



# TEST REPORT

No.I20N00775-SAR

For

**TCL Communication Ltd.**

**LTE/UMTS/GSM Mobile Phone**

**Model Name: 3080A**

With

**Hardware Version: PIO**

**Software Version: V1.0**

**FCC ID: 2ACCJB125**

**Issued Date: 2020-04-15**

**Note:**

The test results in this test report relate only to the devices specified in this report. This report shall not be reproduced except in full without the written approval of SAICT.

**Test Laboratory:**

**SAICT, Shenzhen Academy of Information and Communications Technology**

Building G, Shenzhen International Innovation Center, No.1006 Shennan Road, Futian District, Shenzhen, Guangdong, P. R. China 518026.

Tel: +86(0)755-33322000, Fax: +86(0)755-33322001

Email: [yewu@caict.ac.cn](mailto:yewu@caict.ac.cn), [www.saict.ac.cn](http://www.saict.ac.cn)



## **REPORT HISTORY**

<b>Report Number</b>	<b>Revision</b>	<b>Description</b>	<b>Issue Date</b>
I20N00775-SAR	Rev.0	1st edition	2020-04-15



## TCONTENTS

<b>1. SUMMARY OF TEST REPORT .....</b>	<b>5</b>
1.1. TEST ITEMS .....	5
1.2. TEST STANDARDS .....	5
1.3. TEST RESULT .....	5
1.4. TESTING LOCATION .....	5
1.5. PROJECT DATA .....	5
1.6. SIGNATURE.....	5
<b>2. STATEMENT OF COMPLIANCE .....</b>	<b>6</b>
<b>3. CLIENT INFORMATION .....</b>	<b>8</b>
3.1. APPLICANT INFORMATION .....	8
3.2. MANUFACTURER INFORMATION .....	8
<b>4. EQUIPMENT UNDER TEST (EUT) AND ANCILLARY EQUIPMENT (AE) .....</b>	<b>9</b>
4.1. ABOUT EUT .....	9
4.2. INTERNAL IDENTIFICATION OF EUT USED DURING THE TEST .....	10
4.3. INTERNAL IDENTIFICATION OF AE USED DURING THE TEST .....	10
<b>5. TEST METHODOLOGY .....</b>	<b>11</b>
5.1. APPLICABLE LIMIT REGULATIONS .....	11
5.2. APPLICABLE MEASUREMENT STANDARDS.....	11
<b>6. SPECIFIC ABSORPTION RATE (SAR).....</b>	<b>12</b>
6.1. INTRODUCTION.....	12
6.2. SAR DEFINITION.....	12
<b>7. TISSUE SIMULATING LIQUIDS .....</b>	<b>13</b>
7.1. TARGETS FOR TISSUE SIMULATING LIQUID .....	13
7.2. DIELECTRIC PERFORMANCE .....	13
<b>8. SYSTEM VERIFICATION .....</b>	<b>17</b>
8.1. SYSTEM SETUP.....	17
8.2. SYSTEM VERIFICATION.....	18
<b>9. MEASUREMENT PROCEDURES .....</b>	<b>19</b>
9.1. TESTS TO BE PERFORMED .....	19
9.2. GENERAL MEASUREMENT PROCEDURE.....	21
9.3. WCDMA MEASUREMENT PROCEDURES FOR SAR .....	22
9.4. BLUETOOTH & WLAN MEASUREMENT PROCEDURES FOR SAR.....	23
9.5. LTE MEASUREMENT PROCEDURES FOR SAR .....	23
9.6. POWER DRIFT.....	24
<b>10. CONDUCTED OUTPUT POWER .....</b>	<b>25</b>
10.1. GSM MEASUREMENT RESULT .....	25
10.2. WCDMA MEASUREMENT RESULT .....	27
10.3. LTE MEASUREMENT RESULT .....	29
10.4. BLUETOOTH MEASUREMENT RESULT .....	42



<b>11. SIMULTANEOUS TX SAR CONSIDERATIONS</b> .....	<b>43</b>
11.1. INTRODUCTION.....	43
11.2. TRANSMIT ANTENNA SEPARATION DISTANCES .....	43
11.3. STANDALONE SAR TEST EXCLUSION CONSIDERATIONS .....	44
<b>12. EVALUATION OF SIMULTANEOUS</b> .....	<b>45</b>
<b>13. SUMMARY OF TEST RESULTS</b> .....	<b>46</b>
13.1. TESTING ENVIRONMENT.....	46
13.2. SAR RESULTS .....	47
<b>14. SAR MEASUREMENT VARIABILITY</b> .....	<b>59</b>
<b>15. MEASUREMENT UNCERTAINTY</b> .....	<b>61</b>
15.1. MEASUREMENT UNCERTAINTY FOR NORMAL SAR TESTS (300MHZ~3GHZ) .....	61
<b>16. MAIN TEST INSTRUMENTS</b> .....	<b>62</b>
<b>ANNEX A: GRAPH RESULTS</b> .....	<b>63</b>
<b>ANNEX B: SYSTEM VERIFICATION RESULTS</b> .....	<b>84</b>
<b>ANNEX C: SAR MEASUREMENT SETUP</b> .....	<b>90</b>
C.1. MEASUREMENT SET-UP .....	90
C.2. DASY5 E-FIELD PROBE SYSTEM.....	91
C.3. E-FIELD PROBE CALIBRATION .....	91
C.4. OTHER TEST EQUIPMENT.....	92
<b>ANNEX D: POSITION OF THE WIRELESS DEVICE IN RELATION TO THE PHANTOM</b> .....	<b>96</b>
D.1. GENERAL CONSIDERATIONS.....	96
D.2. BODY-WORN DEVICE .....	97
D.3. DESKTOP DEVICE.....	97
D.4. DUT SETUP PHOTOS.....	98
<b>ANNEX E: EQUIVALENT MEDIA RECIPES</b> .....	<b>99</b>
<b>ANNEX F: SYSTEM VALIDATION</b> .....	<b>100</b>
<b>ANNEX G: DAE CALIBRATION CERTIFICATE</b> .....	<b>101</b>
<b>ANNEX H: PROBE CALIBRATION CERTIFICATE</b> .....	<b>104</b>
<b>ANNEX I: DIPOLE CALIBRATION CERTIFICATE</b> .....	<b>114</b>
<b>ANNEX J: EXTENDED CALIBRATION SAR DIPOLE</b> .....	<b>162</b>
<b>ANNEX K: ACCREDITATION CERTIFICATE</b> .....	<b>163</b>



No. I20N00775-SAR

## 1. Summary of Test Report

### 1.1. Test Items

Description: LTE/UMTS/GSM Mobile Phone  
Model Name: 3080A  
Applicant's name: TCL Communication Ltd.  
Manufacturer's Name: TCL Communication Ltd.

### 1.2. Test Standards

ANSI C95.1-1992, IEEE 1528-2013

### 1.3. Test Result

Pass. Please refer to "13. Summary of Test Results"

### 1.4. Testing Location

Address: Building G, Shenzhen International Innovation Center, No.1006 Shennan Road, Futian District, Shenzhen, Guangdong, P. R. China

### 1.5. Project Data

Testing Start Date: 2020-04-11

Testing End Date: 2020-04-14

### 1.6. Signature

Li yongfu

(Prepared this test report)

Zhang Yunzhan

(Reviewed this test report)

Cao Junfei

(Approved this test report)

## 2. Statement of Compliance

The maximum results of Specific Absorption Rate (SAR) found during testing for TCL Communication Ltd. LTE/UMTS/GSM Mobile Phone 3080A are as follows:

**Table 2.1: Highest Reported SAR for Head (1g)**

Exposure Configuration	Technology Band	Highest Reported SAR 1g(W/Kg)	Equipment Class
Head	GSM850	<b>1.39</b>	PCE
	GSM1900	0.36	
	WCDMA Band 2	0.92	
	WCDMA Band 4	0.95	
	WCDMA Band 5	1.23	
	LTE Band 2	0.98	
	LTE Band 4	1.17	
	LTE Band 5	1.14	
	LTE Band 7	1.35	
	LTE Band 28	1.06	
	Bluetooth	0.01	DSS

**Table 2.2: Highest Reported SAR for Body-worn (1g)**

Exposure Configuration	Technology Band	Highest Reported SAR 1g(W/Kg)	Equipment Class
Body-worn (15mm)	GSM850	1.14	PCE
	GSM1900	1.07	
	WCDMA Band 2	1.02	
	WCDMA Band 4	1.11	
	WCDMA Band 5	0.45	
	LTE Band 2	0.87	
	LTE Band 4	<b>1.23</b>	
	LTE Band 5	0.68	
	LTE Band 7	0.30	
	LTE Band 28	0.75	

The SAR values found for the Mobile Phone are below the maximum recommended levels of 1.6 W/Kg as averaged over any 1g tissue according to the ANSI C95.1-1992.

The EUT battery must be fully charged and checked periodically during the test to ascertain uniform power output.

The measurement together with the test system set-up is described in annex C of this test report. A detailed description of the equipment under test can be found in chapter 4 of this test report.



The highest reported SAR value is obtained at the case of **(Table 2.1 & 2.2)**, and the value is: **1.39 W/kg (1g)**.

**Table2.3: The sum of reported SAR values for WWAN antenna and Bluetooth**

<i>/</i>	<b>Position</b>	<b>WWAN Antenna (W/kg)</b>	<b>Bluetooth (W/kg)</b>	<b>Sum (W/kg)</b>
Highest reported SAR value for Head	Left Touch	1.39	0.01	1.40
Highest reported SAR value for Body	Rear	1.23	0.14	1.37

Note: the test positions of above tables are for the worse case that has been evaluated.

According to the above tables, the highest sum of reported SAR values is **1.40 W/kg (1g)**.

The detail for simultaneous transmission consideration is described in chapter 12.



### 3. Client Information

#### 3.1. Applicant Information

Company Name:	TCL Communication Ltd.
Address /Post:	5/F, Building 22E, 22 Science Park East Avenue, Hong Kong Science Park, Shatin, NT, Hong Kong
City:	/
Country:	/
Telephone:	0086-755-36611722

#### 3.2. Manufacturer Information

Company Name:	TCL Communication Ltd.
Address /Post:	5/F, Building 22E, 22 Science Park East Avenue, Hong Kong Science Park, Shatin, NT, Hong Kong
City:	/
Country:	/
Telephone:	0086-755-36611722



## 4. Equipment under Test (EUT) and Ancillary Equipment (AE)

### 4.1. About EUT

Description:	LTE/UMTS/GSM Mobile Phone
Model Name:	3080A
Marketing Name:	/
Operating mode(s):	GSM850/1900, WCDMA Band2/4/5, LTE Band2/4/5/7/28, Bluetooth
Condition of EUT as received	No obvious damage in appearance
Tested Tx Frequency:	825 – 848.8MHz (GSM 850)
	1850.2 – 1910MHz (GSM 1900)
	1852.4 – 1907.6MHz (WCDMA Band 2)
	1712.4 – 1752.6MHz (WCDMA Band 4)
	826.4 – 846.6MHz (WCDMA Band 5)
	1850.7 – 1909.3MHz (LTE Band 2)
	1710.7 – 1754.3MHz (LTE Band 4)
	824.7 – 848.3MHz (LTE Band 5)
	2502.5 – 2567.5MHz (LTE Band 7)
	704.5 – 746.5MHz (LTE Band 28)
2402 – 2480MHz (Bluetooth)	
GPRS / EGPRS Multislot Class:	12
GPRS capability Class:	B
Test device Production information:	Production unit
Device type:	Portable device
Antenna type:	Integrated antenna
Hotspot mode:	/
Product Dimensions:	Long 124mm ;Wide 50mm ; Overall Diagonal 129mm
Display Diagonal:	62mm
<b>Remark:</b>	
1. This device does not support DTM operation.	

#### 4.2. Internal Identification of EUT used during the test

EUT ID*	IMEI	HW Version	SW Version
UT04aa	354831110200052	PIO	V1.0
UT05aa	354831110200136	PIO	V1.0
UT06aa	354831110200037	PIO	V1.0

\*EUT ID: is used to identify the test sample in the lab internally.

**Note:** It is performed to test SAR with the UT 05aa & 06aa, and conducted power with the UT04aa.

#### 4.3. Internal Identification of AE used during the test

AE ID*	Description	Type	Manufacturer
AE1	Battery	TLi015M7(CAB1500081C7)	VEKEN
AE2	Battery	TLi015MA(CAB1500082CA)	TIANMAO
AE3	Headset	CCB0046A10C1	JUWEI
AE4	Headset	CCB0046A10C4	meihao

\*AE ID: is used to identify the test sample in the lab internally.



## 5. Test Methodology

### 5.1. Applicable Limit Regulations

**ANSI C95.1–1992:** IEEE Standard for Safety Levels with Respect to Human Exposure to Radio Frequency Electromagnetic Fields, 3 kHz to 300 GHz.

It specifies the maximum exposure limit of **1.6 W/kg** as averaged over any 1 gram of tissue for portable devices being used within 20 cm of the user in the uncontrolled environment.

### 5.2. Applicable Measurement Standards

**IEEE 1528–2013:** Recommended Practice for Determining the Peak Spatial-Average Specific Absorption Rate (SAR) in the Human Head from Wireless Communications Devices: Experimental Techniques.

**KDB 447498 D01 General RF Exposure Guidance v06:** Mobile and Portable Devices RF Exposure Procedures and Equipment Authorization Policies.

**KDB 648474 D04 Handset SAR v01r03:** SAR Evaluation Considerations for Wireless Handsets.

**KDB 941225 D01 SAR test for 3G devices v03r01:** SAR Measurement Procedures for 3G Devices

**KDB 941225 D05 SAR for LTE Devices v02r05:** SAR Evaluation Considerations for LTE Devices

**KDB 865664 D01 SAR measurement 100 MHz to 6 GHz v01r04:** SAR Measurement Requirements for 100 MHz to 6 GHz.

**KDB 865664 D02 RF Exposure Reporting v01r02:** RF Exposure Compliance Reporting and Documentation Considerations

**TCB workshop April 2019; RF Exposure Procedures (Tissue Simulating Liquids)**

## 6. Specific Absorption Rate (SAR)

### 6.1. Introduction

SAR is related to the rate at which energy is absorbed per unit mass in an object exposed to a radio field. The SAR distribution in a biological body is complicated and is usually carried out by experimental techniques or numerical modeling. The standard recommends limits for two tiers of groups, occupational/controlled and general population/uncontrolled, based on a person's awareness and ability to exercise control over his or her exposure. In general, occupational/controlled exposure limits are higher than the limits for general population/uncontrolled.

### 6.2. SAR Definition

The SAR definition is the time derivative (rate) of the incremental energy ( $dW$ ) absorbed by (dissipated in) an incremental mass ( $dm$ ) contained in a volume element ( $dv$ ) of a given density ( $\rho$ ). The equation description is as below:

$$SAR = \frac{d}{dt} \left( \frac{dW}{dm} \right) = \frac{d}{dt} \left( \frac{dW}{\rho dv} \right)$$

SAR is expressed in units of Watts per kilogram (W/kg)

SAR measurement can be either related to the temperature elevation in tissue by

$$SAR = c \left( \frac{\delta T}{\delta t} \right)$$

Where:  $C$  is the specific heat capacity,  $\delta T$  is the temperature rise and  $\delta t$  is the exposure duration, or related to the electrical field in the tissue by

$$SAR = \frac{\sigma |E|^2}{\rho}$$

Where:  $\sigma$  is the conductivity of the tissue,  $\rho$  is the mass density of tissue and  $E$  is the RMS electrical field strength.

However for evaluating SAR of low power transmitter, electrical field measurement is typically applied.

## 7. Tissue Simulating Liquids

### 7.1. Targets for tissue simulating liquid

**Table 7.1: Targets for tissue simulating liquid**

Frequency (MHz)	Liquid Type	Conductivity ( $\sigma$ )	$\pm 5\%$ Range	Permittivity ( $\epsilon$ )	$\pm 5\%$ Range
750	Head	0.89	0.85~0.93	41.9	39.8~44.0
835	Head	0.90	0.86~0.95	41.5	39.4~43.6
1750	Head	1.37	1.30~1.44	40.1	38.1~42.1
1900	Head	1.40	1.33~1.47	40.0	38.0~42.0
2450	Head	1.80	1.71~1.89	39.2	37.2~41.2
2550	Head	1.91	1.81~2.01	39.1	37.1~41.0

### 7.2. Dielectric Performance

**Table 7.2: Dielectric Performance of Tissue Simulating Liquid**

Measurement Date (yyyy-mm-dd)	Type	Frequency	Conductivity $\sigma$ (S/m)	Drift (%)	Permittivity $\epsilon$	Drift (%)
2020-04-13	Head	750	0.904	1.57	41.32	-1.38
2020-04-12	Head	835	0.918	2.00	41.04	-1.11
2020-04-13	Head	1750	1.356	-1.02	39.53	-1.42
2020-04-11	Head	1900	1.417	1.21	39.05	-2.38
2020-04-14	Head	2450	1.775	-1.39	39.66	1.17
2020-04-14	Head	2550	1.949	2.04	38.29	-2.07

Note: The liquid temperature is 22.0°C.

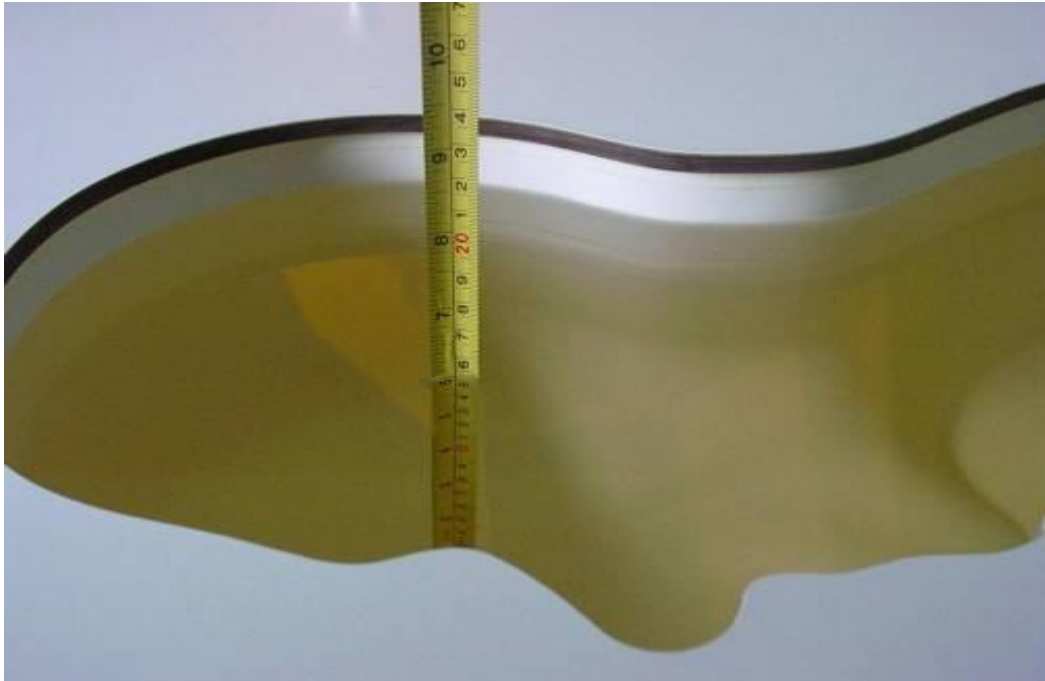

**Picture 15-1: Liquid depth in the Head Phantom (750MHz)**

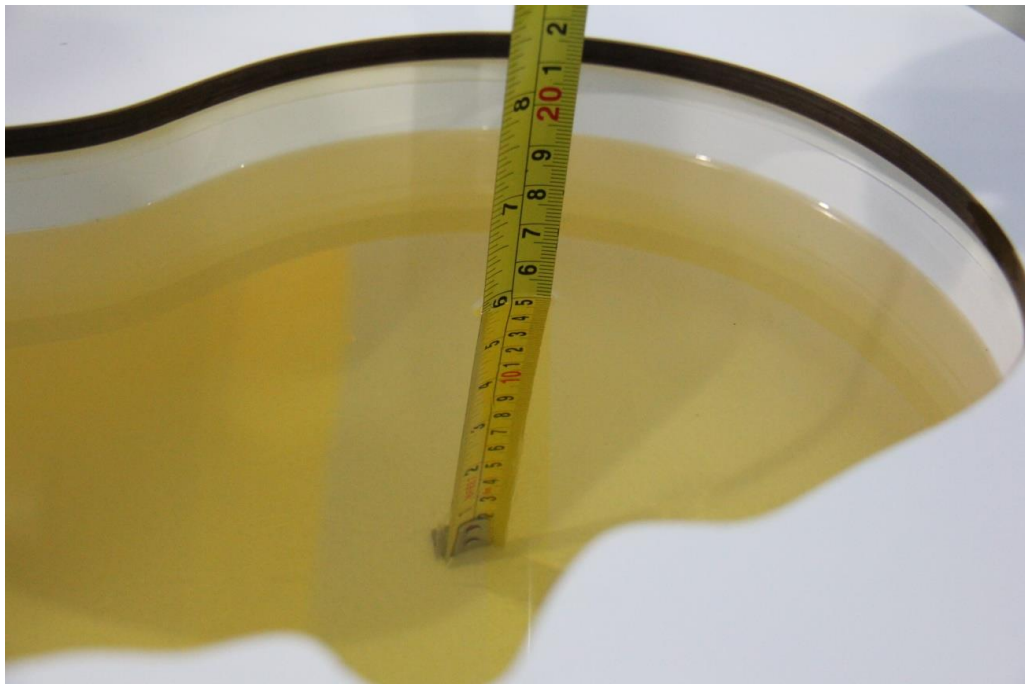

**Picture 7-1: Liquid depth in the Head Phantom (835MHz)**

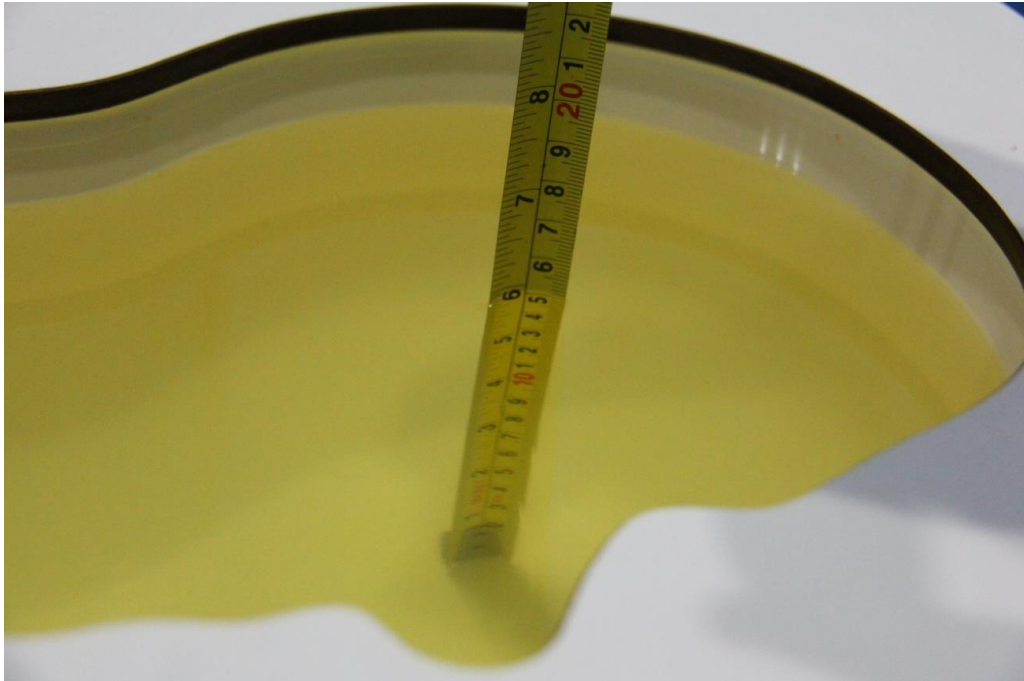

**Picture 7-2: Liquid depth in the Head Phantom (1750MHz)**

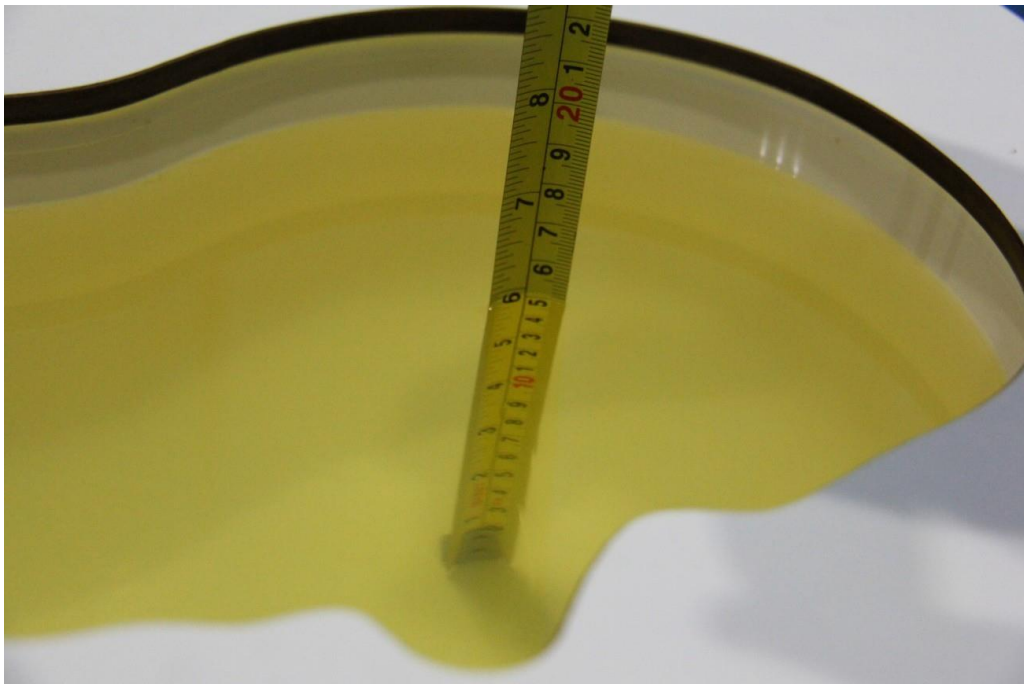

**Picture 7-3: Liquid depth in the Head Phantom (1900MHz)**

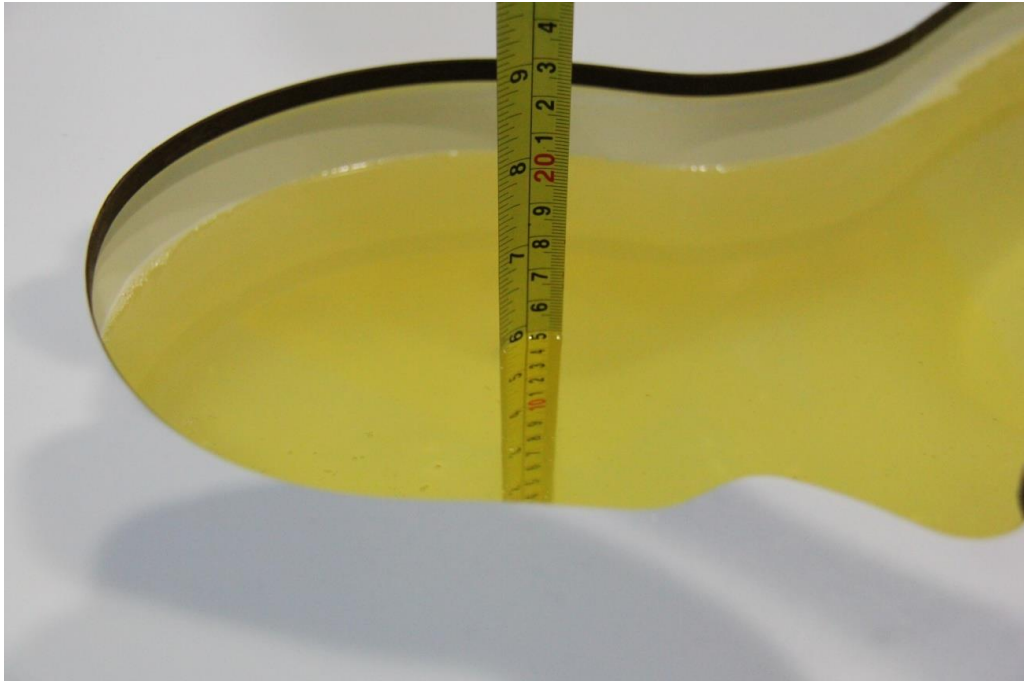

**Picture 7-4: Liquid depth in the Head Phantom(2450MHz)**

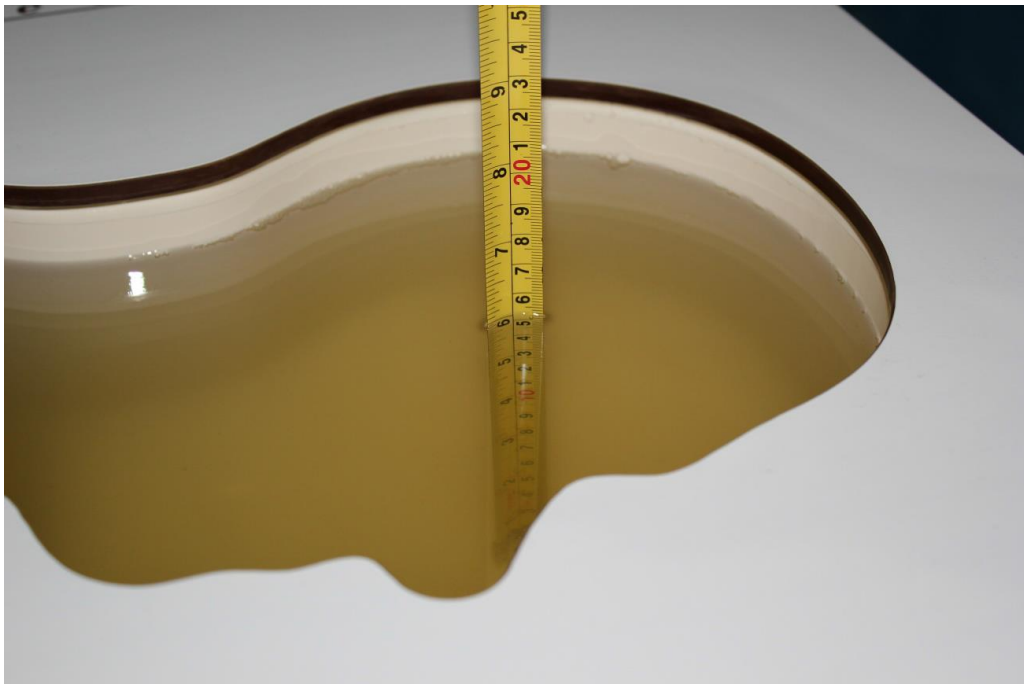

**Picture 7-5: Liquid depth in the Head Phantom(2550MHz)**



## 8. System verification

### 8.1. System Setup

In the simplified setup for system evaluation, the DUT is replaced by a calibrated dipole and the power source is replaced by a continuous wave that comes from a signal generator. The calibrated dipole must be placed beneath the flat phantom section of the SAM twin phantom with the correct distance holder. The distance holder should touch the phantom surface with a light pressure at the reference marking and be oriented parallel to the long side of the phantom. The equipment setup is shown below:

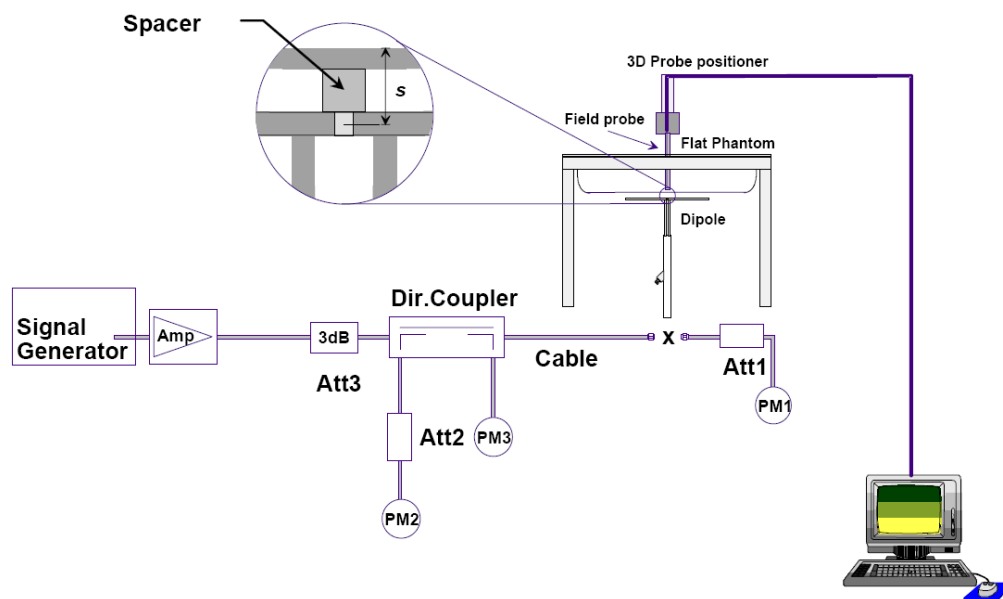

Picture 8.1 System Setup for System Evaluation



Picture 8.2 Photo of Dipole Setup

## 8.2. System Verification

SAR system verification is required to confirm measurement accuracy, according to the tissue dielectric media, probe calibration points and other system operating parameters required for measuring the SAR of a test device. The system verification must be performed for each frequency band and within the valid range of each probe calibration point required for testing the device.

**Table 8.1: System Verification of Head**

Measurement Date (yyyy-mm-dd)	Frequency	Target value (W/kg)		Measured value (W/kg)		Deviation (%)	
		10 g Average	1 g Average	10 g Average	1 g Average	10 g Average	1 g Average
2020-04-13	750 MHz	5.70	8.53	5.76	8.72	1.05	2.23
2020-04-12	835 MHz	6.29	9.62	6.44	9.96	2.38	3.53
2020-04-13	1750 MHz	19.30	36.40	18.92	35.40	-1.97	-2.75
2020-04-11	1900 MHz	21.00	40.50	21.40	41.60	1.90	2.72
2020-04-14	2450 MHz	24.10	52.00	23.84	50.80	-1.08	-2.31
2020-04-14	2550 MHz	26.50	57.80	27.08	60.00	2.19	3.81

## 9. Measurement Procedures

### 9.1. Tests to be performed

In order to determine the highest value of the peak spatial-average SAR of a handset, all device positions, configurations and operational modes shall be tested for each frequency band according to steps 1 to 3 below. A flowchart of the test process is shown in picture 9.1.

**Step 1:** The tests described in 9.2 shall be performed at the channel that is closest to the center of the transmit frequency band ( $f_c$ ) for:

- a) all device positions (cheek and tilt, for both left and right sides of the SAM phantom, as described in annex D),
- b) all configurations for each device position in a), e.g., antenna extended and retracted, and
- c) all operational modes, e.g., analogue and digital, for each device position in a) and configuration in b) in each frequency band.

If more than three frequencies need to be tested according to 11.1 (i.e.,  $N_c > 3$ ), then all frequencies, configurations and modes shall be tested for all of the above test conditions.

**Step 2:** For the condition providing highest peak spatial-average SAR determined in Step 1, perform all tests described in 9.2 at all other test frequencies, i.e., lowest and highest frequencies. In addition, for all other conditions (device position, configuration and operational mode) where the peak spatial-average SAR value determined in Step 1 is within 3 dB of the applicable SAR limit, it is recommended that all other test frequencies shall be tested as well.

**Step 3:** Examine all data to determine the highest value of the peak spatial-average SAR found in Steps 1 to 2.

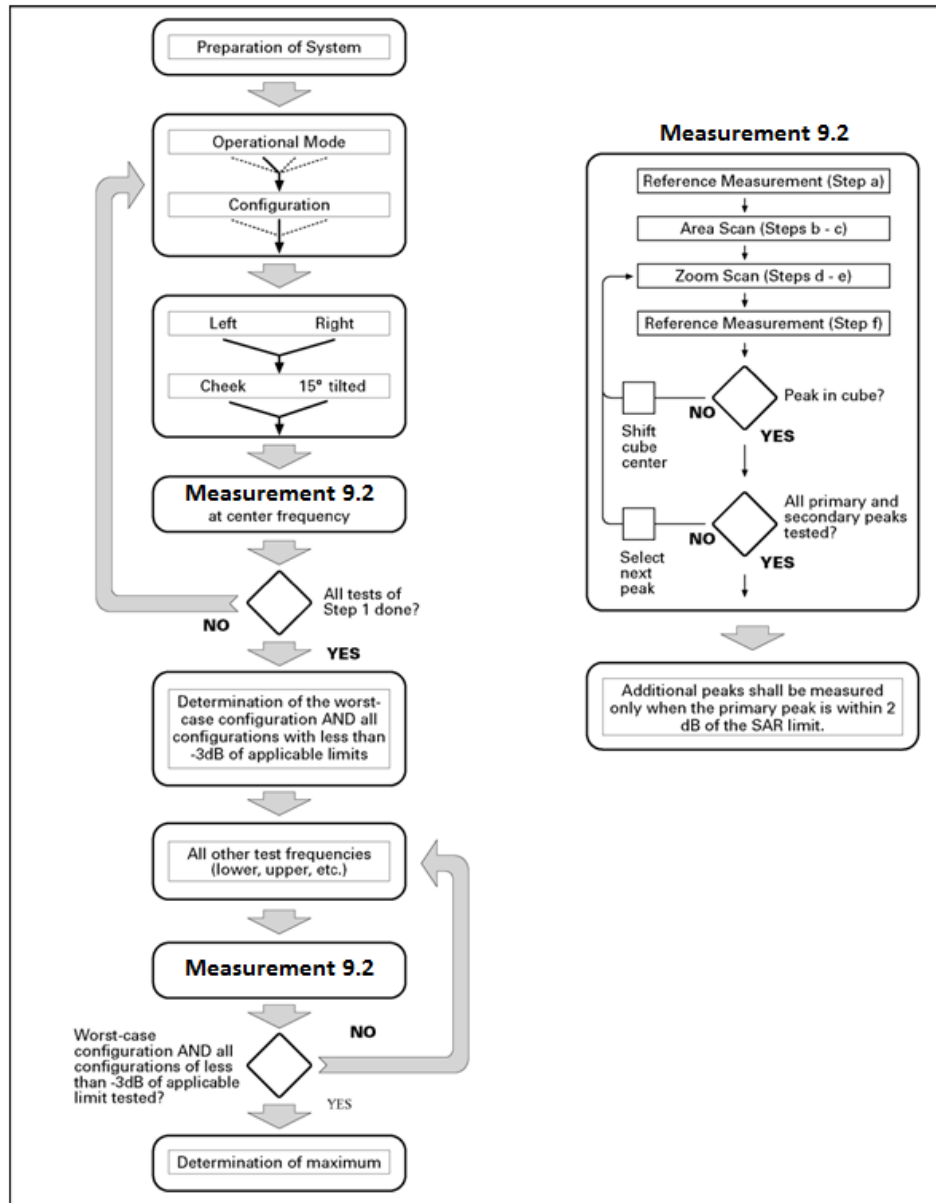

Picture 9.1 Block diagram of the tests to be performed

## 9.2. General Measurement Procedure

The area and zoom scan resolutions specified in the table below must be applied to the SAR measurements and fully documented in SAR reports to qualify for TCB approval. Probe boundary effect error compensation is required for measurements with the probe tip closer than half a probe tip diameter to the phantom surface. Both the probe tip diameter and sensor offset distance must satisfy measurement protocols; to ensure probe boundary effect errors are minimized and the higher fields closest to the phantom surface can be correctly measured and extrapolated to the phantom surface for computing 1-g SAR. Tolerances of the post-processing algorithms must be verified by the test laboratory for the scan resolutions used in the SAR measurements, according to the reference distribution functions specified in IEEE Std 1528-2013. The results should be documented as part of the system validation records and may be requested to support test results when all the measurement parameters in the following table are not satisfied.

		$\leq 3$ GHz	$> 3$ GHz
Maximum distance from closest measurement point (geometric center of probe sensors) to phantom surface		$5 \pm 1$ mm	$\frac{1}{2} \cdot \delta \cdot \ln(2) \pm 0.5$ mm
Maximum probe angle from probe axis to phantom surface normal at the measurement location		$30^\circ \pm 1^\circ$	$20^\circ \pm 1^\circ$
Maximum area scan spatial resolution: $\Delta x_{Area}, \Delta y_{Area}$		$\leq 2$ GHz: $\leq 15$ mm 2 – 3 GHz: $\leq 12$ mm	3 – 4 GHz: $\leq 12$ mm 4 – 6 GHz: $\leq 10$ mm
		When the x or y dimension of the test device, in the measurement plane orientation, is smaller than the above, the measurement resolution must be $\leq$ the corresponding x or y dimension of the test device with at least one measurement point on the test device.	
Maximum zoom scan spatial resolution: $\Delta x_{Zoom}, \Delta y_{Zoom}$		$\leq 2$ GHz: $\leq 8$ mm 2 – 3 GHz: $\leq 5$ mm*	3 – 4 GHz: $\leq 5$ mm* 4 – 6 GHz: $\leq 4$ mm*
Maximum zoom scan spatial resolution, normal to phantom surface	uniform grid: $\Delta z_{Zoom}(n)$	$\leq 5$ mm	3 – 4 GHz: $\leq 4$ mm 4 – 5 GHz: $\leq 3$ mm 5 – 6 GHz: $\leq 2$ mm
	graded grid $\Delta z_{Zoom}(1)$ : between 1 <sup>st</sup> two points closest to phantom surface	$\leq 4$ mm	3 – 4 GHz: $\leq 3$ mm 4 – 5 GHz: $\leq 2.5$ mm 5 – 6 GHz: $\leq 2$ mm
	$\Delta z_{Zoom}(n>1)$ : between subsequent points	$\leq 1.5 \cdot \Delta z_{Zoom}(n-1)$	
Minimum zoom scan volume	x, y, z	$\geq 30$ mm	3 – 4 GHz: $\geq 28$ mm 4 – 5 GHz: $\geq 25$ mm 5 – 6 GHz: $\geq 22$ mm
Note: $\delta$ is the penetration depth of a plane-wave at normal incidence to the tissue medium; see draft standard IEEE P1528-2011 for details. * When zoom scan is required and the <i>reported</i> SAR from the area scan based 1-g SAR estimation procedures of KDB 447498 is $\leq 1.4$ W/kg, $\leq 8$ mm, $\leq 7$ mm and $\leq 5$ mm zoom scan resolution may be applied, respectively, for 2 GHz to 3 GHz, 3 GHz to 4 GHz and 4 GHz to 6 GHz.			

### 9.3. WCDMA Measurement Procedures for SAR

The following procedures are applicable to WCDMA handsets operating under 3GPP Release99, Release 5 and Release 6. The default test configuration is to measure SAR with an established radio link between the DUT and a communication test set using a 12.2kbps RMC (reference measurement channel) configured in Test Loop Mode 1. SAR is selectively confirmed for other physical channel configurations (DPCCH & DPDCH<sub>n</sub>), HSDPA and HSPA (HSUPA/HSDPA) modes according to output power, exposure conditions and device operating capabilities. Both uplink and downlink should be configured with the same RMC or AMR, when required. SAR for Release 5 HSDPA and Release 6 HSPA are measured using the applicable FRC (fixed reference channel) and E-DCH reference channel configurations. Maximum output power is verified according to applicable versions of 3GPP TS 34.121 and SAR must be measured according to these maximum output conditions. When Maximum Power Reduction (MPR) is not implemented according to Cubic Metric (CM) requirements for Release 6 HSPA, the following procedures do not apply.

#### For Release 5 HSDPA Data Devices:

Sub-test	$\beta_c$	$\beta_d$	$\beta_d$ (SF)	$\beta_c / \beta_d$	$\beta_{hs}$	CM/dB
1	2/15	15/15	64	2/15	4/15	0.0
2	12/15	15/15	64	12/15	24/25	1.0
3	15/15	8/15	64	15/8	30/15	1.5
4	15/15	4/15	64	15/4	30/15	1.5

#### For Release 6 HSPA Data Devices

Sub-test	$\beta_c$	$\beta_d$	$\beta_d$ (SF)	$\beta_c / \beta_d$	$\beta_{hs}$	$\beta_{ec}$	$\beta_{ed}$	$\beta_{ed}$ (SF)	$\beta_{ed}$ (codes)	CM (dB)	MPR (dB)	AG Index	E-TFCI
1	11/15	15/15	64	11/15	22/15	209/225	1039/225	4	1	1.0	0.0	20	75
2	6/15	15/15	64	6/15	12/15	12/15	12/15	4	1	3.0	2.0	12	67
3	15/15	9/15	64	15/9	30/15	30/15	$\beta_{ed1}:47/1$ 5 $\beta_{ed2}:47/15$	4	2	2.0	1.0	15	92
4	2/15	15/15	64	2/15	4/15	4/15	56/75	4	1	3.0	2.0	17	71
5	15/15	15/15	64	15/15	24/15	30/15	134/15	4	1	1.0	0.0	21	81

#### 9.4. Bluetooth & WLAN Measurement Procedures for SAR

Normal network operating configurations are not suitable for measuring the SAR of 802.11 transmitters in general. Unpredictable fluctuations in network traffic and antenna diversity conditions can introduce undesirable variations in SAR results. The SAR for these devices should be measured using chipset based test mode software to ensure that the results are consistent and reliable.

Chipset based test mode software is hardware dependent and generally varies among manufacturers. The device operating parameters established in a test mode for SAR measurements must be identical to those programmed in production units, including output power levels, amplifier gain settings and other RF performance tuning parameters. The test frequencies should correspond to actual channel frequencies defined for domestic use. SAR for devices with switched diversity should be measured with only one antenna transmitting at a time during each SAR measurement, according to a fixed modulation and data rate. The same data pattern should be used for all measurements.

#### 9.5. LTE Measurement Procedures for SAR

SAR tests for LTE are performed with a base station simulator, Anristu MT8820C. Closed loop power control was used so the UE transmits with maximum output power during SAR testing. All powers were measured with the Anristu MT8820C. It is performed for conducted power and SAR based on the KDB941225 D05.

SAR is evaluated separately according to the following procedures for the different test positions in each exposure condition – head, body, body-worn accessories and other use conditions. The procedures in the following subsections are applied separately to test each LTE frequency band.

1) QPSK with 1 RB allocation

Start with the largest channel bandwidth and measure SAR for QPSK with 1 RB allocation, using the RB offset and required test channel combination with the highest maximum output power among RB offsets at the upper edge, middle and lower edge of each required test channel. When the reported SAR is  $\leq 0.8$  W/kg, testing of the remaining RB offset configurations and required test channels is not required for 1 RB allocation; otherwise, SAR is required for the remaining required test channels and only for the RB offset configuration with the highest output power for that channel. When the reported SAR of a required test channel is  $> 1.45$  W/kg, SAR is required for all three RB offset configurations for that required test channel.

2) QPSK with 50% RB allocation

The procedures required for 1 RB allocation in 1) are applied to measure the SAR for QPSK with 50% RB allocation.

3) QPSK with 100% RB allocation

For QPSK with 100% RB allocation, SAR is not required when the highest maximum output power for 100 % RB allocation is less than the highest maximum output power in 50% and 1 RB allocations and the highest reported SAR for 1 RB and 50% RB allocation in 1) and 2) are  $\leq 0.8$  W/kg. Otherwise, SAR is measured for the highest output power channel; and if the reported SAR is  $> 1.45$  W/kg, the remaining required test channels must also be tested.



## 9.6. Power Drift

To control the output power stability during the SAR test, DASY5 system calculates the power drift by measuring the E-field at the same location at the beginning and at the end of the measurement for each test position. These drift values can be found in Section 14 labeled as: (Power Drift [dB]). This ensures that the power drift during one measurement is within 5%.



## 10. Conducted Output Power

### 10.1. GSM Measurement result

During the process of testing, the EUT was controlled via Agilent Digital Radio Communication tester (E5515C) to ensure the maximum power transmission and proper modulation. This result contains conducted output power for the EUT. In all cases, the measured peak output power should be greater and within 5% than EMI measurement.

**Table 10.1: The conducted power measurement results for GSM**

GSM 850MHz	Tune up 33	Conducted Power(dBm)		
		Channel 251(848.8MHz)	Channel 190(836.6MHz)	Channel 128(824.2MHz)
		32.28	32.32	32.35
GSM 1900MHz	Tune up 31	Conducted Power(dBm)		
		Channel 810(1909.8MHz)	Channel 661(1880MHz)	Channel512(1850.2MHz)
		30.35	30.36	30.34

**Table 10.2: The conducted power measurement results for GPRS and EGPRS**

GPRS850/ EGPRS850	Tune up	Measured Power (dBm)			calculation	Average Power (dBm)		
		251	190	128		251	190	128
1Tx-slots	34	32.26	32.31	32.35	-9.03dB	23.23	23.28	23.32
2Tx-slots	32	<b>30.26</b>	<b>30.24</b>	<b>30.46</b>	-6.02dB	<b>24.24</b>	<b>24.22</b>	<b>24.44</b>
3Tx-slots	30.5	28.44	28.47	28.54	-4.26dB	24.18	24.21	24.28
4Tx-slots	28.5	26.50	26.52	26.66	-3.01dB	23.49	23.51	23.65
EGPRS 850 (8PSK)	Tune up	Measured Power (dBm)			calculation	Measured Power (dBm)		
		251	190	128		251	190	128
1Tx-slots	26.5	25.17	24.84	24.68	-9.03dB	16.14	15.81	15.65
2Tx-slots	25.5	24.20	23.44	23.74	-6.02dB	18.18	17.42	17.72
3Tx-slots	23.5	21.89	20.98	21.28	-4.26dB	17.63	16.72	17.02
4Tx-slots	20.5	19.04	18.46	18.54	-3.01dB	16.03	15.45	15.53

GPRS1900/ EGPRS1900	Tune up	Measured Power (dBm)			calculation	Average Power (dBm)		
		810	661	512		810	661	512
1Tx-slots	<b>31</b>	30.30	30.36	30.31	<b>-9.03dB</b>	21.27	21.33	21.28
2Tx-slots	<b>29</b>	27.91	28.08	28.37	<b>-6.02dB</b>	21.89	22.06	22.35
3Tx-slots	<b>27.5</b>	<b>26.25</b>	<b>26.46</b>	<b>26.78</b>	<b>-4.26dB</b>	<b>21.99</b>	<b>22.20</b>	<b>22.52</b>
4Tx-slots	<b>25.5</b>	24.16	24.41	24.69	<b>-3.01dB</b>	21.15	21.40	21.68
EGPRS 1900 (8PSK)	Tune up	Measured Power (dBm)			calculation	Measured Power (dBm)		
		810	661	512		810	661	512
1Tx-slots	<b>27</b>	26.38	26.41	25.94	<b>-9.03dB</b>	17.35	17.38	16.91
2Tx-slots	<b>25</b>	24.31	24.35	24.17	<b>-6.02dB</b>	18.29	18.33	18.15
3Tx-slots	<b>22</b>	21.18	21.25	20.88	<b>-4.26dB</b>	16.92	16.99	16.62
4Tx-slots	<b>19</b>	18.33	18.49	18.31	<b>-3.01dB</b>	15.32	15.48	15.30

Note:

1) Division Factors

To average the power, the division factor is as follows:

1TX-slot = 1 transmit time slot out of 8 time slots=> conducted power divided by (8/1) => -9.03dB

2TX-slots = 2 transmit time slots out of 8 time slots=> conducted power divided by (8/2) => -6.02dB

3TX-slots = 3 transmit time slots out of 8 time slots=> conducted power divided by (8/3) => -4.26dB

4TX-slots = 4 transmit time slots out of 8 time slots=> conducted power divided by (8/4) => -3.01dB

**According to the conducted power as above, the body measurements are performed with 2Txslots for 850MHz and 3Txslots for 1900MHz.**

## 10.2. WCDMA Measurement result

Table 10.3: T The conducted power measurement results WCDMA

Item	band	WCDMA Band 2			
	ARFCN	Tune up	9538 (1907.6MHz)	9400 (1880MHz)	9262 (1852.4MHz)
WCDMA	\	23.5	22.70	22.60	22.90
HSUPA	1	19.5	18.50	18.40	18.30
	2	19.5	18.60	18.50	18.40
	3	19.5	18.30	18.30	18.20
	4	20.0	18.80	19.10	18.80
	5	23.0	22.10	21.80	21.80
HSDPA	1	23.5	22.50	22.40	22.30
	2	23.5	22.10	22.20	22.10
	3	23.0	21.90	21.90	21.90
	4	23.0	21.90	21.90	21.90
Item	band	WCDMA Band 4			
	ARFCN	Tune up	1513 (1752.6MHz)	1413 (1732.6MHz)	1312 (1712.4MHz)
WCDMA	\	24.0	23.60	23.60	23.50
HSUPA	1	23.5	22.30	22.30	22.30
	2	23.5	22.40	22.40	22.40
	3	23.5	22.60	22.60	22.60
	4	23.0	22.10	22.10	22.10
	5	24.0	23.50	23.50	23.60
HSDPA	1	24.0	22.40	23.40	22.50
	2	24.0	22.40	23.20	22.50
	3	24.0	22.40	23.10	22.40
	4	24.0	22.50	23.20	22.50



Item	band	WCDMA Band 5			
	ARFCN	Tune up	4233 (846.6MHz)	4182 (836.4MHz)	4132 (826.4MHz)
<b>WCDMA</b>	\	<b>23.5</b>	22.50	22.60	22.80
<b>HSUPA</b>	<b>1</b>	<b>19.5</b>	18.10	18.10	18.60
	<b>2</b>	<b>19.5</b>	18.20	18.20	18.70
	<b>3</b>	<b>19.5</b>	18.10	18.30	18.50
	<b>4</b>	<b>19.5</b>	18.10	18.10	18.40
	<b>5</b>	<b>23.5</b>	22.40	22.50	22.60
<b>HSDPA</b>	<b>1</b>	<b>23.0</b>	22.20	22.10	22.30
	<b>2</b>	<b>22.5</b>	21.70	21.60	21.80
	<b>3</b>	<b>22.0</b>	20.80	20.80	21.00
	<b>4</b>	<b>22.0</b>	20.80	20.80	20.90

### 10.3. LTE Measurement result

**Table 10.4: The conducted Power for LTE**

LTE Band 2				Actual output Power (dBm)			Tune up
Band-width	RB allocation	RB offset	Modulation	High	Middle	Low	
1.4 MHz				1909.3MHz	1880MHz	1850.7MHz	
	1RB	High	QPSK	22.60	22.22	22.39	23
			16QAM	22.69	21.88	22.47	23
		Middle	QPSK	22.61	22.19	22.45	23
			16QAM	22.68	21.88	22.57	23
		Low	QPSK	22.67	22.16	22.46	23
			16QAM	22.23	21.86	22.51	23
	3RB	High	QPSK	22.70	22.26	22.59	23
			16QAM	22.48	21.94	22.28	23
		Middle	QPSK	22.81	22.34	22.56	23
			16QAM	22.47	21.85	22.32	23
		Low	QPSK	22.73	22.29	22.59	23
			16QAM	22.48	21.82	22.32	23
	6RB	/	QPSK	22.18	21.64	22.06	22.5
16QAM			20.39	20.82	20.40	21.5	
3 MHz				1908.5MHz	1880MHz	1851.5MHz	/
	1RB	High	QPSK	22.66	22.24	22.43	23
			16QAM	22.66	21.92	21.99	23
		Middle	QPSK	22.75	22.14	22.39	23
			16QAM	22.74	21.86	21.98	23
		Low	QPSK	22.60	22.12	22.39	23
			16QAM	22.67	21.80	22.03	23
	8RB	High	QPSK	22.11	21.80	22.05	22.5
			16QAM	20.46	20.79	20.62	21.5
		Middle	QPSK	22.21	21.74	21.93	22.5
			16QAM	20.63	20.86	20.62	21.5
		Low	QPSK	22.15	21.74	21.97	22.5
			16QAM	20.71	20.87	20.49	21.5
	15RB	/	QPSK	22.20	21.71	22.02	22.5
16QAM			20.58	20.81	20.55	21.5	

LTE Band 2				Actual output Power (dBm)			Tune up
Band-width	RB allocation	RB offset	Modulation	High	Middle	Low	
5 MHz				1907.5MHz	1880MHz	1852.5MHz	
	1RB	High	QPSK	22.70	22.13	22.35	23
			16QAM	22.70	22.18	22.43	23
		Middle	QPSK	22.57	22.11	22.39	23
			16QAM	22.66	22.17	22.53	23
		Low	QPSK	22.56	22.10	22.38	23
			16QAM	22.61	22.21	22.50	23
	12RB	High	QPSK	22.28	21.74	21.96	22.5
			16QAM	20.48	20.68	20.62	21.5
		Middle	QPSK	22.13	21.64	21.99	22.5
			16QAM	20.83	20.90	20.65	21.5
		Low	QPSK	22.12	21.55	21.98	22.5
			16QAM	20.83	20.79	20.41	21.5
	25RB	/	QPSK	22.19	21.61	21.92	22.5
16QAM			20.67	20.75	20.53	21.5	
10 MHz				1905MHz	1880MHz	1855MHz	/
	1RB	High	QPSK	22.57	22.27	22.37	23
			16QAM	22.20	22.29	21.88	23
		Middle	QPSK	22.57	22.03	22.42	23
			16QAM	22.10	22.17	21.99	23
		Low	QPSK	22.47	22.11	22.44	23
			16QAM	22.13	22.32	22.50	23
	25RB	High	QPSK	22.18	21.64	21.93	22.5
			16QAM	20.96	21.01	20.75	21.5
		Middle	QPSK	22.04	21.54	21.96	22.5
			16QAM	21.05	20.97	20.49	21.5
		Low	QPSK	22.08	21.76	21.91	22.5
			16QAM	21.12	21.00	20.28	21.5
	50RB	/	QPSK	22.00	21.55	21.88	22.5
16QAM			21.04	21.02	20.53	21.5	

LTE Band 2				Actual output Power (dBm)			Tune up
Band-width	RB allocation	RB offset	Modulation	High	Middle	Low	
15 MHz				1902.5MHz	1880MHz	1857.5MHz	
	1RB	High	QPSK	22.65	22.14	22.21	<b>23</b>
			16QAM	22.64	22.21	22.33	<b>23</b>
		Middle	QPSK	22.55	22.05	22.32	<b>23</b>
			16QAM	22.60	21.76	22.45	<b>23</b>
		Low	QPSK	22.31	22.13	22.43	<b>23</b>
			16QAM	22.37	21.78	22.01	<b>23</b>
	36RB	High	QPSK	22.06	21.76	21.80	<b>22.5</b>
			16QAM	20.50	20.74	20.64	<b>21.5</b>
		Middle	QPSK	22.08	21.56	21.96	<b>22.5</b>
			16QAM	20.67	20.85	20.47	<b>21.5</b>
		Low	QPSK	21.97	21.71	21.99	<b>22.5</b>
			16QAM	20.77	21.08	20.37	<b>21.5</b>
	75RB	/	QPSK	22.04	21.61	21.96	<b>22.5</b>
16QAM			20.64	20.90	20.52	<b>21.5</b>	
20 MHz				1900MHz	1880MHz	1860MHz	/
	1RB	High	QPSK	<b>22.54</b>	22.13	22.14	<b>23</b>
			16QAM	22.66	21.92	22.29	<b>23</b>
		Middle	QPSK	22.38	22.07	22.33	<b>23</b>
			16QAM	22.45	21.73	22.38	<b>23</b>
		Low	QPSK	22.23	<b>22.22</b>	<b>22.45</b>	<b>23</b>
			16QAM	21.82	22.02	22.56	<b>23</b>
	50RB	High	QPSK	<b>21.99</b>	21.71	21.85	<b>22.5</b>
			16QAM	20.89	20.87	20.73	<b>21.5</b>
		Middle	QPSK	21.94	21.56	21.86	<b>22.5</b>
			16QAM	20.74	20.75	20.33	<b>21.5</b>
		Low	QPSK	21.85	<b>21.78</b>	<b>21.97</b>	<b>22.5</b>
			16QAM	20.69	20.99	20.10	<b>21.5</b>
	100RB	/	QPSK	<b>21.93</b>	21.52	21.86	<b>22.5</b>
16QAM			20.77	20.94	20.42	<b>21.5</b>	

LTE Band 4				Actual output Power (dBm)			Tune up
Band-width	RB allocation	RB offset	Modulation	High	Middle	Low	
1.4 MHz				1754.3MHz	1732.5MHz	1710.7MHz	
	1RB	High	QPSK	23.66	23.56	23.45	24.5
			16QAM	23.90	23.82	23.63	24.5
		Middle	QPSK	23.69	23.65	23.51	24.5
			16QAM	23.89	23.78	23.66	24.5
		Low	QPSK	23.73	23.73	23.50	24.5
			16QAM	23.92	23.78	23.63	24.5
	3RB	High	QPSK	23.95	23.83	23.58	24.5
			16QAM	23.58	23.58	23.43	24.5
		Middle	QPSK	23.94	23.78	23.61	24.5
			16QAM	23.60	23.63	23.45	24.5
		Low	QPSK	23.91	23.72	23.56	24.5
			16QAM	23.63	23.59	23.40	24.5
	6RB	/	QPSK	23.34	23.23	23.06	24.0
16QAM			22.03	22.06	21.89	23.0	
3 MHz				1753.5MHz	1732.5MHz	1711.5MHz	/
	1RB	High	QPSK	23.73	23.69	23.43	24.5
			16QAM	23.94	23.28	23.11	24.5
		Middle	QPSK	23.68	23.68	23.55	24.5
			16QAM	23.95	23.24	23.04	24.5
		Low	QPSK	23.69	23.73	23.53	24.5
			16QAM	23.99	23.80	23.14	24.5
	8RB	High	QPSK	23.28	23.22	23.17	24.0
			16QAM	22.51	22.45	22.33	23.0
		Middle	QPSK	23.31	23.27	23.18	24.0
			16QAM	22.51	22.44	22.36	23.0
		Low	QPSK	23.36	23.25	23.11	24.0
			16QAM	22.56	22.42	22.30	23.0
	15RB	/	QPSK	23.36	23.27	23.12	24.0
16QAM			20.12	22.31	22.30	23.0	



LTE Band 4				Actual output Power (dBm)			Tune up
Band-width	RB allocation	RB offset	Modulation	High	Middle	Low	
5 MHz				1752.5MHz	1732.5MHz	1712.5MHz	
	1RB	High	QPSK	23.64	23.60	23.47	24.5
			16QAM	23.94	23.78	23.68	24.5
		Middle	QPSK	23.65	23.61	23.48	24.5
			16QAM	23.94	23.80	23.36	24.5
		Low	QPSK	23.67	23.58	23.50	24.5
			16QAM	23.95	23.82	23.12	24.5
	12RB	High	QPSK	23.22	23.15	23.06	24.0
			16QAM	22.40	22.32	22.28	23.0
		Middle	QPSK	23.26	23.21	23.08	24.0
			16QAM	22.42	22.40	22.20	23.0
		Low	QPSK	23.38	23.22	23.07	24.0
			16QAM	22.45	22.35	22.18	23.0
	25RB	/	QPSK	23.25	23.17	23.10	24.0
16QAM			22.36	22.29	22.37	23.0	
10 MHz				1750MHz	1732.5MHz	1715MHz	/
	1RB	High	QPSK	23.78	23.72	23.59	24.5
			16QAM	23.40	23.28	23.13	24.5
		Middle	QPSK	23.72	23.69	23.60	24.5
			16QAM	23.34	23.28	23.15	24.5
		Low	QPSK	23.80	23.65	23.48	24.5
			16QAM	23.94	23.17	23.12	24.5
	25RB	High	QPSK	23.36	23.27	23.11	24.0
			16QAM	22.41	22.50	22.15	23.0
		Middle	QPSK	23.30	23.26	23.16	24.0
			16QAM	22.44	22.52	22.12	23.0
		Low	QPSK	23.23	23.17	23.12	24.0
			16QAM	22.35	22.49	22.14	23.0
	50RB	/	QPSK	23.31	23.28	23.17	24.0
16QAM			22.48	22.34	22.15	23.0	

LTE Band 4				Actual output Power (dBm)			Tune up
Band-width	RB allocation	RB offset	Modulation	High	Middle	Low	
15 MHz				1747.5MHz	1732.5MHz	1717.5MHz	
	1RB	High	QPSK	23.78	23.63	23.50	24.5
			16QAM	23.89	23.83	23.67	24.5
		Middle	QPSK	23.70	23.56	23.54	24.5
			16QAM	23.83	23.78	23.62	24.5
		Low	QPSK	23.75	23.49	23.49	24.5
			16QAM	23.93	23.77	23.72	24.5
	36RB	High	QPSK	23.38	23.14	23.13	24.0
			16QAM	22.38	22.34	22.22	23.0
		Middle	QPSK	23.26	23.21	23.04	24.0
			16QAM	22.36	22.43	22.23	23.0
		Low	QPSK	23.18	23.28	23.06	24.0
			16QAM	22.38	22.39	22.27	23.0
	75RB	/	QPSK	23.31	23.26	23.09	24.0
16QAM			22.43	22.35	22.19	23.0	
20 MHz				1745MHz	1732.5MHz	1720MHz	/
	1RB	High	QPSK	23.68	23.57	23.57	24.5
			16QAM	23.40	23.21	23.75	24.5
		Middle	QPSK	23.58	23.67	23.46	24.5
			16QAM	23.37	23.22	23.55	24.5
		Low	QPSK	23.62	23.54	23.55	24.5
			16QAM	23.39	23.22	23.71	24.5
	50RB	High	QPSK	23.21	23.12	23.03	24.0
			16QAM	22.42	22.26	22.15	23.0
		Middle	QPSK	23.21	23.24	23.09	24.0
			16QAM	22.41	22.35	22.17	23.0
		Low	QPSK	23.27	23.15	23.10	24.0
			16QAM	22.38	22.29	22.19	23.0
	100RB	/	QPSK	23.22	23.20	23.06	24.0
16QAM			22.44	22.32	22.18	23.0	

LTE Band 5				Actual output Power (dBm)			Tune up
Band-width	RB allocation	RB offset	Modulation	High	Middle	Low	
1.4 MHz				848.3MHz	836.5MHz	824.7MHz	
	1RB	High	QPSK	21.62	21.52	21.53	22.5
			16QAM	21.50	21.69	21.63	22.5
		Middle	QPSK	21.56	21.57	21.59	22.5
			16QAM	21.45	21.64	21.61	22.5
		Low	QPSK	21.65	21.57	21.51	22.5
			16QAM	21.50	21.49	21.59	22.5
	3RB	High	QPSK	21.82	21.75	21.66	22.5
			16QAM	21.40	21.47	21.46	22.5
		Middle	QPSK	21.75	21.69	21.73	22.5
			16QAM	21.50	21.49	21.46	22.5
		Low	QPSK	21.81	21.70	21.74	22.5
			16QAM	21.44	21.46	21.47	22.5
	6RB	/	QPSK	21.34	21.25	21.25	22.0
16QAM			20.10	20.51	20.36	21.0	
3 MHz				847.5MHz	836.5MHz	825.5MHz	/
	1RB	High	QPSK	21.67	21.54	21.64	22.5
			16QAM	21.71	21.14	21.76	22.5
		Middle	QPSK	21.72	21.08	21.57	22.5
			16QAM	21.72	21.16	21.64	22.5
		Low	QPSK	21.71	21.10	21.62	22.5
			16QAM	21.63	21.12	21.60	22.5
	8RB	High	QPSK	21.28	21.24	21.27	22.0
			16QAM	20.05	20.39	20.20	21.0
		Middle	QPSK	21.37	21.24	21.16	22.0
			16QAM	20.16	20.49	20.23	21.0
		Low	QPSK	20.35	21.12	21.09	22.0
			16QAM	20.18	20.51	20.17	21.0
	15RB	/	QPSK	21.25	21.25	21.10	22.0
16QAM			20.12	20.43	20.18	21.0	

LTE Band 5				Actual output Power (dBm)			Tune up
Band-width	RB allocation	RB offset	Modulation	High	Middle	Low	
5 MHz				846.5MHz	836.5MHz	826.5MHz	
	1RB	High	QPSK	21.58	21.50	21.65	22.5
			16QAM	21.78	21.16	21.89	22.5
		Middle	QPSK	21.63	21.64	21.64	22.5
			16QAM	21.78	21.69	21.85	22.5
		Low	QPSK	21.65	21.73	21.62	22.5
			16QAM	21.63	21.65	21.61	22.5
	12RB	High	QPSK	21.37	21.36	21.36	22.0
			16QAM	20.13	20.49	20.47	21.0
		Middle	QPSK	21.37	21.35	21.44	22.0
			16QAM	20.41	20.74	20.56	21.0
		Low	QPSK	21.11	21.09	21.27	22.0
			16QAM	20.41	20.66	20.38	21.0
	25RB	/	QPSK	21.39	21.32	21.41	22.0
16QAM			20.29	20.59	20.45	21.0	
10 MHz				844MHz	836.5MHz	829MHz	/
	1RB	High	QPSK	21.68	21.69	21.79	22.5
			16QAM	21.36	21.86	21.34	22.5
		Middle	QPSK	21.55	21.68	21.72	22.5
			16QAM	21.18	21.74	21.42	22.5
		Low	QPSK	21.67	21.63	21.77	22.5
			16QAM	21.64	21.74	21.17	22.5
	25RB	High	QPSK	21.44	21.30	21.45	22.0
			16QAM	20.58	20.67	20.71	21.0
		Middle	QPSK	21.23	21.28	21.41	22.0
			16QAM	20.68	20.73	20.51	21.0
		Low	QPSK	21.41	21.23	21.42	22.0
			16QAM	20.87	20.77	20.33	21.0
	50RB	/	QPSK	21.35	21.32	21.42	22.0
16QAM			20.72	20.74	20.54	21.0	



LTE-FDD Band 7				Actual output Power (dBm)			Tune up
Band-width	RB allocation	RB offset	Modulation	High	Middle	Low	
5 MHz				2567.4MHz	2535MHz	2502.5MHz	
	1RB	High	QPSK	21.78	21.27	21.56	22.5
			16QAM	21.83	21.35	21.80	22.5
		Middle	QPSK	21.70	21.18	21.51	22.5
			16QAM	21.93	21.27	21.80	22.5
		Low	QPSK	21.64	21.21	21.47	22.5
			16QAM	21.98	21.34	21.84	22.5
	12RB	High	QPSK	21.38	20.94	21.24	22.0
			16QAM	20.97	21.38	21.57	22.0
		Middle	QPSK	21.32	20.93	21.18	22.0
			16QAM	21.20	21.51	21.63	22.0
		Low	QPSK	21.30	20.82	21.25	22.0
			16QAM	21.16	21.38	21.46	22.0
	25RB	/	QPSK	21.32	20.84	21.19	22.0
16QAM			21.03	21.35	21.54	22.0	
10 MHz				2565MHz	2535MHz	2505MHz	/
	1RB	High	QPSK	21.49	21.26	21.46	22.5
			16QAM	21.86	21.58	21.82	22.5
		Middle	QPSK	21.65	21.26	21.44	22.5
			16QAM	21.70	21.52	21.84	22.5
		Low	QPSK	21.51	21.17	21.49	22.5
			16QAM	21.59	21.48	21.74	22.5
	25RB	High	QPSK	21.36	20.98	21.20	22.0
			16QAM	21.45	21.71	21.74	22.0
		Middle	QPSK	21.34	20.82	21.12	22.0
			16QAM	21.48	21.57	21.47	22.0
		Low	QPSK	21.20	20.77	21.14	22.0
			16QAM	21.55	21.52	21.26	22.0
	50RB	/	QPSK	21.26	20.86	21.09	22.0
16QAM			21.49	21.61	21.51	22.0	

LTE-FDD Band 7				Actual output Power (dBm)			Tune up
Band-width	RB allocation	RB offset	Modulation	High	Middle	Low	
15 MHz				2562.5MHz	2535MHz	2507.5MHz	
	1RB	High	QPSK	21.86	21.44	21.48	<b>22.5</b>
			16QAM	22.30	21.36	21.46	<b>22.5</b>
		Middle	QPSK	21.66	21.21	21.56	<b>22.5</b>
			16QAM	22.03	21.20	21.88	<b>22.5</b>
		Low	QPSK	21.50	21.24	21.62	<b>22.5</b>
			16QAM	21.48	21.26	21.99	<b>22.5</b>
	36RB	High	QPSK	21.44	20.93	21.15	<b>22.0</b>
			16QAM	20.94	21.47	21.77	<b>22.0</b>
		Middle	QPSK	21.23	20.89	21.12	<b>22.0</b>
			16QAM	21.10	21.43	21.56	<b>22.0</b>
		Low	QPSK	21.22	20.93	21.12	<b>22.0</b>
			16QAM	21.29	21.50	21.50	<b>22.0</b>
	75RB	/	QPSK	21.24	20.91	21.05	<b>22.0</b>
16QAM			21.11	21.47	21.59	<b>22.0</b>	
20 MHz				2560MHz	2535MHz	2510MHz	/
	1RB	High	QPSK	<b>21.92</b>	21.41	21.54	<b>22.5</b>
			16QAM	22.21	21.40	21.32	<b>22.5</b>
		Middle	QPSK	21.71	21.38	21.57	<b>22.5</b>
			16QAM	21.91	21.13	21.38	<b>22.5</b>
		Low	QPSK	21.54	<b>21.42</b>	<b>21.67</b>	<b>22.5</b>
			16QAM	21.74	21.27	21.34	<b>22.5</b>
	50RB	High	QPSK	<b>21.32</b>	20.87	21.09	<b>22.0</b>
			16QAM	21.21	21.11	21.17	<b>22.0</b>
		Middle	QPSK	21.28	<b>20.90</b>	<b>21.12</b>	<b>22.0</b>
			16QAM	21.18	21.46	20.79	<b>22.0</b>
		Low	QPSK	21.05	20.80	21.02	<b>22.0</b>
			16QAM	21.23	21.48	20.51	<b>22.0</b>
	100RB	/	QPSK	<b>21.20</b>	20.91	21.19	<b>22.0</b>
16QAM			21.21	21.54	20.83	<b>22.0</b>	



LTE Band 28				Actual output Power (dBm)			Tune up
3 MHz				746.5MHz	719.5MHz	704.5MHz	/
	1RB	High	QPSK	22.17	21.58	21.56	<b>23</b>
			16QAM	21.71	21.77	20.92	<b>23</b>
		Middle	QPSK	22.17	21.57	21.36	<b>23</b>
			16QAM	22.16	21.95	20.95	<b>23</b>
		Low	QPSK	22.15	21.47	21.35	<b>23</b>
			16QAM	22.17	21.33	21.00	<b>23</b>
	8RB	High	QPSK	21.70	21.50	21.01	<b>22.5</b>
			16QAM	20.69	20.77	20.58	<b>21.5</b>
		Middle	QPSK	21.68	21.37	21.00	<b>22.5</b>
			16QAM	20.66	20.83	20.60	<b>21.5</b>
		Low	QPSK	21.55	21.37	21.06	<b>22.5</b>
			16QAM	20.50	20.78	20.41	<b>21.5</b>
	15RB	/	QPSK	21.64	21.49	21.00	<b>22.5</b>
			16QAM	20.49	20.75	20.48	<b>21.5</b>



LTE-FDD Band 28				Actual output Power (dBm)			Tune up
Band-width	RB allocation	RB offset	Modulation	High	Middle	Low	
5 MHz				745.5MHz	720.5MHz	705.5MHz	
	1RB	High	QPSK	22.17	21.64	21.40	23
			16QAM	22.10	21.87	21.77	23
		Middle	QPSK	22.16	21.51	21.43	23
			16QAM	22.12	21.40	21.47	23
		Low	QPSK	22.07	21.48	21.30	23
			16QAM	22.10	21.40	21.04	23
	12RB	High	QPSK	21.66	21.50	21.09	22.5
			16QAM	20.52	20.55	20.63	21.5
		Middle	QPSK	21.62	21.38	21.08	22.5
			16QAM	20.42	20.79	20.65	21.5
		Low	QPSK	21.64	21.39	21.06	22.5
			16QAM	20.05	20.65	20.36	21.5
	25RB	/	QPSK	21.57	21.37	21.06	22.5
16QAM			20.20	20.61	20.49	21.5	
10 MHz				743MHz	723MHz	708MHz	/
	1RB	High	QPSK	22.10	21.82	21.64	23
			16QAM	21.82	22.00	21.43	23
		Middle	QPSK	22.06	21.60	21.42	23
			16QAM	21.67	21.87	21.28	23
		Low	QPSK	22.03	21.45	21.31	23
			16QAM	22.02	21.83	20.98	23
	25RB	High	QPSK	21.66	21.37	21.18	22.5
			16QAM	20.54	20.61	20.70	21.5
		Middle	QPSK	21.73	21.44	21.33	22.5
			16QAM	20.19	20.63	20.23	21.5
		Low	QPSK	21.48	21.44	21.09	22.5
			16QAM	20.22	20.63	20.44	21.5
	50RB	/	QPSK	21.65	21.43	21.26	22.5
16QAM			20.41	20.68	20.32	21.5	





LTE-FDD Band 28				Actual output Power (dBm)			Tune up
Band-width	RB allocation	RB offset	Modulation	High	Middle	Low	
15 MHz				740.5MHz	725.5MHz	710.5MHz	
	1RB	High	QPSK	22.32	22.06	21.69	23
			16QAM	21.97	22.27	22.02	23
		Middle	QPSK	22.17	21.83	21.42	23
			16QAM	21.75	21.94	21.68	23
		Low	QPSK	21.80	21.77	21.38	23
			16QAM	21.56	21.82	21.42	23
	36RB	High	QPSK	21.84	21.56	21.28	22.5
			16QAM	20.44	20.80	20.90	21.5
		Middle	QPSK	21.70	21.41	21.16	22.5
			16QAM	20.37	20.57	20.50	21.5
		Low	QPSK	21.54	21.50	21.33	22.5
			16QAM	20.79	20.43	20.10	21.5
	75RB	/	QPSK	21.64	21.46	21.17	22.5
16QAM			20.60	20.67	20.53	21.5	
20 MHz				738MHz	728MHz	713MHz	/
	1RB	High	QPSK	22.28	22.21	21.72	23
			16QAM	22.37	22.24	22.02	23
		Middle	QPSK	22.08	21.79	21.51	23
			16QAM	22.09	21.99	21.75	23
		Low	QPSK	21.90	21.70	21.30	23
			16QAM	22.00	21.88	21.37	23
	50RB	High	QPSK	21.69	21.65	21.57	22.5
			16QAM	20.75	20.52	21.12	21.5
		Middle	QPSK	21.53	21.48	21.37	22.5
			16QAM	20.66	20.16	20.56	21.5
		Low	QPSK	21.53	21.54	21.20	22.5
			16QAM	20.94	20.89	20.97	21.5
	100RB	/	QPSK	21.61	21.51	21.38	22.5
16QAM			20.80	20.20	20.56	21.5	

#### 10.4. Bluetooth Measurement result

**Table 10.9: The conducted Power measurement results for Bluetooth**

Bluetooth	Tune up	Averaged Power (dBm)	
		Channel	Power (dBm)
GFSK	7	Ch.0 (2402 MHz)	5.96
	8	Ch39 (2441 MHz)	7.03
	8	Ch78 (2480 MHz)	7.33
EDR2M-4_DQPSK	8	Ch.0 (2402 MHz)	6.80
	9	Ch39 (2441 MHz)	8.13
	9.5	Ch78 (2480 MHz)	8.72
EDR3M-8DPSK	8	Ch.0 (2402 MHz)	6.92
	9	Ch39 (2441 MHz)	8.31
	10	Ch78 (2480 MHz)	8.78

## 11. Simultaneous TX SAR Considerations

### 11.1. Introduction

The following procedures adopted from “FCC SAR Considerations for Cell Phones with Multiple Transmitters” are applicable to handsets with built-in unlicensed transmitters such as 802.11 a/b/g and Bluetooth devices which may simultaneously transmit with the licensed transmitter.

For this device, the BT and WLAN can transmit simultaneous with other transmitters.

### 11.2. Transmit Antenna Separation Distances

Top Side

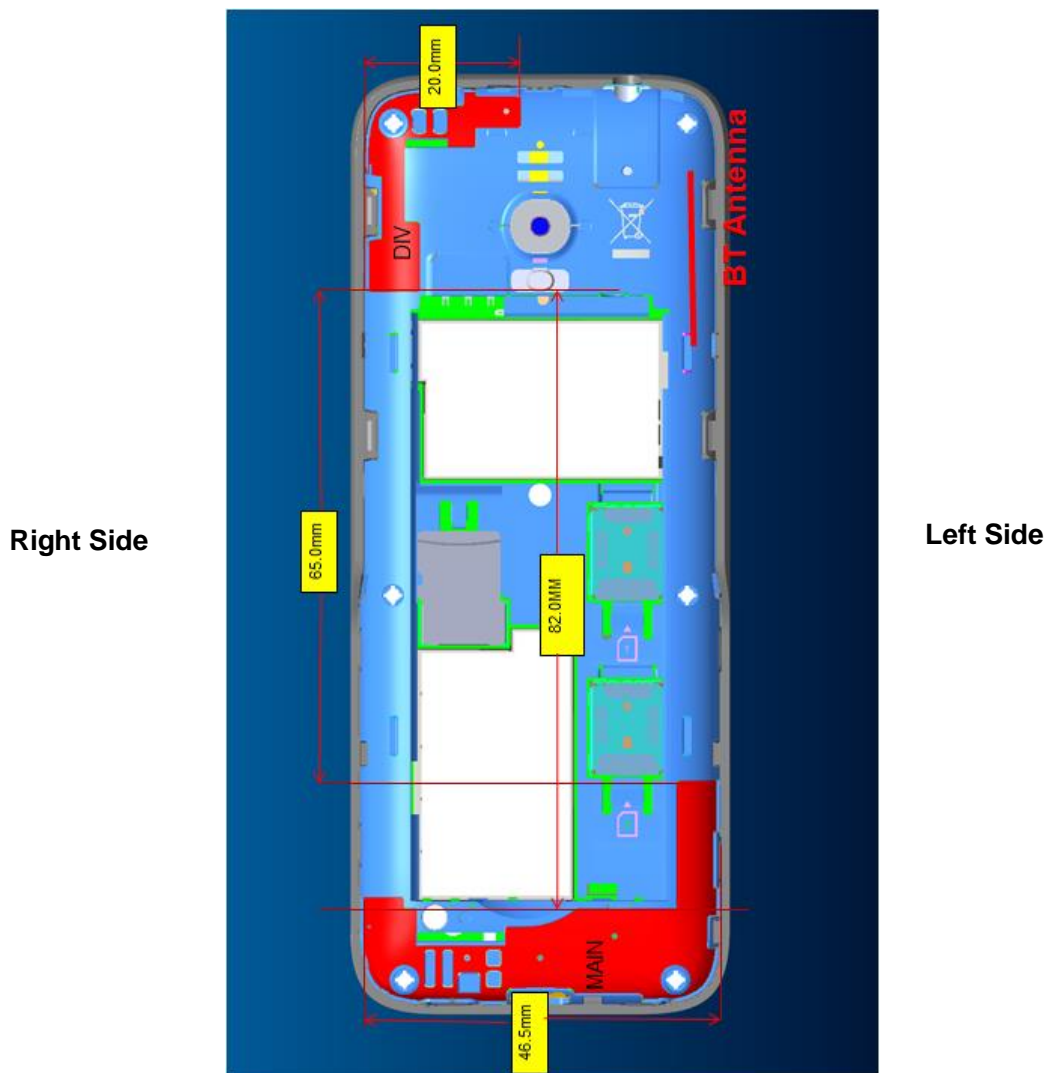

Bottom Side

### 11.3. Standalone SAR Test Exclusion Considerations

Standalone 1-g head or body SAR evaluation by measurement or numerical simulation is not required when the corresponding SAR Exclusion Threshold condition, listed below, is satisfied. The 1-g SAR test exclusion threshold for 100 MHz to 6 GHz at test separation distances  $\leq 50$  mm are determined by:

$[(\text{max. power of channel, including tune-up tolerance, mW}) / (\text{min. test separation distance, mm})] \cdot [\sqrt{f(\text{GHz})}] \leq 3.0$  for 1-g SAR, where

- $f(\text{GHz})$  is the RF channel transmit frequency in GHz
- Power and distance are rounded to the nearest mW and mm before calculation
- The result is rounded to one decimal place for comparison

**Table 11.1: Standalone SAR test exclusion considerations**

Band/Mode	f(GHz)	Position	SAR test exclusion threshold (mW)	RF output power		SAR test exclusion
				dBm	mW	
Bluetooth	2.441	Head	9.60	10	10.0	No
		Body	19.20	10	10.0	Yes

## 12. Evaluation of Simultaneous

**Table 12.1: The sum of reported SAR values for WWAN antenna and Bluetooth**

/	Position	WWAN Antenna (W/kg)	Bluetooth (W/kg)	Sum (W/kg)
Highest reported SAR value for Head	Left Touch	1.39	0.01	1.40
Highest reported SAR value for Body	Rear	1.23	0.14	1.37

Note: the test positions of above tables are for the worse case that has been evaluated.

**Table 12.2: Estimated SAR for Bluetooth**

Position	f (GHz)	Distance (mm)	Upper limit of power *		Estimated <sub>1g</sub> (W/kg)
			dBm	mW	
Body	2.441	15	10	10.0	0.14

\* - Maximum possible output power declared by manufacturer

When standalone SAR test exclusion applies to an antenna that transmits simultaneously with other antennas, the standalone SAR must be estimated according to following to determine simultaneous transmission SAR test exclusion:

(max. power of channel, including tune-up tolerance, mW) / (min. test separation distance, mm) · [ $\sqrt{f(\text{GHz})/x}$ ] W/kg for test separation distances  $\leq 50$  mm;

Where  $x = 7.5$  for 1-g SAR.

When the minimum test separation distance is  $< 5$  mm, a distance of 5 mm is applied to determine SAR test exclusion

### Conclusion:

According to the above tables, the sum of reported SAR values is  $< 1.6$ W/kg. So the simultaneous transmission SAR with volume scans is not required.

### 13. Summary of Test Results

According to the client's decision rule in the test registration form, which is "based on the measurement results as the basis of the conformity statement", the test conclusion of this report meets the limit requirements.

The calculated SAR is obtained by the following formula:

$$\text{Reported SAR} = \text{Measured SAR} \times 10^{(P_{\text{Target}} - P_{\text{Measured}})/10}$$

Where  $P_{\text{Target}}$  is the power of manufacturing upper limit;

$P_{\text{Measured}}$  is the measured power in chapter 10.

**Note:**

B2 (Battery): TLi015MA (TIANMAO)

**Duty Cycle**

Mode	Duty Cycle
Speech for GSM850/1900	1:8.3
GPRS for GSM850	1:4
GPRS for GSM1900	1:2.67
WCDMA850/1700/1900	1:1
FDD_LTE Band 2/4/5/7/28	1:1
Bluetooth	1:1

#### 13.1. Testing Environment

Temperature:	18°C~25°C
Relative humidity:	30%~70%
Ground system resistance:	<4Ω
Ambient noise & Reflection:	< 0.012 W/kg

### 13.2. SAR results

**Table 13.1: SAR Values (GSM 850 - Head)**

Frequency		Test Mode	Test Position	Figure No. / Note	Ambient Temperature: 22.7°C		Liquid Temperature: 22.2°C		
MHz	Ch.				Conducted Power (dBm)	Max. tune-up Power (dBm)	Measured SAR(1g) (W/kg)	Reported SAR(1g) (W/kg)	Power Drift(dB)
836.6	190	Speech	Left Touch	1	32.31	33	1.190	1.39	0.04
836.6	190	Speech	Left Tilt	/	32.31	33	0.617	0.72	-0.01
836.6	190	Speech	Right Touch	/	32.31	33	1.090	1.28	0.04
836.6	190	Speech	Right Tilt	/	32.31	33	0.639	0.75	0.06
848.8	251	Speech	Left Touch	/	32.29	33	1.130	1.33	0.00
824.4	128	Speech	Left Touch	/	32.38	33	1.110	1.28	-0.06
848.8	251	Speech	Right Touch	/	32.29	33	1.160	1.37	0.03
824.4	128	Speech	Right Touch	/	32.38	33	1.040	1.20	-0.02
836.6	190	Speech	Left Touch	B2	32.31	33	1.110	1.30	-0.06

**Table 13.2: SAR Values (GSM 850 -Body)**

Frequency		Test Mode	Test Position	Figure No. / Note	Ambient Temperature: 22.7°C		Liquid Temperature: 22.2°C		
MHz	Ch.				Conducted Power (dBm)	Max. tune-up Power (dBm)	Measured SAR(1g) (W/kg)	Reported SAR(1g) (W/kg)	Power Drift(dB)
<b>Body-Worn Test Data (15mm)</b>									
836.6	190	GPRS	Front	/	31.28	32	0.897	1.06	-0.02
836.6	190	GPRS	Rear	/	31.28	32	0.924	1.09	0.01
848.8	251	GPRS	Front	/	31.26	32	0.884	1.05	-0.01
824.4	128	GPRS	Front	/	31.48	32	0.798	0.90	-0.01
848.8	251	GPRS	Rear	/	31.26	32	0.865	1.03	0.02
824.4	128	GPRS	Rear	/	31.48	32	0.860	0.97	0.05
836.6	190	GPRS	Rear	2 /B2	31.28	32	0.964	1.14	-0.02

**Table 13.3: SAR Values (GSM 1900 - Head)**

Frequency		Test Mode	Test Position	Figure No. / Note	Conducted Power (dBm)	Max. tune-up Power (dBm)	Measured SAR(1g) (W/kg)	Reported SAR(1g) (W/kg)	Power Drift(dB)
MHz	Ch.								
Ambient Temperature: 22.7°C		Liquid Temperature: 22.2°C							
1880	661	Speech	Left Touch	/	30.36	31	0.243	0.28	0.03
1880	661	Speech	Left Tilt	/	30.36	31	0.116	0.13	0.01
1880	661	Speech	Right Touch	<b>3</b>	30.36	31	<b>0.312</b>	<b>0.36</b>	-0.06
1880	661	Speech	Right Tilt	/	30.36	31	0.204	0.24	0.05
1880	661	Speech	Right Touch	B2	30.35	31	0.304	0.35	0.06

**Table 13.4: SAR Values (GSM 1900 - Body)**

Frequency		Test Mode	Test Position	Figure No. / Note	Conducted Power (dBm)	Max. tune-up Power (dBm)	Measured SAR(1g) (W/kg)	Reported SAR(1g) (W/kg)	Power Drift(dB)
MHz	Ch.								
Ambient Temperature: 22.4°C		Liquid Temperature: 22.0°C							
<b>Body-Worn Test Data (15mm)</b>									
1880	661	GPRS	Front	/	26.46	27.5	0.623	0.79	-0.08
1880	661	GPRS	Rear	/	26.46	27.5	0.747	0.95	0.06
1909.8	810	GPRS	Rear	/	26.25	27.5	0.755	1.01	0.10
1850.2	512	GPRS	Rear	/	26.78	27.5	0.728	0.86	0.10
1909.8	810	GPRS	Rear	<b>4 /B2</b>	26.25	27.5	<b>0.805</b>	<b>1.07</b>	-0.05



**Table 13.5: SAR Values (WCDMA Band 2 - Head)**

Frequency		Test Mode	Test Position	Figure No. / Note	Conducted Power (dBm)	Max. tune-up Power (dBm)	Measured SAR(1g) (W/kg)	Reported SAR(1g) (W/kg)	Power Drift(dB)
Ambient Temperature: 22.7°C	Liquid Temperature: 22.2°C								
MHz	Ch.								
1880	9400	RMC	Left Touch	/	22.6	23.5	0.740	0.91	-0.02
1880	9400	RMC	Left Tilt	/	22.6	23.5	0.307	0.38	0.11
1880	9400	RMC	Right Touch	/	22.6	23.5	0.646	0.79	0.03
1880	9400	RMC	Right Tilt	/	22.6	23.5	0.387	0.48	0.05
1907.6	9538	RMC	Left Touch	<b>5</b>	22.7	23.5	<b>0.765</b>	<b>0.92</b>	0.04
1852.4	9262	RMC	Left Touch	/	22.9	23.5	0.681	0.78	0.06
1907.6	9538	RMC	Left Touch	B2	22.7	23.5	0.715	0.86	0.13

**Table 13.6: SAR Values (WCDMA Band 2 - Body)**

Frequency		Test Mode	Test Position	Figure No. / Note	Conducted Power (dBm)	Max. tune-up Power (dBm)	Measured SAR(1g) (W/kg)	Reported SAR(1g) (W/kg)	Power Drift(dB)
Ambient Temperature: 22.4°C	Liquid Temperature: 22.0°C								
MHz	Ch.								
<b>Body-Worn Test Data (15mm)</b>									
1880	9400	RMC	Front	/	22.6	23.5	0.733	0.90	0.05
1880	9400	RMC	Rear	/	22.6	23.5	0.812	1.00	0.02
1907.6	9538	RMC	Front	/	22.7	23.5	0.740	0.89	0.02
1852.4	9262	RMC	Front	/	22.9	23.5	0.696	0.80	0.06
1907.6	9538	RMC	Rear	/	22.7	23.5	0.799	0.96	0.03
1852.4	9262	RMC	Rear	/	22.9	23.5	0.796	0.91	0.03
1880	9400	RMC	Rear	<b>6 /B2</b>	22.6	23.5	<b>0.829</b>	<b>1.02</b>	0.03

**Table 13.7: SAR Values (WCDMA Band 4 - Head)**

Frequency		Test Mode	Test Position	Figure No. / Note	Conducted Power (dBm)	Max. tune-up Power (dBm)	Measured SAR(1g) (W/kg)	Reported SAR(1g) (W/kg)	Power Drift(dB)
MHz	Ch.								
Ambient Temperature: 22.9°C      Liquid Temperature: 22.4°C									
1732.6	1413	RMC	Left Touch	/	23.6	24	0.749	0.82	0.15
1732.6	1413	RMC	Left Tilt	/	23.6	24	0.225	0.25	0.17
1732.6	1413	RMC	Right Touch	/	23.6	24	0.685	0.75	0.04
1732.6	1413	RMC	Right Tilt	/	23.6	24	0.339	0.37	0.06
1752.6	1513	RMC	Left Touch	<b>7</b>	23.6	24	<b>0.868</b>	<b>0.95</b>	0.04
1712.4	1312	RMC	Left Touch	/	23.5	24	0.610	0.68	0.08
1752.6	1513	RMC	Left Touch	B2	23.6	24	0.750	0.82	0.04

**Table 13.8: SAR Values ( WCDMA Band 4 - Body)**

Frequency		Test Mode	Test Position	Figure No. / Note	Conducted Power (dBm)	Max. tune-up Power (dBm)	Measured SAR(1g) (W/kg)	Reported SAR(1g) (W/kg)	Power Drift(dB)
MHz	Ch.								
Ambient Temperature: 22.6°C      Liquid Temperature: 22.1°C									
<b>Body-Worn Test Data (15mm)</b>									
1732.6	1413	RMC	Front	/	23.6	24	0.736	0.81	0.06
1732.6	1413	RMC	Rear	/	23.6	24	0.858	0.94	0.10
1752.6	1513	RMC	Front	/	23.6	24	0.838	0.92	0.04
1712.4	1312	RMC	Front	/	23.5	24	0.637	0.71	0.03
1752.6	1513	RMC	Rear	<b>8</b>	23.6	24	<b>1.010</b>	<b>1.11</b>	0.08
1712.4	1312	RMC	Rear	/	23.5	24	0.981	1.10	0.17
1732.6	1413	RMC	Rear	B2	23.6	24	1.000	1.10	0.15

**Table 13.9: SAR Values (WCDMA Band 5 - Head)**

Frequency		Test Mode	Test Position	Figure No. / Note	Conducted Power (dBm)	Max. tune-up Power (dBm)	Measured SAR(1g) (W/kg)	Reported SAR(1g) (W/kg)	Power Drift(dB)
MHz	Ch.								
Ambient Temperature: 22.7°C      Liquid Temperature: 22.2°C									
836.4	4182	RMC	Left Touch	/	22.6	23.5	0.910	1.12	0.04
836.4	4182	RMC	Left Tilt	/	22.6	23.5	0.504	0.62	0.00
836.4	4182	RMC	Right Touch	/	22.6	23.5	0.827	1.02	0.03
836.4	4182	RMC	Right Tilt	/	22.6	23.5	0.491	0.60	0.05
846.6	4233	RMC	Left Touch	/	22.5	23.5	0.942	1.19	0.01
826.4	4132	RMC	Left Touch	<b>9</b>	22.8	23.5	<b>1.050</b>	<b>1.23</b>	-0.01
846.6	4233	RMC	Right Touch	/	22.5	23.5	0.886	1.12	0.03
826.4	4132	RMC	Right Touch	/	22.8	23.5	0.972	1.14	0.05
836.4	4182	RMC	Left Touch	B2	22.8	23.5	1.040	1.22	-0.13

**Table 13.10: SAR Values (WCDMA Band 5 -Body)**

Frequency		Test Mode	Test Position	Figure No. / Note	Conducted Power (dBm)	Max. tune-up Power (dBm)	Measured SAR(1g) (W/kg)	Reported SAR(1g) (W/kg)	Power Drift(dB)
MHz	Ch.								
Ambient Temperature: 22.7°C      Liquid Temperature: 22.2°C									
<b>Body-Worn Test Data (15mm)</b>									
836.4	4182	RMC	Front	/	22.6	23.5	0.280	0.34	-0.02
836.4	4182	RMC	Rear	<b>10</b>	22.6	23.5	<b>0.363</b>	<b>0.45</b>	0.11
836.4	4182	RMC	Rear	B2	22.6	23.5	0.355	0.44	0.03