

16. Main Test Instruments

Table 16.1: List of Main Instruments

No.	Name	Type	Serial Number	Calibration Date	Valid Period
01	Network analyzer	Agilent E5071C	MY46103759	2019-11-15	One year
02	Dielectric probe	85070E	MY44300317	/	/
03	Power meter	E4418B	MY50000366	2019-12-14	One year
04	Power sensor	E9304A	MY50000188		
05	Power meter	NRP	101460	2020-01-15	One year
06	Power sensor	NRP-Z91	100553		
07	Signal Generator	E8257D	MY47461211	2019-06-03	One year
08	Amplifier	VTL5400	0404	/	/
09	E-field Probe	ES3DV3	3151	2020-01-03	One year
11	DAE	DAE4	786	2020-03-03	One year
12	Dipole Validation Kit	D835V2	4d057	2018-10-09	Three year
13	Dipole Validation Kit	D1750V2	1152	2019-08-30	One year
14	Dipole Validation Kit	D1900V2	5d088	2018-10-24	Three year
15	Dipole Validation Kit	D2450V2	873	2018-10-26	Three year
16	Dipole Validation Kit	D2550V2	1058	2018-08-24	Three year
17	Radio Communication Analyzer	Anristu MT8820C	6201341853	2020-01-15	One year
18	Software	DASY5	52.8.8.1222	/	/

ANNEX A: Graph Results

GSM850 Head

Date: 2020-3-12

Electronics: DAE4 Sn786

Medium: Head 835MHz

Medium parameters used (interpolated): $f = 836.6$ MHz; $\sigma = 0.885$ S/m; $\epsilon_r = 41.943$; $\rho = 1000$ kg/m³

Ambient Temperature: 22.0°C Liquid Temperature: 21.5°C

Communication System: UID 0, GSM (0) Frequency: 836.6 MHz Duty Cycle: 1:8.3

Probe: ES3DV3 – SN3151 ConvF (6.41, 6.41, 6.41);

Left Cheek Middle/Area Scan (61x101x1): Interpolated grid: dx=1.500 mm, dy=1.500 mm

Maximum value of SAR (interpolated) = 0.299 W/kg

Left Cheek Middle/Zoom Scan (5x5x7)/Cube 0: Measurement grid: dx=8mm, dy=8mm, dz=5mm

Reference Value = 3.340 V/m; Power Drift = 0.02 dB

Peak SAR (extrapolated) = 0.336 W/kg

SAR(1 g) = 0.229 W/kg; SAR(10 g) = 0.157 W/kg

Maximum value of SAR (measured) = 0.304 W/kg

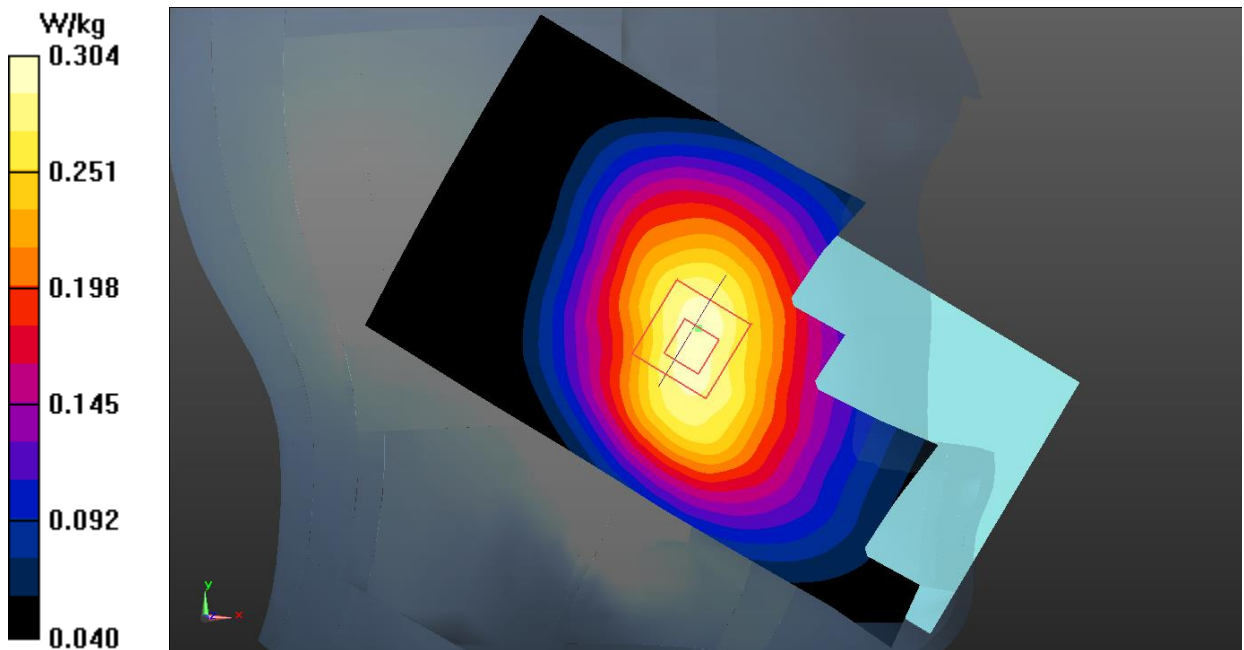

Fig.1 GSM 850 Head

GSM850 Body

Date: 2020-3-12

Electronics: DAE4 Sn786

Medium: Head 835MHz

Medium parameters used (interpolated): $f = 836.6$ MHz; $\sigma = 0.885$ S/m; $\epsilon_r = 41.943$; $\rho = 1000$ kg/m³

Ambient Temperature: 22.0°C Liquid Temperature: 21.5°C

Communication System: UID 0, GPRS 2Txslot (0) Frequency: 836.6 MHz Duty Cycle: 1:4

Probe: ES3DV3 – SN3151 ConvF (6.41, 6.41, 6.41);

Rear Side Middle/Area Scan (61x111x1): Interpolated grid: $dx=1.500$ mm, $dy=1.500$ mm

Maximum value of SAR (interpolated) = 0.408 W/kg

Rear Side Middle/Zoom Scan (5x5x7)/Cube 0: Measurement grid: $dx=8$ mm, $dy=8$ mm, $dz=5$ mm

Reference Value = 17.47 V/m; Power Drift = 0.14 dB

Peak SAR (extrapolated) = 0.502 W/kg

SAR(1 g) = 0.390 W/kg; SAR(10 g) = 0.293 W/kg

Maximum value of SAR (measured) = 0.409 W/kg

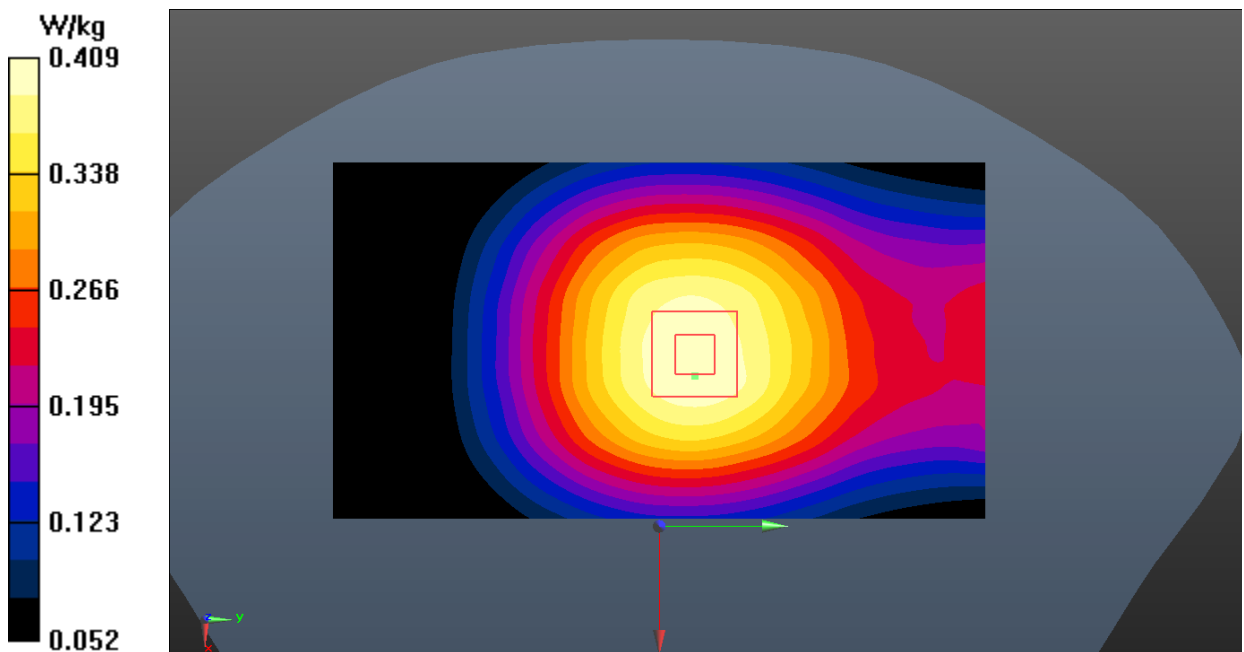
**Fig.2 GSM 850 Body**

GSM1900 Head

Date: 2020-4-1

Electronics: DAE4 Sn786

Medium: Head 1900MHz

Medium parameters used: $f = 1880$ MHz; $\sigma = 1.401$ S/m; $\epsilon_r = 39.224$; $\rho = 1000$ kg/m³

Ambient Temperature: 22.0°C Liquid Temperature: 21.5°C

Communication System: UID 0, GSM (0) Frequency: 1880 MHz Duty Cycle: 1:8.3

Probe: ES3DV3 – SN3151 ConvF (5.11, 5.11, 5.11);

Right Cheek Middle /Area Scan (61x71x1): Interpolated grid: $dx=1.500$ mm, $dy=1.500$ mm

Maximum value of SAR (interpolated) = 1.57 W/kg

Right Cheek Middle /Zoom Scan (5x5x7)/Cube 0: Measurement grid: $dx=8$ mm, $dy=8$ mm, $dz=5$ mm

Reference Value = 12.45 V/m; Power Drift = -0.05 dB

Peak SAR (extrapolated) = 1.92 W/kg

SAR(1 g) = 0.981 W/kg; SAR(10 g) = 0.512 W/kg

Maximum value of SAR (measured) = 1.08 W/kg

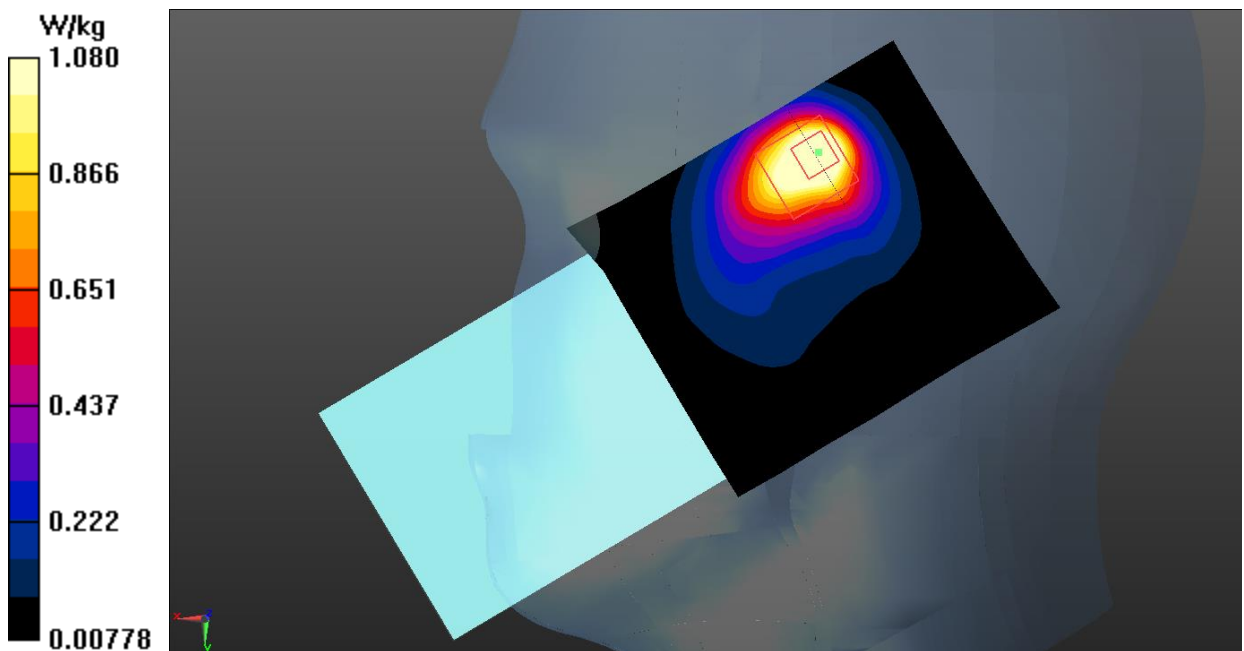

Fig.3 GSM 1900 Head

GSM1900 Body

Date: 2020-4-1

Electronics: DAE4 Sn786

Medium: Head 1900MHz

Medium parameters used: $f = 1880$ MHz; $\sigma = 1.401$ S/m; $\epsilon_r = 39.224$; $\rho = 1000$ kg/m³

Ambient Temperature: 22.0°C Liquid Temperature: 21.5°C

Communication System: UID 0, GPRS 3Txslot (0) Frequency: 1880 MHz Duty Cycle: 1:2.67

Probe: ES3DV3 – SN3151 ConvF (5.11, 5.11, 5.11);

Rear Side Middle /Area Scan (61x111x1): Interpolated grid: dx=1.500 mm, dy=1.500 mm

Maximum value of SAR (interpolated) = 0.697 W/kg

Rear Side Middle /Zoom Scan (5x5x7)/Cube 0: Measurement grid: dx=8mm, dy=8mm, dz=5mm

Reference Value = 8.971 V/m; Power Drift = 0.17 dB

Peak SAR (extrapolated) = 1.13 W/kg

SAR(1 g) = 0.607 W/kg; SAR(10 g) = 0.328 W/kg

Maximum value of SAR (measured) = 0.665 W/kg

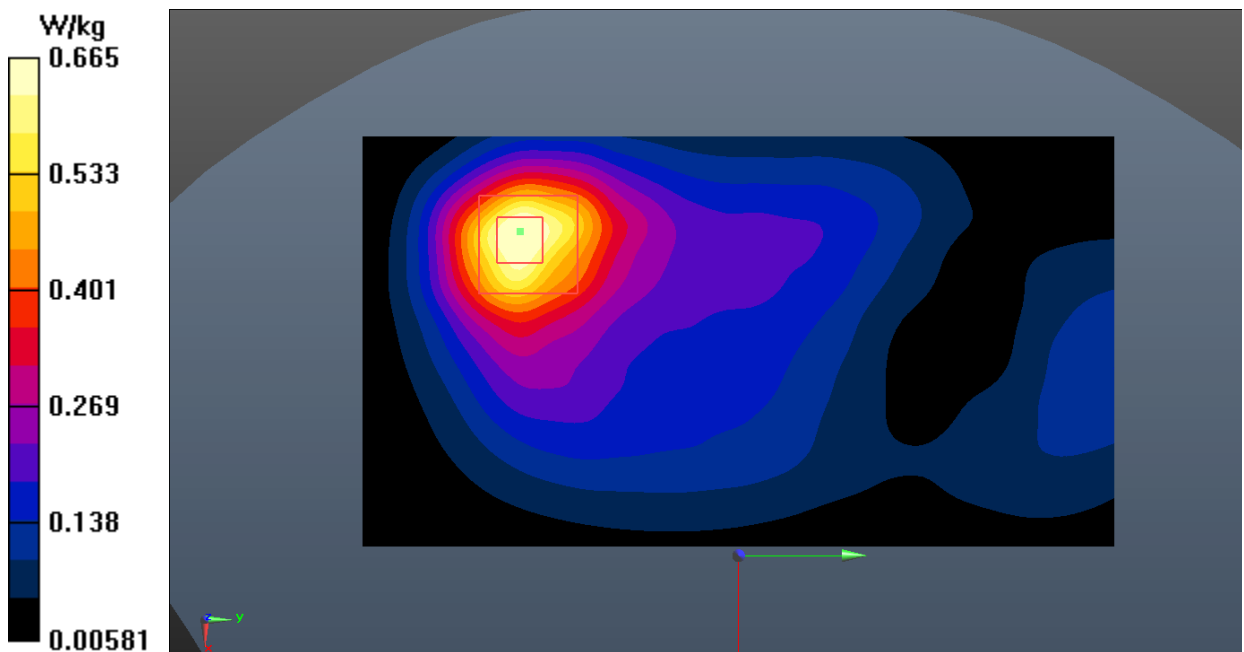

Fig.4 GSM 1900 Body

WCDMA Band 2 Head

Date: 2020-4-1

Electronics: DAE4 Sn786

Medium: Head 1900MHz

Medium parameters used (interpolated): $f = 1852.4$ MHz; $\sigma = 1.377$ S/m; $\epsilon_r = 39.332$; $\rho = 1000$ kg/m³

Ambient Temperature: 22.0°C Liquid Temperature: 21.5°C

Communication System: UID 0, WCDMA (0) Frequency: 1852.4 MHz Duty Cycle: 1:1

Probe: ES3DV3 – SN3151 ConvF (5.11, 5.11, 5.11);

Right Cheek Low /Area Scan (61x111x1): Interpolated grid: dx=1.500 mm, dy=1.500 mm

Maximum value of SAR (interpolated) = 1.59 W/kg

Right Cheek Low /Zoom Scan (5x5x7)/Cube 0: Measurement grid: dx=8mm, dy=8mm, dz=5mm

Reference Value = 14.16 V/m; Power Drift = 0.06 dB

Peak SAR (extrapolated) = 2.12 W/kg

SAR(1 g) = 1.14 W/kg; SAR(10 g) = 0.602 W/kg

Maximum value of SAR (measured) = 1.41 W/kg

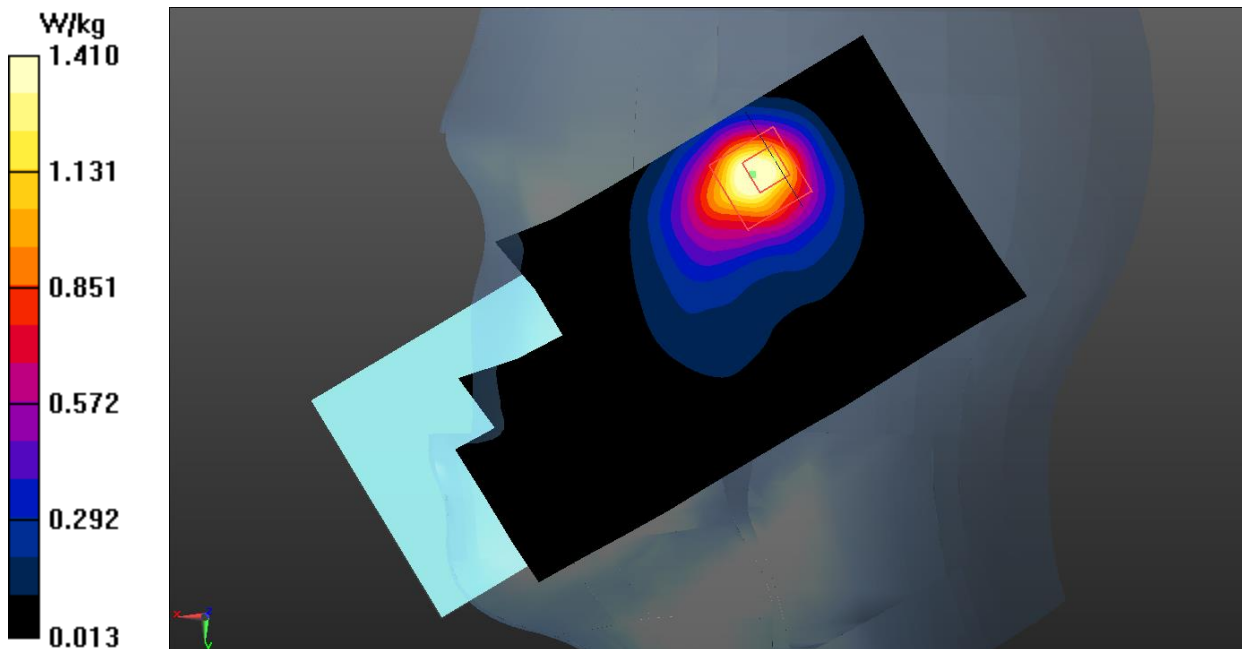
**Fig.5 WCDMA Band 2 Head**

WCDMA Band 2 Body

Date: 2020-4-1

Electronics: DAE4 Sn786

Medium: Head 1900MHz

Medium parameters used: $f = 1908$ MHz; $\sigma = 1.426$ S/m; $\epsilon_r = 39.115$; $\rho = 1000$ kg/m³

Ambient Temperature: 22.0°C Liquid Temperature: 21.5°C

Communication System: UID 0, WCDMA (0) Frequency: 1907.6 MHz Duty Cycle: 1:1

Probe: ES3DV3 – SN3151 ConvF (5.11, 5.11, 5.11);

Rear Side High/Area Scan (61x61x1): Interpolated grid: dx=1.500 mm, dy=1.500 mm

Maximum value of SAR (interpolated) = 1.49 W/kg

Rear Side High/Zoom Scan (5x5x7)/Cube 0: Measurement grid: dx=8mm, dy=8mm, dz=5mm

Reference Value = 15.15 V/m; Power Drift = -0.02 dB

Peak SAR (extrapolated) = 1.91 W/kg

SAR(1 g) = 1.02 W/kg; SAR(10 g) = 0.557 W/kg

Maximum value of SAR (measured) = 1.09 W/kg

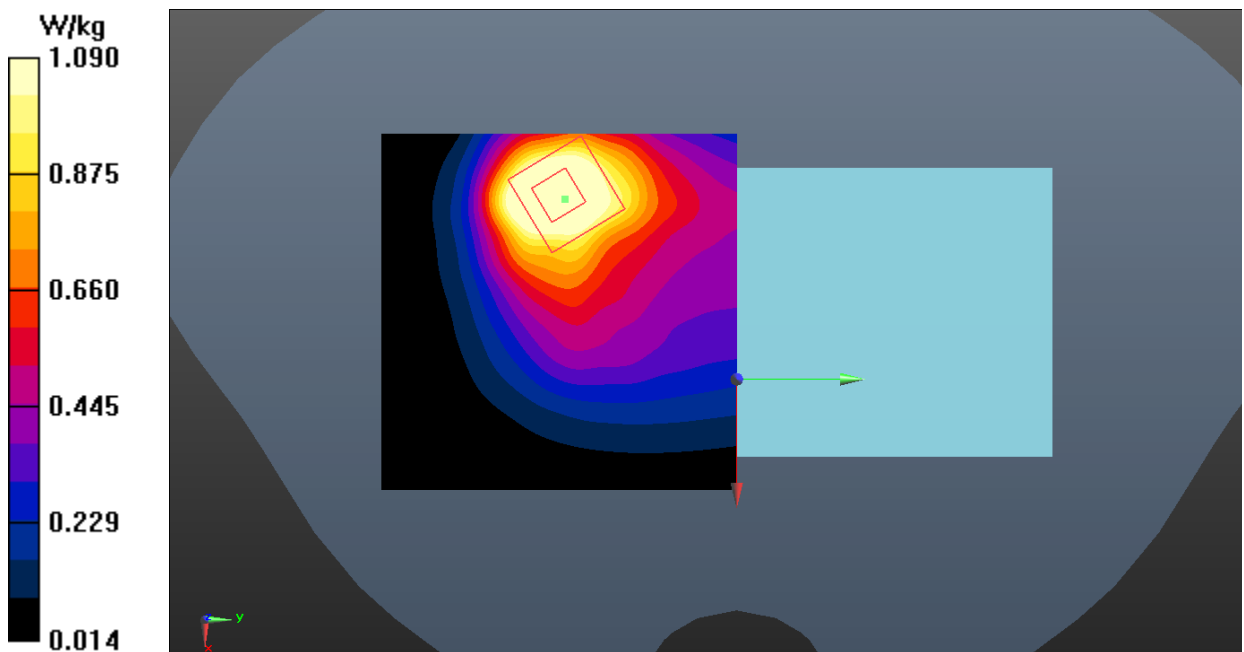

Fig.6 WCDMA Band 2 Body

WCDMA Band 4 Head

Date: 2020-3-28

Electronics: DAE4 Sn786

Medium: Head 1750MHz

Medium parameters used: $f = 1753 \text{ MHz}$; $\sigma = 1.355 \text{ S/m}$; $\epsilon_r = 39.556$; $\rho = 1000 \text{ kg/m}^3$ Ambient Temperature: 22.0°C Liquid Temperature: 21.5°C Communication System: UID 0, WCDMA (0) Frequency: 1752.6 MHz Duty Cycle: 1:1

Probe: ES3DV3 – SN3151 ConvF (5.23, 5.23, 5.23);

Right Cheek High/Area Scan (61x61x1): Interpolated grid: $dx=1.500 \text{ mm}$, $dy=1.500 \text{ mm}$ Maximum value of SAR (interpolated) = 1.78 W/kg **Right Cheek High/Zoom Scan (5x5x7)/Cube 0:** Measurement grid: $dx=8\text{mm}$, $dy=8\text{mm}$, $dz=5\text{mm}$ Reference Value = 10.92 V/m ; Power Drift = 0.01 dB Peak SAR (extrapolated) = 1.78 W/kg **SAR(1 g) = 0.962 W/kg ; SAR(10 g) = 0.501 W/kg** Maximum value of SAR (measured) = 1.34 W/kg 

Fig.7 WCDMA Band 4 Head

WCDMA Band 4 Body

Date: 2020-3-28

Electronics: DAE4 Sn786

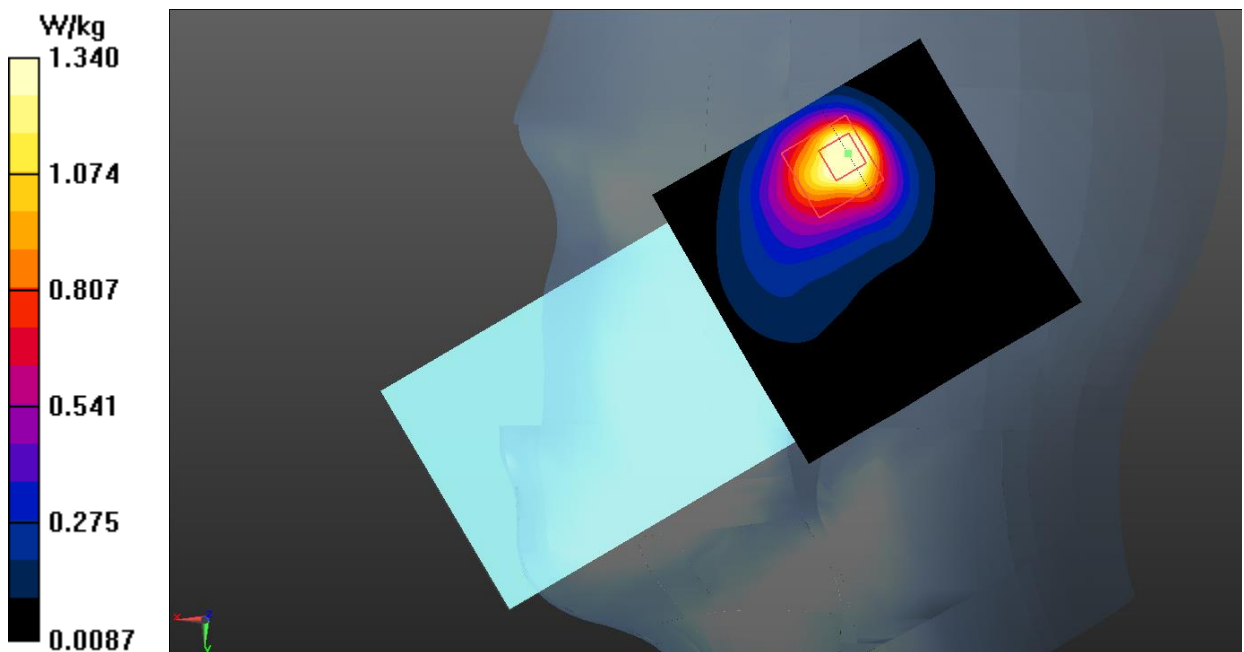
Medium: Head 1750MHz

Medium parameters used: $f = 1753 \text{ MHz}$; $\sigma = 1.355 \text{ S/m}$; $\epsilon_r = 39.556$; $\rho = 1000 \text{ kg/m}^3$ Ambient Temperature: 22.0°C Liquid Temperature: 21.5°C Communication System: UID 0, WCDMA (0) Frequency: 1752.6 MHz Duty Cycle: 1:1

Probe: ES3DV3 – SN3151 ConvF (5.23, 5.23, 5.23);

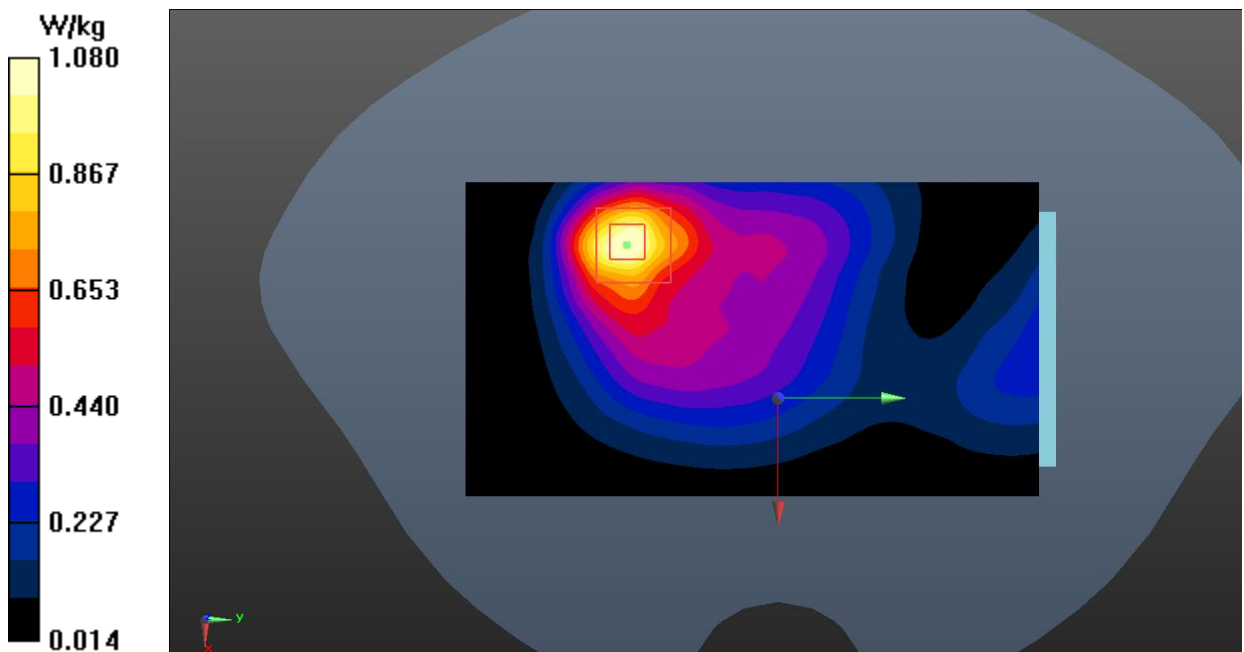
Rear Side High/Area Scan (61x111x1): Interpolated grid: $dx=1.500 \text{ mm}$, $dy=1.500 \text{ mm}$ Maximum value of SAR (interpolated) = 1.13 W/kg **Rear Side High/Zoom Scan (5x5x7)/Cube 0:** Measurement grid: $dx=8\text{mm}$, $dy=8\text{mm}$, $dz=5\text{mm}$ Reference Value = 15.32 V/m ; Power Drift = 0.03 dB Peak SAR (extrapolated) = 1.40 W/kg **SAR(1 g) = 0.752 W/kg ; SAR(10 g) = 0.407 W/kg** Maximum value of SAR (measured) = 1.08 W/kg **Fig.8 WCDMA Band 4 Body**

WCDMA Band 5 Head

Date: 2020-3-12

Electronics: DAE4 Sn786

Medium: Head 835MHz

Medium parameters used (interpolated): $f = 836.4$ MHz; $\sigma = 0.885$ S/m; $\epsilon_r = 41.945$; $\rho = 1000$ kg/m³

Ambient Temperature: 22.0°C Liquid Temperature: 21.5°C

Communication System: UID 0, WCDMA (0) Frequency: 836.4 MHz Duty Cycle: 1:1

Probe: ES3DV3 – SN3151 ConvF (6.41, 6.41, 6.41);

Right Cheek Middle/Area Scan (61x61x1): Interpolated grid: dx=1.500 mm, dy=1.500 mm

Maximum value of SAR (interpolated) = 0.249 W/kg

Right Cheek Middle/Zoom Scan (5x5x7)/Cube 0: Measurement grid: dx=8mm, dy=8mm, dz=5mm

Reference Value = 4.683 V/m; Power Drift = 0.05 dB

Peak SAR (extrapolated) = 0.270 W/kg

SAR(1 g) = 0.213 W/kg; SAR(10 g) = 0.160 W/kg

Maximum value of SAR (measured) = 0.246 W/kg

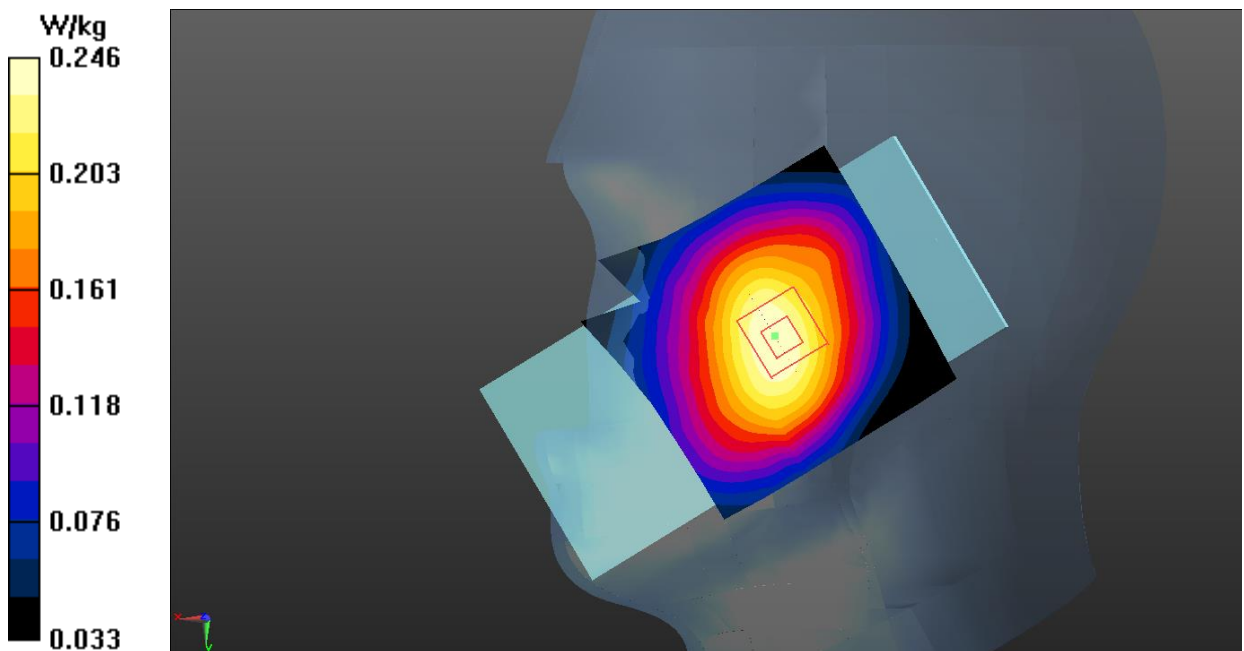

Fig.9 WCDMA Band 5 Head

WCDMA Band 5 Body

Date: 2020-3-12

Electronics: DAE4 Sn786

Medium: Head 835MHz

Medium parameters used (interpolated): $f = 836.4$ MHz; $\sigma = 0.885$ S/m; $\epsilon_r = 41.945$; $\rho = 1000$ kg/m³

Ambient Temperature: 22.0°C Liquid Temperature: 21.5°C

Communication System: UID 0, WCDMA (0) Frequency: 836.4 MHz Duty Cycle: 1:1

Probe: ES3DV3 – SN3151 ConvF (6.41, 6.41, 6.41);

Rear Side Middle/Area Scan (61x91x1): Interpolated grid: dx=1.500 mm, dy=1.500 mm

Maximum value of SAR (interpolated) = 0.447 W/kg

Rear Side Middle/Zoom Scan (5x5x7)/Cube 0: Measurement grid: dx=8mm, dy=8mm, dz=5mm

Reference Value = 19.59 V/m; Power Drift = 0.02 dB

Peak SAR (extrapolated) = 0.480 W/kg

SAR(1 g) = 0.380 W/kg; SAR(10 g) = 0.285 W/kg

Maximum value of SAR (measured) = 0.400 W/kg

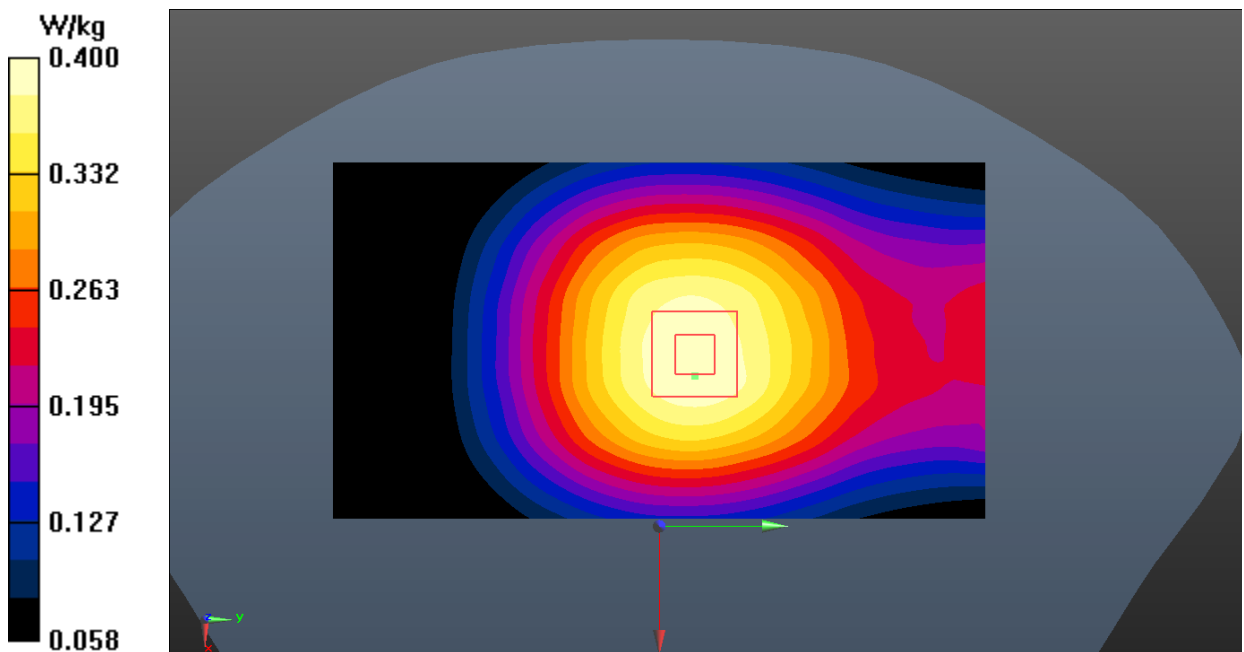

Fig.10 WCDMA Band 5 Body

LTE Band 2 Head

Date: 2020-4-1

Electronics: DAE4 Sn786

Medium: Head 1900MHz

Medium parameters used: $f = 1900$ MHz; $\sigma = 1.419$ S/m; $\epsilon_r = 39.146$; $\rho = 1000$ kg/m³

Ambient Temperature: 22.0°C Liquid Temperature: 21.5°C

Communication System: UID 0, LTE_FDD (0) Frequency: 1900 MHz Duty Cycle: 1:1

Probe: ES3DV3 – SN3151 ConvF (5.11, 5.11, 5.11);

Right Cheek High 1RB_99/Area Scan (61x61x1): Interpolated grid: dx=1.500 mm, dy=1.500 mm

Maximum value of SAR (interpolated) = 1.47 W/kg

Right Cheek High 1RB_99/Zoom Scan (5x5x7)/Cube 0: Measurement grid: dx=8mm, dy=8mm, dz=5mm

Reference Value = 10.60 V/m; Power Drift = 0.17 dB

Peak SAR (extrapolated) = 1.74 W/kg

SAR(1 g) = 0.858 W/kg; SAR(10 g) = 0.427 W/kg

Maximum value of SAR (measured) = 1.11 W/kg

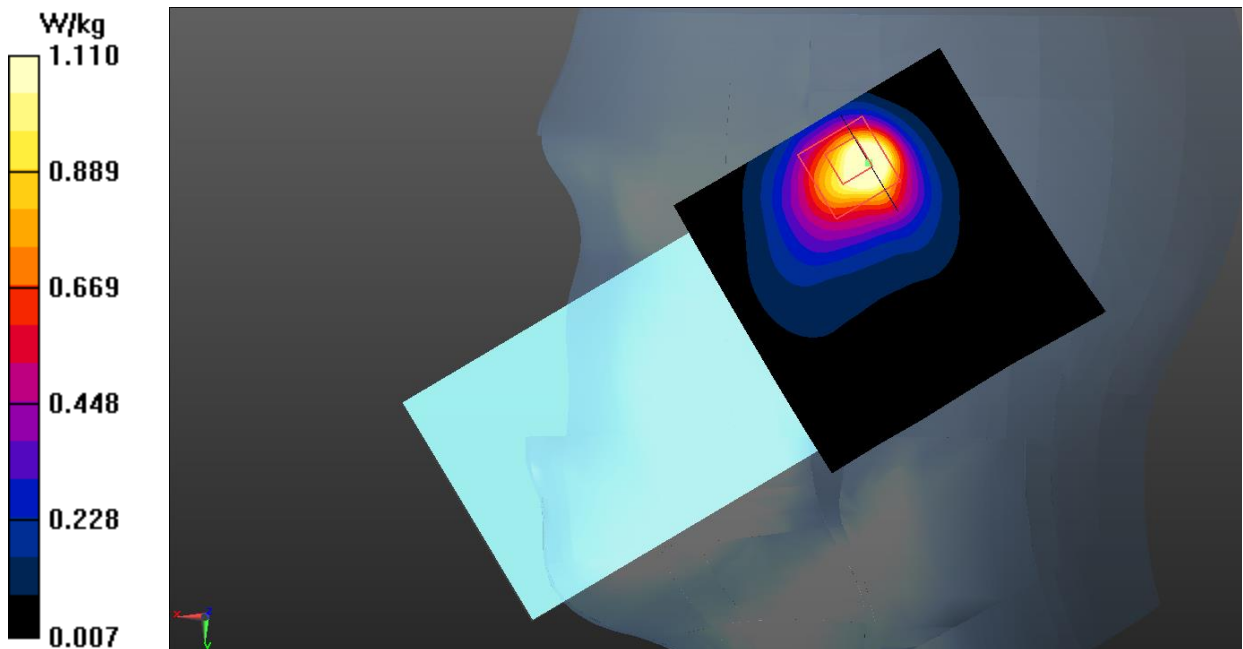

Fig.11 LTE Band 2 Head

LTE Band 2 Body

Date: 2020-4-1

Electronics: DAE4 Sn786

Medium: Head 1900MHz

Medium parameters used: $f = 1900 \text{ MHz}$; $\sigma = 1.419 \text{ S/m}$; $\epsilon_r = 39.146$; $\rho = 1000 \text{ kg/m}^3$

Ambient Temperature: 22.0°C Liquid Temperature: 21.5°C

Communication System: UID 0, LTE_FDD (0) Frequency: 1900 MHz Duty Cycle: 1:1

Probe: ES3DV3 – SN3151 ConvF (5.11, 5.11, 5.11);

Rear Side High 1RB_99/Area Scan (61x61x1): Interpolated grid: $dx=1.500 \text{ mm}$, $dy=1.500 \text{ mm}$

Maximum value of SAR (interpolated) = 1.45 W/kg

Rear Side High 1RB_99/Zoom Scan (5x5x7)/Cube 0: Measurement grid: $dx=8\text{mm}$, $dy=8\text{mm}$, $dz=5\text{mm}$

Reference Value = 14.68 V/m; Power Drift = 0.05 dB

Peak SAR (extrapolated) = 1.85 W/kg

SAR(1 g) = 0.998 W/kg; SAR(10 g) = 0.550 W/kg

Maximum value of SAR (measured) = 1.08 W/kg

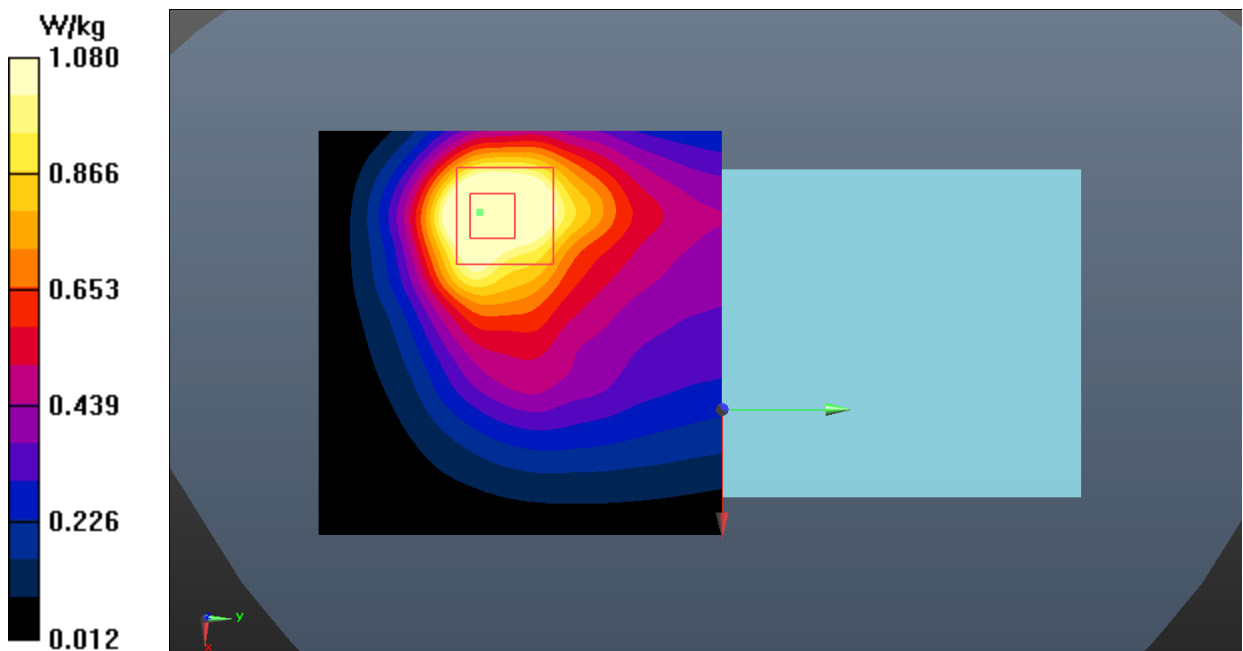

Fig.12 LTE Band 2 Body

LTE Band 4 Head

Date: 2020-3-28

Electronics: DAE4 Sn786

Medium: Head 1750MHz

Medium parameters used: $f = 1745 \text{ MHz}$; $\sigma = 1.348 \text{ S/m}$; $\epsilon_r = 35.588$; $\rho = 1000 \text{ kg/m}^3$

Ambient Temperature: 22.0°C Liquid Temperature: 21.5°C

Communication System: UID 0, LTE_FDD (0) Frequency: 1745 MHz Duty Cycle: 1:1

Probe: ES3DV3 – SN3151 ConvF (5.23, 5.23, 5.23);

Right Cheek High 1RB_99/Area Scan (61x61x1): Interpolated grid: $dx=1.500 \text{ mm}$, $dy=1.500 \text{ mm}$

Maximum value of SAR (interpolated) = 1.59 W/kg

Right Cheek High 1RB_99/Zoom Scan (5x5x7)/Cube 0: Measurement grid: $dx=8\text{mm}$, $dy=8\text{mm}$, $dz=5\text{mm}$

Reference Value = 10.92 V/m; Power Drift = 0.12 dB

Peak SAR (extrapolated) = 1.68 W/kg

SAR(1 g) = 0.957 W/kg; SAR(10 g) = 0.493 W/kg

Maximum value of SAR (measured) = 1.23 W/kg

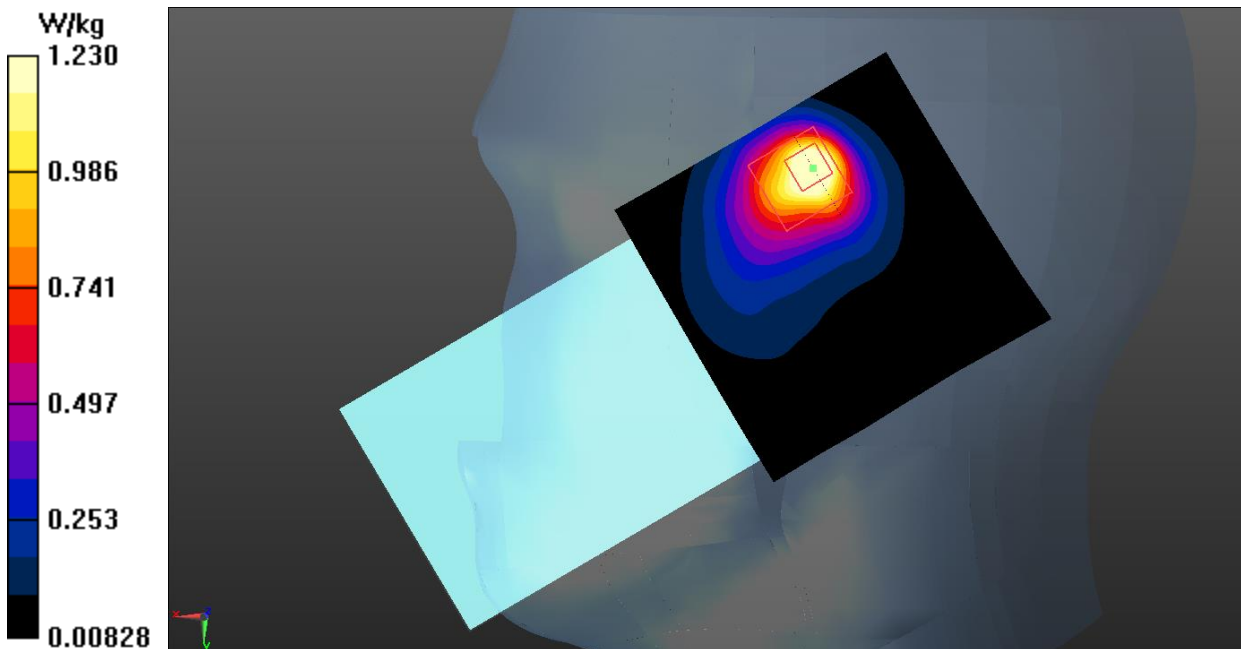

Fig.13 LTE Band 4 Head

LTE Band 4 Body

Date: 2020-3-28

Electronics: DAE4 Sn786

Medium: Head 1750MHz

Medium parameters used: $f = 1745 \text{ MHz}$; $\sigma = 1.348 \text{ S/m}$; $\epsilon_r = 35.588$; $\rho = 1000 \text{ kg/m}^3$

Ambient Temperature: 22.0°C Liquid Temperature: 21.5°C

Communication System: UID 0, LTE_FDD (0) Frequency: 1745 MHz Duty Cycle: 1:1

Probe: ES3DV3 – SN3151 ConvF (5.23, 5.23, 5.23);

Rear Side High 1RB_99/Area Scan (51x61x1): Interpolated grid: $dx=1.500 \text{ mm}$, $dy=1.500 \text{ mm}$

Maximum value of SAR (interpolated) = 1.10 W/kg

Rear Side High 1RB_99/Zoom Scan (5x5x7)/Cube 0: Measurement grid: $dx=8\text{mm}$, $dy=8\text{mm}$, $dz=5\text{mm}$

Reference Value = 14.01 V/m; Power Drift = 0.02 dB

Peak SAR (extrapolated) = 1.34 W/kg

SAR(1 g) = 0.724 W/kg; SAR(10 g) = 0.394 W/kg

Maximum value of SAR (measured) = 0.802 W/kg

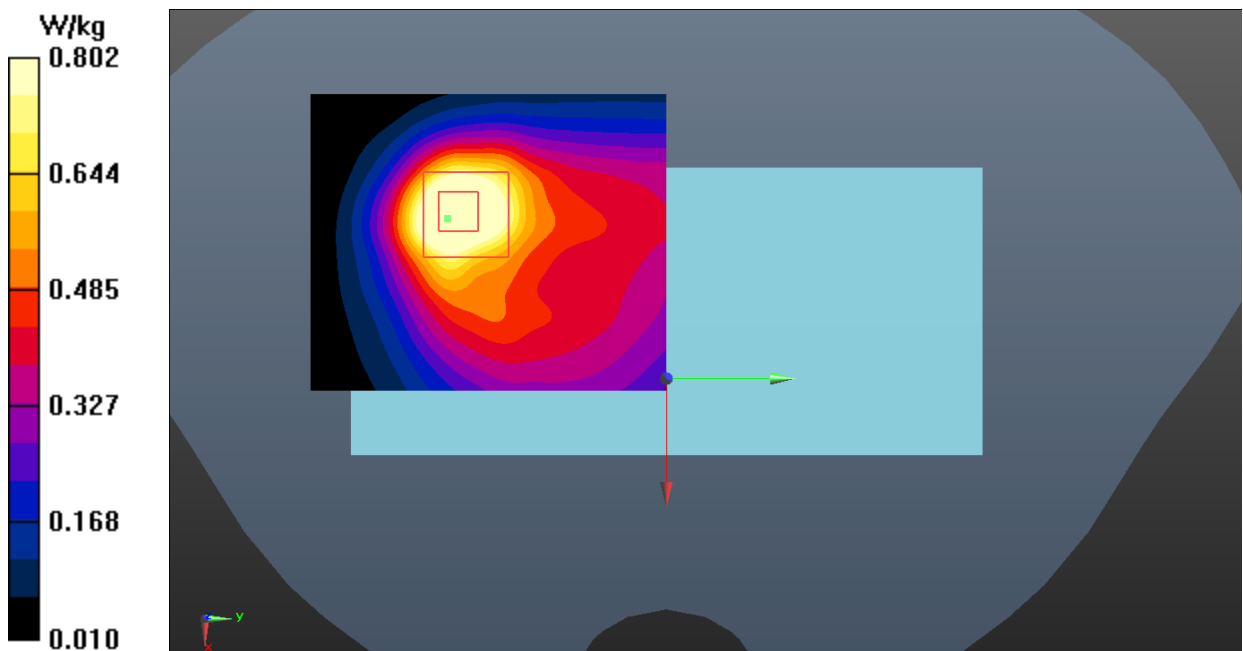

Fig.14 LTE Band 4 Body

LTE Band 7 Head

Date: 2020-3-13

Electronics: DAE4 Sn786

Medium: Head 2550MHz

Medium parameters used: $f = 2560$ MHz; $\sigma = 1.965$ S/m; $\epsilon_r = 38.301$; $\rho = 1000$ kg/m³

Ambient Temperature: 22.0°C Liquid Temperature: 21.5°C

Communication System: UID 0, LTE_FDD (0) Frequency: 2560 MHz Duty Cycle: 1:1

Probe: ES3DV3 – SN3151 ConvF (4.53, 4.53, 4.53);

Right Cheek High 1RB_99/Area Scan (61x101x1): Interpolated grid: dx=1.500 mm, dy=1.500 mm
Maximum value of SAR (interpolated) = 0.348 W/kg

Right Cheek High 1RB_99/Zoom Scan (5x5x7)/Cube 0: Measurement grid: dx=8mm, dy=8mm, dz=5mm

Reference Value = 1.875 V/m; Power Drift = 0.10 dB

Peak SAR (extrapolated) = 0.438 W/kg

SAR(1 g) = 0.256 W/kg; SAR(10 g) = 0.144 W/kg

Maximum value of SAR (measured) = 0.344 W/kg

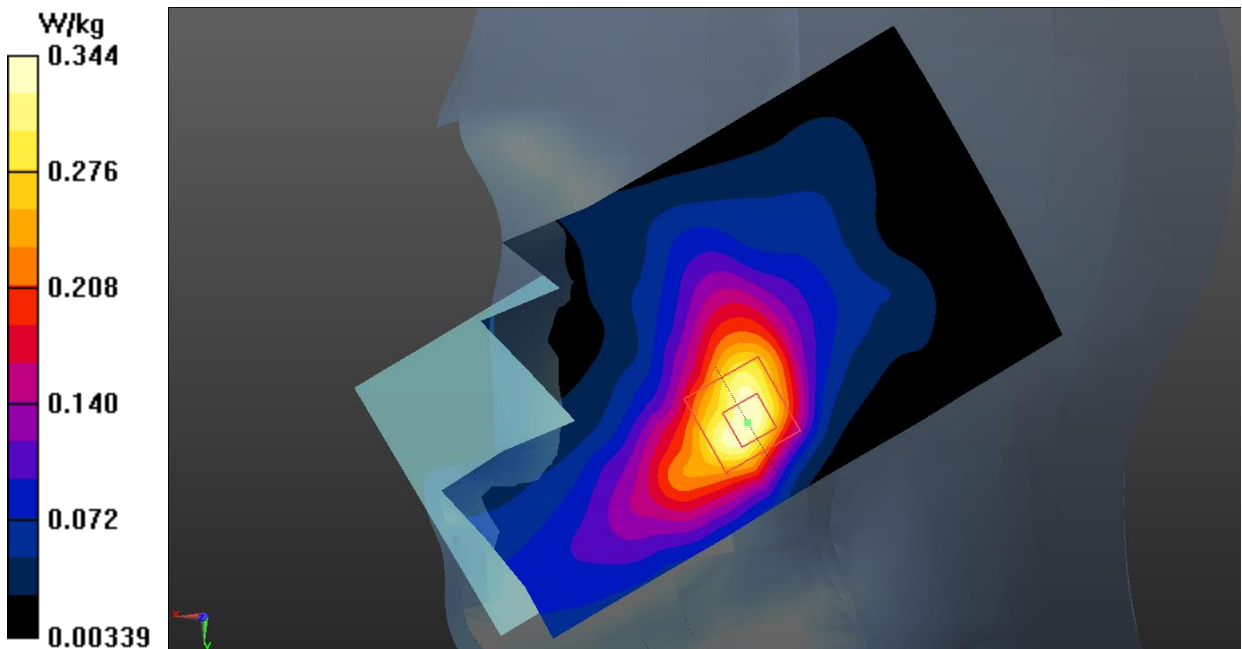

Fig.15 LTE Band 7 Head

LTE Band 7 Body

Date: 2020-3-13

Electronics: DAE4 Sn786

Medium: Head 2550MHz

Medium parameters used: $f = 2560$ MHz; $\sigma = 1.965$ S/m; $\epsilon_r = 38.301$; $\rho = 1000$ kg/m³

Ambient Temperature: 22.0°C Liquid Temperature: 21.5°C

Communication System: UID 0, LTE_FDD (0) Frequency: 2560 MHz Duty Cycle: 1:1

Probe: ES3DV3 – SN3151 ConvF (4.53, 4.53, 4.53);

Rear Side High 1RB_99/Area Scan (61x61x1): Interpolated grid: dx=1.500 mm, dy=1.500 mm

Maximum value of SAR (interpolated) = 0.716 W/kg

Rear Side High 1RB_99/Zoom Scan (5x5x7)/Cube 0: Measurement grid: dx=8mm, dy=8mm, dz=5mm

Reference Value = 6.112 V/m; Power Drift = 0.14 dB

Peak SAR (extrapolated) = 0.987 W/kg

SAR(1 g) = 0.498 W/kg; SAR(10 g) = 0.255 W/kg

Maximum value of SAR (measured) = 0.535 W/kg

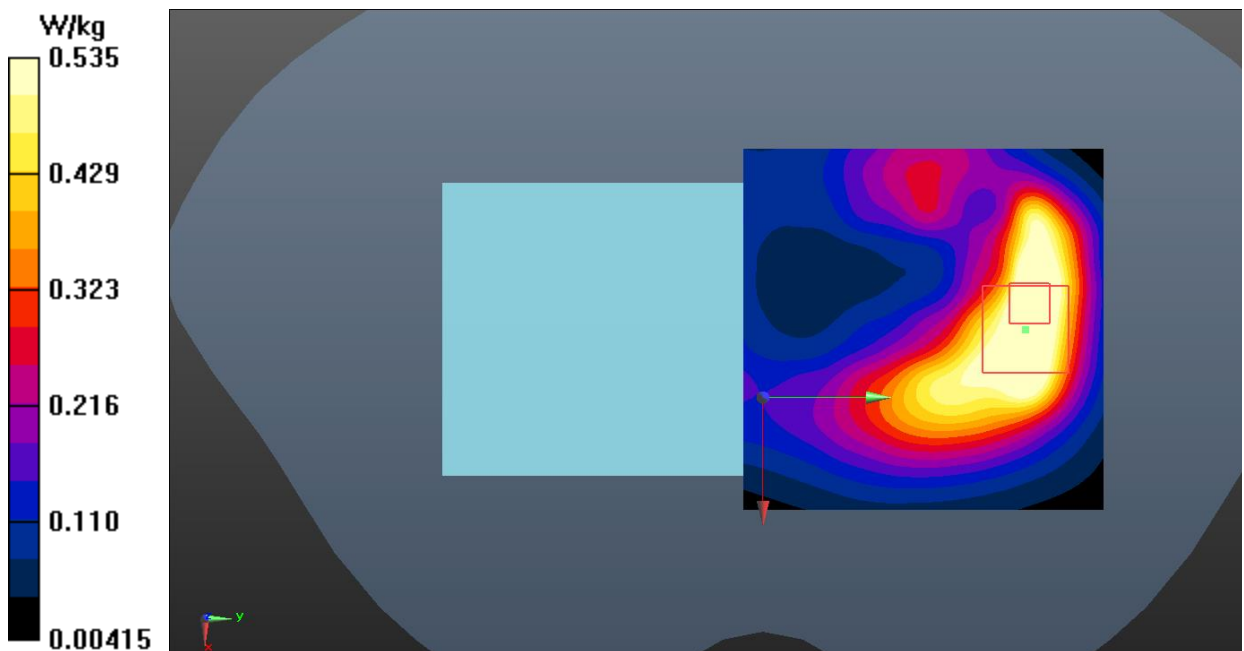
**Fig.16 LTE Band 7 Body**

WLAN 2.4G Head

Date: 2020-3-30

Electronics: DAE4 Sn786

Medium: Head 2450MHz

Medium parameters used: $f = 2462$ MHz; $\sigma = 1.846$ S/m; $\epsilon_r = 38.683$; $\rho = 1000$ kg/m³

Ambient Temperature: 22.0°C Liquid Temperature: 21.5°C

Communication System: UID 0, WiFi (0) Frequency: 2462 MHz Duty Cycle: 1:1

Probe: ES3DV3 – SN3151 ConvF (4.68, 4.68, 4.68);

Left Cheek High /Area Scan (61x61x1): Interpolated grid: dx=1.500 mm, dy=1.500 mm

Maximum value of SAR (interpolated) = 0.316 W/kg

Left Cheek High/Zoom Scan (5x5x7)/Cube 0: Measurement grid: dx=8mm, dy=8mm, dz=5mm

Reference Value = 5.432 V/m; Power Drift = -0.12 dB

Peak SAR (extrapolated) = 0.441 W/kg

SAR(1 g) = 0.223 W/kg; SAR(10 g) = 0.115 W/kg

Maximum value of SAR (measured) = 0.319 W/kg

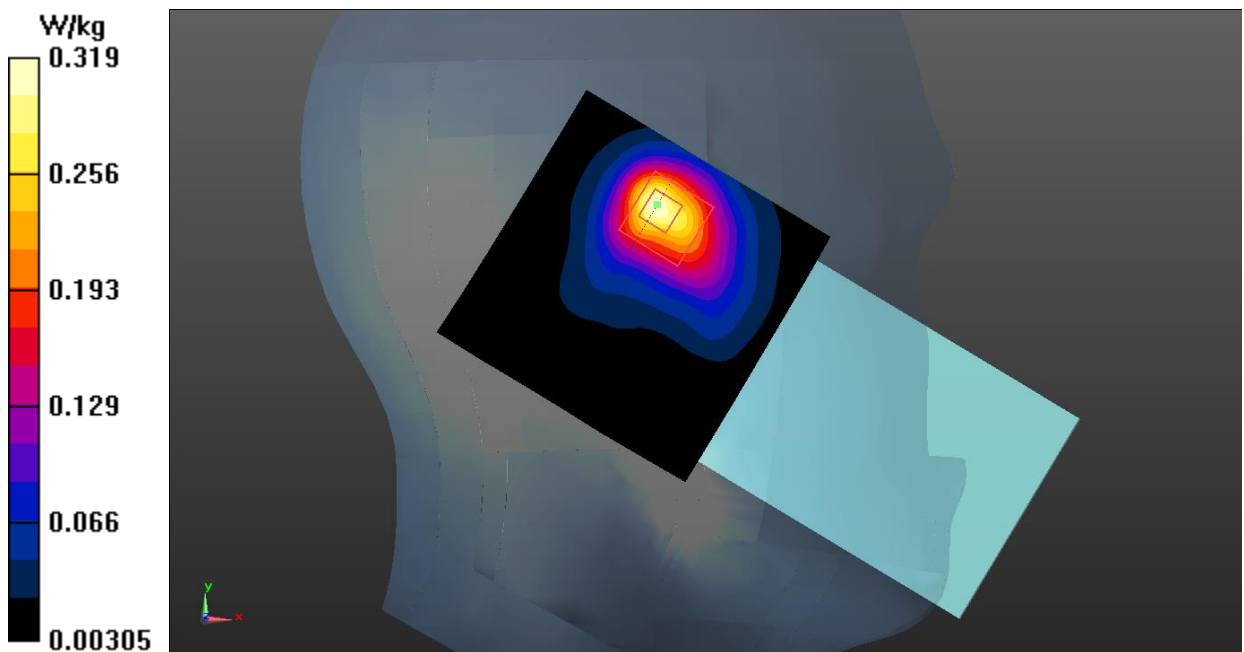

Fig.17 WLAN 2.4G Head

WLAN 2.4G Body

Date: 2020-3-30

Electronics: DAE4 Sn786

Medium: Head 2450MHz

Medium parameters used: $f = 2462 \text{ MHz}$; $\sigma = 1.846 \text{ S/m}$; $\epsilon_r = 38.683$; $\rho = 1000 \text{ kg/m}^3$

Ambient Temperature: 22.0°C Liquid Temperature: 21.5°C

Communication System: UID 0, WiFi (0) Frequency: 2462 MHz Duty Cycle: 1:1

Probe: ES3DV3 – SN3151 ConvF (4.68, 4.68, 4.68);

Rear Side High /Area Scan (61x61x1): Interpolated grid: $dx=1.500 \text{ mm}$, $dy=1.500 \text{ mm}$

Maximum value of SAR (interpolated) = 0.163 W/kg

Rear Side High /Zoom Scan (5x5x7)/Cube 0: Measurement grid: $dx=8\text{mm}$, $dy=8\text{mm}$, $dz=5\text{mm}$

Reference Value = 5.183 V/m ; Power Drift = -0.07 dB

Peak SAR (extrapolated) = 0.223 W/kg

SAR(1 g) = 0.108 W/kg ; SAR(10 g) = 0.050 W/kg

Maximum value of SAR (measured) = 0.105 W/kg

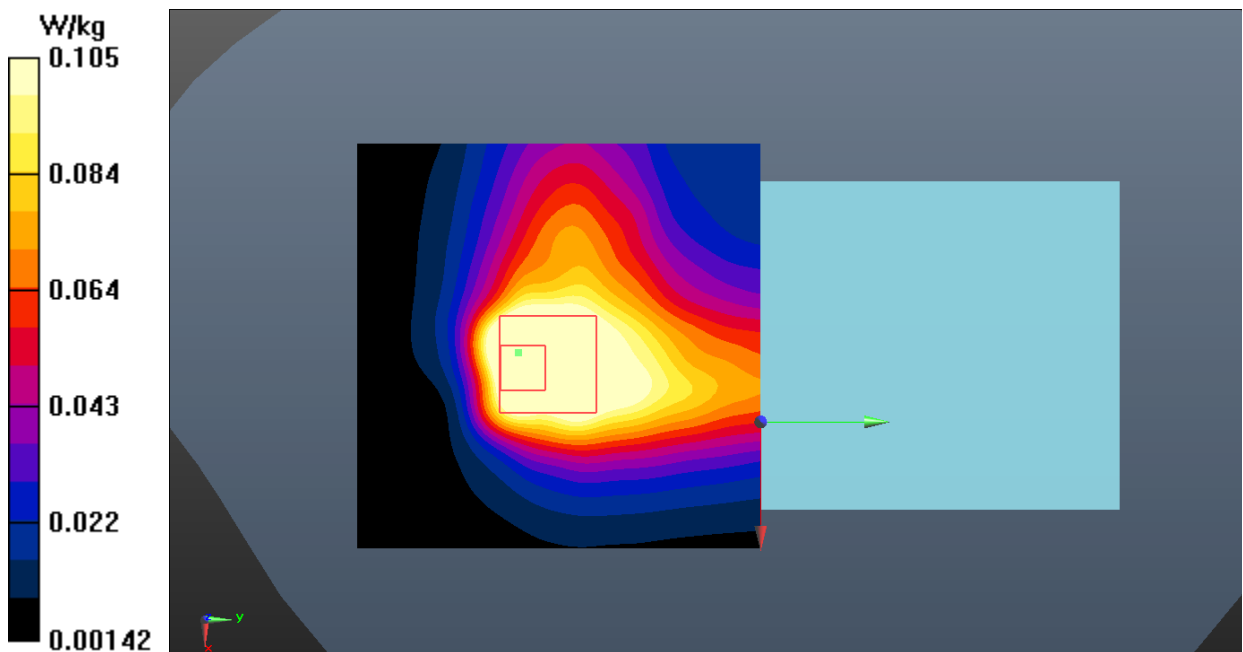

Fig.18 WLAN 2.4G Body

ANNEX B: System Verification Results

835MHz

Date: 2020-3-12

Electronics: DAE4 Sn786

Medium: Head 835MHz

Medium parameters used: $f = 835 \text{ MHz}$; $\sigma = 0.884 \text{ S/m}$; $\epsilon_r = 41.962$; $\rho = 1000 \text{ kg/m}^3$

Ambient Temperature: 22.5°C Liquid Temperature: 22.0°C

Communication System: CW Frequency: 835 MHz Duty Cycle: 1:1

Probe: ES3DV3 – SN3151 ConvF (6.41, 6.41, 6.41);

System Validation /Area Scan (81x161x1): Interpolated grid: $dx=1.000 \text{ mm}$, $dy=1.000 \text{ mm}$

Reference Value = 61.236 V/m ; Power Drift = -0.09 dB

SAR(1 g) = 2.36 W/kg; SAR(10 g) = 1.55 W/kg

Maximum value of SAR (interpolated) = 2.65 W/kg

System Validation /Zoom Scan (7x7x7)/Cube 0: Measurement grid: $dx=5\text{mm}$, $dy=5\text{mm}$, $dz=5\text{mm}$

Reference Value = 61.236 V/m ; Power Drift = -0.09 dB

Peak SAR (extrapolated) = 3.38 W/kg

SAR(1 g) = 2.31 W/kg; SAR(10 g) = 1.53 W/kg

Maximum value of SAR (measured) = 2.61 W/kg

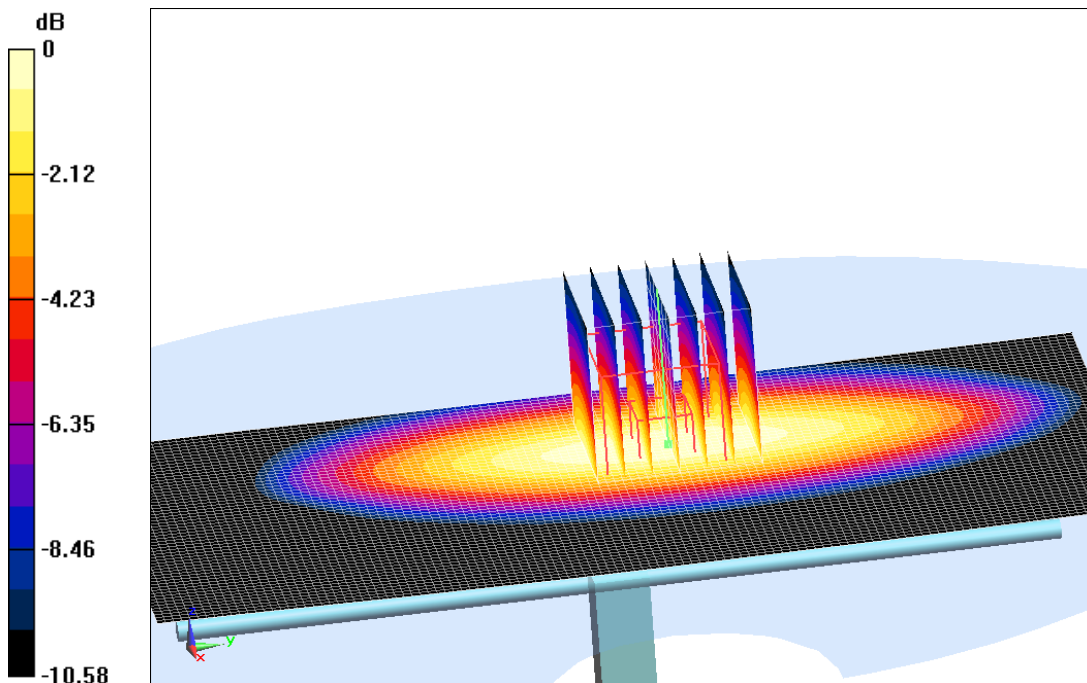

0 dB = 2.61 W/kg = 4.17 dB W/kg

Fig.B.1. Validation 835MHz 250mW

1750MHz

Date: 2020-3-28

Electronics: DAE4 Sn786

Medium: Head 1750MHz

Medium parameters used: $f = 1750 \text{ MHz}$; $\sigma = 1.352 \text{ S/m}$; $\epsilon_r = 39.568$; $\rho = 1000 \text{ kg/m}^3$

Ambient Temperature: 22.5°C Liquid Temperature: 22.0°C

Communication System: CW Frequency: 1750 MHz Duty Cycle: 1:1

Probe: ES3DV3 – SN3151 ConvF (5.23, 5.23, 5.23);

System Validation/Area Scan (61x121x1): Interpolated grid: $dx=1.000 \text{ mm}$, $dy=1.000 \text{ mm}$

Reference Value = 77.845 V/m ; Power Drift = -0.06 dB

SAR(1 g) = 9.05 W/kg ; SAR(10 g) = 4.79 W/kg

Maximum value of SAR (interpolated) = 11.0 W/kg

System Validation/Zoom Scan (7x7x7)/Cube 0: Measurement grid: $dx=5\text{mm}$, $dy=5\text{mm}$, $dz=5\text{mm}$

Reference Value = 77.845 V/m ; Power Drift = -0.06 dB

Peak SAR (extrapolated) = 16.9 W/kg

SAR(1 g) = 8.88 W/kg ; SAR(10 g) = 4.74 W/kg

Maximum value of SAR (measured) = 10.7 W/kg

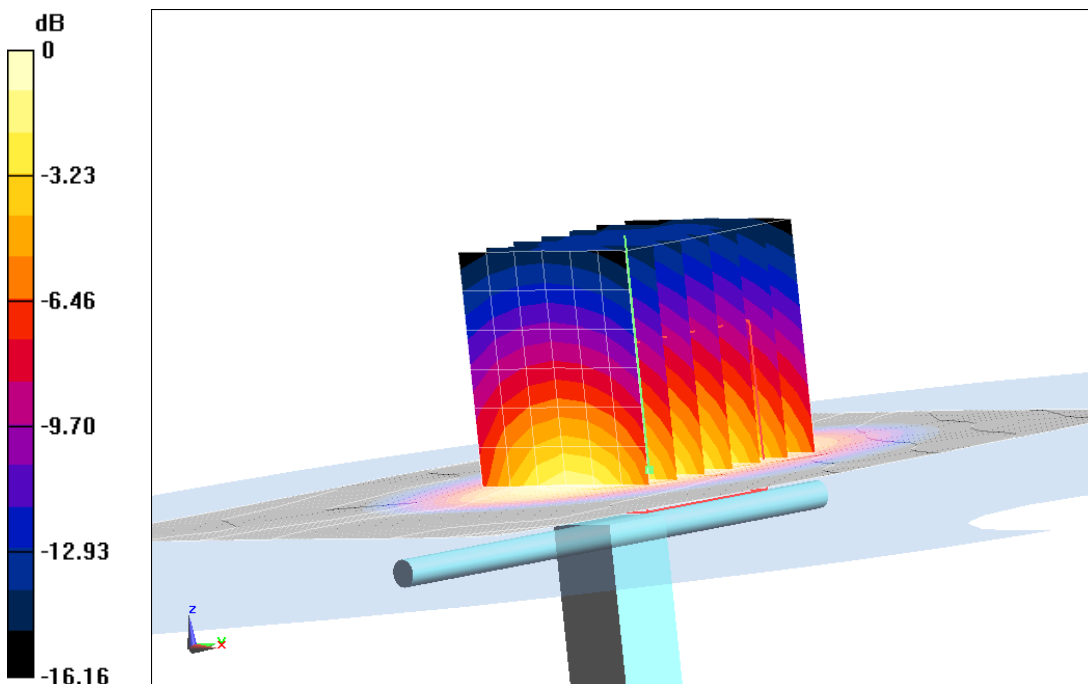

0 dB = 10.7 W/kg = 10.29 dB W/kg

Fig.B.2. Validation 1750MHz 250mW

1900MHz

Date: 2020-4-1

Electronics: DAE4 Sn786

Medium: Head 1900MHz

Medium parameters used: $f = 1900 \text{ MHz}$; $\sigma = 1.419 \text{ S/m}$; $\epsilon_r = 39.146$; $\rho = 1000 \text{ kg/m}^3$

Ambient Temperature: 22.5°C Liquid Temperature: 22.0°C

Communication System: CW Frequency: 1900 MHz Duty Cycle: 1:1

Probe: ES3DV3 – SN3151 ConvF (5.11, 5.11, 5.11);

System Validation /Area Scan (81x121x1): Interpolated grid: $dx=1.000 \text{ mm}$, $dy=1.000 \text{ mm}$

Reference Value = 90.728 V/m ; Power Drift = 0.02 dB

SAR(1 g) = 10.3 W/kg ; SAR(10 g) = 5.21 W/kg

Maximum value of SAR (interpolated) = 13.2 W/kg

System Validation /Zoom Scan (7x7x7)/Cube 0: Measurement grid: $dx=5\text{mm}$, $dy=5\text{mm}$, $dz=5\text{mm}$

Reference Value = 90.728 V/m ; Power Drift = 0.02 dB

Peak SAR (extrapolated) = 22.7 W/kg

SAR(1 g) = 10.5 W/kg ; SAR(10 g) = 5.37 W/kg

Maximum value of SAR (measured) = 13.6 W/kg

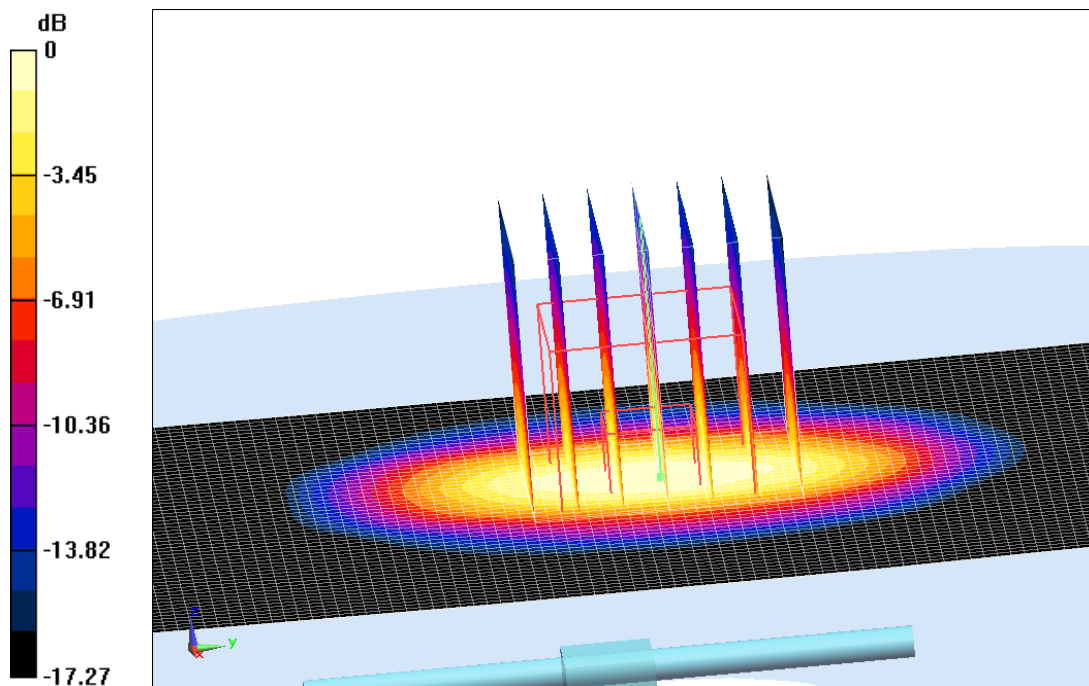

0 dB = 13.6 W/kg = 11.34 dB W/kg

Fig.B.3. Validation 1900MHz 250mW

2450MHz

Date: 2020-3-30

Electronics: DAE4 Sn786

Medium: Head 2450MHz

Medium parameters used: $f = 2450 \text{ MHz}$; $\sigma = 1.832 \text{ S/m}$; $\epsilon_r = 38.723$; $\rho = 1000 \text{ kg/m}^3$

Ambient Temperature: 22.5°C Liquid Temperature: 22.0°C

Communication System: CW Frequency: 2450 MHz Duty Cycle: 1:1

Probe: ES3DV3 – SN3151 ConvF (4.68, 4.68, 4.68);

System Validation /Area Scan (61x81x1): Interpolated grid: $dx=1.000 \text{ mm}$, $dy=1.000 \text{ mm}$

Reference Value = 93.536 V/m ; Power Drift = 0.10 dB

SAR(1 g) = 13.2 W/kg ; SAR(10 g) = 5.98 W/kg

Maximum value of SAR (interpolated) = 15.4 W/kg

System Validation /Zoom Scan (7x7x7)/Cube 0: Measurement grid: $dx=5\text{mm}$, $dy=5\text{mm}$, $dz=5\text{mm}$

Reference Value = 93.536 V/m ; Power Drift = 0.10 dB

Peak SAR (extrapolated) = 27.1 W/kg

SAR(1 g) = 13.4 W/kg ; SAR(10 g) = 6.12 W/kg

Maximum value of SAR (measured) = 15.8 W/kg

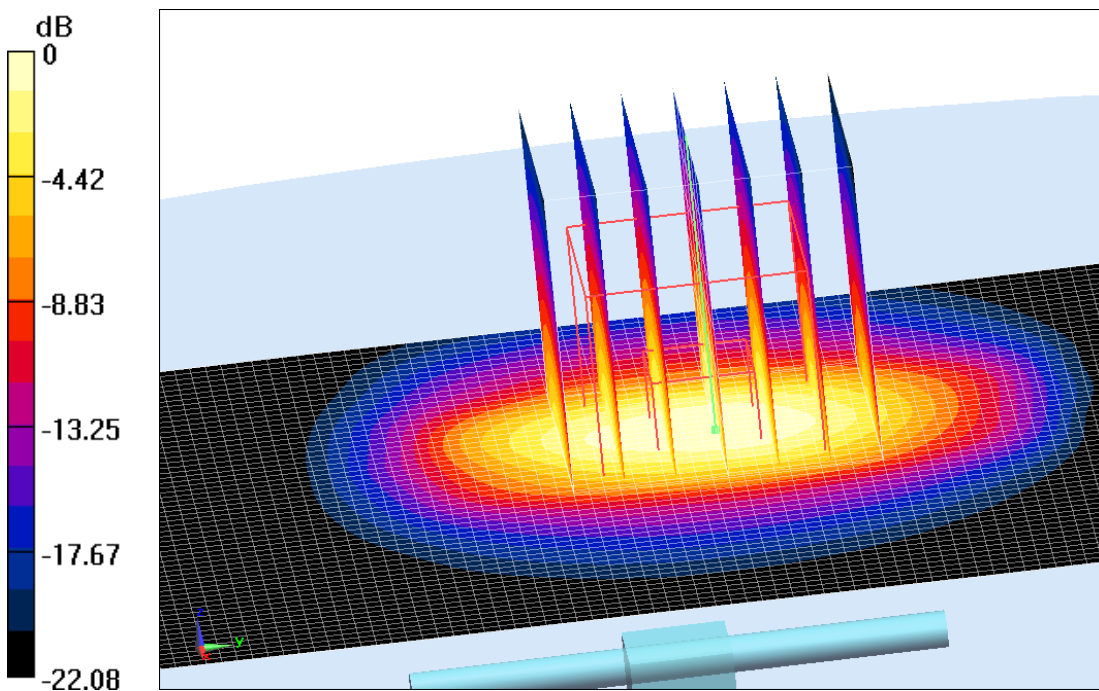

0 dB = 15.8 W/kg = 11.99 dB W/kg

Fig.B.4. Validation 2450MHz 250mW

2550 MHz

Date: 2020-3-13

Electronics: DAE4 Sn786

Medium: Head 2550MHz

Medium parameters used: $f = 2550 \text{ MHz}$; $\sigma = 1.953 \text{ S/m}$; $\epsilon_r = 38.344$; $\rho = 1000 \text{ kg/m}^3$

Ambient Temperature: 22.5°C Liquid Temperature: 22.0°C

Communication System: CW_TMC Frequency: 2550 MHz Duty Cycle: 1:1

Probe: ES3DV3 – SN3151 ConvF (4.53, 4.53, 4.53);

System Validation/Area Scan (61x121x1): Interpolated grid: $dx=1.000 \text{ mm}$, $dy=1.000 \text{ mm}$

Reference Value = 93.424 V/m ; Power Drift = 0.05 dB

SAR(1 g) = 14.9 W/kg ; SAR(10 g) = 6.71 W/kg

Maximum value of SAR (interpolated) = 16.5 W/kg

System Validation/Zoom Scan (7x7x7)/Cube0: Measurement grid: $dx=5\text{mm}$, $dy=5\text{mm}$, $dz=5\text{mm}$

Reference Value = 93.424 V/m ; Power Drift = 0.05 dB

Peak SAR (extrapolated) = 31.9 W/kg

SAR(1 g) = 15.1 W/kg ; SAR(10 g) = 6.83 W/kg

Maximum value of SAR (measured) = 16.7 W/kg

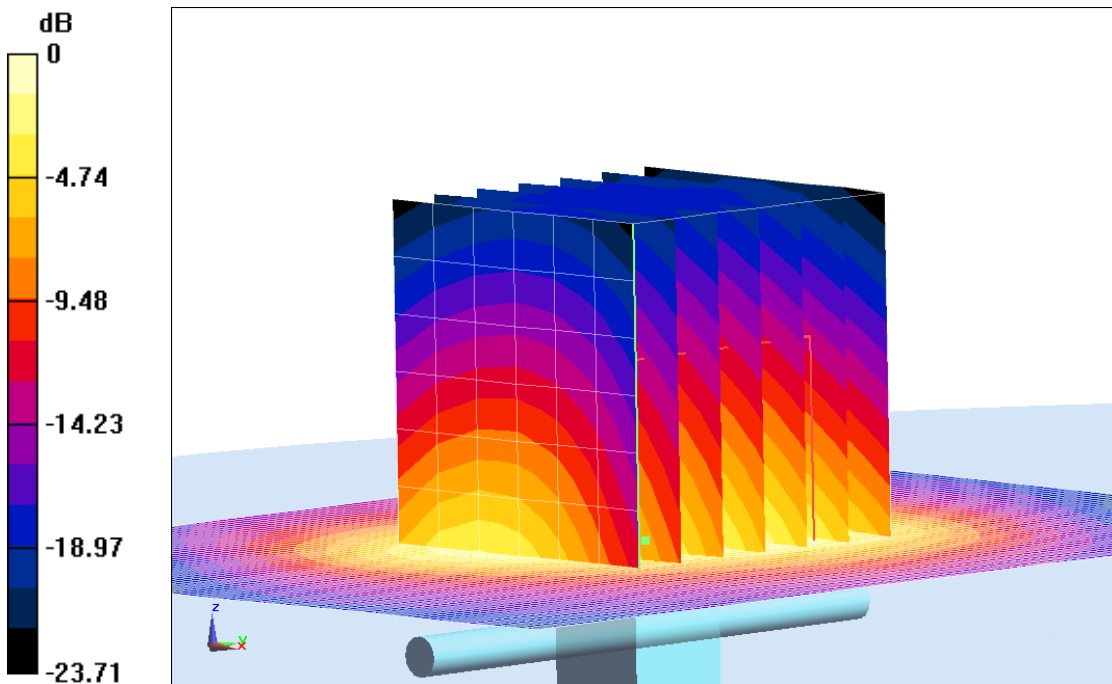

0 dB = 16.7 W/kg = 12.23 dB W/kg

Fig.B.5. validation 2550MHz 250mW

ANNEX C: SAR Measurement Setup

C.1. Measurement Set-up

DASY5 system for performing compliance tests is illustrated above graphically. This system consists of the following items:

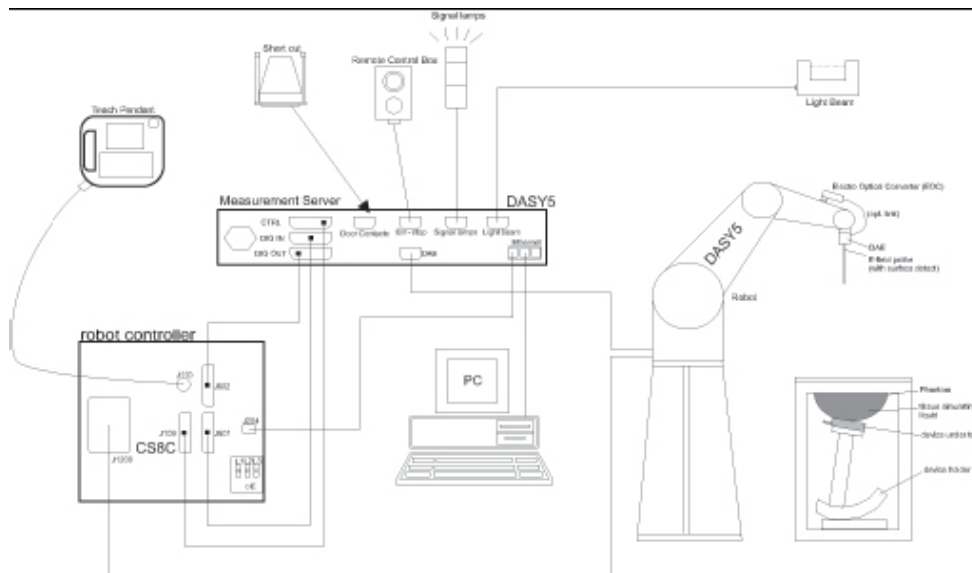

Picture C.1 SAR Lab Test Measurement Set-up

- A standard high precision 6-axis robot (Stäubli TX=RX family) with controller, teach pendant and software. An arm extension for accommodating the data acquisition electronics (DAE).
- An isotropic field probe optimized and calibrated for the targeted measurement.
- A data acquisition electronics (DAE) which performs the signal amplification, signal multiplexing, AD-conversion, offset measurements, mechanical surface detection, collision detection, etc. The unit is battery powered with standard or rechargeable batteries. The signal is optically transmitted to the EOC.
- The Electro-optical converter (EOC) performs the conversion from optical to electrical signals for the digital communication to the DAE. To use optical surface detection, a special version of the EOC is required. The EOC signal is transmitted to the measurement server.
- The function of the measurement server is to perform the time critical tasks such as signal filtering, control of the robot operation and fast movement interrupts.
- The Light Beam used is for probe alignment. This improves the (absolute) accuracy of the probe positioning.
- A computer running WinXP and the DASY5 software.
- Remote control and teach pendant as well as additional circuitry for robot safety such as
- warning lamps, etc.
- The phantom, the device holder and other accessories according to the targeted measurement.

C.2. DASY5 E-field Probe System

The SAR measurements were conducted with the dosimetric probe designed in the classical triangular configuration and optimized for dosimetric evaluation. The probe is constructed using the thick film technique; with printed resistive lines on ceramic substrates. The probe is equipped with an optical multifiber line ending at the front of the probe tip. It is connected to the EOC box on the robot arm and provides an automatic detection of the phantom surface. Half of the fibers are connected to a pulsed infrared transmitter, the other half to a synchronized receiver. As the probe approaches the surface, the reflection from the surface produces a coupling from the transmitting to the receiving fibers. This reflection increases first during the approach, reaches maximum and then decreases. If the probe is flatly touching the surface, the coupling is zero. The distance of the coupling maximum to the surface is independent of the surface reflectivity and largely independent of the surface to probe angle. The DASY5 software reads the reflection during a software approach and looks for the maximum using 2nd order curve fitting. The approach is stopped at reaching the maximum.

Probe Specifications:

Model:	ES3DV3, EX3DV4
Frequency	10MHz — 6.0GHz(EX3DV4)
Range:	10MHz — 4GHz(ES3DV3)
Calibration:	In head and body simulating tissue at Frequencies from 835 up to 5800MHz
Linearity:	± 0.2 dB(30 MHz to 6 GHz) for EX3DV4 ± 0.2 dB(30 MHz to 4 GHz) for ES3DV3
Dynamic Range:	10 mW/kg — 100W/kg
Probe Length:	330 mm
Probe Tip	
Length:	20 mm
Body Diameter:	12 mm
Tip Diameter:	2.5 mm (3.9 mm for ES3DV3)
Tip-Center:	1 mm (2.0mm for ES3DV3)
Application:	SAR Dosimetry Testing Compliance tests of mobile phones Dosimetry in strong gradient fields



Picture C.2 Near-field Probe



Picture C.3 E-field Probe

C.3. E-field Probe Calibration

Each E-Probe/Probe Amplifier combination has unique calibration parameters. A TEM cell calibration procedure is conducted to determine the proper amplifier settings to enter in the probe parameters. The amplifier settings are determined for a given frequency by subjecting the probe to a known E-field density (1 mW/cm^2) using an RF Signal generator, TEM cell, and RF Power Meter.

The free space E-field from amplified probe outputs is determined in a test chamber. This calibration can be performed in a TEM cell if the frequency is below 1 GHz and in a waveguide or

other methodologies above 1 GHz for free space. For the free space calibration, the probe is placed in the volumetric center of the cavity and at the proper orientation with the field. The probe is then rotated 360 degrees until the three channels show the maximum reading. The power density readings equates to 1 mW/ cm²:

E-field temperature correlation calibration is performed in a flat phantom filled with the appropriate simulated brain tissue. The E-field in the medium correlates with the temperature rise in the dielectric medium. For temperature correlation calibration a RF transparent thermistor-based temperature probe is used in conjunction with the E-field probe.

$$SAR = C \frac{\Delta T}{\Delta t}$$

Where:

Δt = Exposure time (30 seconds),

C = Heat capacity of tissue (brain or muscle),

ΔT = Temperature increase due to RF exposure.

$$SAR = \frac{|E|^2 \cdot \sigma}{\rho}$$

Where:

σ = Simulated tissue conductivity,

ρ = Tissue density (kg/m³).

C.4. Other Test Equipment

C.4.1. Data Acquisition Electronics (DAE)

The data acquisition electronics consist of a highly sensitive electrometer-grade preamplifier with auto-zeroing, a channel and gain-switching multiplexer, a fast 16 bit AD-converter and a command decoder with a control logic unit. Transmission to the measurement server is accomplished through an optical downlink for data and status information, as well as an optical uplink for commands and the clock.

The mechanical probe mounting device includes two different sensor systems for frontal and sideways probe contacts. They are used for mechanical surface detection and probe collision detection.

The input impedance of the DAE is 200 MOhm; the inputs are symmetrical and floating. Common mode rejection is above 80 dB.



PictureC.4: DAE

C.4.2. Robot

The SPEAG DASY system uses the high precision robots (DASY5: RX160L) type from Stäubli SA (France). For the 6-axis controller system, the robot controller version from Stäubli is used. The Stäubli robot series have many features that are important for our application:

- High precision (repeatability 0.02mm)
- High reliability (industrial design)
- Low maintenance costs (virtually maintenance free due to direct drive gears; no belt drives)
- Jerk-free straight movements (brushless synchron motors; no stepper motors)
- Low ELF interference (motor control fields shielded via the closed metallic construction shields)



Picture C.5 DASY 5

C.4.3. Measurement Server

The Measurement server is based on a PC/104 CPU board with CPU (DASY5: 400 MHz, Intel Celeron), chipdisk (DASY5:128MB), RAM (DASY5:128MB). The necessary circuits for communication with the DAE electronic box, as well as the 16 bit AD converter system for optical detection and digital I/O interface are contained on the DASY I/O board, which is directly connected to the PC/104 bus of the CPU board.

The measurement server performs all real-time data evaluation of field measurements and surface detection, controls robot movements and handles safety operation. The PC operating system cannot interfere with these time critical processes. All connections are supervised by a watchdog, and disconnection of any of the cables to the measurement server will automatically disarm the robot and disable all program-controlled robot movements. Furthermore, the measurement server is equipped with an expansion port which is reserved for future applications. Please note that this expansion port does not have a standardized pinout, and therefore only devices provided by SPEAG can be connected. Devices from any other supplier could seriously damage the measurement server.



Picture C.6 Server for DASY 5

C.4.4. Device Holder for Phantom

The SAR in the phantom is approximately inversely proportional to the square of the distance between the source and the liquid surface. For a source at 5mm distance, a positioning uncertainty of $\pm 0.5\text{mm}$ would produce a SAR uncertainty of $\pm 20\%$. Accurate device positioning is therefore crucial for accurate and repeatable measurements. The positions in which the devices must be measured are defined by the standards.

The DASY device holder is designed to cope with the different positions given in the standard. It has two scales for device rotation (with respect to the body axis) and device inclination (with respect to the line between the ear reference points). The rotation centers for both scales is the ear reference point (ERP). Thus the device needs no repositioning when changing the angles.

The DASY device holder is constructed of low-loss POM material having the following dielectric

parameters: relative permittivity $\epsilon = 3$ and loss tangent $\delta = 0.02$. The amount of dielectric material has been reduced in the closest vicinity of the device, since measurements have suggested that the influence of the clamp on the test results could thus be lowered.

<Laptop Extension Kit>

The extension is lightweight and made of POM, acrylic glass and foam. It fits easily on the upper part of the Mounting Device in place of the phone positioner. The extension is fully compatible with the Twin-SAM and ELI phantoms.



Picture C.7-1: Device Holder

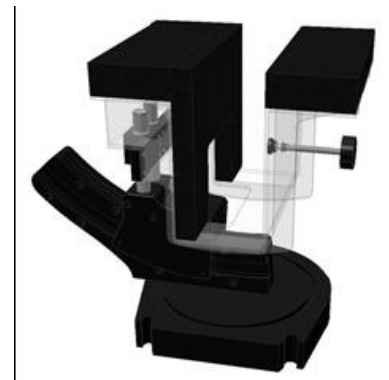

Picture C.7-2: Laptop Extension Kit

C.4.5. Phantom

The SAM Twin Phantom V4.0 is constructed of a fiberglass shell integrated in a table. The shape of the shell is based on data from an anatomical study designed to

Represent the 90th percentile of the population. The phantom enables the dissymmetric evaluation of SAR for both left and right handed handset usage, as well as body-worn usage using the flat phantom region. Reference markings on the Phantom allow the complete setup of all predefined phantom positions and measurement grids by manually teaching three points in the robot. The shell phantom has a 2mm shell thickness (except the ear region where shell thickness increases to 6 mm).



Shell Thickness: 2 ± 0.2 mm
Filling Volume: Approx. 25 liters
Dimensions: 810 x 1000 x 500 mm (H x L x W)
Available: Special



Picture C.8: SAM Twin Phantom

ANNEX D: Position of the wireless device in relation to the phantom

D.1. General considerations

This standard specifies two handset test positions against the head phantom – the “cheek” position and the “tilt” position.

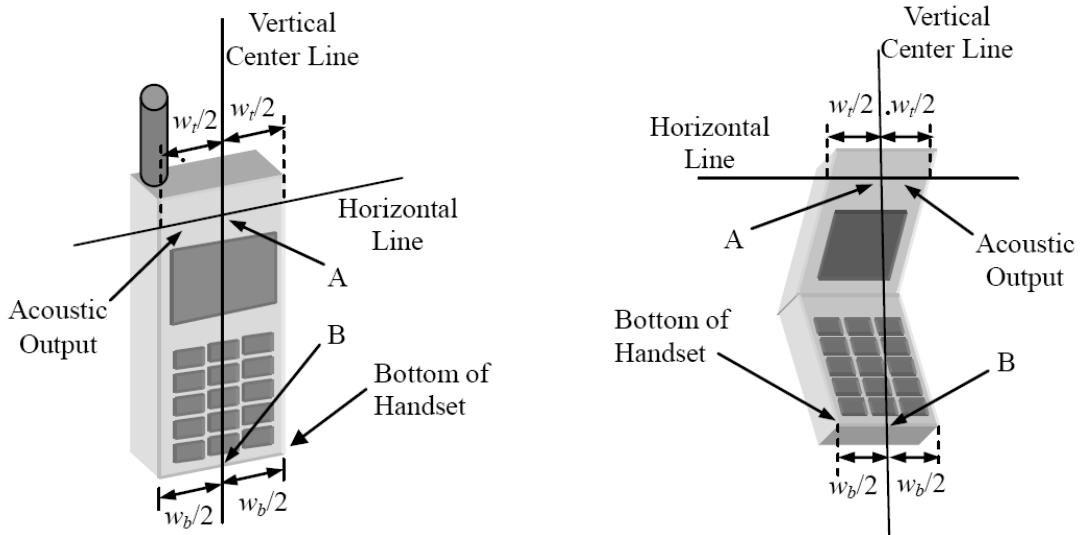

- w_t Width of the handset at the level of the acoustic
- w_b Width of the bottom of the handset
- A Midpoint of the width w_t of the handset at the level of the acoustic output
- B Midpoint of the width w_b of the bottom of the handset

Picture D.1-a Typical “fixed” case handset Picture D.1-b Typical “clam-shell” case handset

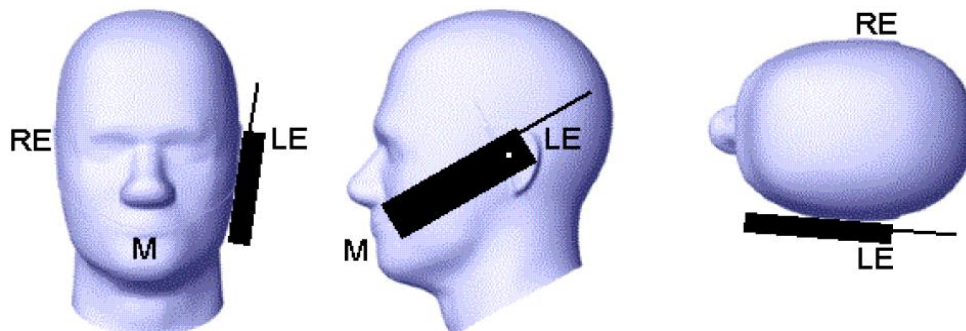

Picture D.2 Cheek position of the wireless device on the left side of SAM

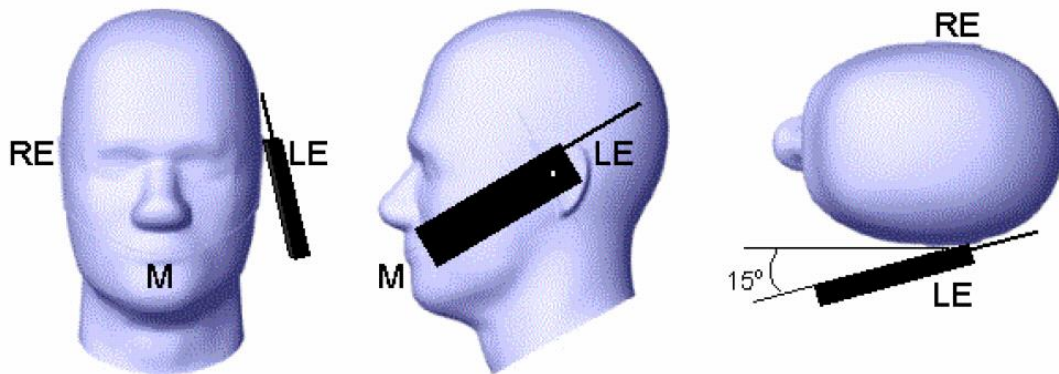

Picture D.3 Tilt position of the wireless device on the left side of SAM

D.2. Body-worn device

A typical example of a body-worn device is a mobile phone, wireless enabled PDA or other battery operated wireless device with the ability to transmit while mounted on a person's body using a carry accessory approved by the wireless device manufacturer.

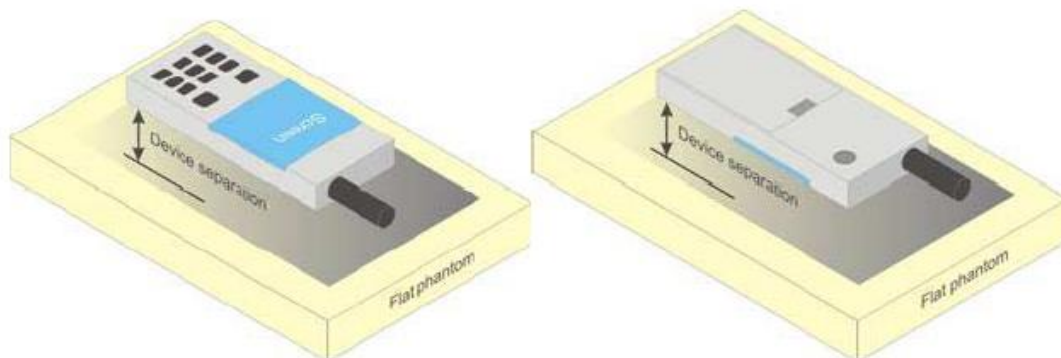

Picture D.4 Test positions for body-worn devices

D.3. Desktop device

A typical example of a desktop device is a wireless enabled desktop computer placed on a table or desk when used.

The DUT shall be positioned at the distance and in the orientation to the phantom that corresponds to the intended use as specified by the manufacturer in the user instructions. For devices that employ an external antenna with variable positions, tests shall be performed for all antenna positions specified. Picture 8.5 show positions for desktop device SAR tests. If the intended use is not specified, the device shall be tested directly against the flat phantom.

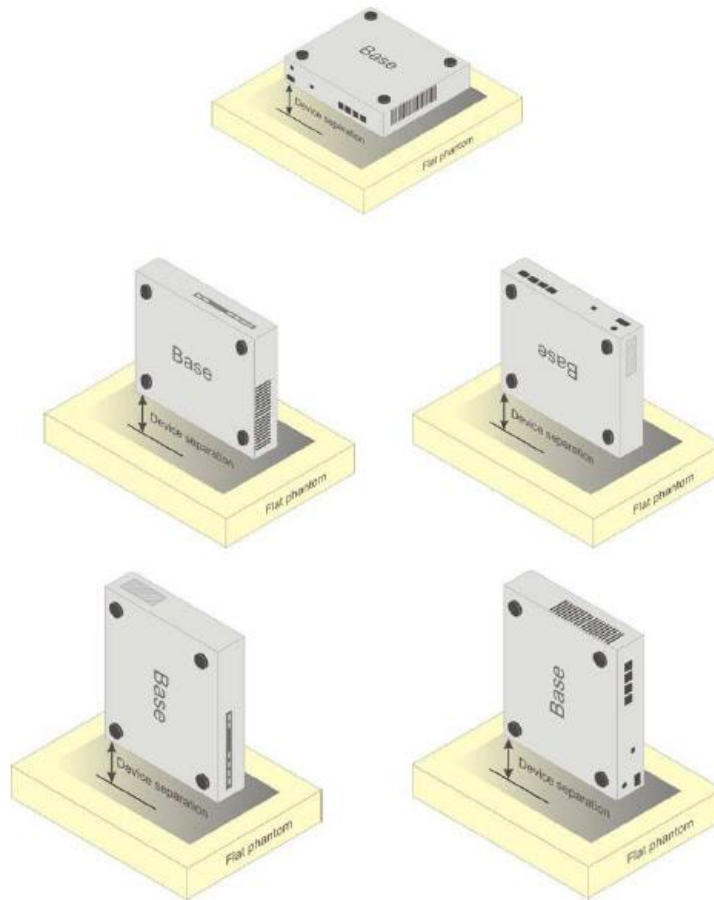

Picture D.5 Test positions for desktop devices

D.4. DUT Setup Photos



Picture D.6

ANNEX E: Equivalent Media Recipes

The liquid used for the frequency range of 700-6000 MHz consisted of water, sugar, salt, preventol, glycol monobutyl and Cellulose. The liquid has been previously proven to be suited for worst-case. The Table E.1 shows the detail solution. It's satisfying the latest tissue dielectric parameters requirements proposed by the IEEE 1528 and IEC 62209.

Table E.1: Composition of the Tissue Equivalent Matter

Frequency (MHz)	835 Head	835 Body	1900 Head	1900 Body	2450 Head	2450 Body	5800 Head	5800 Body
Ingredients (% by weight)								
Water	41.45	52.5	55.242	69.91	58.79	72.60	65.53	65.53
Sugar	56.0	45.0	\	\	\	\	\	\
Salt	1.45	1.4	0.306	0.13	0.06	0.18	\	\
Preventol	0.1	0.1	\	\	\	\	\	\
Cellulose	1.0	1.0	\	\	\	\	\	\
Glycol Monobutyl	\	\	44.452	29.96	41.15	27.22	\	\
Diethylenglycol monoheylether	\	\	\	\	\	\	17.24	17.24
Triton X-100	\	\	\	\	\	\	17.24	17.24
Dielectric Parameters Target Value	$\epsilon=41.5$ $\sigma=0.90$	$\epsilon=55.2$ $\sigma=0.97$	$\epsilon=40.0$ $\sigma=1.40$	$\epsilon=53.3$ $\sigma=1.52$	$\epsilon=39.2$ $\sigma=1.80$	$\epsilon=52.7$ $\sigma=1.95$	$\epsilon=35.3$ $\sigma=5.27$	$\epsilon=48.2$ $\sigma=6.00$

Note: There is a little adjustment respectively for 750, 1800, 2600, 5200, 5300, and 5600, based on the recipe of closest frequency in table E.1

ANNEX F: System Validation

The SAR system must be validated against its performance specifications before it is deployed. When SAR probes, system components or software are changed, upgraded or recalibrated, these must be validated with the SAR system(s) that operates with such components.

Table F.1: System Validation

Probe SN.	Liquid name	Validation date	Frequency point	Status (OK or Not)
3151	Head 750MHz	2020-01-06	750 MHz	OK
3151	Head 835MHz	2020-01-06	835 MHz	OK
3151	Head 1750MHz	2020-01-07	1750 MHz	OK
3151	Head 1900MHz	2020-01-07	1900 MHz	OK
3151	Head 2450MHz	2020-01-08	2450 MHz	OK
3151	Head 2550MHz	2020-01-08	2550 MHz	OK
3151	Body 750MHz	2020-01-06	750 MHz	OK
3151	Body 835MHz	2020-01-06	835 MHz	OK
3151	Body 1750MHz	2020-01-07	1750 MHz	OK
3151	Body 1900MHz	2020-01-07	1900 MHz	OK
3151	Body 2450MHz	2020-01-08	2450 MHz	OK
3151	Body 2550MHz	2020-01-08	5200 MHz	OK



No. I20N00391-SAR

ANNEX G: DAE Calibration Certificate

DAE4 SN: 786 Calibration Certificate

 In Collaboration with
s p e a g
CALIBRATION LABORATORY

Add: No.51 Xueyuan Road, Haidian District, Beijing, 100191, China
Tel: +86-10-62304633-2512 Fax: +86-10-62304633-2504
E-mail: cttl@chinattl.com [Http://www.chinattl.cn](http://www.chinattl.cn)

  中国认可
国际互认
校准
CALIBRATION
CNAS L0570

Client : **CTTL(South Branch)**

Certificate No: **Z20-60101**

CALIBRATION CERTIFICATE			
Object	DAE4 - SN: 786		
Calibration Procedure(s)	FF-Z11-002-01 Calibration Procedure for the Data Acquisition Electronics (DAEx)		
Calibration date:	March 03, 2020		
This calibration Certificate documents the traceability to national standards, which realize the physical units of measurements(SI). The measurements and the uncertainties with confidence probability are given on the following pages and are part of the certificate.			
All calibrations have been conducted in the closed laboratory facility: environment temperature(22±3)°C and humidity<70%.			
Calibration Equipment used (M&TE critical for calibration)			
Primary Standards	ID #	Cal Date(Calibrated by, Certificate No.)	Scheduled Calibration
Process Calibrator 753	1971018	24-Jun-19 (CTTL, No.J19X05126)	Jun-20
Calibrated by:	Name	Function	Signature
	Yu Zongying	SAR Test Engineer	
Reviewed by:	Lin Hao	SAR Test Engineer	
Approved by:	Qi Dianyuan	SAR Project Leader	
Issued: March 05, 2020			
This calibration certificate shall not be reproduced except in full without written approval of the laboratory.			

Certificate No: Z20-60101

Page 1 of 3



Add: No.51 Xueyuan Road, Haidian District, Beijing, 100191, China
Tel: +86-10-62304633-2512 Fax: +86-10-62304633-2504
E-mail: cttl@chinattl.com Http://www.chinattl.cn

Glossary:

DAE data acquisition electronics
Connector angle information used in DASY system to align probe sensor X to the robot coordinate system.

Methods Applied and Interpretation of Parameters:

- *DC Voltage Measurement:* Calibration Factor assessed for use in DASY system by comparison with a calibrated instrument traceable to national standards. The figure given corresponds to the full scale range of the voltmeter in the respective range.
- *Connector angle:* The angle of the connector is assessed measuring the angle mechanically by a tool inserted. Uncertainty is not required.
- The report provide only calibration results for DAE, it does not contain other performance test results.



Add: No.51 Xueyuan Road, Haidian District, Beijing, 100191, China
Tel: +86-10-62304633-2512 Fax: +86-10-62304633-2504
E-mail: cttl@chinattl.com Http://www.chinattl.cn

DC Voltage Measurement

A/D - Converter Resolution nominal
High Range: 1LSB = 6.1μV , full range = -100...+300 mV
Low Range: 1LSB = 61nV , full range = -1.....+3mV
DASY measurement parameters: Auto Zero Time: 3 sec; Measuring time: 3 sec

Calibration Factors	X	Y	Z
High Range	404.081 ± 0.15% (k=2)	404.251 ± 0.15% (k=2)	404.649 ± 0.15% (k=2)
Low Range	3.97247 ± 0.7% (k=2)	3.97408 ± 0.7% (k=2)	3.95771 ± 0.7% (k=2)

Connector Angle

Connector Angle to be used in DASY system	229.5° ± 1 °
---	--------------



No. I20N00391-SAR

ANNEX H: Probe Calibration Certificate

Probe ES3DV3-SN: 3151 Calibration Certificate



In Collaboration with
s p e a g
CALIBRATION LABORATORY



中国认可
国际互认
校准
CALIBRATION
CNAS L0570

Add: No.51 Xueyuan Road, Haidian District, Beijing, 100191, China
Tel: +86-10-62304633-2512 Fax: +86-10-62304633-2504
E-mail: cttl@chinattl.com [Http://www.chinattl.cn](http://www.chinattl.cn)

Client **CTTL(South Branch)**

Certificate No: **Z20-60021**

CALIBRATION CERTIFICATE

Object: ES3DV3 - SN : 3151

Calibration Procedure(s): FF-Z11-004-01
Calibration Procedures for Dosimetric E-field Probes

Calibration date: January 03, 2020

This calibration Certificate documents the traceability to national standards, which realize the physical units of measurements(SI). The measurements and the uncertainties with confidence probability are given on the following pages and are part of the certificate.

All calibrations have been conducted in the closed laboratory facility: environment temperature(22±3)°C and humidity<70%.

Calibration Equipment used (M&TE critical for calibration)

Primary Standards	ID #	Cal Date(Calibrated by, Certificate No.)	Scheduled Calibration
Power Meter NRP2	101919	18-Jun-19(CTTL, No.J19X05125)	Jun-20
Power sensor NRP-Z91	101547	18-Jun-19(CTTL, No.J19X05125)	Jun-20
Power sensor NRP-Z91	101548	18-Jun-19(CTTL, No.J19X05125)	Jun-20
Reference 10dBAttenuator	18N50W-10dB	9-Feb-18(CTTL, No.J18X01133)	Feb-20
Reference 20dBAttenuator	18N50W-20dB	9-Feb-18(CTTL, No.J18X01132)	Feb-20
Reference Probe EX3DV4	SN 7307	24-May-19(SPEAG, No.EX3-7307_May19/2)	May-20
DAE4	SN 1525	26-Aug-19(SPEAG, No.DAE4-1525_Aug19)	Aug-20

Secondary Standards	ID #	Cal Date(Calibrated by, Certificate No.)	Scheduled Calibration
SignalGenerator MG3700A	6201052605	18-Jun-19(CTTL, No.J19X05127)	Jun-20
Network Analyzer E5071C	MY46110673	24-Jan-19(CTTL, No.J19X00547)	Jan-20

	Name	Function	Signature
Calibrated by:	Yu Zongying	SAR Test Engineer	
Reviewed by:	Lin Hao	SAR Test Engineer	
Approved by:	Qi Dianyuan	SAR Project Leader	

Issued: January 05, 2020

This calibration certificate shall not be reproduced except in full without written approval of the laboratory.



Add: No.51 Xueyuan Road, Haidian District, Beijing, 100191, China
Tel: +86-10-62304633-2512 Fax: +86-10-62304633-2504
E-mail: cttl@chinattl.com [Http://www.chinattl.cn](http://www.chinattl.cn)

Glossary:

TSL	tissue simulating liquid
NORM _{x,y,z}	sensitivity in free space
ConvF	sensitivity in TSL / NORM _{x,y,z}
DCP	diode compression point
CF	crest factor (1/duty_cycle) of the RF signal
A,B,C,D	modulation dependent linearization parameters
Polarization Φ	Φ rotation around probe axis
Polarization θ	θ rotation around an axis that is in the plane normal to probe axis (at measurement center), i $\theta=0$ is normal to probe axis

Connector Angle information used in DASY system to align probe sensor X to the robot coordinate system

Calibration is Performed According to the Following Standards:

- IEEE Std 1528-2013, "IEEE Recommended Practice for Determining the Peak Spatial-Averaged Specific Absorption Rate (SAR) in the Human Head from Wireless Communications Devices: Measurement Techniques", June 2013
- IEC 62209-1, "Measurement procedure for the assessment of Specific Absorption Rate (SAR) from hand-held and body-mounted devices used next to the ear (frequency range of 300 MHz to 6 GHz)", July 2016
- IEC 62209-2, "Procedure to determine the Specific Absorption Rate (SAR) for wireless communication devices used in close proximity to the human body (frequency range of 30 MHz to 6 GHz)", March 2010
- KDB 865664, "SAR Measurement Requirements for 100 MHz to 6 GHz"

Methods Applied and Interpretation of Parameters:

- NORM_{x,y,z}:** Assessed for E-field polarization $\theta=0$ ($f \leq 900$ MHz in TEM-cell; $f > 1800$ MHz: waveguide). NORM_{x,y,z} are only intermediate values, i.e., the uncertainties of NORM_{x,y,z} does not effect the E^2 -field uncertainty inside TSL (see below ConvF).
- NORM(f)_{x,y,z} = NORM_{x,y,z}* frequency_response** (see Frequency Response Chart). This linearization is implemented in DASY4 software versions later than 4.2. The uncertainty of the frequency response is included in the stated uncertainty of ConvF.
- DCP_{x,y,z}:** DCP are numerical linearization parameters assessed based on the data of power sweep (no uncertainty required). DCP does not depend on frequency nor media.
- PAR:** PAR is the Peak to Average Ratio that is not calibrated but determined based on the signal characteristics.
- A_{x,y,z}; B_{x,y,z}; C_{x,y,z}; VR_{x,y,z}; A,B,C** are numerical linearization parameters assessed based on the data of power sweep for specific modulation signal. The parameters do not depend on frequency nor media. VR is the maximum calibration range expressed in RMS voltage across the diode.
- ConvF and Boundary Effect Parameters:** Assessed in flat phantom using E-field (or Temperature Transfer Standard for $f \leq 800$ MHz) and inside waveguide using analytical field distributions based on power measurements for $f > 800$ MHz. The same setups are used for assessment of the parameters applied for boundary compensation (alpha, depth) of which typical uncertainty valued are given. These parameters are used in DASY4 software to improve probe accuracy close to the boundary. The sensitivity in TSL corresponds to NORM_{x,y,z}* ConvF whereby the uncertainty corresponds to that given for ConvF. A frequency dependent ConvF is used in DASY version 4.4 and higher which allows extending the validity from ± 50 MHz to ± 100 MHz.
- Spherical isotropy (3D deviation from isotropy):** in a field of low gradients realized using a flat phantom exposed by a patch antenna.
- Sensor Offset:** The sensor offset corresponds to the offset of virtual measurement center from the probe tip (on probe axis). No tolerance required.
- Connector Angle:** The angle is assessed using the information gained by determining the NORM_x (no uncertainty required).



No. I20N00391-SAR



Add: No.51 Xueyuan Road, Haidian District, Beijing, 100191, China
Tel: +86-10-62304633-2512 Fax: +86-10-62304633-2504
E-mail: ctl@chinatl.com [Http://www.chinatl.cn](http://www.chinatl.cn)

Probe ES3DV3

SN: 3151

Calibrated: January 03, 2020

Calibrated for DASY/EASY Systems

(Note: non-compatible with DASY2 system!)



Add: No.51 Xueyuan Road, Haidian District, Beijing, 100191, China
 Tel: +86-10-62304633-2512 Fax: +86-10-62304633-2504
 E-mail: ctl@chinattl.com [Http://www.chinattl.cn](http://www.chinattl.cn)

DASY/EASY – Parameters of Probe: ES3DV3 – SN:3151**Basic Calibration Parameters**

	Sensor X	Sensor Y	Sensor Z	Unc (k=2)
Norm($\mu\text{V}/(\text{V}/\text{m})^2$) ^A	1.15	1.25	1.20	±10.0%
DCP(mV) ^B	104.7	104.8	103.2	

Modulation Calibration Parameters

UID	Communication System Name		A dB	B dB· μV	C	D dB	VR mV	Unc ^E (k=2)
0	CW	X	0.0	0.0	1.0	0.00	270.2	±2.2%
		Y	0.0	0.0	1.0		279.5	
		Z	0.0	0.0	1.0		271.5	

The reported uncertainty of measurement is stated as the standard uncertainty of Measurement multiplied by the coverage factor k=2, which for a normal distribution Corresponds to a coverage probability of approximately 95%.

^A The uncertainties of Norm X, Y, Z do not affect the E²-field uncertainty inside TSL (see Page 5).

^B Numerical linearization parameter: uncertainty not required.

^E Uncertainty is determined using the max. deviation from linear response applying rectangular distribution and is expressed for the square of the field value.



Add: No.51 Xueyuan Road, Haidian District, Beijing, 100191, China
Tel: +86-10-62304633-2512 Fax: +86-10-62304633-2504
E-mail: cttl@chinattl.com [Http://www.chinattl.cn](http://www.chinattl.cn)

DASY/EASY – Parameters of Probe : ES3DV3 – SN:3151

Calibration Parameter Determined in Head Tissue Simulating Media

f [MHz] ^C	Relative Permittivity ^F	Conductivity (S/m) ^F	ConvF X	ConvF Y	ConvF Z	Alpha ^G	Depth ^G (mm)	Unct. (k=2)
750	41.9	0.89	6.41	6.41	6.41	0.40	1.35	±12.1%
900	41.5	0.97	6.23	6.23	6.23	0.40	1.46	±12.1%
1450	40.5	1.20	5.50	5.50	5.50	0.33	1.67	±12.1%
1750	40.1	1.37	5.23	5.23	5.23	0.54	1.35	±12.1%
1900	40.0	1.40	5.11	5.11	5.11	0.65	1.27	±12.1%
2000	40.0	1.40	5.07	5.07	5.07	0.60	1.35	±12.1%
2300	39.5	1.67	4.86	4.86	4.86	0.90	1.08	±12.1%
2450	39.2	1.80	4.68	4.68	4.68	0.90	1.08	±12.1%
2600	39.0	1.96	4.53	4.53	4.53	0.90	1.10	±12.1%

^C Frequency validity above 300 MHz of ±100MHz only applies for DASY v4.4 and higher (Page 2), else it is restricted to ±50MHz. The uncertainty is the RSS of ConvF uncertainty at calibration frequency and the uncertainty for the indicated frequency band. Frequency validity below 300 MHz is ± 10, 25, 40, 50 and 70 MHz for ConvF assessments at 30, 64, 128, 150 and 220 MHz respectively. Above 5 GHz frequency validity can be extended to ± 110 MHz.

^F At frequency below 3 GHz, the validity of tissue parameters (ϵ and σ) can be relaxed to ±10% if liquid compensation formula is applied to measured SAR values. At frequencies above 3 GHz, the validity of tissue parameters (ϵ and σ) is restricted to ±5%. The uncertainty is the RSS of the ConvF uncertainty for indicated target tissue parameters.

^G Alpha/Depth are determined during calibration. SPEAG warrants that the remaining deviation due to the boundary effect after compensation is always less than ± 1% for frequencies below 3 GHz and below ± 2% for the frequencies between 3-6 GHz at any distance larger than half the probe tip diameter from the boundary.



Add: No.51 Xueyuan Road, Haidian District, Beijing, 100191, China
Tel: +86-10-62304633-2512 Fax: +86-10-62304633-2504
E-mail: cttl@chinattl.com [Http://www.chinattl.cn](http://www.chinattl.cn)

Frequency Response of E-Field (TEM-Cell: ifi110 EXX, Waveguide: R22)

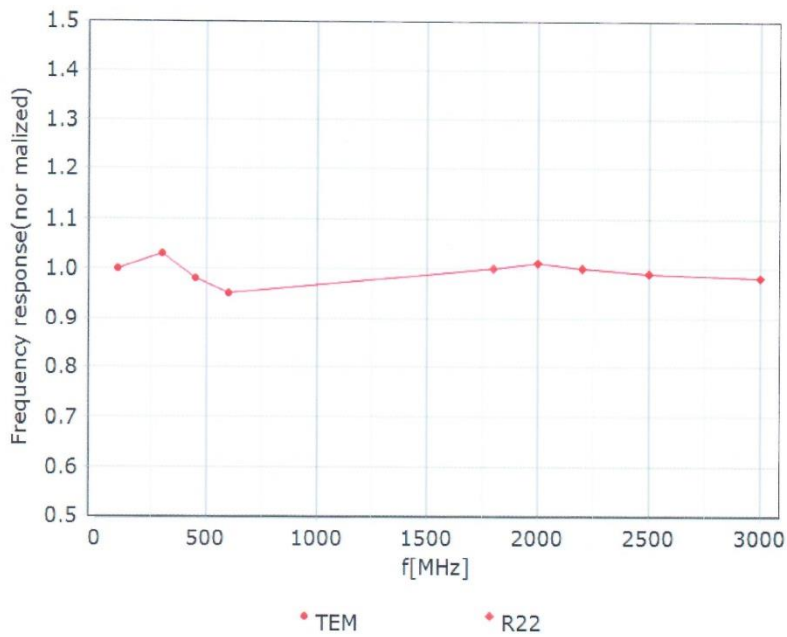

Uncertainty of Frequency Response of E-field: $\pm 7.4\%$ (k=2)



Add: No.51 Xueyuan Road, Haidian District, Beijing, 100191, China
 Tel: +86-10-62304633-2512 Fax: +86-10-62304633-2504
 E-mail: cttl@chinattl.com [Http://www.chinattl.cn](http://www.chinattl.cn)

Receiving Pattern (Φ), $\theta=0^\circ$

f=600 MHz, TEM

f=1800 MHz, R22

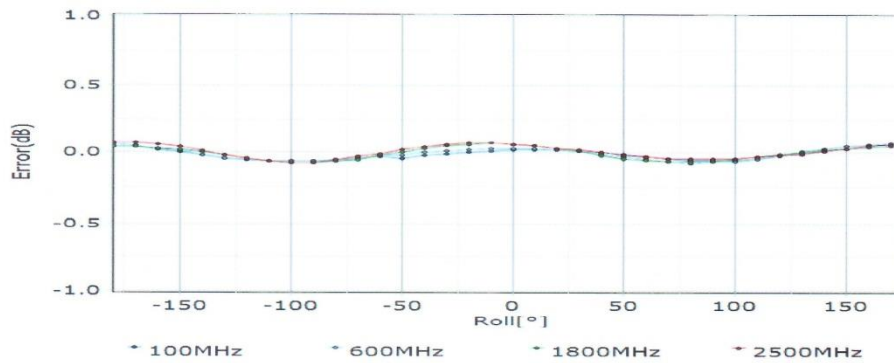
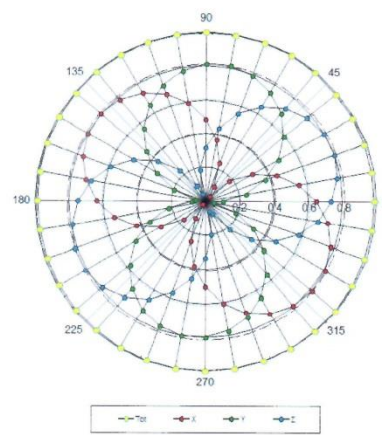
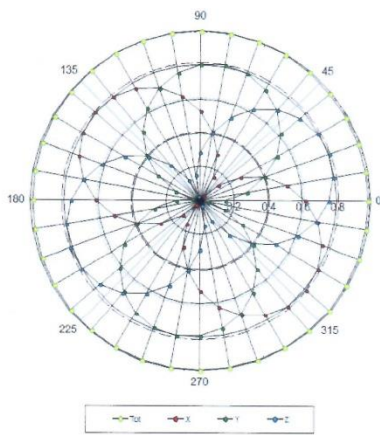

Uncertainty of Axial Isotropy Assessment: $\pm 1.2\%$ ($k=2$)



Add: No.51 Xueyuan Road, Haidian District, Beijing, 100191, China
 Tel: +86-10-62304633-2512 Fax: +86-10-62304633-2504
 E-mail: cttl@chinattl.com [Http://www.chinattl.cn](http://www.chinattl.cn)

Dynamic Range f(SAR_{head}) (TEM cell, f = 900 MHz)

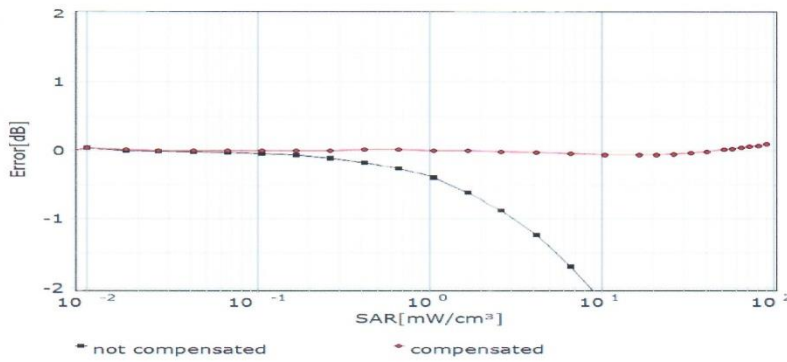
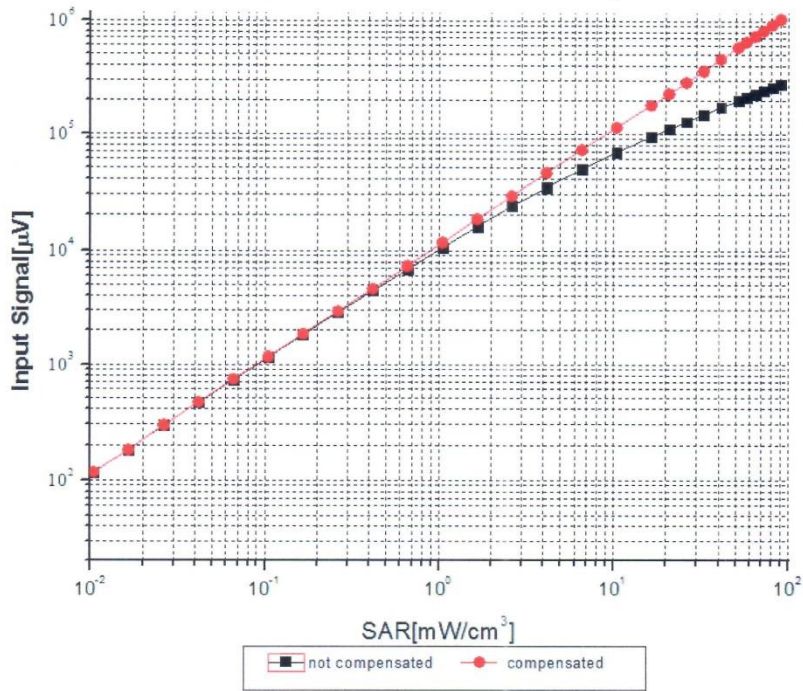

Uncertainty of Linearity Assessment: ±0.9% (k=2)



Add: No.51 Xueyuan Road, Haidian District, Beijing, 100191, China
 Tel: +86-10-62304633-2512 Fax: +86-10-62304633-2504
 E-mail: cttl@chinattl.com [Http://www.chinattl.cn](http://www.chinattl.cn)

Conversion Factor Assessment

f=750 MHz,WGLS R9(H_convF)

f=1750 MHz,WGLS R22(H_convF)

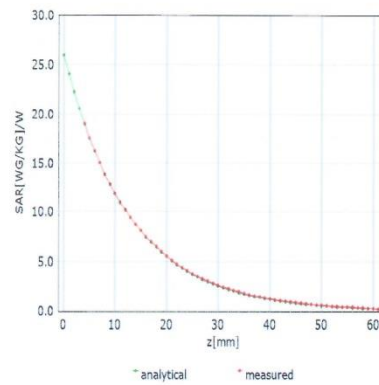
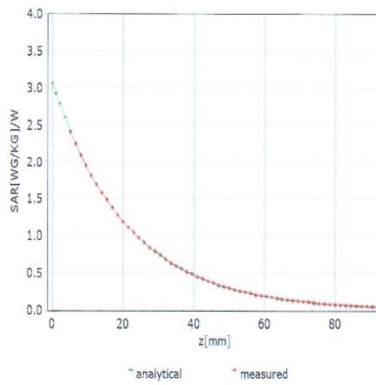

Deviation from Isotropy in Liquid

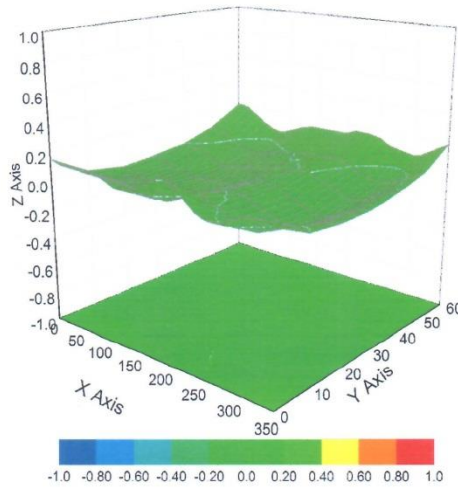

Uncertainty of Spherical Isotropy Assessment: $\pm 3.2\%$ (K=2)



Add: No.51 Xueyuan Road, Haidian District, Beijing, 100191, China
Tel: +86-10-62304633-2512 Fax: +86-10-62304633-2504
E-mail: ctl@chinatl.com [Http://www.chinatl.cn](http://www.chinatl.cn)

DASY/EASY – Parameters of Probe: ES3DV3 – SN:3151

Other Probe Parameters

Sensor Arrangement	Triangular
Connector Angle (°)	89
Mechanical Surface Detection Mode	enabled
Optical Surface Detection Mode	disable
Probe Overall Length	337mm
Probe Body Diameter	10mm
Tip Length	10mm
Tip Diameter	4mm
Probe Tip to Sensor X Calibration Point	2mm
Probe Tip to Sensor Y Calibration Point	2mm
Probe Tip to Sensor Z Calibration Point	2mm
Recommended Measurement Distance from Surface	3mm



ANNEX I: Dipole Calibration Certificate

835 MHz Dipole Calibration Certificate



In Collaboration with
s p e a g
CALIBRATION LABORATORY



中国认可
国际互认
校准
CALIBRATION
CNAS L0570

Add: No.51 Xueyuan Road, Haidian District, Beijing, 100191, China
Tel: +86-10-62304633-2079 Fax: +86-10-62304633-2504
E-mail: cttl@chinattl.com http://www.chinattl.cn

Client **CTTL(South Branch)**

Certificate No: **Z18-60385**

CALIBRATION CERTIFICATE

Object: D835V2 - SN: 4d057

Calibration Procedure(s): FF-Z11-003-01
Calibration Procedures for dipole validation kits

Calibration date: October 9, 2018

This calibration Certificate documents the traceability to national standards, which realize the physical units of measurements(SI). The measurements and the uncertainties with confidence probability are given on the following pages and are part of the certificate.

All calibrations have been conducted in the closed laboratory facility: environment temperature(22±3)°C and humidity<70%.

Calibration Equipment used (M&TE critical for calibration)

Primary Standards	ID #	Cal Date(Calibrated by, Certificate No.)	Scheduled Calibration
Power Meter NRVD	102083	01-Nov-17 (CTTL, No.J17X08756)	Oct-18
Power sensor NRV-Z5	100542	01-Nov-17 (CTTL, No.J17X08756)	Oct-18
Reference Probe EX3DV4	SN 7514	27-Aug-18(SPEAG,No.EX3-7514_Aug18)	Aug-19
DAE4	SN 1555	20-Aug-18(SPEAG,No.DAE4-1555_Aug18)	Aug-19
Secondary Standards	ID #	Cal Date(Calibrated by, Certificate No.)	Scheduled Calibration
Signal Generator E4438C	MY49071430	23-Jan-18 (CTTL, No.J18X00560)	Jan-19
NetworkAnalyzer E5071C	MY46110673	24-Jan-18 (CTTL, No.J18X00561)	Jan-19

	Name	Function	Signature
Calibrated by:	Zhao Jing	SAR Test Engineer	
Reviewed by:	Lin Hao	SAR Test Engineer	
Approved by:	Qi Dianyuan	SAR Project Leader	

Issued: October 11, 2018

This calibration certificate shall not be reproduced except in full without written approval of the laboratory.

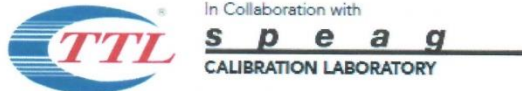

Add: No.51 Xueyuan Road, Haidian District, Beijing, 100191, China
Tel: +86-10-62304633-2079 Fax: +86-10-62304633-2504
E-mail: cttl@chinattl.com http://www.chinattl.cn

Glossary:

TSL	tissue simulating liquid
ConvF	sensitivity in TSL / NORM _{x,y,z}
N/A	not applicable or not measured

Calibration is Performed According to the Following Standards:

- IEEE Std 1528-2013, "IEEE Recommended Practice for Determining the Peak Spatial-Averaged Specific Absorption Rate (SAR) in the Human Head from Wireless Communications Devices: Measurement Techniques", June 2013
- IEC 62209-1, "Measurement procedure for assessment of specific absorption rate of human exposure to radio frequency fields from hand-held and body-mounted wireless communication devices- Part 1: Device used next to the ear (Frequency range of 300MHz to 6GHz)", July 2016
- IEC 62209-2, "Procedure to measure the Specific Absorption Rate (SAR) For wireless communication devices used in close proximity to the human body (frequency range of 30MHz to 6GHz)", March 2010
- KDB865664, SAR Measurement Requirements for 100 MHz to 6 GHz

Additional Documentation:

- DASY4/5 System Handbook

Methods Applied and Interpretation of Parameters:

- Measurement Conditions:* Further details are available from the Validation Report at the end of the certificate. All figures stated in the certificate are valid at the frequency indicated.
- Antenna Parameters with TSL:* The dipole is mounted with the spacer to position its feed point exactly below the center marking of the flat phantom section, with the arms oriented parallel to the body axis.
- Feed Point Impedance and Return Loss:* These parameters are measured with the dipole positioned under the liquid filled phantom. The impedance stated is transformed from the measurement at the SMA connector to the feed point. The Return Loss ensures low reflected power. No uncertainty required.
- Electrical Delay:* One-way delay between the SMA connector and the antenna feed point. No uncertainty required.
- SAR measured:* SAR measured at the stated antenna input power.
- SAR normalized:* SAR as measured, normalized to an input power of 1 W at the antenna connector.
- SAR for nominal TSL parameters:* The measured TSL parameters are used to calculate the nominal SAR result.

The reported uncertainty of measurement is stated as the standard uncertainty of Measurement multiplied by the coverage factor $k=2$, which for a normal distribution Corresponds to a coverage probability of approximately 95%.