



SAR TEST REPORT

No. I19Z61861-SEM02

For

TCL Communication Ltd.

USB Connect 4G V2 (APAC)

Model Name: IK41CQ

With

Hardware Version: V3.0

Software Version: IK41_ZZ_02.00_01

FCC ID: 2ACCJB116

Issued Date: 2019-12-6

Note:

The test results in this test report relate only to the devices specified in this report. This report shall not be reproduced except in full without the written approval of CTTL.

The report must not be used by the client to claim product certification, approval, or endorsement by NVLAP, NIST, or any agency of the U.S.Government.

Test Laboratory:

CTTL, Telecommunication Technology Labs, CAICT

No. 51, Xueyuan Road, Haidian District, Beijing, P. R. China 100191.

Tel:+86(0)10-62304633-2512, Fax:+86(0)10-62304633-2504

Email: cttl_terminals@caict.ac.cn, website: www.caict.ac.cn

**REPORT HISTORY**

Report Number	Revision	Issue Date	Description
I19Z61861-SEM02	Rev.0	2019-11-28	Initial creation of test report
I19Z61861-SEM02	Rev.1	2019-12-4	Added the probe ConvF on page 46. Updated the duty cycle on page 47. Remove test data about LTE band19.
I19Z61861-SEM02	Rev.2	2019-12-6	Updated Exposure Configuration and removed Equipment class on table 2.1.

TABLE OF CONTENT

1 TEST LABORATORY	5
1.1 TESTING LOCATION	5
1.2 TESTING ENVIRONMENT.....	5
1.3 PROJECT DATA	5
1.4 SIGNATURE.....	5
2 STATEMENT OF COMPLIANCE	6
3 CLIENT INFORMATION	7
3.1 APPLICANT INFORMATION	7
3.2 MANUFACTURER INFORMATION	7
4 EQUIPMENT UNDER TEST (EUT) AND ANCILLARY EQUIPMENT (AE).....	8
4.1 ABOUT EUT	8
4.2 INTERNAL IDENTIFICATION OF EUT USED DURING THE TEST	8
5 TEST METHODOLOGY	9
5.1 APPLICABLE LIMIT REGULATIONS	9
5.2 APPLICABLE MEASUREMENT STANDARDS.....	9
6 SPECIFIC ABSORPTION RATE (SAR).....	10
6.1 INTRODUCTION.....	10
6.2 SAR DEFINITION.....	10
7 TISSUE SIMULATING LIQUIDS	11
7.1 TARGETS FOR TISSUE SIMULATING LIQUID	11
7.2 DIELECTRIC PERFORMANCE	11
8 SYSTEM VERIFICATION	13
8.1 SYSTEM SETUP.....	13
8.2 SYSTEM VERIFICATION.....	14
9 MEASUREMENT PROCEDURES	15
9.1 TESTS TO BE PERFORMED	15
9.2 GENERAL MEASUREMENT PROCEDURE.....	17
9.3 SAR MEASUREMENT FOR LTE.....	18
9.4 POWER DRIFT.....	18
10 AREA SCAN BASED 1-G SAR.....	19
10.1 REQUIREMENT OF KDB.....	19
10.2 FAST SAR ALGORITHMS	19
11 CONDUCTED OUTPUT POWER.....	20
11.1 GSM MEASUREMENT RESULT	20
11.2 LTE MEASUREMENT RESULT	22



12 TRANSMIT ANTENNA POSITION AND SIZE	29
13 SAR TEST RESULT	30
13.1 SAR RESULTS FOR FAST SAR.....	30
13.2 SAR RESULTS FOR STANDARD PROCEDURE.....	32
14 SAR MEASUREMENT VARIABILITY	33
15 MEASUREMENT UNCERTAINTY	35
15.1 MEASUREMENT UNCERTAINTY FOR NORMAL SAR TESTS (300MHZ~3GHZ)	35
15.2 MEASUREMENT UNCERTAINTY FOR NORMAL SAR TESTS (3~6GHZ)	36
15.3 MEASUREMENT UNCERTAINTY FOR FAST SAR TESTS (300MHZ~3GHZ)	37
15.4 MEASUREMENT UNCERTAINTY FOR FAST SAR TESTS (3~6GHZ).....	38
16 MAIN TEST INSTRUMENTS	40
ANNEX A GRAPH RESULTS	41
ANNEX B SYSTEM VERIFICATION RESULTS	48
ANNEX C SAR MEASUREMENT SETUP	52
ANNEX D POSITION OF THE WIRELESS DEVICE IN RELATION TO THE PHANTOM	58
ANNEX E EQUIVALENT MEDIA RECIPES	59
ANNEX F SYSTEM VALIDATION	60
ANNEX G PROBE CALIBRATION CERTIFICATE	61
ANNEX H DIPOLE CALIBRATION CERTIFICATE	80
ANNEX I SENSOR TRIGGERING DATA SUMMARY	104
ANNEX J ACCREDITATION CERTIFICATE	109

1 Test Laboratory

1.1 Testing Location

Company Name:	CTTL(Shouxiang)
Address:	No. 51 Shouxiang Science Building, Xueyuan Road, Haidian District, Beijing, P. R. China100191

1.2 Testing Environment

Temperature:	18°C~25°C,
Relative humidity:	30%~ 70%
Ground system resistance:	< 0.5 Ω
Ambient noise & Reflection:	< 0.012 W/kg

1.3 Project Data

Project Leader:	Qi Dianyuan
Test Engineer:	Lin Xiaojun
Testing Start Date:	November 20, 2019
Testing End Date:	November 22, 2019

1.4 Signature



Lin Xiaojun
(Prepared this test report)



Qi Dianyuan
(Reviewed this test report)

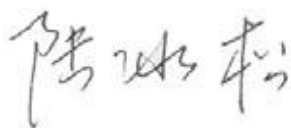

Lu Bingsong
Deputy Director of the laboratory
(Approved this test report)

2 Statement of Compliance

The maximum results of Specific Absorption Rate (SAR) found during testing for TCL Communication Ltd. USB Connect 4G V2 (APAC) IK41CQ is as follows:

Table 2.1: Highest Reported SAR (1g)

Exposure Configuration	Technology Band	Position	Highest Reported SAR 1g(W/kg)
Body worn (Separation Distance 5mm)	GSM850	Body	1.23
	GSM1900	Body	1.20
	WCDMA850	Body	0.94
	LTE Band5	Body	0.78
	LTE Band40	Body	1.13

The SAR values found for the Mobile Phone are below the maximum recommended levels of 1.6 W/kg as averaged over any 1g tissue according to the ANSI C95.1-1992.

For body operation, this device has been tested and meets FCC RF exposure guidelines when used with any accessory that contains no metal and which provides a minimum separation distance of 5 mm between this device and the body of the user. Use of other accessories may not ensure compliance with FCC RF exposure guidelines.

The measurement together with the test system set-up is described in annex C of this test report. A detailed description of the equipment under test can be found in chapter 4 of this test report. The highest reported SAR value is obtained at the case of **(Table 2.1)**, and the values are: **1.23 W/kg(1g)**.



3 Client Information

3.1 Applicant Information

Company Name:	TCL Communication Ltd.
Address/Post:	5/F, Building 22E, 22 Science Park East Avenue, Hong Kong Science Park, Shatin, NT, Hong Kong
Contact Person:	Gong Zhizhou
Contact Email:	zhizhou.gong@tcl.com
Telephone:	0086-755-36611722
Fax	0086-755-36612000-81722

3.2 Manufacturer Information

Company Name:	TCL Communication Ltd.
Address/Post:	5/F, Building 22E, 22 Science Park East Avenue, Hong Kong Science Park, Shatin, NT, Hong Kong
Contact Person:	Gong Zhizhou
Contact Email:	zhizhou.gong@tcl.com
Telephone:	0086-755-36611722
Fax	0086-755-36612000-81722

4 Equipment Under Test (EUT) and Ancillary Equipment (AE)

4.1 About EUT

Description:	USB Connect 4G V2 (APAC)
Model name:	IK41CQ
Operating mode(s):	GSM850/900/1800/1900, WCDMA850/900/1800/2100 LTE Band 1/3/5/19/28/40
Tested Tx Frequency:	825 – 848.8 MHz (GSM 850)
	1850.2 – 1910 MHz (GSM 1900)
	824 – 849 MHz (LTE Band 5)
	2300 – 2400 MHz (LTE Band 40)
GPRS/EGPRS Multislot Class:	33
GPRS capability Class:	B
Test device Production information:	Production unit
Device type:	Portable device
Antenna type:	Integrated antenna

4.2 Internal Identification of EUT used during the test

EUT ID*	IMEI	HW Version	SW Version
EUT1	352600110000305	V3.0	IK41_ZZ_02.00_01
EUT2	352600110000404	V3.0	IK41_ZZ_02.00_01
EUT3	352600110000560	V3.0	IK41_ZZ_02.00_01
EUT4	352600110000495	V3.0	IK41_ZZ_02.00_01

*EUT ID: is used to identify the test sample in the lab internally.

Note: It is performed to test SAR with the EUT1&2 and conducted power with the EUT3&4.

5 TEST METHODOLOGY

5.1 Applicable Limit Regulations

ANSI C95.1–1992:IEEE Standard for Safety Levels with Respect to Human Exposure to Radio Frequency Electromagnetic Fields, 3 kHz to 300 GHz.

It specifies the maximum exposure limit of **1.6 W/kg** as averaged over any 1 gram of tissue for portable devices being used within 20 cm of the user in the uncontrolled environment.

5.2 Applicable Measurement Standards

IEEE 1528–2013: Recommended Practice for Determining the Peak Spatial-Average Specific Absorption Rate (SAR) in the Human Head from Wireless Communications Devices: Measurement Techniques.

KDB447498 D01: General RF Exposure Guidance v06: Mobile and Portable Devices RF Exposure Procedures and Equipment Authorization Policies.

KDB447498 D02: SAR Procedures for Dongle Xmtr v02r01: SAR Measurement Procedures for USB Dongle Transmitters

KDB941225 D05 SAR for LTE Devices v02r05: SAR Evaluation Considerations for LTE Devices

KDB865664 D01 SAR measurement 100 MHz to 6 GHz v01r04: SAR Measurement Requirements for 100 MHz to 6 GHz.

KDB865664 D02 RF Exposure Reporting v01r02: RF Exposure Compliance Reporting and Documentation Considerations

6 Specific Absorption Rate (SAR)

6.1 Introduction

SAR is related to the rate at which energy is absorbed per unit mass in an object exposed to a radio field. The SAR distribution in a biological body is complicated and is usually carried out by experimental techniques or numerical modeling. The standard recommends limits for two tiers of groups, occupational/controlled and general population/uncontrolled, based on a person's awareness and ability to exercise control over his or her exposure. In general, occupational/controlled exposure limits are higher than the limits for general population/uncontrolled.

6.2 SAR Definition

The SAR definition is the time derivative (rate) of the incremental energy (dW) absorbed by (dissipated in) an incremental mass (dm) contained in a volume element (dv) of a given density (ρ). The equation description is as below:

$$SAR = \frac{d}{dt} \left(\frac{dW}{dm} \right) = \frac{d}{dt} \left(\frac{dW}{\rho dv} \right)$$

SAR is expressed in units of Watts per kilogram (W/kg)

SAR measurement can be either related to the temperature elevation in tissue by

$$SAR = c \left(\frac{\delta T}{\delta t} \right)$$

Where: C is the specific heat capacity, δT is the temperature rise and δt is the exposure duration, or related to the electrical field in the tissue by

$$SAR = \frac{\sigma |E|^2}{\rho}$$

Where: σ is the conductivity of the tissue, ρ is the mass density of tissue and E is the RMS electrical field strength.

However for evaluating SAR of low power transmitter, electrical field measurement is typically applied.

7 Tissue Simulating Liquids

7.1 Targets for tissue simulating liquid

Table 7.1: Targets for tissue simulating liquid

Frequency(MHz)	Liquid Type	Conductivity(σ)	$\pm 5\%$ Range	Permittivity(ϵ)	$\pm 5\%$ Range
835	Body	0.97	0.92~1.02	55.2	52.4~58.0
1900	Body	1.52	1.44~1.60	53.3	50.6~56.0
2300	Body	1.85	1.76~1.94	52.8	50.2~55.4

7.2 Dielectric Performance

Table 7.2: Dielectric Performance of Tissue Simulating Liquid

Measurement Date (yyyy-mm-dd)	Type	Frequency	Permittivity ϵ	Drift (%)	Conductivity σ (S/m)	Drift (%)
2019-11-20	Body	835 MHz	55.11	-0.16	0.973	0.31
2019-11-21	Body	1900 MHz	53.22	-0.15	1.52	0.00
2019-11-22	Body	2300 MHz	53.5	1.13	1.802	-0.44

Note: The liquid temperature is 22.0°C

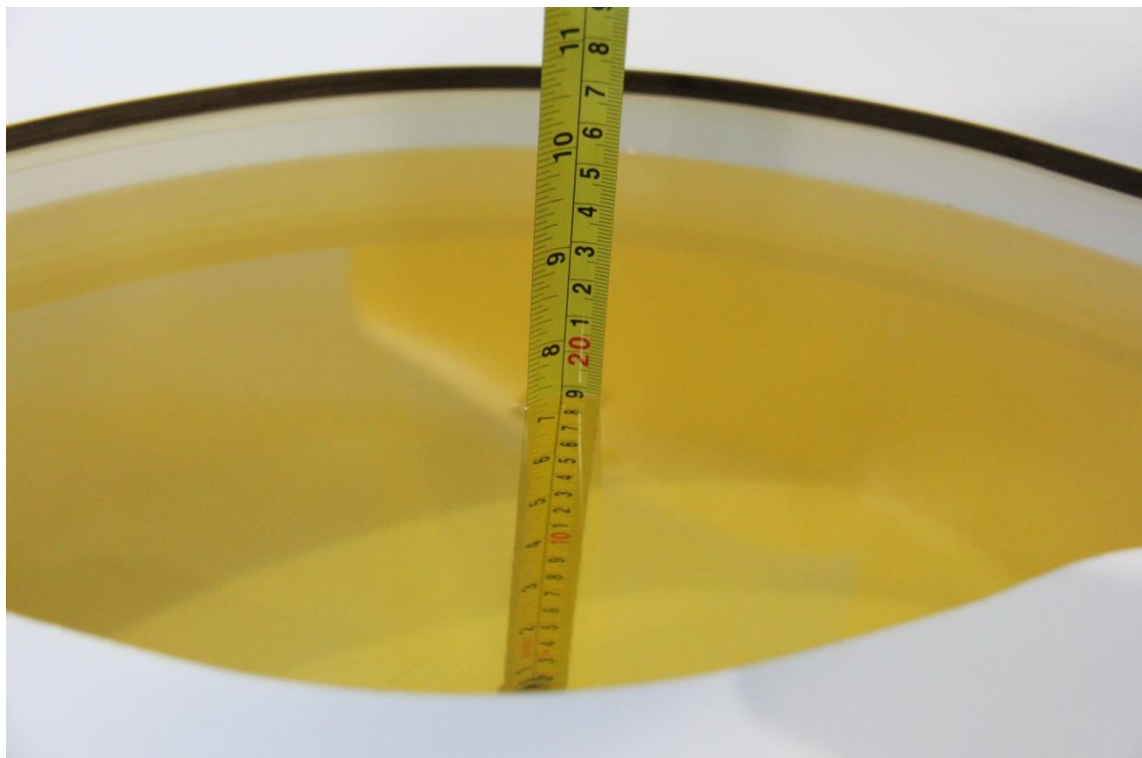

Picture 7-1 Liquid depth in the Flat Phantom (835 MHz)

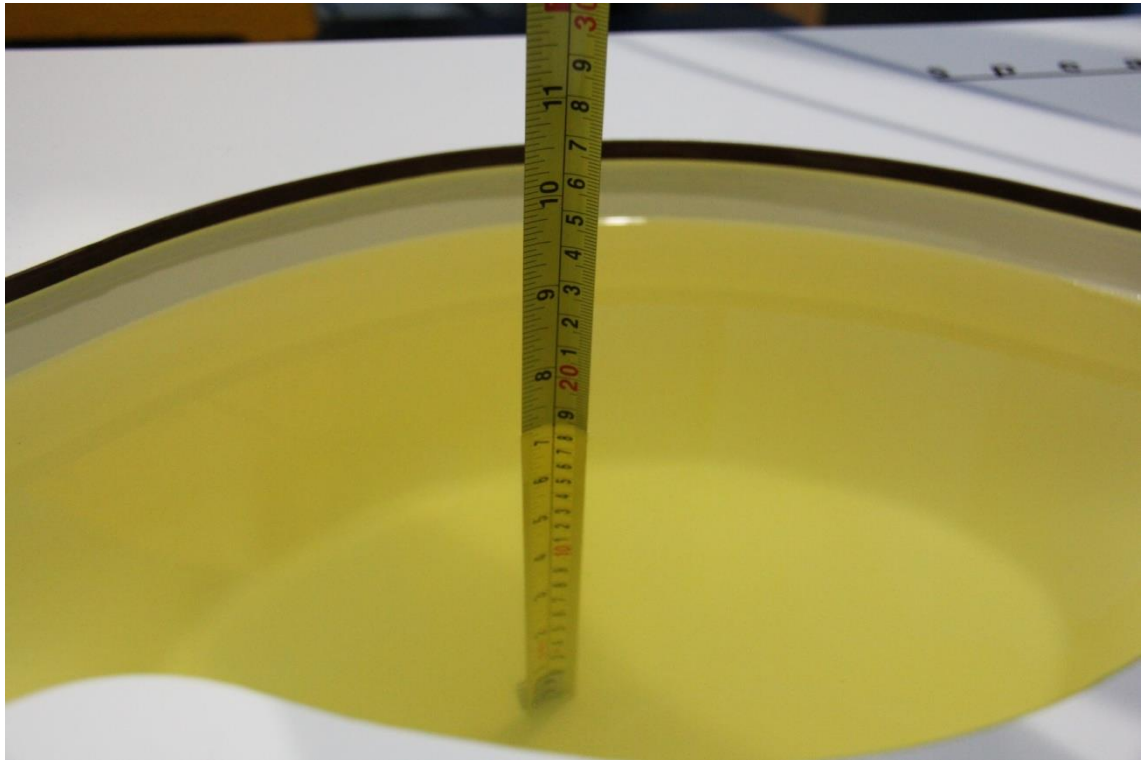

Picture 7-2 Liquid depth in the Flat Phantom (1900MHz)

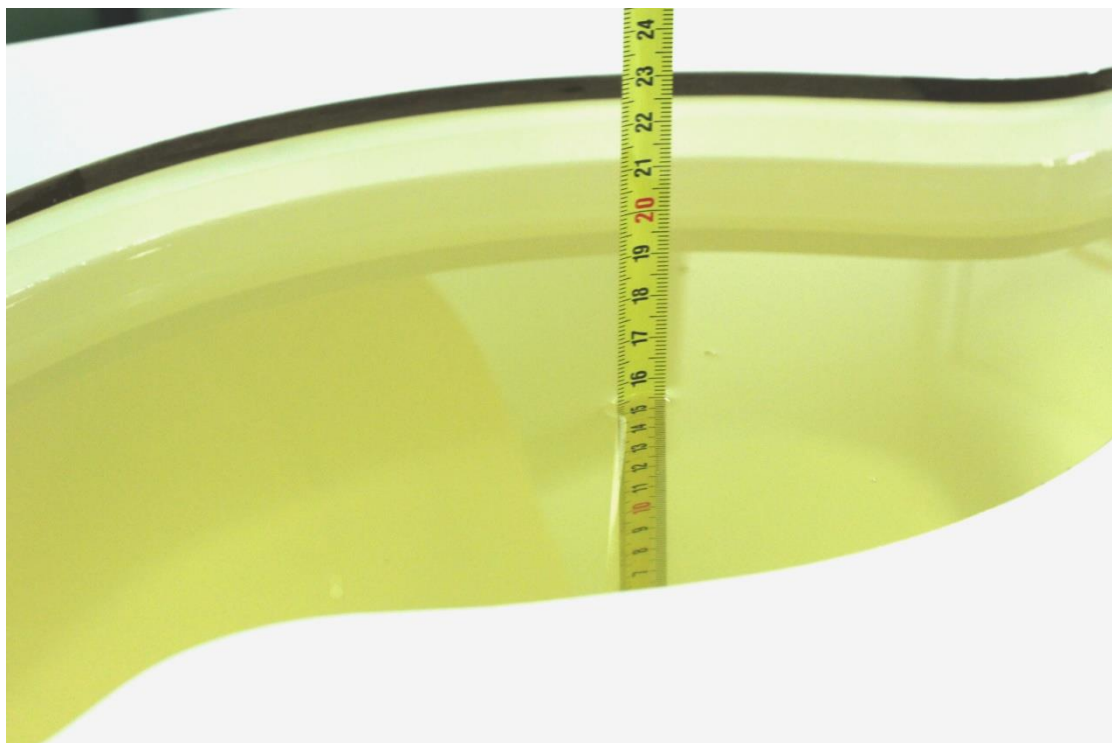

Picture 7-3 Liquid depth in the Flat Phantom (2300MHz)

8 System verification

8.1 System Setup

In the simplified setup for system evaluation, the DUT is replaced by a calibrated dipole and the power source is replaced by a continuous wave that comes from a signal generator. The calibrated dipole must be placed beneath the flat phantom section of the SAM twin phantom with the correct distance holder. The distance holder should touch the phantom surface with a light pressure at the reference marking and be oriented parallel to the long side of the phantom. The equipment setup is shown below:

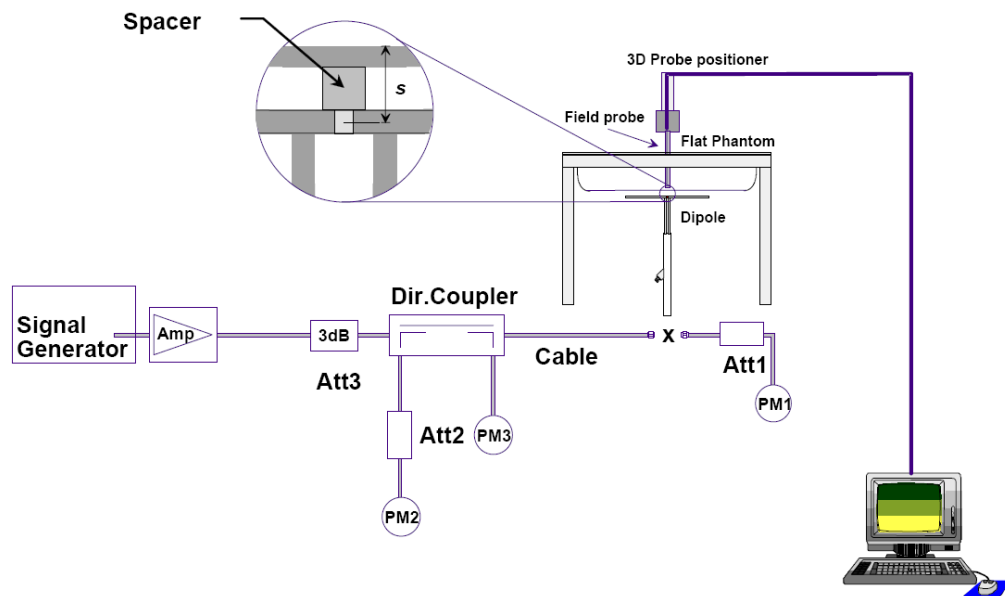

Picture 8.1 System Setup for System Evaluation



Picture 8.2 Photo of Dipole Setup

8.2 System Verification

SAR system verification is required to confirm measurement accuracy, according to the tissue dielectric media, probe calibration points and other system operating parameters required for measuring the SAR of a test device. The system verification must be performed for each frequency band and within the valid range of each probe calibration point required for testing the device.

The system verification results are required that the area scan estimated 1-g SAR is within 3% of the zoom scan 1-g SAR. The details are presented in annex B.

Table 8.1: System Verification of Body

Measurement Date (yyyy-mm-dd)	Frequency	Target value (W/kg)		Measured value (W/kg)		Deviation	
		10 g Average	1 g Average	10 g Average	1 g Average	10 g Average	1 g Average
2019-11-20	835 MHz	6.32	9.68	6.4	9.76	1.27%	0.83%
2019-11-21	1900 MHz	20.9	39.7	21	39.64	0.48%	-0.15%
2019-11-22	2300 MHz	22.9	47.2	22.96	47.28	0.26%	0.17%

9 Measurement Procedures

9.1 Tests to be performed

In order to determine the highest value of the peak spatial-average SAR of a handset, all device positions, configurations and operational modes shall be tested for each frequency band according to steps 1 to 3 below. A flowchart of the test process is shown in picture 9.1.

Step 1: The tests described in 9.2 shall be performed at the channel that is closest to the centre of the transmit frequency band (f_c) for:

- a) all device positions (cheek and tilt, for both left and right sides of the SAM phantom, as described in annex D),
- b) all configurations for each device position in a), e.g., antenna extended and retracted, and
- c) all operational modes, e.g., analogue and digital, for each device position in a) and configuration in b) in each frequency band.

If more than three frequencies need to be tested according to 11.1 (i.e., $N_c > 3$), then all frequencies, configurations and modes shall be tested for all of the above test conditions.

Step 2: For the condition providing highest peak spatial-average SAR determined in Step 1, perform all tests described in 9.2 at all other test frequencies, i.e., lowest and highest frequencies. In addition, for all other conditions (device position, configuration and operational mode) where the peak spatial-average SAR value determined in Step 1 is within 3 dB of the applicable SAR limit, it is recommended that all other test frequencies shall be tested as well.

Step 3: Examine all data to determine the highest value of the peak spatial-average SAR found in Steps 1 to 2.

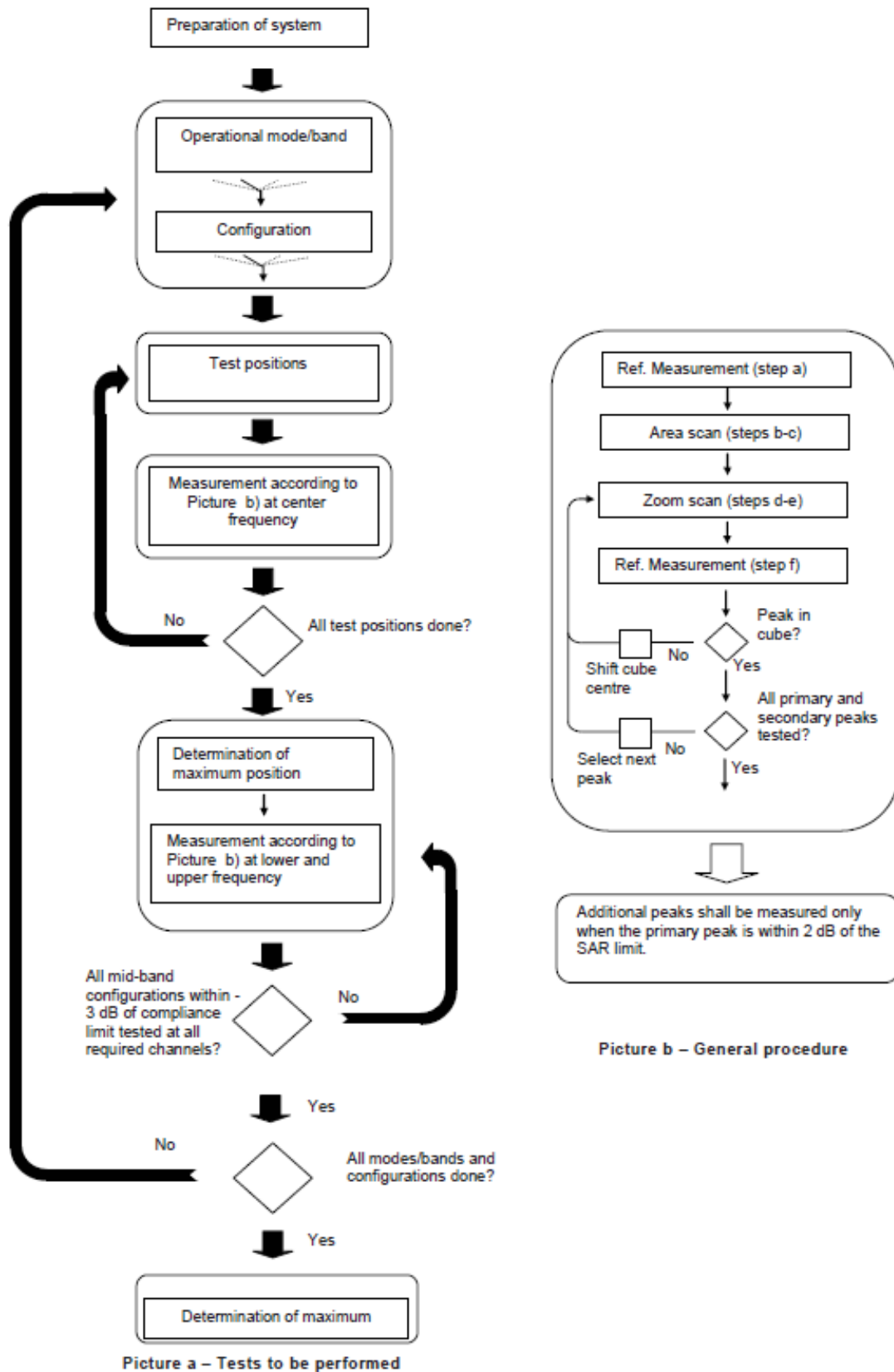

Picture 9.1 Block diagram of the tests to be performed

9.2 General Measurement Procedure

The area and zoom scan resolutions specified in the table below must be applied to the SAR measurements and fully documented in SAR reports to qualify for TCB approval. Probe boundary effect error compensation is required for measurements with the probe tip closer than half a probe tip diameter to the phantom surface. Both the probe tip diameter and sensor offset distance must satisfy measurement protocols; to ensure probe boundary effect errors are minimized and the higher fields closest to the phantom surface can be correctly measured and extrapolated to the phantom surface for computing 1-g SAR. Tolerances of the post-processing algorithms must be verified by the test laboratory for the scan resolutions used in the SAR measurements, according to the reference distribution functions specified in IEEE Std 1528-2003. The results should be documented as part of the system validation records and may be requested to support test results when all the measurement parameters in the following table are not satisfied.

		≤ 3 GHz	> 3 GHz	
Maximum distance from closest measurement point (geometric center of probe sensors) to phantom surface		5 ± 1 mm	$\frac{1}{2} \cdot \delta \cdot \ln(2) \pm 0.5$ mm	
Maximum probe angle from probe axis to phantom surface normal at the measurement location		$30^\circ \pm 1^\circ$	$20^\circ \pm 1^\circ$	
Maximum area scan spatial resolution: Δx_{Area} , Δy_{Area}		≤ 2 GHz: ≤ 15 mm 2 – 3 GHz: ≤ 12 mm	3 – 4 GHz: ≤ 12 mm 4 – 6 GHz: ≤ 10 mm	
		When the x or y dimension of the test device, in the measurement plane orientation, is smaller than the above, the measurement resolution must be \leq the corresponding x or y dimension of the test device with at least one measurement point on the test device.		
Maximum zoom scan spatial resolution: Δx_{Zoom} , Δy_{Zoom}		≤ 2 GHz: ≤ 8 mm 2 – 3 GHz: ≤ 5 mm*	3 – 4 GHz: ≤ 5 mm* 4 – 6 GHz: ≤ 4 mm*	
Maximum zoom scan spatial resolution, normal to phantom surface	uniform grid: $\Delta z_{Zoom}(n)$	≤ 5 mm	3 – 4 GHz: ≤ 4 mm 4 – 5 GHz: ≤ 3 mm 5 – 6 GHz: ≤ 2 mm	
	graded grid	$\Delta z_{Zoom}(1)$: between 1 st two points closest to phantom surface	≤ 4 mm	3 – 4 GHz: ≤ 3 mm 4 – 5 GHz: ≤ 2.5 mm 5 – 6 GHz: ≤ 2 mm
		$\Delta z_{Zoom}(n>1)$: between subsequent points	$\leq 1.5 \cdot \Delta z_{Zoom}(n-1)$	
Minimum zoom scan volume	x, y, z	≥ 30 mm	3 – 4 GHz: ≥ 28 mm 4 – 5 GHz: ≥ 25 mm 5 – 6 GHz: ≥ 22 mm	
Note: δ is the penetration depth of a plane-wave at normal incidence to the tissue medium; see draft standard IEEE P1528-2011 for details. * When zoom scan is required and the <i>reported</i> SAR from the area scan based 1-g SAR estimation procedures of KDB 447498 is ≤ 1.4 W/kg, ≤ 8 mm, ≤ 7 mm and ≤ 5 mm zoom scan resolution may be applied, respectively, for 2 GHz to 3 GHz, 3 GHz to 4 GHz and 4 GHz to 6 GHz.				

9.3 SAR Measurement for LTE

SAR tests for LTE are performed with a base station simulator, Rohde & Schwarz CMW500. Closed loop power control was used so the UE transmits with maximum output power during SAR testing. All powers were measured with the CMW 500.

It is performed for conducted power and SAR based on the KDB941225 D05.

SAR is evaluated separately according to the following procedures for the different test positions in each exposure condition – head, body, body-worn accessories and other use conditions. The procedures in the following subsections are applied separately to test each LTE frequency band.

1) QPSK with 1 RB allocation

Start with the largest channel bandwidth and measure SAR for QPSK with 1 RB allocation, using the RB offset and required test channel combination with the highest maximum output power among RB offsets at the upper edge, middle and lower edge of each required test channel. When the reported SAR is ≤ 0.8 W/kg, testing of the remaining RB offset configurations and required test channels is not required for 1 RB allocation; otherwise, SAR is required for the remaining required test channels and only for the RB offset configuration with the highest output power for that channel. When the reported SAR of a required test channel is > 1.45 W/kg, SAR is required for all three RB offset configurations for that required test channel.

2) QPSK with 50% RB allocation

The procedures required for 1 RB allocation in 1) are applied to measure the SAR for QPSK with 50% RB allocation.

3) QPSK with 100% RB allocation

For QPSK with 100% RB allocation, SAR is not required when the highest maximum output power for 100 % RB allocation is less than the highest maximum output power in 50% and 1 RB allocations and the highest reported SAR for 1 RB and 50% RB allocation in 1) and 2) are ≤ 0.8 W/kg. Otherwise, SAR is measured for the highest output power channel; and if the reported SAR is > 1.45 W/kg, the remaining required test channels must also be tested.

9.4 Power Drift

To control the output power stability during the SAR test, DASY4 system calculates the power drift by measuring the E-field at the same location at the beginning and at the end of the measurement for each test position. These drift values can be found in section 14 labeled as: (Power Drift [dB]). This ensures that the power drift during one measurement is within 5%.

10 Area Scan Based 1-g SAR

10.1 Requirement of KDB

According to the KDB447498 D01, when the implementation is based the specific polynomial fit algorithm as presented at the 29th Bioelectromagnetics Society meeting (2007) and the estimated 1-gSAR is ≤ 1.2 W/kg, a zoom scan measurement is not required provided it is also not needed for any other purpose; for example, if the peak SAR location required for simultaneous transmission SAR test exclusion can be determined accurately by the SAR system or manually to discriminate between distinctive peaks and scattered noisy SAR distributions from area scans.

There must not be any warning or alert messages due to various measurement concerns identified by the SAR system; for example, noise in measurements, peaks too close to scan boundary, peaks are too sharp, spatial resolution and uncertainty issues etc. The SAR system verification must also demonstrate that the area scan estimated 1-g SAR is within 3% of the zoom scan 1-g SAR (See Annex B). When all the SAR results for each exposure condition in a frequency band and wireless mode are based on estimated 1-g SAR, the 1-g SAR for the highest SAR configuration must be determined by a zoom scan.

10.2 Fast SAR Algorithms

The approach is based on the area scan measurement applying a frequency dependent attenuation parameter. This attenuation parameter was empirically determined by analyzing a large number of phones. The MOTOROLA FAST SAR was developed and validated by the MOTOROLA Research Group in Ft. Lauderdale.

In the initial study, an approximation algorithm based on Linear fit was developed. The accuracy of the algorithm has been demonstrated across a broad frequency range (136-2450 MHz) and for both 1- and 10-g averaged SAR using a sample of 264 SAR measurements from 55 wireless handsets. For the sample size studied, the root-mean-squared errors of the algorithm are 1.2% and 5.8% for 1- and 10-g averaged SAR, respectively. The paper describing the algorithm in detail is expected to be published in August 2004 within the Special Issue of Transactions on MTT.

In the second step, the same research group optimized the fitting algorithm to an Polynomial fit whereby the frequency validity was extended to cover the range 30-6000MHz. Details of this study can be found in the BEMS 2007 Proceedings.

Both algorithms are implemented in DASY software.

11 Conducted Output Power

There are two sets of tune-up power, Normal power and Low power for GSM1900/LTE B40 by SAR Sensor. The detail of SAR Sensor is presented in annex I.

11.1 GSM Measurement result

During the process of testing, the EUT was controlled via Agilent Digital Radio Communication tester (E5515C) to ensure the maximum power transmission and proper modulation. This result contains conducted output power for the EUT. In all cases, the measured peak output power should be greater and within 5% than EMI measurement.

Normal Power

Table 11.1-1: The conducted power measurement results for GSM

GSM 850 GPRS (GMSK)	Measured Power (dBm)				calculation	Averaged Power (dBm)		
	251	190	128			251	190	128
1 Txslot	33.50	33.42	33.28	34.00	-9.03	24.47	24.39	24.25
2Txslots	31.46	31.37	31.27	32.00	-6.02	25.44	25.35	25.25
3Txslots	29.31	29.27	29.22	30.50	-4.26	25.05	25.01	24.96
4Txslots	27.59	27.67	27.64	29.00	-3.01	24.58	24.66	24.63
GSM 850 EGPRS (GMSK)	Measured Power (dBm)				calculation	Averaged Power (dBm)		
	251	190	128			251	190	128
1 Txslot	33.46	33.34	33.21	34.00	-9.03	24.43	24.31	24.18
2Txslots	31.44	31.36	31.18	32.00	-6.02	25.42	25.34	25.16
3Txslots	29.31	29.18	29.12	30.50	-4.26	25.05	24.92	24.86
4Txslots	27.60	27.58	27.56	29.00	-3.01	24.59	24.57	24.55
GSM 850 EGPRS (8PSK)	Measured Power (dBm)				calculation	Averaged Power (dBm)		
	251	190	128			251	190	128
1 Txslot	26.49	26.54	26.56	28.00	-9.03	17.46	17.51	17.53
2 Txslots	24.64	24.57	24.66	26.00	-6.02	18.62	18.55	18.64
3Txslots	22.74	22.62	22.76	24.50	-4.26	18.48	18.36	18.50
4 Txslots	20.73	20.65	20.64	22.50	-3.01	17.72	17.64	17.63
PCS1900 GPRS (GMSK)	Measured Power (dBm)				calculation	Averaged Power (dBm)		
	810	661	512			810	661	512
1 Txslot	29.12	29.47	29.74	30.50	-9.03	20.09	20.44	20.71
2Txslots	27.37	27.58	27.84	28.50	-6.02	21.35	21.56	21.82
3Txslots	25.36	25.74	25.98	26.50	-4.26	21.10	21.48	21.72
4Txslots	23.87	24.28	24.63	24.50	-3.01	20.86	21.27	21.62
PCS1900 EGPRS (GMSK)	Measured Power (dBm)				calculation	Averaged Power (dBm)		
	810	661	512			810	661	512
1 Txslot	29.11	29.46	29.70	30.50	-9.03	20.08	20.43	20.67
2Txslots	27.13	27.59	27.88	28.50	-6.02	21.11	21.57	21.86
3Txslots	25.34	25.77	26.00	26.50	-4.26	21.08	21.51	21.74

4Txslots	24.03	24.40	24.71	24.50	-3.01	21.02	21.39	21.70
PCS1900	Measured Power (dBm)				calculation	Averaged Power (dBm)		
EGPRS (8PSK)	810	661	512			810	661	512
1 Txslot	25.25	25.62	25.86	26.50	-9.03	16.22	16.59	16.83
2 Txslots	23.28	23.66	23.88	24.50	-6.02	17.26	17.64	17.86
3Txslots	21.28	21.66	21.87	22.50	-4.26	17.02	17.40	17.61
4 Txslots	19.28	19.71	19.85	20.50	-3.01	16.27	16.70	16.84

NOTES:

1) Division Factors

To average the power, the division factor is as follows:

1TX-slot = 1 transmit time slot out of 8 time slots=> conducted power divided by (8/1) => -9.03dB

2TX-slots = 2 transmit time slots out of 8 time slots=> conducted power divided by (8/2) => -6.02dB

3TX-slots = 3 transmit time slots out of 8 time slots=> conducted power divided by (8/3) => -4.26dB

4TX-slots = 4 transmit time slots out of 8 time slots=> conducted power divided by (8/4) => -3.01dB

According to the conducted power as above, the body measurements are performed with 2Tx slots for GSM850/1900.

Low Power

Table 11.1-2: The conducted power measurement results for GSM, GPRS and EGPRS

PCS1900	Measured Power (dBm)				calculation	Averaged Power (dBm)		
GPRS (GMSK)	810	661	512			810	661	512
1 Txslot	25.31	25.50	25.58	26.00	-9.03	16.28	16.47	16.55
2 Txslots	22.34	22.44	22.50	24.00	-6.02	16.32	16.42	16.48
3Txslots	20.90	21.08	21.24	22.00	-4.26	16.64	16.82	16.98
4 Txslots	19.30	19.38	19.52	20.00	-3.01	16.29	16.37	16.51
PCS1900	Measured Power (dBm)				calculation	Averaged Power (dBm)		
EGPRS (GMSK)	810	661	512			810	661	512
1 Txslot	25.22	25.47	25.53	26.00	-9.03	16.19	16.44	16.50
2 Txslots	22.23	22.38	22.11	24.00	-6.02	16.21	16.36	16.09
3Txslots	20.91	21.07	21.11	22.00	-4.26	16.65	16.81	16.85
4 Txslots	19.18	19.33	18.97	20.00	-3.01	16.17	16.32	15.96
PCS1900	Measured Power (dBm)				calculation	Averaged Power (dBm)		
EGPRS (8PSK)	810	661	512			810	661	512
1 Txslot	25.28	25.27	25.28	26.00	-9.03	16.25	16.24	16.25
2 Txslots	23.21	23.22	23.25	24.00	-6.02	17.19	17.20	17.23
3Txslots	21.15	21.18	21.22	22.00	-4.26	16.89	16.92	16.96
4 Txslots	19.12	19.16	19.18	20.00	-3.01	16.11	16.15	16.17

NOTES:

1) Division Factors

To average the power, the division factor is as follows:

1TX-slot = 1 transmit time slot out of 8 time slots=> conducted power divided by (8/1) => -9.03dB

2TX-slots = 2 transmit time slots out of 8 time slots=> conducted power divided by (8/2) => -6.02dB

3TX-slots = 3 transmit time slots out of 8 time slots=> conducted power divided by (8/3) => -4.26dB

4TX-slots = 4 transmit time slots out of 8 time slots=> conducted power divided by (8/4) => -3.01dB

According to the conducted power as above, the body measurements are performed with 3Txslots for GSM1900.

11.2 LTE Measurement result

Table 11.2-1: Maximum Power Reduction (MPR) for LTE

Modulation	Channel bandwidth / Transmission bandwidth configuration [RB]						MPR (dB)
	1.4	3	5	10	15	20	
	MHz	MHz	MHz	MHz	MHz	MHz	
QPSK	> 5	> 4	> 8	> 12	> 16	> 18	1
16 QAM	≤ 5	≤ 4	≤ 8	≤ 12	≤ 16	≤ 18	1
16 QAM	> 5	> 4	> 8	> 12	> 16	> 18	2

Table 11.2-2: The tune up for LTE– Normal Power

Band	Tune up
LTE Band 5	23
LTE Band 19	23
LTE Band 40	24.5

Table 11.2-3: The tune up for LTE– Low Power

Band	Tune up
LTE Band 40	22.3

Table 11.2-4: The conducted Power for LTE
Normal Power
LTE band5

Bandwidth (MHz)	RB allocation	Frequency (MHz)	QPSK	16QAM
	RB offset (Start RB)		Actual output power (dBm)	Actual output power (dBm)
1.4MHz	1RB-High (5)	848.3 (20643)	22.07	21.11
		836.5 (20525)	22.43	21.09
		824.7 (20407)	22.06	21.21
	1RB-Middle (3)	848.3 (20643)	22.26	21.32
		836.5 (20525)	22.23	21.09
		824.7 (20407)	22.21	21.04
	1RB-Low (0)	848.3 (20643)	22.13	21.24
		836.5 (20525)	22.14	21.12
		824.7 (20407)	22.06	21.08
	3RB-High (3)	848.3 (20643)	22.16	21.39
		836.5 (20525)	22.22	21.41
		824.7 (20407)	22.35	21.42
	3RB-Middle (1)	848.3 (20643)	22.22	21.45
		836.5 (20525)	22.30	21.50
		824.7 (20407)	22.40	21.43
	3RB-Low (0)	848.3 (20643)	22.17	21.48
		836.5 (20525)	22.23	21.43
		824.7 (20407)	22.14	21.29
	6RB (0)	848.3 (20643)	21.23	20.42
		836.5 (20525)	21.20	20.35
		824.7 (20407)	21.33	20.51
3MHz	1RB-High (14)	847.5 (20635)	22.13	21.63
		836.5 (20525)	22.47	21.17
		825.5 (20415)	22.34	21.55
	1RB-Middle (7)	847.5 (20635)	22.11	21.84
		836.5 (20525)	22.24	21.66
		825.5 (20415)	22.30	21.95
	1RB-Low (0)	847.5 (20635)	22.25	21.50
		836.5 (20525)	22.31	21.82
		825.5 (20415)	22.13	21.94
	8RB-High (7)	847.5 (20635)	21.14	20.44
		836.5 (20525)	21.09	20.63
		825.5 (20415)	21.04	20.24
	8RB-Middle (4)	847.5 (20635)	21.04	20.49
		836.5 (20525)	21.14	20.64
		825.5 (20415)	21.23	20.53
	8RB-Low (0)	847.5 (20635)	21.16	20.31
		836.5 (20525)	21.19	20.62
		825.5 (20415)	21.21	20.31
	15RB (0)	847.5 (20635)	21.16	20.28
		836.5 (20525)	21.09	20.50
		825.5 (20415)	21.20	20.47

5MHz	1RB-High (24)	846.5 (20625)	22.18	21.23
		836.5 (20525)	22.13	21.14
		826.5 (20425)	22.45	21.27
	1RB-Middle (12)	846.5 (20625)	22.30	21.35
		836.5 (20525)	22.10	21.17
		826.5 (20425)	22.26	21.22
	1RB-Low (0)	846.5 (20625)	22.42	21.03
		836.5 (20525)	22.03	21.19
		826.5 (20425)	22.38	21.16
	12RB-High (13)	846.5 (20625)	21.28	20.35
		836.5 (20525)	21.29	20.06
		826.5 (20425)	21.35	20.03
	12RB-Middle (6)	846.5 (20625)	21.21	20.29
		836.5 (20525)	21.23	20.19
		826.5 (20425)	21.32	20.13
	12RB-Low (0)	846.5 (20625)	21.23	20.20
		836.5 (20525)	21.21	20.10
		826.5 (20425)	21.37	20.48
25RB (0)	846.5 (20625)	21.29	20.49	
	836.5 (20525)	21.22	20.13	
	826.5 (20425)	21.32	20.34	
10MHz	1RB-High (49)	844 (20600)	22.37	21.38
		836.5 (20525)	22.33	21.36
		829 (20450)	22.31	21.01
	1RB-Middle (24)	844 (20600)	22.67	21.39
		836.5 (20525)	22.56	21.48
		829 (20450)	22.50	21.86
	1RB-Low (0)	844 (20600)	22.50	21.16
		836.5 (20525)	22.25	20.97
		829 (20450)	22.17	21.17
	25RB-High (25)	844 (20600)	21.38	20.33
		836.5 (20525)	21.34	20.44
		829 (20450)	21.40	20.41
	25RB-Middle (12)	844 (20600)	21.39	20.33
		836.5 (20525)	21.25	20.28
		829 (20450)	21.41	20.42
	25RB-Low (0)	844 (20600)	21.37	20.44
		836.5 (20525)	21.31	20.26
		829 (20450)	21.30	20.12
50RB (0)	844 (20600)	21.40	20.30	
	836.5 (20525)	21.43	20.36	
	829 (20450)	21.33	20.15	

LTE band40

Bandwidth (MHz)	RB allocation	Frequency (MHz)	QPSK	16QAM
	RB offset (Start RB)		Actual output power (dBm)	Actual output power (dBm)
5MHz	1RB-High (24)	2397.5 (39625)	23.41	22.08
		2350 (39150)	23.32	21.80
		2302.5 (38675)	23.19	22.50
	1RB-Middle (12)	2397.5 (39625)	23.57	22.62
		2350 (39150)	23.40	21.85
		2302.5 (38675)	23.05	22.34
	1RB-Low (0)	2397.5 (39625)	23.55	22.06
		2350 (39150)	23.15	21.85
		2302.5 (38675)	23.08	22.24
	12RB-High (13)	2397.5 (39625)	22.45	21.19
		2350 (39150)	22.23	21.04
		2302.5 (38675)	22.01	21.12
	12RB-Middle (6)	2397.5 (39625)	22.52	21.53
		2350 (39150)	22.01	20.84
		2302.5 (38675)	21.97	21.02
	12RB-Low (0)	2397.5 (39625)	22.43	21.71
		2350 (39150)	22.18	20.99
		2302.5 (38675)	22.06	21.07
	25RB (0)	2397.5 (39625)	22.53	21.45
		2350 (39150)	22.21	21.03
		2302.5 (38675)	22.10	21.22
10MHz	1RB-High (49)	2395 (39600)	23.34	22.59
		2350 (39150)	23.24	21.81
		2305 (38700)	23.15	22.95
	1RB-Middle (24)	2395 (39600)	23.72	22.97
		2350 (39150)	23.21	21.71
		2305 (38700)	22.92	22.73
	1RB-Low (0)	2395 (39600)	23.53	23.25
		2350 (39150)	23.08	21.78
		2305 (38700)	23.03	23.13
	25RB-High (25)	2395 (39600)	22.46	21.59
		2350 (39150)	22.28	21.01
		2305 (38700)	22.07	21.00
	25RB-Middle (12)	2395 (39600)	22.58	21.58
		2350 (39150)	22.30	21.06
		2305 (38700)	21.96	20.86
	25RB-Low (0)	2395 (39600)	22.63	21.80
		2350 (39150)	22.34	21.11
		2305 (38700)	22.09	20.90
50RB (0)	2395 (39600)	22.58	21.61	
	2350 (39150)	22.30	21.29	
	2305 (38700)	22.00	21.08	

15MHz	1RB-High (74)	2392.5 (39575)	23.53	22.64
		2350 (39150)	23.21	22.25
		2307.5 (38725)	23.44	21.52
	1RB-Middle (37)	2392.5 (39575)	23.77	23.16
		2350 (39150)	23.01	22.66
		2307.5 (38725)	22.64	22.86
	1RB-Low (0)	2392.5 (39575)	23.88	23.02
		2350 (39150)	23.25	22.55
		2307.5 (38725)	22.74	22.71
	36RB-High (38)	2392.5 (39575)	22.60	21.44
		2350 (39150)	22.16	21.27
		2307.5 (38725)	22.03	21.00
	36RB-Middle (19)	2392.5 (39575)	22.59	21.55
		2350 (39150)	22.09	20.85
		2307.5 (38725)	21.92	20.96
	36RB-Low (0)	2392.5 (39575)	22.65	21.52
		2350 (39150)	22.20	20.85
		2307.5 (38725)	21.90	20.93
	75RB (0)	2392.5 (39575)	22.44	21.40
		2350 (39150)	22.11	21.01
		2307.5 (38725)	22.06	20.90
20MHz	1RB-High (99)	2390 (39550)	23.41	21.58
		2350 (39150)	23.43	22.18
		2310 (38750)	23.16	21.57
	1RB-Middle (50)	2390 (39550)	23.67	21.85
		2350 (39150)	23.69	22.15
		2310 (38750)	23.44	22.24
	1RB-Low (0)	2390 (39550)	23.47	21.70
		2350 (39150)	23.62	22.43
		2310 (38750)	23.19	21.63
	50RB-High (50)	2390 (39550)	22.54	21.46
		2350 (39150)	22.26	21.18
		2310 (38750)	22.22	21.24
	50RB-Middle (25)	2390 (39550)	22.67	21.50
		2350 (39150)	22.19	21.01
		2310 (38750)	22.21	21.00
	50RB-Low (0)	2390 (39550)	22.57	21.50
		2350 (39150)	22.25	21.09
		2310 (38750)	22.09	20.89
	100RB (0)	2390 (39550)	22.57	21.40
		2350 (39150)	22.30	21.02
		2310 (38750)	22.15	21.03

**Low Power
LTE band40**

Bandwidth (MHz)	RB allocation	Frequency (MHz)	QPSK	16QAM
	RB offset (Start RB)		Actual output power (dBm)	Actual output power (dBm)
5MHz	1RB-High (24)	2397.5 (39625)	20.91	19.57
		2350 (39150)	21.10	19.61
		2302.5 (38675)	20.98	20.19
	1RB-Middle (12)	2397.5 (39625)	21.62	20.16
		2350 (39150)	21.08	19.37
		2302.5 (38675)	21.14	20.38
	1RB-Low (0)	2397.5 (39625)	21.19	19.66
		2350 (39150)	21.07	19.40
		2302.5 (38675)	21.12	20.27
	12RB-High (13)	2397.5 (39625)	20.09	19.02
		2350 (39150)	19.84	18.71
		2302.5 (38675)	20.20	18.85
	12RB-Middle (6)	2397.5 (39625)	20.19	19.19
		2350 (39150)	19.93	18.79
		2302.5 (38675)	20.09	19.16
	12RB-Low (0)	2397.5 (39625)	20.16	19.11
		2350 (39150)	20.04	18.81
		2302.5 (38675)	20.20	19.07
	25RB (0)	2397.5 (39625)	19.98	18.90
		2350 (39150)	19.96	18.91
		2302.5 (38675)	20.15	19.03
10MHz	1RB-High (49)	2395 (39600)	20.98	20.53
		2350 (39150)	21.00	19.54
		2305 (38700)	21.14	21.08
	1RB-Middle (24)	2395 (39600)	21.45	20.65
		2350 (39150)	20.98	19.45
		2305 (38700)	20.90	21.03
	1RB-Low (0)	2395 (39600)	21.34	20.69
		2350 (39150)	21.05	19.47
		2305 (38700)	21.08	21.04
	25RB-High (25)	2395 (39600)	20.10	19.23
		2350 (39150)	19.98	18.88
		2305 (38700)	20.19	18.99
	25RB-Middle (12)	2395 (39600)	20.20	19.23
		2350 (39150)	20.03	19.03
		2305 (38700)	20.10	18.94
	25RB-Low (0)	2395 (39600)	20.21	19.28
		2350 (39150)	20.02	19.02
		2305 (38700)	20.22	19.32
50RB (0)	2395 (39600)	20.17	19.01	
	2350 (39150)	20.07	19.11	
	2305 (38700)	20.20	19.02	

15MHz	1RB-High (74)	2392.5 (39575)	21.07	20.37
		2350 (39150)	21.11	19.37
		2307.5 (38725)	21.05	20.39
	1RB-Middle (37)	2392.5 (39575)	21.16	20.88
		2350 (39150)	20.88	19.32
		2307.5 (38725)	20.94	20.33
	1RB-Low (0)	2392.5 (39575)	21.20	20.87
		2350 (39150)	20.98	19.48
		2307.5 (38725)	21.21	20.55
	36RB-High (38)	2392.5 (39575)	20.16	19.00
		2350 (39150)	19.97	19.00
		2307.5 (38725)	20.19	18.93
	36RB-Middle (19)	2392.5 (39575)	20.24	19.15
		2350 (39150)	19.82	18.86
		2307.5 (38725)	19.93	18.96
	36RB-Low (0)	2392.5 (39575)	20.14	19.30
		2350 (39150)	19.82	18.94
		2307.5 (38725)	20.08	19.01
	75RB (0)	2392.5 (39575)	20.08	19.18
		2350 (39150)	19.93	18.80
		2307.5 (38725)	20.08	19.01
20MHz	1RB-High (99)	2390 (39550)	21.27	19.38
		2350 (39150)	21.15	20.04
		2310 (38750)	20.49	19.46
	1RB-Middle (50)	2390 (39550)	21.34	19.49
		2350 (39150)	21.18	20.06
		2310 (38750)	20.69	19.94
	1RB-Low (0)	2390 (39550)	21.07	19.39
		2350 (39150)	21.12	19.90
		2310 (38750)	20.68	19.59
	50RB-High (50)	2390 (39550)	20.05	19.02
		2350 (39150)	20.14	18.94
		2310 (38750)	19.98	18.89
	50RB-Middle (25)	2390 (39550)	20.13	19.24
		2350 (39150)	20.08	18.80
		2310 (38750)	19.91	18.99
	50RB-Low (0)	2390 (39550)	19.94	19.16
		2350 (39150)	19.97	18.88
		2310 (38750)	20.11	19.01
	100RB (0)	2390 (39550)	20.07	18.97
		2350 (39150)	19.92	18.71
		2310 (38750)	20.07	19.04

12 Transmit Antenna Position and Size

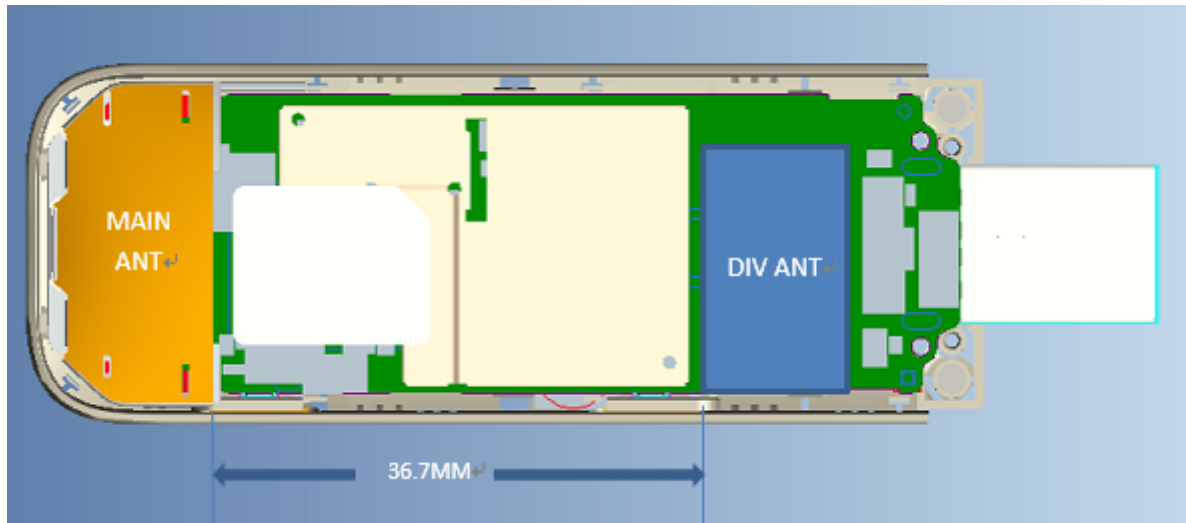

Picture 12.1 Antenna Position and size

13 SAR Test Result

It is determined by user manual for the distance between the EUT and the phantom bottom. The distance is 5mm 9mm or 14mm and just applied to the condition of body worn accessory.

It is performed for all SAR measurements with area scan based 1-g SAR estimation (Fast SAR). A zoom scan measurement is added when the estimated 1-g SAR is the highest measured SAR in each exposure configuration, wireless mode and frequency band combination or more than 1.2W/kg.

The calculated SAR is obtained by the following formula:

$$\text{Reported SAR} = \text{Measured SAR} \times 10^{(P_{\text{Target}} - P_{\text{Measured}})/10}$$

Where P_{Target} is the power of manufacturing upper limit;

P_{Measured} is the measured power in chapter 11.

Table 13.1: Duty Cycle

Mode	Duty Cycle
GPRS&EGPRS for GSM850/1900 Normal Power	1:4
GPRS&EGPRS for GSM1900 Low Power	1:2.67
LTE bands 5/19	1:1
LTE band40	1:1.58

13.1 SAR results for Fast SAR

Table 13.1-1: SAR Values (GSM 850 MHz Band - Body)

Channel Number	Frequency (MHz)	Test setup	Figure No./ Note	EUT Measured Power (dBm)	Tune up (dBm)	Measured SAR 1g (W/kg)	Calculated SAR 1g (W/kg)	Measured SAR 10g (W/kg)	Calculated SAR 10g (W/kg)	Power Drift
190	836.6	Front GPRS (2)	/	31.37	32.00	0.386	0.45	0.245	0.28	-0.11
190	836.6	Rear GPRS (2)	/	31.37	32.00	0.432	0.50	0.254	0.29	-0.03
190	836.6	Top Edge GPRS (2)	/	31.37	32.00	0.987	1.14	0.656	0.76	-0.01
251	848.8	Top Edge GPRS (2)	/	31.46	32.00	0.96	1.09	0.621	0.70	0.1
128	824.2	Top Edge GPRS (2)	/	31.27	32.00	0.957	1.13	0.63	0.75	0.05
251	848.8	Bottom Edge GPRS (2)	/	31.46	32.00	0.85	0.96	0.508	0.58	-0.02
190	836.6	Bottom Edge GPRS (2)	Fig.1	31.37	32.00	1.06	1.23	0.68	0.79	-0.03
128	824.2	Bottom Edge GPRS (2)	/	31.27	32.00	0.978	1.16	0.643	0.76	-0.04
190	836.6	Bottom Edge EGPRS (2)	/	31.36	32.00	1.023	1.19	0.675	0.78	-0.07
251	848.8	Bottom Edge EGPRS (2)	/	31.44	32.00	0.947	1.08	0.655	0.74	0.08
128	824.2	Bottom Edge EGPRS (2)	/	31.18	32.00	0.974	1.18	0.629	0.76	0.05

Note: The distance between the EUT and the phantom bottom is 5mm.

Table 13.1-2: SAR Values (GSM 1900 MHz Band - Body)

Channel Number	Frequency (MHz)	Test setup	Figure No./ Note	EUT Measured Power (dBm)	Tune up (dBm)	Measured SAR 1g (W/kg)	Calculated SAR 1g (W/kg)	Measured SAR 10g (W/kg)	Calculated SAR 10g (W/kg)	Power Drift
661	1880	Front GPRS(2)	Note1	27.58	28.50	0.376	0.46	0.208	0.26	-0.04
810	1909.8	Rear GPRS(2)	Note1	27.37	28.50	0.449	0.58	0.227	0.29	0.01
661	1880	Rear GPRS(2)	Note1	27.58	28.50	0.684	0.84	0.336	0.41	0.07
512	1850.2	Rear GPRS(2)	Note1	27.84	28.50	0.731	0.85	0.362	0.42	0.08
661	1880	Top Edge GPRS(2)	Note2	27.58	28.50	0.485	0.60	0.259	0.32	0.06
661	1880	Bottom Edge GPRS(2)	Note2	27.37	28.50	0.49	0.64	0.273	0.35	0.09
512	1850.2	Rear EGPRS(2)	Note1	27.88	28.50	0.727	0.84	0.359	0.41	0.10
810	1909.8	Rear EGPRS(2)	Note1	27.37	28.50	0.671	0.87	0.339	0.44	0.08
661	1880	Rear EGPRS(2)	Note1	27.58	28.50	0.642	0.79	0.351	0.43	0.05
661	1880	Front GPRS(3)	/	21.08	22.00	0.289	0.36	0.167	0.21	0.11
661	1880	Rear GPRS(3)	/	21.08	22.00	0.613	0.76	0.324	0.40	-0.01
661	1880	Top Edge GPRS(3)	/	21.08	22.00	0.793	0.98	0.42	0.52	-0.04
512	1850.2	Top Edge GPRS(3)	/	21.24	22.00	0.77	0.92	0.395	0.47	0.07
810	1909.8	Top Edge GPRS(3)	/	20.90	22.00	0.785	1.01	0.401	0.52	0.08
810	1909.8	Bottom Edge GPRS(3)	/	20.90	22.00	0.684	0.88	0.365	0.47	-0.08
661	1880	Bottom Edge GPRS(3)	/	21.08	22.00	0.811	1.00	0.458	0.57	-0.11
512	1850.2	Bottom Edge GPRS(3)	Fig.2	21.24	22.00	1.01	1.20	0.574	0.68	0.10
512	1850.2	Bottom Edge EGPRS(3)	/	21.11	22.00	0.965	1.18	0.551	0.68	0.08
810	1909.8	Bottom Edge EGPRS(3)	/	20.90	22.00	0.891	1.15	0.477	0.61	0.10
661	1880	Bottom Edge EGPRS(3)	/	21.08	22.00	0.95	1.17	0.484	0.60	0.12

Note: The distance between the EUT and the phantom bottom is 5mm.

Note1: The distance between the EUT and the phantom bottom is 9mm.

Note2: The distance between the EUT and the phantom bottom is 14mm.

Table 13.1-3: SAR Values (WCDMA850 - Body)

Channel Number	Frequency (MHz)	Test setup	Figure No./ Note	EUT Measured Power (dBm)	Tune up (dBm)	Measured SAR 1g (W/kg)	Calculated SAR 1g (W/kg)	Measured SAR 10g (W/kg)	Calculated SAR 10g (W/kg)	Power Drift
4183	836.6	Front	/	22.38	23.00	0.432	0.50	0.274	0.32	-0.02
4183	836.6	Rear	/	22.38	23.00	0.418	0.48	0.264	0.30	-0.03
4183	836.6	Top Edge	/	22.38	23.00	0.743	0.86	0.483	0.56	0.10
4233	846.6	Top Edge	/	22.24	23.00	0.705	0.84	0.465	0.55	0.08
4132	826.4	Top Edge	/	22.51	23.00	0.718	0.80	0.485	0.54	0.09
4233	846.6	Bottom Edge	Fig.3	22.24	23.00	0.787	0.94	0.506	0.60	-0.04
4183	836.6	Bottom Edge	/	22.38	23.00	0.778	0.90	0.499	0.58	0.10
4132	826.4	Bottom Edge	/	22.51	23.00	0.602	0.67	0.373	0.42	-0.08

Note: The distance between the EUT and the phantom bottom is 5mm.

Table 13.1-4: SAR Values (LTEband5 - Body)

Channel Number	Frequency (MHz)	Test setup	Figure No./ Note	EUT Measured Power (dBm)	Tune up (dBm)	Measured SAR 1g (W/kg)	Calculated SAR 1g (W/kg)	Measured SAR 10g (W/kg)	Calculated SAR 10g (W/kg)	Power Drift
20600	844	1RB-Middle Front	/	22.67	23	0.379	0.41	0.239	0.26	0.03
20600	844	1RB-Middle Rear	/	22.67	23	0.308	0.33	0.201	0.22	0.04
20600	844	1RB-Middle Top Edge	/	22.67	23	0.534	0.58	0.36	0.39	-0.10
20600	844	1RB-Middle Bottom Edge	Fig.4	22.67	23	0.72	0.78	0.46	0.50	-0.01
20450	829	25RB-Middle Front	/	21.41	22	0.283	0.32	0.173	0.20	-0.12
20450	829	25RB-Middle Rear	/	21.41	22	0.263	0.30	0.174	0.20	0.03
20450	829	25RB-Middle Top Edge	/	21.41	22	0.358	0.41	0.231	0.26	0.11
20450	829	25RB-Middle Bottom Edge	/	21.41	22	0.435	0.50	0.289	0.33	-0.01

Note: The distance between the EUT and the phantom bottom is 5mm.

Note1: The LTE mode is QPSK_10MHz.

Table 13.1-6: SAR Values (LTEband40 - Body)

Channel Number	Frequency (MHz)	Test setup	Figure No./ Note	EUT Measured Power (dBm)	Tune up (dBm)	Measured SAR 1g (W/kg)	Calculated SAR 1g (W/kg)	Measured SAR 10g (W/kg)	Calculated SAR 10g (W/kg)	Power Drift
39150	2350	1RB-Middle Front	Note1	23.69	24.5	0.216	0.26	0.129	0.16	-0.03
39150	2350	1RB-Middle Rear	Note1	23.69	24.5	0.534	0.64	0.277	0.33	-0.08
39150	2350	1RB-Middle Top Edge	Note2	23.69	24.5	0.267	0.32	0.156	0.19	0.04
39150	2350	1RB-Middle Bottom Edge	Note2	23.69	24.5	0.261	0.31	0.151	0.18	0.12
39550	2390	50RB-Middle Front	Note1	22.67	23.5	0.12	0.15	0.07	0.08	-0.11
39550	2390	50RB-Middle Rear	Note1	22.67	23.5	0.348	0.42	0.183	0.22	0.07
39550	2390	50RB-Middle Top Edge	Note2	22.67	23.5	0.166	0.20	0.093	0.11	0.09
39550	2390	50RB-Middle Bottom Edge	Note2	22.67	23.5	0.201	0.24	0.111	0.13	0.04
39550	2390	1RB-Middle Front	/	21.34	22.3	0.223	0.28	0.119	0.15	-0.11
39550	2390	1RB-Middle Rear	/	21.34	22.3	0.517	0.65	0.248	0.31	-0.11
39550	2390	1RB-Middle Top Edge	/	21.34	22.3	0.639	0.80	0.307	0.38	-0.08
38750	2310	1RB-Middle Top Edge	/	20.69	22.3	0.605	0.88	0.287	0.42	0.13
39150	2350	1RB-Middle Top Edge	/	21.18	22.3	0.619	0.80	0.291	0.38	0.07
39550	2390	1RB-Middle Bottom Edge	Fig.6	21.34	22.3	0.908	1.13	0.434	0.54	0.06
38750	2310	1RB-Middle Bottom Edge	/	20.69	22.3	0.654	0.95	0.315	0.46	0.05
39150	2350	1RB-Middle Bottom Edge	/	21.18	22.3	0.64	0.83	0.301	0.39	-0.09
39150	2350	50RB-High Front	/	20.14	22.3	0.2	0.33	0.104	0.17	0.08
39150	2350	50RB-High Rear	/	20.14	22.3	0.521	0.86	0.253	0.42	0.07
39550	2390	50RB-High Rear	/	20.13	22.3	0.527	0.87	0.26	0.43	-0.11
38750	2310	50RB-High Rear	/	20.11	22.3	0.501	0.83	0.239	0.40	0.05
39150	2350	50RB-High Top Edge	/	20.14	22.3	0.454	0.75	0.231	0.38	-0.09
39150	2350	50RB-High Bottom Edge	/	20.14	22.3	0.605	0.99	0.303	0.50	-0.04
39550	2390	50RB-High Bottom Edge	/	20.13	22.3	0.571	0.94	0.284	0.47	0.08
38750	2310	50RB-High Bottom Edge	/	20.11	22.3	0.59	0.98	0.274	0.45	0.09

Note: The distance between the EUT and the phantom bottom is 5mm.

Note1: The distance between the EUT and the phantom bottom is 9mm.

Note2: The distance between the EUT and the phantom bottom is 14mm.

Note3: The LTE mode is QPSK_20MHz.

13.2 SAR results for Standard procedure

There is zoom scan measurement to be added for the highest measured SAR in each exposure configuration/band.

Test Band	Channel	Frequency	Tune-Up	Measured Power	Test Position	Measured 10g SAR	Measured 1g SAR	Reported 10g SAR	Reported 1g SAR	Power Drift	Figure
GSM850	190	836.6	32	31.36752	Bottom Edge 5mm	0.68	1.06	0.79	1.23	-0.03	Fig A.1
WCDMA850-BV	4233	846.6	23	22.24	Bottom Edge 5mm	0.506	0.787	0.60	0.94	-0.04	Fig A.3
LTE850-FDD5	20600	844 MHz	23	22.6709	Bottom Edge 5mm	0.46	0.72	0.50	0.78	-0.01	Fig A.4
LTE800-FDD19	24075	837.5 MHz	23	22.27338	Bottom Edge 5mm	0.359	0.569	0.42	0.67	-0.03	Fig A.5
LTE2300-TDD40	39550	2390 MHz	22.3	21.33899	Bottom Edge 5mm	0.434	0.908	0.54	1.13	0.06	Fig A.6

14 SAR Measurement Variability

SAR measurement variability must be assessed for each frequency band, which is determined by the SAR probe calibration point and tissue-equivalent medium used for the device measurements. When both head and body tissue-equivalent media are required for SAR measurements in a frequency band, the variability measurement procedures should be applied to the tissue medium with the highest measured SAR, using the highest measured SAR configuration for that tissue-equivalent medium.

The following procedures are applied to determine if repeated measurements are required.

- 1) Repeated measurement is not required when the original highest measured SAR is < 0.80 W/kg; steps 2) through 4) do not apply.
- 2) When the original highest measured SAR is ≥ 0.80 W/kg, repeat that measurement once.
- 3) Perform a second repeated measurement only if the ratio of largest to smallest SAR for the original and first repeated measurements is > 1.20 or when the original or repeated measurement is ≥ 1.45 W/kg ($\sim 10\%$ from the 1-g SAR limit).
- 4) Perform a third repeated measurement only if the original, first or second repeated measurement is ≥ 1.5 W/kg and the ratio of largest to smallest SAR for the original, first and second repeated measurements is > 1.20

Table 14.1: SAR Measurement Variability for Body GSM850 (1g)

Channel Number	Frequency (MHz)	Test setup	Spacing (mm)	Original SAR (W/kg)	First Repeated SAR (W/kg)	The Ratio	Second Repeated SAR (W/kg)
190	836.6	Top Edge GPRS(2)	5	1.14	1.09	1.05	/
251	848.8	Top Edge GPRS(2)	5	1.09	1.02	1.07	/
128	824.2	Top Edge GPRS(2)	5	1.13	1.09	1.04	/
251	848.8	Bottom Edge GPRS(2)	5	0.96	0.89	1.08	/
190	836.6	Bottom Edge GPRS(2)	5	1.23	1.18	1.04	/
128	824.2	Bottom Edge GPRS(2)	5	1.16	1.10	1.05	/
190	836.6	Bottom Edge EGPRS(2)	5	1.19	1.12	1.06	/
251	848.8	Bottom Edge EGPRS(2)	5	1.08	0.99	1.09	/
128	824.2	Bottom Edge EGPRS(2)	5	1.18	1.09	1.08	/

Table 14.2: SAR Measurement Variability for Body GSM1900 (1g)

Channel Number	Frequency (MHz)	Test setup	Spacing (mm)	Original SAR (W/kg)	First Repeated SAR (W/kg)	The Ratio	Second Repeated SAR (W/kg)
661	1880	Top Edge GPRS(3)	5	0.98	0.92	1.06	/
512	1850.2	Top Edge GPRS(3)	5	0.92	0.85	1.08	/
810	1909.8	Top Edge GPRS(3)	5	1.01	0.94	1.07	/
810	1909.8	Bottom Edge GPRS(3)	5	0.88	0.81	1.09	/
661	1880	Bottom Edge GPRS(3)	5	1.00	0.94	1.07	/
512	1850.2	Bottom Edge GPRS(3)	5	1.20	1.05	1.15	/
512	1850.2	Bottom Edge EGPRS(3)	5	1.18	1.05	1.13	/
810	1909.8	Bottom Edge EGPRS(3)	5	1.15	1.08	1.06	/
661	1880	Bottom Edge EGPRS(3)	5	1.17	1.02	1.15	/

Table 14.3: SAR Measurement Variability for Body LTE band40 (1g)

Channel Number	Frequency (MHz)	Test setup	Spacing (mm)	Original SAR (W/kg)	First Repeated SAR (W/kg)	The Ratio	Second Repeated SAR (W/kg)
39550	2390	1RB-Middle Top Edge	5	0.80	0.74	1.08	/
38750	2310	1RB-Middle Top Edge	5	0.88	0.81	1.08	/
39150	2350	1RB-Middle Top Edge	5	0.80	0.75	1.07	/
39550	2390	1RB-Middle Bottom Edge	5	1.13	1.06	1.07	/
38750	2310	1RB-Middle Bottom Edge	5	0.95	0.90	1.05	/
39150	2350	1RB-Middle Bottom Edge	5	0.83	0.79	1.05	/
39150	2350	50RB-High Rear	5	0.86	0.80	1.07	/
39550	2390	50RB-High Rear	5	0.87	0.81	1.07	/
38750	2310	50RB-High Rear	5	0.83	0.80	1.04	/
39150	2350	50RB-High Bottom Edge	5	0.99	0.92	1.08	/
39550	2390	50RB-High Bottom Edge	5	0.94	0.89	1.06	/
38750	2310	50RB-High Bottom Edge	5	0.98	0.91	1.07	/

15 Measurement Uncertainty

15.1 Measurement Uncertainty for Normal SAR Tests (300MHz~3GHz)

No.	Error Description	Type	Uncertainty value	Probably Distribution	Div.	(Ci) 1g	(Ci) 10g	Std. Unc. (1g)	Std. Unc. (10g)	Degree of freedom
Measurement system										
1	Probe calibration	B	6.0	N	1	1	1	6.0	6.0	∞
2	Isotropy	B	4.7	R	$\sqrt{3}$	0.7	0.7	1.9	1.9	∞
3	Boundary effect	B	1.0	R	$\sqrt{3}$	1	1	0.6	0.6	∞
4	Linearity	B	4.7	R	$\sqrt{3}$	1	1	2.7	2.7	∞
5	Detection limit	B	1.0	N	1	1	1	0.6	0.6	∞
6	Readout electronics	B	0.3	R	$\sqrt{3}$	1	1	0.3	0.3	∞
7	Response time	B	0.8	R	$\sqrt{3}$	1	1	0.5	0.5	∞
8	Integration time	B	2.6	R	$\sqrt{3}$	1	1	1.5	1.5	∞
9	RF ambient conditions-noise	B	0	R	$\sqrt{3}$	1	1	0	0	∞
10	RF ambient conditions-reflection	B	0	R	$\sqrt{3}$	1	1	0	0	∞
11	Probe positioned mech. restrictions	B	0.4	R	$\sqrt{3}$	1	1	0.2	0.2	∞
12	Probe positioning with respect to phantom shell	B	2.9	R	$\sqrt{3}$	1	1	1.7	1.7	∞
13	Post-processing	B	1.0	R	$\sqrt{3}$	1	1	0.6	0.6	∞
Test sample related										
14	Test sample positioning	A	3.3	N	1	1	1	3.3	3.3	71
15	Device holder uncertainty	A	3.4	N	1	1	1	3.4	3.4	5
16	Drift of output power	B	5.0	R	$\sqrt{3}$	1	1	2.9	2.9	∞
Phantom and set-up										
17	Phantom uncertainty	B	4.0	R	$\sqrt{3}$	1	1	2.3	2.3	∞
18	Liquid conductivity (target)	B	5.0	R	$\sqrt{3}$	0.64	0.43	1.8	1.2	∞
19	Liquid conductivity (meas.)	A	2.06	N	1	0.64	0.43	1.32	0.89	43
20	Liquid permittivity (target)	B	5.0	R	$\sqrt{3}$	0.6	0.49	1.7	1.4	∞
21	Liquid permittivity (meas.)	A	1.6	N	1	0.6	0.49	1.0	0.8	521

Combined standard uncertainty	$u_c = \sqrt{\sum_{i=1}^{21} c_i^2 u_i^2}$							9.55	9.43	257
Expanded uncertainty (confidence interval of 95 %)	$u_e = 2u_c$							19.1	18.9	

15.2 Measurement Uncertainty for Normal SAR Tests (3~6GHz)

No.	Error Description	Type	Uncertainty value	Probably Distribution	Div.	(Ci) 1g	(Ci) 10g	Std. Unc. (1g)	Std. Unc. (10g)	Degree of freedom
Measurement system										
1	Probe calibration	B	6.55	N	1	1	1	6.55	6.55	∞
2	Isotropy	B	4.7	R	$\sqrt{3}$	0.7	0.7	1.9	1.9	∞
3	Boundary effect	B	2.0	R	$\sqrt{3}$	1	1	1.2	1.2	∞
4	Linearity	B	4.7	R	$\sqrt{3}$	1	1	2.7	2.7	∞
5	Detection limit	B	1.0	R	$\sqrt{3}$	1	1	0.6	0.6	∞
6	Readout electronics	B	0.3	R	$\sqrt{3}$	1	1	0.3	0.3	∞
7	Response time	B	0.8	R	$\sqrt{3}$	1	1	0.5	0.5	∞
8	Integration time	B	2.6	R	$\sqrt{3}$	1	1	1.5	1.5	∞
9	RF ambient conditions-noise	B	0	R	$\sqrt{3}$	1	1	0	0	∞
10	RFambient conditions-reflection	B	0	R	$\sqrt{3}$	1	1	0	0	∞
11	Probe positioned mech. restrictions	B	0.8	R	$\sqrt{3}$	1	1	0.5	0.5	∞
12	Probe positioning with respect to phantom shell	B	6.7	R	$\sqrt{3}$	1	1	3.9	3.9	∞
13	Post-processing	B	4.0	R	$\sqrt{3}$	1	1	2.3	2.3	∞
Test sample related										
14	Test sample positioning	A	3.3	N	1	1	1	3.3	3.3	71
15	Device holder uncertainty	A	3.4	N	1	1	1	3.4	3.4	5
16	Drift of output power	B	5.0	R	$\sqrt{3}$	1	1	2.9	2.9	∞
Phantom and set-up										
17	Phantom uncertainty	B	4.0	R	$\sqrt{3}$	1	1	2.3	2.3	∞
18	Liquid conductivity (target)	B	5.0	R	$\sqrt{3}$	0.64	0.43	1.8	1.2	∞
19	Liquid conductivity (meas.)	A	2.06	N	1	0.64	0.43	1.32	0.89	43
20	Liquid permittivity (target)	B	5.0	R	$\sqrt{3}$	0.6	0.49	1.7	1.4	∞

21	Liquid permittivity (meas.)	A	1.6	N	1	0.6	0.49	1.0	0.8	521
Combined standard uncertainty		$u_c' = \sqrt{\sum_{i=1}^{21} c_i^2 u_i^2}$						10.7	10.6	257
Expanded uncertainty (confidence interval of 95 %)		$u_e = 2u_c$						21.4	21.1	

15.3 Measurement Uncertainty for Fast SAR Tests (300MHz~3GHz)

No.	Error Description	Type	Uncertainty value	Probably Distribution	Div.	(Ci) 1g	(Ci) 10g	Std. Unc. (1g)	Std. Unc. (10g)	Degree of freedom
Measurement system										
1	Probe calibration	B	6.0	N	1	1	1	6.0	6.0	∞
2	Isotropy	B	4.7	R	$\sqrt{3}$	0.7	0.7	1.9	1.9	∞
3	Boundary effect	B	1.0	R	$\sqrt{3}$	1	1	0.6	0.6	∞
4	Linearity	B	4.7	R	$\sqrt{3}$	1	1	2.7	2.7	∞
5	Detection limit	B	1.0	R	$\sqrt{3}$	1	1	0.6	0.6	∞
6	Readout electronics	B	0.3	R	$\sqrt{3}$	1	1	0.3	0.3	∞
7	Response time	B	0.8	R	$\sqrt{3}$	1	1	0.5	0.5	∞
8	Integration time	B	2.6	R	$\sqrt{3}$	1	1	1.5	1.5	∞
9	RF ambient conditions-noise	B	0	R	$\sqrt{3}$	1	1	0	0	∞
10	RFambient conditions-reflection	B	0	R	$\sqrt{3}$	1	1	0	0	∞
11	Probe positioned mech. Restrictions	B	0.4	R	$\sqrt{3}$	1	1	0.2	0.2	∞
12	Probe positioning with respect to phantom shell	B	2.9	R	$\sqrt{3}$	1	1	1.7	1.7	∞
13	Post-processing	B	1.0	R	$\sqrt{3}$	1	1	0.6	0.6	∞
14	Fast SAR z-Approximation	B	7.0	R	$\sqrt{3}$	1	1	4.0	4.0	∞
Test sample related										
15	Test sample positioning	A	3.3	N	1	1	1	3.3	3.3	71
16	Device holder uncertainty	A	3.4	N	1	1	1	3.4	3.4	5
17	Drift of output power	B	5.0	R	$\sqrt{3}$	1	1	2.9	2.9	∞
Phantom and set-up										
18	Phantom uncertainty	B	4.0	R	$\sqrt{3}$	1	1	2.3	2.3	∞
19	Liquid conductivity (target)	B	5.0	R	$\sqrt{3}$	0.64	0.43	1.8	1.2	∞

20	Liquid conductivity (meas.)	A	2.06	N	1	0.64	0.43	1.32	0.89	43
21	Liquid permittivity (target)	B	5.0	R	$\sqrt{3}$	0.6	0.49	1.7	1.4	∞
22	Liquid permittivity (meas.)	A	1.6	N	1	0.6	0.49	1.0	0.8	521
Combined standard uncertainty		$u_c = \sqrt{\sum_{i=1}^{22} c_i^2 u_i^2}$						10.4	10.3	257
Expanded uncertainty (confidence interval of 95 %)		$u_e = 2u_c$						20.8	20.6	

15.4 Measurement Uncertainty for Fast SAR Tests (3~6GHz)

No.	Error Description	Type	Uncertainty value	Probably Distribution	Div.	(Ci) 1g	(Ci) 10g	Std. Unc. (1g)	Std. Unc. (10g)	Degree of freedom
Measurement system										
1	Probe calibration	B	6.55	N	1	1	1	6.55	6.55	∞
2	Isotropy	B	4.7	R	$\sqrt{3}$	0.7	0.7	1.9	1.9	∞
3	Boundary effect	B	2.0	R	$\sqrt{3}$	1	1	1.2	1.2	∞
4	Linearity	B	4.7	R	$\sqrt{3}$	1	1	2.7	2.7	∞
5	Detection limit	B	1.0	R	$\sqrt{3}$	1	1	0.6	0.6	∞
6	Readout electronics	B	0.3	R	$\sqrt{3}$	1	1	0.3	0.3	∞
7	Response time	B	0.8	R	$\sqrt{3}$	1	1	0.5	0.5	∞
8	Integration time	B	2.6	R	$\sqrt{3}$	1	1	1.5	1.5	∞
9	RF ambient conditions-noise	B	0	R	$\sqrt{3}$	1	1	0	0	∞
10	RF ambient conditions-reflection	B	0	R	$\sqrt{3}$	1	1	0	0	∞
11	Probe positioned mech. Restrictions	B	0.8	R	$\sqrt{3}$	1	1	0.5	0.5	∞
12	Probe positioning with respect to phantom shell	B	6.7	R	$\sqrt{3}$	1	1	3.9	3.9	∞
13	Post-processing	B	1.0	R	$\sqrt{3}$	1	1	0.6	0.6	∞
14	Fast SAR z-Approximation	B	14.0	R	$\sqrt{3}$	1	1	8.1	8.1	∞
Test sample related										
15	Test sample positioning	A	3.3	N	1	1	1	3.3	3.3	71
16	Device holder uncertainty	A	3.4	N	1	1	1	3.4	3.4	5
17	Drift of output power	B	5.0	R	$\sqrt{3}$	1	1	2.9	2.9	∞

Phantom and set-up										
18	Phantom uncertainty	B	4.0	R	$\sqrt{3}$	1	1	2.3	2.3	∞
19	Liquid conductivity (target)	B	5.0	R	$\sqrt{3}$	0.64	0.43	1.8	1.2	∞
20	Liquid conductivity (meas.)	A	2.06	N	1	0.64	0.43	1.32	0.89	43
21	Liquid permittivity (target)	B	5.0	R	$\sqrt{3}$	0.6	0.49	1.7	1.4	∞
22	Liquid permittivity (meas.)	A	1.6	N	1	0.6	0.49	1.0	0.8	521
Combined standard uncertainty		$u_c = \sqrt{\sum_{i=1}^{22} c_i^2 u_i^2}$						13.5	13.4	257
Expanded uncertainty (confidence interval of 95 %)		$u_e = 2u_c$						27.0	26.8	

16 MAIN TEST INSTRUMENTS

Table 16.1: List of Main Instruments

No.	Name	Type	Serial Number	Calibration Date	Valid Period
01	Network analyzer	E5071C	MY46110673	January 24, 2019	One year
02	Power meter	NRP2	106277	September 4, 2019	One year
03	Power sensor	NRP8S	104291		
04	Power sensor	NRP6A	101369	April 11, 2019	One Year
05	Signal Generator	E4438C	MY49070393	January 4, 2019	One Year
06	Amplifier	60S1G4	0331848	No Calibration Requested	
07	Directional Coupler	778D	MY48220584	No Calibration Requested	
08	Directional Coupler	772D	MY46151265	No Calibration Requested	
09	BTS	E5515C	MY50263375	January 17, 2019	One year
10	BTS	CMW500	159890	January 3, 2019	One year
11	E-field Probe	SPEAG EX3DV4	3617	January 31, 2019	One year
12	DAE	SPEAG DAE4	771	January 11,2019	One year
13	Dipole Validation Kit	SPEAG D835V2	4d069	July 18, 2019	One year
14	Dipole Validation Kit	SPEAG D1900V2	5d101	July 17, 2019	One year
15	Dipole Validation Ki	SPEAG D2300V2	1018	July 17, 2019	One year

END OF REPORT BODY

ANNEX A Graph Results

GSM850_CH190 Bottom Edge 5mm

Date: 11/20/2019

Electronics: DAE4 Sn771

Medium: body 835 MHz

Medium parameters used: $f = 836.6$; $\sigma = 0.975$ mho/m; $\epsilon_r = 55.11$; $\rho = 1000$ kg/m³

Ambient Temperature: 22.5°C, Liquid Temperature: 22.3°C

Communication System: GSM850 836.6 Duty Cycle: 1:4

Probe: EX3DV4 – SN3617 ConvF(9.61,9.61,9.61)

Area Scan (71x121x1): Interpolated grid: $dx=1.000$ mm, $dy=1.000$ mm

Maximum value of SAR (interpolated) = 1.53 W/kg

Zoom Scan (7x7x7)/Cube 0: Measurement grid: $dx=5$ mm, $dy=5$ mm, $dz=5$ mm

Reference Value = 31.8 V/m; Power Drift = -0.03 dB

Peak SAR (extrapolated) = 2.39 W/kg

SAR(1 g) = 1.06 W/kg; SAR(10 g) = 0.68 W/kg

Maximum value of SAR (measured) = 1.47 W/kg

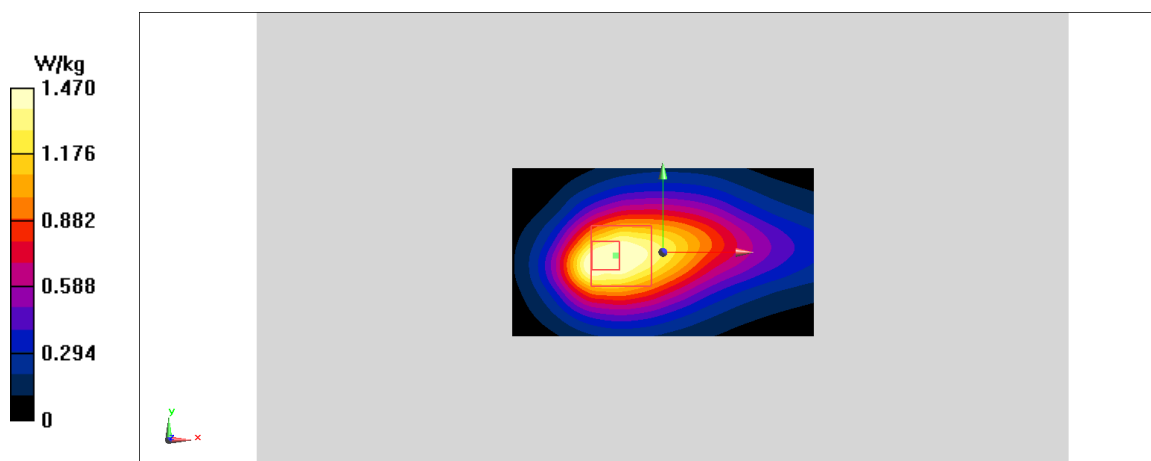

Fig A.1

PCS1900_CH512 Bottom Edge 5mm

Date: 11/21/2019

Electronics: DAE4 Sn771

Medium: body 1900 MHz

Medium parameters used: $f = 1850.2$; $\sigma = 1.472$ mho/m; $\epsilon_r = 53.28$; $\rho = 1000$ kg/m³

Ambient Temperature: 22.5°C, Liquid Temperature: 22.3°C

Communication System: PCS1900 1850.2 Duty Cycle: 1:2.67

Probe: EX3DV4 – SN3617 ConvF(7.78,7.78,7.78)

Area Scan (71x121x1): Interpolated grid: dx=1.000 mm, dy=1.000 mm

Maximum value of SAR (interpolated) = 1.47 W/kg

Zoom Scan (7x7x7)/Cube 0: Measurement grid: dx=5mm, dy=5mm, dz=5mm

Reference Value = 25.95 V/m; Power Drift = 0.1 dB

Peak SAR (extrapolated) = 1.7 W/kg

SAR(1 g) = 1.01 W/kg; SAR(10 g) = 0.574 W/kg

Maximum value of SAR (measured) = 1.45 W/kg

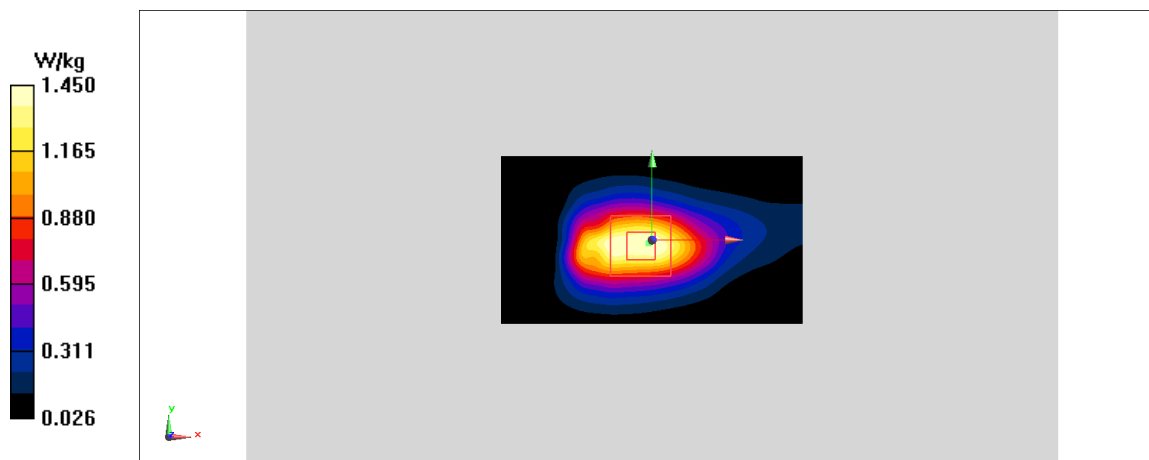
**Fig A.2**

WCDMA850-BV_CH4233 Bottom Edge 5mm

Date: 11/20/2019

Electronics: DAE4 Sn771

Medium: body 835 MHz

Medium parameters used: $f = 846.6$; $\sigma = 0.984$ mho/m; $\epsilon_r = 55.1$; $\rho = 1000$ kg/m³

Ambient Temperature: 22.5°C, Liquid Temperature: 22.3°C

Communication System: WCDMA850-BV 846.6 Duty Cycle: 1:1

Probe: EX3DV4 – SN3617 ConvF(9.61,9.61,9.61)

Area Scan (71x121x1): Interpolated grid: dx=1.000 mm, dy=1.000 mm

Maximum value of SAR (interpolated) = 1.19 W/kg

Zoom Scan (7x7x7)/Cube 0: Measurement grid: dx=5mm, dy=5mm, dz=5mm

Reference Value = 29.45 V/m; Power Drift = -0.04 dB

Peak SAR (extrapolated) = 1.29 W/kg

SAR(1 g) = 0.787 W/kg; SAR(10 g) = 0.506 W/kg

Maximum value of SAR (measured) = 1.08 W/kg

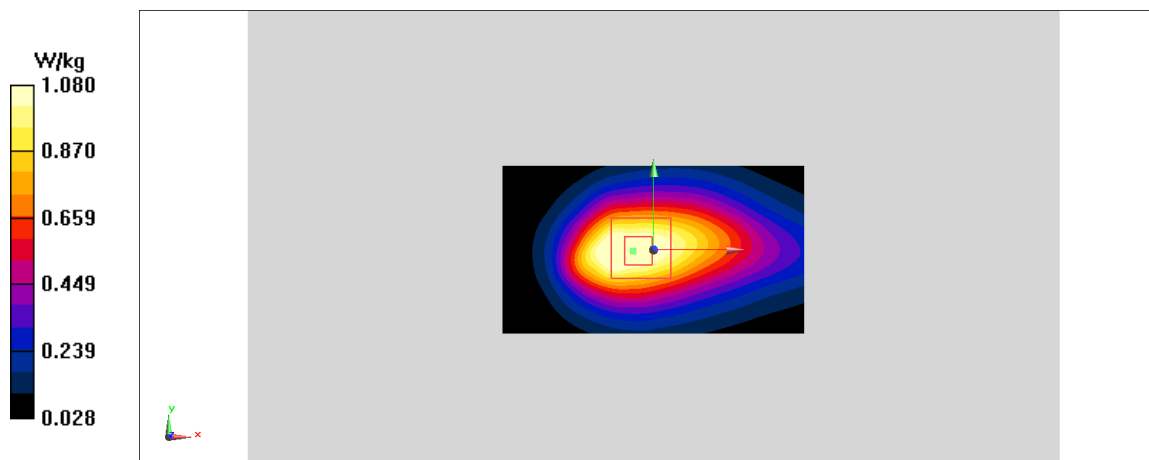
**Fig A.3**

LTE850-FDD5_CH20600 Bottom Edge 5mm

Date: 11/20/2019

Electronics: DAE4 Sn771

Medium: body 835 MHz

Medium parameters used: $f = 844$ MHz; $\sigma = 0.982$ mho/m; $\epsilon_r = 55.1$; $\rho = 1000$ kg/m³

Ambient Temperature: 22.5°C, Liquid Temperature: 22.3°C

Communication System: LTE850-FDD5 844 MHz Duty Cycle: 1:1

Probe: EX3DV4 – SN3617 ConvF(9.61,9.61,9.61)

Area Scan (71x121x1): Interpolated grid: dx=1.000 mm, dy=1.000 mm

Maximum value of SAR (interpolated) = 1.08 W/kg

Zoom Scan (7x7x7)/Cube 0: Measurement grid: dx=5mm, dy=5mm, dz=5mm

Reference Value = 30.29 V/m; Power Drift = -0.01 dB

Peak SAR (extrapolated) = 1.22 W/kg

SAR(1 g) = 0.72 W/kg; SAR(10 g) = 0.46 W/kg

Maximum value of SAR (measured) = 1.03 W/kg

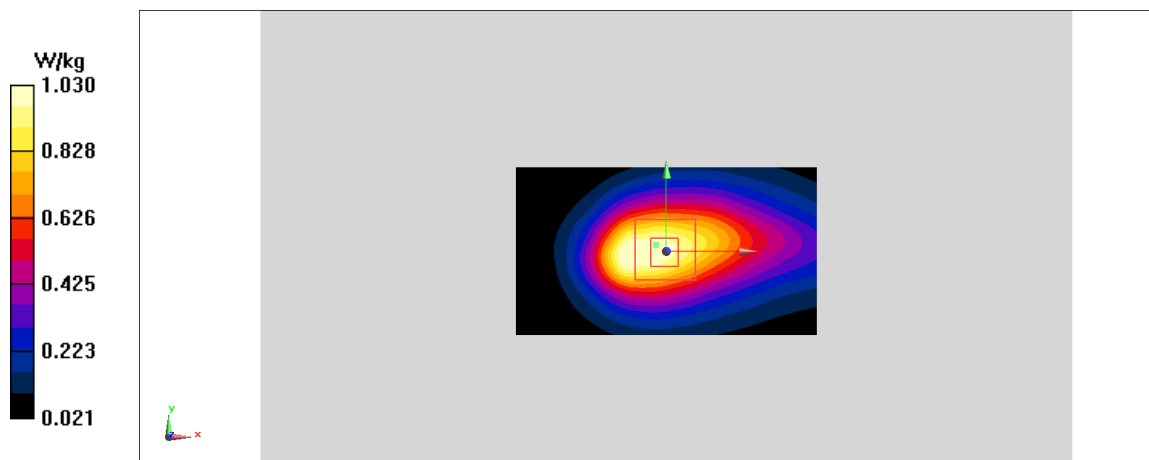
**Fig A.4**

LTE2300-TDD40_CH39550 Bottom Edge 5mm

Date: 11/22/2019

Electronics: DAE4 Sn771

Medium: body 2300 MHz

Medium parameters used: $f = 2390$ MHz; $\sigma = 1.888$ mho/m; $\epsilon_r = 53.39$; $\rho = 1000$ kg/m³

Ambient Temperature: 22.5°C, Liquid Temperature: 22.3°C

Communication System: LTE2300-TDD40 2390 MHz Duty Cycle: 1:1.58

Probe: EX3DV4 – SN3617 ConvF(7.84,7.84,7.84)

Area Scan (71x121x1): Interpolated grid: dx=1.000 mm, dy=1.000 mm

Maximum value of SAR (interpolated) = 1.71 W/kg

Zoom Scan (7x7x7)/Cube 0: Measurement grid: dx=5mm, dy=5mm, dz=5mm

Reference Value = 16.65 V/m; Power Drift = 0.06 dB

Peak SAR (extrapolated) = 1.87 W/kg

SAR(1 g) = 0.908 W/kg; SAR(10 g) = 0.434 W/kg

Maximum value of SAR (measured) = 1.49 W/kg

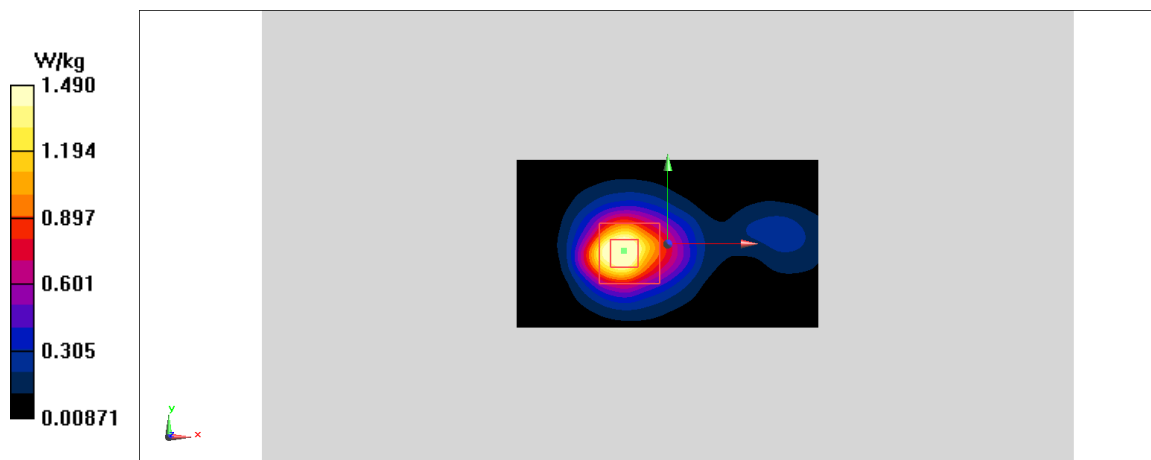

Fig A.6

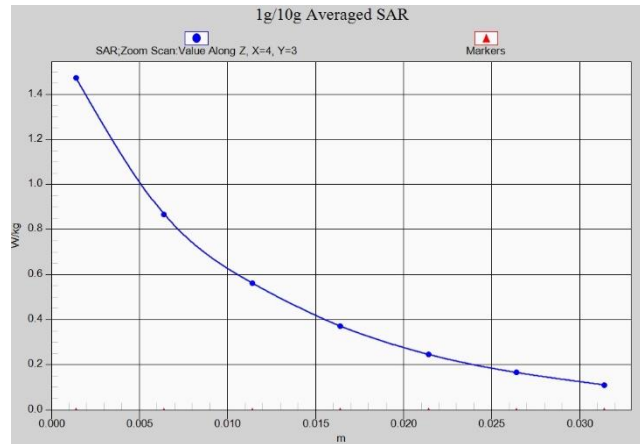

Fig. 1-1 Z-Scan at power reference point (GSM850 Body)

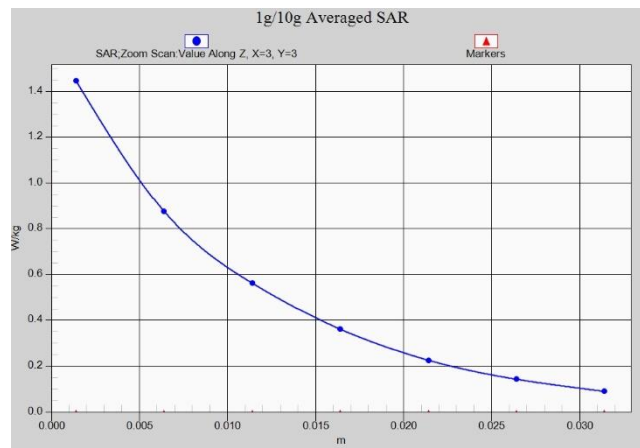

Fig. 1-2 Z-Scan at power reference point (GSM1900 Body)

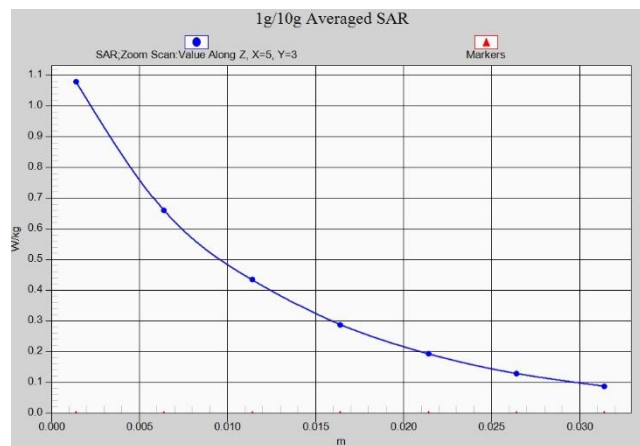

Fig. 1-3 Z-Scan at power reference point (WCDMA850 Body)

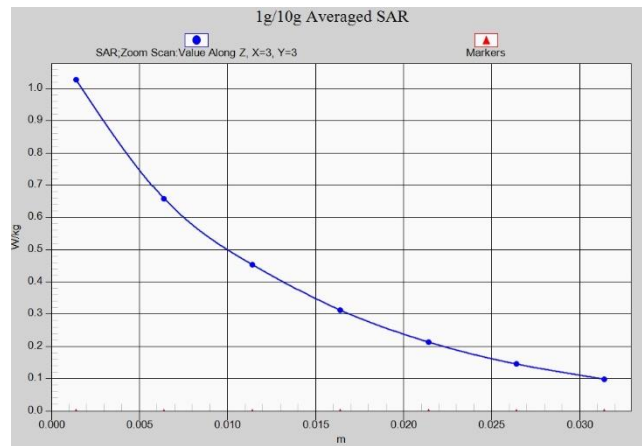

Fig. 1-4 Z-Scan at power reference point (LTE band5 Body)

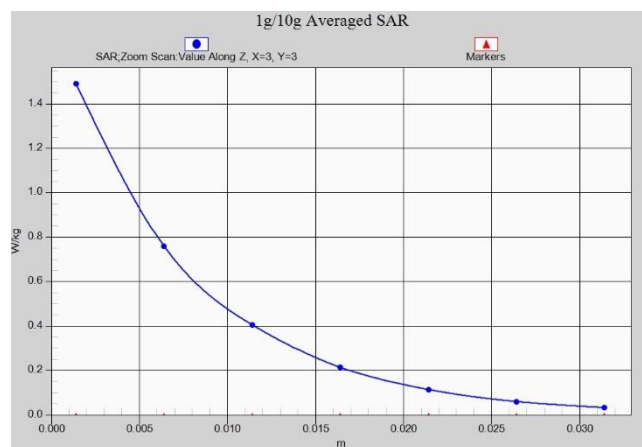

Fig. 1-6 Z-Scan at power reference point (LTE band40 Body)

ANNEX B System Verification Results

835 MHz

Date: 11/20/2019

Electronics: DAE4 Sn771

Medium: Body 835 MHz

Medium parameters used: $f = 835 \text{ MHz}$; $\sigma = 0.973 \text{ mho/m}$; $\epsilon_r = 55.11$; $\rho = 1000 \text{ kg/m}^3$

Ambient Temperature: 22.5°C Liquid Temperature: 22.3°C

Communication System: CW Frequency: 835 MHz Duty Cycle: 1:1

Probe: EX3DV4 – SN3617 ConvF(9.61,9.61,9.61)

System Validation /Area Scan (81x191x1): Interpolated grid: $dx=1.000 \text{ mm}$, $dy=1.000 \text{ mm}$

Reference Value = 57.26 V/m ; Power Drift = -0.02

Fast SAR: SAR(1 g) = 2.43 W/kg ; SAR(10 g) = 1.55 W/kg

Maximum value of SAR (interpolated) = 3.4 W/kg

System Validation /Zoom Scan (7x7x7)/Cube 0: Measurement grid: $dx=5\text{mm}$, $dy=5\text{mm}$, $dz=5\text{mm}$

Reference Value = 57.26 V/m ; Power Drift = -0.02 dB

Peak SAR (extrapolated) = 3.71 W/kg

SAR(1 g) = 2.44 W/kg ; SAR(10 g) = 1.6 W/kg

Maximum value of SAR (measured) = 3.29 W/kg

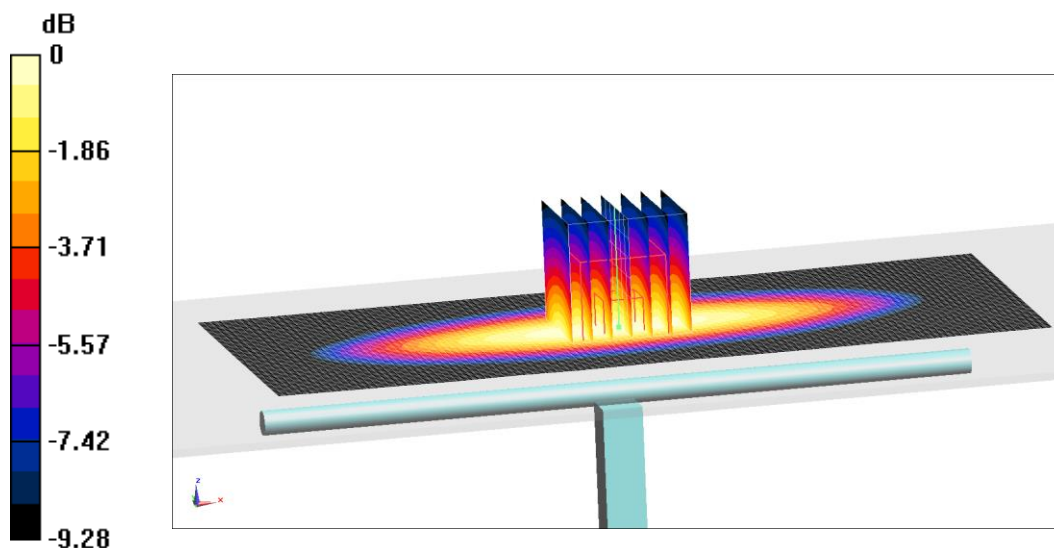

$0 \text{ dB} = 3.29 \text{ W/kg} = 5.17 \text{ dB W/kg}$

Fig.B.1 validation 835 MHz 250mW

1900 MHz

Date: 11/21/2019

Electronics: DAE4 Sn771

Medium: Body 1900 MHz

Medium parameters used: $f = 1900$ MHz; $\sigma = 1.52$ mho/m; $\epsilon_r = 53.22$; $\rho = 1000$ kg/m³

Ambient Temperature: 22.5°C Liquid Temperature: 22.3°C

Communication System: CW Frequency: 1900 MHz Duty Cycle: 1:1

Probe: EX3DV4 – SN3617 ConvF(7.78,7.78,7.78)

System Validation /Area Scan (81x191x1): Interpolated grid: dx=1.000 mm, dy=1.000 mm

Reference Value = 103.9 V/m; Power Drift = -0.09

Fast SAR: SAR(1 g) = 9.88 W/kg; SAR(10 g) = 5.22 W/kg

Maximum value of SAR (interpolated) = 16.9 W/kg

System Validation /Zoom Scan (7x7x7)/Cube 0: Measurement grid: dx=5mm, dy=5mm, dz=5mm

Reference Value = 103.9 V/m; Power Drift = -0.09 dB

Peak SAR (extrapolated) = 17.63 W/kg

SAR(1 g) = 9.91 W/kg; SAR(10 g) = 5.25 W/kg

Maximum value of SAR (measured) = 14.5 W/kg

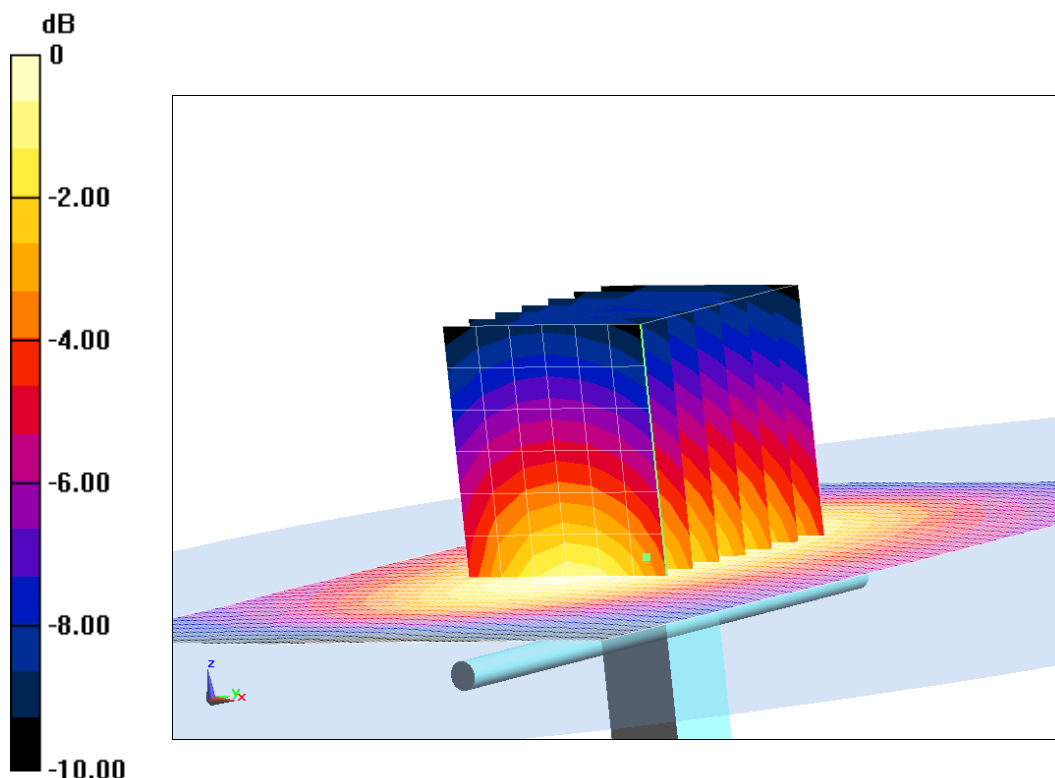

0 dB = 14.5 W/kg = 11.61 dB W/kg

Fig.B.2 validation 1900 MHz 250mW

2300 MHz

Date: 11/22/2019

Electronics: DAE4 Sn771

Medium: Body 2300 MHz

Medium parameters used: $f = 2300$ MHz; $\sigma = 1.802$ mho/m; $\epsilon_r = 53.5$; $\rho = 1000$ kg/m³

Ambient Temperature: 22.5°C Liquid Temperature: 22.3°C

Communication System: CW Frequency: 2300 MHz Duty Cycle: 1:1

Probe: EX3DV4 – SN3617 ConvF(7.84,7.84,7.84)

System Validation /Area Scan (81x191x1): Interpolated grid: dx=1.000 mm, dy=1.000 mm

Reference Value = 108.49 V/m; Power Drift = 0.07

Fast SAR: SAR(1 g) = 11.61 W/kg; SAR(10 g) = 5.64 W/kg

Maximum value of SAR (interpolated) = 19.24 W/kg

System Validation /Zoom Scan (7x7x7)/Cube 0: Measurement grid: dx=5mm, dy=5mm, dz=5mm

Reference Value = 108.49 V/m; Power Drift = 0.07 dB

Peak SAR (extrapolated) = 22.34 W/kg

SAR(1 g) = 11.82 W/kg; SAR(10 g) = 5.74 W/kg

Maximum value of SAR (measured) = 18.58 W/kg

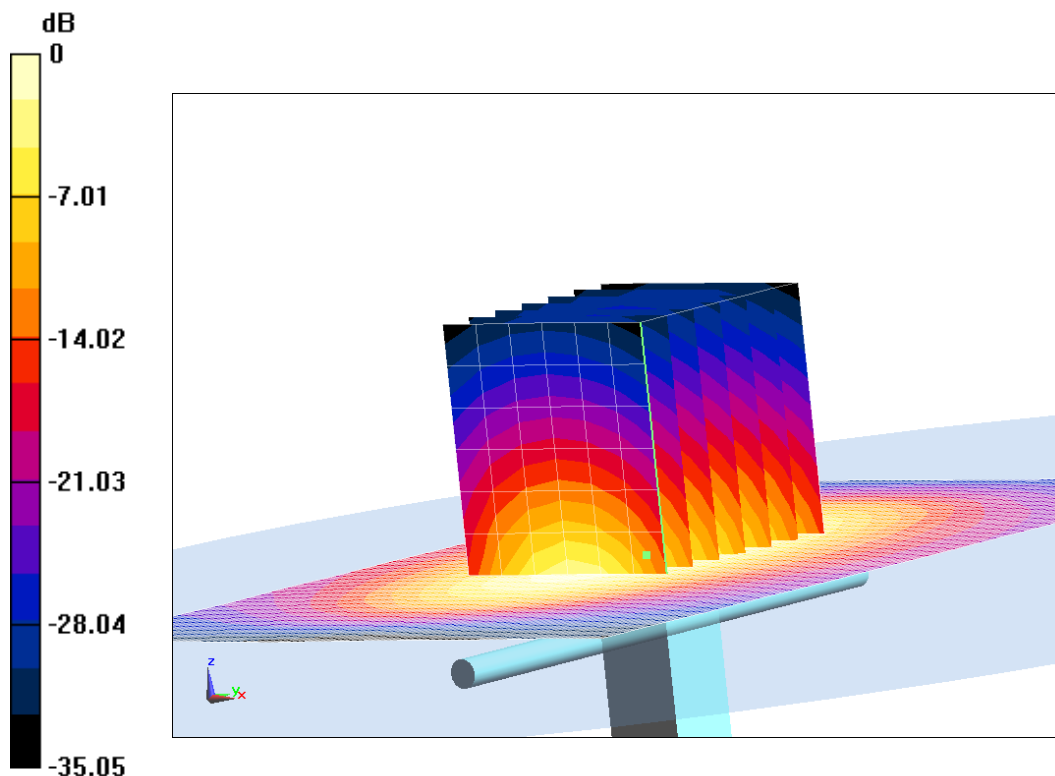

0 dB = 18.58 W/kg = 12.69 dB W/kg

Fig.B.3 validation 2300 MHz 250mW



The SAR system verification must be required that the area scan estimated 1-g SAR is within 3% of the zoom scan 1-g SAR.

Table B.1 Comparison between area scan and zoom scan for system verification

Date	Band	Position	Area scan (1g)	Zoom scan (1g)	Drift (%)
2019/11/20	835	Body	2.43	2.44	-0.41
2019/11/21	1900	Body	9.88	9.91	-0.30
2019/11/22	2300	Body	13.53	13.77	-1.74

ANNEX C SAR Measurement Setup

C.1 Measurement Set-up

The Dasy4 or DASY5 system for performing compliance tests is illustrated above graphically. This system consists of the following items:

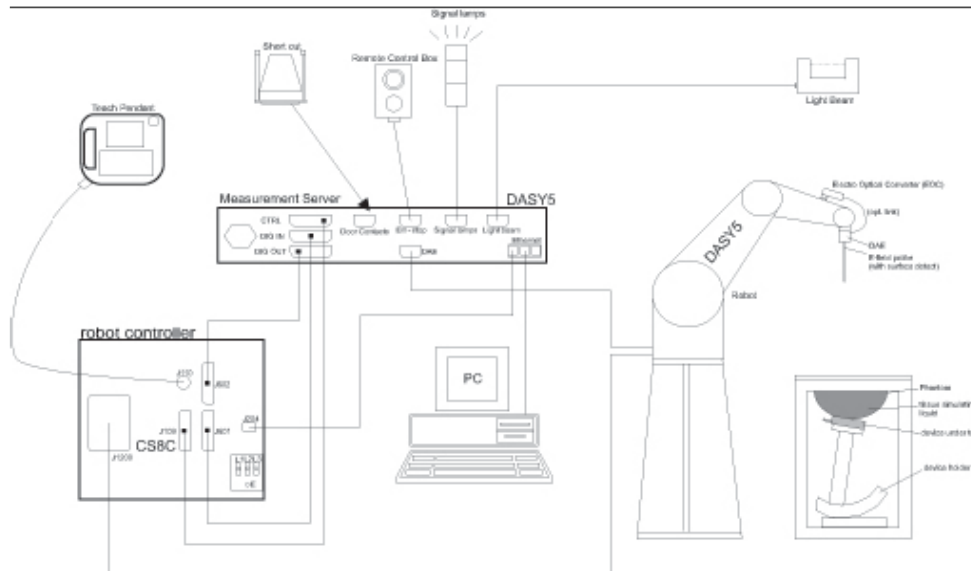

Picture C.1 SAR Lab Test Measurement Set-up

- A standard high precision 6-axis robot (Stäubli TX=RX family) with controller, teach pendant and software. An arm extension for accommodating the data acquisition electronics (DAE).
- An isotropic field probe optimized and calibrated for the targeted measurement.
- A data acquisition electronics (DAE) which performs the signal amplification, signal multiplexing, AD-conversion, offset measurements, mechanical surface detection, collision detection, etc. The unit is battery powered with standard or rechargeable batteries. The signal is optically transmitted to the EOC.
- The Electro-optical converter (EOC) performs the conversion from optical to electrical signals for the digital communication to the DAE. To use optical surface detection, a special version of the EOC is required. The EOC signal is transmitted to the measurement server.
- The function of the measurement server is to perform the time critical tasks such as signal filtering, control of the robot operation and fast movement interrupts.
- The Light Beam used is for probe alignment. This improves the (absolute) accuracy of the probe positioning.
- A computer running WinXP and the DASY4 or DASY5 software.
- Remote control and teach pendant as well as additional circuitry for robot safety such as
- warning lamps, etc.
- The phantom, the device holder and other accessories according to the targeted measurement.

C.2 Dasy4 or DASY5 E-field Probe System

The SAR measurements were conducted with the dosimetric probe designed in the classical triangular configuration and optimized for dosimetric evaluation. The probe is constructed using the thick film technique; with printed resistive lines on ceramic substrates. The probe is equipped with an optical multifiber line ending at the front of the probe tip. It is connected to the EOC box on the robot arm and provides an automatic detection of the phantom surface. Half of the fibers are connected to a pulsed infrared transmitter, the other half to a synchronized receiver. As the probe approaches the surface, the reflection from the surface produces a coupling from the transmitting to the receiving fibers. This reflection increases first during the approach, reaches maximum and then decreases. If the probe is flatly touching the surface, the coupling is zero. The distance of the coupling maximum to the surface is independent of the surface reflectivity and largely independent of the surface to probe angle. The DASY4 or DASY5 software reads the reflection during a software approach and looks for the maximum using 2nd ord curve fitting. The approach is stopped at reaching the maximum.

Probe Specifications:

Model:	ES3DV3, EX3DV4
Frequency	10MHz — 6.0GHz(EX3DV4)
Range:	10MHz — 4GHz(ES3DV3)
Calibration:	In head and body simulating tissue at Frequencies from 835 up to 5800MHz
Linearity:	± 0.2 dB(30 MHz to 6 GHz) for EX3DV4 ± 0.2 dB(30 MHz to 4 GHz) for ES3DV3
DynamicRange:	10 mW/kg — 100W/kg
Probe Length:	330 mm
Probe Tip	
Length:	20 mm
Body Diameter:	12 mm
Tip Diameter:	2.5 mm (3.9 mm for ES3DV3)
Tip-Center:	1 mm (2.0mm for ES3DV3)
Application:	SAR Dosimetry Testing Compliance tests of mobile phones Dosimetry in strong gradient fields



Picture C.2Near-field Probe



Picture C.3E-field Probe

C.3 E-field Probe Calibration

Each E-Probe/Probe Amplifier combination has unique calibration parameters. A TEM cell calibration procedure is conducted to determine the proper amplifier settings to enter in the probe parameters. The amplifier settings are determined for a given frequency by subjecting the probe to a known E-field density (1 mW/cm²) using an RF Signal generator, TEM cell, and RF Power Meter.

The free space E-field from amplified probe outputs is determined in a test chamber. This calibration can be performed in a TEM cell if the frequency is below 1 GHz and in a waveguide or other methodologies above 1 GHz for free space. For the free space calibration, the probe is placed

in the volumetric center of the cavity and at the proper orientation with the field. The probe is then rotated 360 degrees until the three channels show the maximum reading. The power density readings equates to 1 mW/cm².

E-field temperature correlation calibration is performed in a flat phantom filled with the appropriate simulated brain tissue. The E-field in the medium correlates with the temperature rise in the dielectric medium. For temperature correlation calibration a RF transparent thermistor-based temperature probe is used in conjunction with the E-field probe.

$$SAR = C \frac{\Delta T}{\Delta t}$$

Where:

Δt = Exposure time (30 seconds),

C = Heat capacity of tissue (brain or muscle),

ΔT = Temperature increase due to RF exposure.

$$SAR = \frac{|E|^2 \cdot \sigma}{\rho}$$

Where:

σ = Simulated tissue conductivity,

ρ = Tissue density (kg/m³).

C.4 Other Test Equipment

C.4.1 Data Acquisition Electronics(DAE)

The data acquisition electronics consist of a highly sensitive electrometer-grade preamplifier with auto-zeroing, a channel and gain-switching multiplexer, a fast 16 bit AD-converter and a command decoder with a control logic unit. Transmission to the measurement server is accomplished through an optical downlink for data and status information, as well as an optical uplink for commands and the clock.

The mechanical probe mounting device includes two different sensor systems for frontal and sideways probe contacts. They are used for mechanical surface detection and probe collision detection.

The input impedance of the DAE is 200 MOhm; the inputs are symmetrical and floating. Common mode rejection is above 80 dB.



PictureC.4: DAE

C.4.2 Robot

The SPEAG DASY system uses the high precision robots (DASY4: RX90XL; DASY5: RX160L) type from Stäubli SA (France). For the 6-axis controller system, the robot controller version from Stäubli is used. The Stäubli robot series have many features that are important for our application:

- High precision (repeatability 0.02mm)
- High reliability (industrial design)
- Low maintenance costs (virtually maintenance free due to direct drive gears; no belt drives)
- Jerk-free straight movements (brushless synchron motors; no stepper motors)
- Low ELF interference (motor control fields shielded via the closed metallic construction shields)



Picture C.5 DASY 4



Picture C.6 DASY 5

C.4.3 Measurement Server

The Measurement server is based on a PC/104 CPU board with CPU (dasy4: 166 MHz, Intel Pentium; DASY5: 400 MHz, Intel Celeron), chipdisk (DASY4: 32 MB; DASY5: 128MB), RAM (DASY4: 64 MB, DASY5: 128MB). The necessary circuits for communication with the DAE electronic box, as well as the 16 bit AD converter system for optical detection and digital I/O interface are contained on the DASY I/O board, which is directly connected to the PC/104 bus of the CPU board.

The measurement server performs all real-time data evaluation of field measurements and surface detection, controls robot movements and handles safety operation. The PC operating system cannot interfere with these time critical processes. All connections are supervised by a watchdog, and disconnection of any of the cables to the measurement server will automatically disarm the robot and disable all program-controlled robot movements. Furthermore, the measurement server is equipped with an expansion port which is reserved for future applications. Please note that this expansion port does not have a standardized pinout, and therefore only devices provided by SPEAG can be connected. Devices from any other supplier could seriously damage the measurement server.



Picture C.7 Server for DASY 4



Picture C.8 Server for DASY 5

C.4.4 Device Holder for Phantom

The SAR in the phantom is approximately inversely proportional to the square of the distance between the source and the liquid surface. For a source at 5mm distance, a positioning uncertainty of $\pm 0.5\text{mm}$ would produce a SAR uncertainty of $\pm 20\%$. Accurate device positioning is therefore crucial for accurate and repeatable measurements. The positions in which the devices must be measured are defined by the standards.

The DASY device holder is designed to cope with the different positions given in the standard. It has two scales for device rotation (with respect to the body axis) and device inclination (with respect to the line between the ear reference points). The rotation centers for both scales are the ear reference point (ERP). Thus the device needs no repositioning when changing the angles. The DASY device holder is constructed of low-loss POM material having the following dielectric parameters: relative permittivity $\epsilon = 3$ and loss tangent $\delta = 0.02$. The amount of dielectric material has been reduced in the closest vicinity of the device, since measurements have suggested that the influence of the clamp on the test results could thus be lowered.

<Laptop Extension Kit>

The extension is lightweight and made of POM, acrylic glass and foam. It fits easily on the upper part of the Mounting Device in place of the phone positioner. The extension is fully compatible with the Twin-SAM and ELI phantoms.



Picture C.9-1: Device Holder

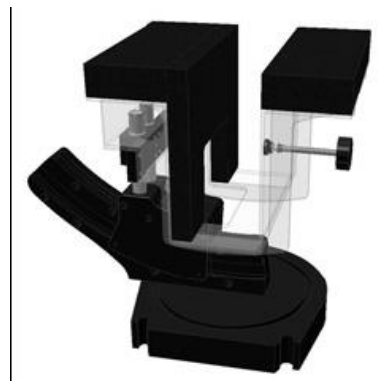

Picture C.9-2: Laptop Extension Kit

C.4.5 Phantom

The SAM Twin Phantom V4.0 is constructed of a fiberglass shell integrated in a table. The shape of the shell is based on data from an anatomical study designed to represent the 90th percentile of the population. The phantom enables the dissymmetric evaluation of SAR for both left and right handed handset usage, as well as body-worn usage using the flat phantom region. Reference markings on the Phantom allow the complete setup of all predefined phantom positions and measurement grids by manually teaching three points in the robot. The shell phantom has a 2mm shell thickness (except the ear region where shell thickness increases to 6 mm).

Shell Thickness: 2 ± 0.2 mm

Filling Volume: Approx. 25 liters

Dimensions: 810 x 1000 x 500 mm (H x L x W)

Available: Special



Picture C.10: SAM Twin Phantom

ANNEX D Position of the wireless device in relation to the phantom

D.1 USB Dongle device

Test all USB orientations [see figure below: (A) Horizontal-Up, (B) Horizontal-Down, (C) Vertical-Front, and (D) Vertical-Back] with a device-to-phantom separation distance of 5 mm or less. These test orientations are intended for the exposure conditions found in typical laptop/notebook/netbook or tablet computers with either horizontal or vertical USB connector configurations at various locations in the keyboard section of the computer. Current generation portable host computers should be used to establish the required SAR measurement separation distance. The same test separation distance must be used to test all frequency bands and modes in each USB orientation. The typical Horizontal-Up USB connection (A), found in the majority of host computers, must be tested using an appropriate host computer. A host computer with either Vertical-Front (C) or Vertical-Back (D) USB connection should be used to test one of the vertical USB orientations.

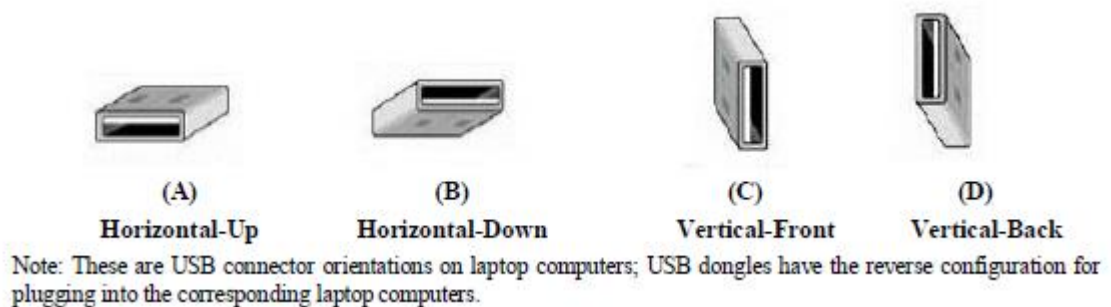

Picture D.1 Test positions for desktop devices

D.2 DUT Setup Photos



Picture D.3

ANNEX E Equivalent Media Recipes

The liquid used for the frequency range of 800-3000 MHz consisted of water, sugar, salt, preventol, glycol monobutyl and Cellulose. The liquid has been previously proven to be suited for worst-case. The Table E.1 shows the detail solution. It's satisfying the latest tissue dielectric parameters requirements proposed by the IEEE 1528 and IEC 62209.

TableE.1: Composition of the Tissue Equivalent Matter

Frequency (MHz)	835Head	835Body	1900 Head	1900 Body	2450 Head	2450 Body	5800 Head	5800 Body
Ingredients (% by weight)								
Water	41.45	52.5	55.242	69.91	58.79	72.60	65.53	65.53
Sugar	56.0	45.0	\	\	\	\	\	\
Salt	1.45	1.4	0.306	0.13	0.06	0.18	\	\
Preventol	0.1	0.1	\	\	\	\	\	\
Cellulose	1.0	1.0	\	\	\	\	\	\
Glycol Monobutyl	\	\	44.452	29.96	41.15	27.22	\	\
Diethylenglycol monohexylether	\	\	\	\	\	\	17.24	17.24
Triton X-100	\	\	\	\	\	\	17.24	17.24
Dielectric Parameters Target Value	$\epsilon=41.5$ $\sigma=0.90$	$\epsilon=55.2$ $\sigma=0.97$	$\epsilon=40.0$ $\sigma=1.40$	$\epsilon=53.3$ $\sigma=1.52$	$\epsilon=39.2$ $\sigma=1.80$	$\epsilon=52.7$ $\sigma=1.95$	$\epsilon=35.3$ $\sigma=5.27$	$\epsilon=48.2$ $\sigma=6.00$

Note: There are a little adjustment respectively for 750, 1750, 2600, 5200, 5300 and 5600 based on the recipe of closest frequency in table E.1.

ANNEX F System Validation

The SAR system must be validated against its performance specifications before it is deployed. When SAR probes, system components or software are changed, upgraded or recalibrated, these must be validated with the SAR system(s) that operates with such components.

Table F.1: System Validation for 3617

Probe SN.	Liquid name	Validation date	Frequency point	Status (OK or Not)
3617	Head 750MHz	Feb.14,2019	750 MHz	OK
3617	Head 850MHz	Feb.14,2019	835 MHz	OK
3617	Head 900MHz	Feb.14,2019	900 MHz	OK
3617	Head 1750MHz	Feb.14,2019	1750 MHz	OK
3617	Head 1810MHz	Feb.14,2019	1810 MHz	OK
3617	Head 1900MHz	Feb.15,2019	1900 MHz	OK
3617	Head 2000MHz	Feb.15,2019	2000 MHz	OK
3617	Head 2100MHz	Feb.15,2019	2100 MHz	OK
3617	Head 2300MHz	Feb.15,2019	2300 MHz	OK
3617	Head 2450MHz	Feb.15,2019	2450 MHz	OK
3617	Head 2600MHz	Feb.16,2019	2600 MHz	OK
3617	Head 3500MHz	Feb.16,2019	3500 MHz	OK
3617	Head 3700MHz	Feb.16,2019	3700 MHz	OK
3617	Head 5200MHz	Feb.16,2019	5250 MHz	OK
3617	Head 5500MHz	Feb.16,2019	5600 MHz	OK
3617	Head 5800MHz	Feb.16,2019	5800 MHz	OK
3617	Body 750MHz	Feb.16,2019	750 MHz	OK
3617	Body 850MHz	Feb.13,2019	835 MHz	OK
3617	Body 900MHz	Feb.13,2019	900 MHz	OK
3617	Body 1750MHz	Feb.13,2019	1750 MHz	OK
3617	Body 1810MHz	Feb.13,2019	1810 MHz	OK
3617	Body 1900MHz	Feb.13,2019	1900 MHz	OK
3617	Body 2000MHz	Feb.17,2019	2000 MHz	OK
3617	Body 2100MHz	Feb.17,2019	2100 MHz	OK
3617	Body 2300MHz	Feb.17,2019	2300 MHz	OK
3617	Body 2450MHz	Feb.17,2019	2450 MHz	OK
3617	Body 2600MHz	Feb.17,2019	2600 MHz	OK
3617	Body 3500MHz	Feb.12,2019	3500 MHz	OK
3617	Body 3700MHz	Feb.12,2019	3700 MHz	OK
3617	Body 5200MHz	Feb.12,2019	5250 MHz	OK
3617	Body 5500MHz	Feb.12,2019	5600 MHz	OK
3617	Body 5800MHz	Feb.12,2019	5800 MHz	OK

ANNEX G Probe Calibration Certificate

Probe 3617 Calibration Certificate

Calibration Laboratory of
Schmid & Partner
Engineering AG
 Zeughausstrasse 43, 8004 Zurich, Switzerland



S Schweizerischer Kalibrierdienst
C Service suisse d'étalonnage
S Servizio svizzero di taratura
 Swiss Calibration Service

Accredited by the Swiss Accreditation Service (SAS)
 The Swiss Accreditation Service is one of the signatories to the EA
 Multilateral Agreement for the recognition of calibration certificates

Accreditation No.: **SCS 0108**

Client **CTTL (Auden)**

Certificate No: **EX3-3617_Jan19**

CALIBRATION CERTIFICATE

Object: **EX3DV4 - SN:3617**

Calibration procedure(s): **QA CAL-01.v9, QA CAL-12.v9, QA CAL-14.v5, QA CAL-23.v5, QA CAL-25.v7**
Calibration procedure for dosimetric E-field probes

Calibration date: **January 31, 2019**

This calibration certificate documents the traceability to national standards, which realize the physical units of measurements (SI). The measurements and the uncertainties with confidence probability are given on the following pages and are part of the certificate.

All calibrations have been conducted in the closed laboratory facility: environment temperature (22 ± 3)°C and humidity < 70%.

Calibration Equipment used (M&TE critical for calibration)

Primary Standards	ID	Cal Date (Certificate No.)	Scheduled Calibration
Power meter NRP	SN: 104778	04-Apr-18 (No. 217-02672/02673)	Apr-19
Power sensor NRP-Z91	SN: 103244	04-Apr-18 (No. 217-02672)	Apr-19
Power sensor NRP-Z91	SN: 103245	04-Apr-18 (No. 217-02673)	Apr-19
Reference 20 dB Attenuator	SN: S5277 (20x)	04-Apr-18 (No. 217-02682)	Apr-19
DAE4	SN: 660	19-Dec-18 (No. DAE4-660_Dec18)	Dec-19
Reference Probe ES3DV2	SN: 3013	31-Dec-18 (No. ES3-3013_Dec18)	Dec-19
Secondary Standards	ID	Check Date (in house)	Scheduled Check
Power meter E4419B	SN: GB41293874	06-Apr-16 (in house check Jun-18)	In house check: Jun-20
Power sensor E4412A	SN: MY41498087	06-Apr-16 (in house check Jun-18)	In house check: Jun-20
Power sensor E4412A	SN: 000110210	06-Apr-16 (in house check Jun-18)	In house check: Jun-20
RF generator HP 8648C	SN: US3642U01700	04-Aug-99 (in house check Jun-18)	In house check: Jun-20
Network Analyzer E8358A	SN: US41080477	31-Mar-14 (in house check Oct-18)	In house check: Oct-19

Calibrated by: **Jeton Kastrati** (Name), **Laboratory Technician** (Function), (Signature)

Approved by: **Katja Pokovic** (Name), **Technical Manager** (Function), (Signature)

Issued: February 2, 2019

This calibration certificate shall not be reproduced except in full without written approval of the laboratory.

Calibration Laboratory of
Schmid & Partner
Engineering AG
Zeughausstrasse 43, 8004 Zurich, Switzerland



S Schweizerischer Kalibrierdienst
C Service suisse d'étalonnage
S Servizio svizzero di taratura
S Swiss Calibration Service

Accredited by the Swiss Accreditation Service (SAS)
The Swiss Accreditation Service is one of the signatories to the EA
Multilateral Agreement for the recognition of calibration certificates

Accreditation No.: **SCS 0108**

Glossary:

TSL	tissue simulating liquid
NORM _{x,y,z}	sensitivity in free space
ConvF	sensitivity in TSL / NORM _{x,y,z}
DCP	diode compression point
CF	crest factor (1/duty_cycle) of the RF signal
A, B, C, D	modulation dependent linearization parameters
Polarization φ	φ rotation around probe axis
Polarization ϑ	ϑ rotation around an axis that is in the plane normal to probe axis (at measurement center), i.e., $\vartheta = 0$ is normal to probe axis
Connector Angle	information used in DASY system to align probe sensor X to the robot coordinate system

Calibration is Performed According to the Following Standards:

- IEEE Std 1528-2013, "IEEE Recommended Practice for Determining the Peak Spatial-Averaged Specific Absorption Rate (SAR) in the Human Head from Wireless Communications Devices: Measurement Techniques", June 2013
- IEC 62209-1, "Measurement procedure for the assessment of Specific Absorption Rate (SAR) from hand-held and body-mounted devices used next to the ear (frequency range of 300 MHz to 6 GHz)", July 2016
- IEC 62209-2, "Procedure to determine the Specific Absorption Rate (SAR) for wireless communication devices used in close proximity to the human body (frequency range of 30 MHz to 6 GHz)", March 2010
- KDB 865664, "SAR Measurement Requirements for 100 MHz to 6 GHz"

Methods Applied and Interpretation of Parameters:

- NORM_{x,y,z}**: Assessed for E-field polarization $\vartheta = 0$ ($f \leq 900$ MHz in TEM-cell; $f > 1800$ MHz: R22 waveguide). NORM_{x,y,z} are only intermediate values, i.e., the uncertainties of NORM_{x,y,z} does not affect the E^2 -field uncertainty inside TSL (see below ConvF).
- NORM(f)_{x,y,z}** = NORM_{x,y,z} * frequency_response (see Frequency Response Chart). This linearization is implemented in DASY4 software versions later than 4.2. The uncertainty of the frequency response is included in the stated uncertainty of ConvF.
- DCP_{x,y,z}**: DCP are numerical linearization parameters assessed based on the data of power sweep with CW signal (no uncertainty required). DCP does not depend on frequency nor media.
- PAR**: PAR is the Peak to Average Ratio that is not calibrated but determined based on the signal characteristics
- A_{x,y,z}; B_{x,y,z}; C_{x,y,z}; D_{x,y,z}; VR_{x,y,z}**: A, B, C, D are numerical linearization parameters assessed based on the data of power sweep for specific modulation signal. The parameters do not depend on frequency nor media. VR is the maximum calibration range expressed in RMS voltage across the diode.
- ConvF and Boundary Effect Parameters**: Assessed in flat phantom using E-field (or Temperature Transfer Standard for $f \leq 800$ MHz) and inside waveguide using analytical field distributions based on power measurements for $f > 800$ MHz. The same setups are used for assessment of the parameters applied for boundary compensation (alpha, depth) of which typical uncertainty values are given. These parameters are used in DASY4 software to improve probe accuracy close to the boundary. The sensitivity in TSL corresponds to NORM_{x,y,z} * ConvF whereby the uncertainty corresponds to that given for ConvF. A frequency dependent ConvF is used in DASY version 4.4 and higher which allows extending the validity from ± 50 MHz to ± 100 MHz.
- Spherical isotropy (3D deviation from isotropy)**: in a field of low gradients realized using a flat phantom exposed by a patch antenna.
- Sensor Offset**: The sensor offset corresponds to the offset of virtual measurement center from the probe tip (on probe axis). No tolerance required.
- Connector Angle**: The angle is assessed using the information gained by determining the NORM_x (no uncertainty required).

EX3DV4 – SN:3617

January 31, 2019

DASY/EASY - Parameters of Probe: EX3DV4 - SN:3617

Basic Calibration Parameters

	Sensor X	Sensor Y	Sensor Z	Unc (k=2)
Norm ($\mu\text{V}/(\text{V}/\text{m})^2$) ^A	0.35	0.21	0.32	± 10.1 %
DCP (mV) ^B	102.9	95.7	101.9	

Calibration Results for Modulation Response

UID	Communication System Name		A dB	B dB· μV	C	D dB	VR mV	Max dev.	Max Unc ^E (k=2)
0	CW	X	0.00	0.00	1.00	0.00	151.4	± 3.0 %	± 4.7 %
		Y	0.00	0.00	1.00		154.7		
		Z	0.00	0.00	1.00		150.4		
10352-AAA	Pulse Waveform (200Hz, 10%)	X	5.31	73.42	14.63	10.00	60.0	± 2.6 %	± 9.6 %
		Y	2.86	65.84	11.90		60.0		
		Z	15.00	87.67	20.10		60.0		
10353-AAA	Pulse Waveform (200Hz, 20%)	X	10.57	81.97	16.23	6.99	80.0	± 1.7 %	± 9.6 %
		Y	2.03	65.40	10.27		80.0		
		Z	15.00	89.79	19.80		80.0		
10354-AAA	Pulse Waveform (200Hz, 40%)	X	15.00	86.62	16.29	3.98	95.0	± 1.1 %	± 9.6 %
		Y	0.82	61.50	6.58		95.0		
		Z	15.00	97.47	22.01		95.0		
10355-AAA	Pulse Waveform (200Hz, 60%)	X	15.00	89.99	16.64	2.22	120.0	± 1.2 %	± 9.6 %
		Y	0.40	60.00	3.98		120.0		
		Z	15.00	114.21	28.32		120.0		
10387-AAA	QPSK Waveform, 1 MHz	X	0.65	62.36	8.93	0.00	150.0	± 3.9 %	± 9.6 %
		Y	0.45	60.00	5.43		150.0		
		Z	0.90	65.62	10.92		150.0		
10388-AAA	QPSK Waveform, 10 MHz	X	2.42	70.53	17.16	0.00	150.0	± 1.8 %	± 9.6 %
		Y	1.99	67.57	15.24		150.0		
		Z	2.71	72.39	18.22		150.0		
10396-AAA	64-QAM Waveform, 100 kHz	X	3.78	75.33	20.79	3.01	150.0	± 0.7 %	± 9.6 %
		Y	3.23	71.01	18.81		150.0		
		Z	3.71	74.94	20.97		150.0		
10399-AAA	64-QAM Waveform, 40 MHz	X	3.58	68.11	16.37	0.00	150.0	± 4.0 %	± 9.6 %
		Y	3.32	66.75	15.59		150.0		
		Z	3.71	68.68	16.83		150.0		
10414-AAA	WLAN CCDF, 64-QAM, 40MHz	X	4.84	66.21	15.87	0.00	150.0	± 6.7 %	± 9.6 %
		Y	4.48	64.72	15.19		150.0		
		Z	4.93	66.43	16.14		150.0		

Note: For details on UID parameters see Appendix

The reported uncertainty of measurement is stated as the standard uncertainty of measurement multiplied by the coverage factor k=2, which for a normal distribution corresponds to a coverage probability of approximately 95%.

^A The uncertainties of Norm X,Y,Z do not affect the E²-field uncertainty inside TSL (see Pages 5 and 6).

^B Numerical linearization parameter: uncertainty not required.

^E Uncertainty is determined using the max. deviation from linear response applying rectangular distribution and is expressed for the square of the field value.



EX3DV4- SN:3617

January 31, 2019

DASY/EASY - Parameters of Probe: EX3DV4 - SN:3617

Sensor Model Parameters

	C1 fF	C2 fF	α V ⁻¹	T1 ms.V ⁻²	T2 ms.V ⁻¹	T3 ms	T4 V ⁻²	T5 V ⁻¹	T6
X	38.8	281.02	33.92	10.58	0.71	4.99	1.88	0.20	1.01
Y	39.2	310.65	39.54	8.92	1.27	5.05	0.00	0.75	1.01
Z	40.7	300.62	35.22	10.39	0.59	5.05	1.28	0.33	1.01

Other Probe Parameters

Sensor Arrangement	Triangular
Connector Angle (°)	14.6
Mechanical Surface Detection Mode	enabled
Optical Surface Detection Mode	disabled
Probe Overall Length	337 mm
Probe Body Diameter	10 mm
Tip Length	9 mm
Tip Diameter	2.5 mm
Probe Tip to Sensor X Calibration Point	1 mm
Probe Tip to Sensor Y Calibration Point	1 mm
Probe Tip to Sensor Z Calibration Point	1 mm
Recommended Measurement Distance from Surface	1.4 mm

DASY/EASY - Parameters of Probe: EX3DV4 - SN:3617

Calibration Parameter Determined in Head Tissue Simulating Media

f (MHz) ^C	Relative Permittivity ^F	Conductivity (S/m) ^F	ConvF X	ConvF Y	ConvF Z	Alpha ^G	Depth ^G (mm)	Unc (k=2)
64	54.2	0.75	12.45	12.45	12.45	0.00	1.00	± 13.3 %
150	52.3	0.76	11.88	11.88	11.88	0.00	1.00	± 13.3 %
300	45.3	0.87	11.40	11.40	11.40	0.08	1.20	± 13.3 %
450	43.5	0.87	10.54	10.54	10.54	0.14	1.40	± 13.3 %
750	41.9	0.89	10.03	10.03	10.03	0.63	0.84	± 12.0 %
835	41.5	0.90	9.75	9.75	9.75	0.39	0.95	± 12.0 %
900	41.5	0.97	9.66	9.66	9.66	0.47	0.85	± 12.0 %
1450	40.5	1.20	8.68	8.68	8.68	0.37	0.80	± 12.0 %
1640	40.2	1.31	8.48	8.48	8.48	0.38	0.80	± 12.0 %
1750	40.1	1.37	8.38	8.38	8.38	0.36	0.82	± 12.0 %
1810	40.0	1.40	8.11	8.11	8.11	0.32	0.84	± 12.0 %
1900	40.0	1.40	8.14	8.14	8.14	0.32	0.85	± 12.0 %
2000	40.0	1.40	8.13	8.13	8.13	0.28	0.84	± 12.0 %
2100	39.8	1.49	8.30	8.30	8.30	0.37	0.85	± 12.0 %
2300	39.5	1.67	7.74	7.74	7.74	0.32	0.84	± 12.0 %
2450	39.2	1.80	7.62	7.62	7.62	0.31	0.95	± 12.0 %
2600	39.0	1.96	7.19	7.19	7.19	0.43	0.85	± 12.0 %
3300	38.2	2.71	6.98	6.98	6.98	0.25	1.20	± 13.1 %
3500	37.9	2.91	6.97	6.97	6.97	0.50	1.20	± 13.1 %
3700	37.7	3.12	6.89	6.89	6.89	0.20	1.20	± 13.1 %
3900	37.5	3.32	6.88	6.88	6.88	0.20	1.20	± 13.1 %
4600	36.7	4.04	6.84	6.84	6.84	0.20	1.50	± 13.1 %
4950	36.3	4.40	5.60	5.60	5.60	0.40	1.80	± 13.1 %
5200	36.0	4.66	5.50	5.50	5.50	0.40	1.80	± 13.1 %
5250	35.9	4.71	5.39	5.39	5.39	0.40	1.80	± 13.1 %
5300	35.9	4.76	5.25	5.25	5.25	0.40	1.80	± 13.1 %
5500	35.6	4.96	5.18	5.18	5.18	0.40	1.80	± 13.1 %
5600	35.5	5.07	5.06	5.06	5.06	0.40	1.80	± 13.1 %
5750	35.4	5.22	5.07	5.07	5.07	0.40	1.80	± 13.1 %
5800	35.3	5.27	5.04	5.04	5.04	0.40	1.80	± 13.1 %

^C Frequency validity above 300 MHz of ± 100 MHz only applies for DASY v4.4 and higher (see Page 2), else it is restricted to ± 50 MHz. The uncertainty is the RSS of the ConvF uncertainty at calibration frequency and the uncertainty for the indicated frequency band. Frequency validity below 300 MHz is ± 10, 25, 40, 50 and 70 MHz for ConvF assessments at 30, 64, 128, 150 and 220 MHz respectively. Validity of ConvF assessed at 6 MHz is 4-9 MHz, and ConvF assessed at 13 MHz is 9-19 MHz. Above 5 GHz frequency validity can be extended to ± 110 MHz.

^F At frequencies below 3 GHz, the validity of tissue parameters (ϵ and σ) can be relaxed to ± 10% if liquid compensation formula is applied to measured SAR values. At frequencies above 3 GHz, the validity of tissue parameters (ϵ and σ) is restricted to ± 5%. The uncertainty is the RSS of the ConvF uncertainty for indicated target tissue parameters.

^G Alpha/Depth are determined during calibration. SPEAG warrants that the remaining deviation due to the boundary effect after compensation is always less than ± 1% for frequencies below 3 GHz and below ± 2% for frequencies between 3-6 GHz at any distance larger than half the probe tip diameter from the boundary.

DASY/EASY - Parameters of Probe: EX3DV4 - SN:3617

Calibration Parameter Determined in Body Tissue Simulating Media

f (MHz) ^C	Relative Permittivity ^F	Conductivity (S/m) ^F	ConvF X	ConvF Y	ConvF Z	Alpha ^G	Depth (mm) ^G	Unc (k=2)
150	61.9	0.80	11.45	11.45	11.45	0.00	1.00	± 13.3 %
300	58.2	0.92	10.57	10.57	10.57	0.03	1.20	± 13.3 %
450	56.7	0.94	10.39	10.39	10.39	0.08	1.20	± 13.3 %
750	55.5	0.96	9.85	9.85	9.85	0.50	0.84	± 12.0 %
835	55.2	0.97	9.61	9.61	9.61	0.37	0.95	± 12.0 %
900	55.0	1.05	9.57	9.57	9.57	0.45	0.84	± 12.0 %
1450	54.0	1.30	8.33	8.33	8.33	0.34	0.80	± 12.0 %
1640	53.7	1.42	8.53	8.53	8.53	0.35	0.80	± 12.0 %
1750	53.4	1.49	8.03	8.03	8.03	0.39	0.84	± 12.0 %
1810	53.3	1.52	7.94	7.94	7.94	0.43	0.84	± 12.0 %
1900	53.3	1.52	7.78	7.78	7.78	0.38	0.87	± 12.0 %
2000	53.3	1.52	8.00	8.00	8.00	0.22	1.15	± 12.0 %
2100	53.2	1.62	8.23	8.23	8.23	0.41	0.85	± 12.0 %
2300	52.9	1.81	7.84	7.84	7.84	0.40	0.84	± 12.0 %
2450	52.7	1.95	7.79	7.79	7.79	0.31	0.86	± 12.0 %
2600	52.5	2.16	7.49	7.49	7.49	0.26	0.98	± 12.0 %
3500	51.3	3.31	6.86	6.86	6.86	0.25	1.20	± 13.1 %
3700	51.0	3.55	6.60	6.60	6.60	0.26	1.25	± 13.1 %
3900	51.2	3.78	6.69	6.69	6.69	0.26	1.25	± 13.1 %
4600	49.8	4.60	6.50	6.50	6.50	0.28	1.30	± 13.1 %
3500	51.3	3.31	6.46	6.46	6.46	0.20	1.70	± 13.1 %
4950	49.4	5.01	4.99	4.99	4.99	0.50	1.90	± 13.1 %
5200	49.0	5.30	4.84	4.84	4.84	0.50	1.90	± 13.1 %
5250	48.9	5.36	4.76	4.76	4.76	0.50	1.90	± 13.1 %
5300	48.9	5.42	4.63	4.63	4.63	0.50	1.90	± 13.1 %
5500	48.6	5.65	4.32	4.32	4.32	0.50	1.90	± 13.1 %
5600	48.5	5.77	4.23	4.23	4.23	0.50	1.90	± 13.1 %
5750	48.3	5.94	4.36	4.36	4.36	0.50	1.90	± 13.1 %
5800	48.2	6.00	4.24	4.24	4.24	0.50	1.90	± 13.1 %

^C Frequency validity above 300 MHz of ± 100 MHz only applies for DASY v4.4 and higher (see Page 2), else it is restricted to ± 50 MHz. The uncertainty is the RSS of the ConvF uncertainty at calibration frequency and the uncertainty for the indicated frequency band. Frequency validity below 300 MHz is ± 10, 25, 40, 50 and 70 MHz for ConvF assessments at 30, 64, 128, 150 and 220 MHz respectively. Validity of ConvF assessed at 6 MHz is 4-9 MHz, and ConvF assessed at 13 MHz is 9-19 MHz. Above 5 GHz frequency validity can be extended to ± 110 MHz.

^F At frequencies below 3 GHz, the validity of tissue parameters (ϵ and σ) can be relaxed to ± 10% if liquid compensation formula is applied to measured SAR values. At frequencies above 3 GHz, the validity of tissue parameters (ϵ and σ) is restricted to ± 5%. The uncertainty is the RSS of the ConvF uncertainty for indicated target tissue parameters.

^G Alpha/Depth are determined during calibration. SPEAG warrants that the remaining deviation due to the boundary effect after compensation is always less than ± 1% for frequencies below 3 GHz and below ± 2% for frequencies between 3-6 GHz at any distance larger than half the probe tip diameter from the boundary.

Frequency Response of E-Field (TEM-Cell:ifi110 EXX, Waveguide: R22)

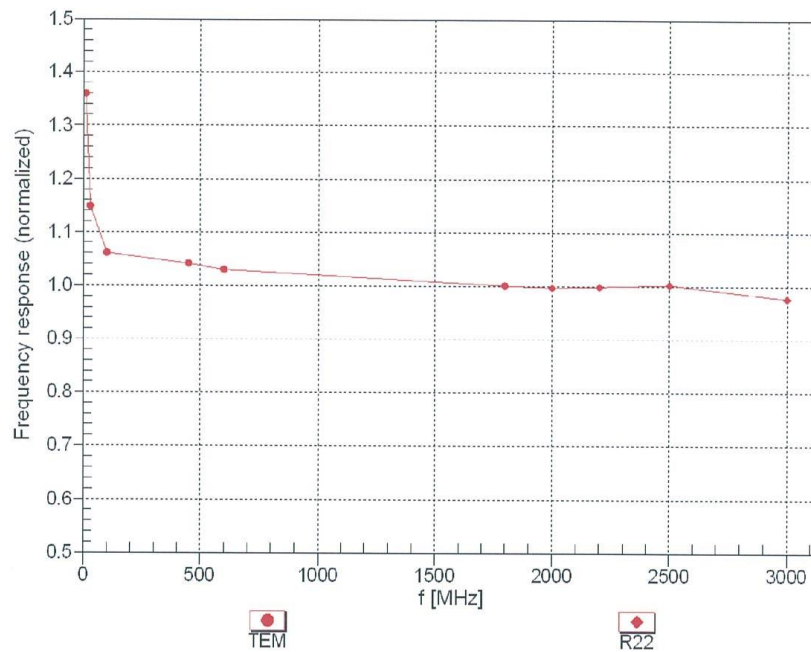

Uncertainty of Frequency Response of E-field: $\pm 6.3\%$ (k=2)

EX3DV4- SN:3617

January 31, 2019

Receiving Pattern (ϕ), $\vartheta = 0^\circ$

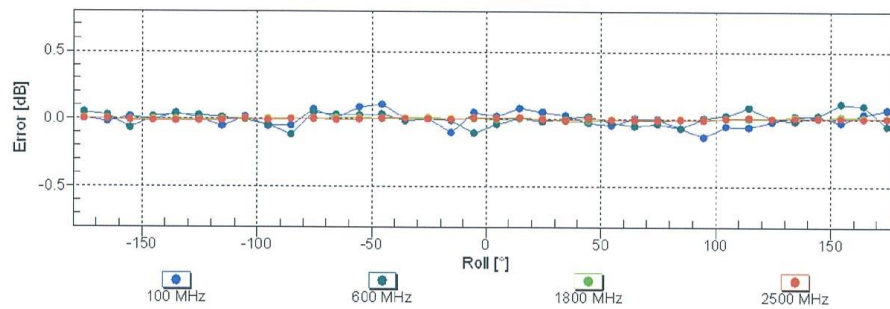
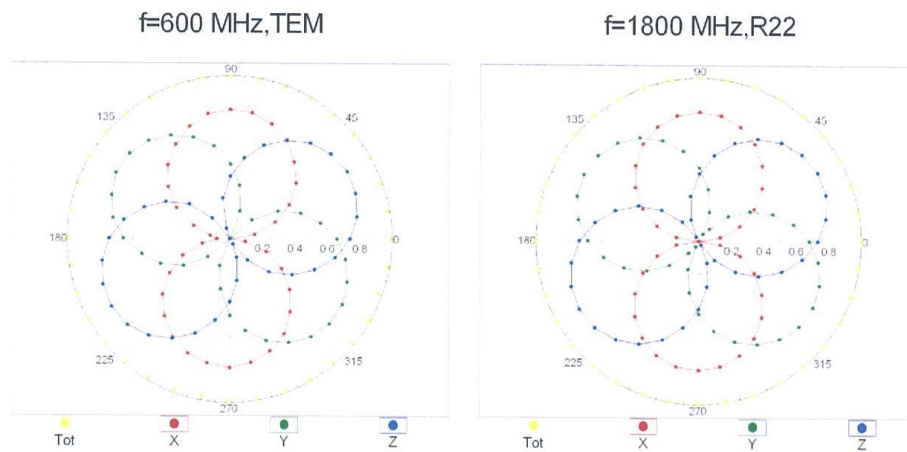

Uncertainty of Axial Isotropy Assessment: $\pm 0.5\%$ ($k=2$)

Dynamic Range f(SAR_{head})
(TEM cell , f_{eval}= 1900 MHz)

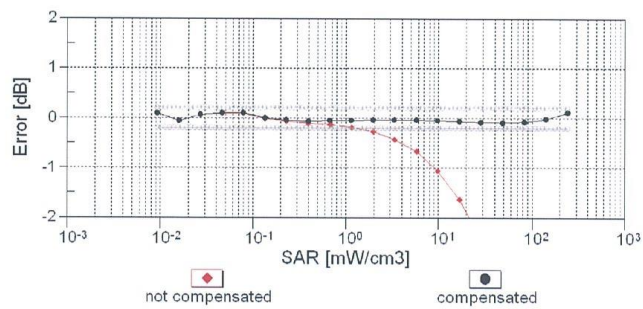
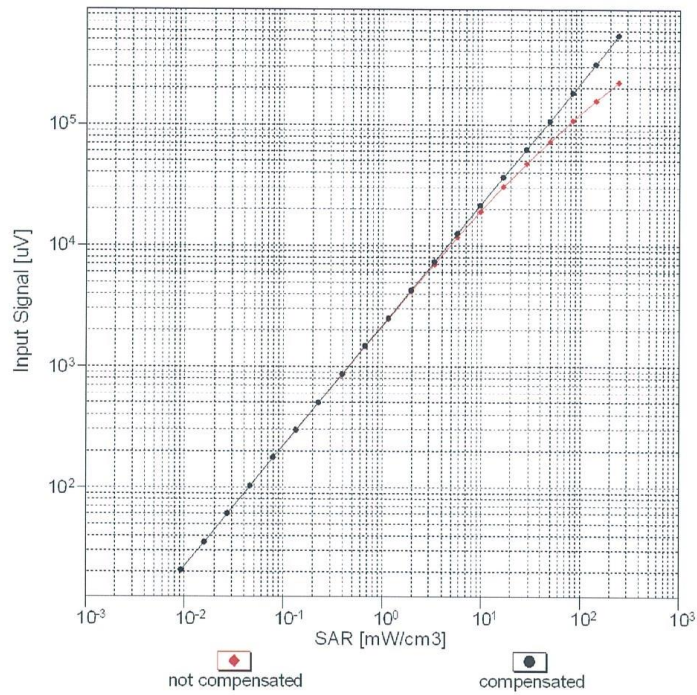

Uncertainty of Linearity Assessment: ± 0.6% (k=2)

Conversion Factor Assessment

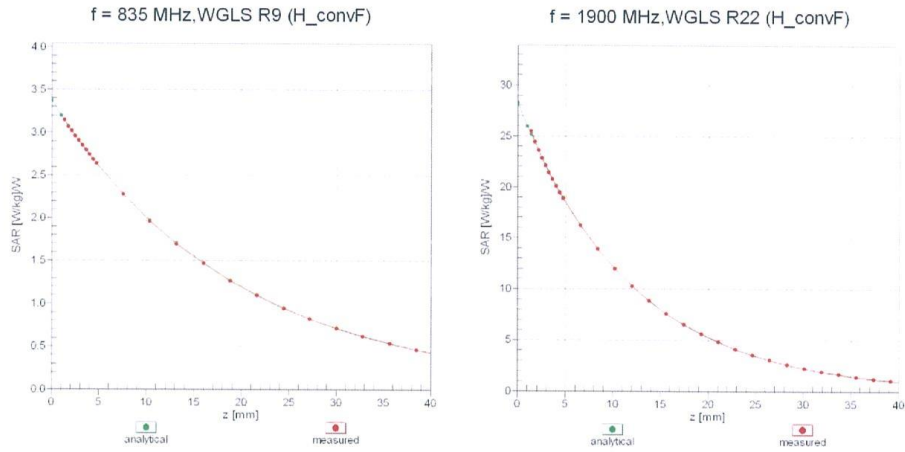

Deviation from Isotropy in Liquid Error (ϕ, θ), f = 900 MHz

