



# SAR TEST REPORT

No. I19Z61094-SEM01

For

**TCL Communication Ltd.**

**Smart Phone**

**Model name: 5032W**

With

**Hardware Version: 06**

**Software Version: 3E5H**

**FCC ID: 2ACCJB111**

**Issued Date: 2019-9-18**



**Note:**

The test results in this test report relate only to the devices specified in this report. This report shall not be reproduced except in full without the written approval of CTTL.

The report must not be used by the client to claim product certification, approval, or endorsement by NVLAP, NIST, or any agency of the U.S. Government.

**Test Laboratory:**

CTTL, Telecommunication Technology Labs, CAICT

No. 51, Xueyuan Road, Haidian District, Beijing, P. R. China 100191.

Tel:+86(0)10-62304633-2512, Fax:+86(0)10-62304633-2504

Email: [ctl\\_terminals@caict.ac.cn](mailto:ctl_terminals@caict.ac.cn), website: [www.caict.ac.cn](http://www.caict.ac.cn)



## **REPORT HISTORY**

<b>Report Number</b>	<b>Revision</b>	<b>Issue Date</b>	<b>Description</b>
I19Z61094-SEM01	Rev.0	2019-9-4	Initial creation of test report
I19Z61094-SEM01	Rev.1	2019-9-18	Update the information on section 7.1 of test report. Update the information on table 11.3-4 of test report. Update the information on section 14.1 of test report.



## TABLE OF CONTENT

<b>1 TEST LABORATORY</b> .....	<b>5</b>
1.1 TESTING LOCATION .....	5
1.2 TESTING ENVIRONMENT.....	5
1.3 PROJECT DATA .....	5
1.4 SIGNATURE.....	5
<b>2 STATEMENT OF COMPLIANCE</b> .....	<b>6</b>
<b>3 CLIENT INFORMATION</b> .....	<b>8</b>
3.1 APPLICANT INFORMATION .....	8
3.2 MANUFACTURER INFORMATION .....	8
<b>4 EQUIPMENT UNDER TEST (EUT) AND ANCILLARY EQUIPMENT (AE)</b> .....	<b>9</b>
4.1 ABOUT EUT.....	9
4.2INTERNAL IDENTIFICATION OF EUT USED DURING THE TEST.....	9
4.3 INTERNAL IDENTIFICATION OF AE USED DURING THE TEST .....	9
<b>5 TEST METHODOLOGY</b> .....	<b>10</b>
5.1 APPLICABLE LIMIT REGULATIONS .....	10
5.2 APPLICABLE MEASUREMENT STANDARDS.....	10
<b>6 SPECIFIC ABSORPTION RATE (SAR)</b> .....	<b>11</b>
6.1 INTRODUCTION.....	11
6.2 SAR DEFINITION .....	11
<b>7 TISSUE SIMULATING LIQUIDS</b> .....	<b>12</b>
7.1 TARGETS FOR TISSUE SIMULATING LIQUID .....	12
7.2 DIELECTRIC PERFORMANCE .....	12
<b>8 SYSTEM VERIFICATION</b> .....	<b>20</b>
8.1 SYSTEM SETUP.....	20
8.2 SYSTEM VERIFICATION.....	21
<b>9 MEASUREMENT PROCEDURES</b> .....	<b>22</b>
9.1 TESTS TO BE PERFORMED .....	22
9.2 GENERAL MEASUREMENT PROCEDURE.....	24
9.3 WCDMA MEASUREMENT PROCEDURES FOR SAR .....	25
9.4 SAR MEASUREMENT FOR LTE.....	26
9.5 BLUETOOTH & WI-FI MEASUREMENT PROCEDURES FOR SAR .....	26
9.6 POWER DRIFT.....	27
<b>10 AREA SCAN BASED 1-G SAR</b> .....	<b>27</b>
10.1 REQUIREMENT OF KDB.....	27
10.2 FAST SAR ALGORITHMS .....	27
<b>11 CONDUCTED OUTPUT POWER</b> .....	<b>28</b>



11.1 GSM MEASUREMENT RESULT .....	28
11.2 WCDMA MEASUREMENT RESULT.....	30
11.3 LTE MEASUREMENT RESULT.....	32
11.4 WI-FI AND BT MEASUREMENT RESULT .....	64
<b>12 SIMULTANEOUS TX SAR CONSIDERATIONS.....</b>	<b>66</b>
12.1 INTRODUCTION.....	66
12.2 TRANSMIT ANTENNA SEPARATION DISTANCES .....	66
12.3 SAR MEASUREMENT POSITIONS .....	67
12.4 STANDALONE SAR TEST EXCLUSION CONSIDERATIONS .....	67
<b>13 EVALUATION OF SIMULTANEOUS.....</b>	<b>68</b>
<b>14 SAR TEST RESULT .....</b>	<b>74</b>
14.1 SAR RESULTS FOR FAST SAR.....	75
14.2 SAR RESULTS FOR STANDARD PROCEDURE .....	90
14.3 WLAN EVALUATION FOR 2.4G .....	97
14.4 WLAN EVALUATION FOR 5G.....	100
<b>15 SAR MEASUREMENT VARIABILITY.....</b>	<b>104</b>
<b>16 MEASUREMENT UNCERTAINTY .....</b>	<b>107</b>
16.1 MEASUREMENT UNCERTAINTY FOR NORMAL SAR TESTS (300MHZ~3GHZ) .....	107
16.2 MEASUREMENT UNCERTAINTY FOR NORMAL SAR TESTS (3~6GHZ) .....	108
16.3 MEASUREMENT UNCERTAINTY FOR FAST SAR TESTS (300MHZ~3GHZ) .....	109
16.4 MEASUREMENT UNCERTAINTY FOR FAST SAR TESTS (3~6GHZ).....	110
<b>17 MAIN TEST INSTRUMENTS.....</b>	<b>111</b>
<b>ANNEX A GRAPH RESULTS.....</b>	<b>112</b>
<b>ANNEX B SYSTEM VERIFICATION RESULTS .....</b>	<b>186</b>
<b>ANNEX C SAR MEASUREMENT SETUP .....</b>	<b>203</b>
<b>ANNEX D POSITION OF THE WIRELESS DEVICE IN RELATION TO THE PHANTOM .....</b>	<b>209</b>
<b>ANNEX E EQUIVALENT MEDIA RECIPES .....</b>	<b>212</b>
<b>ANNEX F SYSTEM VALIDATION .....</b>	<b>213</b>
<b>ANNEX G PROBE CALIBRATION CERTIFICATE.....</b>	<b>214</b>
<b>ANNEX H DIPOLE CALIBRATION CERTIFICATE .....</b>	<b>225</b>
<b>ANNEX I EXTENDED CALIBRATION SAR DIPOLE .....</b>	<b>286</b>
<b>ANNEX J ACCREDITATION CERTIFICATE.....</b>	<b>289</b>

## 1 Test Laboratory

### 1.1 Testing Location

Company Name:	CTTL(Shouxiang)
Address:	No. 51 Shouxiang Science Building, Xueyuan Road, Haidian District, Beijing, P. R. China100191

### 1.2 Testing Environment

Temperature:	18°C~25°C,
Relative humidity:	30%~ 70%
Ground system resistance:	< 0.5 $\Omega$
Ambient noise & Reflection:	< 0.012 W/kg

### 1.3 Project Data

Project Leader:	Qi Dianyuan
Test Engineer:	Lin Xiaojun
Testing Start Date:	August 6, 2019
Testing End Date:	August 11, 2019

### 1.4 Signature



---

Lin Xiaojun  
(Prepared this test report)

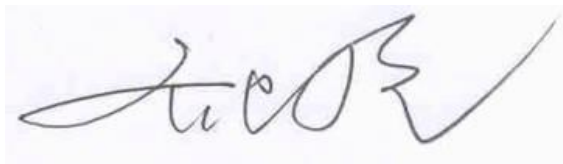

---

Qi Dianyuan  
(Reviewed this test report)

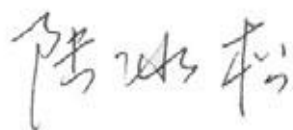

---

Lu Bingsong  
Deputy Director of the laboratory  
(Approved this test report)

## 2 Statement of Compliance

The maximum results of SAR found during testing for TCL Communication Ltd. Smart Phone 5032W are as follows:

**Table 2.1: Highest Reported SAR (1g)**

Exposure Configuration	Technology Band	Highest Reported SAR 1g(W/kg)	Equipment Class
Head (Separation Distance 0mm)	GSM 850	<b>0.16</b>	PCE
	PCS 1900	<b>0.17</b>	
	UMTS FDD 2	<b>0.24</b>	
	UMTS FDD 4	<b>0.14</b>	
	UMTS FDD 5	<b>0.17</b>	
	LTE Band 7	<b>0.06</b>	
	LTE Band 12	<b>0.73</b>	
	LTE Band 13	<b>0.08</b>	
	LTE Band 25	<b>0.34</b>	
	LTE Band 26	<b>0.15</b>	
	LTE Band 41(Power Class 3)	<b>0.02</b>	
	LTE Band 41(Power Class 2)	<b>0.04</b>	
	LTE Band 66	<b>0.17</b>	
	LTE Band 71	<b>0.54</b>	
	WLAN 2.4 GHz	<b>0.87</b>	DTS
WLAN 5 GHz	<b>0.61</b>	UNII	
Hotspot (Separation Distance 10mm)	GSM 850	<b>0.52</b>	PCE
	PCS 1900	<b>1.20</b>	
	UMTS FDD 2	<b>1.03</b>	
	UMTS FDD 4	<b>1.22</b>	
	UMTS FDD 5	<b>0.31</b>	
	LTE Band 7	<b>1.17</b>	
	LTE Band 12	<b>0.35</b>	
	LTE Band 13	<b>0.26</b>	
	LTE Band 25	<b>1.03</b>	
	LTE Band 26	<b>0.36</b>	
	LTE Band 41(Power Class 3)	<b>0.71</b>	
	LTE Band 41(Power Class 2)	<b>1.34</b>	
	LTE Band 66	<b>1.35</b>	
	LTE Band 71	<b>0.26</b>	
	WLAN 2.4 GHz	<b>0.62</b>	DTS
WLAN 5 GHz	<b>1.04</b>	UNII	
Body-worn (Separation Distance 15mm)	PCS 1900	<b>0.50</b>	PCE
	UMTS FDD 2	<b>0.59</b>	
	UMTS FDD 4	<b>1.32</b>	
	LTE Band 25	<b>0.57</b>	
	LTE Band 66	<b>1.37</b>	

The SAR values found for the Mobile Phone are below the maximum recommended levels of 1.6 W/kg as averaged over any 1g tissue according to the ANSI C95.1-1992.

For body operation, this device has been tested and meets FCC RF exposure guidelines when used  
©Copyright. All rights reserved by CTTL.

with any accessory that contains no metal and which provides a minimum separation distance of 10 mm for hotspot and 15mm for body worn between this device and the body of the user. Use of other accessories may not ensure compliance with FCC RF exposure guidelines.

The EUT battery must be fully charged and checked periodically during the test to ascertain uniform power output.

The measurement together with the test system set-up is described in annex C of this test report. A detailed description of the equipment under test can be found in chapter 4 of this test report. The highest reported SAR value is obtained at the case of **(Table 2.1)**, and the values are: **1.37W/kg(1g)**.

**Table 2.2: The sum of reported SAR values for main antenna and WiFi 2.4G**

	Position	band	Main antenna	WiFi	Sum
<b>Highest reported SAR value for Head</b>	Left hand, Touch cheek	LTE Band12	0.71	0.87	<b>1.58</b>
<b>Highest reported SAR value for Body</b>	Rear 10mm	WCDMA1700	1.22	0.62	<b>1.84</b>
		LTE Band7	1.17	0.62	<b>1.79</b>
		LTE Band41 PC2	1.34	0.62	<b>1.96</b>
		LTE Band66	1.31	0.62	<b>1.93</b>
	Rear 15mm	WCDMA1700	1.32	0.30	<b>1.62</b>
		LTE Band66	1.37	0.30	<b>1.67</b>

**Table 2.3 The sum of reported SAR values for main antenna and WiFi 5G**

	Position	band	Main antenna	WiFi	Sum
<b>Highest reported SAR value for Head</b>	Left hand, Touch cheek	LTE Band12	0.71	0.61	<b>1.32</b>
<b>Highest reported SAR value for Body</b>	Rear 10mm	GSM1900	0.82	1.04	<b>1.86</b>
		W1900	0.65	1.04	<b>1.69</b>
		W1700	1.22	1.04	<b>2.26</b>
		LTE Band7	1.17	1.04	<b>2.21</b>
		LTE Band41 PC2	1.34	1.04	<b>2.38</b>
		LTE Band41 PC3	0.71	1.04	<b>1.75</b>
		LTE Band66	1.31	1.04	<b>2.35</b>
	Rear 15mm	W1700	1.32	0.82	<b>2.14</b>
		LTE Band66	1.37	0.82	<b>2.19</b>

According to the KDB 447498 D01, when the sum of SAR is larger than the limit, SAR test exclusion is determined by the SAR to peak location separation ratio. The ratio is determined by  $(SAR_1 + SAR_2)^{1.5}/R_i$ , rounded to two decimal digits, and must be  $\leq 0.04$  for all antenna pairs in the configuration to qualify for 1-g SAR test exclusion. The ratio  $\leq 0.04$ , The detail for simultaneous transmission consideration is described in chapter 13.

**Table 2.3: The sum of reported SAR values for main antenna and BT**

	Position	Main antenna	BT	Sum
<b>Maximum reported SAR value for Head</b>	Left hand, Touch cheek	0.71	0.33 <sup>[1]</sup>	<b>1.04</b>
<b>Maximum reported SAR value for Body</b>	Bottom 10mm	1.35	0.17 <sup>[1]</sup>	<b>1.52</b>
<b>Maximum reported SAR value for Body</b>	Rear 15mm	1.37	0.11 <sup>[1]</sup>	<b>1.48</b>

[1] - Estimated SAR for Bluetooth (see the table 13.4)

According to the above tables, the highest sum of reported SAR values is **2.38 W/kg (1g)**. The detail for simultaneous transmission consideration is described in chapter 13.

### 3 Client Information

#### 3.1 Applicant Information

Company Name:	TCL Communication Ltd.
Address/Post:	7/F, Block F4, TCL Communication Technology Building, TCL International E City, Zhong Shan Yuan Road, Nanshan District, Shenzhen, Guangdong, P.R. China 518052
Contact Person:	Gong Zhizhou
E-mail:	zhizhou.gong@tcl.com
Telephone:	0086-755-36611722

#### 3.2 Manufacturer Information

Company Name:	TCL Communication Ltd.
Address/Post:	7/F, Block F4, TCL Communication Technology Building, TCL International E City, Zhong Shan Yuan Road, Nanshan District, Shenzhen, Guangdong, P.R. China 518052
Contact Person:	Gong Zhizhou
E-mail:	zhizhou.gong@tcl.com
Telephone:	0086-755-36611722



## 4 Equipment Under Test (EUT) and Ancillary Equipment (AE)

### 4.1 About EUT

Description:	Smart Phone
Model name:	5032W
Operating mode(s):	GSM 850/900/1800/1900, UMTS FDD 1/2/4/5, BT, Wi-Fi2.4G/5G LTE Band 1/2/3/4/5/7/12/13/20/25/26/41/66/71
Tested Tx Frequency:	824 – 849 MHz (GSM 850)
	1850 – 1910 MHz (GSM 1900)
	824–849 MHz (WCDMA 850 Band V)
	1710 – 1755 MHz (WCDMA 1700 Band IV)
	1850–1910 MHz (WCDMA1900 Band II)
	2502.5 – 2567.5 MHz(LTE Band 7)
	699.7 – 715.3 MHz (LTE Band 12)
	779.5 –784.5 MHz (LTE Band 13)
	1850.7 – 1914.3 MHz (LTE Band 25)
	814.7 – 848.3 MHz (LTE Band 26)
	2498.5 – 2687.5 MHz (LTE Band 41)
	1710.7 – 1779.3 MHz (LTE Band 66)
	665.5 – 695.5 MHz (LTE Band 71)
	2412 – 2462 MHz (Wi-Fi 2.4G)
5.15 – 5.35 GHz 5.725 – 5.825 GHz(Wi-Fi 5G)	
GPRS/EGPRS Multislot Class:	12
GPRS capability Class:	B
Test device Production information:	Production unit
Device type:	Portable device
Antenna type:	Integrated antenna
Hotspot mode:	Support

### 4.2 Internal Identification of EUT used during the test

EUT ID*	IMEI	HW	SW Version
EUT1	015552000001704	06	3E5H
EUT2	015552000001647	06	3E5H
EUT3	015552000001662	06	3E5H
EUT4	015552000001621	06	3E5H
EUT5	015552000001746	06	3E5H
EUT6	015552000001613	06	3E5H

\*EUT ID: is used to identify the test sample in the lab internally.

**Note:** It is performed to test SAR with the EUT1~4 and conducted power with the EUT5&6.

### 4.3 Internal Identification of AE used during the test

AE ID*	Description	Model	SN	Manufacturer
AE1	Battery	TLp038B1	/	CAC3860001C1

\*AE ID: is used to identify the test sample in the lab internally.

## 5 TEST METHODOLOGY

### 5.1 Applicable Limit Regulations

**ANSI C95.1–1992:**IEEE Standard for Safety Levels with Respect to Human Exposure to Radio Frequency Electromagnetic Fields, 3 kHz to 300 GHz.

It specifies the maximum exposure limit of **1.6 W/kg** as averaged over any 1 gram of tissue for portable devices being used within 20 cm of the user in the uncontrolled environment.

### 5.2 Applicable Measurement Standards

**IEEE 1528–2013:** Recommended Practice for Determining the Peak Spatial-Average Specific Absorption Rate (SAR) in the Human Head from Wireless Communications Devices: Measurement Techniques.

**KDB447498 D01: General RF Exposure Guidance v06:** Mobile and Portable Devices RF Exposure Procedures and Equipment Authorization Policies.

**KDB648474 D04 Handset SAR v01r03:** SAR Evaluation Considerations for Wireless Handsets.

**KDB941225 D01 SAR test for 3G devices v03r01:** SAR Measurement Procedures for 3G Devices

**KDB941225 D05 SAR for LTE Devices v02r05:** SAR Evaluation Considerations for LTE Devices

**KDB941225 D06 Hotspot Mode SAR v02r01:** SAR Evaluation Procedures for Portable Devices with Wireless Router Capabilities

**KDB248227 D01 802.11 Wi-Fi SAR v02r02:** SAR GUIDANCE FOR IEEE 802.11 (Wi-Fi) TRANSMITTERS

**KDB865664 D01 SAR measurement 100 MHz to 6 GHz v01r04:** SAR Measurement Requirements for 100 MHz to 6 GHz.

**KDB865664 D02 RF Exposure Reporting v01r02:** RF Exposure Compliance Reporting and Documentation Considerations

## 6 Specific Absorption Rate (SAR)

### 6.1 Introduction

SAR is related to the rate at which energy is absorbed per unit mass in an object exposed to a radio field. The SAR distribution in a biological body is complicated and is usually carried out by experimental techniques or numerical modeling. The standard recommends limits for two tiers of groups, occupational/controlled and general population/uncontrolled, based on a person's awareness and ability to exercise control over his or her exposure. In general, occupational/controlled exposure limits are higher than the limits for general population/uncontrolled.

### 6.2 SAR Definition

The SAR definition is the time derivative (rate) of the incremental energy ( $dW$ ) absorbed by (dissipated in) an incremental mass ( $dm$ ) contained in a volume element ( $dv$ ) of a given density ( $\rho$ ). The equation description is as below:

$$SAR = \frac{d}{dt} \left( \frac{dW}{dm} \right) = \frac{d}{dt} \left( \frac{dW}{\rho dv} \right)$$

SAR is expressed in units of Watts per kilogram (W/kg)

SAR measurement can be either related to the temperature elevation in tissue by

$$SAR = c \left( \frac{\delta T}{\delta t} \right)$$

Where:  $C$  is the specific heat capacity,  $\delta T$  is the temperature rise and  $\delta t$  is the exposure duration, or related to the electrical field in the tissue by

$$SAR = \frac{\sigma |E|^2}{\rho}$$

Where:  $\sigma$  is the conductivity of the tissue,  $\rho$  is the mass density of tissue and  $E$  is the RMS electrical field strength.

However for evaluating SAR of low power transmitter, electrical field measurement is typically applied.

## 7 Tissue Simulating Liquids

### 7.1 Targets for tissue simulating liquid

Table 7.1: Targets for tissue simulating liquid

Frequency(MHz)	Liquid Type	Conductivity( $\sigma$ )	$\pm 5\%$ Range	Permittivity( $\epsilon$ )	$\pm 5\%$ Range
750	Head	0.89	0.85~0.93	41.94	39.8~44.0
750	Body	0.96	0.91~1.01	55.5	52.7~58.3
835	Head	0.90	0.86~0.95	41.5	39.4~43.6
835	Body	0.97	0.92~1.02	55.2	52.4~58.0
1750	Head	1.37	1.30~1.44	40.08	38.1~42.1
1750	Body	1.49	1.42~1.56	53.4	50.7~56.1
1900	Head	1.40	1.33~1.47	40.0	38.0~42.0
1900	Body	1.52	1.44~1.60	53.3	50.6~56.0
2300	Head	1.67	1.59~1.75	39.47	37.5~41.4
2300	Body	1.85	1.76~1.94	52.8	50.2~55.4
2450	Head	1.80	1.71~1.89	39.2	37.2~41.2
2450	Body	1.95	1.85~2.05	52.7	50.1~55.3
2600	Head	1.96	1.86~2.06	39.01	37.1~41.0
2600	Body	2.16	2.05~2.27	52.5	49.9~55.1
5250	Head	4.71	4.47~4.95	35.93	34.13~37.73
5250	Body	5.36	5.09~5.63	48.9	46.46~51.35
5750	Head	5.22	4.96~5.48	35.36	33.59~37.13
5750	Body	5.94	5.64~6.24	48.3	45.89~50.72

### 7.2 Dielectric Performance

Table 7.2: Dielectric Performance of Tissue Simulating Liquid

Measurement Date (yyyy-mm-dd)	Type	Frequency	Permittivity $\epsilon$	Drift (%)	Conductivity $\sigma$ (S/m)	Drift (%)
2019/8/6	Head	750 MHz	42.71	1.84	0.895	0.56
	Body	750 MHz	54.64	-1.55	0.957	-0.31
2019/8/7	Head	835 MHz	41.49	-0.02	0.918	2.00
	Body	835 MHz	55.01	-0.34	0.964	-0.62
2019/8/8	Head	1750 MHz	39.86	-0.55	1.355	-1.09
	Body	1750 MHz	54.2	1.50	1.495	0.34
2019/8/9	Head	1900 MHz	40.05	0.12	1.375	-1.79
	Body	1900 MHz	53.43	0.24	1.533	0.86
2019/8/10	Head	2450 MHz	38.98	-0.56	1.817	0.94
	Body	2450 MHz	52.56	-0.27	1.933	-0.87
2019/8/10	Head	2600 MHz	39.1	0.23	1.961	0.05
	Body	2600 MHz	53.36	1.64	2.2	1.85
2019/8/11	Head	5250 MHz	36.47	1.50	4.743	0.70
	Body	5250 MHz	48.74	-0.33	5.447	1.62
2019/8/11	Head	5750 MHz	34.96	-1.13	5.183	-0.71
	Body	5750 MHz	48.2	-0.21	5.549	1.07

Note: The liquid temperature is 22.0°C

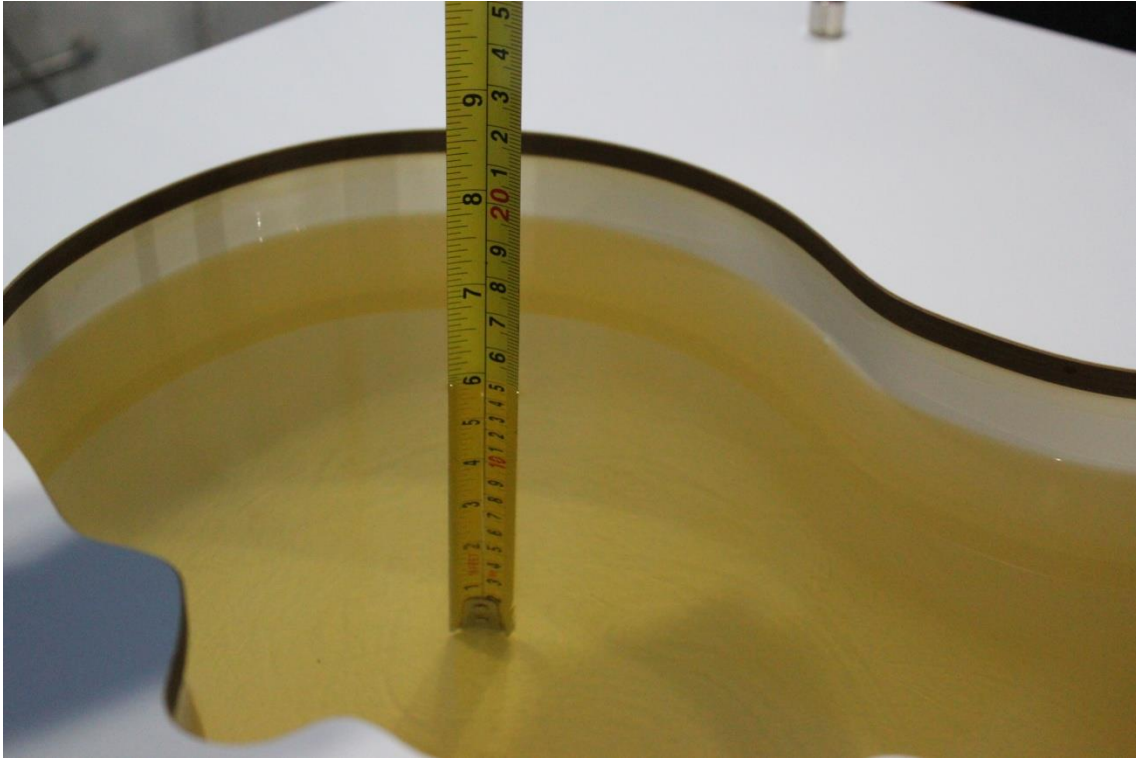

**Picture 7-1 Liquid depth in the Head Phantom (750MHz)**



**Picture 7-2 Liquid depth in the Flat Phantom (750MHz)**

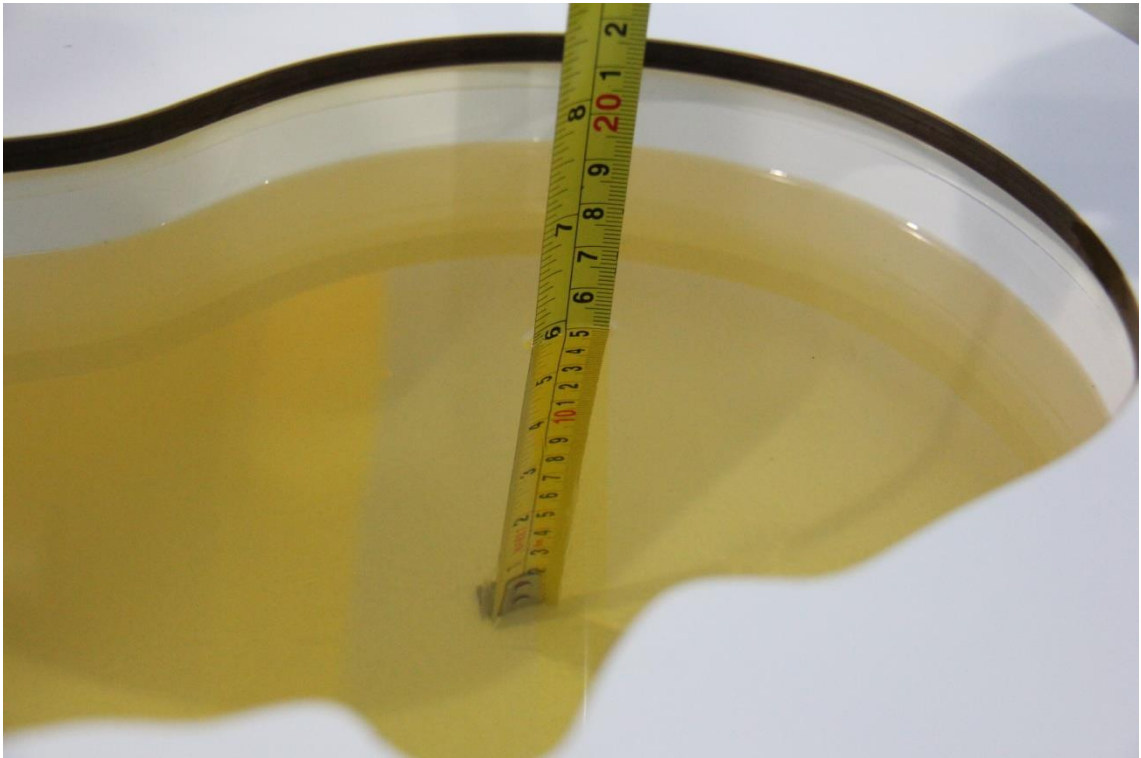

**Picture 7-3 Liquid depth in the Head Phantom (835 MHz)**

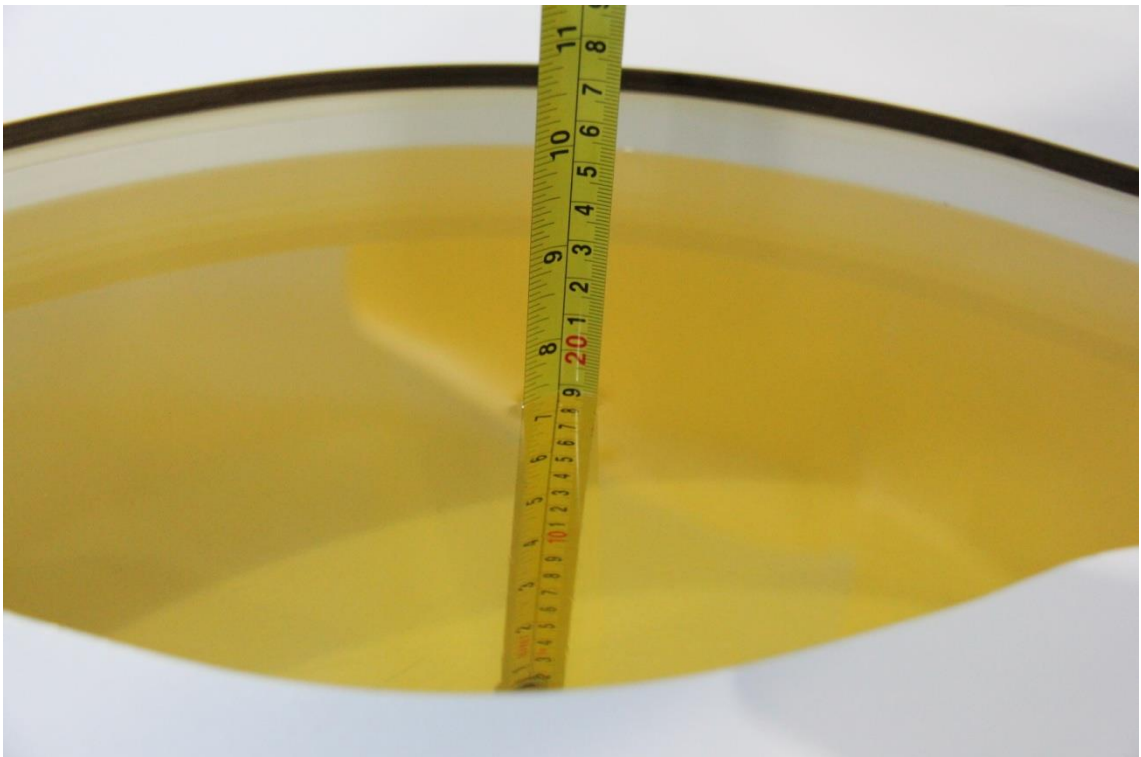

**Picture 7-4 Liquid depth in the Flat Phantom (835 MHz)**

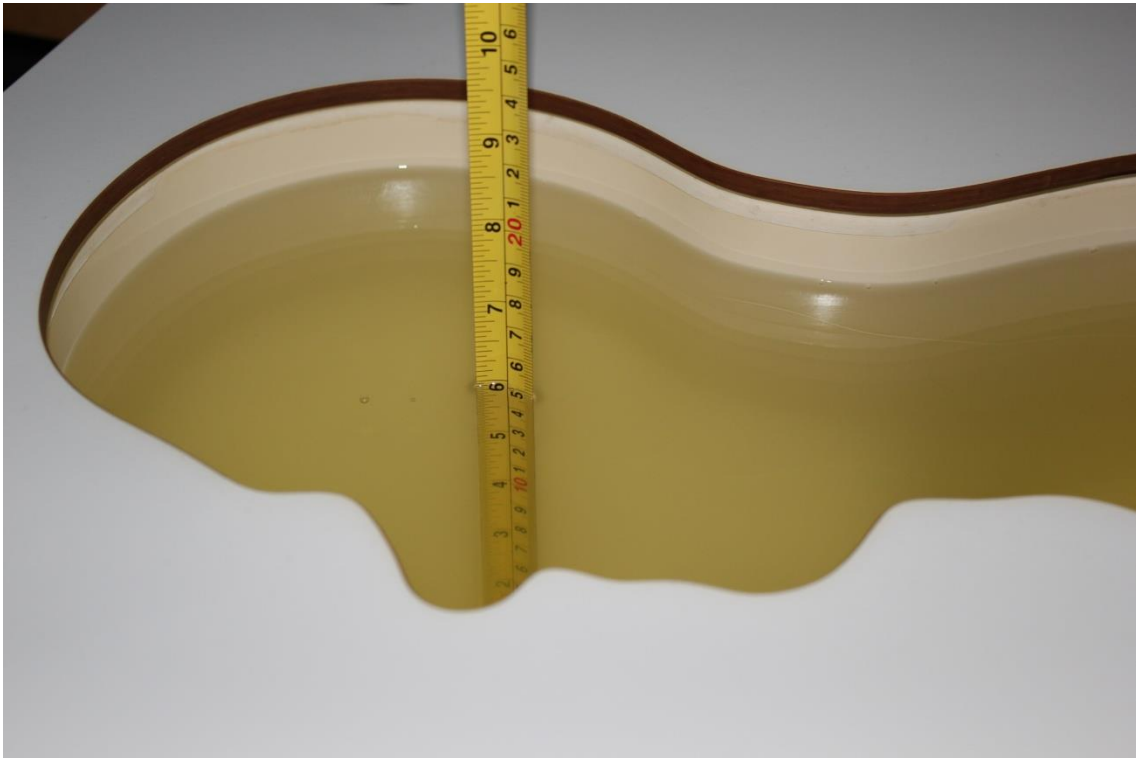

**Picture 7-5 Liquid depth in the Head Phantom (1750 MHz)**

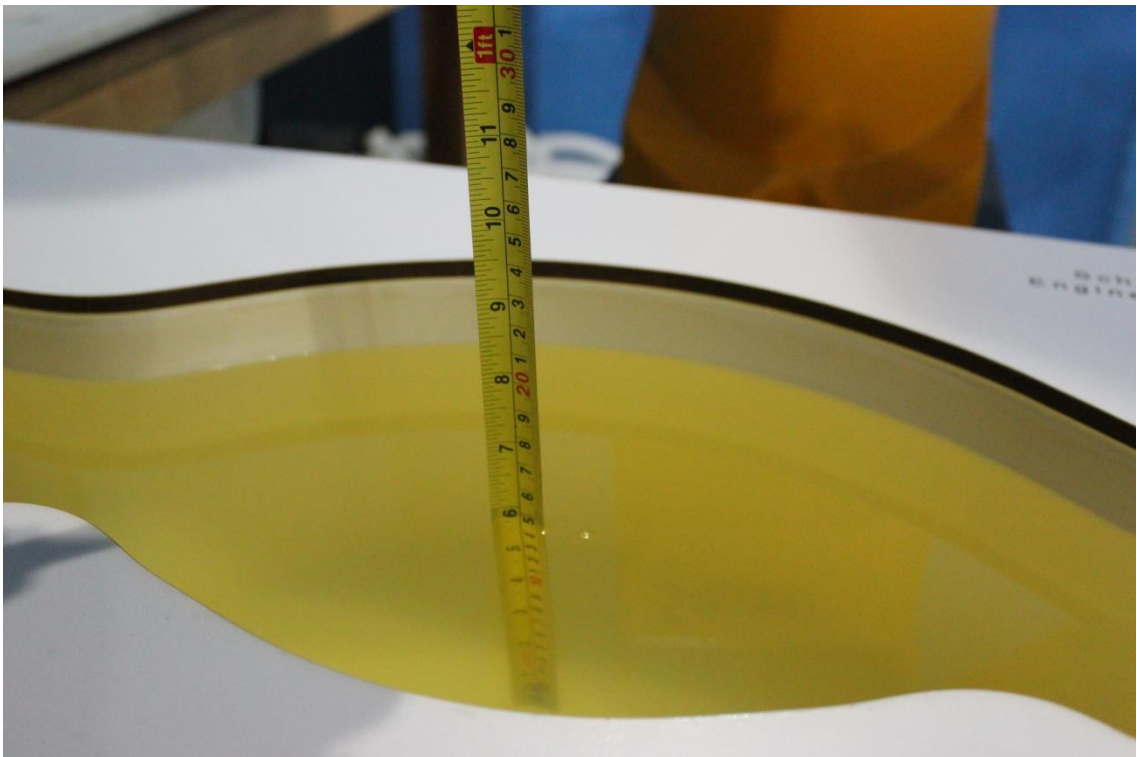

**Picture 7-6 Liquid depth in the Flat Phantom (1750MHz)**

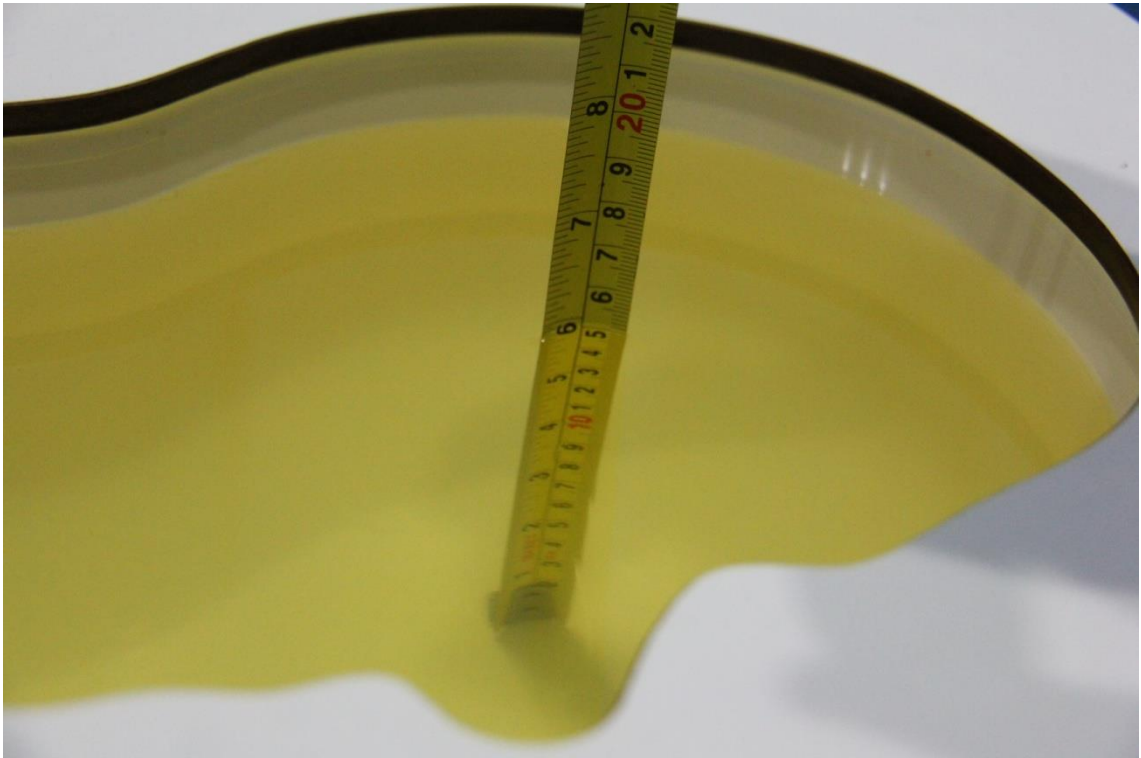

**Picture 7-7 Liquid depth in the Head Phantom (1900 MHz)**



**Picture 7-8 Liquid depth in the Flat Phantom (1900MHz)**



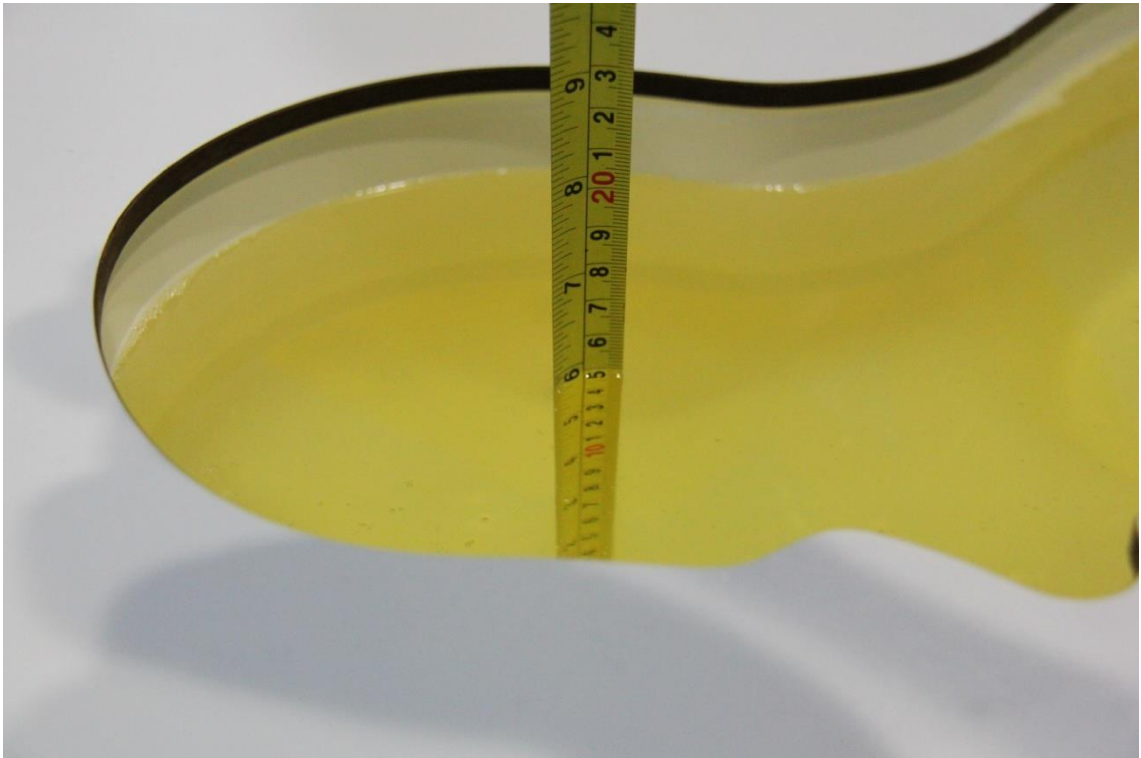

**Picture 7-9 Liquid depth in the Head Phantom (2450MHz)**

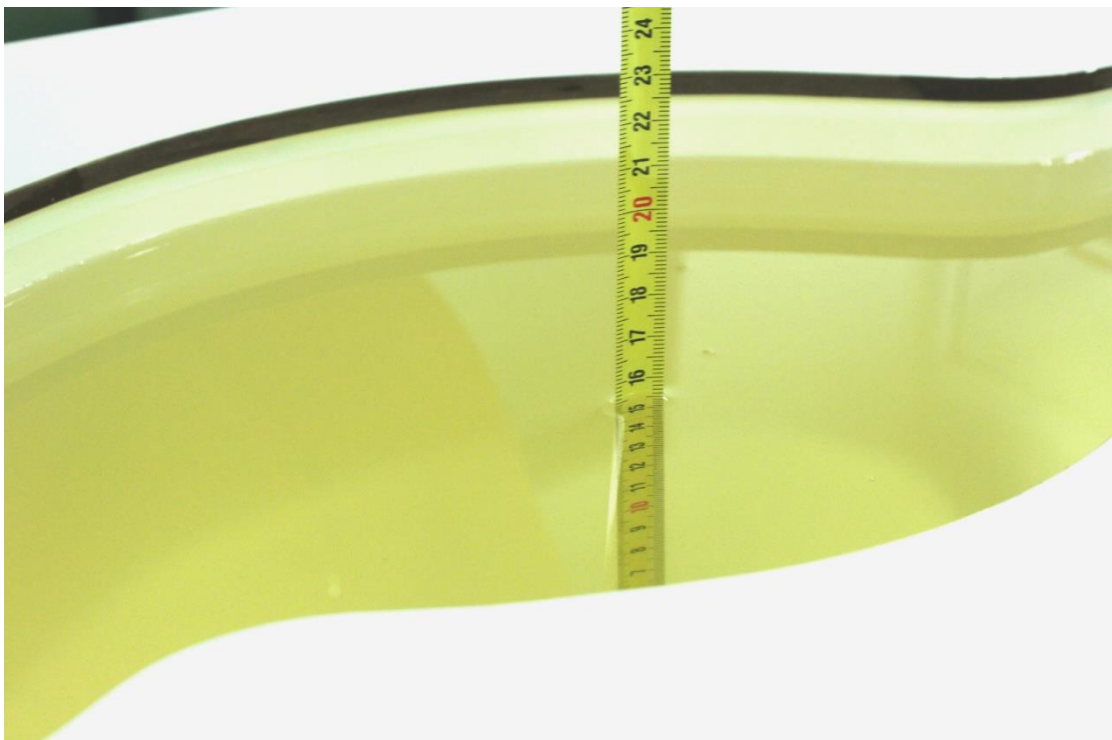

**Picture 7-10 Liquid depth in the Flat Phantom (2450MHz)**



**Picture 7-11 Liquid depth in the Head Phantom (2600 MHz)**

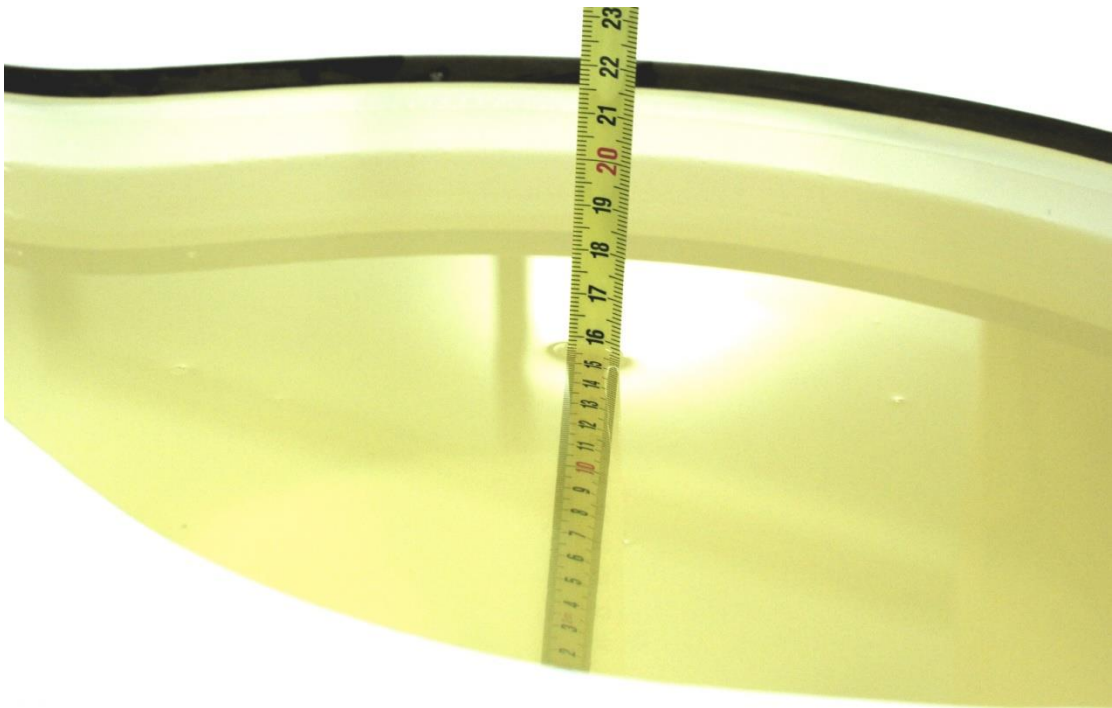

**Picture 7-12 Liquid depth in the Flat Phantom (2600MHz)**



**Picture 7-11 Liquid depth in the Head Phantom (5GHz)**

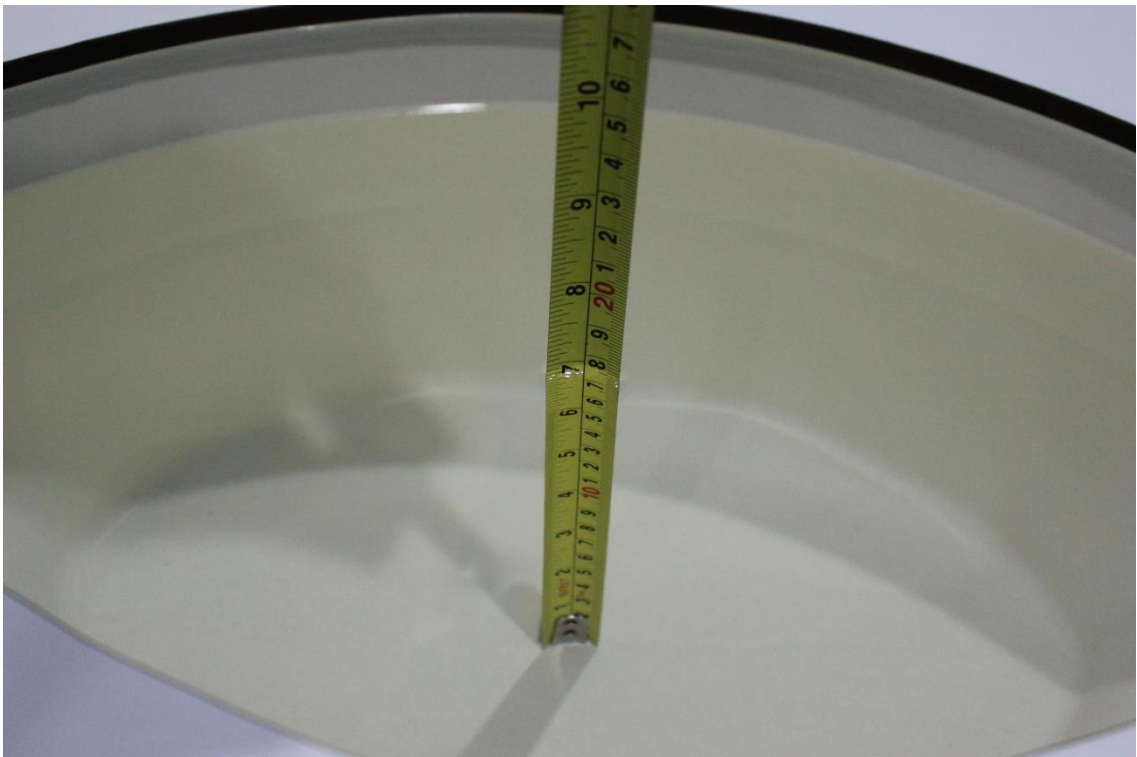

**Picture 7-12 Liquid depth in the Flat Phantom (5GHz)**

## 8 System verification

### 8.1 System Setup

In the simplified setup for system evaluation, the DUT is replaced by a calibrated dipole and the power source is replaced by a continuous wave that comes from a signal generator. The calibrated dipole must be placed beneath the flat phantom section of the SAM twin phantom with the correct distance holder. The distance holder should touch the phantom surface with a light pressure at the reference marking and be oriented parallel to the long side of the phantom. The equipment setup is shown below:

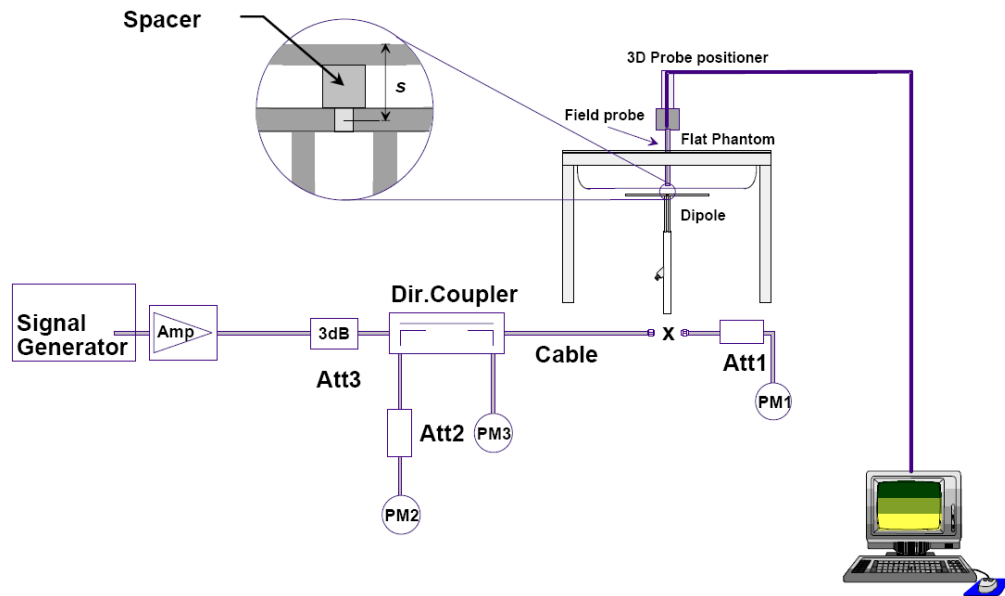

Picture 8.1 System Setup for System Evaluation



Picture 8.2 Photo of Dipole Setup

## 8.2 System Verification

SAR system verification is required to confirm measurement accuracy, according to the tissue dielectric media, probe calibration points and other system operating parameters required for measuring the SAR of a test device. The system verification must be performed for each frequency band and within the valid range of each probe calibration point required for testing the device.

The system verification results are required that the area scan estimated 1-g SAR is within 3% of the zoom scan 1-g SAR. The details are presented in annex B.

**Table 8.1: System Verification of Head**

Measurement Date (yyyy-mm-dd)	Frequency	Target value (W/kg)		Measured value(W/kg)		Deviation	
		10 g Average	1 g Average	10 g Average	1 g Average	10 g Average	1 g Average
2019/8/6	750 MHz	5.34	8.20	5.36	8.2	0.37%	0.00%
2019/8/7	835 MHz	6.06	9.40	6.16	9.4	1.65%	0.00%
2019/8/8	1750 MHz	18.9	35.9	19.12	35.28	1.16%	-1.73%
2019/8/9	1900 MHz	21.3	40.4	21.2	39.6	-0.47%	-1.98%
2019/8/10	2450 MHz	24.2	51.7	23.92	51.68	-1.16%	-0.04%
2019/8/10	2600 MHz	24.9	55.4	24.92	56.04	0.08%	1.16%
2019/8/11	5250 MHz	23.1	80.0	23.2	78.7	0.61%	-1.60%
2019/8/11	5750 MHz	23.0	79.5	22.8	80.7	-1.04%	1.48%

**Table 8.2: System Verification of Body**

Measurement Date (yyyy-mm-dd)	Frequency	Target value (W/kg)		Measured value (W/kg)		Deviation	
		10 g Average	1 g Average	10 g Average	1 g Average	10 g Average	1 g Average
2019/8/6	750 MHz	5.68	8.63	5.64	8.76	-0.70%	1.51%
2019/8/7	835 MHz	6.28	9.53	6.24	9.6	-0.64%	0.73%
2019/8/8	1750 MHz	19.3	36.4	19.2	35.76	-0.52%	-1.76%
2019/8/9	1900 MHz	21.4	40.4	21.2	40.28	-0.93%	-0.30%
2019/8/10	2450 MHz	24.1	51.3	24	52.28	-0.41%	1.91%
2019/8/10	2600 MHz	24.5	54.1	24.76	53.12	1.06%	-1.81%
2019/8/11	5250 MHz	21.2	75.7	21.5	75.0	1.32%	-0.87%
2019/8/11	5750 MHz	21.4	76.9	21.1	76.2	-1.31%	-0.96%

## 9 Measurement Procedures

### 9.1 Tests to be performed

In order to determine the highest value of the peak spatial-average SAR of a handset, all device positions, configurations and operational modes shall be tested for each frequency band according to steps 1 to 3 below. A flowchart of the test process is shown in picture 9.1.

**Step 1:** The tests described in 9.2 shall be performed at the channel that is closest to the centre of the transmit frequency band ( $f_c$ ) for:

- a) all device positions (cheek and tilt, for both left and right sides of the SAM phantom, as described in annex D),
- b) all configurations for each device position in a), e.g., antenna extended and retracted, and
- c) all operational modes, e.g., analogue and digital, for each device position in a) and configuration in b) in each frequency band.

If more than three frequencies need to be tested according to 11.1 (i.e.,  $N_c > 3$ ), then all frequencies, configurations and modes shall be tested for all of the above test conditions.

**Step 2:** For the condition providing highest peak spatial-average SAR determined in Step 1, perform all tests described in 9.2 at all other test frequencies, i.e., lowest and highest frequencies. In addition, for all other conditions (device position, configuration and operational mode) where the peak spatial-average SAR value determined in Step 1 is within 3 dB of the applicable SAR limit, it is recommended that all other test frequencies shall be tested as well.

**Step 3:** Examine all data to determine the highest value of the peak spatial-average SAR found in Steps 1 to 2.

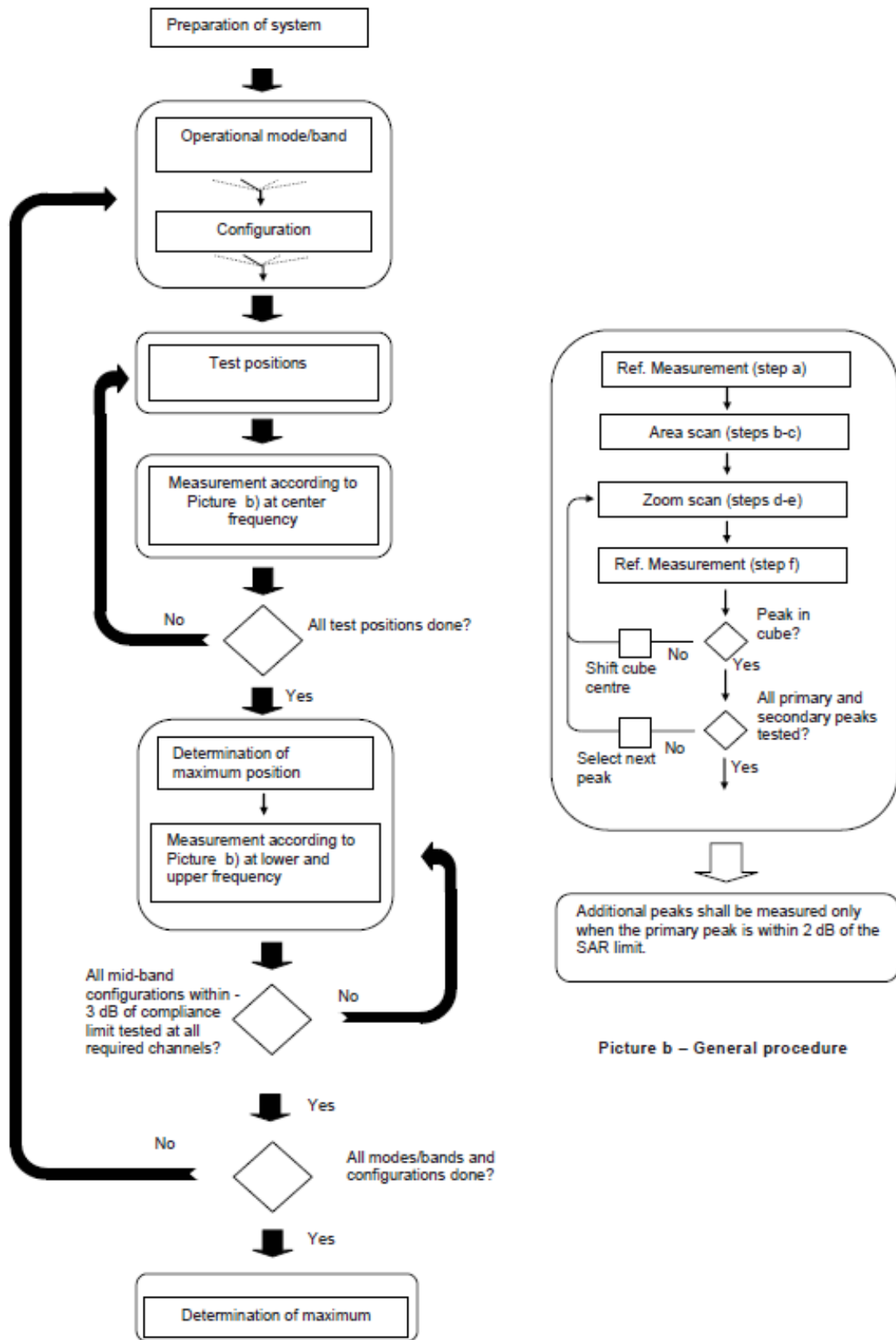

Picture 9.1 Block diagram of the tests to be performed

## 9.2 General Measurement Procedure

The area and zoom scan resolutions specified in the table below must be applied to the SAR measurements and fully documented in SAR reports to qualify for TCB approval. Probe boundary effect error compensation is required for measurements with the probe tip closer than half a probe tip diameter to the phantom surface. Both the probe tip diameter and sensor offset distance must satisfy measurement protocols; to ensure probe boundary effect errors are minimized and the higher fields closest to the phantom surface can be correctly measured and extrapolated to the phantom surface for computing 1-g SAR. Tolerances of the post-processing algorithms must be verified by the test laboratory for the scan resolutions used in the SAR measurements, according to the reference distribution functions specified in IEEE Std 1528-2003. The results should be documented as part of the system validation records and may be requested to support test results when all the measurement parameters in the following table are not satisfied.

		$\leq 3$ GHz	$> 3$ GHz	
Maximum distance from closest measurement point (geometric center of probe sensors) to phantom surface		$5 \pm 1$ mm	$\frac{1}{2} \cdot \delta \cdot \ln(2) \pm 0.5$ mm	
Maximum probe angle from probe axis to phantom surface normal at the measurement location		$30^\circ \pm 1^\circ$	$20^\circ \pm 1^\circ$	
Maximum area scan spatial resolution: $\Delta x_{Area}$ , $\Delta y_{Area}$		$\leq 2$ GHz: $\leq 15$ mm 2 – 3 GHz: $\leq 12$ mm	3 – 4 GHz: $\leq 12$ mm 4 – 6 GHz: $\leq 10$ mm	
		When the x or y dimension of the test device, in the measurement plane orientation, is smaller than the above, the measurement resolution must be $\leq$ the corresponding x or y dimension of the test device with at least one measurement point on the test device.		
Maximum zoom scan spatial resolution: $\Delta x_{Zoom}$ , $\Delta y_{Zoom}$		$\leq 2$ GHz: $\leq 8$ mm 2 – 3 GHz: $\leq 5$ mm*	3 – 4 GHz: $\leq 5$ mm* 4 – 6 GHz: $\leq 4$ mm*	
Maximum zoom scan spatial resolution, normal to phantom surface	uniform grid: $\Delta z_{Zoom}(n)$	$\leq 5$ mm	3 – 4 GHz: $\leq 4$ mm 4 – 5 GHz: $\leq 3$ mm 5 – 6 GHz: $\leq 2$ mm	
	graded grid	$\Delta z_{Zoom}(1)$ : between 1 <sup>st</sup> two points closest to phantom surface	$\leq 4$ mm	3 – 4 GHz: $\leq 3$ mm 4 – 5 GHz: $\leq 2.5$ mm 5 – 6 GHz: $\leq 2$ mm
		$\Delta z_{Zoom}(n>1)$ : between subsequent points	$\leq 1.5 \cdot \Delta z_{Zoom}(n-1)$	
Minimum zoom scan volume	x, y, z	$\geq 30$ mm	3 – 4 GHz: $\geq 28$ mm 4 – 5 GHz: $\geq 25$ mm 5 – 6 GHz: $\geq 22$ mm	
<p>Note: <math>\delta</math> is the penetration depth of a plane-wave at normal incidence to the tissue medium; see draft standard IEEE P1528-2011 for details.</p> <p>* When zoom scan is required and the <i>reported</i> SAR from the area scan based 1-g SAR estimation procedures of KDB 447498 is <math>\leq 1.4</math> W/kg, <math>\leq 8</math> mm, <math>\leq 7</math> mm and <math>\leq 5</math> mm zoom scan resolution may be applied, respectively, for 2 GHz to 3 GHz, 3 GHz to 4 GHz and 4 GHz to 6 GHz.</p>				



### 9.3 WCDMA Measurement Procedures for SAR

The following procedures are applicable to WCDMA handsets operating under 3GPP Release99, Release 5 and Release 6. The default test configuration is to measure SAR with an established radio link between the DUT and a communication test set using a 12.2kbps RMC (reference measurement channel) configured in Test Loop Mode 1. SAR is selectively confirmed for other physical channel configurations (DPCCH & DPDCH<sub>n</sub>), HSDPA and HSPA (HSUPA/HSDPA) modes according to output power, exposure conditions and device operating capabilities. Both uplink and downlink should be configured with the same RMC or AMR, when required. SAR for Release 5 HSDPA and Release 6 HSPA are measured using the applicable FRC (fixed reference channel) and E-DCH reference channel configurations. Maximum output power is verified according to applicable versions of 3GPP TS 34.121 and SAR must be measured according to these maximum output conditions. When Maximum Power Reduction (MPR) is not implemented according to Cubic Metric (CM) requirements for Release 6 HSPA, the following procedures do not apply.

#### For Release 5 HSDPA Data Devices:

Sub-test	$\beta_c$	$\beta_d$	$\beta_d$ (SF)	$\beta_c / \beta_d$	$\beta_{hs}$	CM/dB
1	2/15	15/15	64	2/15	4/15	0.0
2	12/15	15/15	64	12/15	24/25	1.0
3	15/15	8/15	64	15/8	30/15	1.5
4	15/15	4/15	64	15/4	30/15	1.5

#### For Release 6 HSPA Data Devices

Sub-test	$\beta_c$	$\beta_d$	$\beta_d$ (SF)	$\beta_c / \beta_d$	$\beta_{hs}$	$\beta_{ec}$	$\beta_{ed}$	$\beta_{ed}$ (SF)	$\beta_{ed}$ (codes)	CM (dB)	MPR (dB)	AG Index	E-TFCI
1	11/15	15/15	64	11/15	22/15	209/225	1039/225	4	1	1.5	1.5	20	75
2	6/15	15/15	64	6/15	12/15	12/15	12/15	4	1	1.5	1.5	12	67
3	15/15	9/15	64	15/9	30/15	30/15	$\beta_{ed1}:47/15$ $\beta_{ed2}:47/15$	4	2	1.5	1.5	15	92
4	2/15	15/15	64	2/15	4/15	4/15	56/75	4	1	1.5	1.5	17	71
5	15/15	15/15	64	15/15	24/15	30/15	134/15	4	1	1.5	1.5	21	81

#### Rel.8 DC-HSDPA (Cat 24)

SAR test exclusion for Rel.8 DC-HSDPA must satisfy the SAR test exclusion requirements of Rel.5 HSDPA. SAR test exclusion for DC-HSDPA devices is determined by power measurements according to the H-Set 12, Fixed Reference Channel (FRC) configuration in Table C.8.1.12 of 3GPP TS 34.121-1. A primary and a secondary serving HS-DSCH Cell are required to perform the power measurement and for the results to qualify for SAR test exclusion.

## 9.4 SAR Measurement for LTE

SAR tests for LTE are performed with a base station simulator, Rohde & Schwarz CMW500. Closed loop power control was used so the UE transmits with maximum output power during SAR testing. All powers were measured with the CMW 500.

It is performed for conducted power and SAR based on the KDB941225 D05.

SAR is evaluated separately according to the following procedures for the different test positions in each exposure condition – head, body, body-worn accessories and other use conditions. The procedures in the following subsections are applied separately to test each LTE frequency band.

### 1) QPSK with 1 RB allocation

Start with the largest channel bandwidth and measure SAR for QPSK with 1 RB allocation, using the RB offset and required test channel combination with the highest maximum output power among RB offsets at the upper edge, middle and lower edge of each required test channel. When the reported SAR is  $\leq 0.8$  W/kg, testing of the remaining RB offset configurations and required test channels is not required for 1 RB allocation; otherwise, SAR is required for the remaining required test channels and only for the RB offset configuration with the highest output power for that channel. When the reported SAR of a required test channel is  $> 1.45$  W/kg, SAR is required for all three RB offset configurations for that required test channel.

### 2) QPSK with 50% RB allocation

The procedures required for 1 RB allocation in 1) are applied to measure the SAR for QPSK with 50% RB allocation.

### 3) QPSK with 100% RB allocation

For QPSK with 100% RB allocation, SAR is not required when the highest maximum output power for 100 % RB allocation is less than the highest maximum output power in 50% and 1 RB allocations and the highest reported SAR for 1 RB and 50% RB allocation in 1) and 2) are  $\leq 0.8$  W/kg. Otherwise, SAR is measured for the highest output power channel; and if the reported SAR is  $> 1.45$  W/kg, the remaining required test channels must also be tested.

## 9.5 Bluetooth & Wi-Fi Measurement Procedures for SAR

Normal network operating configurations are not suitable for measuring the SAR of 802.11 transmitters in general. Unpredictable fluctuations in network traffic and antenna diversity conditions can introduce undesirable variations in SAR results. The SAR for these devices should be measured using chipset based test mode software to ensure that the results are consistent and reliable.

Chipset based test mode software is hardware dependent and generally varies among manufacturers. The device operating parameters established in a test mode for SAR measurements must be identical to those programmed in production units, including output power levels, amplifier gain settings and other RF performance tuning parameters. The test frequencies should correspond to actual channel frequencies defined for domestic use. SAR for devices with switched diversity should be measured with only one antenna transmitting at a time during each SAR measurement, according to a fixed modulation and data rate. The same data pattern should be used for all measurements.

## 9.6 Power Drift

To control the output power stability during the SAR test, DASY4 system calculates the power drift by measuring the E-field at the same location at the beginning and at the end of the measurement for each test position. These drift values can be found in section 14 labeled as: (Power Drift [dB]). This ensures that the power drift during one measurement is within 5%.

## 10 Area Scan Based 1-g SAR

### 10.1 Requirement of KDB

According to the KDB447498 D01 v05, when the implementation is based on the specific polynomial fit algorithm as presented at the 29th Bioelectromagnetics Society meeting (2007) and the estimated 1-g SAR is  $\leq 1.2$  W/kg, a zoom scan measurement is not required provided it is also not needed for any other purpose; for example, if the peak SAR location required for simultaneous transmission SAR test exclusion can be determined accurately by the SAR system or manually to discriminate between distinctive peaks and scattered noisy SAR distributions from area scans.

There must not be any warning or alert messages due to various measurement concerns identified by the SAR system; for example, noise in measurements, peaks too close to scan boundary, peaks are too sharp, spatial resolution and uncertainty issues etc. The SAR system verification must also demonstrate that the area scan estimated 1-g SAR is within 3% of the zoom scan 1-g SAR (See Annex B). When all the SAR results for each exposure condition in a frequency band and wireless mode are based on estimated 1-g SAR, the 1-g SAR for the highest SAR configuration must be determined by a zoom scan.

### 10.2 Fast SAR Algorithms

The approach is based on the area scan measurement applying a frequency dependent attenuation parameter. This attenuation parameter was empirically determined by analyzing a large number of phones. The MOTOROLA FAST SAR was developed and validated by the MOTOROLA Research Group in Ft. Lauderdale.

In the initial study, an approximation algorithm based on Linear fit was developed. The accuracy of the algorithm has been demonstrated across a broad frequency range (136-2450 MHz) and for both 1- and 10-g averaged SAR using a sample of 264 SAR measurements from 55 wireless handsets. For the sample size studied, the root-mean-squared errors of the algorithm are 1.2% and 5.8% for 1- and 10-g averaged SAR, respectively. The paper describing the algorithm in detail is expected to be published in August 2004 within the Special Issue of Transactions on MTT.

In the second step, the same research group optimized the fitting algorithm to an Polynomial fit whereby the frequency validity was extended to cover the range 30-6000 MHz. Details of this study can be found in the BEMS 2007 Proceedings.

Both algorithms are implemented in DASY software.

## 11 Conducted Output Power

For Main antenna, there are two sets of tune-up power, Normal power and Low power, used for different use cases for PCS1900/WCDMA1700/ WCDMA1900 and LTE Band25/66. Normal power status is applied for head test and body worn test of above bands. Low power status is applied for hotspot test of above bands. For other bands, Normal power status is applied for both head and body test.

For WIFI antenna, there are two sets of tune-up power, Normal power and Low power, Normal power status is applied for Body, Low power status is applied for receiver test of Head.

### 11.1 GSM Measurement result

During the process of testing, the EUT was controlled via Agilent Digital Radio Communication tester (E5515C) to ensure the maximum power transmission and proper modulation. This result contains conducted output power for the EUT. In all cases, the measured peak output power should be greater and within 5% than EMI measurement.

#### Normal Power

**Table 11.1-1: The conducted power measurement results for GSM, GPRS and EGPRS**

GSM 850 Speech (GMSK)	Measured Power (dBm)			Tune up	calculation	Averaged Power (dBm)		
	251	190	128			251	190	128
1 Txslot	32.18	32.17	32.14	33.50	/	/	/	/
GSM 850 GPRS (GMSK)	Measured Power (dBm)				calculation	Averaged Power (dBm)		
	251	190	128			251	190	128
1 Txslot	32.19	32.17	32.14	33.50	-9.03	23.16	23.14	23.11
2 Txslots	31.62	31.61	31.58	32.50	-6.02	25.60	25.59	25.56
3Txslots	30.08	30.05	30.02	30.50	-4.26	25.82	25.79	25.76
<b>4 Txslots</b>	<b>28.99</b>	<b>28.97</b>	<b>28.93</b>	<b>29.50</b>	<b>-3.01</b>	<b>25.98</b>	<b>25.96</b>	<b>25.92</b>
GSM 850 EGPRS (GMSK)	Measured Power (dBm)				calculation	Averaged Power (dBm)		
	251	190	128			251	190	128
1 Txslot	32.18	32.16	32.13	33.50	-9.03	23.15	23.13	23.10
2 Txslots	31.61	31.60	31.57	32.50	-6.02	25.59	25.58	25.55
3Txslots	30.07	30.04	30.01	30.50	-4.26	25.81	25.78	25.75
<b>4 Txslots</b>	<b>28.99</b>	<b>28.96</b>	<b>28.92</b>	<b>29.50</b>	<b>-3.01</b>	<b>25.98</b>	<b>25.95</b>	<b>25.91</b>
GSM 850 EGPRS (8PSK)	Measured Power (dBm)				calculation	Averaged Power (dBm)		
	251	190	128			251	190	128
1 Txslot	27.37	27.12	27.17	28.00	-9.03	18.34	18.09	18.14
2 Txslots	26.11	26.06	26.02	27.00	-6.02	20.09	20.04	20.00
3Txslots	24.05	24.08	24.09	25.00	-4.26	19.79	19.82	19.83
4 Txslots	22.83	22.78	22.73	24.00	-3.01	19.82	19.77	19.72
PCS1900 Speech (GMSK)	Measured Power (dBm)			Tune up	calculation	Averaged Power (dBm)		
	810	661	512			810	661	512
1 Txslot	30.19	30.20	30.21	31.00	/	/	/	/
PCS1900	Measured Power (dBm)				calculation	Averaged Power (dBm)		

GPRS (GMSK)	810	661	512			810	661	512
1 Txslot	30.17	30.20	30.17	31.00	-9.03	21.14	21.17	21.14
<b>2 Txslots</b>	<b>29.50</b>	<b>29.48</b>	<b>29.45</b>	<b>30.00</b>	<b>-6.02</b>	<b>23.48</b>	<b>23.46</b>	<b>23.43</b>
3Txslots	27.43	27.38	27.33	28.00	-4.26	23.17	23.12	23.07
4 Txslots	26.47	26.44	26.42	27.00	-3.01	23.46	23.43	23.41
PCS1900	Measured Power (dBm)				calculation	Averaged Power (dBm)		
EGPRS (GMSK)	810	661	512			810	661	512
1 Txslot	30.19	30.20	30.18	31.00	-9.03	21.16	21.17	21.15
<b>2 Txslots</b>	<b>29.47</b>	<b>29.48</b>	<b>29.43</b>	<b>30.00</b>	<b>-6.02</b>	<b>23.45</b>	<b>23.46</b>	<b>23.41</b>
3Txslots	27.45	27.38	27.34	28.00	-4.26	23.19	23.12	23.08
4 Txslots	26.40	26.44	26.42	27.00	-3.01	23.39	23.43	23.41
PCS1900	Measured Power (dBm)				calculation	Averaged Power (dBm)		
EGPRS (8PSK)	810	661	512			810	661	512
1 Txslot	26.26	26.37	26.44	27.00	-9.03	17.23	17.34	17.41
2 Txslots	25.06	25.26	25.38	26.00	-6.02	19.04	19.24	19.36
3Txslots	22.81	23.07	23.06	24.00	-4.26	18.55	18.81	18.80
4 Txslots	21.63	21.70	21.82	23.00	-3.01	18.62	18.69	18.81

NOTES:

1) Division Factors

To average the power, the division factor is as follows:

1TX-slot = 1 transmit time slot out of 8 time slots=> conducted power divided by (8/1) => -9.03dB

2TX-slots = 2 transmit time slots out of 8 time slots=> conducted power divided by (8/2) => -6.02dB

3TX-slots = 3 transmit time slots out of 8 time slots=> conducted power divided by (8/3) => -4.26dB

4TX-slots = 4 transmit time slots out of 8 time slots=> conducted power divided by (8/4) => -3.01dB

**According to the conducted power as above, the body measurements are performed with 4Txslots for GSM850 and 2Txslots for GSM1900.**

**Low Power**

PCS1900 Speech (GMSK)	Measured Power (dBm)			<b>Tune up</b>	calculation	Averaged Power (dBm)		
	810	661	512			810	661	512
1 Txslot	29.61	29.59	29.55	30.00	/	/	/	/
PCS1900	Measured Power (dBm)				calculation	Averaged Power (dBm)		
GPRS (GMSK)	810	661	512			810	661	512
1 Txslot	29.60	29.57	29.53	30.00	-9.03	20.57	20.54	20.50
2 Txslots	29.61	29.58	29.55	30.00	-6.02	23.59	23.56	23.53
3Txslots	27.87	27.82	27.80	28.00	-4.26	23.61	23.56	23.54
<b>4 Txslots</b>	<b>26.84</b>	<b>26.79</b>	<b>26.61</b>	<b>27.00</b>	<b>-3.01</b>	<b>23.83</b>	<b>23.78</b>	<b>23.60</b>
PCS1900	Measured Power (dBm)				calculation	Averaged Power (dBm)		
EGPRS (GMSK)	810	661	512			810	661	512
1 Txslot	29.60	29.57	29.53	30.00	-9.03	20.57	20.54	20.50
2 Txslots	29.61	29.59	29.55	30.00	-6.02	23.59	23.57	23.53

3Txslots	27.87	27.82	27.80	28.00	-4.26	23.61	23.56	23.54
<b>4 Txslots</b>	<b>26.84</b>	<b>26.79</b>	<b>26.61</b>	<b>27.00</b>	<b>-3.01</b>	<b>23.83</b>	<b>23.78</b>	<b>23.60</b>
PCS1900 EGPRS (8PSK)	Measured Power (dBm)				calculation	Averaged Power (dBm)		
	810	661	512			810	661	512
1 Txslot	25.58	25.70	25.77	26.00	-9.03	16.55	16.67	16.74
2 Txslots	25.23	25.50	25.72	26.00	-6.02	19.21	19.48	19.70
3Txslots	23.10	23.86	23.40	24.00	-4.26	18.84	19.60	19.14
4 Txslots	21.68	21.99	22.14	23.00	-3.01	18.67	18.98	19.13

NOTES:

1) Division Factors

To average the power, the division factor is as follows:

1TX-slot = 1 transmit time slot out of 8 time slots=> conducted power divided by (8/1) => -9.03dB

2TX-slots = 2 transmit time slots out of 8 time slots=> conducted power divided by (8/2) => -6.02dB

3TX-slots = 3 transmit time slots out of 8 time slots=> conducted power divided by (8/3) => -4.26dB

4TX-slots = 4 transmit time slots out of 8 time slots=> conducted power divided by (8/4) => -3.01dB

**According to the conducted power as above, the body measurements are performed with 4Txslots for GSM1900.**

## 11.2 WCDMA Measurement result

Normal power

**Table 11.2-1: The conducted Power for WCDMA**

Item	band	FDDV result			
	ARFCN	4233 (846.6MHz)	4182 (836.4MHz)	4132 (826.4MHz)	Tune up
WCDMA	\	23.53	23.51	23.48	24.00
HSUPA	1	20.52	20.53	20.50	21.00
	2	20.53	20.54	20.47	21.00
	3	21.49	21.40	21.41	22.00
	4	20.00	19.98	19.94	21.00
	5	21.43	21.41	21.39	22.00
HSPA+	1	22.08	21.99	21.78	23.00
DC-HSDPA	1	22.49	22.51	22.40	23.00
	2	22.45	22.48	22.31	23.00
	3	21.94	21.96	21.92	23.00
	4	21.94	21.93	21.88	23.00
Item	band	FDDIV result			
	ARFCN	1513 (1752.6MHz)	1412 (1732.4MHz)	1312 (1712.4MHz)	
WCDMA	\	23.61	23.55	23.58	24.00
HSUPA	1	20.16	20.14	20.22	21.00
	2	20.31	20.25	20.27	21.00
	3	21.26	21.22	21.24	22.00
	4	19.73	19.71	19.75	21.00

	5	21.27	21.24	21.23	22.00
HSPA+	1	21.80	21.87	21.69	22.00
DC-HSDPA	1	22.28	22.23	22.25	23.00
	2	22.18	22.17	22.14	23.00
	3	21.76	21.72	21.77	23.00
	4	21.72	21.68	21.75	23.00
Item	band	FDDII result			
	ARFCN	9538 (1907.6MHz)	9400 (1880MHz)	9262 (1852.4MHz)	Tune up
WCDMA	\	23.68	23.64	23.57	24.00
HSUPA	1	20.56	20.53	20.51	21.00
	2	20.64	20.65	20.61	21.00
	3	21.62	21.60	21.57	22.00
	4	20.14	20.11	20.06	21.00
	5	21.58	21.56	21.55	22.00
HSPA+	1	22.07	22.20	22.07	23.00
DC-HSDPA	1	22.43	22.44	22.41	23.00
	2	22.61	22.49	22.57	23.00
	3	22.2	22.10	22.08	23.00
	4	22.17	22.20	22.05	23.00

Low power

Table 11.2-2: The conducted Power for WCDMA

Item	band	FDDIV result			
	ARFCN	1513 (1752.6MHz)	1412(1732.4MHz)	1312 (1712.4MHz)	Tune up
WCDMA	\	19.30	19.31	19.32	20.00
HSUPA	1	17.36	17.35	17.34	18.00
	2	17.38	17.35	17.30	18.00
	3	18.37	18.34	18.32	19.00
	4	16.84	16.85	16.84	18.00
	5	18.33	18.32	18.29	19.00
HSPA+	1	18.85	18.86	18.81	19.00
DC-HSDPA	1	18.37	18.35	18.37	19.00
	2	18.38	18.41	18.35	19.00
	3	17.13	17.11	17.15	18.00
	4	17.92	17.94	17.94	19.00
Item	band	FDDII result			
	ARFCN	9538 (1907.6MHz)	9400 (1880MHz)	9262 (1852.4MHz)	Tune up
WCDMA	\	21.71	21.69	21.57	22.00
HSUPA	1	19.71	19.69	19.63	20.00
	2	19.71	19.65	19.64	20.00
	3	20.7	20.70	20.66	21.00
	4	19.21	19.18	19.14	19.50
	5	20.68	20.67	20.61	21.00

<b>HSPA+</b>	<b>1</b>	21.14	21.09	21.07	21.50
<b>DC-HSDPA</b>	<b>1</b>	20.8	20.84	20.81	21.00
	<b>2</b>	20.79	20.83	20.75	21.00
	<b>3</b>	19.54	19.55	19.51	21.00
	<b>4</b>	20.32	20.31	20.27	21.00

### 11.3 LTE Measurement result

**Table 11.3-1: Maximum Power Reduction (MPR) for LTE**

Modulation	Channel bandwidth / Transmission bandwidth configuration [RB]						MPR (dB)
	1.4	3	5	10	15	20	
	MHz	MHz	MHz	MHz	MHz	MHz	
QPSK	> 5	> 4	> 8	> 12	> 16	> 18	1
16 QAM	≤ 5	≤ 4	≤ 8	≤ 12	≤ 16	≤ 18	1
16 QAM	> 5	> 4	> 8	> 12	> 16	> 18	2

**Table 11.3-2: The tune up for LTE – Normal Power**

Band	Tune up
LTE Band 7	24
LTE Band 12	24
LTE Band 13	24
LTE Band 25	24
LTE Band 26	24
LTE Band 41 Power Class 2	27
LTE Band 41 Power Class 3	24
LTE Band 66	24
LTE Band 71	24

**Table 11.3-3: The tune up for LTE – Low Power**

Band	Tune up
LTE Band 25 QPSK/16QAM	23
LTE Band 25 64QAM	22
LTE Band 66	20



**Normal power**

**Table 11.3-4: The conducted Power for LTE**

Band 7						
Bandwidth (MHz)	RB allocation	Frequency (MHz)	QPSK	16QAM	64QAM	
	RB offset (Start RB)		Actual output power (dBm)	Actual output power (dBm)	Actual output power (dBm)	
5 MHz	1RB High (24)	2567.5	23.29	22.38	21.52	
		2535	23.27	22.27	21.71	
		2502.5	22.97	22.47	21.39	
	1RB Middle (12)	2567.5	23.50	22.52	21.59	
		2535	23.49	22.46	21.74	
		2502.5	23.24	22.71	21.51	
	1RB Low (0)	2567.5	23.21	22.29	21.52	
		2535	23.26	22.25	21.73	
		2502.5	22.95	22.39	21.31	
	12RB High (13)	2567.5	22.33	21.36	20.48	
		2535	22.23	21.28	20.67	
		2502.5	22.08	21.12	20.34	
	12RB Middle (6)	2567.5	22.38	21.44	20.56	
		2535	22.29	21.29	20.74	
		2502.5	22.08	21.18	20.36	
	12RB Low (0)	2567.5	22.35	21.42	20.55	
		2535	22.30	21.31	20.71	
		2502.5	22.05	21.15	20.29	
	25RB (0)	2567.5	22.32	21.30	20.49	
		2535	22.28	21.26	20.72	
		2502.5	22.04	21.06	20.30	
	10 MHz	1RB High (49)	2565	23.31	22.37	21.62
			2535	23.28	22.20	21.83
			2505	23.17	22.49	21.60
1RB Middle (24)		2565	23.39	22.36	21.72	
		2535	23.46	22.22	21.93	
		2505	23.18	22.48	21.67	
1RB Low (0)		2565	23.28	22.29	21.69	
		2535	23.27	22.09	21.82	
		2505	23.07	22.30	21.44	
25RB High (25)		2565	22.30	21.45	20.48	
		2535	22.30	21.27	20.71	
		2505	22.17	21.22	20.52	
25RB Middle (12)		2565	22.39	21.47	20.57	
		2535	22.35	21.33	20.76	
		2505	22.14	21.15	20.44	
25RB Low (0)		2565	22.40	21.49	20.60	
		2535	22.36	21.31	20.82	
		2505	22.10	21.11	20.35	
50RB (0)		2565	22.38	21.37	20.55	
		2535	22.27	21.29	20.75	

		2505	22.15	21.12	20.46
15 MHz	1RB High (74)	2562.5	23.29	22.59	21.58
		2535	23.13	22.10	21.72
		2507.5	23.00	22.36	21.72
	1RB Middle (37)	2562.5	23.32	22.60	21.74
		2535	23.23	22.04	21.75
		2507.5	23.03	22.37	21.64
	1RB Low (0)	2562.5	23.27	22.63	21.77
		2535	23.15	21.96	21.75
		2507.5	22.94	22.26	21.39
	36RB High (38)	2562.5	22.38	21.29	20.48
		2535	22.34	21.24	20.66
		2507.5	22.20	21.21	20.57
	36RB Middle (19)	2562.5	22.44	21.31	20.59
		2535	22.35	21.24	20.75
		2507.5	22.10	21.13	20.44
	36RB Low (0)	2562.5	22.41	21.27	20.62
		2535	22.40	21.28	20.77
		2507.5	22.07	21.08	20.33
75RB (0)	2562.5	22.39	21.30	20.53	
	2535	22.39	21.30	20.71	
	2507.5	22.12	21.15	20.43	
20 MHz	1RB High (99)	2560	23.17	22.59	21.47
		2535	23.14	22.58	21.64
		2510	22.94	22.46	21.55
	1RB Middle (50)	2560	23.43	22.83	21.74
		2535	23.38	22.58	21.81
		2510	23.27	22.75	21.61
	1RB Low (0)	2560	23.12	22.62	21.72
		2535	23.06	22.36	21.64
		2510	22.86	22.34	21.30
	50RB High (50)	2560	22.20	21.24	20.34
		2535	22.23	21.19	20.61
		2510	22.19	21.22	20.56
	50RB Middle (25)	2560	22.29	21.35	20.54
		2535	22.27	21.21	20.68
		2510	22.10	21.13	20.46
	50RB Low (0)	2560	22.19	21.22	20.47
		2535	22.27	21.27	20.80
		2510	22.01	21.02	20.26
100RB (0)	2560	22.20	21.25	20.40	
	2535	22.28	21.28	20.66	
	2510	22.12	21.17	20.44	

Band 12						
Bandwidth (MHz)	RB allocation	Frequency (MHz)	QPSK	16QAM	64QAM	
	RB offset (Start RB)		Actual output power (dBm)	Actual output power (dBm)	Actual output power (dBm)	
1.4 MHz	1RB High (5)	715.3	22.79	21.71	21.02	
		707.5	22.83	21.85	21.15	
		699.7	22.82	22.08	21.15	
	1RB Middle (3)	715.3	23.05	21.96	21.30	
		707.5	23.02	22.04	21.36	
		699.7	23.05	22.18	21.37	
	1RB Low (0)	715.3	22.75	21.70	21.18	
		707.5	22.81	21.86	20.15	
		699.7	22.85	22.09	21.14	
	3RB High (3)	715.3	22.84	21.93	21.04	
		707.5	22.88	21.92	21.11	
		699.7	22.87	21.97	21.01	
	3RB Middle (1)	715.3	22.88	22.00	21.07	
		707.5	22.92	21.94	21.18	
		699.7	22.94	21.98	21.15	
	3RB Low (0)	715.3	22.85	21.95	21.11	
		707.5	22.86	21.90	21.18	
		699.7	22.92	21.98	21.17	
	6RB (0)	715.3	21.94	21.04	20.16	
		707.5	21.83	21.02	20.07	
		699.7	21.88	20.78	20.10	
	3 MHz	1RB High (14)	714.5	22.85	21.67	21.08
			707.5	22.83	21.66	21.16
			700.5	22.89	22.14	21.22
		1RB Middle (7)	714.5	22.93	21.87	21.18
			707.5	22.97	21.81	21.31
			700.5	22.97	22.24	21.29
1RB Low (0)		714.5	22.86	21.82	21.30	
		707.5	22.76	21.72	20.10	
		700.5	22.88	22.13	21.18	
8RB High (7)		714.5	21.84	20.84	20.04	
		707.5	21.77	20.96	20.00	
		700.5	21.80	20.88	19.94	
8RB Middle (4)		714.5	21.90	20.94	20.09	
		707.5	21.87	20.99	20.13	
		700.5	21.87	20.96	20.09	
8RB Low (0)		714.5	21.86	20.88	20.12	
		707.5	21.82	20.93	20.14	
		700.5	21.84	20.92	20.08	
15RB (0)		714.5	21.83	20.80	20.06	
		707.5	21.83	20.88	20.07	
		700.5	21.76	20.87	19.98	
5 MHz		1RB High (24)	713.5	22.82	21.74	21.05
			707.5	22.76	21.85	21.09

	1RB Middle (12)	701.5	22.77	22.26	21.10	
		713.5	23.07	22.02	21.32	
		707.5	23.03	22.09	21.38	
	1RB Low (0)	701.5	22.98	22.45	21.30	
		713.5	22.79	21.80	21.22	
		707.5	22.82	21.89	20.17	
	12RB High (13)	701.5	22.76	22.14	21.06	
		713.5	21.76	20.80	19.96	
		707.5	21.77	20.88	20.00	
	12RB Middle (6)	701.5	21.82	20.99	19.96	
		713.5	21.87	20.92	20.07	
		707.5	21.82	20.94	20.08	
	12RB Low (0)	701.5	21.84	21.03	20.06	
		713.5	21.80	20.89	20.06	
		707.5	21.79	20.91	20.11	
	25RB (0)	701.5	21.75	20.96	20.00	
		713.5	21.78	20.81	20.00	
		707.5	21.79	20.85	20.03	
	10 MHz	1RB High (49)	701.5	21.77	20.91	19.99
			711	22.85	21.68	21.08
			707.5	22.78	22.08	21.11
		1RB Middle (24)	704	22.79	21.77	21.12
			711	22.98	21.80	21.23
			707.5	22.96	22.22	21.30
		1RB Low (0)	704	22.94	21.89	21.26
			711	22.72	21.62	21.15
			707.5	22.81	22.07	20.16
25RB High (25)		704	22.78	21.68	21.08	
		711	21.77	20.83	19.97	
		707.5	21.88	20.95	20.11	
25RB Middle (12)		704	21.85	20.99	19.99	
		711	21.86	20.92	20.06	
		707.5	21.82	20.97	20.08	
25RB Low (0)		704	21.86	21.00	20.08	
		711	21.81	20.88	20.07	
		707.5	21.83	20.96	20.15	
50RB (0)		704	21.83	20.99	20.08	
		711	21.80	20.86	20.03	
		707.5	21.89	20.97	20.14	
			704	21.86	20.96	20.07

Band 13					
Bandwidth (MHz)	RB allocation	Frequency (MHz)	QPSK	16QAM	64QAM
	RB offset (Start RB)		Actual output power (dBm)	Actual output power (dBm)	Actual output power (dBm)
5 MHz	1RB High (24)	784.4	22.80	21.84	21.02
		782	22.83	21.84	21.01
		799.5	22.78	22.21	21.06
	1RB Middle (12)	784.4	23.00	22.04	21.15
		782	23.02	22.18	21.15
		799.5	23.05	22.13	21.16
	1RB Low (0)	784.4	22.78	21.80	21.09
		782	22.81	21.87	21.05
		799.5	22.75	22.20	21.01
	12RB High (13)	784.4	21.87	20.90	20.07
		782	21.86	20.89	20.05
		799.5	21.87	21.00	20.06
	12RB Middle (6)	784.4	21.87	20.91	20.09
		782	21.90	20.97	20.13
		799.5	21.92	21.07	20.12
	12RB Low (0)	784.4	21.80	20.83	20.04
		782	21.81	20.89	20.08
		799.5	21.83	20.98	20.04
	25RB (0)	784.4	21.83	20.81	20.05
		782	21.89	20.86	20.05
		799.5	21.85	20.97	20.05
10 MHz	1RB High (49)	782	22.87	21.75	21.09
	1RB Middle (24)	782	22.98	21.83	21.24
	1RB Low (0)	782	22.78	21.68	21.06
	25RB High (25)	782	21.89	20.93	20.05
	25RB Middle (12)	782	21.92	20.99	20.06
	25RB Low (0)	782	21.91	20.91	20.07
	50RB (0)	782	21.93	20.90	20.04

Band 25						
Bandwidth (MHz)	RB allocation RB offset (Start RB)	Frequency (MHz)	QPSK	16QAM	64QAM	
			Actual output power (dBm)	Actual output power (dBm)	Actual output power (dBm)	
1.4 MHz	1RB High (5)	1914.3	23.21	22.20	21.66	
		1882.5	23.30	22.30	21.65	
		1850.7	23.24	22.53	21.58	
	1RB Middle (3)	1914.3	23.39	22.34	21.69	
		1882.5	23.45	22.42	21.68	
		1850.7	23.39	22.63	21.71	
	1RB Low (0)	1914.3	23.20	22.19	21.66	
		1882.5	23.32	22.27	21.63	
		1850.7	23.24	22.51	21.62	
	3RB High (3)	1914.3	23.32	22.42	21.63	
		1882.5	23.34	22.34	21.59	
		1850.7	23.29	22.42	21.62	
	3RB Middle (1)	1914.3	23.33	22.45	21.63	
		1882.5	23.38	22.31	21.61	
		1850.7	23.33	22.43	21.61	
	3RB Low (0)	1914.3	23.28	22.37	21.59	
		1882.5	23.31	22.26	21.59	
		1850.7	23.31	22.36	21.64	
	6RB (0)	1914.3	22.39	21.46	20.57	
		1882.5	22.36	21.39	20.56	
		1850.7	22.26	21.12	20.59	
	3 MHz	1RB High (14)	1913.5	23.28	22.21	21.68
			1882.5	23.39	22.16	21.68
			1851.5	23.34	22.57	21.69
		1RB Middle (7)	1913.5	23.40	22.37	21.65
			1882.5	23.45	22.30	21.75
			1851.5	23.44	22.69	21.66
1RB Low (0)		1913.5	23.33	22.30	21.69	
		1882.5	23.31	22.16	21.66	
		1851.5	23.31	22.56	21.64	
8RB High (7)		1913.5	22.32	21.28	20.58	
		1882.5	22.33	21.39	20.65	
		1851.5	22.30	21.32	20.62	
8RB Middle (4)		1913.5	22.37	21.38	20.65	
		1882.5	22.44	21.43	20.67	
		1851.5	22.35	21.36	20.65	
8RB Low (0)		1913.5	22.34	21.31	20.62	
		1882.5	22.33	21.40	20.63	
		1851.5	22.31	21.29	20.63	
15RB (0)		1913.5	22.27	21.23	20.56	
		1882.5	22.29	21.31	20.61	
		1851.5	22.24	21.28	20.59	
5 MHz		1RB	1912.5	23.21	22.24	21.54

	High (24)	1882.5	23.29	22.32	21.63	
		1852.5	23.20	22.61	21.62	
	1RB Middle (12)	1912.5	23.51	22.50	21.63	
		1882.5	23.58	22.54	21.74	
	1RB Low (0)	1852.5	23.43	22.82	21.66	
		1912.5	23.25	22.25	21.59	
		1882.5	23.32	22.28	21.63	
	12RB High (13)	1852.5	23.19	22.62	21.67	
		1912.5	22.23	21.28	20.55	
		1882.5	22.30	21.30	20.64	
	12RB Middle (6)	1852.5	22.25	21.35	20.63	
		1912.5	22.35	21.34	20.64	
		1882.5	22.33	21.41	20.68	
	12RB Low (0)	1852.5	22.29	21.38	20.65	
		1912.5	22.31	21.29	20.65	
		1882.5	22.26	21.29	20.65	
	25RB (0)	1852.5	22.27	21.29	20.62	
		1912.5	22.21	21.18	20.58	
		1882.5	22.27	21.26	20.61	
	10 MHz	1RB High (49)	1852.5	22.25	21.30	20.62
			1910	23.29	22.20	21.68
			1882.5	23.34	22.14	21.75
		1RB Middle (24)	1855	23.34	22.49	21.66
			1910	23.39	22.31	21.79
1882.5			23.40	22.26	21.78	
1RB Low (0)		1855	23.46	22.65	21.75	
		1910	23.30	22.21	21.71	
		1882.5	23.30	22.12	21.73	
25RB High (25)		1855	23.31	22.54	21.72	
		1910	22.25	21.31	20.57	
		1882.5	22.36	21.35	20.71	
25RB Middle (12)		1855	22.31	21.29	20.65	
		1910	22.34	21.41	20.66	
		1882.5	22.37	21.37	20.67	
25RB Low (0)		1855	22.27	21.32	20.66	
		1910	22.36	21.40	20.69	
		1882.5	22.28	21.32	20.68	
50RB (0)		1855	22.25	21.25	20.66	
		1910	22.33	21.33	20.66	
		1882.5	22.31	21.30	20.68	
15 MHz		1RB High (74)	1855	22.27	21.30	20.65
			1907.5	23.29	22.50	21.63
			1882.5	23.24	22.10	21.61
	1RB Middle (37)	1857.5	23.22	22.38	21.54	
		1907.5	23.43	22.64	21.76	
		1882.5	23.38	22.22	21.72	
	1RB	1857.5	23.36	22.52	21.71	
	1907.5	23.41	22.46	21.63		

	Low (0)	1882.5	23.30	22.04	21.61	
		1857.5	23.21	22.49	21.68	
	36RB High (38)	1907.5	22.42	21.28	20.63	
		1882.5	22.50	21.35	20.70	
	36RB Middle (19)	1857.5	22.34	21.27	20.59	
		1907.5	22.51	21.38	20.69	
		1882.5	22.47	21.36	20.66	
	36RB Low (0)	1857.5	22.41	21.33	20.65	
		1907.5	22.55	21.37	20.71	
		1882.5	22.45	21.33	20.64	
	75RB (0)	1857.5	22.34	21.25	20.63	
		1907.5	22.50	21.41	20.66	
		1882.5	22.49	21.35	20.65	
	20 MHz	1RB High (99)	1857.5	22.35	21.29	20.61
			1905	23.13	22.61	21.58
1882.5			23.11	22.47	21.51	
1RB Middle (50)		1860	23.16	22.26	21.47	
		1905	23.53	22.91	21.79	
		1882.5	23.49	22.82	21.82	
1RB Low (0)		1860	23.41	22.59	21.78	
		1905	23.17	22.53	21.51	
		1882.5	23.15	22.36	21.51	
50RB High (50)		1860	23.12	22.35	21.57	
		1905	22.22	21.24	20.59	
		1882.5	22.38	21.36	20.72	
50RB Middle (25)		1860	22.08	21.01	20.52	
		1905	22.34	21.33	20.69	
		1882.5	22.31	21.31	20.66	
50RB Low (0)		1860	22.20	21.16	20.64	
		1905	22.39	21.39	20.79	
		1882.5	22.24	21.28	20.64	
100RB (0)		1860	22.16	21.11	20.60	
		1905	22.32	21.37	20.70	
		1882.5	22.24	21.28	20.65	
		1860	22.12	21.06	20.52	



Band 26						
Bandwidth (MHz)	RB allocation RB offset (Start RB)	Frequency (MHz)	QPSK	16QAM	64QAM	
			Actual output power (dBm)	Actual output power (dBm)	Actual output power (dBm)	
1.4 MHz	1RB High (5)	848.3		21.91	21.18	
		831.5	23.01	21.98	21.25	
		814.7	22.92	22.20	21.19	
	1RB Middle (3)	848.3	23.12	22.09	21.46	
		831.5	23.11	22.23	21.48	
		814.7	23.04	22.38	21.44	
	1RB Low (0)	848.3	22.93	21.95	21.32	
		831.5	23.03	21.97	21.44	
		814.7	22.90	22.20	21.32	
	3RB High (3)	848.3	23.02	22.07	21.19	
		831.5	23.02	21.96	21.19	
		814.7	23.01	22.11	21.18	
	3RB Middle (1)	848.3	23.08	22.17	21.26	
		831.5	23.07	22.02	21.25	
		814.7	23.03	22.13	21.27	
	3RB Low (0)	848.3	22.97	22.14	21.18	
		831.5	23.05	21.99	21.28	
		814.7	23.00	22.10	21.28	
	6RB (0)	848.3	22.10	21.18	20.29	
		831.5	22.07	21.13	20.27	
		814.7	21.97	20.86	20.17	
	3 MHz	1RB High (14)	847.5	22.90	22.24	21.17
			831.5	22.99	21.88	21.23
			815.5	22.97	21.85	21.23
		1RB Middle (7)	847.5	23.08	22.42	21.42
			831.5	23.12	22.08	21.38
			815.5	23.12	22.09	21.53
1RB Low (0)		847.5	22.95	22.26	21.35	
		831.5	22.95	21.96	21.36	
		815.5	22.95	21.92	21.37	
8RB High (7)		847.5	21.98	20.98	20.14	
		831.5	21.93	20.94	20.10	
		815.5	21.92	20.97	20.09	
8RB Middle (4)		847.5	22.03	21.09	20.22	
		831.5	22.02	21.01	20.20	
		815.5	22.03	21.02	20.27	
8RB Low (0)		847.5	22.03	21.04	20.25	
		831.5	22.00	20.99	20.23	
		815.5	22.00	20.97	20.28	
15RB (0)		847.5	21.95	20.99	20.14	
		831.5	21.95	20.88	20.15	
		815.5	21.96	20.89	20.16	

5 MHz	1RB High (24)	846.5	22.87	21.87	21.14
		831.5	22.96	21.97	21.21
		816.5	22.87	22.31	21.13
	1RB Middle (12)	846.5	23.09	22.17	21.44
		831.5	23.11	22.26	21.48
		816.5	23.09	22.55	21.49
	1RB Low (0)	846.5	22.86	21.94	21.26
		831.5	22.92	21.96	21.33
		816.5	22.82	22.28	21.23
	12RB High (13)	846.5	21.86	20.89	20.02
		831.5	21.95	20.93	20.12
		816.5	21.93	21.02	20.09
	12RB Middle (6)	846.5	22.01	21.03	20.19
		831.5	21.97	21.05	20.16
		816.5	21.96	21.10	20.20
	12RB Low (0)	846.5	22.00	20.99	20.22
		831.5	21.91	20.95	20.13
		816.5	21.87	20.96	20.15
25RB (0)	846.5	21.94	20.88	20.13	
	831.5	21.98	20.96	20.17	
	816.5	21.92	20.95	20.12	
10 MHz	1RB High (49)	844	22.89	21.86	21.12
		831.5	22.92	21.78	21.09
		820	22.95	22.23	21.22
	1RB Middle (24)	844	22.99	22.03	21.29
		831.5	23.05	21.93	21.22
		820	23.07	22.36	21.29
	1RB Low (0)	844	22.86	21.91	21.15
		831.5	22.90	21.75	21.17
		820	22.89	22.20	21.22
	25RB High (25)	844	21.85	20.92	20.04
		831.5	21.95	20.96	20.04
		820	21.98	20.99	20.18
	25RB Middle (12)	844	21.95	21.04	20.17
		831.5	21.96	20.94	20.16
		820	21.96	21.00	20.21
	25RB Low (0)	844	22.04	21.09	20.24
		831.5	21.98	20.96	20.15
		820	21.92	20.94	20.19
50RB (0)	844	21.93	20.94	20.11	
	831.5	21.97	20.88	20.15	
	820	21.93	20.95	20.18	
15 MHz	1RB High (74)	841.5	22.86	22.16	21.13
		831.5	22.91	22.20	21.15
		822.5	22.85	21.73	21.11
	1RB Middle (37)	1907.5	22.99	22.32	21.33
		1882.5	22.98	22.26	21.25
		1857.5	22.91	21.86	21.31



	1RB Low (0)	1907.5	22.81	22.17	21.21
		1882.5	22.83	22.18	21.24
		1857.5	22.83	21.70	21.25
	36RB High (38)	1907.5	21.95	20.96	20.11
		1882.5	21.97	20.86	20.13
		1857.5	21.99	20.92	20.15
	36RB Middle (19)	1907.5	22.02	21.01	20.20
		1882.5	22.03	20.89	20.22
		1857.5	22.00	20.94	20.24
	36RB Low (0)	1907.5	21.98	20.95	20.20
		1882.5	21.98	20.85	20.21
		1857.5	21.96	20.90	20.24
	75RB (0)	1907.5	21.96	20.94	20.15
		1882.5	21.96	20.91	20.16
		1857.5	21.97	20.92	20.17

Band 41 – PC2					
Bandwidth (MHz)	RB allocation	Frequency (MHz)	QPSK	16QAM	64QAM
	RB offset (Start RB)		Actual output power (dBm)	Actual output power (dBm)	Actual output power (dBm)
5 MHz	1RB High (24)	2687.5	26.04	25.41	24.01
		2640.3	26.01	25.43	24.14
		2593	26.29	25.68	24.52
		2545.8	26.09	25.64	24.44
		2498.5	26.00	25.39	24.27
	1RB Middle (12)	2687.5	26.01	25.57	24.04
		2640.3	26.25	25.68	24.19
		2593	26.47	25.88	24.53
		2545.8	26.32	25.89	24.45
		2498.5	26.19	25.59	24.28
	1RB Low (0)	2687.5	26.03	25.34	24.05
		2640.3	26.07	25.47	24.18
		2593	26.23	25.64	24.54
		2545.8	26.10	25.70	24.44
		2498.5	26.17	25.34	24.27
	12RB High (13)	2687.5	25.02	24.12	23.07
		2640.3	25.09	24.30	23.21
		2593	25.24	24.43	23.58
		2545.8	25.13	24.38	23.50
		2498.5	25.02	24.20	23.34
	12RB Middle (6)	2687.5	25.22	24.17	23.11
		2640.3	25.12	24.32	23.22
		2593	25.24	24.44	23.57
		2545.8	25.17	24.42	23.51
		2498.5	25.05	24.26	23.36
	12RB Low (0)	2687.5	25.20	24.20	23.13
		2640.3	25.09	24.31	23.21
		2593	25.20	24.40	23.57
		2545.8	25.16	24.38	23.48
		2498.5	25.00	24.17	23.35
	25RB (0)	2687.5	25.20	24.07	23.12
		2640.3	25.09	24.27	23.23
2593		25.23	24.50	23.59	
2545.8		25.15	24.35	23.49	
2498.5		25.01	24.20	23.35	
10 MHz	1RB	2685	25.99	25.34	24.02

	High (49)	2639	26.12	25.12	24.14	
		2593	26.38	25.64	24.47	
		2547	26.24	25.45	24.46	
		2501	26.14	25.54	24.00	
	1RB Middle (24)	2685	26.14	25.37	24.13	
		2639	26.22	25.44	24.24	
		2593	26.44	25.74	24.57	
		2547	26.33	25.26	24.55	
		2501	26.17	25.53	24.09	
	1RB Low (0)	2685	26.11	25.12	24.09	
		2639	26.25	25.47	24.25	
		2593	26.28	25.75	24.61	
		2547	26.20	25.55	24.43	
		2501	25.96	25.44	24.08	
	25RB High (25)	2685	25.03	23.97	23.13	
		2639	25.23	24.22	23.25	
		2593	25.40	24.45	23.64	
		2547	25.35	24.35	23.62	
		2501	25.17	24.21	23.12	
	25RB Middle (12)	2685	25.11	24.00	23.16	
		2639	25.24	24.19	23.27	
		2593	25.39	24.28	23.62	
		2547	25.31	24.32	23.54	
		2501	25.32	24.19	23.17	
	25RB Low (0)	2685	25.06	24.03	23.19	
		2639	25.24	24.22	23.29	
		2593	25.39	24.39	23.66	
		2547	25.33	24.32	23.53	
		2501	25.16	24.14	23.19	
	50RB (0)	2685	25.06	24.01	23.14	
		2639	25.23	24.25	23.25	
		2593	25.40	24.44	23.61	
		2547	25.31	24.26	23.52	
		2501	25.20	24.31	23.13	
	15 MHz	1RB High (74)	2682.5	25.91	25.33	23.98
			2637.8	26.09	25.46	24.09
			2593	26.34	25.51	24.39
			2548.3	26.17	25.55	24.44
			2503.5	26.17	25.53	24.24
		1RB Middle (37)	2682.5	25.99	25.35	24.01
2637.8			26.19	25.56	24.16	
2593			26.40	25.58	24.49	

		2548.3	26.28	25.67	24.46
		2503.5	26.15	25.51	24.23
	1RB Low (0)	2682.5	25.97	25.34	24.09
		2637.8	26.25	25.59	24.28
		2593	26.42	25.51	24.57
		2548.3	26.25	25.70	24.43
		2503.5	26.12	25.39	24.27
	36RB High (38)	2682.5	24.99	23.96	23.00
		2637.8	25.28	24.31	23.13
		2593	25.45	24.43	23.47
		2548.3	25.38	24.29	23.50
		2503.5	25.31	24.27	23.22
	36RB Middle (19)	2682.5	25.02	23.96	23.06
		2637.8	25.26	24.26	23.17
		2593	25.46	24.46	23.52
		2548.3	25.30	24.29	23.46
		2503.5	25.23	24.20	23.26
	36RB Low (0)	2682.5	25.04	23.97	23.09
		2637.8	25.33	24.30	23.21
		2593	25.45	24.37	23.56
2548.3		25.38	24.32	23.42	
2503.5		25.14	24.21	23.27	
75RB (0)	2682.5	25.04	24.01	23.08	
	2637.8	25.28	24.25	23.20	
	2593	25.45	24.45	23.56	
	2548.3	25.30	24.33	23.49	
	2503.5	25.27	24.23	23.29	
20 MHz	1RB High (99)	2680	25.98	25.28	23.97
		2636.5	26.13	25.34	24.08
		2593	26.33	25.73	24.33
		2549.5	26.23	25.52	24.39
		2506	26.21	25.41	24.14
	1RB Middle (50)	2680	26.23	25.48	24.10
		2636.5	26.49	25.66	24.26
		2593	26.63	25.99	24.54
		2549.5	26.61	25.77	24.54
		2506	26.45	25.59	24.28
	1RB Low (0)	2680	26.01	25.32	24.15
		2636.5	26.30	25.49	24.31
		2593	26.30	25.71	24.58
		2549.5	26.42	25.62	24.43
		2506	26.15	25.26	24.28



	50RB High (50)	2680	25.04	24.01	23.04
		2636.5	25.22	24.23	23.17
		2593	25.43	24.45	23.50
		2549.5	25.24	24.25	23.49
		2506	25.26	24.26	23.24
	50RB Middle (25)	2680	25.06	24.06	23.15
		2636.5	25.28	24.29	23.23
		2593	25.45	24.49	23.57
		2549.5	25.27	24.28	23.43
		2506	25.25	24.20	23.24
	50RB Low (0)	2680	25.03	24.07	23.18
		2636.5	25.29	24.29	23.29
		2593	25.39	24.48	23.61
		2549.5	25.36	24.26	23.47
		2506	25.18	24.16	23.29
	100RB (0)	2680	25.01	24.06	23.10
		2636.5	25.27	24.25	23.22
		2593	25.41	24.45	23.59
		2549.5	25.31	24.26	23.45
		2506	25.25	24.23	23.27

Band 41 – PC3					
Bandwidth (MHz)	RB allocation	Frequency (MHz)	QPSK	16QAM	64QAM
	RB offset (Start RB)		Actual output power (dBm)	Actual output power (dBm)	Actual output power (dBm)
5 MHz	1RB High (24)	2687.5	23.10	22.12	21.03
		2640.3	23.26	22.44	21.18
		2593	23.57	22.45	21.16
		2545.8	23.39	22.34	21.45
		2498.5	23.16	22.34	21.19
	1RB Middle (12)	2687.5	23.01	22.08	21.06
		2640.3	23.22	22.41	21.19
		2593	23.52	22.32	21.59
		2545.8	23.31	22.32	21.48
		2498.5	23.09	22.29	21.31
	1RB Low (0)	2687.5	23.12	22.15	21.14
		2640.3	23.31	22.50	21.21
		2593	23.53	22.40	21.56
		2545.8	23.42	22.41	21.46
		2498.5	23.12	22.31	21.27
	12RB High (13)	2687.5	22.12	21.04	20.03
		2640.3	22.36	21.43	20.26
		2593	22.48	21.44	20.54
		2545.8	22.50	21.32	20.46
		2498.5	22.21	21.23	20.28
	12RB Middle (6)	2687.5	22.18	21.11	20.01
		2640.3	22.47	21.38	20.18
		2593	22.53	21.52	20.55
		2545.8	22.46	21.35	20.45
		2498.5	22.27	21.28	20.30
	12RB Low (0)	2687.5	22.11	21.04	20.60
		2640.3	22.39	21.40	20.23
		2593	22.43	21.43	20.57
		2545.8	22.45	21.33	20.44
		2498.5	22.22	21.15	20.28
	25RB (0)	2687.5	22.11	21.10	20.50
		2640.3	22.39	21.35	20.16
2593		22.46	21.47	20.54	
2545.8		22.48	21.37	20.46	
2498.5		22.23	21.18	20.30	
10 MHz	1RB	2685	23.07	22.16	21.00



	High (49)	2639	23.26	22.47	21.14	
		2593	23.59	22.47	21.57	
		2547	23.36	22.41	21.50	
		2501	23.23	22.42	21.26	
	1RB Middle (24)	2685	23.33	22.41	21.11	
		2639	23.57	22.81	21.21	
		2593	23.54	22.75	21.47	
		2547	23.65	22.69	21.54	
		2501	23.45	22.62	21.24	
	1RB Low (0)	2685	23.06	22.16	21.03	
		2639	23.34	22.57	21.24	
		2593	23.61	22.51	21.59	
		2547	23.39	22.43	21.63	
		2501	23.14	22.36	21.28	
	25RB High (25)	2685	22.10	21.07	19.96	
		2639	22.30	21.39	20.20	
		2593	22.60	21.59	20.58	
		2547	22.51	21.54	20.56	
		2501	22.27	21.25	20.34	
	25RB Middle (12)	2685	22.19	21.17	20.07	
		2639	22.36	21.27	20.20	
		2593	22.47	21.48	20.56	
		2547	22.40	21.32	20.52	
		2501	22.29	21.22	20.28	
	25RB Low (0)	2685	22.18	21.15	20.14	
		2639	22.37	21.43	20.37	
		2593	22.52	21.51	20.60	
		2547	22.42	21.40	20.63	
		2501	22.23	21.21	20.28	
	50RB (0)	2685	22.12	21.15	20.07	
		2639	22.29	21.30	20.18	
		2593	22.46	21.47	20.56	
		2547	22.38	21.35	20.47	
		2501	22.22	21.27	20.32	
	15 MHz	1RB High (74)	2682.5	23.03	22.16	21.01
			2637.8	23.21	22.37	21.14
			2593	23.45	22.39	21.45
			2548.3	23.31	22.33	21.53
			2503.5	23.26	22.40	21.24
		1RB Middle (37)	2682.5	23.03	22.17	21.02
2637.8			23.32	22.42	21.20	
2593			23.54	22.47	21.54	

		2548.3	23.40	22.42	21.50
		2503.5	23.24	22.34	21.17
	1RB Low (0)	2682.5	23.07	22.19	21.15
		2637.8	23.38	22.49	21.33
		2593	23.50	22.45	21.59
		2548.3	23.38	22.46	21.49
		2503.5	23.18	22.31	21.28
	36RB High (38)	2682.5	22.10	21.06	19.99
		2637.8	22.30	21.28	20.15
		2593	22.50	21.44	20.52
		2548.3	22.42	21.34	20.51
		2503.5	22.28	21.25	20.19
	36RB Middle (19)	2682.5	22.06	21.03	20.03
		2637.8	22.33	21.30	20.16
		2593	22.50	21.45	20.51
		2548.3	22.38	21.34	20.47
		2503.5	22.27	21.22	20.22
	36RB Low (0)	2682.5	22.06	20.98	20.08
		2637.8	22.35	21.31	20.24
		2593	22.45	21.38	20.58
2548.3		22.41	21.30	20.45	
2503.5		22.23	21.18	20.22	
75RB (0)	2682.5	22.07	21.07	20.06	
	2637.8	22.33	21.25	20.20	
	2593	22.46	21.45	20.57	
	2548.3	22.35	21.36	20.42	
	2503.5	22.26	21.19	20.25	
20 MHz	1RB High (99)	2680	23.11	22.14	20.97
		2636.5	23.35	22.18	21.09
		2593	23.45	22.56	21.32
		2549.5	23.34	22.31	21.41
		2506	23.39	22.20	21.16
	1RB Middle (50)	2680	23.19	22.18	21.11
		2636.5	23.56	22.37	21.15
		2593	23.57	22.68	21.56
		2549.5	23.51	22.47	21.53
		2506	23.49	22.25	21.31
	1RB Low (0)	2680	23.17	22.17	21.17
		2636.5	23.54	22.36	21.30
		2593	23.47	22.56	21.57
		2549.5	23.46	22.40	21.44
		2506	23.36	22.13	21.26

	50RB High (50)	2680	22.06	21.03	19.97
		2636.5	22.26	21.23	20.13
		2593	22.44	21.51	20.45
		2549.5	22.31	21.31	20.43
		2506	22.29	21.23	20.21
	50RB Middle (25)	2680	22.10	21.10	20.08
		2636.5	22.31	21.27	20.17
		2593	22.45	21.50	20.50
		2549.5	22.36	21.32	20.46
		2506	22.26	21.25	20.23
	50RB Low (0)	2680	22.13	21.09	20.15
		2636.5	22.32	21.30	20.24
		2593	22.44	21.52	20.49
		2549.5	22.32	21.24	20.45
		2506	22.23	21.19	20.26
	100RB (0)	2680	22.11	21.09	20.13
		2636.5	22.25	21.24	20.13
		2593	22.45	21.48	20.54
		2549.5	22.33	21.26	20.35
		2506	22.22	21.21	20.24

Band 66					
Bandwidth (MHz)	RB allocation	Frequency (MHz)	QPSK	16QAM	64QAM
	RB offset (Start RB)		Actual output power (dBm)	Actual output power (dBm)	Actual output power (dBm)
1.4 MHz	1RB High (5)	1779.3	23.11	22.19	21.50
		1745	22.99	22.37	21.26
		1710.7	22.93	21.96	21.22
	1RB Middle (3)	1779.3	23.32	22.36	21.62
		1745	23.25	22.52	21.54
		1710.7	23.20	22.17	21.46
	1RB Low (0)	1779.3	23.17	22.20	21.51
		1745	23.01	22.38	21.41
		1710.7	22.95	21.93	21.34
	3RB High (3)	1779.3	23.17	22.21	21.34
		1745	23.12	22.29	21.27
		1710.7	23.12	22.18	21.30
	3RB Middle (1)	1779.3	23.29	22.27	21.48
		1745	23.19	22.32	21.34
		1710.7	23.12	22.26	21.30
	3RB Low (0)	1779.3	23.23	22.22	21.42
		1745	23.11	22.26	21.28
		1710.7	23.05	22.23	21.25
	6RB (0)	1779.3	22.26	21.31	20.42
		1745	22.04	20.99	20.18
		1710.7	22.13	21.21	20.30
3 MHz	1RB High (14)	1778.5	23.13	22.00	21.52
		1745	23.04	22.35	21.32
		1711.5	22.87	21.82	21.15
	1RB Middle (7)	1778.5	23.28	22.14	21.58
		1745	23.17	22.54	21.46
		1711.5	23.10	22.09	21.36
	1RB Low (0)	1778.5	23.04	22.01	21.38
		1745	23.00	22.31	21.40
		1711.5	22.97	21.92	21.35
	8RB High (7)	1778.5	22.09	21.17	20.27
		1745	21.96	21.05	20.11
		1711.5	21.96	20.96	20.14
	8RB Middle (4)	1778.5	22.22	21.26	20.41
		1745	21.99	21.11	20.14
		1711.5	22.04	21.04	20.22
	8RB Low (0)	1778.5	22.15	21.23	20.34
		1745	21.99	21.08	20.16
		1711.5	21.98	20.95	20.18
	15RB (0)	1778.5	22.12	21.13	20.28
		1745	21.97	21.01	20.11
		1711.5	21.94	20.88	20.12

5 MHz	1RB High (24)	1777.5	23.24	22.14	21.46
		1745	22.87	22.37	21.15
		1712.5	22.86	21.94	21.14
	1RB Middle (12)	1777.5	23.38	22.43	21.68
		1745	23.13	22.64	21.42
		1712.5	23.16	22.15	21.41
	1RB Low (0)	1777.5	23.07	22.12	21.41
		1745	22.89	22.37	21.29
		1712.5	22.91	21.93	21.30
	12RB High (13)	1777.5	22.08	21.15	20.26
		1745	21.97	21.11	20.13
		1712.5	21.97	20.95	20.15
	12RB Middle (6)	1777.5	22.14	21.22	20.33
		1745	22.05	21.17	20.20
		1712.5	21.99	21.00	20.17
	12RB Low (0)	1777.5	22.13	21.20	20.32
		1745	21.98	21.08	20.15
		1712.5	21.95	20.94	20.16
25RB (0)	1777.5	22.11	21.12	20.27	
	1745	21.97	21.05	20.11	
	1712.5	21.93	20.86	20.10	
10 MHz	1RB High (49)	1775	23.08	21.99	21.47
		1745	22.97	22.28	21.25
		1715	22.91	21.99	21.19
	1RB Middle (24)	1775	23.15	22.07	21.45
		1745	23.11	22.40	21.40
		1715	23.00	22.01	21.25
	1RB Low (0)	1775	23.02	21.93	21.36
		1745	22.94	22.29	21.34
		1715	22.90	21.89	21.28
	25RB High (25)	1775	22.08	21.11	20.26
		1745	22.00	21.06	20.15
		1715	22.03	21.10	20.21
	25RB Middle (12)	1775	22.11	21.16	20.30
		1745	22.04	21.03	20.19
		1715	21.99	21.10	20.17
	25RB Low (0)	1775	22.11	21.18	20.30
		1745	22.05	21.08	20.23
		1715	21.94	21.02	20.14
50RB (0)	1775	22.09	21.11	20.25	
	1745	22.03	21.02	20.16	
	1715	22.01	21.06	20.19	
15 MHz	1RB High (74)	1772.5	22.94	21.92	21.33
		1745	22.91	22.23	21.19
		1717.5	22.95	22.27	21.23
	1RB Middle (37)	1772.5	23.08	22.02	21.38
		1745	23.03	22.38	21.32
		1717.5	23.28	22.35	21.31

	1RB Low (0)	1772.5	22.98	21.91	21.33
		1745	22.98	22.28	21.37
		1717.5	23.02	22.19	21.40
	36RB High (38)	1772.5	22.17	21.10	20.35
		1745	22.03	21.05	20.19
		1717.5	22.11	21.01	20.29
	36RB Middle (19)	1772.5	22.21	21.11	20.40
		1745	22.10	21.07	20.25
		1717.5	22.09	21.00	20.27
	36RB Low (0)	1772.5	22.15	21.08	20.34
		1745	22.10	21.09	20.27
		1717.5	22.08	20.94	20.28
	75RB (0)	1772.5	22.19	21.17	20.34
		1745	22.10	21.06	20.24
		1717.5	22.08	21.03	20.25
<b>20 MHz</b>	1RB High (99)	1770	22.91	22.26	21.30
		1745	22.86	22.36	21.14
		1720	22.87	22.29	21.15
	1RB Middle (50)	1770	23.27	22.53	21.47
		1745	23.26	22.67	21.45
		1720	23.24	22.54	21.38
	1RB Low (0)	1770	22.84	22.23	21.18
		1745	22.83	22.32	21.23
		1720	22.84	22.20	21.22
	50RB High (50)	1770	21.96	20.97	20.14
		1745	21.94	20.97	20.09
		1720	22.03	21.02	20.21
	50RB Middle (25)	1770	22.12	21.07	20.31
		1745	22.03	21.06	20.18
		1720	21.99	21.00	20.17
	50RB Low (0)	1770	22.13	21.12	20.32
		1745	22.07	21.04	20.24
		1720	21.98	20.98	20.18
	100RB (0)	1770	22.09	21.10	20.25
		1745	22.00	21.02	20.14
		1720	21.99	20.99	20.17

Band 71					
Bandwidth (MHz)	RB allocation RB offset (Start RB)	Frequency (MHz)	QPSK	16QAM	64QAM
			Actual output power (dBm)	Actual output power (dBm)	Actual output power (dBm)
5 MHz	1RB High (24)	695.5	22.76	21.89	21.26
		680.5	22.76	21.95	21.28
		665.5	22.68	22.30	21.13
	1RB Middle (12)	695.5	22.91	22.10	21.30
		680.5	22.89	22.18	21.33
		665.5	22.93	22.47	21.44
	1RB Low (0)	695.5	22.72	21.85	20.30
		680.5	22.73	21.90	21.31
		665.5	22.65	22.21	21.23
	12RB High (13)	695.5	21.82	20.97	20.32
		680.5	21.82	20.95	20.08
		665.5	21.90	21.04	20.28
	12RB Middle (6)	695.5	21.87	20.95	20.22
		680.5	21.89	20.95	20.18
		665.5	21.93	21.04	20.26
	12RB Low (0)	695.5	21.90	20.94	20.39
		680.5	21.85	20.91	20.11
		665.5	21.79	20.93	20.35
	25RB (0)	695.5	21.87	20.90	20.35
		680.5	21.86	20.92	20.05
		665.5	21.90	20.98	20.32
10 MHz	1RB High (49)	693	22.78	21.82	21.27
		680.5	22.69	21.75	21.21
		668	22.85	22.24	21.30
	1RB Middle (24)	693	22.87	21.95	21.25
		680.5	22.84	21.87	21.28
		668	22.93	22.32	21.44
	1RB Low (0)	693	22.66	21.83	20.23
		680.5	22.72	21.74	21.31
		668	22.76	22.07	21.35
	25RB High (25)	693	21.86	20.99	20.37
		680.5	21.99	21.04	20.25
		668	21.95	21.05	20.34
	25RB Middle (12)	693	21.86	21.02	20.22
		680.5	21.92	20.98	20.21
		668	21.88	20.97	20.21
	25RB Low (0)	693	21.95	21.10	20.44
		680.5	21.93	20.98	20.19
		668	21.80	20.90	20.36
	50RB (0)	693	21.91	20.99	20.40
		680.5	21.97	20.99	20.16
		668	21.89	20.97	20.31

15 MHz	1RB High (74)	690.5	22.76	22.20	21.25	
		680.5	22.73	21.73	21.24	
		670.5	22.79	22.20	21.25	
	1RB Middle (37)	690.5	22.79	22.24	21.18	
		680.5	22.77	21.77	21.21	
		670.5	22.87	22.27	21.37	
	1RB Low (0)	690.5	22.72	22.24	20.30	
		680.5	22.66	21.69	21.24	
		670.5	22.72	22.03	21.31	
	36RB High (38)	690.5	21.80	20.80	20.31	
		680.5	21.95	20.88	20.21	
		670.5	21.85	20.88	20.23	
	36RB Middle (19)	690.5	21.90	20.87	20.26	
		680.5	21.87	20.87	20.15	
		670.5	21.88	20.91	20.21	
	36RB Low (0)	690.5	21.77	20.73	20.27	
		680.5	21.87	20.84	20.13	
		670.5	21.80	20.78	20.36	
	75RB (0)	690.5	21.82	20.80	20.30	
		680.5	21.96	20.94	20.15	
		670.5	21.86	20.86	20.28	
	20 MHz	1RB High (99)	688	22.68	22.23	21.17
			683	22.65	22.21	21.17
			673	22.71	22.22	21.16
		1RB Middle (50)	688	22.92	22.47	21.31
			683	22.93	22.50	21.37
			673	22.88	22.34	21.38
1RB Low (0)		688	22.60	22.19	20.17	
		683	22.59	22.15	21.17	
		673	22.60	22.01	21.19	
50RB High (50)		688	21.63	20.69	20.14	
		683	21.88	20.92	20.14	
		673	21.77	20.77	20.15	
50RB Middle (25)		688	21.85	20.91	20.21	
		683	21.89	20.92	20.18	
		673	21.85	20.85	20.18	
50RB Low (0)		688	21.70	20.76	20.19	
		683	21.91	20.94	20.17	
		673	21.64	20.67	20.20	
100RB (0)		688	21.67	20.72	20.15	
		683	21.92	20.89	20.11	
		673	21.72	20.72	20.14	



Low power

**Table 11.3-5: The conducted Power for LTE**

Band 25					
Bandwidth (MHz)	RB allocation	Frequency (MHz)	QPSK	16QAM	64QAM
	RB offset (Start RB)		Actual output power (dBm)	Actual output power (dBm)	Actual output power (dBm)
1.4 MHz	1RB High (5)	1914.3	22.20	22.25	21.65
		1882.5	22.25	22.26	21.72
		1850.7	22.17	22.47	21.77
	1RB Middle (3)	1914.3	22.38	22.26	21.73
		1882.5	22.36	22.36	21.77
		1850.7	22.34	22.37	21.84
	1RB Low (0)	1914.3	22.17	22.15	21.57
		1882.5	22.18	22.18	21.65
		1850.7	22.17	22.18	21.74
	3RB High (3)	1914.3	22.27	22.33	21.59
		1882.5	22.23	22.15	21.66
		1850.7	22.04	22.19	21.71
	3RB Middle (1)	1914.3	22.28	22.22	21.66
		1882.5	22.29	22.26	21.71
		1850.7	22.27	22.37	21.71
	3RB Low (0)	1914.3	22.27	22.23	21.64
		1882.5	22.29	22.24	21.73
		1850.7	22.23	22.37	21.78
	6RB (0)	1914.3	22.25	21.38	21.05
		1882.5	22.29	21.36	21.06
		1850.7	22.22	21.37	21.07
3 MHz	1RB High (14)	1913.5	22.16	22.05	21.72
		1882.5	22.21	22.10	21.84
		1851.5	22.21	22.49	21.73
	1RB Middle (7)	1913.5	22.37	22.18	21.71
		1882.5	22.43	22.21	21.80
		1851.5	22.34	22.64	21.68
	1RB Low (0)	1913.5	22.32	22.36	21.68
		1882.5	22.30	22.20	21.80
		1851.5	22.11	22.07	21.64
	8RB High (7)	1913.5	22.23	21.24	20.60
		1882.5	22.22	21.26	20.74
		1851.5	22.19	21.26	20.63
	8RB Middle (4)	1913.5	22.25	21.28	20.66
		1882.5	22.31	21.32	20.77
		1851.5	22.25	21.30	20.66
	8RB Low (0)	1913.5	22.28	21.19	20.63
		1882.5	22.26	21.23	20.72
		1851.5	22.20	21.35	20.67
	15RB (0)	1913.5	22.21	21.24	20.61
		1882.5	22.21	21.29	20.67

		1851.5	22.17	21.18	20.62
5 MHz	1RB High (24)	1912.5	22.09	22.22	21.61
		1882.5	22.05	22.16	21.75
		1852.5	22.02	22.24	21.70
	1RB Middle (12)	1912.5	22.40	22.50	21.69
		1882.5	22.32	22.43	21.79
		1852.5	22.32	22.46	21.69
	1RB Low (0)	1912.5	22.11	22.32	21.68
		1882.5	22.12	22.43	21.70
		1852.5	22.03	22.22	21.56
	12RB High (13)	1912.5	22.15	21.19	20.61
		1882.5	22.16	21.33	20.67
		1852.5	22.14	21.06	20.63
	12RB Middle (6)	1912.5	22.26	21.28	20.65
		1882.5	22.22	21.25	20.76
		1852.5	22.21	21.28	20.69
	12RB Low (0)	1912.5	22.21	21.23	20.65
		1882.5	22.18	21.24	20.68
		1852.5	22.15	21.16	20.66
	25RB (0)	1912.5	22.14	21.15	20.60
		1882.5	22.17	21.13	20.68
		1852.5	22.15	21.08	20.64
10 MHz	1RB High (49)	1910	22.18	22.11	21.71
		1882.5	22.26	22.36	21.79
		1855	22.18	22.04	21.76
	1RB Middle (24)	1910	22.29	22.24	21.78
		1882.5	22.35	22.35	21.92
		1855	22.37	22.13	21.82
	1RB Low (0)	1910	22.21	22.19	21.79
		1882.5	22.12	22.13	21.74
		1855	22.22	22.24	21.84
	25RB High (25)	1910	22.13	21.28	20.59
		1882.5	22.26	21.33	20.76
		1855	22.19	21.23	20.74
	25RB Middle (12)	1910	22.24	21.38	20.67
		1882.5	22.22	21.35	20.71
		1855	22.17	21.26	20.76
	25RB Low (0)	1910	22.25	21.28	20.73
		1882.5	22.32	21.32	20.73
		1855	22.16	21.19	20.76
	50RB (0)	1910	22.23	21.25	20.68
		1882.5	22.23	21.31	20.75
		1855	22.20	21.19	20.76
15 MHz	1RB High (74)	1907.5	22.12	22.02	21.64
		1882.5	22.24	22.49	21.67
		1857.5	22.16	22.28	21.59
	1RB Middle	1907.5	22.33	22.19	21.76
		1882.5	22.27	22.15	21.87

	(37)	1857.5	22.28	22.48	21.81
	1RB Low (0)	1907.5	22.19	22.06	21.72
		1882.5	22.17	22.40	21.74
		1857.5	22.16	21.96	21.71
	36RB High (38)	1907.5	22.41	21.28	20.62
		1882.5	22.43	21.32	20.73
		1857.5	22.32	21.20	20.67
	36RB Middle (19)	1907.5	22.23	21.36	20.69
		1882.5	22.39	21.27	20.73
		1857.5	22.37	21.24	20.75
	36RB Low (0)	1907.5	22.50	21.38	20.75
		1882.5	22.42	21.36	20.72
		1857.5	22.31	21.31	20.74
	75RB (0)	1907.5	22.44	21.39	20.69
		1882.5	22.39	21.32	20.71
1857.5		22.31	21.22	20.69	
20 MHz	1RB High (99)	1905	22.11	22.40	21.59
		1882.5	22.13	22.36	21.63
		1860	22.08	22.28	21.54
	1RB Middle (50)	1905	22.44	22.64	21.86
		1882.5	22.46	22.67	21.88
		1860	22.58	22.73	21.81
	1RB Low (0)	1905	22.13	22.45	21.61
		1882.5	22.18	22.35	21.58
		1860	22.07	22.29	21.69
	50RB High (50)	1905	22.23	21.18	20.54
		1882.5	22.32	21.34	20.71
		1860	22.09	21.05	20.61
	50RB Middle (25)	1905	22.35	21.31	20.70
		1882.5	22.28	21.30	20.69
		1860	22.20	21.14	20.72
	50RB Low (0)	1905	22.42	21.34	20.76
		1882.5	22.27	21.30	20.66
		1860	22.14	21.08	20.70
	100RB (0)	1905	22.36	21.37	20.65
		1882.5	22.30	21.29	20.65
		1860	22.11	21.18	20.62

Band 66					
Bandwidth (MHz)	RB allocation	Frequency (MHz)	QPSK	16QAM	64QAM
	RB offset (Start RB)		Actual output power (dBm)	Actual output power (dBm)	Actual output power (dBm)
1.4 MHz	1RB High (5)	1779.3	19.26	19.24	19.56
		1745	19.10	19.31	19.34
		1710.7	19.03	18.99	19.26
	1RB Middle (3)	1779.3	19.41	19.40	19.63
		1745	19.35	19.50	19.44
		1710.7	19.28	19.17	19.24
	1RB Low (0)	1779.3	19.23	19.19	19.36
		1745	19.14	19.32	19.38
		1710.7	19.05	18.96	19.32
	3RB High (3)	1779.3	19.31	19.20	19.43
		1745	19.16	19.20	19.43
		1710.7	19.19	19.18	19.32
	3RB Middle (1)	1779.3	19.39	19.25	19.46
		1745	19.27	19.26	19.41
		1710.7	19.22	19.27	19.38
	3RB Low (0)	1779.3	19.37	19.18	19.54
		1745	19.19	19.23	19.33
		1710.7	19.15	19.15	19.23
	6RB (0)	1779.3	19.33	19.31	19.41
		1745	19.19	18.95	19.28
		1710.7	19.20	19.16	19.24
3 MHz	1RB High (14)	1778.5	19.23	18.94	19.54
		1745	19.15	19.29	19.28
		1711.5	19.03	18.88	19.32
	1RB Middle (7)	1778.5	19.36	19.19	19.44
		1745	19.31	19.47	19.38
		1711.5	19.21	19.12	19.34
	1RB Low (0)	1778.5	19.15	19.03	19.37
		1745	19.12	19.29	19.32
		1711.5	19.07	18.97	19.35
	8RB High (7)	1778.5	19.20	19.13	19.22
		1745	19.07	19.00	19.23
		1711.5	19.02	18.87	19.25
	8RB Middle (4)	1778.5	19.30	19.21	19.39
		1745	19.12	19.04	19.26
		1711.5	19.14	19.01	19.23
	8RB Low (0)	1778.5	19.24	19.18	19.31
		1745	19.08	19.01	19.23
		1711.5	19.09	18.95	19.21
15RB (0)	1778.5	19.25	19.10	19.31	
	1745	19.08	18.95	19.14	
	1711.5	19.01	18.86	19.13	

5 MHz	1RB High (24)	1777.5	19.21	19.13	19.04
		1745	19.00	19.32	19.06
		1712.5	19.00	18.92	18.96
	1RB Middle (12)	1777.5	19.50	19.43	19.21
		1745	19.29	19.48	19.19
		1712.5	19.26	19.16	19.13
	1RB Low (0)	1777.5	19.14	19.11	19.07
		1745	19.03	19.32	19.04
		1712.5	19.04	18.91	19.09
	12RB High (13)	1777.5	19.21	19.05	19.15
		1745	19.07	19.02	19.15
		1712.5	19.03	18.89	19.11
	12RB Middle (6)	1777.5	19.29	19.18	19.21
		1745	19.16	19.08	19.22
		1712.5	19.15	18.93	19.17
	12RB Low (0)	1777.5	19.24	19.16	19.18
		1745	19.07	19.02	19.18
		1712.5	19.07	18.91	19.15
25RB (0)	1777.5	19.20	19.06	19.18	
	1745	19.07	18.99	19.17	
	1712.5	19.07	18.83	19.12	
10 MHz	1RB High (49)	1775	19.18	18.97	19.28
		1745	19.08	19.22	19.15
		1715	19.01	18.91	19.11
	1RB Middle (24)	1775	19.29	19.12	19.38
		1745	19.24	19.39	19.27
		1715	19.10	18.96	19.21
	1RB Low (0)	1775	19.10	18.91	19.23
		1745	19.09	19.24	19.17
		1715	18.99	18.90	19.09
	25RB High (25)	1775	19.20	19.04	19.29
		1745	19.10	19.02	19.17
		1715	19.15	19.02	19.15
	25RB Middle (12)	1775	19.24	19.10	19.32
		1745	19.16	19.01	19.21
		1715	19.09	18.99	19.18
	25RB Low (0)	1775	19.22	19.08	19.34
		1745	19.13	19.01	18.91
		1715	19.09	18.96	19.18
50RB (0)	1775	19.22	19.03	19.29	
	1745	19.12	18.98	19.25	
	1715	19.11	18.97	19.23	
15 MHz	1RB High (74)	1772.5	19.08	18.93	19.18
		1745	19.00	19.13	19.05
		1717.5	19.04	19.27	19.06
	1RB Middle (37)	1772.5	19.18	19.03	19.28
		1745	19.16	19.31	19.15
1717.5		19.09	19.41	19.17	



	1RB Low (0)	1772.5	19.11	18.88	19.17
		1745	19.06	19.24	19.07
		1717.5	19.04	19.28	19.13
	36RB High (38)	1772.5	19.27	19.09	19.17
		1745	19.11	18.95	19.21
		1717.5	19.18	18.93	19.26
	36RB Middle (19)	1772.5	19.30	19.09	19.30
		1745	19.15	18.99	19.18
		1717.5	19.12	18.88	19.18
	36RB Low (0)	1772.5	19.19	19.00	19.29
		1745	19.14	18.96	19.18
		1717.5	19.05	18.85	19.15
	75RB (0)	1772.5	19.22	19.07	19.31
		1745	19.10	18.92	19.20
		1717.5	19.09	18.90	19.18
20 MHz	1RB High (99)	1770	19.03	19.40	19.36
		1745	18.91	19.17	19.18
		1720	18.96	19.29	19.24
	1RB Middle (50)	1770	19.30	19.46	19.56
		1745	19.24	19.49	19.48
		1720	19.25	19.41	19.47
	1RB Low (0)	1770	18.95	19.31	19.29
		1745	18.88	19.16	19.22
		1720	18.95	19.28	19.28
	50RB High (50)	1770	19.11	18.99	19.21
		1745	19.01	18.84	19.16
		1720	19.06	18.98	19.25
	50RB Middle (25)	1770	19.14	19.04	19.34
		1745	19.06	18.91	19.22
		1720	19.03	18.96	19.24
	50RB Low (0)	1770	19.22	19.05	19.36
		1745	19.11	18.93	19.28
		1720	19.04	18.92	19.22
	100RB (0)	1770	19.16	18.99	19.28
		1745	19.04	18.91	19.21
		1720	19.05	18.94	19.20



**Normal Power**

The conducted power measurement results of downlink LTE CA are as below :

DL LT CA Class	PCC								SCC			Power		
	PCC Band	PCC Band Width (MHz)	PCC UL RB size	PCC UL RB offset	PCC DL RB size	PCC DL RB offset	PCC UL Channe l	PCC DL Channe l	SCC Band	SCC Band width (MHz)	SCC DL Channe l	Rel 8 LTETx Power (dBm)	Rel 10 DL LTE CA Tx Power (dBm)	Tune -up
12A-4A	12	5	1	12	25	0	23155	5155	4	20	2175	23.07	23.18	24
12A-66A	12	5	1	12	25	0	23155	5155	66	20	66786	23.07	23.14	24
12A-2A	12	5	1	12	25	0	23155	5155	2	20	900	23.07	23.21	24
66C	66	15	1	37	75	0	132047	66511	66	15	66661	23.28	23.40	24
66B	66	15	1	37	75	0	132047	66511	66	5	66604	23.28	23.33	24
66A-66A	66	5	1	12	25	0	132647	67111	66	20	66536	23.38	23.50	24
66A-2A	66	5	1	12	25	0	132647	67111	2	20	900	23.38	23.58	24
66A-12A	66	5	1	12	25	0	132647	67111	12	10	5095	23.38	23.50	24
66A-71A	66	5	1	12	25	0	132647	67111	71	20	68786	23.38	23.47	24
71A-2A	71	20	1	50	100	0	133322	68786	2	20	900	22.93	23.04	24
71A-4A	71	20	1	50	100	0	133322	68786	4	20	2175	22.93	23.00	24
71A-66A	71	20	1	50	100	0	133322	68786	66	20	66786	22.93	23.08	24

Note: Testing is not required in bands or modes not intended/allowed for US operation.

**Low Power**

The conducted power measurement results of downlink LTE CA are as below :

DL LT CA Class	PCC								SCC			Power		
	PCC Band	PCC Band Width (MHz)	PCC UL RB size	PCC UL RB offset	PCC DL RB size	PCC DL RB offset	PCC UL Channe l	PCC DL Channe l	SCC Band	SCC Band width (MHz)	SCC DL Channe l	Rel 8 LTETx Power (dBm)	Rel 10 DL LTE CA Tx Power (dBm)	Tune -up
66C	66	20	1	50	100	0	132572	67036	66	20	67234	19.30	19.44	20
66B	66	5	1	12	25	0	132647	67111	66	15	67204	19.50	19.62	20
66A-66A	66	5	1	12	25	0	132647	67111	66	20	66536	19.50	19.59	20
66A-2A	66	5	1	12	25	0	132647	67111	2	20	900	19.50	19.65	20
66A-12A	66	5	1	12	25	0	132647	67111	12	10	5095	19.50	19.57	20
66A-71A	66	5	1	12	25	0	132647	67111	71	20	68786	19.50	19.58	20

Note: Testing is not required in bands or modes not intended/allowed for US operation.

### 11.4 Wi-Fi and BT Measurement result

The maximum output power of BT is 9.00dBm.

The maximum tune up of BT is 9dBm.

#### Normal power

The average conducted power for Wi-Fi is as following:

802.11b(dBm)				
Channel\data rate	1Mbps	2Mbps	5.5Mbps	11Mbps
11(2462MHz)		/	20.25	/
6(2437MHz)	20.62	20.75	20.98	20.79
1(2412MHz)		/	20.45	/
<b>Tune up</b>	<b>21.50</b>	<b>21.50</b>	<b>21.50</b>	<b>21.50</b>

802.11g(dBm)								
Channel\data rate	6Mbps	9Mbps	12Mbps	18Mbps	24Mbps	36Mbps	48Mbps	54Mbps
11(2462MHz)	15.67	/	/	/	/	/	/	/
<b>Tune up</b>	<b>16.50</b>							
6(2437MHz)	19.69	17.69	16.86	15.77	14.67	14.68	14.97	14.98
<b>Tune up</b>	<b>20.50</b>	<b>18.50</b>	<b>17.50</b>	<b>16.50</b>	<b>16.00</b>	<b>16.00</b>	<b>16.00</b>	<b>16.00</b>
1(2412MHz)	15.87	/	/	/	/	/	/	/
<b>Tune up</b>	<b>16.50</b>							

802.11n(dBm)-20MHz								
Channel\data rate	MCS0	MCS1	MCS2	MCS3	MCS4	MCS5	MCS6	MCS7
11(2462MHz)	18.39	/	/	/	/	/	/	/
6(2437MHz)	18.66	17.63	17.62	16.55	15.70	16.08	16.07	16.08
1(2412MHz)	18.27	/	/	/	/	/	/	/
<b>Tune up</b>	<b>19.50</b>	<b>18.50</b>	<b>18.50</b>	<b>17.50</b>	<b>17.00</b>	<b>17.00</b>	<b>17.00</b>	<b>17.00</b>

802.11n(dBm)-40MHz								
Channel\data rate	MCS0	MCS1	MCS2	MCS3	MCS4	MCS5	MCS6	MCS7
9(2452MHz)	13.80	/	/	/	/	14.33	/	/
6(2437MHz)	14.46	14.45	14.44	14.23	14.22	14.75	14.74	14.74
3(2422MHz)	14.07	/	/	/	/	14.06	/	/
<b>Tune up</b>	<b>15.50</b>	<b>15.50</b>	<b>15.50</b>	<b>15.50</b>	<b>15.50</b>	<b>15.50</b>	<b>15.50</b>	<b>15.50</b>

802.11n(dBm)-20MHz								
Channel\data rate	MCS0	MCS1	MCS2	MCS3	MCS4	MCS5	MCS6	MCS7
36(5180 MHz)	18.73							
40(5200 MHz)	18.76							
44(5220 MHz)	18.79	17.07	14.79	13.31	12.28	11.32	11.24	11.20
48(5240 MHz)	18.70							
<b>Tune up</b>	<b>19.70</b>	<b>18.00</b>	<b>15.20</b>	<b>14.00</b>	<b>14.00</b>	<b>12.00</b>	<b>12.00</b>	<b>12.00</b>
52(5260 MHz)	18.58	16.65	14.22	13.02	12.03	11.03	10.96	10.94
56(5280 MHz)	18.37							
60(5300 MHz)	18.23							
64(5320 MHz)	<b>18.28</b>							
<b>Tune up</b>	<b>19.20</b>	<b>18.00</b>	<b>15.20</b>	<b>14.00</b>	<b>14.00</b>	<b>12.00</b>	<b>12.00</b>	<b>12.00</b>





802.11a(dBm)								
Channel\data rate	6Mbps	9Mbps	12Mbps	18Mbps	24Mbps	36Mbps	48Mbps	54Mbps
149(5745 MHz)	18.54							
153(5765 MHz)	18.81							
157(5785 MHz)	18.86	17.15	16.13	15.19	14.05	12.88	12.75	12.52
161(5805 MHz)	<b>18.58</b>							
165(5825 MHz)	18.45							
Tune up	19.00	19.00	16.50	16.50	15.00	13.50	13.50	13.50

Low Power

802.11b(dBm)				
Channel\data rate	1Mbps	2Mbps	5.5Mbps	11Mbps
11(2462MHz)	15.95	/	/	/
6(2437MHz)	16.40	16.24	16.30	16.26
1(2412MHz)	16.35			
Tune up	17.00	17.00	17.00	17.00

802.11g(dBm)								
Channel\data rate	6Mbps	9Mbps	12Mbps	18Mbps	24Mbps	36Mbps	48Mbps	54Mbps
11(2462MHz)	15.67	/	/	/	/	/	/	/
Tune up	16.50							
6(2437MHz)	16.01	13.96	12.83	11.88	10.96	10.95	11.24	11.24
Tune up	16.50	15.50	14.50	13.50	12.00	12.00	12.00	12.00
1(2412MHz)	15.87	/	/	/	/	/	/	/
Tune up	16.50							

802.11n(dBm)-20MHz								
Channel\data rate	MCS0	MCS1	MCS2	MCS3	MCS4	MCS5	MCS6	MCS7
11(2462MHz)	14.42	/	/	/	/	/	/	/
6(2437MHz)	14.80	13.88	13.64	12.74	11.80	12.12	12.12	12.12
1(2412MHz)	14.44							
Tune up	16.00	15.50	15.50	14.50	13.00	13.00	13.00	13.00

802.11n(dBm)-40MHz								
Channel\data rate	MCS0	MCS1	MCS2	MCS3	MCS4	MCS5	MCS6	MCS7
9(2452MHz)	10.03							
6(2437MHz)	10.48	10.47	10.46	10.47	10.21	10.34	10.36	10.32
3(2422MHz)	10.15	/	/	/	/	/	/	/
Tune up	11.50	11.50	11.50	11.50	11.50	11.50	11.50	11.50

802.11a(dBm)								
Channel\data rate	6Mbps	9Mbps	12Mbps	18Mbps	24Mbps	36Mbps	48Mbps	54Mbps
36(5180 MHz)	14.49							
40(5200 MHz)	14.62							
44(5220 MHz)	14.72	12.13	11.18	10.11	8.89	7.90	7.91	7.89
48(5240 MHz)	<b>14.29</b>							
52(5260 MHz)	<b>14.33</b>							
56(5280 MHz)	14.42							
60(5300 MHz)	14.47							
64(5320 MHz)	14.56	12.38	11.15	10.19	9.21	8.12	8.20	7.96
Tune up	<b>15.00</b>	14.00	12.50	11.50	10.50	9.50	9.50	9.50
149(5745 MHz)	15.59							
153(5765 MHz)	15.74	13.46	12.28	11.37	10.27	9.26	9.30	9.28
157(5785 MHz)	15.59							
161(5805 MHz)	<b>15.60</b>							
165(5825 MHz)	15.44							
Tune up	<b>16.00</b>	14.00	12.50	11.50	10.50	9.50	9.50	9.50

## 12 Simultaneous TX SAR Considerations

### 12.1 Introduction

The following procedures adopted from “FCC SAR Considerations for Cell Phones with Multiple Transmitters” are applicable to handsets with built-in unlicensed transmitters such as 802.11 a/b/g and Bluetooth devices which may simultaneously transmit with the licensed transmitter. For this device, the BT and Wi-Fi can transmit simultaneous with other transmitters.

### 12.2 Transmit Antenna Separation Distances

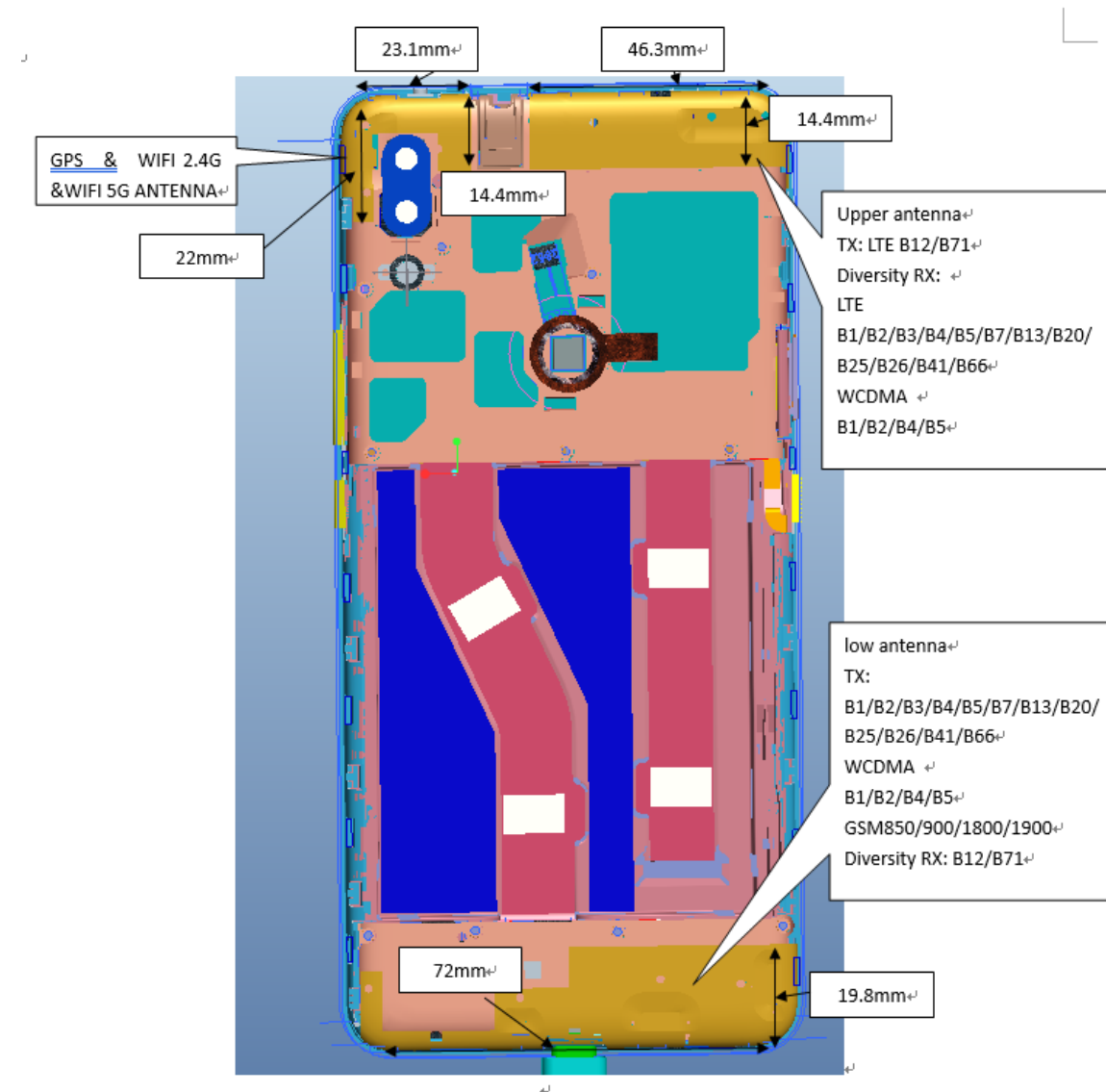

Morgan 4G TMO size	Length	Width	thickness
	170.5mm	84mm	8.45mm

Picture 12.1 Antenna Locations

### 12.3 SAR Measurement Positions

According to the KDB941225 D06 Hot Spot SAR v01, the edges with less than 2.5 cm distance to the antennas need to be tested for SAR.

SAR measurement positions						
Mode	Front	Rear	Left edge	Right edge	Top edge	Bottom edge
Upper antenna	Yes	Yes	Yes	Yes	Yes	No
Low antenna	Yes	Yes	Yes	Yes	No	Yes
WLAN	Yes	Yes	No	Yes	Yes	No

### 12.4 Standalone SAR Test Exclusion Considerations

Standalone 1-g head or body SAR evaluation by measurement or numerical simulation is not required when the corresponding SAR Exclusion Threshold condition, listed below, is satisfied. The 1-g SAR test exclusion threshold for 100 MHz to 6 GHz at test separation distances  $\leq 50$  mm are determined by:

$[(\text{max. power of channel, including tune-up tolerance, mW}) / (\text{min. test separation distance, mm})] \cdot [\sqrt{f(\text{GHz})}] \leq 3.0$  for 1-g SAR, where

- $f(\text{GHz})$  is the RF channel transmit frequency in GHz
- Power and distance are rounded to the nearest mW and mm before calculation
- The result is rounded to one decimal place for comparison

**Table 12.1: Standalone SAR test exclusion considerations**

Band/Mode	F(GHz)	Position	SAR test exclusion threshold(mW)	RF output power		SAR test exclusion
				dBm	mW	
Bluetooth	2.441	Head	9.60	9	7.94	Yes
		Body	19.20	9	7.94	Yes
2.4GHz WLAN	2.45	Head	9.58	17	50.12	No
		Body	19.17	21.5	141.25	No

### 13 Evaluation of Simultaneous

**Table 13.1: The sum of reported SAR values for main antenna and WiFi 2.4G**

	Position	band	Main antenna	WiFi	Sum	Distance (mm)	Ratio
<b>Highest reported SAR value for Head</b>	Left hand, Touch cheek	LTE Band12	0.71	0.87	<b>1.58</b>	/	/
<b>Highest reported SAR value for Body</b>	Rear 10mm	WCDMA1700	1.22	0.62	<b>1.84</b>	<b>156.34</b>	<b>0.02</b>
		LTE Band7	1.17	0.62	<b>1.79</b>	<b>149.40</b>	<b>0.02</b>
		LTE Band41 PC2	1.34	0.62	<b>1.96</b>	<b>146.76</b>	<b>0.02</b>
		LTE Band66	1.31	0.62	<b>1.93</b>	<b>151.75</b>	<b>0.02</b>
	Rear 15mm	WCDMA1700	1.32	0.30	<b>1.62</b>	<b>147.45</b>	<b>0.01</b>
		LTE Band66	1.37	0.30	<b>1.67</b>	<b>142.45</b>	<b>0.02</b>

According to the KDB 447498 D01, when the sum of SAR is larger than the limit, SAR test exclusion is determined by the SAR to peak location separation ratio. The ratio is determined by  $(SAR_1 + SAR_2)^{1.5}/R_i$ , rounded to two decimal digits, and must be  $\leq 0.04$  for all antenna pairs in the configuration to qualify for 1-g SAR test exclusion.

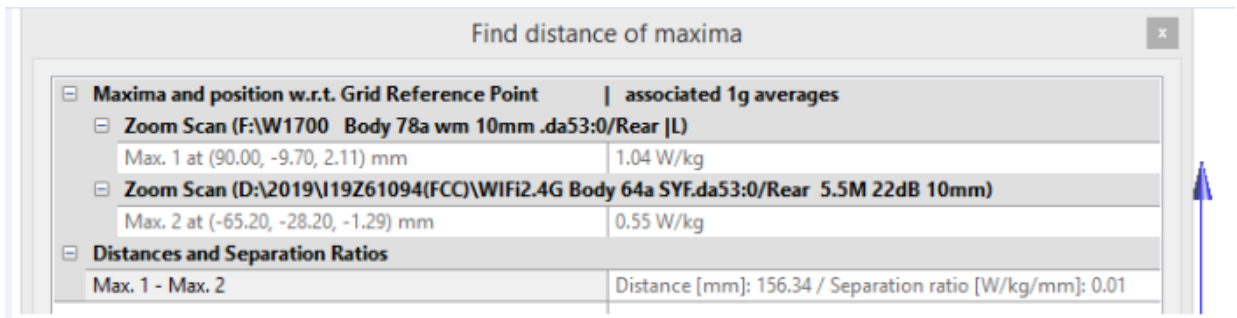

**Picture 13.1 Distance evaluation for WCDMA1700 and WiFi 2.4G 10mm**

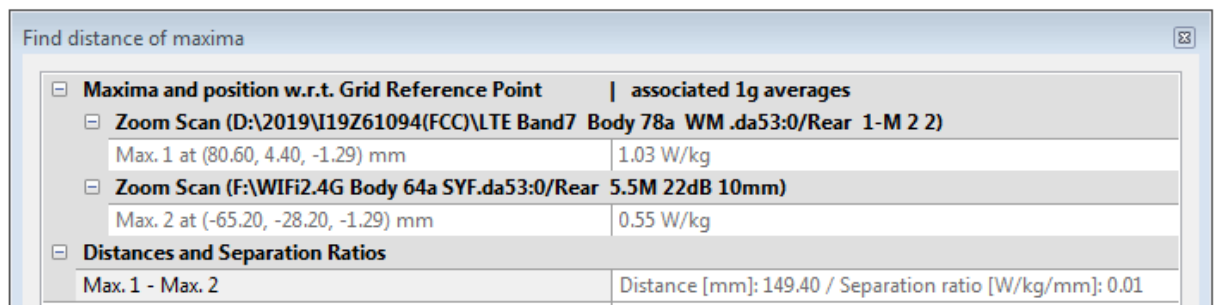

**Picture 13.2 Distance evaluation for LTE Band7 and WiFi 2.4G 10mm**

Find distance of maxima

Maxima and position w.r.t. Grid Reference Point		associated 1g averages
Zoom Scan (F:\WiFi2.4G Body 64a SYF.da53:0/Rear 5.5M 22dB 10mm)		
Max. 1 at (-65.20, -28.20, -1.29) mm		0.55 W/kg
Zoom Scan (F:\2.2450Mhz Body.da53:0/LTE Band41 Rear_10mm 1RB_Mid_P2_CH41490)		
Max. 2 at (76.60, 9.60, 0.22) mm		1.12 W/kg
Distances and Separation Ratios		
Max. 1 - Max. 2		Distance [mm]: 146.76 / Separation ratio [W/kg/mm]: 0.01

Picture 13.3 Distance evaluation for LTE B41 (PC2) and WiFi 2.4G 10mm

Find distance of maxima

Maxima and position w.r.t. Grid Reference Point		associated 1g averages
Zoom Scan (F:\WiFi2.4G Body 64a SYF.da53:0/Rear 5.5M 22dB 10mm)		
Max. 1 at (-65.20, -28.20, -1.29) mm		0.55 W/kg
Zoom Scan (D:\2019\I19Z61094(FCC)\LTE B66 Body 86a wm .da53:0/Rear 50-L 10mm 2)		
Max. 2 at (85.50, -10.70, 2.12) mm		1.05 W/kg
Distances and Separation Ratios		
Max. 1 - Max. 2		Distance [mm]: 151.75 / Separation ratio [W/kg/mm]: 0.01

Picture 13.4 Distance evaluation for LTE B66 and WiFi 2.4G 10mm

Find distance of maxima

Maxima and position w.r.t. Grid Reference Point		associated 1g averages
Zoom Scan (D:\2019\I19Z61094(FCC)\WiFi2.4G Body 64a wm 15mm .da53:0/Rear CH6 22DB 5.5M)		
Max. 1 at (-62.20, -25.80, 0.52) mm		0.27 W/kg
Zoom Scan (F:\1.1800Mhz Body.da53:0/WCDMA 1700 Rear_15mm)		
Max. 2 at (84.50, -11.00, -0.15) mm		1.20 W/kg
Distances and Separation Ratios		
Max. 1 - Max. 2		Distance [mm]: 147.45 / Separation ratio [W/kg/mm]: 0.01

Picture 13.5 Distance evaluation for WCDMA1700 and WiFi 2.4G 15mm

Find distance of maxima

Maxima and position w.r.t. Grid Reference Point		associated 1g averages
Zoom Scan (D:\2019\I19Z61094(FCC)\WiFi2.4G Body 64a wm 15mm .da53:0/Rear CH6 22DB 5.5M)		
Max. 1 at (-62.20, -25.80, 0.52) mm		0.27 W/kg
Zoom Scan (F:\4.1800Mhz Body.da53:0/LTE Band 66 Rear_15mm_1RB-Mid_CH132072)		
Max. 2 at (79.00, -7.00, -0.12) mm		1.15 W/kg
Distances and Separation Ratios		
Max. 1 - Max. 2		Distance [mm]: 142.45 / Separation ratio [W/kg/mm]: 0.01

Picture 13.6 Distance evaluation for LTE B66 and WiFi 2.4G 15mm

**Table 13.2 The sum of reported SAR values for main antenna and WiFi 5G**

	Position	band	Main antenna	WiFi	Sum	Distance (mm)	Ratio
<b>Highest reported SAR value for Head</b>	Left hand, Touch cheek	LTE Band12	0.71	0.61	<b>1.32</b>	/	/
<b>Highest reported SAR value for Body</b>	Rear 10mm	GSM1900	0.82	1.04	<b>1.86</b>	<b>170.20</b>	<b>0.01</b>
		W1900	0.65	1.04	<b>1.69</b>	<b>158.96</b>	<b>0.01</b>
		W1700	1.22	1.04	<b>2.26</b>	<b>172.28</b>	<b>0.02</b>
		LTE Band7	1.17	1.04	<b>2.21</b>	<b>166.49</b>	<b>0.02</b>
		LTE Band41 PC2	1.34	1.04	<b>2.38</b>	<b>164.26</b>	<b>0.02</b>
		LTE Band41 PC3	0.71	1.04	<b>1.75</b>	<b>159.43</b>	<b>0.01</b>
		LTE Band66	1.31	1.04	<b>2.35</b>	<b>167.68</b>	<b>0.02</b>
	Rear 15mm	W1700	1.32	0.82	<b>2.14</b>	<b>157.25</b>	<b>0.02</b>
		LTE Band66	1.37	0.82	<b>2.19</b>	<b>152.48</b>	<b>0.02</b>

According to the KDB 447498 D01, when the sum of SAR is larger than the limit, SAR test exclusion is determined by the SAR to peak location separation ratio. The ratio is determined by  $(SAR_1 + SAR_2)^{1.5}/R_i$ , rounded to two decimal digits, and must be  $\leq 0.04$  for all antenna pairs in the configuration to qualify for 1-g SAR test exclusion.

Find distance of maxima

Maxima and position w.r.t. Grid Reference Point   associated 1g averages	
Zoom Scan (F:\WiFi5G Body 64a SYF 8.28.da53:0/Rear 6M 22dB 10mm)	
Max. 1 at (-79.00, -43.00, -1.34) mm	1.00 W/kg
Zoom Scan (D:\2019\I19Z61094(FCC)\GSM1900 Body 78a wm 10mm .da53:0/Rear  L)	
Max. 2 at (87.40, -7.40, 2.07) mm	0.78 W/kg
Distances and Separation Ratios	
Max. 1 - Max. 2	Distance [mm]: 170.20 / Separation ratio [W/kg/mm]: 0.01

**Picture 13.7 Distance evaluation for GSM1900 and WiFi 5G 10mm**

Maxima and position w.r.t. Grid Reference Point   associated 1g averages	
Zoom Scan (F:\WiFi5G Body 64a SYF 8.28.da53:0/Rear 6M 22dB 10mm)	
Max. 1 at (-79.00, -43.00, -1.34) mm	1.00 W/kg
Zoom Scan (D:\2019\I19Z61094(FCC)\W1900 Body 78a wm 10mm .da53:0/Rear  L)	
Max. 2 at (76.00, -7.90, 1.87) mm	0.60 W/kg
Distances and Separation Ratios	
Max. 1 - Max. 2	Distance [mm]: 158.96 / Separation ratio [W/kg/mm]: 0.01

**Picture 13.8 Distance evaluation for WCDMA1900 and WiFi 5G 10mm**

Find distance of maxima

Maxima and position w.r.t. Grid Reference Point		associated 1g averages
Zoom Scan (D:\2019\I19Z61094(FCC)\W1700 Body 78a wm 10mm .da53:0/Rear  L)		
Max. 1 at (90.00, -9.70, 2.11) mm		1.04 W/kg
Zoom Scan (F:\WIFI5G Body 64a SYF 8.28.da53:0/Rear 6M 22dB 10mm)		
Max. 2 at (-79.00, -43.00, -1.34) mm		1.00 W/kg
Distances and Separation Ratios		
Max. 1 - Max. 2		Distance [mm]: 172.28 / Separation ratio [W/kg/mm]: 0.02

Picture 13.9 Distance evaluation for WCDMA1700 and WiFi 5G 10mm

Find distance of maxima

Maxima and position w.r.t. Grid Reference Point		associated 1g averages
Zoom Scan (F:\WIFI5G Body 64a SYF 8.28.da53:0/Rear 6M 22dB 10mm)		
Max. 1 at (-79.00, -43.00, -1.34) mm		1.00 W/kg
Zoom Scan (D:\2019\I19Z61094(FCC)\LTE Band7 Body 78a WM .da53:0/Rear 1-M 2 2)		
Max. 2 at (80.60, 4.40, -1.29) mm		1.03 W/kg
Distances and Separation Ratios		
Max. 1 - Max. 2		Distance [mm]: 166.49 / Separation ratio [W/kg/mm]: 0.02

Picture 13.10 Distance evaluation for LTE Band7 and WiFi 5G 10mm

Find distance of maxima

Maxima and position w.r.t. Grid Reference Point		associated 1g averages
Zoom Scan (F:\WIFI5G Body 64a SYF 8.28.da53:0/Rear 6M 22dB 10mm)		
Max. 1 at (-79.00, -43.00, -1.34) mm		1.00 W/kg
Zoom Scan (F:\2.2450Mhz Body.da53:0/LTE Band41 Rear_10mm 1RB_Mid_P2_CH41490)		
Max. 2 at (76.60, 9.60, 0.22) mm		1.12 W/kg
Distances and Separation Ratios		
Max. 1 - Max. 2		Distance [mm]: 164.26 / Separation ratio [W/kg/mm]: 0.02

Picture 13.11 Distance evaluation for LTE B41 (PC2) and WiFi5G 10mm

Find distance of maxima

Maxima and position w.r.t. Grid Reference Point		associated 1g averages
Zoom Scan (D:\2019\I19Z61094(FCC)\LTE Band41 Body 78a wm power class 3.da53:0/Rear 1-M)		
Max. 1 at (74.50, 0.00, 1.48) mm		0.65 W/kg
Zoom Scan (F:\WIFI5G Body 64a SYF 8.28.da53:0/Rear 6M 22dB 10mm)		
Max. 2 at (-79.00, -43.00, -1.34) mm		1.00 W/kg
Distances and Separation Ratios		
Max. 1 - Max. 2		Distance [mm]: 159.43 / Separation ratio [W/kg/mm]: 0.01

Picture 13.12 Distance evaluation for LTE B41 (PC3) and WiFi5G 10mm

Find distance of maxima

Maxima and position w.r.t. Grid Reference Point		associated 1g averages
Zoom Scan (D:\2019\I19Z61094(FCC)\LTE B66 Body 86a wm .da53:0/Rear 50-L 10mm 2)		
Max. 1 at (85.50, -10.70, 2.12) mm		1.05 W/kg
Zoom Scan (F:\WIFI5G Body 64a SYF 8.28.da53:0/Rear 6M 22dB 10mm)		
Max. 2 at (-79.00, -43.00, -1.34) mm		1.00 W/kg
Distances and Separation Ratios		
Max. 1 - Max. 2		Distance [mm]: 167.68 / Separation ratio [W/kg/mm]: 0.02

Picture 13.13 Distance evaluation for LTE Band66 and WiFi 5G 10mm

Find distance of maxima

Maxima and position w.r.t. Grid Reference Point		associated 1g averages
Zoom Scan (F:\1.1800Mhz Body.da53:0/WCDMA 1700 Rear_15mm)		
Max. 1 at (84.50, -11.00, -0.15) mm		1.20 W/kg
Zoom Scan (D:\2019\I19Z61094(FCC)\WIFI5G Body 64a wm 15mm .da53:0/Rear CH153 22DB MCSO 11n-20)		
Max. 2 at (-71.00, -34.40, 0.51) mm		0.78 W/kg
Distances and Separation Ratios		
Max. 1 - Max. 2		Distance [mm]: 157.25 / Separation ratio [W/kg/mm]: 0.02

Picture 13.14 Distance evaluation for WCDMA1700 and WiFi 5G 15mm

Find distance of maxima

Maxima and position w.r.t. Grid Reference Point		associated 1g averages
Zoom Scan (F:\4.1800Mhz Body.da53:0/LTE Band 66 Rear_15mm_1RB-Mid_CH132072)		
Max. 1 at (79.00, -7.00, -0.12) mm		1.15 W/kg
Zoom Scan (D:\2019\I19Z61094(FCC)\WIFI5G Body 64a wm 15mm .da53:0/Rear CH153 22DB MCSO 11n-20)		
Max. 2 at (-71.00, -34.40, 0.51) mm		0.78 W/kg
Distances and Separation Ratios		
Max. 1 - Max. 2		Distance [mm]: 152.48 / Separation ratio [W/kg/mm]: 0.02

Picture 13.15 Distance evaluation for LTE Band66 and WiFi 5G 15mm

Table 13.3: The sum of reported SAR values for main antenna and BT

	Position	Main antenna	BT	Sum
Maximum reported SAR value for Head	Left hand, Touch cheek	0.71	0.33 <sup>[1]</sup>	<b>1.04</b>
Maximum reported SAR value for Body	Bottom 10mm	1.35	0.17 <sup>[1]</sup>	<b>1.52</b>
Maximum reported SAR value for Body	Rear 15mm	1.37	0.11 <sup>[1]</sup>	<b>1.48</b>

[1] - Estimated SAR for Bluetooth (see the table 13.4)

Table 13.4: Estimated SAR for Bluetooth

Mode/Band	F (GHz)	Position	Distance (mm)	Upper limit of power *		Estimated <sub>1g</sub> (W/kg)
				dBm	mW	
Bluetooth	2.441	Head	5	9	7.94	0.33
Bluetooth	2.441	Body	10	9	7.94	0.17
Bluetooth	2.441	Body	15	9	7.94	0.11



\* - Maximum possible output power declared by manufacturer

When standalone SAR test exclusion applies to an antenna that transmits simultaneously with other antennas, the standalone SAR must be estimated according to following to determine simultaneous transmission SAR test exclusion:

(max. power of channel, including tune-up tolerance, mW)/(min. test separation distance,mm)]·[ $\sqrt{f(\text{GHz})/x}$ ] W/kg for test separation distances  $\leq 50$  mm;

where  $x = 7.5$  for 1-g SAR.

When the minimum test separation distance is  $< 5$  mm, a distance of 5 mm is applied to determine SAR test exclusion

**Conclusion:**

According to the above tables, the sum of reported SAR values is  $> 1.6\text{W/kg}$ , but the SAR to peak location separation ratio  $< 0.04$ . So the simultaneous transmission SAR with volume scans is not required.

## 14 SAR Test Result

It is determined by user manual for the distance between the EUT and the phantom bottom. The distance is 10 mm or 15mm and just applied to the condition of body worn accessory.

It is performed for all SAR measurements with area scan based 1-g SAR estimation (Fast SAR). A zoom scan measurement is added when the estimated 1-gSAR is the highest measured SAR in each exposure configuration, wireless mode and frequency band combination or more than 1.2W/kg.

The calculated SAR is obtained by the following formula:

$$\text{Reported SAR} = \text{Measured SAR} \times 10^{(P_{\text{Target}} - P_{\text{Measured}})/10}$$

Where  $P_{\text{Target}}$  is the power of manufacturing upper limit;

$P_{\text{Measured}}$  is the measured power in chapter 11.

**Table 14.1: Duty Cycle**

Mode	Duty Cycle
Speech for GSM850/1900	1:8.3
GPRS&EGPRS for GSM850- Normal Power	1:2
GPRS&EGPRS for GSM1900- Normal Power	1:4
GPRS&EGPRS for GSM1900-Low Power	1:2
WCDMA&LTE FDD	1:1
LTE B41 PC2	1:2.309
LTE B41 PC3	1:1.58

### 14.1 SAR results for Fast SAR

**Table 14.1-1: SAR Values (GSM 850 MHz Band - Head)**

Ambient Temperature: 22.9 °C						Liquid Temperature: 22.5 °C					
Frequency		Side	Test Position	Figure No.	Conducted Power (dBm)	Max. tune-up Power (dBm)	Measured SAR(10g) (W/kg)	Reported SAR(10g) (W/kg)	Measured SAR(1g) (W/kg)	Reported SAR(1g) (W/kg)	Power Drift (dB)
Ch.	MHz										
251	848.8	Left	Touch	/	32.18	33.50	0.060	<b>0.08</b>	0.081	<b>0.11</b>	0.09
190	836.6	Left	Touch	/	32.17	33.50	0.062	<b>0.08</b>	0.084	<b>0.11</b>	-0.02
128	824.2	Left	Touch	Fig.1	32.14	33.50	0.089	<b>0.12</b>	0.119	<b>0.16</b>	0.05
190	836.6	Left	Tilt	/	32.17	33.50	0.035	<b>0.05</b>	0.048	<b>0.07</b>	0.09
190	836.6	Right	Touch	/	32.17	33.50	0.058	<b>0.08</b>	0.076	<b>0.10</b>	0.00
190	836.6	Right	Tilt	/	32.17	33.50	0.030	<b>0.04</b>	0.042	<b>0.06</b>	-0.05

**Table 14.1-2: SAR Values (GSM 850 MHz Band - Body)**

Ambient Temperature: 22.9 °C						Liquid Temperature: 22.5 °C					
Frequency		Mode (number of timeslots)	Test Position	Figure No.	Conducted Power (dBm)	Max. tune-up Power (dBm)	Measured SAR(10g) (W/kg)	Reported SAR(10g) (W/kg)	Measured SAR(1g) (W/kg)	Reported SAR(1g) (W/kg)	Power Drift (dB)
Ch.	MHz										
190	836.6	GPRS (4)	Front	/	28.97	29.50	0.189	<b>0.21</b>	0.298	<b>0.34</b>	0.10
251	848.8	GPRS (4)	Rear	/	28.99	29.50	0.257	<b>0.29</b>	0.411	<b>0.46</b>	-0.07
190	836.6	GPRS (4)	Rear	/	28.97	29.50	0.266	<b>0.30</b>	0.452	<b>0.51</b>	-0.08
128	824.2	GPRS (4)	Rear	Fig.2	28.93	29.50	0.276	<b>0.32</b>	0.458	<b>0.52</b>	-0.03
190	836.6	GPRS (4)	Left	/	28.97	29.50	0.107	<b>0.12</b>	0.156	<b>0.18</b>	0.07
190	836.6	GPRS (4)	Right	/	28.97	29.50	0.069	<b>0.08</b>	0.103	<b>0.12</b>	0.13
190	836.6	GPRS (4)	Bottom	/	28.97	29.50	0.097	<b>0.11</b>	0.182	<b>0.21</b>	0.01
128	824.2	EGPRS (4)	Rear	/	28.92	29.50	0.253	<b>0.29</b>	0.421	<b>0.48</b>	-0.09

Note: The distance between the EUT and the phantom bottom is 10mm.

**Table 14.1-3: SAR Values (GSM 1900 MHz Band - Head)**

Frequency		Side	Test Position	Figure No.	Conducted Power (dBm)	Max. tune-up Power (dBm)	Measured SAR(10g) (W/kg)	Reported SAR(10g) (W/kg)	Measured SAR(1g) (W/kg)	Reported SAR(1g) (W/kg)	Power Drift (dB)
Ch.	MHz										
810	1909.8	Left	Touch	/	30.19	31.00	0.061	<b>0.07</b>	0.101	<b>0.12</b>	0.07
661	1880	Left	Touch	Fig.3	30.20	31.00	0.089	<b>0.11</b>	0.144	<b>0.17</b>	-0.01
512	1850.2	Left	Touch	/	30.21	31.00	0.040	<b>0.05</b>	0.060	<b>0.07</b>	-0.10
661	1880	Left	Tilt	/	30.20	31.00	0.068	<b>0.08</b>	0.106	<b>0.13</b>	0.06
661	1880	Right	Touch	/	30.20	31.00	0.062	<b>0.07</b>	0.093	<b>0.11</b>	0.12
661	1880	Right	Tilt	/	30.20	31.00	0.054	<b>0.06</b>	0.091	<b>0.11</b>	0.00

**Table 14.1-4: SAR Values (GSM 1900 MHz Band - Body)**

Frequency		Mode (number of timeslots)	Test Position	Figure No.	Conducted Power (dBm)	Max. tune-up Power (dBm)	Measured SAR(10g) (W/kg)	Reported SAR(10g) (W/kg)	Measured SAR(1g) (W/kg)	Reported SAR(1g) (W/kg)	Power Drift (dB)
Ch.	MHz										
661	1880	GPRS (4)	Front	/	26.79	27	0.397	<b>0.42</b>	0.666	<b>0.70</b>	-0.01
810	1909.8	GPRS (4)	Rear	/	26.84	27	0.437	<b>0.45</b>	0.732	<b>0.76</b>	0.06
661	1880	GPRS (4)	Rear	/	26.79	27	0.466	<b>0.49</b>	0.781	<b>0.82</b>	0.01
512	1850.2	GPRS (4)	Rear	/	26.61	27	0.452	<b>0.49</b>	0.743	<b>0.81</b>	0.09
661	1880	GPRS (4)	Left	/	26.79	27	0.121	<b>0.13</b>	0.201	<b>0.21</b>	-0.06
661	1880	GPRS (4)	Right	/	26.79	27	0.056	<b>0.06</b>	0.096	<b>0.10</b>	0.01
810	1909.8	GPRS (4)	Bottom	/	26.84	27	0.375	<b>0.39</b>	0.710	<b>0.74</b>	0.01
661	1880	GPRS (4)	Bottom	/	26.79	27	0.42	<b>0.44</b>	0.815	<b>0.85</b>	-0.05
512	1850.2	GPRS (4)	Bottom	Fig.4	26.61	27	0.589	<b>0.64</b>	1.10	<b>1.20</b>	-0.02
512	1850.2	EGPRS (4)	Bottom	/	26.61	27	0.533	<b>0.58</b>	0.983	<b>1.07</b>	0.13
512	1850.2	GPRS (4)	Bottom	Note1	26.61	27	2.08	<b>2.27</b>	4.84	<b>5.29</b>	-0.07

Note: The distance between the EUT and the phantom bottom is 10mm.

Note1: The distance between the EUT and the phantom bottom is 0mm Base on the Principle of adding Test for Phablet.

**Table 14.1-5: SAR Values (GSM 1900 MHz Band - Body)**

Frequency		Mode (number of timeslots)	Test Position	Figure No.	Conducted Power (dBm)	Max. tune-up Power (dBm)	Measured SAR(10g) (W/kg)	Reported SAR(10g) (W/kg)	Measured SAR(1g) (W/kg)	Reported SAR(1g) (W/kg)	Power Drift (dB)
Ch.	MHz										
810	1909.8	GPRS (2)	Front	/	29.50	30.00	0.261	<b>0.29</b>	0.432	<b>0.48</b>	-0.03
661	1880	GPRS (2)	Front	/	29.48	30.00	0.259	<b>0.29</b>	0.413	<b>0.47</b>	0.10
512	1850.2	GPRS (2)	Front	Fig.5	29.43	30.00	0.267	<b>0.30</b>	0.435	<b>0.50</b>	-0.08
661	1880	GPRS (2)	Rear	/	29.48	30.00	0.242	<b>0.27</b>	0.389	<b>0.44</b>	-0.04
661	1880	EGPRS (2)	Rear	/	29.43	30.00	0.245	<b>0.28</b>	0.398	<b>0.45</b>	-0.09

Note: The distance between the EUT and the phantom bottom is 15mm.

**Table 14.1-6: SAR Values (WCDMA 850 MHz Band - Head)**

Frequency		Side	Test Position	Figure No.	Conducted Power (dBm)	Max. tune-up Power (dBm)	Measured SAR(10g) (W/kg)	Reported SAR(10g) (W/kg)	Measured SAR(1g) (W/kg)	Reported SAR(1g) (W/kg)	Power Drift (dB)
Ch.	MHz										
Ambient Temperature: 22.9 °C      Liquid Temperature: 22.5 °C											
4233	846.6	Left	Touch	/	23.53	24.00	0.102	<b>0.11</b>	0.140	<b>0.16</b>	0.04
4183	836.6	Left	Touch	Fig.6	23.51	24.00	0.112	<b>0.13</b>	0.152	<b>0.17</b>	0.01
4132	826.4	Left	Touch	/	23.48	24.00	0.107	<b>0.12</b>	0.145	<b>0.16</b>	0.02
4183	836.6	Left	Tilt	/	23.51	24.00	0.049	<b>0.05</b>	0.064	<b>0.07</b>	0.09
4183	836.6	Right	Touch	/	23.51	24.00	0.097	<b>0.11</b>	0.127	<b>0.14</b>	-0.08
4183	836.6	Right	Tilt	/	23.51	24.00	0.062	<b>0.07</b>	0.079	<b>0.09</b>	-0.07

**Table 14.1-7: SAR Values (WCDMA 850 MHz Band - Body)**

Frequency		Test Position	Figure No.	Conducted Power (dBm)	Max. tune-up Power (dBm)	Measured SAR(10g) (W/kg)	Reported SAR(10g) (W/kg)	Measured SAR(1g) (W/kg)	Reported SAR(1g) (W/kg)	Power Drift (dB)
Ch.	MHz									
Ambient Temperature: 22.9 °C      Liquid Temperature: 22.5 °C										
4183	836.6	Front	/	23.51	24.00	0.131	<b>0.15</b>	0.218	<b>0.24</b>	0.09
4233	846.6	Rear	/	23.53	24.00	0.165	<b>0.18</b>	0.271	<b>0.30</b>	0.09
4183	836.6	Rear	Fig.7	23.51	24.00	0.167	<b>0.19</b>	0.277	<b>0.31</b>	0.00
4132	826.4	Rear	/	23.48	24.00	0.156	<b>0.18</b>	0.258	<b>0.29</b>	0.03
4183	836.6	Left	/	23.51	24.00	0.092	<b>0.10</b>	0.141	<b>0.16</b>	0.05
4183	836.6	Right	/	23.51	24.00	0.061	<b>0.07</b>	0.093	<b>0.10</b>	0.12
4183	836.6	Bottom	/	23.51	24.00	0.043	<b>0.05</b>	0.062	<b>0.07</b>	0.03

Note: The distance between the EUT and the phantom bottom is 10mm.

**Table 14.1-8: SAR Values (WCDMA 1700 MHz Band - Head)**

Frequency		Side	Test Position	Figure No.	Conducted Power (dBm)	Max. tune-up Power (dBm)	Measured SAR(10g) (W/kg)	Reported SAR(10g) (W/kg)	Measured SAR(1g) (W/kg)	Reported SAR(1g) (W/kg)	Power Drift (dB)
Ch.	MHz										
Ambient Temperature: 22.9 °C      Liquid Temperature: 22.5 °C											
1412	1732.4	Left	Touch	/	23.55	24.00	0.055	<b>0.06</b>	0.086	<b>0.10</b>	0.03
1412	1732.4	Left	Tilt	/	23.55	24.00	0.067	<b>0.07</b>	0.104	<b>0.12</b>	-0.08
1513	1752.6	Right	Touch	Fig.8	23.61	24.00	0.082	<b>0.09</b>	0.129	<b>0.14</b>	0.06
1412	1732.4	Right	Touch	/	23.55	24.00	0.076	<b>0.08</b>	0.121	<b>0.13</b>	0.13
1312	1712.4	Right	Touch	/	23.58	24.00	0.073	<b>0.08</b>	0.116	<b>0.13</b>	0.13
1412	1732.4	Right	Tilt	/	23.55	24.00	0.069	<b>0.08</b>	0.105	<b>0.12</b>	0.13

**Table 14.1-9: SAR Values (WCDMA 1700 MHz Band - Body)**

Frequency		Test Position	Figure No.	Conducted Power (dBm)	Max. tune-up Power (dBm)	Ambient Temperature: 22.9 °C		Liquid Temperature: 22.5°C		Power Drift (dB)
Ch.	MHz					Measured SAR(10g) (W/kg)	Reported SAR(10g) (W/kg)	Measured SAR(1g) (W/kg)	Reported SAR(1g) (W/kg)	
1412	1732.5	Front	/	19.31	20.00	0.229	<b>0.27</b>	0.393	<b>0.46</b>	-0.09
1513	1752.6	Rear	/	19.30	20.00	0.394	<b>0.46</b>	0.741	<b>0.87</b>	0.12
1412	1732.5	Rear	/	19.31	20.00	0.451	<b>0.53</b>	0.855	<b>1.00</b>	-0.02
1312	1712.4	Rear	Fig.9	19.32	20.00	0.555	<b>0.65</b>	1.04	<b>1.22</b>	0.13
1412	1732.5	Left	/	19.31	20.00	0.032	<b>0.04</b>	0.053	<b>0.06</b>	-0.09
1412	1732.5	Right	/	19.31	20.00	0.028	<b>0.03</b>	0.044	<b>0.05</b>	-0.02
1513	1752.6	Bottom	/	19.30	20.00	0.359	<b>0.42</b>	0.677	<b>0.80</b>	-0.09
1412	1732.5	Bottom	/	19.31	20.00	0.405	<b>0.47</b>	0.758	<b>0.89</b>	-0.04
1312	1712.4	Bottom	/	19.32	20.00	0.461	<b>0.54</b>	0.811	<b>0.95</b>	-0.04
1312	1712.4	Rear	Note1	19.32	20.00	1.09	<b>1.27</b>	2.380	<b>2.78</b>	0.04
1312	1712.4	Rear	Headset	19.32	20.00	0.469	<b>0.55</b>	0.926	<b>1.08</b>	-0.07

Note: The distance between the EUT and the phantom bottom is 10mm

Note1: The distance between the EUT and the phantom bottom is 0mm Base on the Principle of adding Test for Phablet.

**Table 14.1-10: SAR Values (WCDMA 1700 MHz Band - Body)**

Frequency		Test Position	Figure No.	Conducted Power (dBm)	Max. tune-up Power (dBm)	Ambient Temperature: 22.9 °C		Liquid Temperature: 22.5°C		Power Drift (dB)
Ch.	MHz					Measured SAR(10g) (W/kg)	Reported SAR(10g) (W/kg)	Measured SAR(1g) (W/kg)	Reported SAR(1g) (W/kg)	
1412	1732.5	Front	/	23.55	24.00	0.336	<b>0.37</b>	0.517	<b>0.57</b>	0.12
1513	1752.6	Rear	/	23.61	24.00	0.497	<b>0.54</b>	0.834	<b>0.91</b>	-0.06
1412	1732.5	Rear	/	23.55	24.00	0.579	<b>0.64</b>	0.987	<b>1.09</b>	0.05
1312	1712.4	Rear	Fig.10	23.58	24.00	0.697	<b>0.77</b>	1.20	<b>1.32</b>	0.14
1312	1712.4	Rear	Headset	23.58	24.00	0.643	<b>0.71</b>	1.05	<b>1.16</b>	-0.01

Note1: The distance between the EUT and the phantom bottom is 15mm.

**Table 14.1-11: SAR Values (WCDMA 1900 MHz Band - Head)**

Frequency		Side	Test Position	Figure No.	Conducted Power (dBm)	Max. tune-up Power (dBm)	Ambient Temperature: 22.9 °C		Liquid Temperature: 22.5°C		Power Drift (dB)
Ch.	MHz						Measured SAR(10g) (W/kg)	Reported SAR(10g) (W/kg)	Measured SAR(1g) (W/kg)	Reported SAR(1g) (W/kg)	
9800	1880	Left	Touch	/	23.64	24.00	0.098	<b>0.11</b>	0.160	<b>0.17</b>	-0.05
9938	1907.6	Left	Tilt	/	23.68	24.00	0.135	<b>0.15</b>	0.213	<b>0.23</b>	-0.13
9800	1880	Left	Tilt	Fig.11	23.64	24.00	0.139	<b>0.15</b>	0.222	<b>0.24</b>	-0.06
9662	1852.4	Left	Tilt	/	23.57	24.00	0.125	<b>0.14</b>	0.196	<b>0.22</b>	0.04
9800	1880	Right	Touch	/	23.64	24.00	0.120	<b>0.13</b>	0.178	<b>0.19</b>	0.08
9800	1880	Right	Tilt	/	23.64	24.00	0.116	<b>0.13</b>	0.176	<b>0.19</b>	0.01

**Table 14.1-12: SAR Values (WCDMA 1900 MHz Band - Body)**

Ambient Temperature: 22.9 °C						Liquid Temperature: 22.5 °C				
Frequency		Test Position	Figure No.	Conducted Power (dBm)	Max. tune-up Power (dBm)	Measured SAR(10g) (W/kg)	Reported SAR(10g) (W/kg)	Measured SAR(1g) (W/kg)	Reported SAR(1g) (W/kg)	Power Drift (dB)
Ch.	MHz									
9800	1880	Front	/	21.69	22.00	0.317	<b>0.34</b>	0.552	<b>0.59</b>	-0.12
9800	1880	Rear	/	21.69	22.00	0.351	<b>0.38</b>	0.602	<b>0.65</b>	-0.05
9800	1880	Left	/	21.69	22.00	0.128	<b>0.14</b>	0.209	<b>0.22</b>	-0.07
9800	1880	Right	/	21.69	22.00	0.055	<b>0.06</b>	0.093	<b>0.10</b>	-0.13
9938	1907.6	Bottom	/	21.71	22.00	0.338	<b>0.36</b>	0.646	<b>0.69</b>	-0.02
9800	1880	Bottom	/	21.69	22.00	0.441	<b>0.47</b>	0.849	<b>0.91</b>	0.11
9662	1852.4	Bottom	Fig.12	21.57	22.00	0.498	<b>0.55</b>	0.932	<b>1.03</b>	-0.11
9662	1852.4	Bottom	Note1	21.57	22.00	1.230	<b>1.36</b>	2.83	<b>3.12</b>	-0.02

Note: The distance between the EUT and the phantom bottom is 10mm.

Note1: The distance between the EUT and the phantom bottom is 0mm Base on the Principle of adding Test for Phablet.

**Table 14.1-13: SAR Values (WCDMA 1900 MHz Band - Body)**

Ambient Temperature: 22.9 °C						Liquid Temperature: 22.5 °C				
Frequency		Test Position	Figure No.	Conducted Power (dBm)	Max. tune-up Power (dBm)	Measured SAR(10g) (W/kg)	Reported SAR(10g) (W/kg)	Measured SAR(1g) (W/kg)	Reported SAR(1g) (W/kg)	Power Drift (dB)
Ch.	MHz									
9938	1907.6	Front	/	23.68	24.00	0.309	<b>0.33</b>	0.503	<b>0.54</b>	0.10
9800	1880	Front	/	23.64	24.00	0.320	<b>0.35</b>	0.522	<b>0.57</b>	0.04
9662	1852.4	Front	Fig.13	23.57	24.00	0.326	<b>0.36</b>	0.530	<b>0.59</b>	-0.01
9800	1880	Rear	/	23.64	24.00	0.226	<b>0.25</b>	0.368	<b>0.40</b>	0.04

Note1: The distance between the EUT and the phantom bottom is 15mm.

**Table 14.1-14: SAR Values (LTE Band7 - Head)**

Ambient Temperature: 22.9 °C						Liquid Temperature: 22.5 °C						
Frequency		Mode	Side	Test Position	Figure No.	Conducted Power (dBm)	Max. tune-up Power (dBm)	Measured SAR(10g) (W/kg)	Reported SAR(10g) (W/kg)	Measured SAR(1g) (W/kg)	Reported SAR(1g) (W/kg)	Power Drift (dB)
Ch.	MHz											
21350	2560	1RB_Mid	Left	Touch	Fig.14	23.43	24.00	0.030	<b>0.03</b>	0.057	<b>0.06</b>	-0.04
21350	2560	1RB_Mid	Left	Tilt	/	23.43	24.00	0.019	<b>0.02</b>	0.035	<b>0.04</b>	0.07
21350	2560	1RB_Mid	Right	Touch	/	23.43	24.00	0.020	<b>0.02</b>	0.036	<b>0.04</b>	-0.03
21350	2560	1RB_Mid	Right	Tilt	/	23.43	24.00	0.013	<b>0.01</b>	0.022	<b>0.03</b>	-0.10
21350	2560	50RB_Mid	Left	Touch	/	22.29	23.00	0.025	<b>0.03</b>	0.048	<b>0.06</b>	0.08
21350	2560	50RB_Mid	Left	Tilt	/	22.29	23.00	0.015	<b>0.02</b>	0.029	<b>0.03</b>	-0.05
21350	2560	50RB_Mid	Right	Touch	/	22.29	23.00	0.015	<b>0.02</b>	0.027	<b>0.03</b>	0.01
21350	2560	50RB_Mid	Right	Tilt	/	22.29	23.00	0.010	<b>0.01</b>	0.018	<b>0.02</b>	0.02

Note1: The LTE mode is QPSK\_20MHz.

**Table 14.1-15: SAR Values (LTE Band7 - Body)**

Frequency		Mode	Test Position	Figure No.	Conduct ed Power (dBm)	Max. tune-up Power (dBm)	Measured SAR(10g) (W/kg)	Reported SAR(10g) (W/kg)	Measured SAR(1g) (W/kg)	Reported SAR(1g) (W/kg)	Power Drift (dB)	
Ch.	MHz											
		Ambient Temperature: 22.9 °C						Liquid Temperature: 22.5 °C				
21350	2560	1RB_Mid	Front	/	23.43	24.00	0.261	<b>0.30</b>	0.513	<b>0.58</b>	0.08	
21350	2560	1RB_Mid	Rear	Fig.15	23.43	24.00	0.481	<b>0.55</b>	1.03	<b>1.17</b>	-0.02	
21100	2535	1RB_Mid	Rear	/	23.38	24.00	0.379	<b>0.44</b>	0.853	<b>0.98</b>	-0.03	
20850	2510	1RB_Mid	Rear	/	23.27	24.00	0.302	<b>0.36</b>	0.668	<b>0.79</b>	0.01	
21350	2560	1RB_Mid	Left	/	23.43	24.00	0.086	<b>0.10</b>	0.161	<b>0.18</b>	0.06	
21350	2560	1RB_Mid	Right	/	23.43	24.00	0.071	<b>0.08</b>	0.138	<b>0.16</b>	-0.05	
21350	2560	1RB_Mid	Bottom	/	23.43	24.00	0.431	<b>0.49</b>	0.861	<b>0.98</b>	0.08	
21100	2535	1RB_Mid	Bottom	/	23.38	24.00	0.365	<b>0.42</b>	0.824	<b>0.95</b>	0.13	
20850	2510	1RB_Mid	Bottom	/	23.27	24.00	0.297	<b>0.35</b>	0.811	<b>0.96</b>	-0.08	
21350	2560	50RB_Mid	Front	/	22.29	23.00	0.202	<b>0.24</b>	0.398	<b>0.47</b>	-0.07	
21350	2560	50RB_Mid	Rear	/	22.29	23.00	0.375	<b>0.44</b>	0.803	<b>0.94</b>	0.03	
21100	2535	50RB_Mid	Rear	/	22.27	23.00	0.362	<b>0.43</b>	0.788	<b>0.93</b>	0.08	
20850	2510	50RB_High	Rear	/	22.19	23.00	0.323	<b>0.39</b>	0.751	<b>0.90</b>	-0.04	
21350	2560	50RB_Mid	Left	/	22.29	23.00	0.067	<b>0.08</b>	0.123	<b>0.14</b>	0.12	
21350	2560	50RB_Mid	Right	/	22.29	23.00	0.055	<b>0.06</b>	0.108	<b>0.13</b>	-0.04	
21350	2560	50RB_Mid	Bottom	/	22.29	23.00	0.332	<b>0.39</b>	0.665	<b>0.78</b>	0.05	
21100	2535	100RB	Rear	/	22.28	23.00	0.296	<b>0.35</b>	0.668	<b>0.79</b>	-0.10	
21100	2535	100RB	Bottom	/	22.28	23.00	0.275	<b>0.32</b>	0.648	<b>0.77</b>	0.04	

Note1: The distance between the EUT and the phantom bottom is 10mm.

Note2: The LTE mode is QPSK\_20MHz.

**Table 14.1-16: SAR Values (LTE Band12- Head)**

Frequency		Mode	Side	Test Position	Figure No.	Conduct ed Power (dBm)	Max. tune-up Power (dBm)	Measured SAR(10g) (W/kg)	Reported SAR(10g) (W/kg)	Measured SAR(1g) (W/kg)	Reported SAR(1g) (W/kg)	Powe r Drift (dB)
Ch.	MHz											
		Ambient Temperature: 22.9 °C						Liquid Temperature: 22.5 °C				
23130	711	1RB_Mid	Left	Touch	/	22.98	24.00	0.386	<b>0.49</b>	0.561	<b>0.71</b>	-0.08
23131	711	1RB_Mid	Left	Tilt	Fig.16	22.98	24.00	0.381	<b>0.48</b>	0.580	<b>0.73</b>	0.07
23134	711	1RB_Mid	Right	Touch	/	22.98	24.00	0.313	<b>0.40</b>	0.437	<b>0.55</b>	-0.09
23135	711	1RB_Mid	Right	Tilt	/	22.98	24.00	0.328	<b>0.41</b>	0.543	<b>0.69</b>	-0.07
23095	707.5	25RB_High	Left	Touch	/	21.88	23.00	0.287	<b>0.37</b>	0.418	<b>0.54</b>	-0.02
23095	707.5	25RB_High	Left	Tilt	/	21.88	23.00	0.288	<b>0.37</b>	0.436	<b>0.56</b>	0.12
23095	707.5	25RB_High	Right	Touch	/	21.88	23.00	0.229	<b>0.30</b>	0.318	<b>0.41</b>	-0.04
23095	707.5	25RB_High	Right	Tilt	/	21.88	23.00	0.237	<b>0.31</b>	0.390	<b>0.50</b>	0.10

Note1: The LTE mode is QPSK\_10MHz.



**Table 14.1-17: SAR Values (LTE Band12 - Body)**

Frequency		Mode	Test Position	Figure No.	Conducted Power (dBm)	Max. tune-up Power (dBm)	Measured SAR(10g) (W/kg)	Reported SAR(10g) (W/kg)	Measured SAR(1g) (W/kg)	Reported SAR(1g) (W/kg)	Power Drift (dB)
Ch.	MHz										
23130	711	1RB_Mid	Front	/	22.98	24.00	0.162	<b>0.20</b>	0.258	<b>0.33</b>	0.00
23130	711	1RB_Mid	Rear	Fig.17	22.98	24.00	0.175	<b>0.22</b>	0.275	<b>0.35</b>	-0.01
23130	711	1RB_Mid	Left	/	22.98	24.00	0.125	<b>0.16</b>	0.177	<b>0.22</b>	-0.13
23130	711	1RB_Mid	Right	/	22.98	24.00	0.084	<b>0.11</b>	0.114	<b>0.14</b>	0.01
23130	711	1RB_Mid	Top	/	22.98	24.00	0.087	<b>0.11</b>	0.145	<b>0.18</b>	-0.12
23095	707.5	25RB_High	Front	/	21.88	23.00	0.135	<b>0.17</b>	0.189	<b>0.24</b>	0.06
23095	707.5	25RB_High	Rear	/	21.88	23.00	0.134	<b>0.17</b>	0.211	<b>0.27</b>	0.05
23095	707.5	25RB_High	Left	/	21.88	23.00	0.088	<b>0.11</b>	0.127	<b>0.16</b>	0.03
23095	707.5	25RB_High	Right	/	21.88	23.00	0.062	<b>0.08</b>	0.086	<b>0.11</b>	-0.01
23095	707.5	25RB_High	Top	/	21.88	23.00	0.074	<b>0.10</b>	0.108	<b>0.14</b>	0.07

Note1: The distance between the EUT and the phantom bottom is 10mm.

Note2: The LTE mode is QPSK\_10MHz.

**Table 14.1-18: SAR Values (LTE Band13 - Head)**

Frequency		Mode	Side	Test Position	Figure No.	Conducted Power (dBm)	Max. tune-up Power (dBm)	Measured SAR(10g) (W/kg)	Reported SAR(10g) (W/kg)	Measured SAR(1g) (W/kg)	Reported SAR(1g) (W/kg)	Power Drift (dB)
Ch.	MHz											
23230	782	1RB_Mid	Left	Touch	Fig.18	22.98	24.00	0.052	<b>0.07</b>	0.067	<b>0.08</b>	0.09
23230	782	1RB_Mid	Left	Tilt	/	22.98	24.00	0.036	<b>0.05</b>	0.046	<b>0.06</b>	-0.03
23230	782	1RB_Mid	Right	Touch	/	22.98	24.00	0.051	<b>0.06</b>	0.059	<b>0.07</b>	-0.05
23230	782	1RB_Mid	Right	Tilt	/	22.98	24.00	0.033	<b>0.04</b>	0.041	<b>0.05</b>	0.04
23230	782	25RB_Mid	Left	Touch	/	21.92	23.00	0.040	<b>0.05</b>	0.051	<b>0.07</b>	0.05
23230	782	25RB_Mid	Left	Tilt	/	21.92	23.00	0.028	<b>0.04</b>	0.037	<b>0.05</b>	-0.07
23230	782	25RB_Mid	Right	Touch	/	21.92	23.00	0.039	<b>0.05</b>	0.050	<b>0.06</b>	-0.03
23230	782	25RB_Mid	Right	Tilt	/	21.92	23.00	0.025	<b>0.03</b>	0.033	<b>0.04</b>	0.09

Note1: The LTE mode is QPSK\_10MHz.

**Table 14.1-19: SAR Values (LTE Band13 - Body)**

Ambient Temperature: 22.9 °C						Liquid Temperature: 22.5 °C					
Frequency		Mode	Test Position	Figure No.	Conducted Power (dBm)	Max. tune-up Power (dBm)	Measured SAR(10g) (W/kg)	Reported SAR(10g) (W/kg)	Measured SAR(1g) (W/kg)	Reported SAR(1g) (W/kg)	Power Drift (dB)
Ch.	MHz										
23230	782	1RB_Mid	Front	/	22.98	24.00	0.079	<b>0.10</b>	0.133	<b>0.17</b>	-0.01
23231	782	1RB_Mid	Rear	Fig.19	22.98	24.00	0.122	<b>0.15</b>	0.209	<b>0.26</b>	-0.02
23232	782	1RB_Mid	Left	/	22.98	24.00	0.034	<b>0.04</b>	0.054	<b>0.07</b>	0.10
23233	782	1RB_Mid	Right	/	22.98	24.00	0.045	<b>0.06</b>	0.068	<b>0.09</b>	0.00
23234	782	1RB_Mid	Bottom	/	22.98	24.00	0.042	<b>0.05</b>	0.072	<b>0.09</b>	0.10
23235	782	25RB_Mid	Front	/	21.92	23.00	0.061	<b>0.08</b>	0.101	<b>0.13</b>	0.03
23236	782	25RB_Mid	Rear	/	21.92	23.00	0.093	<b>0.12</b>	0.160	<b>0.21</b>	-0.03
23237	782	25RB_Mid	Left	/	21.92	23.00	0.027	<b>0.03</b>	0.043	<b>0.06</b>	-0.08
23238	782	25RB_Mid	Right	/	21.92	23.00	0.035	<b>0.04</b>	0.053	<b>0.07</b>	-0.08
23239	782	25RB_Mid	Bottom	/	21.92	23.00	0.032	<b>0.04</b>	0.056	<b>0.07</b>	-0.11

Note1: The distance between the EUT and the phantom bottom is 10mm.

Note2: The LTE mode is QPSK\_10MHz.

**Table 14.1-20: SAR Values (LTE Band25 - Head)**

Ambient Temperature: 22.9 °C						Liquid Temperature: 22.5 °C						
Frequency		Mode	Side	Test Position	Figure No.	Conduct ed Power (dBm)	Max. tune-up Power (dBm)	Measured SAR(10g) (W/kg)	Reported SAR(10g) (W/kg)	Measured SAR(1g) (W/kg)	Reported SAR(1g) (W/kg)	Power Drift (dB)
Ch.	MHz											
26590	1905	1RB_Mid	Left	Touch	Fig.20	23.53	24.00	0.188	<b>0.21</b>	0.307	<b>0.34</b>	0.06
26590	1905	1RB_Mid	Left	Tilt	/	23.53	24.00	0.107	<b>0.12</b>	0.173	<b>0.19</b>	-0.10
26590	1905	1RB_Mid	Right	Touch	/	23.53	24.00	0.133	<b>0.15</b>	0.205	<b>0.23</b>	-0.10
26590	1905	1RB_Mid	Right	Tilt	/	23.53	24.00	0.119	<b>0.13</b>	0.184	<b>0.21</b>	-0.10
26590	1905	50RB-Low	Left	Touch	/	22.39	23.00	0.159	<b>0.18</b>	0.257	<b>0.30</b>	0.04
26590	1905	50RB-Low	Left	Tilt	/	22.39	23.00	0.088	<b>0.10</b>	0.143	<b>0.16</b>	0.01
26590	1905	50RB-Low	Right	Touch	/	22.39	23.00	0.112	<b>0.13</b>	0.173	<b>0.20</b>	-0.08
26590	1905	50RB-Low	Right	Tilt	/	22.39	23.00	0.099	<b>0.11</b>	0.152	<b>0.17</b>	0.03

Note1: The LTE mode is QPSK\_20MHz.

**Table 14.1-21: SAR Values (LTE Band25 - Body)**

Ambient Temperature: 22.9 °C					Liquid Temperature: 22.5 °C						
Frequency		Mode	Test Position	Figure No.	Conducted Power (dBm)	Max. tune-up Power (dBm)	Measured SAR(10g) (W/kg)	Reported SAR(10g) (W/kg)	Measured SAR(1g) (W/kg)	Reported SAR(1g) (W/kg)	Power Drift (dB)
Ch.	MHz										
26140	1860	1RB_Mid	Front	/	22.58	23	0.349	<b>0.38</b>	0.588	<b>0.65</b>	0.09
26140	1860	1RB_Mid	Rear	/	22.58	23	0.309	<b>0.34</b>	0.488	<b>0.54</b>	0.08
26140	1860	1RB_Mid	Left	/	22.58	23	0.122	<b>0.13</b>	0.201	<b>0.22</b>	0.05
26140	1860	1RB_Mid	Right	/	22.58	23	0.061	<b>0.07</b>	0.103	<b>0.11</b>	0.05
26590	1905	1RB_Mid	Bottom	/	22.44	23	0.374	<b>0.43</b>	0.705	<b>0.80</b>	-0.09
26365	1882.5	1RB_Mid	Bottom	/	22.46	23	0.423	<b>0.48</b>	0.798	<b>0.90</b>	0.11
26140	1860	1RB_Mid	Bottom	Fig.21	22.58	23	0.501	<b>0.55</b>	0.939	<b>1.03</b>	0.00
26590	1905	50RB-Low	Front	/	22.42	23	0.291	<b>0.33</b>	0.489	<b>0.56</b>	0.06
26590	1905	50RB-Low	Rear	/	22.42	23	0.255	<b>0.29</b>	0.406	<b>0.46</b>	-0.09
26590	1905	50RB-Low	Left	/	22.42	23	0.100	<b>0.11</b>	0.164	<b>0.19</b>	0.06
26590	1905	50RB-Low	Right	/	22.42	23	0.050	<b>0.06</b>	0.085	<b>0.10</b>	0.04
26590	1905	50RB-Low	Bottom	/	22.42	23	0.295	<b>0.34</b>	0.585	<b>0.67</b>	0.03
26590	1905	100RB	Bottom	/	22.36	23	0.297	<b>0.34</b>	0.561	<b>0.65</b>	-0.08
26140	1860	1RB_Mid	Bottom	Note3	22.58	23	1.42	<b>1.56</b>	3.28	<b>3.61</b>	0.03

Note1: The distance between the EUT and the phantom bottom is 10mm.

Note2: The LTE mode is QPSK\_20MHz

Note3: The distance between the EUT and the phantom bottom is 0mm Base on the Principle of adding Test for Phablet.

**Table 14.1-22: SAR Values (LTE Band25 - Body)**

Ambient Temperature: 22.9 °C					Liquid Temperature: 22.5 °C						
Frequency		Mode	Test Position	Figure No.	Conducted Power (dBm)	Max. tune-up Power (dBm)	Measured SAR(10g) (W/kg)	Reported SAR(10g) (W/kg)	Measured SAR(1g) (W/kg)	Reported SAR(1g) (W/kg)	Power Drift (dB)
Ch.	MHz										
26590	1905	1RB_Mid	Front	Fig.22	23.53	24.00	0.310	<b>0.35</b>	0.507	<b>0.57</b>	0.00
26590	1905	1RB_Mid	Rear	/	23.53	24.00	0.298	<b>0.33</b>	0.475	<b>0.53</b>	0.10
26590	1905	50RB-Low	Front	/	22.39	23.00	0.255	<b>0.29</b>	0.417	<b>0.48</b>	-0.03
26590	1905	50RB-Low	Rear	/	22.39	23.00	0.248	<b>0.29</b>	0.395	<b>0.45</b>	-0.03

Note1: The distance between the EUT and the phantom bottom is 15mm.

Note2: The LTE mode is QPSK\_20MHz

**Table 14.1-23: SAR Values (LTE Band26 - Head)**

Ambient Temperature: 22.9 °C						Liquid Temperature: 22.5°C						
Frequency		Mode	Side	Test Position	Figure No.	Conducted Power (dBm)	Max. tune-up Power (dBm)	Measured SAR(10g) (W/kg)	Reported SAR(10g)(W/kg)	Measured SAR(1g) (W/kg)	Reported SAR(1g) (W/kg)	Power Drift (dB)
Ch.	MHz											
26965	841.5	1RB_Mid	Left	Touch	Fig.23	22.99	24.00	0.091	<b>0.11</b>	0.120	<b>0.15</b>	0.01
26965	841.5	1RB_Mid	Left	Tilt	/	22.99	24.00	0.058	<b>0.07</b>	0.073	<b>0.09</b>	-0.08
26965	841.5	1RB_Mid	Right	Touch	/	22.99	24.00	0.059	<b>0.07</b>	0.079	<b>0.10</b>	0.05
26965	841.5	1RB_Mid	Right	Tilt	/	22.99	24.00	0.035	<b>0.04</b>	0.044	<b>0.06</b>	0.06
26865	831.5	36RB_Mid	Left	Touch	/	22.03	23.00	0.062	<b>0.08</b>	0.082	<b>0.10</b>	-0.05
26865	831.5	36RB_Mid	Left	Tilt	/	22.03	23.00	0.035	<b>0.04</b>	0.046	<b>0.06</b>	0.03
26865	831.5	36RB_Mid	Right	Touch	/	22.03	23.00	0.055	<b>0.07</b>	0.071	<b>0.09</b>	0.02
26865	831.5	36RB_Mid	Right	Tilt	/	22.03	23.00	0.032	<b>0.04</b>	0.040	<b>0.05</b>	-0.07

Note1: The LTE mode is QPSK\_15MHz.

**Table 14.1-24: SAR Values (LTE Band26 - Body)**

Ambient Temperature: 22.9 °C						Liquid Temperature: 22.5°C					
Frequency		Mode	Test Position	Figure No.	Conducted Power (dBm)	Max. tune-up Power (dBm)	Measured SAR(10g) (W/kg)	Reported SAR(10g) (W/kg)	Measured SAR(1g) (W/kg)	Reported SAR(1g) (W/kg)	Power Drift (dB)
Ch.	MHz										
26965	841.5	1RB_Mid	Front	/	22.99	24.00	0.128	<b>0.16</b>	0.210	<b>0.26</b>	0.11
26965	841.5	1RB_Mid	Rear	Fig.24	22.99	24.00	0.170	<b>0.21</b>	0.283	<b>0.36</b>	-0.05
26965	841.5	1RB_Mid	Left	/	22.99	24.00	0.057	<b>0.07</b>	0.087	<b>0.11</b>	-0.10
26965	841.5	1RB_Mid	Right	/	22.99	24.00	0.050	<b>0.06</b>	0.078	<b>0.10</b>	-0.09
26965	841.5	1RB_Mid	Bottom	/	22.99	24.00	0.064	<b>0.08</b>	0.129	<b>0.16</b>	0.01
26865	831.5	36RB_Mid	Front	/	22.03	23.00	0.107	<b>0.13</b>	0.177	<b>0.22</b>	-0.11
26865	831.5	36RB_Mid	Rear	/	22.03	23.00	0.141	<b>0.18</b>	0.235	<b>0.29</b>	-0.11
26865	831.5	36RB_Mid	Left	/	22.03	23.00	0.050	<b>0.06</b>	0.078	<b>0.10</b>	-0.05
26865	831.5	36RB_Mid	Right	/	22.03	23.00	0.043	<b>0.05</b>	0.064	<b>0.08</b>	-0.08
26865	831.5	36RB_Mid	Bottom	/	22.03	23.00	0.048	<b>0.06</b>	0.097	<b>0.12</b>	0.04

Note1: The distance between the EUT and the phantom bottom is 10mm.

Note2: The LTE mode is QPSK\_15MHz.

**Table 14.1-25: SAR Values (LTE Band41 PC2 - Head)**

Frequency		Mode	Side	Test Position	Figure No.	Conducted Power (dBm)	tune-up Power (dBm)	Measured SAR(10g) (W/kg)	Reported SAR(10g) (W/kg)	Measured SAR(1g) (W/kg)	Reported SAR(1g) (W/kg)	Power Drift (dB)
Ch.	MHz											
40620	2593	1RB_Mid	Left	Touch	/	26.63	27.00	0.018	<b>0.02</b>	0.033	<b>0.04</b>	-0.06
40620	2593	1RB_Mid	Left	Tilt	/	26.63	27.00	0.017	<b>0.02</b>	0.030	<b>0.03</b>	-0.04
40620	2593	1RB_Mid	Right	Touch	Fig.25	26.63	27.00	0.020	<b>0.02</b>	0.034	<b>0.04</b>	0.00
40620	2593	1RB_Mid	Right	Tilt	/	26.63	27.00	0.016	<b>0.02</b>	0.025	<b>0.03</b>	0.06
40620	2593	50RB_Mid	Left	Touch	/	25.45	26.00	0.014	<b>0.02</b>	0.025	<b>0.03</b>	-0.06
40620	2593	50RB_Mid	Left	Tilt	/	25.45	26.00	0.012	<b>0.01</b>	0.022	<b>0.02</b>	0.11
40620	2593	50RB_Mid	Right	Touch	/	25.45	26.00	0.016	<b>0.02</b>	0.026	<b>0.03</b>	-0.07
40620	2593	50RB_Mid	Right	Tilt	/	25.45	26.00	0.014	<b>0.02</b>	0.019	<b>0.02</b>	-0.10

Note1: The LTE mode is QPSK\_20MHz.

**Table 14.1-26: SAR Values (LTE Band41 PC2 - Body)**

Frequency		Mode	Test Position	Figure No.	Conducted Power (dBm)	tune-up Power (dBm)	Measured SAR(10g) (W/kg)	Reported SAR(10g) (W/kg)	Measured SAR(1g) (W/kg)	Reported SAR(1g) (W/kg)	Power Drift (dB)
Ch.	MHz										
40620	2593	1RB_Mid	Front	/	26.63	27.00	0.209	<b>0.23</b>	0.423	<b>0.46</b>	-0.01
41490	2680	1RB_Mid	Rear	Fig.26	26.23	27.00	0.506	<b>0.60</b>	1.12	<b>1.34</b>	0.03
41055	2636.5	1RB_Mid	Rear	/	26.49	27.00	0.379	<b>0.43</b>	0.896	<b>1.01</b>	0.10
40620	2593	1RB_Mid	Rear	/	26.63	27.00	0.323	<b>0.35</b>	0.758	<b>0.83</b>	-0.02
40185	2549.5	1RB_Mid	Rear	/	26.61	27.00	0.252	<b>0.28</b>	0.564	<b>0.62</b>	0.00
39750	2506	1RB_Mid	Rear	/	26.45	27.00	0.189	<b>0.21</b>	0.419	<b>0.48</b>	0.12
40620	2593	1RB_Mid	Left	/	26.63	27.00	0.035	<b>0.04</b>	0.065	<b>0.07</b>	0.05
40620	2593	1RB_Mid	Right	/	26.63	27.00	0.043	<b>0.05</b>	0.080	<b>0.09</b>	0.09
40620	2593	1RB_Mid	Bottom	/	26.63	27.00	0.278	<b>0.30</b>	0.583	<b>0.64</b>	0.00
40620	2593	50RB_Mid	Front	/	25.45	26.00	0.164	<b>0.19</b>	0.332	<b>0.38</b>	0.00
40620	2593	50RB_Mid	Rear	/	25.45	26.00	0.250	<b>0.28</b>	0.587	<b>0.67</b>	0.09
40620	2593	50RB_Mid	Left	/	25.45	26.00	0.027	<b>0.03</b>	0.052	<b>0.06</b>	-0.07
40620	2593	50RB_Mid	Right	/	25.45	26.00	0.035	<b>0.04</b>	0.063	<b>0.07</b>	0.12
40620	2593	50RB_Mid	Bottom	/	25.45	26.00	0.215	<b>0.24</b>	0.453	<b>0.51</b>	-0.11
40620	2593	100RB	Bottom	/	25.41	26.00	0.248	<b>0.28</b>	0.569	<b>0.65</b>	-0.02
41490	2680	1RB_Mid	Rear	Note3	26.23	27.00	2.80	<b>3.34</b>	7.80	<b>9.31</b>	-0.05
41490	2680	1RB_Mid	Rear	Headset	26.23	27.00	0.485	<b>0.58</b>	0.994	<b>1.19</b>	0.06

Note1: The distance between the EUT and the phantom bottom is 10mm.

Note2: The LTE mode is QPSK\_20MHz.

Note3: The distance between the EUT and the phantom bottom is 0mm Base on the Principle of adding Test for Phablet.

**Table 14.1-27: SAR Values (LTE Band41 PC3 - Head)**

Ambient Temperature: 22.9 °C						Liquid Temperature: 22.5 °C						
Frequency		Mode	Side	Test Position	Figure No.	Conduct ed Power (dBm)	tune-up Power (dBm)	Measured SAR(10g) (W/kg)	Reported SAR(10g) (W/kg)	Measured SAR(1g) (W/kg)	Reported SAR(1g) (W/kg)	Power Drift (dB)
Ch.	MHz											
40620	2593	1RB_Mid	Left	Touch	Fig.27	23.57	24.00	0.009	<b>0.01</b>	0.019	<b>0.02</b>	0.00
40620	2593	1RB_Mid	Left	Tilt	/	23.57	24.00	0.007	<b>0.01</b>	0.015	<b>0.02</b>	0.05
40620	2593	1RB_Mid	Right	Touch	/	23.57	24.00	0.008	<b>0.01</b>	0.015	<b>0.02</b>	0.08
40620	2593	1RB_Mid	Right	Tilt	/	23.57	24.00	0.007	<b>0.01</b>	0.014	<b>0.02</b>	0.05
40620	2593	50RB_Mid	Left	Touch	/	22.45	23.00	0.006	<b>0.01</b>	0.013	<b>0.01</b>	0.02
40620	2593	50RB_Mid	Left	Tilt	/	22.45	23.00	0.005	<b>0.01</b>	0.011	<b>0.01</b>	-0.02
40620	2593	50RB_Mid	Right	Touch	/	22.45	23.00	0.006	<b>0.01</b>	0.013	<b>0.01</b>	0.12
40620	2593	50RB_Mid	Right	Tilt	/	22.45	23.00	0.005	<b>0.01</b>	0.011	<b>0.01</b>	-0.11

Note1: The LTE mode is QPSK\_20MHz.

**Table 14.1-28: SAR Values (LTE Band41 PC3 - Body)**

Ambient Temperature: 22.9 °C						Liquid Temperature: 22.5 °C					
Frequency		Mode	Test Position	Figure No.	Conduct ed Power (dBm)	tune-up Power (dBm)	Measured SAR(10g) (W/kg)	Reported SAR(10g) (W/kg)	Measured SAR(1g) (W/kg)	Reported SAR(1g) (W/kg)	Power Drift (dB)
Ch.	MHz										
40620	2593	1RB_Mid	Front	/	23.57	24.00	0.200	<b>0.22</b>	0.361	<b>0.40</b>	0.12
40620	2593	1RB_Mid	Rear	Fig.28	23.57	24.00	0.309	<b>0.34</b>	0.647	<b>0.71</b>	-0.08
40620	2593	1RB_Mid	Left	/	23.57	24.00	0.033	<b>0.04</b>	0.056	<b>0.06</b>	0.06
40620	2593	1RB_Mid	Right	/	23.57	24.00	0.042	<b>0.05</b>	0.069	<b>0.08</b>	0.12
40620	2593	1RB_Mid	Bottom	/	23.57	24.00	0.266	<b>0.29</b>	0.498	<b>0.55</b>	-0.02
40620	2593	50RB_Mid	Front	/	22.45	23.00	0.156	<b>0.18</b>	0.283	<b>0.32</b>	-0.04
40620	2593	50RB_Mid	Rear	/	22.45	23.00	0.239	<b>0.27</b>	0.501	<b>0.57</b>	0.06
40620	2593	50RB_Mid	Left	/	22.45	23.00	0.026	<b>0.03</b>	0.045	<b>0.05</b>	0.10
40620	2593	50RB_Mid	Right	/	22.45	23.00	0.033	<b>0.04</b>	0.054	<b>0.06</b>	0.10
40620	2593	50RB_Mid	Bottom	/	22.45	23.00	0.206	<b>0.23</b>	0.387	<b>0.44</b>	-0.09

Note1: The distance between the EUT and the phantom bottom is 10mm.

Note2: The LTE mode is QPSK\_20MHz.

**Table 14.1-29: SAR Values (LTE Band66 - Head)**

Frequency		Mode	Side	Test Position	Figure No.	Conduct ed Power (dBm)	tune-up Power (dBm)	Measured SAR(10g) (W/kg)	Reported SAR(10g) (W/kg)	Measured SAR(1g) (W/kg)	Reported SAR(1g) (W/kg)	Power Drift (dB)
Ch.	MHz											
132572	1770	1RB_Mid	Left	Touch	/	23.27	24.00	0.067	<b>0.08</b>	0.116	<b>0.14</b>	-0.11
132572	1770	1RB_Mid	Left	Tilt	/	23.27	24.00	0.081	<b>0.10</b>	0.135	<b>0.16</b>	-0.02
132572	1770	1RB_Mid	Right	Touch	Fig.29	23.27	24.00	0.090	<b>0.11</b>	0.147	<b>0.17</b>	-0.05
132572	1770	1RB_Mid	Right	Tilt	/	23.27	24.00	0.075	<b>0.09</b>	0.131	<b>0.15</b>	0.10
132572	1770	50RB_Low	Left	Touch	/	22.13	23.00	0.049	<b>0.06</b>	0.086	<b>0.11</b>	-0.05
132572	1770	50RB_Low	Left	Tilt	/	22.13	23.00	0.063	<b>0.08</b>	0.105	<b>0.13</b>	-0.04
132572	1770	50RB_Low	Right	Touch	/	22.13	23.00	0.074	<b>0.09</b>	0.123	<b>0.15</b>	0.10
132572	1770	50RB_Low	Right	Tilt	/	22.13	23.00	0.065	<b>0.08</b>	0.112	<b>0.14</b>	-0.02

Note1: The LTE mode is QPSK\_20MHz.

**Table 14.1-30: SAR Values (LTE Band66 - Body)**

Frequency		Mode	Test Position	Figure No.	Conduct ed Power (dBm)	tune-up Power (dBm)	Measured SAR(10g) (W/kg)	Reported SAR(10g) (W/kg)	Measured SAR(1g) (W/kg)	Reported SAR(1g) (W/kg)	Power Drift (dB)
Ch.	MHz										
132572	1770	1RB_Mid	Front	/	19.30	20	0.245	<b>0.29</b>	0.405	<b>0.48</b>	0.05
132572	1770	1RB_Mid	Rear	/	19.30	20	0.363	<b>0.43</b>	0.664	<b>0.78</b>	-0.16
132572	1770	1RB_Mid	Left	/	19.30	20	0.051	<b>0.06</b>	0.082	<b>0.10</b>	0.07
132572	1770	1RB_Mid	Right	/	19.30	20	0.035	<b>0.04</b>	0.058	<b>0.07</b>	-0.10
132572	1770	1RB_Mid	Bottom	/	19.30	20	0.425	<b>0.50</b>	0.772	<b>0.91</b>	0.03
132322	1745	1RB_Mid	Bottom	/	19.24	20	0.337	<b>0.40</b>	0.639	<b>0.76</b>	0.07
132072	1720	1RB_Mid	Bottom	/	19.25	20	0.551	<b>0.65</b>	0.995	<b>1.18</b>	0.02
132572	1770	50RB_Low	Front	/	19.22	20	0.245	<b>0.29</b>	0.409	<b>0.49</b>	-0.09
132572	1770	50RB_Low	Rear	/	19.22	20	0.416	<b>0.50</b>	0.818	<b>0.98</b>	-0.10
132322	1745	50RB_Low	Rear	/	19.11	20	0.387	<b>0.47</b>	0.720	<b>0.88</b>	0.03
132072	1720	50RB_High	Rear	/	19.04	20	0.551	<b>0.69</b>	1.05	<b>1.31</b>	-0.09
132572	1770	50RB_Low	Left	/	19.22	20	0.048	<b>0.06</b>	0.076	<b>0.09</b>	0.10
132572	1770	50RB_Low	Right	/	19.22	20	0.034	<b>0.04</b>	0.055	<b>0.07</b>	0.04
132572	1770	50RB_Low	Bottom	/	19.22	20	0.437	<b>0.52</b>	0.799	<b>0.96</b>	-0.08
132322	1745	50RB_Low	Bottom	/	19.11	20	0.352	<b>0.43</b>	0.664	<b>0.81</b>	0.13
132072	1720	50RB_High	Bottom	Fig.30	19.04	20	0.594	<b>0.74</b>	1.08	<b>1.35</b>	0.08
132572	1770	100RB	Rear	/	19.16	20	0.411	<b>0.50</b>	0.772	<b>0.94</b>	-0.09
132572	1770	100RB	Bottom	/	19.16	20	0.407	<b>0.49</b>	0.756	<b>0.92</b>	-0.01
132072	1720	50RB_High	Bottom	Note3	19.04	20	0.922	<b>1.15</b>	1.99	<b>2.48</b>	0.08
132072	1720	50RB_High	Bottom	Headset	19.04	20	0.517	<b>0.65</b>	0.977	<b>1.22</b>	0.15

Note1: The distance between the EUT and the phantom bottom is 10mm.

Note2: The LTE mode is QPSK\_20MHz

Note3: The distance between the EUT and the phantom bottom is 0mm Base on the Principle of adding Test for

Phablet.

**Table 14.1-31: SAR Values (LTE Band66 - Body)**

Frequency		Mode	Test Position	Figure No.	Conducted Power (dBm)	tune-up Power (dBm)	Measured SAR(10g) (W/kg)	Reported SAR(10g) (W/kg)	Measured SAR(1g) (W/kg)	Reported SAR(1g) (W/kg)	Power Drift (dB)
Ch.	MHz										
Ambient Temperature: 22.9 °C      Liquid Temperature: 22.5 °C											
132572	1770	1RB_Mid	Front	/	23.27	24.00	0.389	<b>0.46</b>	0.593	<b>0.70</b>	-0.10
132572	1770	1RB_Mid	Rear	/	23.27	24.00	0.524	<b>0.62</b>	0.878	<b>1.04</b>	-0.12
132322	1745	1RB_Mid	Rear	/	23.26	24.00	0.556	<b>0.66</b>	0.956	<b>1.13</b>	-0.12
132072	1720	1RB_Mid	Rear	Fig.31	23.24	24.00	0.667	<b>0.79</b>	1.15	<b>1.37</b>	0.08
132572	1770	50RB_Low	Front	/	22.13	23.00	0.302	<b>0.37</b>	0.465	<b>0.57</b>	0.01
132572	1770	50RB_Low	Rear	/	22.13	23.00	0.429	<b>0.52</b>	0.720	<b>0.88</b>	0.04
132572	1770	100RB	Rear	/	22.09	23.00	0.391	<b>0.48</b>	0.653	<b>0.81</b>	-0.05
132072	1720	1RB_Mid	Rear	Headset	23.24	24.00	0.618	<b>0.74</b>	0.993	<b>1.18</b>	-0.18

Note1: The distance between the EUT and the phantom bottom is 15mm.

Note2: The LTE mode is QPSK\_20MHz

**Table 14.1-32: SAR Values (LTE Band71 - Head)**

Frequency		Mode	Side	Test Position	Figure No.	Conducted Power (dBm)	tune-up Power (dBm)	Measured SAR(10g) (W/kg)	Reported SAR(10g) (W/kg)	Measured SAR(1g) (W/kg)	Reported SAR(1g) (W/kg)	Power Drift (dB)
Ch.	MHz											
Ambient Temperature: 22.9 °C      Liquid Temperature: 22.5 °C												
133322	683	1RB_Mid	Left	Touch	Fig.32	22.93	24.00	0.290	<b>0.37</b>	0.426	<b>0.54</b>	0.02
133322	683	1RB_Mid	Left	Tilt	/	22.93	24.00	0.196	<b>0.25</b>	0.340	<b>0.43</b>	-0.09
133372	688	1RB_Mid	Right	Touch	/	22.93	24.00	0.254	<b>0.32</b>	0.377	<b>0.48</b>	-0.06
133322	683	1RB_Mid	Right	Tilt	/	22.93	24.00	0.246	<b>0.31</b>	0.389	<b>0.50</b>	0.08
133322	683	50RB_Low	Left	Touch	/	21.91	23.00	0.229	<b>0.29</b>	0.331	<b>0.43</b>	-0.03
133322	683	50RB_Low	Left	Tilt	/	21.91	23.00	0.161	<b>0.21</b>	0.281	<b>0.36</b>	0.12
133322	683	50RB_Low	Right	Touch	/	21.91	23.00	0.202	<b>0.26</b>	0.299	<b>0.38</b>	-0.01
133322	683	50RB_Low	Right	Tilt	/	21.91	23.00	0.197	<b>0.25</b>	0.367	<b>0.47</b>	0.08

Note1: The LTE mode is QPSK\_20MHz.



**Table 14.1-33: SAR Values (LTE Band71 - Body)**

Frequency		Mode	Test Position	Figure No.	Ambient Temperature: 22.9°C		Liquid Temperature: 22.5°C		Measured SAR(1g) (W/kg)	Reported SAR(1g) (W/kg)	Power Drift (dB)
Ch.	MHz				Conduct ed Power (dBm)	tune-up Power (dBm)	Measured SAR(10g) (W/kg)	Reported SAR(10g) (W/kg)			
133322	683	1RB_Mid	Front	/	22.93	24.00	0.099	<b>0.13</b>	0.155	<b>0.20</b>	-0.03
133322	683	1RB_Mid	Rear	Fig.33	22.93	24.00	0.133	<b>0.17</b>	0.204	<b>0.26</b>	0.03
133322	683	1RB_Mid	Left	/	22.93	24.00	0.070	<b>0.09</b>	0.112	<b>0.14</b>	0.09
133322	683	1RB_Mid	Right	/	22.93	24.00	0.080	<b>0.10</b>	0.129	<b>0.16</b>	-0.09
133322	683	1RB_Mid	Top	/	22.93	24.00	0.057	<b>0.07</b>	0.093	<b>0.12</b>	-0.02
133322	683	50RB_Low	Front	/	21.91	23.00	0.083	<b>0.11</b>	0.130	<b>0.17</b>	0.00
133322	683	50RB_Low	Rear	/	21.91	23.00	0.110	<b>0.14</b>	0.169	<b>0.22</b>	0.00
133322	683	50RB_Low	Left	/	21.91	23.00	0.072	<b>0.09</b>	0.114	<b>0.15</b>	0.12
133322	683	50RB_Low	Right	/	21.91	23.00	0.062	<b>0.08</b>	0.100	<b>0.13</b>	-0.06
133322	683	50RB_Low	Top	/	21.91	23.00	0.047	<b>0.06</b>	0.071	<b>0.09</b>	0.11

Note1: The distance between the EUT and the phantom bottom is 10mm.

Note2: The LTE mode is QPSK\_20MHz

## 14.2 SAR results for Standard procedure

There is zoom scan measurement to be added for the highest measured SAR in each exposure configuration/band.

**Table 14.2-1: SAR Values (GSM 850 MHz Band - Head)**

Ambient Temperature: 22.9 °C						Liquid Temperature: 22.5 °C					
Frequency		Side	Test Position	Figure No.	Conducted Power (dBm)	Max. tune-up Power (dBm)	Measured SAR(10g) (W/kg)	Reported SAR(10g) (W/kg)	Measured SAR(1g) (W/kg)	Reported SAR(1g) (W/kg)	Power Drift (dB)
Ch.	MHz										
128	824.2	Left	Touch	Fig.1	32.14	33.50	0.089	<b>0.12</b>	0.119	<b>0.16</b>	0.05

**Table 14.2-2: SAR Values (GSM 850 MHz Band - Body)**

Ambient Temperature: 22.9 °C						Liquid Temperature: 22.5 °C					
Frequency		Mode (number of timeslots)	Test Position	Figure No.	Conducted Power (dBm)	Max. tune-up Power (dBm)	Measured SAR(10g) (W/kg)	Reported SAR(10g) (W/kg)	Measured SAR(1g) (W/kg)	Reported SAR(1g) (W/kg)	Power Drift (dB)
Ch.	MHz										
128	824.2	GPRS (4)	Rear	Fig.2	28.93	29.50	0.276	<b>0.32</b>	0.458	<b>0.52</b>	-0.03

Note: The distance between the EUT and the phantom bottom is 10mm.

**Table 14.2-3: SAR Values (GSM 1900 MHz Band - Head)**

Ambient Temperature: 22.9 °C						Liquid Temperature: 22.5 °C					
Frequency		Side	Test Position	Figure No.	Conducted Power (dBm)	Max. tune-up Power (dBm)	Measured SAR(10g) (W/kg)	Reported SAR(10g) (W/kg)	Measured SAR(1g) (W/kg)	Reported SAR(1g) (W/kg)	Power Drift (dB)
Ch.	MHz										
661	1880	Left	Touch	Fig.3	30.20	31.00	0.089	<b>0.11</b>	0.144	<b>0.17</b>	-0.01

**Table 14.2-4: SAR Values (GSM 1900 MHz Band - Body)**

Ambient Temperature: 22.9 °C						Liquid Temperature: 22.5 °C					
Frequency		Mode (number of timeslots)	Test Position	Figure No.	Conducted Power (dBm)	Max. tune-up Power (dBm)	Measured SAR(10g) (W/kg)	Reported SAR(10g) (W/kg)	Measured SAR(1g) (W/kg)	Reported SAR(1g) (W/kg)	Power Drift (dB)
Ch.	MHz										
512	1850.2	GPRS (4)	Bottom	Fig.4	26.61	27	0.589	<b>0.64</b>	1.1	<b>1.20</b>	-0.02

Note: The distance between the EUT and the phantom bottom is 10mm.

**Table 14.2-5: SAR Values (GSM 1900 MHz Band - Body)**

Ambient Temperature: 22.9 °C						Liquid Temperature: 22.5 °C					
Frequency		Mode (number of timeslots)	Test Position	Figure No.	Conducted Power (dBm)	Max. tune-up Power (dBm)	Measured SAR(10g) (W/kg)	Reported SAR(10g) (W/kg)	Measured SAR(1g) (W/kg)	Reported SAR(1g) (W/kg)	Power Drift (dB)
Ch.	MHz										
512	1850.2	GPRS (2)	Front	Fig.5	29.43	30.00	0.267	<b>0.30</b>	0.435	<b>0.50</b>	-0.08

Note: The distance between the EUT and the phantom bottom is 15mm.

**Table 14.2-6: SAR Values (WCDMA 850 MHz Band - Head)**

Frequency		Side	Test Position	Figure No.	Conducted Power (dBm)	Max. tune-up Power (dBm)	Measured SAR(10g) (W/kg)	Reported SAR(10g) (W/kg)	Measured SAR(1g) (W/kg)	Reported SAR(1g) (W/kg)	Power Drift (dB)
Ch.	MHz										
		Ambient Temperature: 22.9 °C					Liquid Temperature: 22.5 °C				
4183	836.6	Left	Touch	Fig.6	23.51	24.00	0.112	<b>0.13</b>	0.152	<b>0.17</b>	0.01

**Table 14.2-7: SAR Values (WCDMA 850 MHz Band - Body)**

Frequency		Test Position	Figure No.	Conducted Power (dBm)	Max. tune-up Power (dBm)	Measured SAR(10g) (W/kg)	Reported SAR(10g) (W/kg)	Measured SAR(1g) (W/kg)	Reported SAR(1g) (W/kg)	Power Drift (dB)	
Ch.	MHz										
		Ambient Temperature: 22.9 °C					Liquid Temperature: 22.5 °C				
4183	836.6	Rear	Fig.7	23.51	24.00	0.167	<b>0.19</b>	0.277	<b>0.31</b>	0.00	

Note: The distance between the EUT and the phantom bottom is 10mm.

**Table 14.2-8: SAR Values (WCDMA 1700 MHz Band - Head)**

Frequency		Side	Test Position	Figure No.	Conducted Power (dBm)	Max. tune-up Power (dBm)	Measured SAR(10g) (W/kg)	Reported SAR(10g) (W/kg)	Measured SAR(1g) (W/kg)	Reported SAR(1g) (W/kg)	Power Drift (dB)
Ch.	MHz										
		Ambient Temperature: 22.9 °C					Liquid Temperature: 22.5 °C				
1513	1752.6	Right	Touch	Fig.8	23.61	24.00	0.082	<b>0.09</b>	0.129	<b>0.14</b>	0.06

**Table 14.2-9: SAR Values (WCDMA 1700 MHz Band - Body)**

Frequency		Test Position	Figure No.	Conducted Power (dBm)	Max. tune-up Power (dBm)	Measured SAR(10g) (W/kg)	Reported SAR(10g) (W/kg)	Measured SAR(1g) (W/kg)	Reported SAR(1g) (W/kg)	Power Drift (dB)	
Ch.	MHz										
		Ambient Temperature: 22.9 °C					Liquid Temperature: 22.5 °C				
1312	1712.4	Rear	Fig.9	19.32	20.00	0.555	<b>0.65</b>	1.04	<b>1.22</b>	0.13	

Note: The distance between the EUT and the phantom bottom is 10mm

**Table 14.2-10: SAR Values (WCDMA 1700 MHz Band - Body)**

Frequency		Test Position	Figure No.	Conducted Power (dBm)	Max. tune-up Power (dBm)	Measured SAR(10g) (W/kg)	Reported SAR(10g) (W/kg)	Measured SAR(1g) (W/kg)	Reported SAR(1g) (W/kg)	Power Drift (dB)	
Ch.	MHz										
		Ambient Temperature: 22.9 °C					Liquid Temperature: 22.5 °C				
1312	1712.4	Rear	Fig.10	23.58	24.00	0.697	<b>0.77</b>	1.20	<b>1.32</b>	0.14	

Note1: The distance between the EUT and the phantom bottom is 15mm.

**Table 14.2-11: SAR Values (WCDMA 1900 MHz Band - Head)**

Ambient Temperature: 22.9 °C						Liquid Temperature: 22.5 °C					
Frequency		Side	Test Position	Figure No.	Conducted Power (dBm)	Max. tune-up Power (dBm)	Measured SAR(10g) (W/kg)	Reported SAR(10g) (W/kg)	Measured SAR(1g) (W/kg)	Reported SAR(1g) (W/kg)	Power Drift (dB)
Ch.	MHz										
9800	1880	Left	Tilt	Fig.11	23.64	24.00	0.139	<b>0.15</b>	0.222	<b>0.24</b>	-0.06

**Table 14.2-12: SAR Values (WCDMA 1900 MHz Band - Body)**

Ambient Temperature: 22.9 °C					Liquid Temperature: 22.5 °C					
Frequency		Test Position	Figure No.	Conducted Power (dBm)	Max. tune-up Power (dBm)	Measured SAR(10g) (W/kg)	Reported SAR(10g) (W/kg)	Measured SAR(1g) (W/kg)	Reported SAR(1g) (W/kg)	Power Drift (dB)
Ch.	MHz									
9662	1852.4	Bottom	Fig.12	21.57	22.00	0.498	<b>0.55</b>	0.932	<b>1.03</b>	-0.11

Note: The distance between the EUT and the phantom bottom is 10mm.

**Table 14.2-13: SAR Values (WCDMA 1900 MHz Band - Body)**

Ambient Temperature: 22.9 °C					Liquid Temperature: 22.5 °C					
Frequency		Test Position	Figure No.	Conducted Power (dBm)	Max. tune-up Power (dBm)	Measured SAR(10g) (W/kg)	Reported SAR(10g) (W/kg)	Measured SAR(1g) (W/kg)	Reported SAR(1g) (W/kg)	Power Drift (dB)
Ch.	MHz									
9662	1852.4	Front	Fig.13	23.57	24.00	0.326	<b>0.36</b>	0.530	<b>0.59</b>	-0.01

Note1: The distance between the EUT and the phantom bottom is 15mm.

**Table 14.2-14: SAR Values (LTE Band7 - Head)**

Ambient Temperature: 22.9 °C						Liquid Temperature: 22.5 °C						
Frequency		Mode	Side	Test Position	Figure No.	Conducted Power (dBm)	Max. tune-up Power (dBm)	Measured SAR(10g) (W/kg)	Reported SAR(10g) (W/kg)	Measured SAR(1g) (W/kg)	Reported SAR(1g) (W/kg)	Power Drift (dB)
Ch.	MHz											
21350	2560	1RB_Mid	Left	Touch	Fig.14	23.43	24.00	0.030	<b>0.03</b>	0.057	<b>0.06</b>	-0.04

Note1: The LTE mode is QPSK\_20MHz.

**Table 14.2-15: SAR Values (LTE Band7 - Body)**

Ambient Temperature: 22.9 °C					Liquid Temperature: 22.5 °C						
Frequency		Mode	Test Position	Figure No.	Conducted Power (dBm)	Max. tune-up Power (dBm)	Measured SAR(10g) (W/kg)	Reported SAR(10g) (W/kg)	Measured SAR(1g) (W/kg)	Reported SAR(1g) (W/kg)	Power Drift (dB)
Ch.	MHz										
21350	2560	1RB_Mid	Rear	Fig.15	23.43	24.00	0.481	<b>0.55</b>	1.03	<b>1.17</b>	-0.02

Note1: The distance between the EUT and the phantom bottom is 10mm.

Note2: The LTE mode is QPSK\_20MHz.

**Table 14.2-16: SAR Values (LTE Band12- Head)**

Ambient Temperature: 22.9 °C						Liquid Temperature: 22.5°C						
Frequency		Mode	Side	Test Position	Figure No.	Conducted Power (dBm)	Max. tune-up Power (dBm)	Measured SAR(10g) (W/kg)	Reported SAR(10g) (W/kg)	Measured SAR(1g) (W/kg)	Reported SAR(1g) (W/kg)	Power Drift (dB)
Ch.	MHz											
23131	711	1RB_Mid	Left	Tilt	Fig.16	22.98	24.00	0.381	<b>0.48</b>	0.580	<b>0.73</b>	0.07

Note1: The LTE mode is QPSK\_10MHz.

**Table 14.2-17: SAR Values (LTE Band12 - Body)**

Ambient Temperature: 22.9 °C						Liquid Temperature: 22.5°C					
Frequency		Mode	Test Position	Figure No.	Conducted Power (dBm)	Max. tune-up Power (dBm)	Measured SAR(10g) (W/kg)	Reported SAR(10g) (W/kg)	Measured SAR(1g) (W/kg)	Reported SAR(1g) (W/kg)	Power Drift (dB)
Ch.	MHz										
23130	711	1RB_Mid	Rear	Fig.17	22.98	24.00	0.175	<b>0.22</b>	0.275	<b>0.35</b>	-0.01

Note1: The distance between the EUT and the phantom bottom is 10mm.

Note2: The LTE mode is QPSK\_20MHz.

**Table 14.2-18: SAR Values (LTE Band13 - Head)**

Ambient Temperature: 22.9°C						Liquid Temperature: 22.5°C						
Frequency		Mode	Side	Test Position	Figure No.	Conducted Power (dBm)	Max. tune-up Power (dBm)	Measured SAR(10g) (W/kg)	Reported SAR(10g) (W/kg)	Measured SAR(1g) (W/kg)	Reported SAR(1g) (W/kg)	Power Drift (dB)
Ch.	MHz											
23230	782	1RB_Mid	Left	Touch	Fig.18	22.98	24.00	0.052	<b>0.07</b>	0.067	<b>0.08</b>	0.09

Note1: The LTE mode is QPSK\_10MHz.

**Table 14.2-19: SAR Values (LTE Band13 - Body)**

Ambient Temperature: 22.9 °C						Liquid Temperature: 22.5°C					
Frequency		Mode	Test Position	Figure No.	Conducted Power (dBm)	Max. tune-up Power (dBm)	Measured SAR(10g) (W/kg)	Reported SAR(10g) (W/kg)	Measured SAR(1g) (W/kg)	Reported SAR(1g) (W/kg)	Power Drift (dB)
Ch.	MHz										
23231	782	1RB_Mid	Rear	Fig.19	22.98	24.00	0.122	<b>0.15</b>	0.209	<b>0.26</b>	-0.02

Note1: The distance between the EUT and the phantom bottom is 10mm.

Note2: The LTE mode is QPSK\_10MHz.

**Table 14.2-20: SAR Values (LTE Band25 - Head)**

Ambient Temperature: 22.9 °C						Liquid Temperature: 22.5°C						
Frequency		Mode	Side	Test Position	Figure No.	Conducted Power (dBm)	Max. tune-up Power (dBm)	Measured SAR(10g) (W/kg)	Reported SAR(10g) (W/kg)	Measured SAR(1g) (W/kg)	Reported SAR(1g) (W/kg)	Power Drift (dB)
Ch.	MHz											
26590	1905	1RB_Mid	Left	Touch	Fig.20	23.53	24.00	0.188	<b>0.21</b>	0.307	<b>0.34</b>	0.06

Note1: The LTE mode is QPSK\_20MHz.

**Table 14.2-21: SAR Values (LTE Band25 - Body)**

Ambient Temperature: 22.9 °C						Liquid Temperature: 22.5°C						
Frequency		Mode	Test Position	Figure No.	Conducted Power (dBm)	Max. tune-up Power (dBm)	Measured SAR(10g) (W/kg)	Reported SAR(10g) (W/kg)	Measured SAR(1g) (W/kg)	Reported SAR(1g) (W/kg)	Power Drift (dB)	
Ch.	MHz											
26140	1860	1RB_Mid	Bottom	Fig.21	22.58	23	0.501	<b>0.55</b>	0.939	<b>1.03</b>	0.00	

Note1: The distance between the EUT and the phantom bottom is 10mm.

Note2: The LTE mode is QPSK\_20MHz

**Table 14.2-22: SAR Values (LTE Band25 - Body)**

Ambient Temperature: 22.9 °C						Liquid Temperature: 22.5°C						
Frequency		Mode	Test Position	Figure No.	Conducted Power (dBm)	Max. tune-up Power (dBm)	Measured SAR(10g) (W/kg)	Reported SAR(10g) (W/kg)	Measured SAR(1g) (W/kg)	Reported SAR(1g) (W/kg)	Power Drift (dB)	
Ch.	MHz											
26590	1905	1RB_Mid	Front	Fig.22	23.53	24.00	0.310	<b>0.35</b>	0.507	<b>0.57</b>	0.00	

Note1: The distance between the EUT and the phantom bottom is 15mm.

Note2: The LTE mode is QPSK\_20MHz

**Table 14.2-23: SAR Values (LTE Band26 - Head)**

Ambient Temperature: 22.9 °C						Liquid Temperature: 22.5°C						
Frequency		Mode	Side	Test Position	Figure No.	Conducted Power (dBm)	Max. tune-up Power (dBm)	Measured SAR(10g) (W/kg)	Reported SAR(10g) (W/kg)	Measured SAR(1g) (W/kg)	Reported SAR(1g) (W/kg)	Power Drift (dB)
Ch.	MHz											
26965	841.5	1RB_Mid	Left	Touch	Fig.23	22.99	24.00	0.091	<b>0.11</b>	0.120	<b>0.15</b>	0.01

Note1: The LTE mode is QPSK\_15MHz.

**Table 14.2-24: SAR Values (LTE Band26 - Body)**

Ambient Temperature: 22.9 °C						Liquid Temperature: 22.5°C					
Frequency		Mode	Test Position	Figure No.	Conducted Power (dBm)	Max. tune-up Power (dBm)	Measured SAR(10g) (W/kg)	Reported SAR(10g) (W/kg)	Measured SAR(1g) (W/kg)	Reported SAR(1g) (W/kg)	Power Drift (dB)
Ch.	MHz										
26965	841.5	1RB_Mid	Rear	Fig.24	22.99	24.00	0.170	<b>0.21</b>	0.283	<b>0.36</b>	-0.05

Note1: The distance between the EUT and the phantom bottom is 10mm.

Note2: The LTE mode is QPSK\_15MHz.

**Table 14.2-25: SAR Values (LTE Band41 PC2 - Head)**

Ambient Temperature: 22.9 °C						Liquid Temperature: 22.5°C						
Frequency		Mode	Side	Test Position	Figure No.	Conducted Power (dBm)	tune-up Power (dBm)	Measured SAR(10g) (W/kg)	Reported SAR(10g) (W/kg)	Measured SAR(1g) (W/kg)	Reported SAR(1g) (W/kg)	Power Drift (dB)
Ch.	MHz											
40620	2593	1RB_Mid	Right	Touch	Fig.25	26.63	27.00	0.020	<b>0.02</b>	0.034	<b>0.04</b>	0.00

Note1: The LTE mode is QPSK\_20MHz.

**Table 14.2-26: SAR Values (LTE Band41 PC2 - Body)**

Ambient Temperature: 22.9 °C						Liquid Temperature: 22.5°C					
Frequency		Mode	Test Position	Figure No.	Conducted Power (dBm)	tune-up Power (dBm)	Measured SAR(10g) (W/kg)	Reported SAR(10g) (W/kg)	Measured SAR(1g) (W/kg)	Reported SAR(1g) (W/kg)	Power Drift (dB)
Ch.	MHz										
41490	2680	1RB_Mid	Rear	Fig.26	26.23	27.00	0.506	<b>0.60</b>	1.12	<b>1.34</b>	0.03

Note1: The distance between the EUT and the phantom bottom is 10mm.

Note2: The LTE mode is QPSK\_20MHz.

**Table 14.2-27: SAR Values (LTE Band41 PC3 - Head)**

Ambient Temperature: 22.9 °C						Liquid Temperature: 22.5°C						
Frequency		Mode	Side	Test Position	Figure No.	Conducted Power (dBm)	tune-up Power (dBm)	Measured SAR(10g) (W/kg)	Reported SAR(10g) (W/kg)	Measured SAR(1g) (W/kg)	Reported SAR(1g) (W/kg)	Power Drift (dB)
Ch.	MHz											
40620	2593	1RB_Mid	Left	Touch	Fig.27	23.57	24.00	0.009	<b>0.01</b>	0.019	<b>0.02</b>	0.00

Note1: The LTE mode is QPSK\_20MHz.

**Table 14.2-28: SAR Values (LTE Band41 PC3 - Body)**

Ambient Temperature: 22.9 °C						Liquid Temperature: 22.5°C					
Frequency		Mode	Test Position	Figure No.	Conducted Power (dBm)	tune-up Power (dBm)	Measured SAR(10g) (W/kg)	Reported SAR(10g) (W/kg)	Measured SAR(1g) (W/kg)	Reported SAR(1g) (W/kg)	Power Drift (dB)
Ch.	MHz										
40620	2593	1RB_Mid	Rear	Fig.28	23.57	24.00	0.309	<b>0.34</b>	0.647	<b>0.71</b>	-0.08

Note1: The distance between the EUT and the phantom bottom is 10mm.

Note2: The LTE mode is QPSK\_20MHz.

**Table 14.2-29: SAR Values (LTE Band66 - Head)**

Ambient Temperature: 22.9 °C						Liquid Temperature: 22.5°C						
Frequency		Mode	Side	Test Position	Figure No.	Conducted Power (dBm)	tune-up Power (dBm)	Measured SAR(10g) (W/kg)	Reported SAR(10g) (W/kg)	Measured SAR(1g) (W/kg)	Reported SAR(1g) (W/kg)	Power Drift (dB)
Ch.	MHz											
132572	1770	1RB_Mid	Right	Touch	Fig.29	23.27	24.00	0.090	<b>0.11</b>	0.147	<b>0.17</b>	-0.05

Note1: The LTE mode is QPSK\_20MHz.

**Table 14.2-30: SAR Values (LTE Band66 - Body)**

Ambient Temperature: 22.9 °C						Liquid Temperature: 22.5°C					
Frequency		Mode	Test Position	Figure No.	Conducted Power (dBm)	tune-up Power (dBm)	Measured SAR(10g) (W/kg)	Reported SAR(10g) (W/kg)	Measured SAR(1g) (W/kg)	Reported SAR(1g) (W/kg)	Power Drift (dB)
Ch.	MHz										
132072	1720	50RB_High	Bottom	Fig.30	19.04	20	0.594	<b>0.74</b>	1.08	<b>1.35</b>	0.08

Note1: The distance between the EUT and the phantom bottom is 10mm.

Note2: The LTE mode is QPSK\_20MHz

**Table 14.2-31: SAR Values (LTE Band66 - Body)**

Ambient Temperature: 22.9 °C						Liquid Temperature: 22.5°C					
Frequency		Mode	Test Position	Figure No.	Conducted Power (dBm)	tune-up Power (dBm)	Measured SAR(10g) (W/kg)	Reported SAR(10g) (W/kg)	Measured SAR(1g) (W/kg)	Reported SAR(1g) (W/kg)	Power Drift (dB)
Ch.	MHz										
132072	1720	1RB_Mid	Rear	Fig.31	23.24	24.00	0.667	<b>0.79</b>	1.15000	<b>1.37</b>	0.08

Note1: The distance between the EUT and the phantom bottom is 15mm.

Note2: The LTE mode is QPSK\_20MHz

**Table 14.2-32: SAR Values (LTE Band71 - Head)**

Ambient Temperature: 22.9 °C						Liquid Temperature: 22.5°C						
Frequency		Mode	Side	Test Position	Figure No.	Conducted Power (dBm)	tune-up Power (dBm)	Measured SAR(10g) (W/kg)	Reported SAR(10g) (W/kg)	Measured SAR(1g) (W/kg)	Reported SAR(1g) (W/kg)	Power Drift (dB)
Ch.	MHz											
133322	683	1RB_Mid	Left	Touch	Fig.32	22.93	24.00	0.290	<b>0.37</b>	0.426	<b>0.54</b>	0.02

Note1: The LTE mode is QPSK\_20MHz.

**Table 14.2-33: SAR Values (LTE Band71 - Body)**

Ambient Temperature: 22.9 °C						Liquid Temperature: 22.5°C					
Frequency		Mode	Test Position	Figure No.	Conducted Power (dBm)	tune-up Power (dBm)	Measured SAR(10g) (W/kg)	Reported SAR(10g) (W/kg)	Measured SAR(1g) (W/kg)	Reported SAR(1g) (W/kg)	Power Drift (dB)
Ch.	MHz										
133322	683	1RB_Mid	Rear	Fig.33	22.93	24.00	0.133	<b>0.17</b>	0.204	<b>0.26</b>	0.03

Note1: The distance between the EUT and the phantom bottom is 10mm.

Note2: The LTE mode is QPSK\_20MHz



### 14.3 WLAN Evaluation for 2.4G

According to the KDB248227 D01, SAR is measured for 2.4GHz 802.11b DSSS using the initial test position procedure.

#### Head Evaluation

**Table 14.3-1: SAR Values (WLAN - Head)– 802.11b (Fast SAR)**

Frequency		Side	Test Position	Figure No.	Conducted Power (dBm)	Max. tune-up Power (dBm)	Measured SAR(10g) (W/kg)	Reported SAR(10g) (W/kg)	Measured SAR(1g) (W/kg)	Reported SAR(1g)(W/kg)	Power Drift (dB)
MHz	Ch.										
		Ambient Temperature: 22.9 °C					Liquid Temperature: 22.5 °C				
2437	6	Left	Touch	/	16.40	17.00	0.402	<b>0.46</b>	0.791	<b>0.91</b>	0.06
2437	6	Left	Tilt	/	16.40	17.00	0.287	<b>0.33</b>	0.582	<b>0.67</b>	-0.02
2437	6	Right	Touch	/	16.40	17.00	0.190	<b>0.22</b>	0.409	<b>0.47</b>	0.02
2437	6	Right	Tilt	/	16.40	17.00	0.198	<b>0.23</b>	0.469	<b>0.54</b>	0.10

As shown above table, the initial test position for head is “Left Touch”. So the head SAR of WLAN is presented as below:

**Table 14.3-2: SAR Values (WLAN - Head)– 802.11b (Full SAR)**

Frequency		Side	Test Position	Figure No.	Conducted Power (dBm)	Max. tune-up Power (dBm)	Measured SAR(10g) (W/kg)	Reported SAR(10g) (W/kg)	Measured SAR(1g) (W/kg)	Reported SAR(1g)(W/kg)	Power Drift (dB)
MHz	Ch.										
		Ambient Temperature: 22.9 °C					Liquid Temperature: 22.5 °C				
2437	6	Left	Touch	Fig.34	16.40	17.00	0.365	<b>0.42</b>	0.761	<b>0.87</b>	0.06
2412	1	Left	Touch	/	16.35	17.00	0.360	<b>0.42</b>	0.735	<b>0.85</b>	0.16
2437	6	Left	Tilt	/	16.40	17.00	0.277	<b>0.32</b>	0.585	<b>0.67</b>	-0.02

Note1: When the reported SAR of the initial test position is > 0.4 W/kg, SAR is repeated for the 802.11 transmission mode configuration tested in the initial test position using subsequent highest estimated 1-g SAR conditions determined by area scans, on the highest maximum output power channel, until the reported SAR is  $\leq$  0.8 W/kg.

Note2: For all positions/configurations tested using the initial test position and subsequent test positions, when the reported SAR is > 0.8 W/kg, SAR is measured for these test positions/configurations on the subsequent next highest measured output power channel until the reported SAR is  $\leq$  1.2 W/kg or all required channels are tested.

According to the KDB248227 D01, The reported SAR must be scaled to 100% transmission duty factor to determine compliance at the maximum tune-up tolerance limit. The scaled reported SAR is presented as below.

**Table 14.3-3: SAR Values (WLAN - Head) – 802.11b (Scaled Reported SAR)**

Frequency		Side	Test Position	Actual duty factor	maximum duty factor	Reported SAR (1g)(W/kg)	Scaled reported SAR (1g)(W/kg)	
MHz	Ch.							
		Ambient Temperature: 22.9 °C					Liquid Temperature: 22.5 °C	
2437	6	Left	Touch	100%	100%	<b>0.87</b>	<b>0.87</b>	

SAR is not required for OFDM because the 802.11b adjusted SAR  $\leq$  1.2 W/kg.

**Body Evaluation**

**Table 14.3-4: SAR Values (WLAN - Body)– 802.11b (Fast SAR)**

Frequency		Test Position	Figure No.	Conducted Power (dBm)	Max. tune-up Power (dBm)	Ambient Temperature: 22.9 °C		Liquid Temperature: 22.5 °C		Power Drift (dB)
MHz	Ch.					Measured SAR(10g) (W/kg)	Reported SAR(10g) (W/kg)	Measured SAR(1g) (W/kg)	Reported SAR(1g)(W/kg)	
2437	6	Front	/	20.98	21.50	0.242	<b>0.27</b>	0.447	<b>0.50</b>	0.02
2437	6	Rear	/	20.98	21.50	0.297	<b>0.33</b>	0.564	<b>0.64</b>	0.01
2437	6	Right	/	20.98	21.50	0.134	<b>0.15</b>	0.272	<b>0.31</b>	0.00
2437	6	Top	/	20.98	21.50	0.188	<b>0.21</b>	0.361	<b>0.41</b>	0.08

As shown above table, the initial test position for body is “Rear”. So the body SAR of WLAN is presented as below:

**Table 14.3-5: SAR Values (WLAN - Body)– 802.11b (Full SAR)**

Frequency		Test Position	Figure No.	Conducted Power (dBm)	Max. tune-up Power (dBm)	Ambient Temperature: 22.9 °C		Liquid Temperature: 22.5 °C		Power Drift (dB)
MHz	Ch.					Measured SAR(10g) (W/kg)	Reported SAR(10g) (W/kg)	Measured SAR(1g) (W/kg)	Reported SAR(1g)(W/kg)	
2437	6	Front	/	20.98	21.50	0.236	<b>0.27</b>	0.437	<b>0.49</b>	0.02
2437	6	Rear	Fig.35	20.98	21.50	0.289	<b>0.33</b>	0.551	<b>0.62</b>	0.01
2437	6	Rear	Note3	20.98	21.50	0.149	<b>0.17</b>	0.270	<b>0.30</b>	0.07

Note1: When the reported SAR of the initial test position is > 0.4 W/kg, SAR is repeated for the 802.11 transmission mode configuration tested in the initial test position using subsequent highest estimated 1-g SAR conditions determined by area scans, on the highest maximum output power channel, until the reported SAR is ≤ 0.8 W/kg.

Note2: For all positions/configurations tested using the initial test position and subsequent test positions, when the reported SAR is > 0.8 W/kg, SAR is measured for these test positions/configurations on the subsequent next highest measured output power channel until the reported SAR is ≤ 1.2 W/kg or all required channels are tested.

Note3: The distance between the EUT and the phantom bottom is 15mm.

According to the KDB248227 D01, The reported SAR must be scaled to 100% transmission duty factor to determine compliance at the maximum tune-up tolerance limit. The scaled reported SAR is presented as below.

**Table 14.3-6: SAR Values (WLAN - Body) – 802.11b (Scaled Reported SAR)**

Frequency		Test Position	Ambient Temperature: 22.9 °C		Liquid Temperature: 22.5 °C	
MHz	Ch.		Actual duty factor	maximum duty factor	Reported SAR (1g)(W/kg)	Scaled reported SAR (1g)(W/kg)
2462	11	Rear	100%	100%	<b>0.62</b>	<b>0.62</b>

SAR is not required for OFDM because the 802.11b adjusted SAR ≤ 1.2 W/kg.

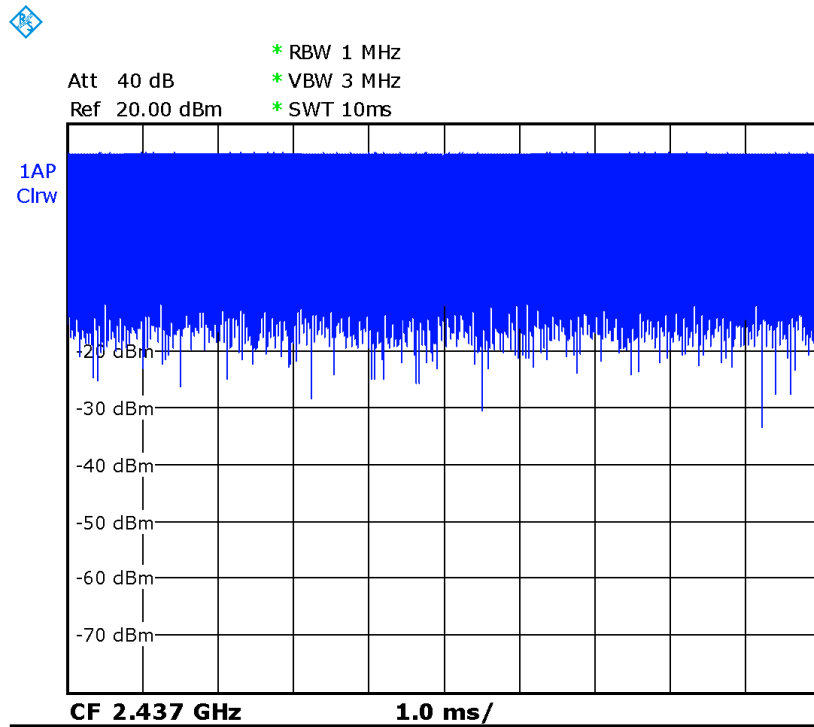

Picture 14.1 Duty factor plot for head

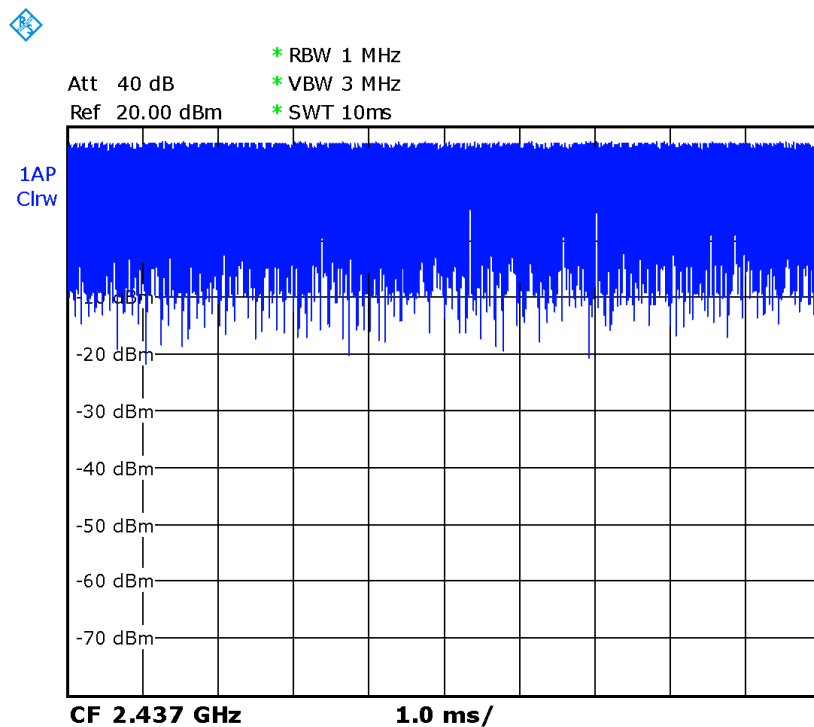

Picture 14.1 Duty factor plot for body

## 14.4 WLAN Evaluation For 5G

**Table 14.4-1: OFDM mode specified maximum output power of WLAN antenna**

802.11 mode	a	g	n		ac			
Ch. BW(MHz)	20	20	20	40	20	40	80	160
U-NII-1	X		X	X	X	X	X	
U-NII-2A	X		X	X	X	X	X	
U-NII-2C								
U-NII-3	X		X	X	X	X	X	
§ 15.247 (5.8 GHz)								

X: maximum(conducted) output power(mW), including tolerance, specified for production units

**Table 14.4-2: Maximum output power specified of WLAN antenna - Head**

802.11 mode	a	g	n		ac			
Ch. BW(MHz)	20	20	20	40	20	40	80	160
U-NII-1	32		32	10	32	10	10	
U-NII-2A	32		32	10	32	10	10	
U-NII-2C								
U-NII-3	40		32	10	32	10	10	
§ 15.247 (5.8 GHz)								

- The maximum output power specified for production units is the same for all channels, modulations and data rates in each channel bandwidth configuration of the 802.11a/g/n/ac modes.
- The blue highlighted cells represent highest output configurations in each standalone or aggregated frequency band, with tune-up tolerance included.

**Table 14.4-3: Maximum output power specified of WLAN antenna - Body**

802.11 mode	a	g	n		ac			
Ch. BW(MHz)	20	20	20	40	20	40	80	160
U-NII-1	89		93	25	79	25	25	
U-NII-2A	79		83	25	79	25	25	
U-NII-2C						25	25	
U-NII-3	79		79	25	25	25	25	
§ 15.247 (5.8 GHz)								

- The maximum output power specified for production units is the same for all channels, modulations and data rates in each channel bandwidth configuration of the 802.11a/g/n/ac modes.
- The blue highlighted cells represent highest output configurations in each standalone or aggregated frequency band, with tune-up tolerance included.

**Table 14.4-4: Maximum output power measured of WLAN antenna, for the applicable OFDM configurations according to the default power measurement procedures for selection initial test configurations - Head**

802.11 mode	a	n		ac		
BW(MHz)	20	20	40	20	40	80
U-NII-1	36/40/44/48 <b>28/29/30/27</b>	36/40/44/48 Lower power	38/46 Lower power	36/40/44/48 Lower power	38/46 Lower power	42 Lower power
U-NII-2A	52/56/60/64 <b>27/28/28/29</b>	52/56/60/64 Lower power	54/62 Lower power	52/56/60/64 Lower power	54/62 Lower power	58 Lower power
U-NII-3	149/153/157/161/ 165 <b>36/37/36/36/35</b>	149/153/157/16 1/165 Lower power	151/159 Lower power	149/153/157/161/ 165 Lower power	151/159 Lower power	155 Lower power

- The **bold numbers** is the maximum output measured power (mW).
- Channels with measured maximum power within 0.25dB are considered to have the same measured output. Channels selected for initial test configuration are **highlighted in yellow**.

**Table 14.4-5: Maximum output power measured of WLAN antenna, for the applicable OFDM configurations according to the default power measurement procedures for selection initial test configurations - Body**

802.11 mode	a	n		ac		
BW(MHz)	20	20	40	20	40	80
U-NII-1	36/40/44/48 Lower power	36/40/44/48 <b>75/75/76/74</b>	38/46 Lower power	36/40/44/48 Lower power	38/46 Lower power	42 Lower power
U-NII-2A	52/56/60/64 Lower power	52/56/60/64 <b>72/69/67/67</b>	54/62 Lower power	52/56/60/64 Lower power	54/62 Lower power	58 Lower power
U-NII-3	149/153/157/161/ 165 <b>71/76/77/72/70</b>	149/153/157/16 1/165 Lower power	151/159 Lower power	149/153/157/161 /165 Lower power	151/159 Lower power	155 Lower power

- The **bold numbers** is the maximum output measured power (mW).
- Channels with measured maximum power within 0.25dB are considered to have the same measured output. Channels selected for initial test configuration are **highlighted in yellow**.

**Table 14.4-6: Reported SAR of initial test configuration for Head**

802.11 mode	a	n		ac		
BW(MHz)	20	20	40	20	40	80
U-NII-2A	52/56/60/64 <b>0.61</b>	52/56/60/64	54/62	52/56/60/64	54/62	58
U-NII-3	149/153/157/161/ /165 <b>0.40</b>	149/153/157/161/ 165	151/159	149/153/157/161 /165	151/159	155

Highest measured output power channel tested initially are in **yellow highlight**.

**Table 14.4-7: Reported SAR of initial test configuration for Body – 10mm**

802.11 mode	a	n		ac		
BW(MHz)	20	20	40	20	40	80
U-NII-2A	52/56/60/64	52/56/60/64 0.25	54/62	52/56/60/64	54/62	58
U-NII-3	149/153/157/161 /165 0.94	149/153/157/161/ 165	151/159	149/153/157/161 /165	151/159	155

Highest measured output power channel tested initially are in yellow highlight.

**Table 14.4-8: Reported SAR of initial test configuration for Body – 10mm**

802.11 mode	a	n		ac		
BW(MHz)	20	20	40	20	40	80
U-NII-3	149/153/157/161 /165 1.04	149/153/157/161/ 165	151/159	149/153/157/161 /165	151/159	155

Highest measured output power channel tested initially are in green highlight.

**Table 14.4-9: SAR Values (WLAN 5G - Head)**

Frequency		Side	Test Position	Figure No.	Conducted Power (dBm)	Max. tune-up Power (dBm)	Measured SAR(10g) (W/kg)	Reported SAR(10g) (W/kg)	Measured SAR(1g) (W/kg)	Reported SAR(1g) (W/kg)	Power Drift (dB)
Ch.	MHz										
64	5320	Left	Touch	Fig.36	14.56	15.00	0.186	0.21	0.551	0.61	-0.03
64	5320	Left	Tilt	/	14.56	15.00	0.145	0.16	0.413	0.46	0.08
64	5320	Right	Touch	/	14.56	15.00	0.064	0.07	0.148	0.16	-0.03
64	5320	Right	Tilt	/	14.56	15.00	0.050	0.06	0.097	0.11	-0.03
153	5765	Left	Touch		15.74	16.00	0.113	0.12	0.379	0.40	0.08
153	5765	Left	Tilt	/	15.74	16.00	0.114	0.12	0.326	0.35	0.06
153	5765	Right	Touch	//	15.74	16.00	0.053	0.06	0.112	0.12	-0.08
153	5765	Right	Tilt	/	15.74	16.00	0.047	0.05	0.083	0.09	0.02

**Table 14.4-10: SAR Values (WLAN 5G - Body)**

Frequency		Test Position	Figure No.	Conducted Power (dBm)	Max. tune-up Power (dBm)	Measured SAR(10g) (W/kg)	Reported SAR(10g) (W/kg)	Measured SAR(1g) (W/kg)	Reported SAR(1g) (W/kg)	Power Drift (dB)
Ch.	MHz									
52	5260	Front	/	18.58	19.20	0.024	0.03	0.059	0.07	-0.15
52	5260	Rear	/	18.58	19.20	0.089	0.10	0.213	0.25	0.01
52	5260	Right	/	18.58	19.20	0.052	0.06	0.208	0.24	0.08
52	5260	Top	/	18.58	19.20	0.052	0.06	0.204	0.24	0.09
157	5785	Front	/	18.86	19.00	0.052	0.05	0.075	0.08	0.09
157	5785	Rear	/	18.86	19.00	0.335	0.35	0.912	0.94	0.00
153	5765	Rear	Fig.37	18.81	19.00	0.371	0.39	1.000	1.04	0.04

157	5785	Right	/	18.86	19.00	0.130	<b>0.13</b>	0.361	<b>0.37</b>	0.16
157	5785	Top	/	18.86	19.00	0.113	<b>0.12</b>	0.304	<b>0.31</b>	-0.18
153	5765	Rear	Note1	18.81	19.00	0.316	<b>0.33</b>	0.781	<b>0.82</b>	-0.04

Note: The distance between the EUT and the phantom bottom is 10mm.

Note1: The distance between the EUT and the phantom bottom is 15mm.

According to the KDB248227 D01, The reported SAR must be scaled to 100% transmission duty factor to determine compliance at the maximum tune-up tolerance limit. The scaled reported SAR is presented as below.

**Table 14.4-12: SAR Values (WLAN 5G - Head) (Scaled Reported SAR)**

Frequency		Side	Test Position	Actual duty factor	maximum duty factor	Reported SAR (1g) (W/kg)	Scaled reported SAR (1g) (W/kg)
Ch.	MHz						
64	5320	Left	Touch	100%	100%	<b>0.61</b>	<b>0.61</b>

**Table 14.4-13 SAR Values (WLAN 5G - Body) (Scaled Reported SAR)**

Frequency		Test Position	D (mm)	Actual duty factor	maximum duty factor	Reported SAR (1g) (W/kg)	Scaled reported SAR (1g) (W/kg)
Ch.	MHz						
153	5765	Rear	10	100%	100%	<b>1.04</b>	<b>1.04</b>

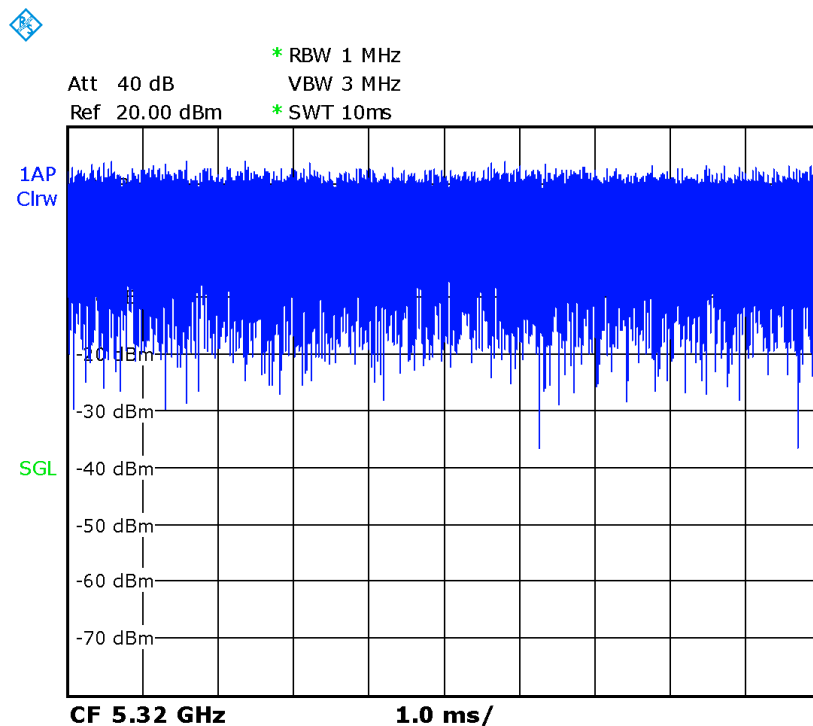

**Picture 14.4 The plot of duty factor for Head**

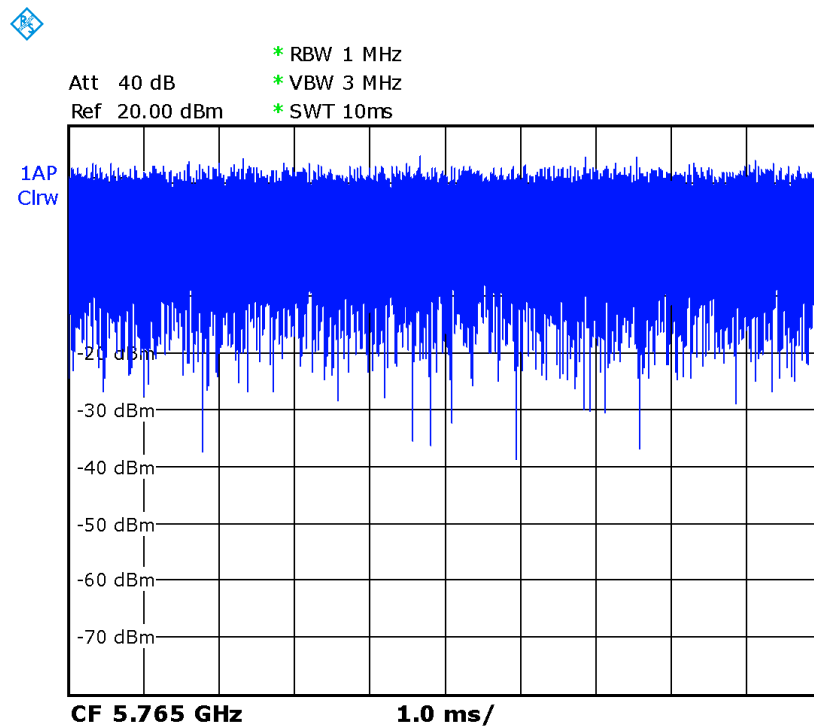

Picture 14.5 The plot of duty factor for Body

## 15 SAR Measurement Variability

SAR measurement variability must be assessed for each frequency band, which is determined by the SAR probe calibration point and tissue-equivalent medium used for the device measurements. When both head and body tissue-equivalent media are required for SAR measurements in a frequency band, the variability measurement procedures should be applied to the tissue medium with the highest measured SAR, using the highest measured SAR configuration for that tissue-equivalent medium.

The following procedures are applied to determine if repeated measurements are required.

- 1) Repeated measurement is not required when the original highest measured SAR is  $< 0.80$  W/kg; steps 2) through 4) do not apply.
- 2) When the original highest measured SAR is  $\geq 0.80$  W/kg, repeat that measurement once.
- 3) Perform a second repeated measurement only if the ratio of largest to smallest SAR for the original and first repeated measurements is  $> 1.20$  or when the original or repeated measurement is  $\geq 1.45$  W/kg ( $\sim 10\%$  from the 1-g SAR limit).
- 4) Perform a third repeated measurement only if the original, first or second repeated measurement is  $\geq 1.5$  W/kg and the ratio of largest to smallest SAR for the original, first and second repeated measurements is  $> 1.20$ .



**Table 15.1: SAR Measurement Variability for Body GSM1900 (1g)**

Frequency		Test Position	Spacing (mm)	Original SAR (W/kg)	First Repeated SAR (W/kg)	The Ratio	Second Repeated SAR (W/kg)
Ch.	MHz						
512	1850.2	Bottom	10	1.1	1.03	1.07	/

**Table 15.2: SAR Measurement Variability for Body WCDMA1700 (1g)**

Frequency		Test Position	Spacing (mm)	Original SAR (W/kg)	First Repeated SAR (W/kg)	The Ratio	Second Repeated SAR (W/kg)
Ch.	MHz						
1312	1712.4	Rear	10	1.04	0.992	1.05	/
1312	1712.4	Rear	15	1.20	1.08	1.11	/

**Table 15.3: SAR Measurement Variability for Body WCDMA1900 (1g)**

Frequency		Test Position	Spacing (mm)	Original SAR (W/kg)	First Repeated SAR (W/kg)	The Ratio	Second Repeated SAR (W/kg)
Ch.	MHz						
9262	1852.4	Bottom	10	0.932	0.910	1.02	/

**Table 15.4: SAR Measurement Variability for Body LTE B7 (1g)**

Frequency		Test Position	Spacing (mm)	Original SAR (W/kg)	First Repeated SAR (W/kg)	The Ratio	Second Repeated SAR (W/kg)
Ch.	MHz						
21350	2560	Rear	10	1.03	0.985	1.05	/

**Table 15.5: SAR Measurement Variability for Body LTE B25 (1g)**

Frequency		Test Position	Spacing (mm)	Original SAR (W/kg)	First Repeated SAR (W/kg)	The Ratio	Second Repeated SAR (W/kg)
Ch.	MHz						
26140	1860	Bottom	10	0.939	0.908	1.04	/

**Table 15.6: SAR Measurement Variability for Body LTE B41-PC2 (1g)**

Frequency		Test Position	Spacing (mm)	Original SAR (W/kg)	First Repeated SAR (W/kg)	The Ratio	Second Repeated SAR (W/kg)
Ch.	MHz						
41490	2680	Rear	10	1.12	0.995	1.13	/

**Table 15.7: SAR Measurement Variability for Body LTE B66 (1g)**

Frequency		Test Position		Spacing (mm)	Original SAR (W/kg)	First Repeated SAR (W/kg)	The Ratio	Second Repeated SAR (W/kg)
Ch.	MHz							
132072	1720	Bottom	50RB-High	10	1.08	0.981	1.10	/
132072	1720	Rear	1RB-Mid	15	1.150	0.997	1.15	/

**Table 15.8: SAR Measurement Variability for Body WLAN 5GHz (1g)**

Frequency		Test Position	Spacing (mm)	Original SAR (W/kg)	First Repeated SAR (W/kg)	The Ratio	Second Repeated SAR (W/kg)
Ch.	MHz						
153	5765	Rear	10	1.00	0.877	1.14	/

## 16 Measurement Uncertainty

### 16.1 Measurement Uncertainty for Normal SAR Tests (300MHz~3GHz)

No.	Error Description	Type	Uncertainty value	Probably Distribution	Div.	(Ci) 1g	(Ci) 10g	Std. Unc. (1g)	Std. Unc. (10g)	Degree of freedom
<b>Measurement system</b>										
1	Probe calibration	B	6.0	N	1	1	1	6.0	6.0	$\infty$
2	Isotropy	B	4.7	R	$\sqrt{3}$	0.7	0.7	1.9	1.9	$\infty$
3	Boundary effect	B	1.0	R	$\sqrt{3}$	1	1	0.6	0.6	$\infty$
4	Linearity	B	4.7	R	$\sqrt{3}$	1	1	2.7	2.7	$\infty$
5	Detection limit	B	1.0	N	1	1	1	0.6	0.6	$\infty$
6	Readout electronics	B	0.3	R	$\sqrt{3}$	1	1	0.3	0.3	$\infty$
7	Response time	B	0.8	R	$\sqrt{3}$	1	1	0.5	0.5	$\infty$
8	Integration time	B	2.6	R	$\sqrt{3}$	1	1	1.5	1.5	$\infty$
9	RF ambient conditions-noise	B	0	R	$\sqrt{3}$	1	1	0	0	$\infty$
10	RFambient conditions-reflection	B	0	R	$\sqrt{3}$	1	1	0	0	$\infty$
11	Probe positioned mech. restrictions	B	0.4	R	$\sqrt{3}$	1	1	0.2	0.2	$\infty$
12	Probe positioning with respect to phantom shell	B	2.9	R	$\sqrt{3}$	1	1	1.7	1.7	$\infty$
13	Post-processing	B	1.0	R	$\sqrt{3}$	1	1	0.6	0.6	$\infty$
<b>Test sample related</b>										
14	Test sample positioning	A	3.3	N	1	1	1	3.3	3.3	71
15	Device holder uncertainty	A	3.4	N	1	1	1	3.4	3.4	5
16	Drift of output power	B	5.0	R	$\sqrt{3}$	1	1	2.9	2.9	$\infty$
<b>Phantom and set-up</b>										
17	Phantom uncertainty	B	4.0	R	$\sqrt{3}$	1	1	2.3	2.3	$\infty$
18	Liquid conductivity (target)	B	5.0	R	$\sqrt{3}$	0.64	0.43	1.8	1.2	$\infty$
19	Liquid conductivity (meas.)	A	2.06	N	1	0.64	0.43	1.32	0.89	43
20	Liquid permittivity (target)	B	5.0	R	$\sqrt{3}$	0.6	0.49	1.7	1.4	$\infty$
21	Liquid permittivity (meas.)	A	1.6	N	1	0.6	0.49	1.0	0.8	521

Combined standard uncertainty	$u_c = \sqrt{\sum_{i=1}^{21} c_i^2 u_i^2}$					9.55	9.43	257
Expanded uncertainty (confidence interval of 95 %)	$u_e = 2u_c$					19.1	18.9	

### 16.2 Measurement Uncertainty for Normal SAR Tests (3~6GHz)

No.	Error Description	Type	Uncertainty value	Probably Distribution	Div.	(Ci) 1g	(Ci) 10g	Std. Unc. (1g)	Std. Unc. (10g)	Degree of freedom
<b>Measurement system</b>										
1	Probe calibration	B	6.55	N	1	1	1	6.55	6.55	∞
2	Isotropy	B	4.7	R	$\sqrt{3}$	0.7	0.7	1.9	1.9	∞
3	Boundary effect	B	2.0	R	$\sqrt{3}$	1	1	1.2	1.2	∞
4	Linearity	B	4.7	R	$\sqrt{3}$	1	1	2.7	2.7	∞
5	Detection limit	B	1.0	R	$\sqrt{3}$	1	1	0.6	0.6	∞
6	Readout electronics	B	0.3	R	$\sqrt{3}$	1	1	0.3	0.3	∞
7	Response time	B	0.8	R	$\sqrt{3}$	1	1	0.5	0.5	∞
8	Integration time	B	2.6	R	$\sqrt{3}$	1	1	1.5	1.5	∞
9	RF ambient conditions-noise	B	0	R	$\sqrt{3}$	1	1	0	0	∞
10	RFambient conditions-reflection	B	0	R	$\sqrt{3}$	1	1	0	0	∞
11	Probe positioned mech. restrictions	B	0.8	R	$\sqrt{3}$	1	1	0.5	0.5	∞
12	Probe positioning with respect to phantom shell	B	6.7	R	$\sqrt{3}$	1	1	3.9	3.9	∞
13	Post-processing	B	4.0	R	$\sqrt{3}$	1	1	2.3	2.3	∞
<b>Test sample related</b>										
14	Test sample positioning	A	3.3	N	1	1	1	3.3	3.3	71
15	Device holder uncertainty	A	3.4	N	1	1	1	3.4	3.4	5
16	Drift of output power	B	5.0	R	$\sqrt{3}$	1	1	2.9	2.9	∞
<b>Phantom and set-up</b>										
17	Phantom uncertainty	B	4.0	R	$\sqrt{3}$	1	1	2.3	2.3	∞
18	Liquid conductivity (target)	B	5.0	R	$\sqrt{3}$	0.64	0.43	1.8	1.2	∞
19	Liquid conductivity (meas.)	A	2.06	N	1	0.64	0.43	1.32	0.89	43
20	Liquid permittivity	B	5.0	R	$\sqrt{3}$	0.6	0.49	1.7	1.4	∞

	(target)									
21	Liquid permittivity (meas.)	A	1.6	N	1	0.6	0.49	1.0	0.8	521
Combined standard uncertainty		$u_c = \sqrt{\sum_{i=1}^{21} c_i^2 u_i^2}$						10.7	10.6	257
Expanded uncertainty (confidence interval of 95 %)		$u_e = 2u_c$						21.4	21.1	

### 16.3 Measurement Uncertainty for Fast SAR Tests (300MHz~3GHz)

No.	Error Description	Type	Uncertainty value	Probably Distribution	Div.	(Ci) 1g	(Ci) 10g	Std. Unc. (1g)	Std. Unc. (10g)	Degree of freedom
<b>Measurement system</b>										
1	Probe calibration	B	6.0	N	1	1	1	6.0	6.0	$\infty$
2	Isotropy	B	4.7	R	$\sqrt{3}$	0.7	0.7	1.9	1.9	$\infty$
3	Boundary effect	B	1.0	R	$\sqrt{3}$	1	1	0.6	0.6	$\infty$
4	Linearity	B	4.7	R	$\sqrt{3}$	1	1	2.7	2.7	$\infty$
5	Detection limit	B	1.0	R	$\sqrt{3}$	1	1	0.6	0.6	$\infty$
6	Readout electronics	B	0.3	R	$\sqrt{3}$	1	1	0.3	0.3	$\infty$
7	Response time	B	0.8	R	$\sqrt{3}$	1	1	0.5	0.5	$\infty$
8	Integration time	B	2.6	R	$\sqrt{3}$	1	1	1.5	1.5	$\infty$
9	RF ambient conditions-noise	B	0	R	$\sqrt{3}$	1	1	0	0	$\infty$
10	RFambient conditions-reflection	B	0	R	$\sqrt{3}$	1	1	0	0	$\infty$
11	Probe positioned mech. Restrictions	B	0.4	R	$\sqrt{3}$	1	1	0.2	0.2	$\infty$
12	Probe positioning with respect to phantom shell	B	2.9	R	$\sqrt{3}$	1	1	1.7	1.7	$\infty$
13	Post-processing	B	1.0	R	$\sqrt{3}$	1	1	0.6	0.6	$\infty$
14	Fast SAR z-Approximation	B	7.0	R	$\sqrt{3}$	1	1	4.0	4.0	$\infty$
<b>Test sample related</b>										
15	Test sample positioning	A	3.3	N	1	1	1	3.3	3.3	71
16	Device holder uncertainty	A	3.4	N	1	1	1	3.4	3.4	5
17	Drift of output power	B	5.0	R	$\sqrt{3}$	1	1	2.9	2.9	$\infty$
<b>Phantom and set-up</b>										
18	Phantom uncertainty	B	4.0	R	$\sqrt{3}$	1	1	2.3	2.3	$\infty$

19	Liquid conductivity (target)	B	5.0	R	$\sqrt{3}$	0.64	0.43	1.8	1.2	$\infty$
20	Liquid conductivity (meas.)	A	2.06	N	1	0.64	0.43	1.32	0.89	43
21	Liquid permittivity (target)	B	5.0	R	$\sqrt{3}$	0.6	0.49	1.7	1.4	$\infty$
22	Liquid permittivity (meas.)	A	1.6	N	1	0.6	0.49	1.0	0.8	521
Combined standard uncertainty		$u_c = \sqrt{\sum_{i=1}^{22} c_i^2 u_i^2}$						10.4	10.3	257
Expanded uncertainty (confidence interval of 95 %)		$u_e = 2u_c$						20.8	20.6	

#### 16.4 Measurement Uncertainty for Fast SAR Tests (3~6GHz)

No.	Error Description	Type	Uncertainty value	Probably Distribution	Div.	(Ci) 1g	(Ci) 10g	Std. Unc. (1g)	Std. Unc. (10g)	Degree of freedom
<b>Measurement system</b>										
1	Probe calibration	B	6.55	N	1	1	1	6.55	6.55	$\infty$
2	Isotropy	B	4.7	R	$\sqrt{3}$	0.7	0.7	1.9	1.9	$\infty$
3	Boundary effect	B	2.0	R	$\sqrt{3}$	1	1	1.2	1.2	$\infty$
4	Linearity	B	4.7	R	$\sqrt{3}$	1	1	2.7	2.7	$\infty$
5	Detection limit	B	1.0	R	$\sqrt{3}$	1	1	0.6	0.6	$\infty$
6	Readout electronics	B	0.3	R	$\sqrt{3}$	1	1	0.3	0.3	$\infty$
7	Response time	B	0.8	R	$\sqrt{3}$	1	1	0.5	0.5	$\infty$
8	Integration time	B	2.6	R	$\sqrt{3}$	1	1	1.5	1.5	$\infty$
9	RF ambient conditions-noise	B	0	R	$\sqrt{3}$	1	1	0	0	$\infty$
10	RFambient conditions-reflection	B	0	R	$\sqrt{3}$	1	1	0	0	$\infty$
11	Probe positioned mech. Restrictions	B	0.8	R	$\sqrt{3}$	1	1	0.5	0.5	$\infty$
12	Probe positioning with respect to phantom shell	B	6.7	R	$\sqrt{3}$	1	1	3.9	3.9	$\infty$
13	Post-processing	B	1.0	R	$\sqrt{3}$	1	1	0.6	0.6	$\infty$
14	Fast SAR z-Approximation	B	14.0	R	$\sqrt{3}$	1	1	8.1	8.1	$\infty$
<b>Test sample related</b>										
15	Test sample positioning	A	3.3	N	1	1	1	3.3	3.3	71
16	Device holder	A	3.4	N	1	1	1	3.4	3.4	5

	uncertainty									
17	Drift of output power	B	5.0	R	$\sqrt{3}$	1	1	2.9	2.9	$\infty$
<b>Phantom and set-up</b>										
18	Phantom uncertainty	B	4.0	R	$\sqrt{3}$	1	1	2.3	2.3	$\infty$
19	Liquid conductivity (target)	B	5.0	R	$\sqrt{3}$	0.64	0.43	1.8	1.2	$\infty$
20	Liquid conductivity (meas.)	A	2.06	N	1	0.64	0.43	1.32	0.89	43
21	Liquid permittivity (target)	B	5.0	R	$\sqrt{3}$	0.6	0.49	1.7	1.4	$\infty$
22	Liquid permittivity (meas.)	A	1.6	N	1	0.6	0.49	1.0	0.8	521
Combined standard uncertainty		$u_c = \sqrt{\sum_{i=1}^{22} c_i^2 u_i^2}$						13.5	13.4	257
Expanded uncertainty (confidence interval of 95 %)		$u_e = 2u_c$						27.0	26.8	

## 17 MAIN TEST INSTRUMENTS

Table 17.1: List of Main Instruments

No.	Name	Type	Serial Number	Calibration Date	Valid Period
01	Network analyzer	E5071C	MY46110673	January 24, 2019	One year
02	Power meter	NRVD	102083	October 24, 2018	One year
03	Power sensor	NRV-Z5	100542		
04	Signal Generator	E4438C	MY49070393	January 4, 2019	One Year
05	Amplifier	60S1G4	0331848	No Calibration Requested	
06	BTS	E5515C	MY50263375	January 17, 2019	One year
07	BTS	CMW500	159890	January 3, 2019	One year
08	E-field Probe	SPEAG EX3DV4	7514	August 27, 2018	One year
09	DAE	SPEAG DAE4	771	January 11, 2019	One year
10	Dipole Validation Kit	SPEAG D750V3	1017	July 23, 2018	Two year
11	Dipole Validation Kit	SPEAG D835V2	4d069	July 23, 2018	Two year
12	Dipole Validation Kit	SPEAG D1750V2	1003	July 20, 2018	Two year
13	Dipole Validation Kit	SPEAG D1900V2	5d101	July 24, 2018	Two year
14	Dipole Validation Kit	SPEAG D2450V2	853	July 24, 2018	Two year
15	Dipole Validation Kit	SPEAG D2600V2	1012	July 26, 2018	Two year
16	Dipole Validation Kit	SPEAG D5GHZV2	1262	January 31, 2019	One year

\*\*\*END OF REPORT BODY\*\*\*

## ANNEX A Graph Results

### GSM850\_CH128 Left Cheek

Date: 8/7/2019

Electronics: DAE4 Sn771

Medium: head 835 MHz

Medium parameters used:  $f = 824.2$ ;  $\sigma = 0.908$  mho/m;  $\epsilon_r = 41.5$ ;  $\rho = 1000$  kg/m<sup>3</sup>

Ambient Temperature: 22.5°C, Liquid Temperature: 22.3°C

Communication System: GSM850 824.2 Duty Cycle: 1:8.3

Probe: EX3DV4 – SN7514 ConvF(9.09,9.09,9.09)

**Area Scan (71x121x1):** Interpolated grid:  $dx=1.000$  mm,  $dy=1.000$  mm

Maximum value of SAR (interpolated) = W/kg

**Zoom Scan (7x7x7)/Cube 0:** Measurement grid:  $dx=5$ mm,  $dy=5$ mm,  $dz=5$ mm

Reference Value = V/m; Power Drift = 0.05 dB

Peak SAR (extrapolated) = W/kg

**SAR(1 g) = 0.119 W/kg; SAR(10 g) = 0.089 W/kg**

Maximum value of SAR (measured) = W/kg

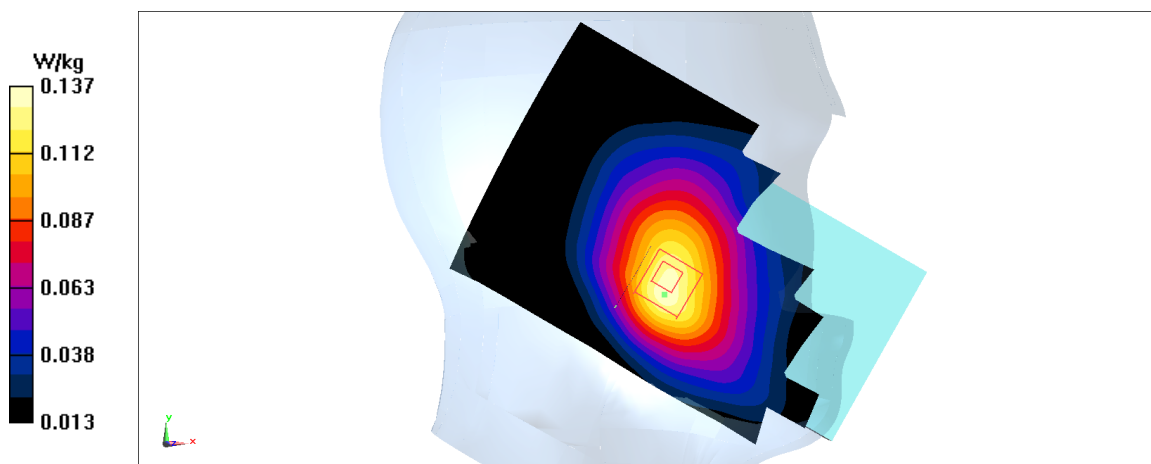

Fig A.1



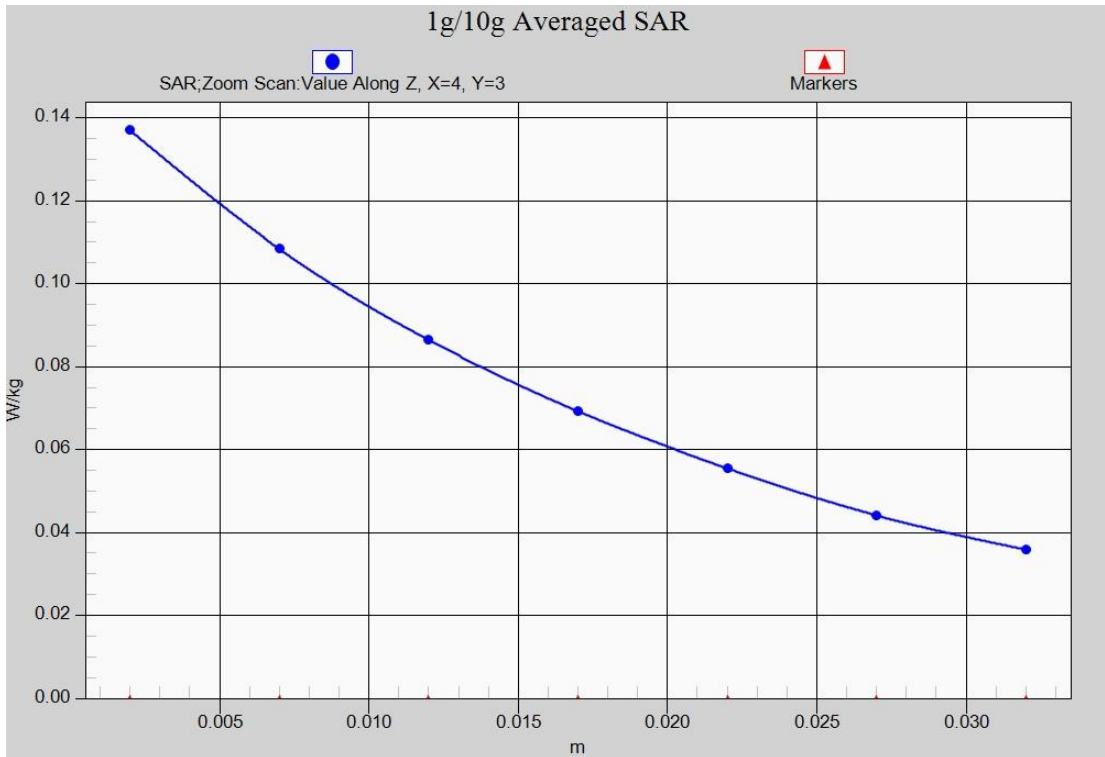

Fig. 1-1 Z-Scan at power reference point (850 MHz)

### GSM850\_CH128 Rear

Date: 8/7/2019

Electronics: DAE4 Sn771

Medium: body 835 MHz

Medium parameters used:  $f = 824.2$ ;  $\sigma = 0.954$  mho/m;  $\epsilon_r = 55.02$ ;  $\rho = 1000$  kg/m<sup>3</sup>

Ambient Temperature: 22.5°C, Liquid Temperature: 22.3°C

Communication System: GSM850 824.2 Duty Cycle: 1:2

Probe: EX3DV4 – SN7514 ConvF(9.47,9.47,9.47)

**Area Scan (71x121x1):** Interpolated grid: dx=1.000 mm, dy=1.000 mm

Maximum value of SAR (interpolated) = 0.6 W/kg

**Zoom Scan (7x7x7)/Cube 0:** Measurement grid: dx=5mm, dy=5mm, dz=5mm

Reference Value = 17.97 V/m; Power Drift = -0.03 dB

Peak SAR (extrapolated) = 0.722 W/kg

**SAR(1 g) = 0.458 W/kg; SAR(10 g) = 0.276 W/kg**

Maximum value of SAR (measured) = 0.598 W/kg

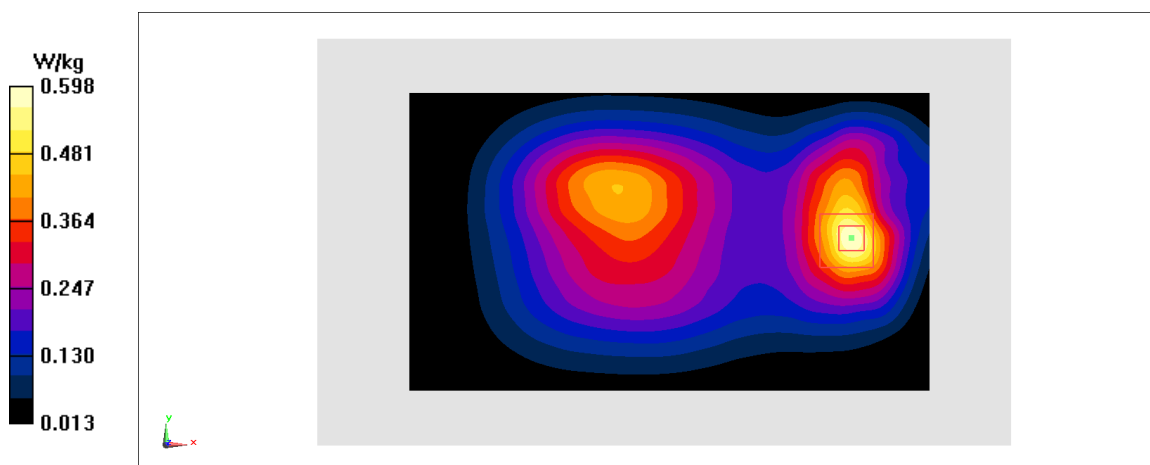

Fig A.2

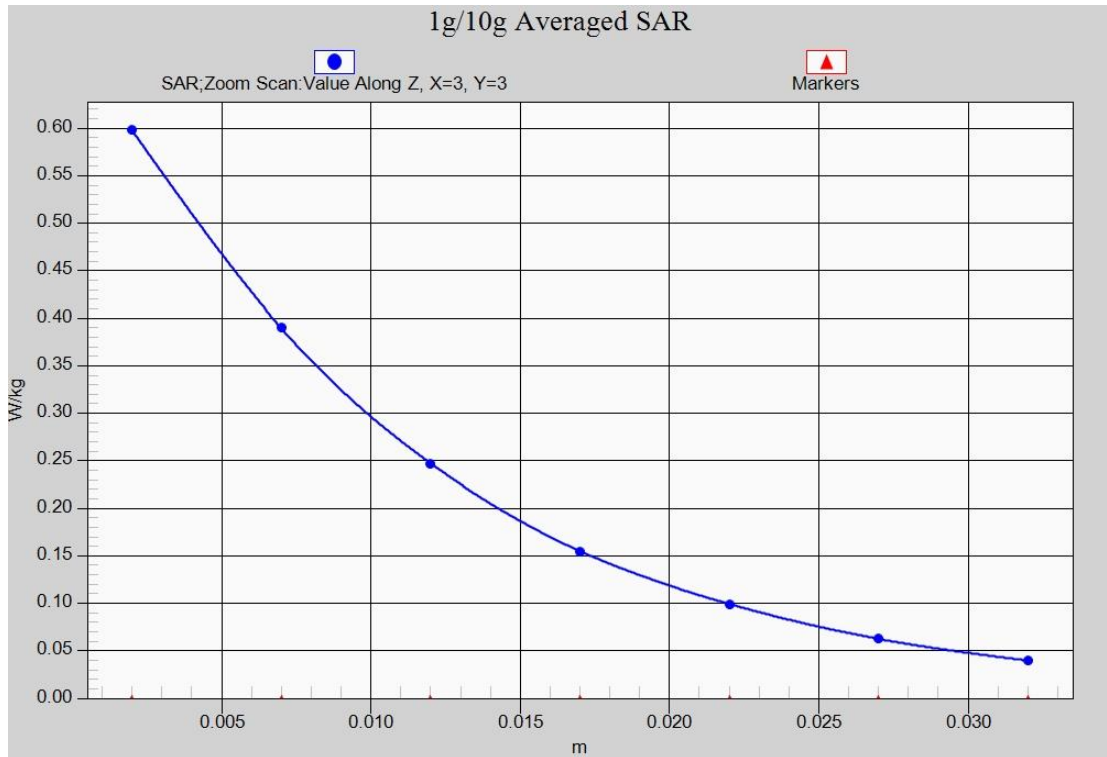

Fig. 2-1 Z-Scan at power reference point (850 MHz)

**PCS1900\_CH661 Left Cheek**

Date: 8/9/2019

Electronics: DAE4 Sn771

Medium: head 1900 MHz

Medium parameters used:  $f = 1880$ ;  $\sigma = 1.356$  mho/m;  $\epsilon_r = 40.07$ ;  $\rho = 1000$  kg/m<sup>3</sup>

Ambient Temperature: 22.5°C, Liquid Temperature: 22.3°C

Communication System: PCS1900 1880 Duty Cycle: 1:8.3

Probe: EX3DV4 – SN7514 ConvF(7.73,7.73,7.73)

**Area Scan (71x121x1):** Interpolated grid: dx=1.000 mm, dy=1.000 mm

Maximum value of SAR (interpolated) = 0.195 W/kg

**Zoom Scan (7x7x7)/Cube 0:** Measurement grid: dx=5mm, dy=5mm, dz=5mm

Reference Value = 3.187 V/m; Power Drift = -0.01 dB

Peak SAR (extrapolated) = 0.223 W/kg

**SAR(1 g) = 0.144 W/kg; SAR(10 g) = 0.089 W/kg**

Maximum value of SAR (measured) = 0.185 W/kg

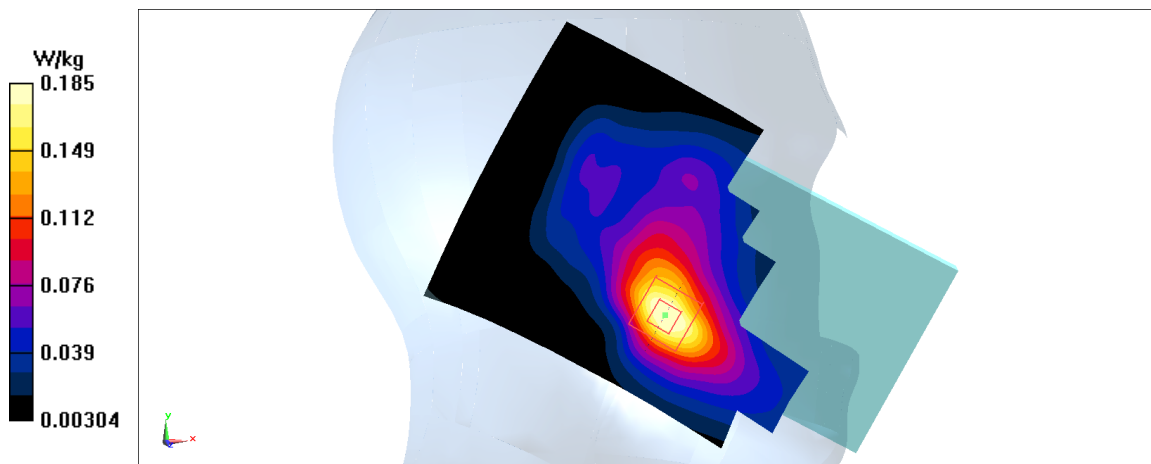

**Fig A.3**

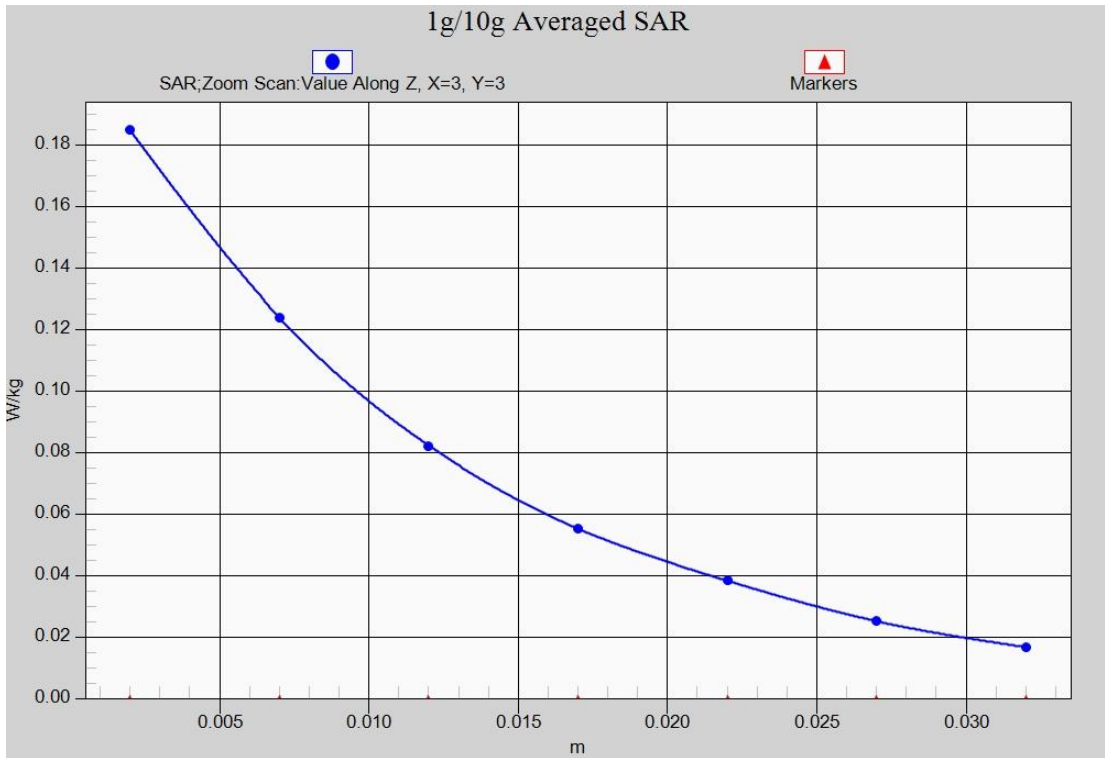

Fig. 3-1 Z-Scan at power reference point (1900 MHz)

**PCS1900\_CH512 Bottom**

Date: 8/9/2019

Electronics: DAE4 Sn771

Medium: body 1900 MHz

Medium parameters used:  $f = 1850.2$ ;  $\sigma = 1.485$  mho/m;  $\epsilon_r = 53.49$ ;  $\rho = 1000$  kg/m<sup>3</sup>

Ambient Temperature: 22.5°C, Liquid Temperature: 22.3°C

Communication System: PCS1900 1850.2 Duty Cycle: 1:2

Probe: EX3DV4 – SN7514 ConvF(7.53,7.53,7.53)

**Area Scan (71x121x1):** Interpolated grid: dx=1.000 mm, dy=1.000 mm

Maximum value of SAR (interpolated) = 1.63 W/kg

**Zoom Scan (7x7x7)/Cube 0:** Measurement grid: dx=5mm, dy=5mm, dz=5mm

Reference Value = 25.02 V/m; Power Drift = -0.02 dB

Peak SAR (extrapolated) = 1.94 W/kg

**SAR(1 g) = 1.1 W/kg; SAR(10 g) = 0.589 W/kg**

Maximum value of SAR (measured) = 1.61 W/kg

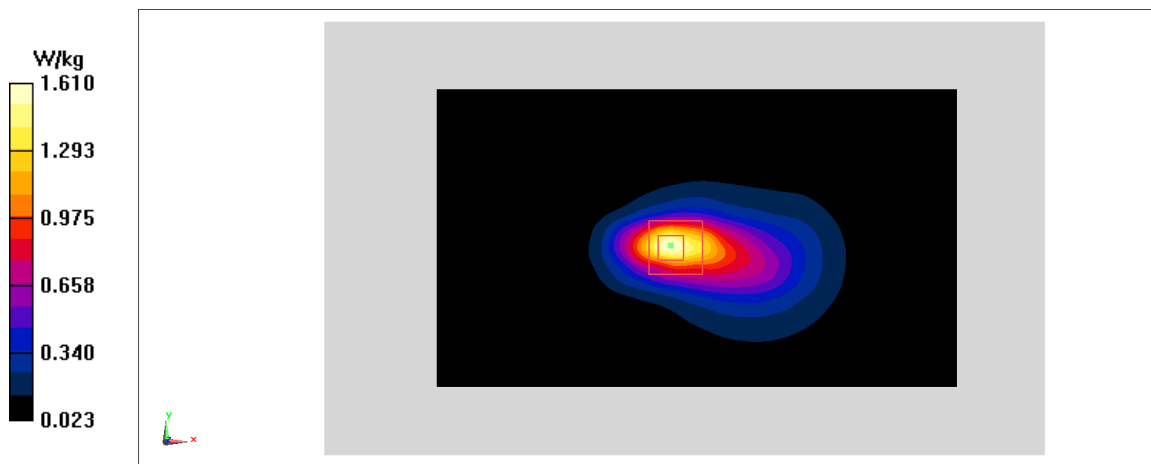

**Fig A.4**

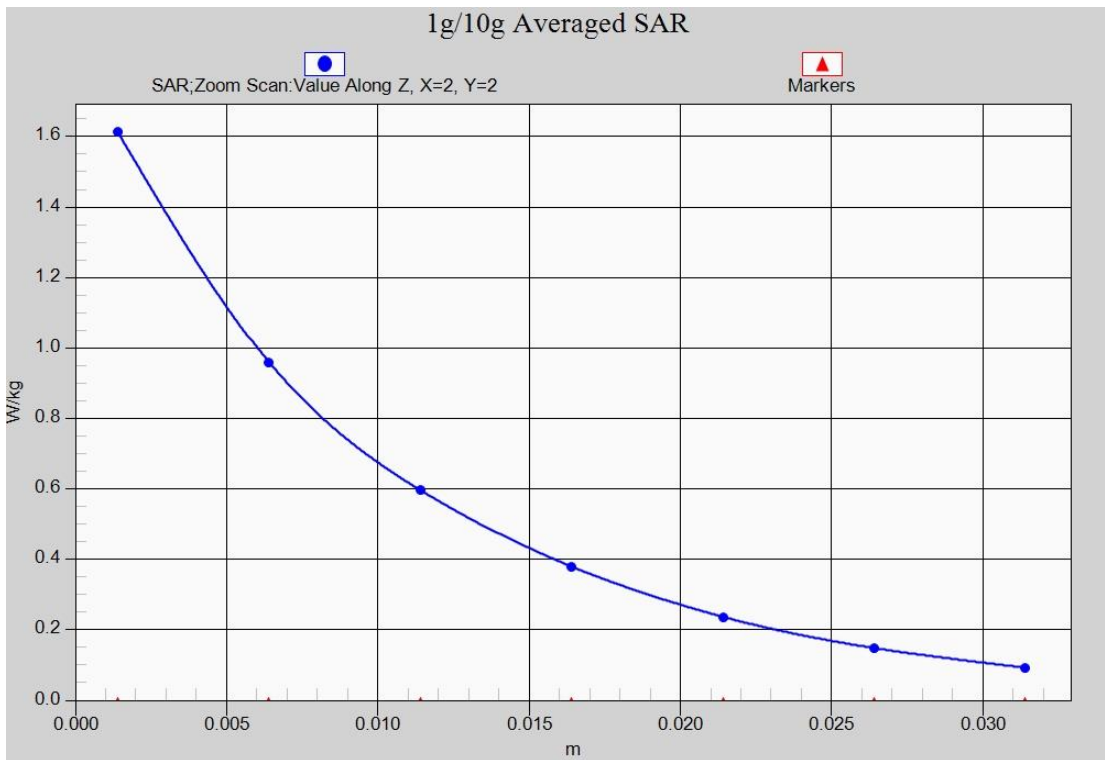

Fig. 4-1 Z-Scan at power reference point (1900 MHz)

### PCS1900\_CH512 Front

Date: 8/9/2019

Electronics: DAE4 Sn771

Medium: body 1900 MHz

Medium parameters used:  $f = 1850.2$ ;  $\sigma = 1.485$  mho/m;  $\epsilon_r = 53.49$ ;  $\rho = 1000$  kg/m<sup>3</sup>

Ambient Temperature: 22.5°C, Liquid Temperature: 22.3°C

Communication System: PCS1900 1850.2 Duty Cycle: 1:4

Probe: EX3DV4 – SN7514 ConvF(7.53,7.53,7.53)

**Area Scan (71x121x1):** Interpolated grid: dx=1.000 mm, dy=1.000 mm

Maximum value of SAR (interpolated) = 0.571 W/kg

**Zoom Scan (7x7x7)/Cube 0:** Measurement grid: dx=5mm, dy=5mm, dz=5mm

Reference Value = 8.488 V/m; Power Drift = -0.08 dB

Peak SAR (extrapolated) = 0.679 W/kg

**SAR(1 g) = 0.435 W/kg; SAR(10 g) = 0.267 W/kg**

Maximum value of SAR (measured) = 0.564 W/kg

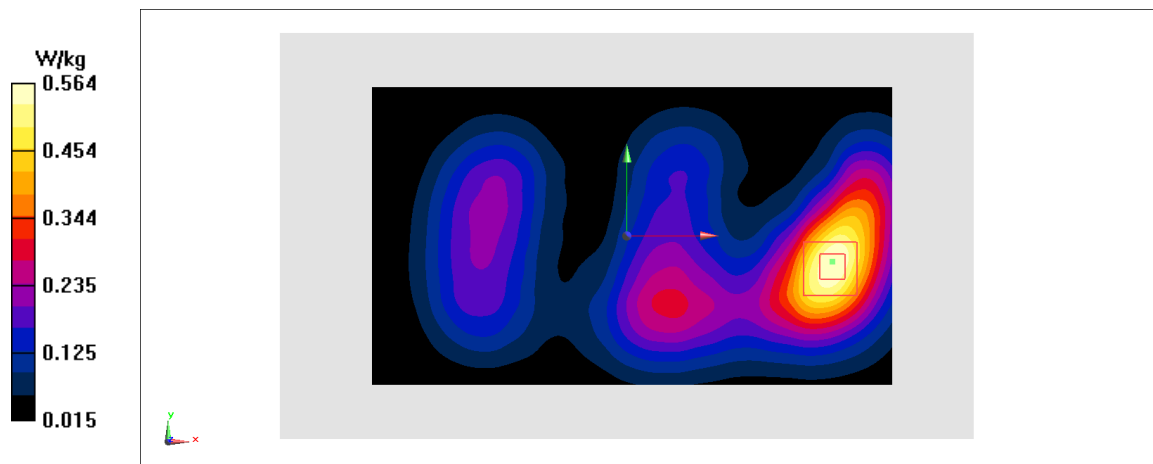
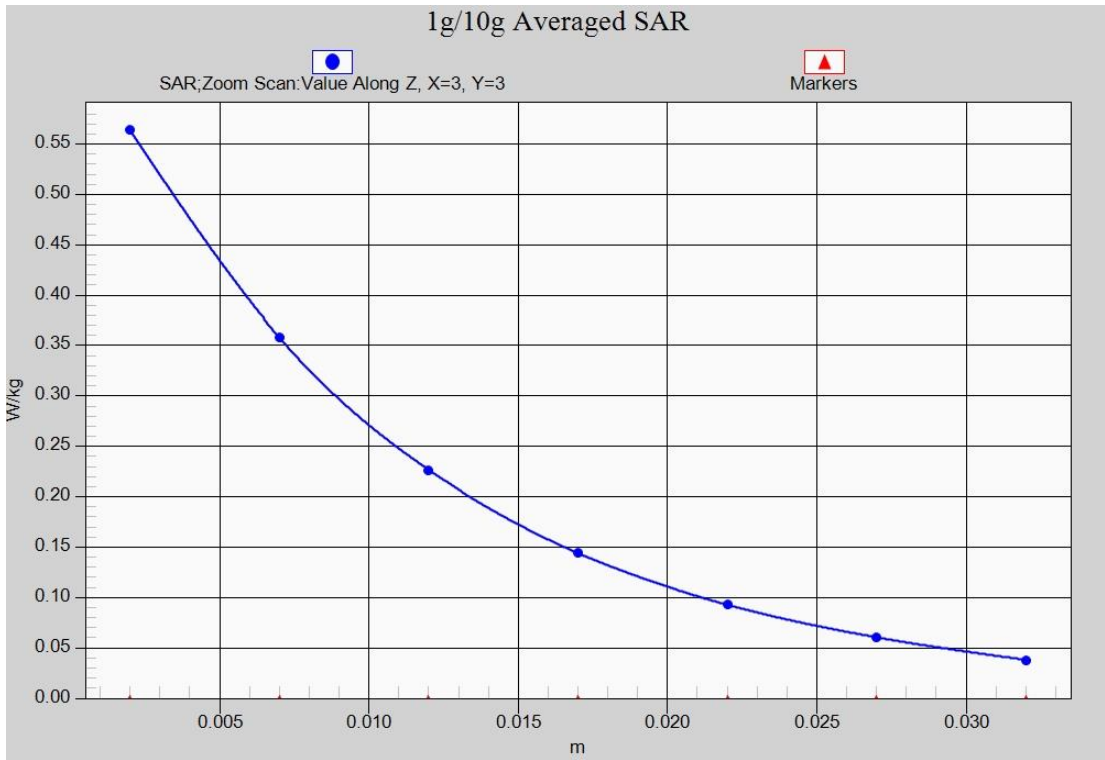

Fig A.5





**Fig. 5-1 Z-Scan at power reference point (1900 MHz)**

### WCDMA1900-BII\_CH9400 Left Tilt

Date: 8/9/2019

Electronics: DAE4 Sn771

Medium: head 1900 MHz

Medium parameters used:  $f = 1880$ ;  $\sigma = 1.356$  mho/m;  $\epsilon_r = 40.07$ ;  $\rho = 1000$  kg/m<sup>3</sup>

Ambient Temperature: 22.5°C, Liquid Temperature: 22.3°C

Communication System: WCDMA1900-BII 1880 Duty Cycle: 1:1

Probe: EX3DV4 – SN7514 ConvF(7.73,7.73,7.73)

**Area Scan (71x121x1):** Interpolated grid: dx=1.000 mm, dy=1.000 mm

Maximum value of SAR (interpolated) = 0.313 W/kg

**Zoom Scan (7x7x7)/Cube 0:** Measurement grid: dx=5mm, dy=5mm, dz=5mm

Reference Value = 9.481 V/m; Power Drift = -0.06 dB

Peak SAR (extrapolated) = 0.327 W/kg

**SAR(1 g) = 0.222 W/kg; SAR(10 g) = 0.139 W/kg**

Maximum value of SAR (measured) = 0.279 W/kg

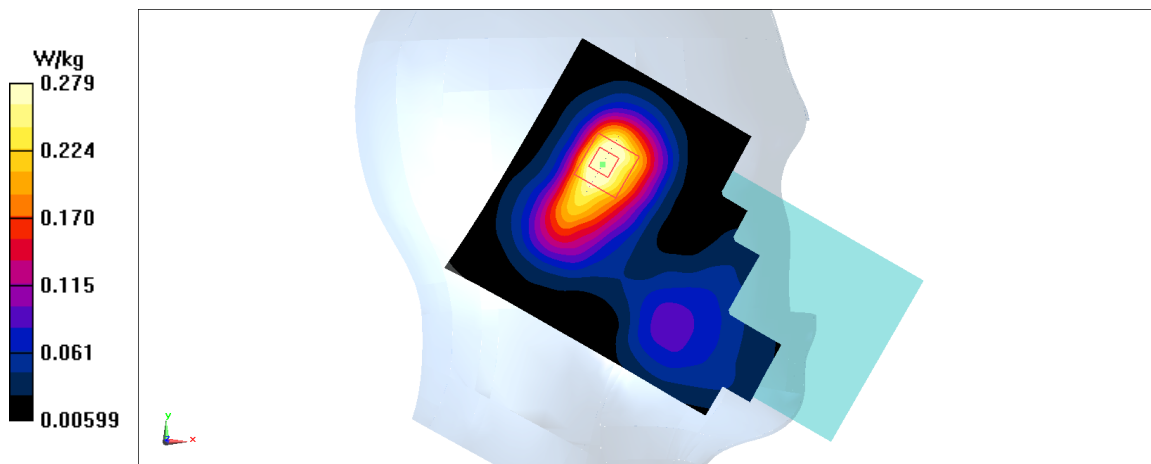
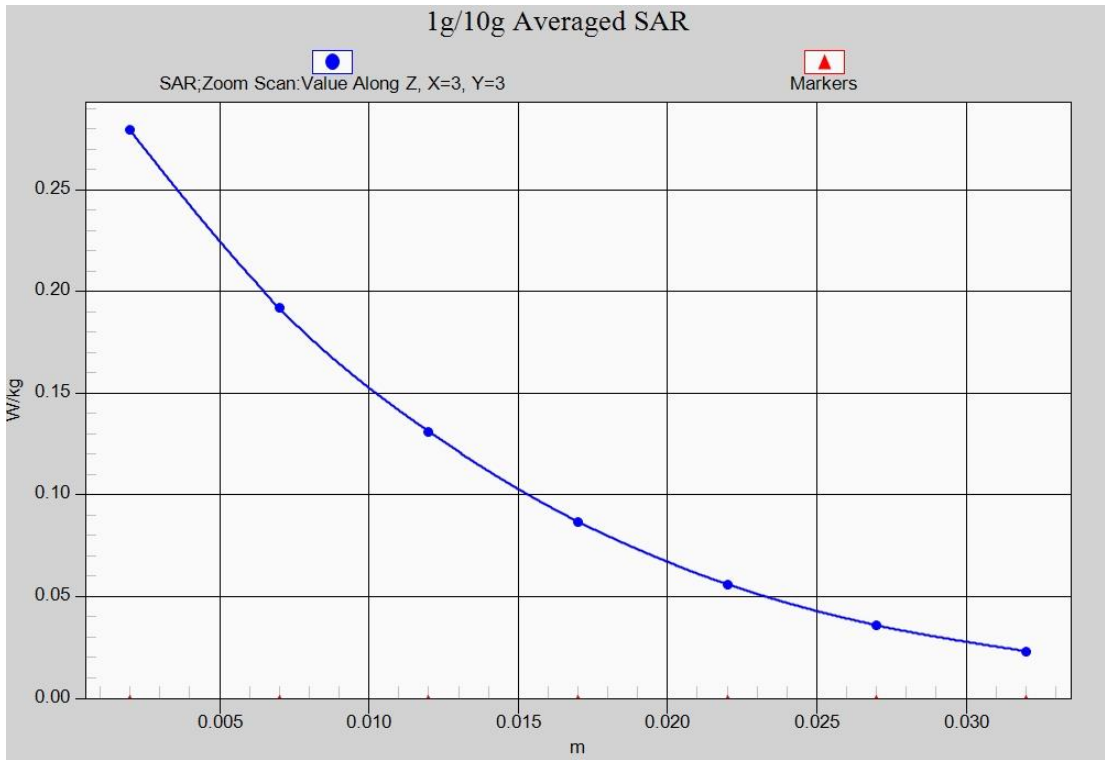

Fig A.6



**Fig. 6-1 Z-Scan at power reference point (WCDMA1900 MHz)**

### WCDMA1900-BII\_CH9262 Bottom

Date: 8/9/2019

Electronics: DAE4 Sn771

Medium: body 1900 MHz

Medium parameters used:  $f = 1852.4$ ;  $\sigma = 1.487$  mho/m;  $\epsilon_r = 53.49$ ;  $\rho = 1000$  kg/m<sup>3</sup>

Ambient Temperature: 22.5°C, Liquid Temperature: 22.3°C

Communication System: WCDMA1900-BII 1852.4 Duty Cycle: 1:1

Probe: EX3DV4 – SN7514 ConvF(7.53,7.53,7.53)

**Area Scan (71x121x1):** Interpolated grid: dx=1.000 mm, dy=1.000 mm

Maximum value of SAR (interpolated) = 1.32 W/kg

**Zoom Scan (7x7x7)/Cube 0:** Measurement grid: dx=5mm, dy=5mm, dz=5mm

Reference Value = 23.29 V/m; Power Drift = -0.11 dB

Peak SAR (extrapolated) = 1.57 W/kg

**SAR(1 g) = 0.932 W/kg; SAR(10 g) = 0.498 W/kg**

Maximum value of SAR (measured) = 1.28 W/kg

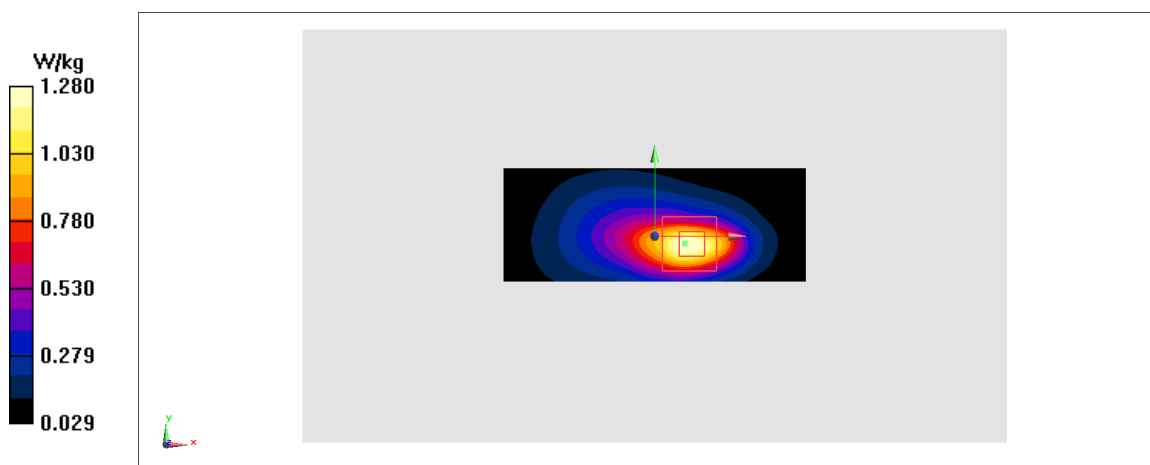

Fig A.7

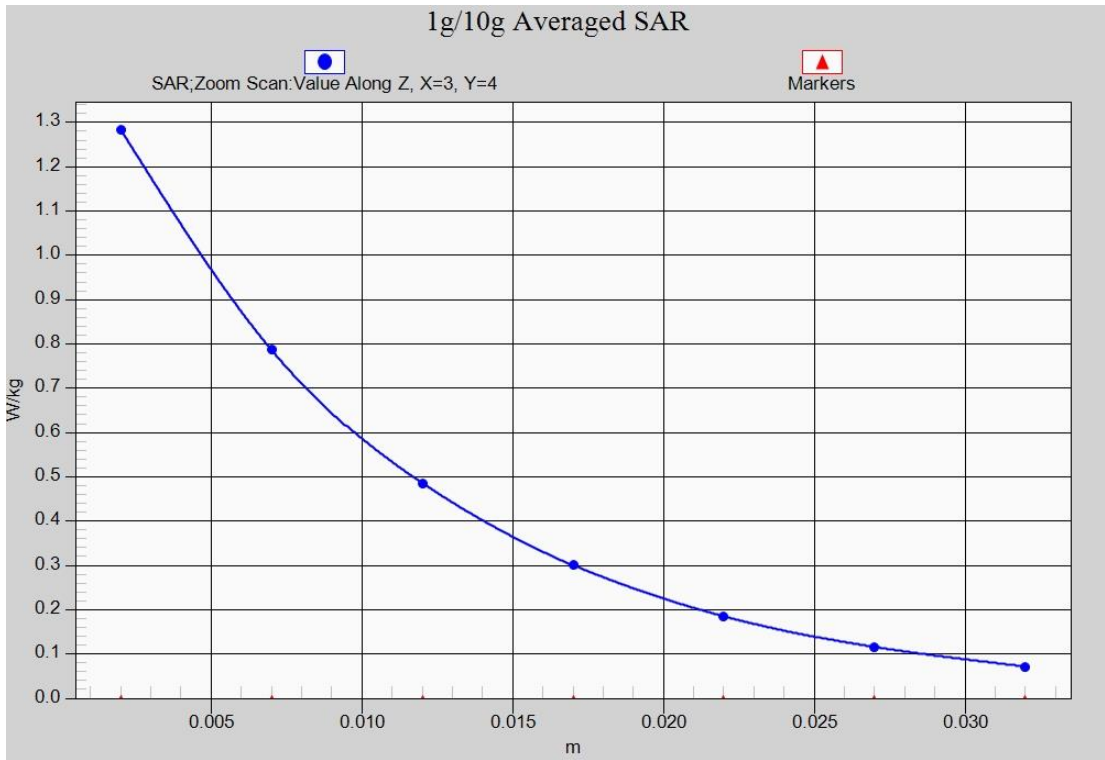

Fig. 7-1 Z-Scan at power reference point (WCDMA1900 MHz)

**WCDMA1900-BII\_CH9262 Front**

Date: 8/9/2019

Electronics: DAE4 Sn771

Medium: body 1900 MHz

Medium parameters used:  $f = 1852.4$ ;  $\sigma = 1.487$  mho/m;  $\epsilon_r = 53.49$ ;  $\rho = 1000$  kg/m<sup>3</sup>

Ambient Temperature: 22.5°C, Liquid Temperature: 22.3°C

Communication System: WCDMA1900-BII 1852.4 Duty Cycle: 1:1

Probe: EX3DV4 – SN7514 ConvF(7.53,7.53,7.53)

**Area Scan (71x121x1):** Interpolated grid: dx=1.000 mm, dy=1.000 mm

Maximum value of SAR (interpolated) = 0.695 W/kg

**Zoom Scan (7x7x7)/Cube 0:** Measurement grid: dx=5mm, dy=5mm, dz=5mm

Reference Value = 9.275 V/m; Power Drift = -0.01 dB

Peak SAR (extrapolated) = 0.83 W/kg

**SAR(1 g) = 0.53 W/kg; SAR(10 g) = 0.326 W/kg**

Maximum value of SAR (measured) = 0.688 W/kg

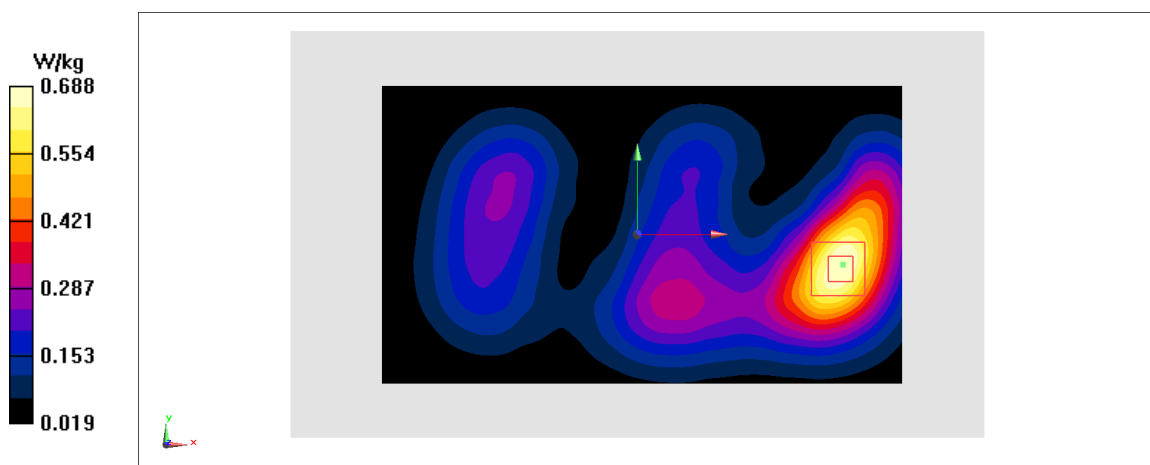

**Fig A.8**

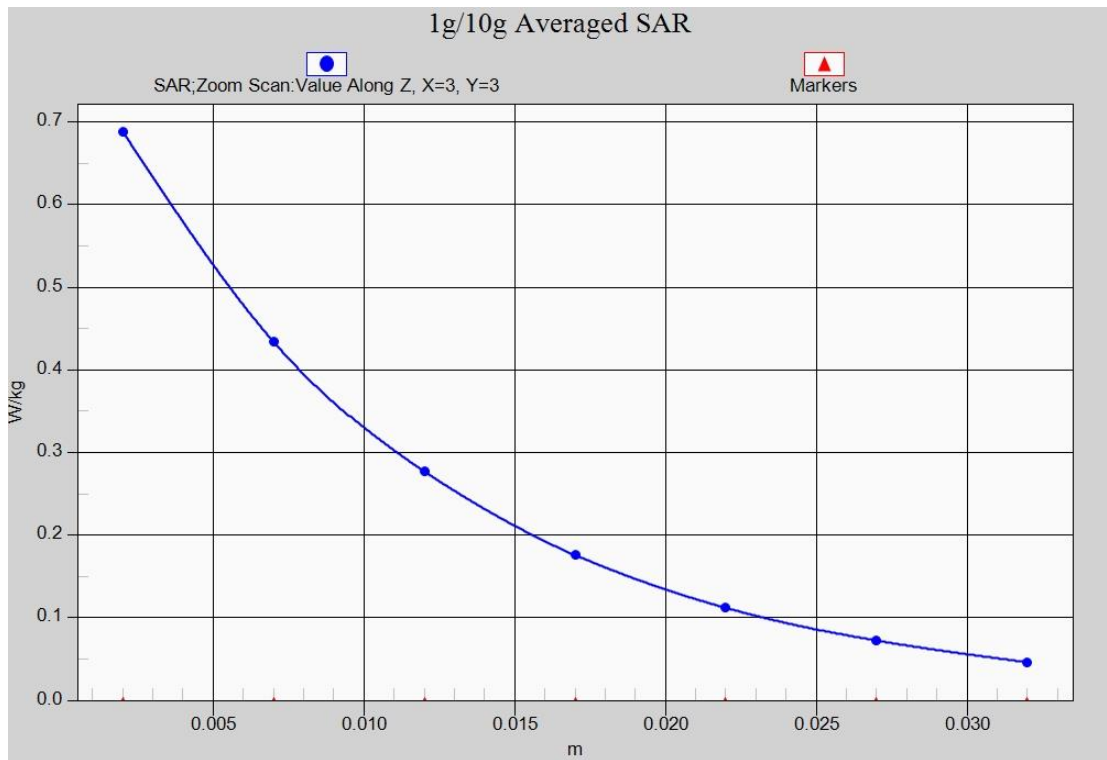

Fig. 8-1 Z-Scan at power reference point (WCDMA1900)

### WCDMA1700-BIV\_CH1513 Right Cheek

Date: 8/8/2019

Electronics: DAE4 Sn771

Medium: head 1750 MHz

Medium parameters used:  $f = 1752.6$ ;  $\sigma = 1.358$  mho/m;  $\epsilon_r = 39.86$ ;  $\rho = 1000$  kg/m<sup>3</sup>

Ambient Temperature: 22.5°C, Liquid Temperature: 22.3°C

Communication System: WCDMA1700-BIV 1752.6 Duty Cycle: 1:1

Probe: EX3DV4 – SN7514 ConvF(8.10,8.10,8.10)

**Area Scan (71x121x1):** Interpolated grid: dx=1.000 mm, dy=1.000 mm

Maximum value of SAR (interpolated) = 0.176 W/kg

**Zoom Scan (7x7x7)/Cube 0:** Measurement grid: dx=5mm, dy=5mm, dz=5mm

Reference Value = 4.035 V/m; Power Drift = 0.06 dB

Peak SAR (extrapolated) = 0.187 W/kg

**SAR(1 g) = 0.129 W/kg; SAR(10 g) = 0.082 W/kg**

Maximum value of SAR (measured) = 0.158 W/kg

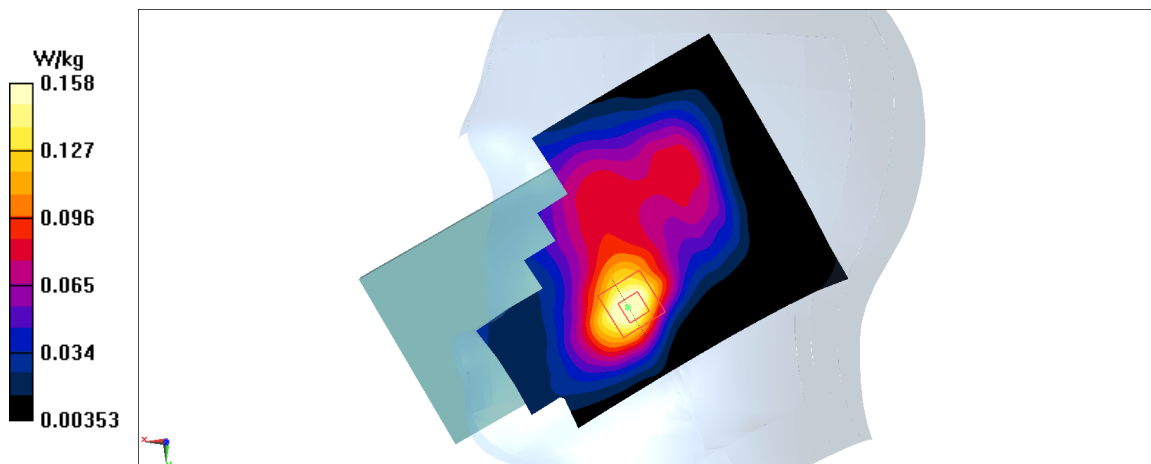

Fig A.9



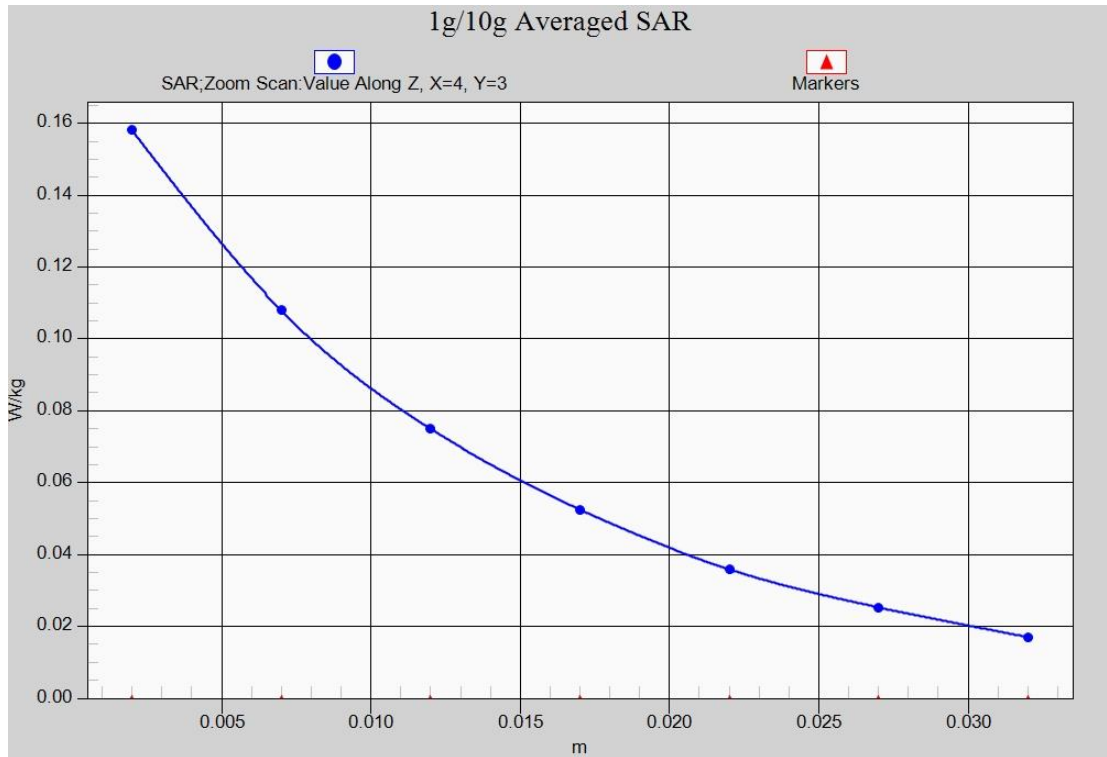

Fig. 9-1 Z-Scan at power reference point (WCDMA1700)

### WCDMA1700-BIV\_CH1312 Rear

Date: 8/8/2019

Electronics: DAE4 Sn771

Medium: body 1750 MHz

Medium parameters used:  $f = 1712.4$ ;  $\sigma = 1.459$  mho/m;  $\epsilon_r = 54.25$ ;  $\rho = 1000$  kg/m<sup>3</sup>

Ambient Temperature: 22.5°C, Liquid Temperature: 22.3°C

Communication System: WCDMA1700-BIV 1712.4 Duty Cycle: 1:1

Probe: EX3DV4 – SN7514 ConvF(7.82,7.82,7.82)

**Area Scan (71x121x1):** Interpolated grid: dx=1.000 mm, dy=1.000 mm

Maximum value of SAR (interpolated) = 1.62 W/kg

**Zoom Scan (7x7x7)/Cube 0:** Measurement grid: dx=5mm, dy=5mm, dz=5mm

Reference Value = 2.837 V/m; Power Drift = 0.13 dB

Peak SAR (extrapolated) = 1.87 W/kg

**SAR(1 g) = 1.04 W/kg; SAR(10 g) = 0.555 W/kg**

Maximum value of SAR (measured) = 1.58 W/kg

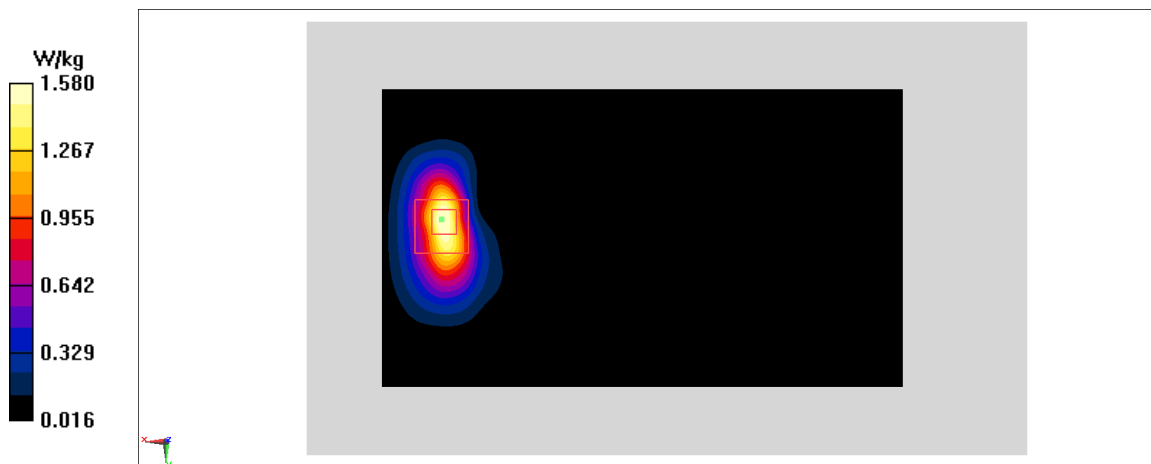

Fig A.10

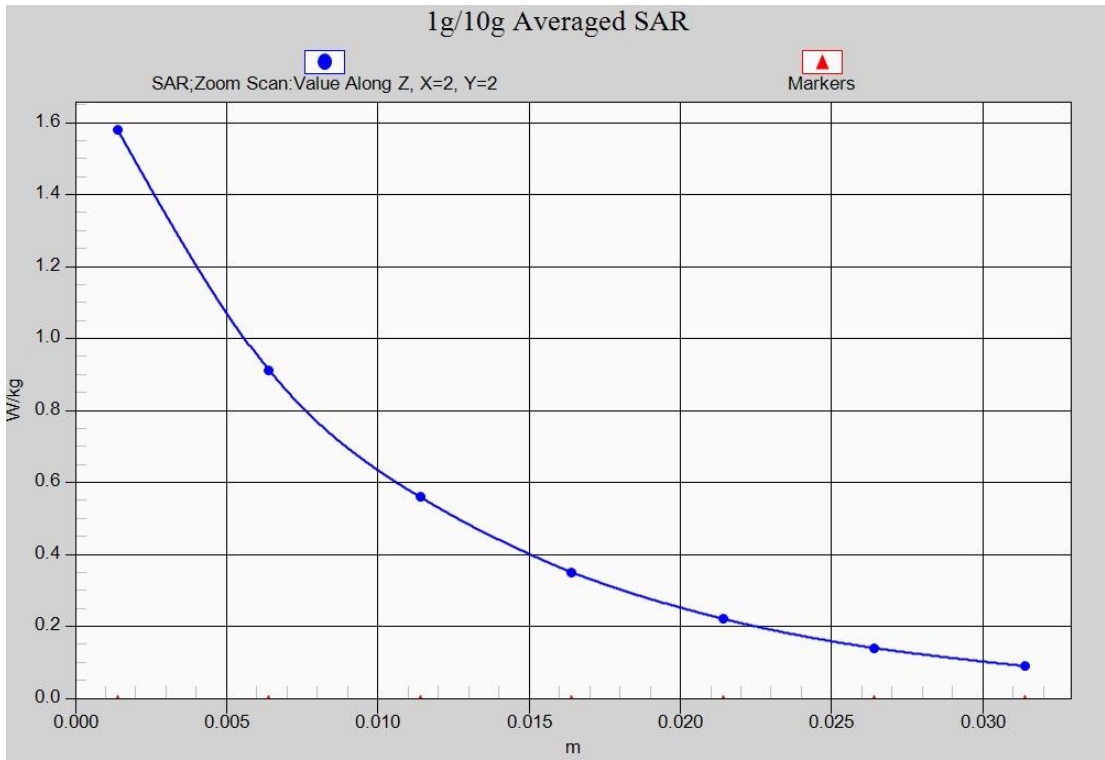

Fig. 10-1 Z-Scan at power reference point (WCDMA1700)

**WCDMA1700-BIV\_CH1312 Rear**

Date: 8/8/2019

Electronics: DAE4 Sn771

Medium: body 1750 MHz

Medium parameters used:  $f = 1712.4$ ;  $\sigma = 1.459$  mho/m;  $\epsilon_r = 54.25$ ;  $\rho = 1000$  kg/m<sup>3</sup>

Ambient Temperature: 22.5°C, Liquid Temperature: 22.3°C

Communication System: WCDMA1700-BIV 1712.4 Duty Cycle: 1:1

Probe: EX3DV4 – SN7514 ConvF(7.82,7.82,7.82)

**Area Scan (71x121x1):** Interpolated grid: dx=1.000 mm, dy=1.000 mm

Maximum value of SAR (interpolated) = 1.71 W/kg

**Zoom Scan (7x7x7)/Cube 0:** Measurement grid: dx=5mm, dy=5mm, dz=5mm

Reference Value = 5.544 V/m; Power Drift = 0.14 dB

Peak SAR (extrapolated) = 1.9 W/kg

**SAR(1 g) = 1.2 W/kg; SAR(10 g) = 0.697 W/kg**

Maximum value of SAR (measured) = 1.58 W/kg

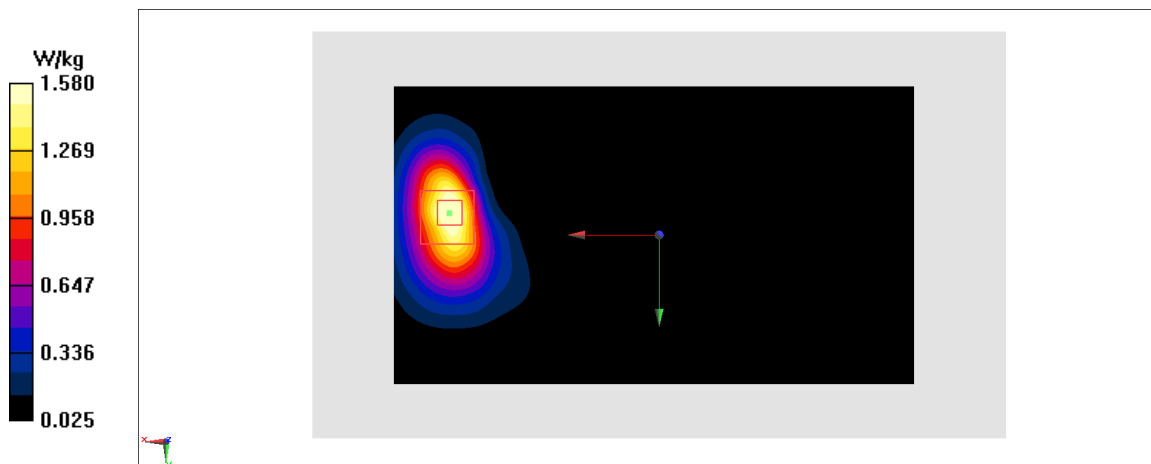

**Fig A.11**

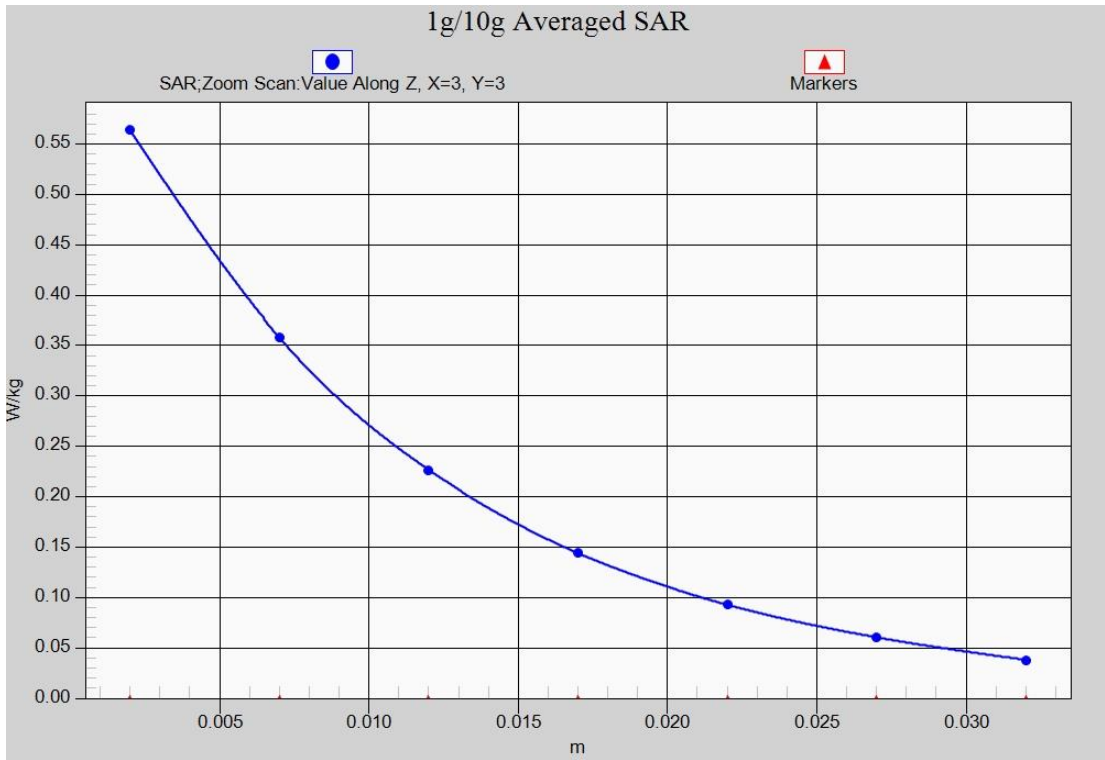

**Fig. 11-1 Z-Scan at power reference point (WCDMA1700)**

### WCDMA850-BV\_CH4183 Left Cheek

Date: 8/7/2019

Electronics: DAE4 Sn771

Medium: head 835 MHz

Medium parameters used:  $f = 836.6$ ;  $\sigma = 0.92$  mho/m;  $\epsilon_r = 41.49$ ;  $\rho = 1000$  kg/m<sup>3</sup>

Ambient Temperature: 22.5°C, Liquid Temperature: 22.3°C

Communication System: WCDMA850-BV 836.6 Duty Cycle: 1:1

Probe: EX3DV4 – SN7514 ConvF(9.09,9.09,9.09)

**Area Scan (71x121x1):** Interpolated grid: dx=1.000 mm, dy=1.000 mm

Maximum value of SAR (interpolated) = 0.18 W/kg

**Zoom Scan (7x7x7)/Cube 0:** Measurement grid: dx=5mm, dy=5mm, dz=5mm

Reference Value = 3.006 V/m; Power Drift = 0.01 dB

Peak SAR (extrapolated) = 0.199 W/kg

**SAR(1 g) = 0.152 W/kg; SAR(10 g) = 0.112 W/kg**

Maximum value of SAR (measured) = 0.176 W/kg

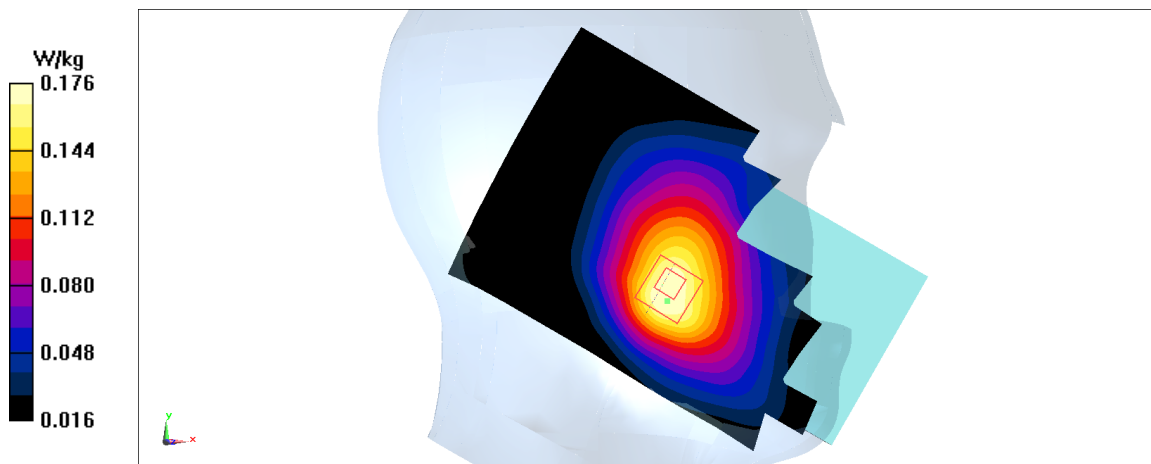
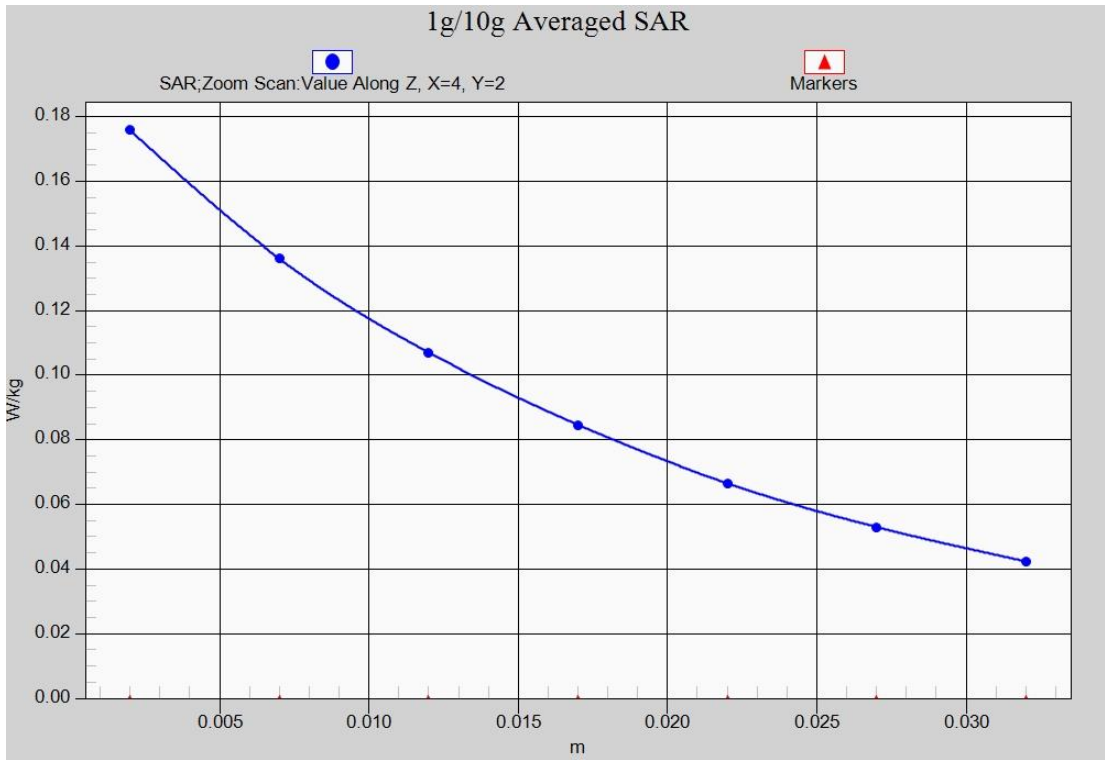

Fig A.12



**Fig. 12-1 Z-Scan at power reference point (WCDMA850)**

**WCDMA850-BV\_CH4183 Rear**

Date: 8/7/2019

Electronics: DAE4 Sn771

Medium: body 835 MHz

Medium parameters used:  $f = 836.6$ ;  $\sigma = 0.966$  mho/m;  $\epsilon_r = 55.01$ ;  $\rho = 1000$  kg/m<sup>3</sup>

Ambient Temperature: 22.5°C, Liquid Temperature: 22.3°C

Communication System: WCDMA850-BV 836.6 Duty Cycle: 1:1

Probe: EX3DV4 – SN7514 ConvF(9.47,9.47,9.47)

**Area Scan (71x121x1):** Interpolated grid: dx=1.000 mm, dy=1.000 mm

Maximum value of SAR (interpolated) = 0.356 W/kg

**Zoom Scan (7x7x7)/Cube 0:** Measurement grid: dx=5mm, dy=5mm, dz=5mm

Reference Value = 14.47 V/m; Power Drift = 0 dB

Peak SAR (extrapolated) = 0.435 W/kg

**SAR(1 g) = 0.277 W/kg; SAR(10 g) = 0.167 W/kg**

Maximum value of SAR (measured) = 0.359 W/kg

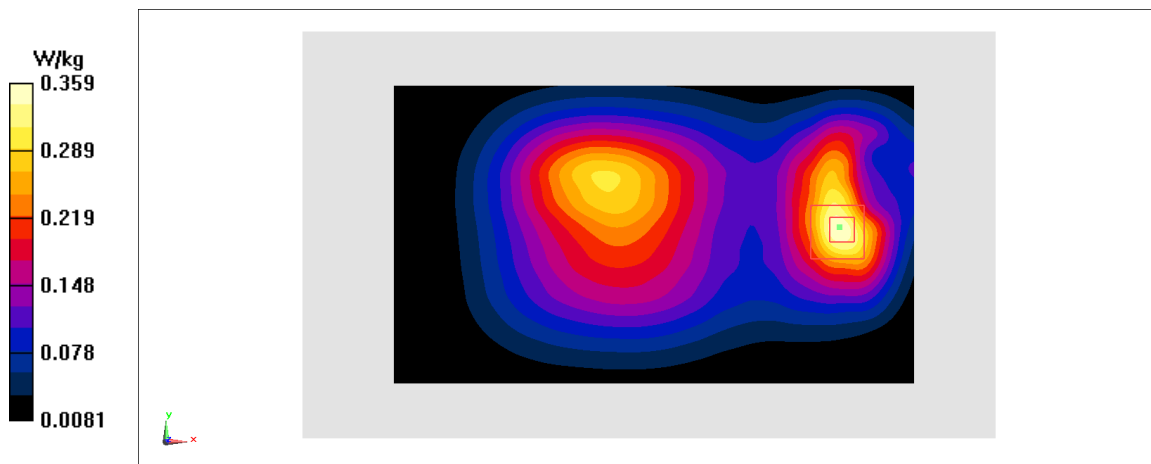

**Fig A.13**



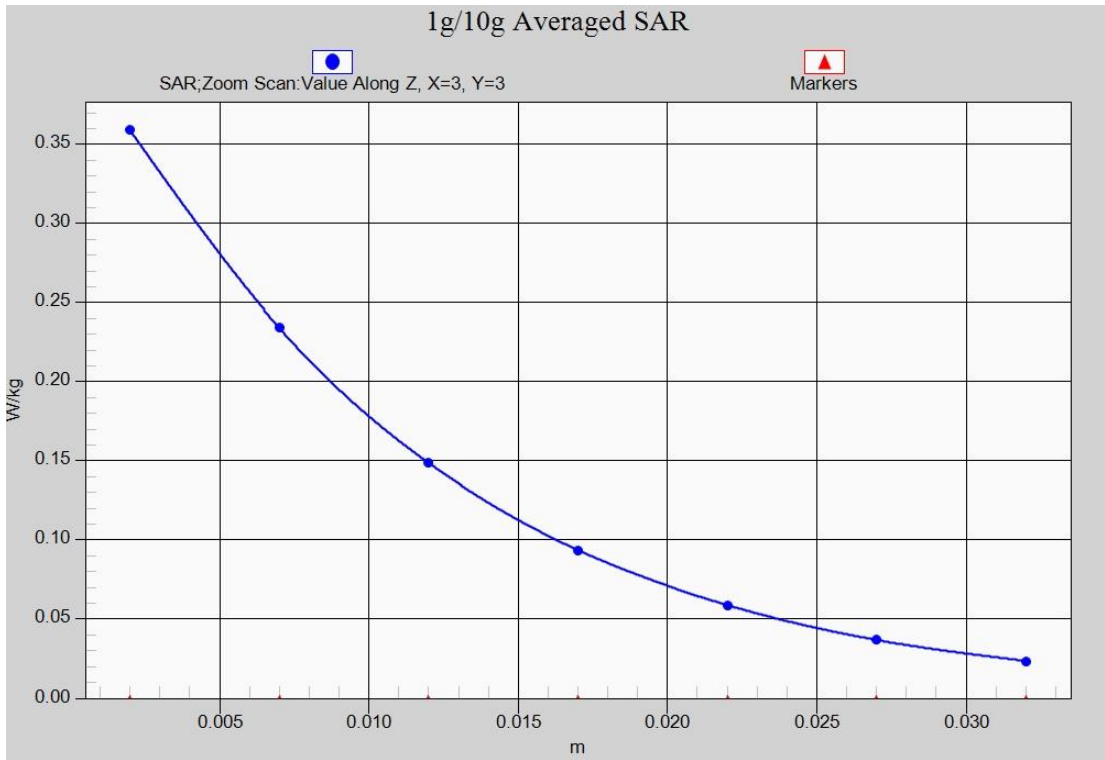

Fig. 13-1 Z-Scan at power reference point (WCDMA850)

### LTE2500-FDD7\_CH21350 Left Cheek

Date: 8/10/2019

Electronics: DAE4 Sn771

Medium: head 2600 MHz

Medium parameters used:  $f = 2560$  MHz;  $\sigma = 1.923$  mho/m;  $\epsilon_r = 39.15$ ;  $\rho = 1000$  kg/m<sup>3</sup>

Ambient Temperature: 22.5°C, Liquid Temperature: 22.3°C

Communication System: LTE2500-FDD7 2560 MHz Duty Cycle: 1:1

Probe: EX3DV4 – SN7514 ConvF(6.92,6.92,6.92)

**Area Scan (71x121x1):** Interpolated grid: dx=1.000 mm, dy=1.000 mm

Maximum value of SAR (interpolated) = 0.0957 W/kg

**Zoom Scan (7x7x7)/Cube 0:** Measurement grid: dx=5mm, dy=5mm, dz=5mm

Reference Value = 0.843 V/m; Power Drift = -0.04 dB

Peak SAR (extrapolated) = 0.111 W/kg

**SAR(1 g) = 0.057 W/kg; SAR(10 g) = 0.03 W/kg**

Maximum value of SAR (measured) = 0.0828 W/kg

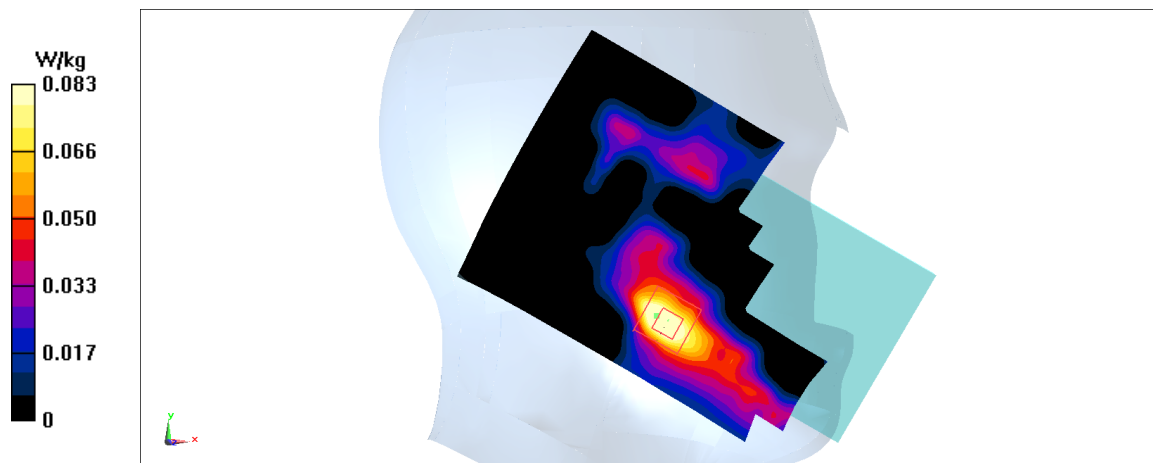
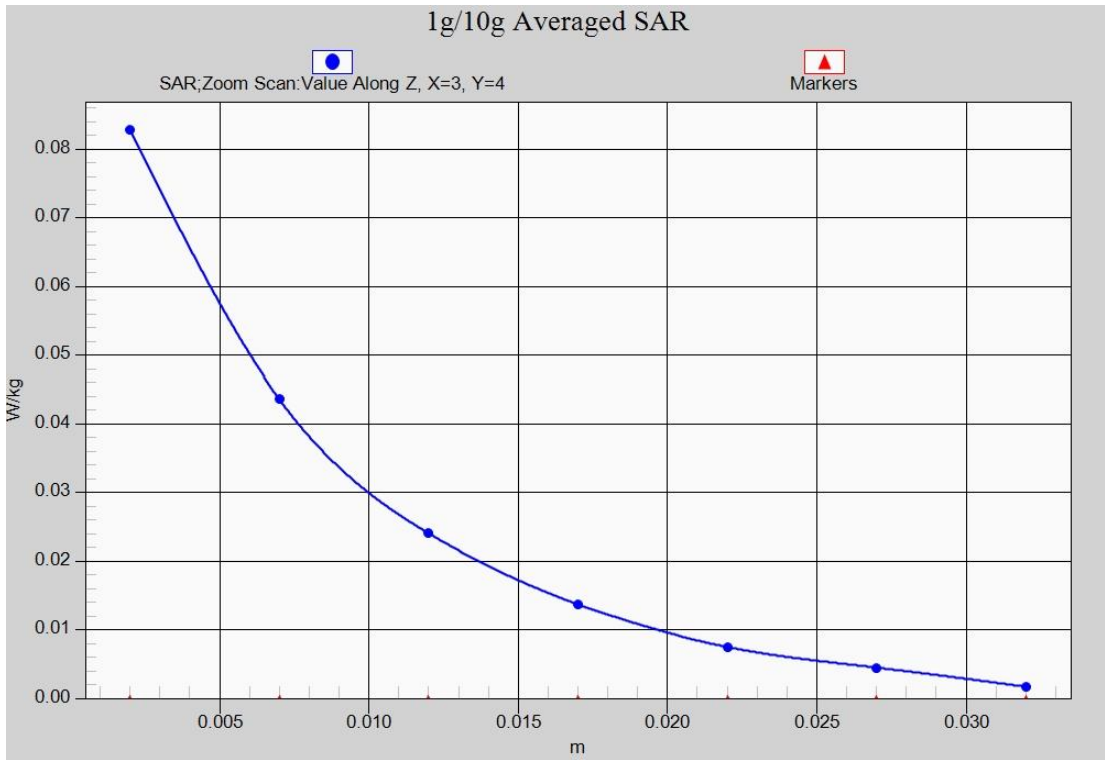

Fig A.14



**Fig. 14-1 Z-Scan at power reference point (LTE Band7)**

**LTE2500-FDD7\_CH21350 Rear**

Date: 8/10/2019

Electronics: DAE4 Sn771

Medium: body 2600 MHz

Medium parameters used:  $f = 2560$  MHz;  $\sigma = 2.162$  mho/m;  $\epsilon_r = 53.41$ ;  $\rho = 1000$  kg/m<sup>3</sup>

Ambient Temperature: 22.5°C, Liquid Temperature: 22.3°C

Communication System: LTE2500-FDD7 2560 MHz Duty Cycle: 1:1

Probe: EX3DV4 – SN7514 ConvF(7.06,7.06,7.06)

**Area Scan (71x121x1):** Interpolated grid: dx=1.000 mm, dy=1.000 mm

Maximum value of SAR (interpolated) = 1.81 W/kg

**Zoom Scan (7x7x7)/Cube 0:** Measurement grid: dx=5mm, dy=5mm, dz=5mm

Reference Value = 3.055 V/m; Power Drift = -0.02 dB

Peak SAR (extrapolated) = 2.19 W/kg

**SAR(1 g) = 1.03 W/kg; SAR(10 g) = 0.481 W/kg**

Maximum value of SAR (measured) = 1.67 W/kg

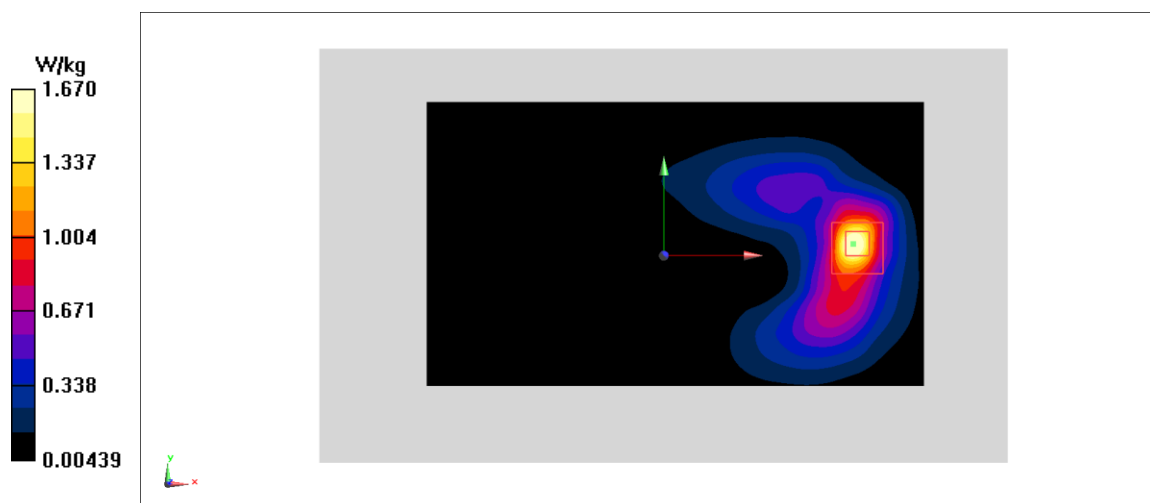

**Fig A.15**

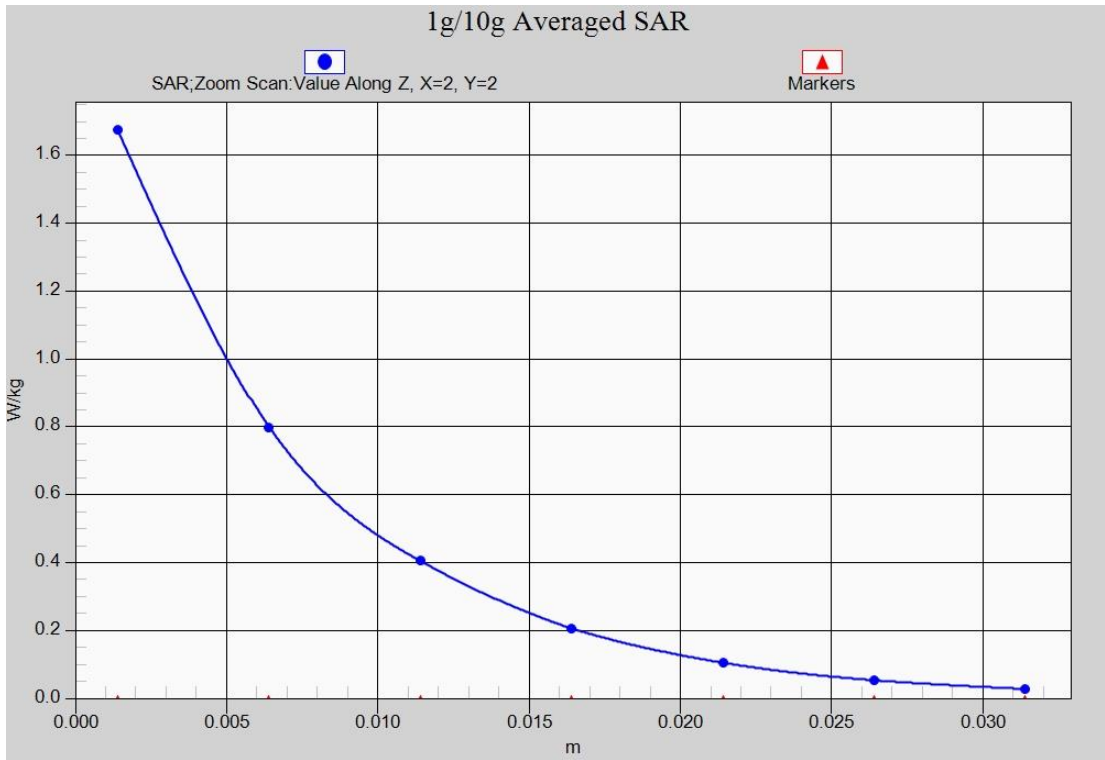

**Fig. 15-1 Z-Scan at power reference point (LTE Band7)**

**LTE700-FDD12\_CH23131 Left Tilt**

Date: 8/6/2019

Electronics: DAE4 Sn771

Medium: head 750 MHz

Medium parameters used:  $f = 711.1$  MHz;  $\sigma = 0.858$  mho/m;  $\epsilon_r = 42.76$ ;  $\rho = 1000$  kg/m<sup>3</sup>

Ambient Temperature: 22.5°C, Liquid Temperature: 22.3°C

Communication System: LTE700-FDD12 711.1 MHz Duty Cycle: 1:1

Probe: EX3DV4 – SN7514 ConvF(9.47,9.47,9.47)

**Area Scan (71x121x1):** Interpolated grid: dx=1.000 mm, dy=1.000 mm

Maximum value of SAR (interpolated) = 0.722 W/kg

**Zoom Scan (7x7x7)/Cube 0:** Measurement grid: dx=5mm, dy=5mm, dz=5mm

Reference Value = 27.77 V/m; Power Drift = 0.07 dB

Peak SAR (extrapolated) = 1 W/kg

**SAR(1 g) = 0.58 W/kg; SAR(10 g) = 0.381 W/kg**

Maximum value of SAR (measured) = 0.766 W/kg

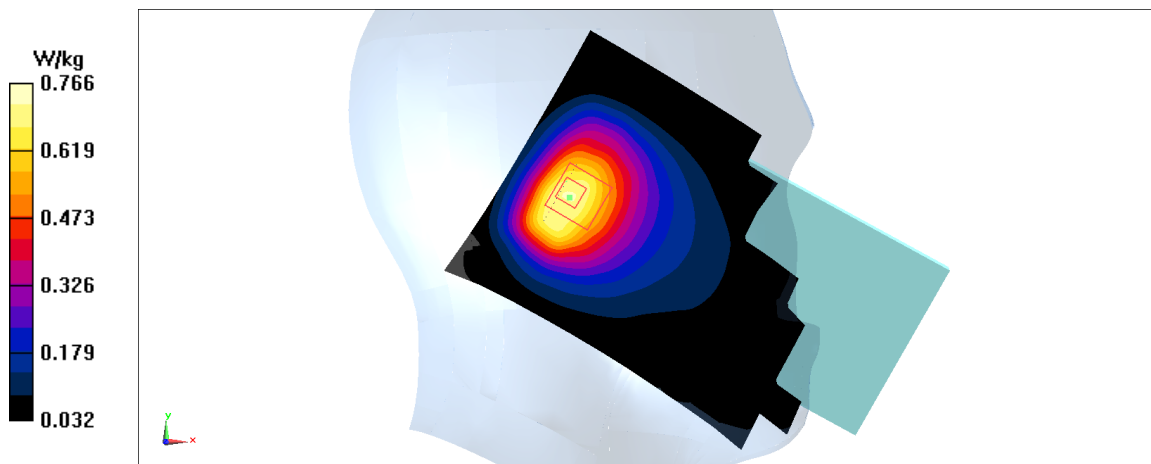

**Fig A.16**

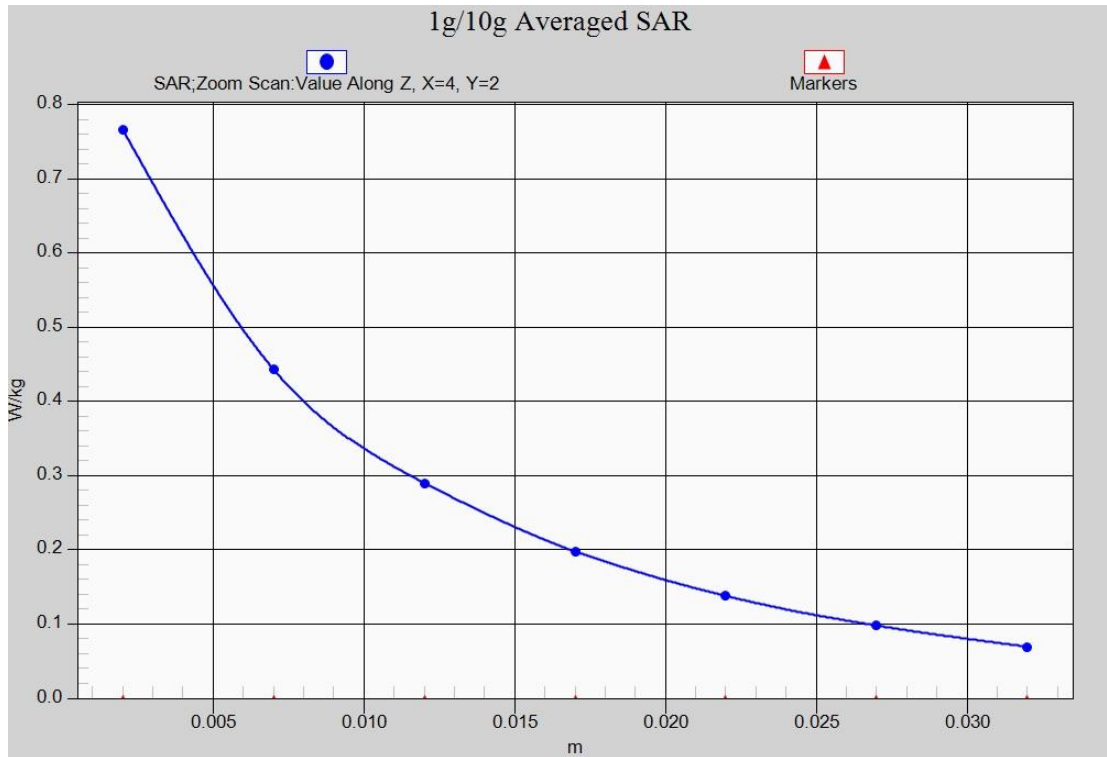

**Fig. 16-1 Z-Scan at power reference point (LTE Band12)**

**LTE700-FDD12\_CH23130 Rear**

Date: 8/6/2019

Electronics: DAE4 Sn771

Medium: body 750 MHz

Medium parameters used:  $f = 711$  MHz;  $\sigma = 0.92$  mho/m;  $\epsilon_r = 54.69$ ;  $\rho = 1000$  kg/m<sup>3</sup>

Ambient Temperature: 22.5°C, Liquid Temperature: 22.3°C

Communication System: LTE700-FDD12 711 MHz Duty Cycle: 1:1

Probe: EX3DV4 – SN7514 ConvF(9.68,9.68,9.68)

**Area Scan (71x121x1):** Interpolated grid: dx=1.000 mm, dy=1.000 mm

Maximum value of SAR (interpolated) = 0.422 W/kg

**Zoom Scan (7x7x7)/Cube 0:** Measurement grid: dx=5mm, dy=5mm, dz=5mm

Reference Value = 17.66 V/m; Power Drift = -0.01 dB

Peak SAR (extrapolated) = 0.492 W/kg

**SAR(1 g) = 0.275 W/kg; SAR(10 g) = 0.175 W/kg**

Maximum value of SAR (measured) = 0.375 W/kg

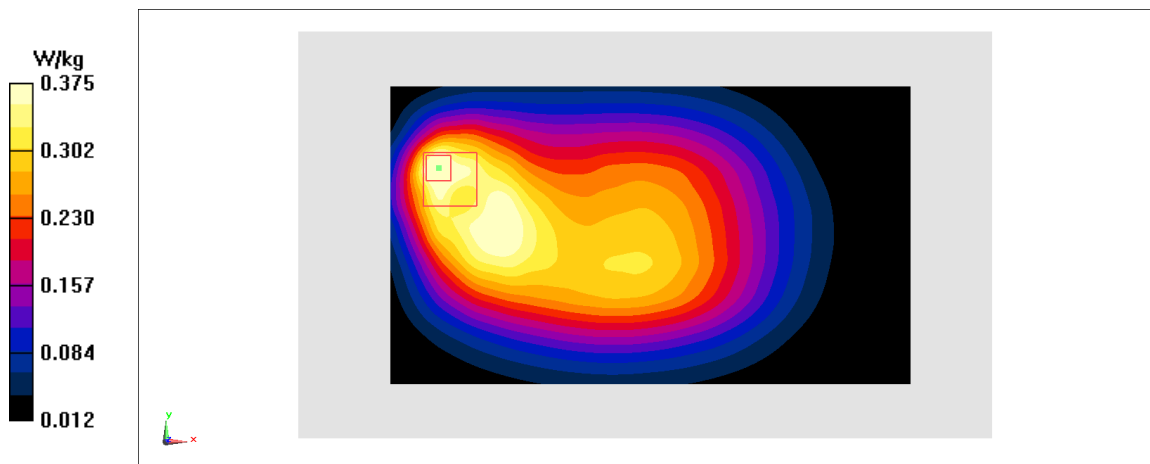

**Fig A.17**



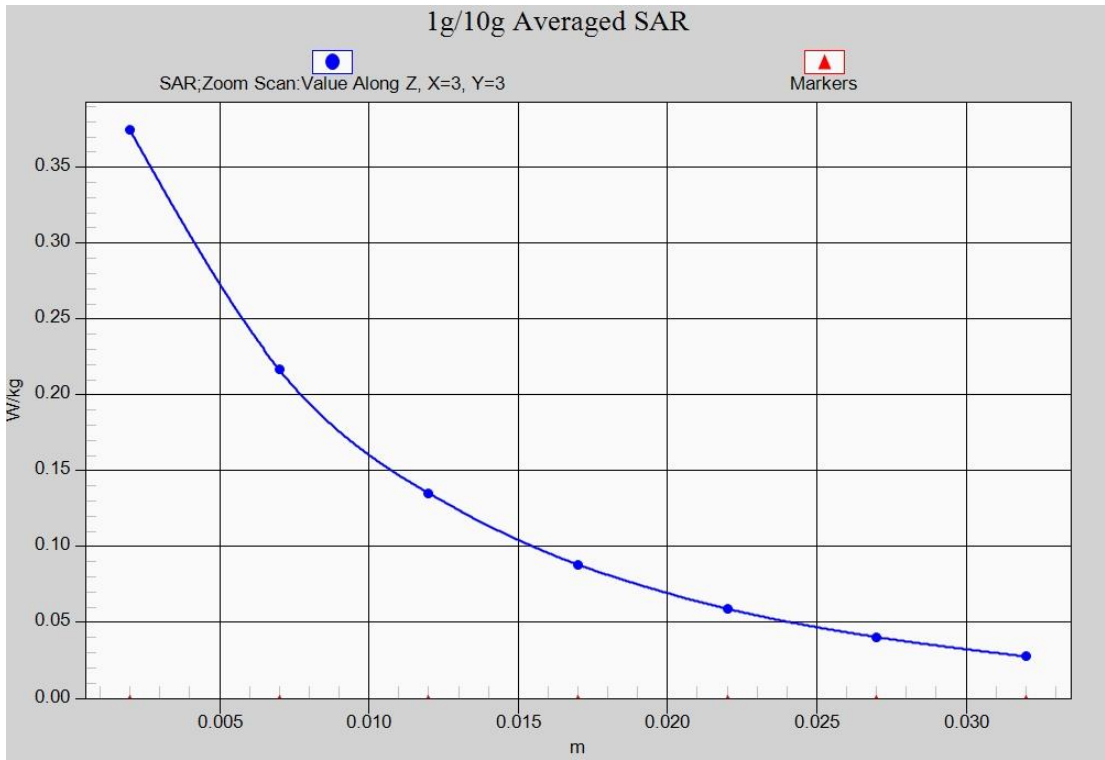

**Fig. 17-1 Z-Scan at power reference point (LTE Band12)**