



Test Report No.: RF190118W006-7



FCC TEST REPORT (PART 27)

Applicant:	TCL Communication Ltd.
Address:	7/F, Block F4, TCL Communication Technology Building, TCL International E City, Zhong Shan Yuan Road, Nanshan District, Shenzhen, Guangdong, P.R. China 518052

Manufacturer or Supplier:	TCL Communication Ltd.
Address:	7/F, Block F4, TCL Communication Technology Building, TCL International E City, Zhong Shan Yuan Road, Nanshan District, Shenzhen, Guangdong, P.R. China 518052
Product:	LTE/UMTS/GSM Smartphone
Brand Name:	Alcatel
Model Name:	5024A
FCC ID:	2ACCJB107
Date of tests:	Jan. 19, 2019 ~ Feb. 20, 2019

The tests have been carried out according to the requirements of the following standard:

- FCC Part 27, Subpart C, L ANSI/TIA/EIA-603- D
- FCC Part 2 ANSI/TIA/EIA-603-E ANSI C63.26-2015

CONCLUSION: The submitted sample was found to COMPLY with the test requirement

Prepared by Roger Li Engineer / Mobile Department	Approved by Sam Tung Manager / Mobile Department
Date: Feb. 21, 2019	Date: Feb. 21, 2019

This report is governed by, and incorporates by reference, CPS Conditions of Service as posted at the date of issuance of this report at <http://www.bureauveritas.com/home/about-us/our-business/cps/about-us/terms-conditions> and is intended for your exclusive use. Any copying or replication of this report to or for any other person or entity, or use of our name or trademark, is permitted only with our prior written permission. This report sets forth our findings solely with respect to the test samples identified herein. The results set forth in this report are not indicative or representative of the quality or characteristics of the lot from which a test sample was taken or any similar or identical product unless specifically and expressly noted. Our report includes all of the tests requested by you and the results thereof based upon the information that you provided to us. Measurement uncertainty is only provided upon request for accredited tests. You have 60 days from date of issuance of this report to notify us of any material error or omission caused by our negligence or if you require measurement uncertainty; provided, however, that such notice shall be in writing and shall specifically address the issue you wish to raise. A failure to raise such issue within the prescribed time shall constitute your unqualified acceptance of the completeness of this report, the tests conducted and the correctness of the report contents.



TABLE OF CONTENTS

RELEASE CONTROL RECORD	4
1 SUMMARY OF TEST RESULTS	5
1.1 MEASUREMENT UNCERTAINTY	5
1.2 TEST SITE AND INSTRUMENTS	6
2 GENERAL INFORMATION.....	7
2.1 GENERAL DESCRIPTION OF EUT.....	7
2.2 CONFIGURATION OF SYSTEM UNDER TEST	9
2.3 DESCRIPTION OF SUPPORT UNITS.....	10
2.4 DESCRIPTION OF TEST MODES.....	10
2.5 GENERAL DESCRIPTION OF APPLIED STANDARDS.....	13
3 TEST TYPES AND RESULTS	14
3.1 OUTPUT POWER MEASUREMENT	14
3.1.1 LIMITS OF OUTPUT POWER MEASUREMENT.....	14
3.1.2 TEST PROCEDURES	14
3.1.3 TEST SETUP.....	15
3.1.4 TEST RESULTS	16
3.2 FREQUENCY STABILITY MEASUREMENT	28
3.2.1 LIMITS OF FREQUENCY STABILITY MEASUREMENT.....	28
3.2.2 TEST PROCEDURE.....	28
3.2.3 TEST SETUP.....	28
3.2.4 TEST RESULTS	29
3.3 OCCUPIED BANDWIDTH MEASUREMENT	35
3.3.1 LIMITS OF OCCUPIED BANDWIDTH MEASUREMENT	35
3.3.2 TEST SETUP.....	35
3.3.3 TEST PROCEDURES	35
3.3.4 TEST RESULTS	36
3.4 PEAK TO AVERAGE RATIO	42
3.4.1 LIMITS OF PEAK TO AVERAGE RATIO MEASUREMENT.....	42
3.4.2 TEST SETUP.....	42
3.4.3 TEST PROCEDURES	42
3.4.4 TEST RESULTS	43
3.5 BAND EDGE MEASUREMENT	49
3.5.1 LIMITS OF BAND EDGE MEASUREMENT	49
3.5.2 TEST SETUP.....	49
3.5.3 TEST PROCEDURES	50
3.5.4 TEST RESULTS	51
3.6 CONDUCTED SPURIOUS EMISSIONS.....	69
3.6.1 LIMITS OF CONDUCTED SPURIOUS EMISSIONS MEASUREMENT	69
3.6.2 TEST PROCEDURE.....	69
3.6.3 TEST SETUP.....	69
3.6.4 TEST RESULTS	70
3.7 RADIATED EMISSION MEASUREMENT.....	76
3.7.1 LIMITS OF RADIATED EMISSION MEASUREMENT	76
3.7.2 TEST PROCEDURES	76
3.7.3 DEVIATION FROM TEST STANDARD	76
3.7.4 TEST SETUP.....	77
3.7.5 TEST RESULTS	79



Test Report No.: RF190118W006-7

4	INFORMATION ON THE TESTING LABORATORIES	97
5	APPENDIX A – MODIFICATIONS RECORDERS FOR ENGINEERING CHANGES TO THE EUT BY THE LAB	98



Test Report No.: RF190118W006-7

RELEASE CONTROL RECORD

ISSUE NO.	REASON FOR CHANGE	DATE ISSUED
RF190118W006-7	Original release	Feb. 21, 2019



1 SUMMARY OF TEST RESULTS

The EUT has been tested according to the following specifications:

APPLIED STANDARD: FCC Part 27 & Part 2			
STANDARD SECTION	TEST TYPE AND LIMIT	RESULT	REMARK
2.1046 27.50(d)(4)	Maximum Peak Output Power	PASS	Meet the requirement of limit.
2.1055 27.54	Frequency Stability	PASS	Meet the requirement of limit.
2.1049 27.53(h)	Occupied Bandwidth	PASS	Meet the requirement of limit.
27.50(d)(5)	Peak to average ratio	PASS	Meet the requirement of limit.
27.53(h)	Band Edge Measurements	PASS	Meet the requirement of limit.
2.1051 27.53(h)	Conducted Spurious Emissions	PASS	Meet the requirement of limit.
2.1053 27.53(h)	Radiated Spurious Emissions	PASS	Meet the requirement of limit. Minimum passing margin is -33.16dB at 42.350MHz.

1.1 MEASUREMENT UNCERTAINTY

Where relevant, the following measurement uncertainty levels have been estimated for tests performed on the EUT as specified in CISPR 16-4-2:

MEASUREMENT	UNCERTAINTY
Maximum Peak Output Power	±1dB
Frequency Stability	± 39.27Hz
Radiated emissions	±4.48dB
Conducted emissions	±2 dB
Occupied Channel Bandwidth	±21.7KHz
Band Edge Measurements	±4.48dB
Peak to average ratio	±0.76dB

This uncertainty represents an expanded uncertainty expressed at approximately the 95% confidence level using a coverage factor of k=2.



Test Report No.: RF181119W003-7

1.2 TEST SITE AND INSTRUMENTS

Equipment	Manufacturer	Model No.	Serial No.	Last Cal.	Next Cal.
MXE EMI Receiver	KEYSIGHT	N9038A-544	MY54450026	Mar. 16,18	Mar. 15,19
EXA Signal Analyzer	KEYSIGHT	N9010A-526	MY54510322	Mar. 16,18	Mar. 15,19
Bilog Antenna 1	ETS-LINDGREN	3143B	00161964	Mar. 15,18	Mar. 14,19
Bilog Antenna 2	ETS-LINDGREN	3143B	00161965	Mar. 15,18	Mar. 14,19
Horn Antenna 1	ETS-LINDGREN	3117	00168728	Mar. 15,18	Mar. 14,19
Horn Antenna 2	ETS-LINDGREN	3117	00168692	Nov. 30, 18	Nov. 29, 19
Loop antenna	Daze	ZN30900A	0708	Oct. 23,18	Oct. 22, 19
Horn Antenna (18GHz-40GHz)	N/A	QWH-SL-18-40-K-SG/QMS-00361	15433	Nov. 21, 18	Nov. 20, 19
Radio Communication Analyzer	ANRITSU	MT8820C	6201465426	Mar. 02,18	Mar. 01,19
Signal Pre-Amplifier	EMSI	EMC 9135	980249	Jul. 09,18	Jul. 08,19
Signal Pre-Amplifier	EMSI	EMC 012645B	980257	Jul. 09,18	Jul. 08,19
Signal Pre-Amplifier	EMSI	EMC 184045B	980259	Jul. 09,18	Jul. 08,19
3m Semi-anechoic Chamber	ETS-LINDGREN	9m*6m*6m	Euroshieldpn-CT0001143-1216	Apr. 21,18	Apr. 20,19
Test Software	E3	V 9.160323	N/A	N/A	N/A
Test Software	ADT	ADT_Radiated_V7.6.15.9.2	N/A	N/A	N/A
10dB Attenuator	JFW/USA	50HF-010-SMA	1505	Jul. 09,18	Jul. 08,19
Power Meter	Anritsu	ML2495A	1506002	Mar. 02,18	Mar. 01,19
Power Sensor	Anritsu	MA2411B	1339352	Mar. 16,18	Mar. 15,19
Humid & Temp Programmable Tester	Juyi	ITH-120-45-CP-AR	IAA1504-001	Jul. 09,18	Jul. 08,19
MXG Analog Microwave Signal Generator	KEYSIGHT	N5183A	MY50143024	Mar. 13,18	Mar. 12,19

- NOTE:**
1. The calibration interval of the above test instruments is 12 months or 24 months and the calibrations are traceable to CEPREI/CHINA, GRGT/CHINA and NIM/CHINA.
 2. The test was performed in 3m Semi-anechoic Chamber and RF Oven Room.
 3. The horn antenna is used only for the measurement of emission frequency above 1GHz if tested.
 4. The FCC Site Registration No. is 525120; The Designation No. is CN1171.



2 GENERAL INFORMATION

2.1 GENERAL DESCRIPTION OF EUT

PRODUCT	LTE/UMTS/GSM Smartphone	
BRAND NAME	Alcatel	
MODEL NAME	5024A	
POWER SUPPLY	5.0Vdc (adapter or host equipment) 3.85Vdc (Li-ion, battery)	
MODULATION TECHNOLOGY	LTE	QPSK, 16QAM, 64QAM
FREQUENCY RANGE	LTE Band 66 Channel Bandwidth: 1.4MHz	1710.7MHz ~ 1779.3MHz
	LTE Band 66 Channel Bandwidth: 3MHz	1711.5MHz ~ 1778.5MHz
	LTE Band 66 Channel Bandwidth: 5MHz	1712.5MHz ~ 1777.5MHz
	LTE Band 66 Channel Bandwidth: 10MHz	1715.0MHz ~ 1775.0MHz
	LTE Band 66 Channel Bandwidth: 15MHz	1717.5MHz ~ 1772.5MHz
	LTE Band 66 Channel Bandwidth: 20MHz	1720.0MHz ~ 1770.0MHz
EMISSION DESIGNATOR	LTE Band 66 Channel Bandwidth: 1.4MHz	QPSK: 1M09G7D
		16QAM: 1M09W7D
		64QAM: 1M09W7D
	LTE Band 66 Channel Bandwidth: 3MHz	QPSK: 2M69G7D
		16QAM: 2M69W7D
		64QAM: 2M69W7D
	LTE Band 66 Channel Bandwidth: 5MHz	QPSK: 4M47G7D
		16QAM: 4M47W7D
		64QAM: 4M48W7D
	LTE Band 66 Channel Bandwidth: 10MHz	QPSK: 8M96G7D
		16QAM: 8M92W7D
		64QAM: 8M94W7D
	LTE Band 66 Channel Bandwidth: 15MHz	QPSK: 13M4G7D
		16QAM: 13M4W7D
		64QAM: 13M4W7D
	LTE Band 66 Channel Bandwidth: 20MHz	QPSK: 17M9G7D
		16QAM: 17M9W7D
		64QAM: 17M9W7D



Test Report No.: RF181119W003-7

MAX. ERP/EIRP POWER	LTE Band 66 Channel Bandwidth: 1.4MHz	188mW
	LTE Band 66 Channel Bandwidth: 3MHz	185mW
	LTE Band 66 Channel Bandwidth: 5MHz	184mW
	LTE Band 66 Channel Bandwidth: 10MHz	186mW
	LTE Band 66 Channel Bandwidth: 15MHz	181mW
	LTE Band 66 Channel Bandwidth: 20MHz	157mW
ANTENNA TYPE	IFIA Antenna with 0.47dBi	
HW VERSION	PIO	
SW VERSION	V1.0	
ACCESSORY DEVICE	Refer to note as below	
DATA CABLE	USB cable: non-shielded, detachable, 1.5m Earphone cable: non-shielded, detachable, 1.4m	

NOTE:

1. For a more detailed features description, please refer to the manufacturer's specifications or the user's manual.
2. For the test results, the EUT had been tested with all conditions. But only the worst case was shown in test report.

List of Accessories:

ACCESSORIES	BRAND	MODEL	Manufacturer	SPECIFICATION
AC Adapter 1	alcatel	UC11US	PUAN	I/P:100-240Vac, 0.2A O/P: 5Vdc, 1A
AC Adapter 2	alcatel	UC11US	chenyang	I/P:100-240Vac, 0.2A O/P: 5Vdc, 1A
Battery 1	alcatel	TLp030K7	VEKEN	Rating: 3.85Vdc, 3000mAh
Battery 2	alcatel	TLp030KA	Tianmao	Rating: 3.85Vdc, 3000mAh
USB Cable 1	alcatel	N/A	JUWEI	1.5m shielded cable w/o core
USB Cable 2	alcatel	N/A	shenghua	1.5m shielded cable w/o core
Earphone	alcatel	N/A	JUWEI	1.4m shielded cable w/o core

2.2 CONFIGURATION OF SYSTEM UNDER TEST

FOR RADIATION EMISSION TEST

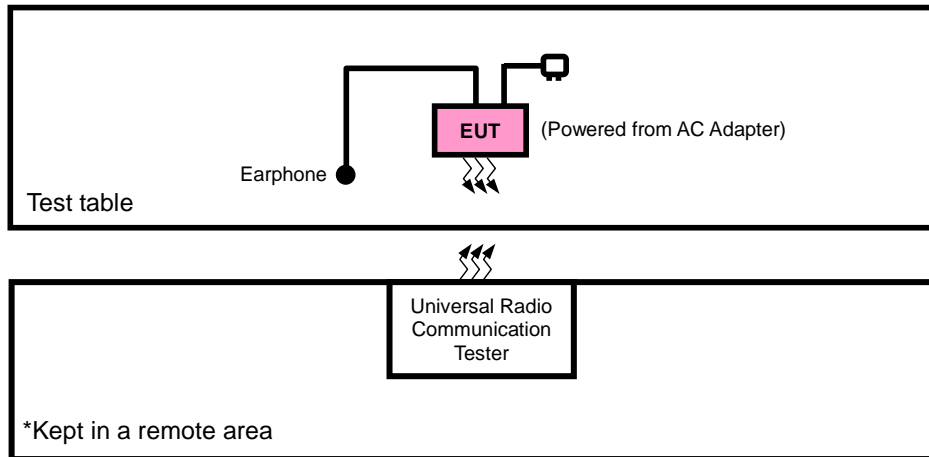

FOR CONDUCTED & E.I.R.P TEST

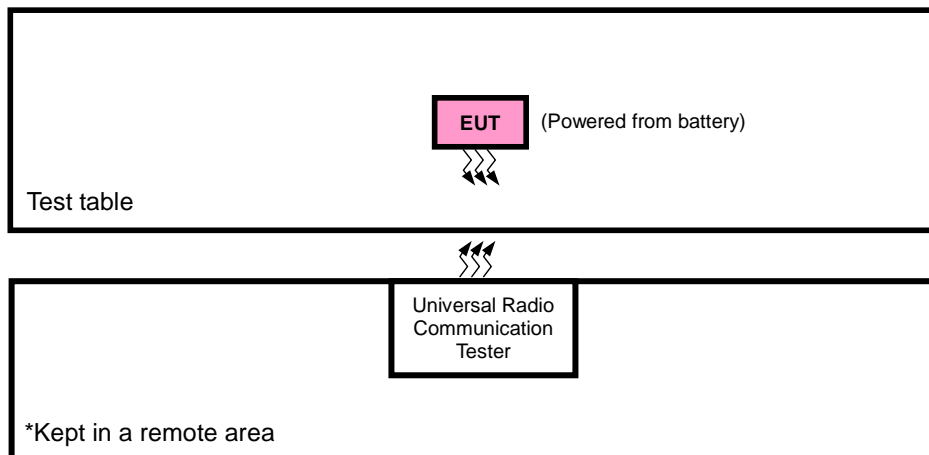



2.3 DESCRIPTION OF SUPPORT UNITS

The EUT has been tested as an independent unit together with other necessary accessories or support units. The following support units or accessories were used to form a representative test configuration during the tests.

NO.	PRODUCT	BRAND	MODEL NO.	SERIAL NO.	FCC ID
1	DC source	LONG WEI	PS-6403D	010934269	N/A
2	PC	HP	A6608CN	3CR83825X3	N/A

NO.	SIGNAL CABLE DESCRIPTION OF THE ABOVE SUPPORT UNITS
1	DC Line: Unshielded, Detachable 1.0m
2	AC Line: Unshielded, Detachable 1.5m

NOTE:

- 1. All power cords of the above support units are non shielded (1.8m).

2.4 DESCRIPTION OF TEST MODES

Pre-Scan has been conducted to determine the worst-case mode from all possible combinations between available modulations, data rates, XYZ axis and antenna ports. The worst case in ERP/EIRP and radiated emission was found when positioned on X-plane for LTE. Following channel(s) was (were) selected for the final test as listed below:

EUT CONFIGURE MODE	DESCRIPTION
A	EUT + Adapter + USB Cable+ Earphone + with LTE link
B	EUT + Battery with LTE link



Test Report No.: RF181119W003-7

LTE BAND 66

EUT CONFIGURE MODE	TEST ITEM	AVAILABLE CHANNEL	TESTED CHANNEL	CHANNEL BANDWIDTH	MODULATION	MODE
B	EIRP	131979 to 132665	131979, 132322, 132665	1.4MHz	QPSK, 16QAM, 64QAM	1 RB / 0 RB Offset
		131987 to 132657	131987, 132322, 132657	3MHz	QPSK, 16QAM, 64QAM	1 RB / 0 RB Offset
		131997 to 132647	131997, 132322, 132647	5MHz	QPSK, 16QAM, 64QAM	1 RB / 0 RB Offset
		132022 to 132622	132022, 132322, 132622	10MHz	QPSK, 16QAM, 64QAM	1 RB / 0 RB Offset
		132047 to 132597	132047, 132322, 132597	15MHz	QPSK, 16QAM, 64QAM	1 RB / 0 RB Offset
		132072 to 132572	132072, 132322, 132572	20MHz	QPSK, 16QAM, 64QAM	1 RB / 0 RB Offset
B	FREQUENCY STABILITY	131979 to 132665	131979, 132665	1.4MHz	QPSK	1 RB / 0 RB Offset
		131987 to 132657	131987, 132657	3MHz	QPSK	1 RB / 0 RB Offset
		131997 to 132647	131997, 132647	5MHz	QPSK	1 RB / 0 RB Offset
		132022 to 132622	132022, 132622	10MHz	QPSK	1 RB / 0 RB Offset
		132047 to 132597	132047, 132597	15MHz	QPSK	1 RB / 0 RB Offset
		132072 to 132572	132072, 132572	20MHz	QPSK	1 RB / 0 RB Offset
B	OCCUPIED BANDWIDTH	131979 to 132665	131979, 132322, 132665	1.4MHz	QPSK, 16QAM, 64QAM	6 RB / 0 RB Offset
		131987 to 132657	131987, 132322, 132657	3MHz	QPSK, 16QAM, 64QAM	15 RB / 0 RB Offset
		131997 to 132647	131997, 132322, 132647	5MHz	QPSK, 16QAM, 64QAM	25 RB / 0 RB Offset
		132022 to 132622	132022, 132322, 132622	10MHz	QPSK, 16QAM, 64QAM	50 RB / 0 RB Offset
		132047 to 132597	132047, 132322, 132597	15MHz	QPSK, 16QAM, 64QAM	75 RB / 0 RB Offset
		132072 to 132572	132072, 132322, 132572	20MHz	QPSK, 16QAM, 64QAM	100 RB / 0 RB Offset
B	PEAK TO AVERAGE RATIO	131979 to 132665	131979, 132322, 132665	1.4MHz	QPSK, 16QAM, 64QAM	1 RB / 0 RB Offset
		131987 to 132657	131987, 132322, 132657	3MHz	QPSK, 16QAM, 64QAM	1 RB / 0 RB Offset
		131997 to 132647	131997, 132322, 132647	5MHz	QPSK, 16QAM, 64QAM	1 RB / 0 RB Offset
		132022 to 132622	132022, 132322, 132622	10MHz	QPSK, 16QAM, 64QAM	1 RB / 0 RB Offset
		132047 to 132597	132047, 132322, 132597	15MHz	QPSK, 16QAM, 64QAM	1 RB / 0 RB Offset
		132072 to 132572	132072, 132322, 132572	20MHz	QPSK, 16QAM, 64QAM	1 RB / 0 RB Offset



Test Report No.: RF181119W003-7

B	BAND EDGE	131979 to 132665	131979	1.4MHz	QPSK, 16QAM, 64QAM	1 RB / 0 RB Offset
			132665	1.4MHz	QPSK, 16QAM, 64QAM	6 RB / 0 RB Offset
		131987 to 132657	131987	3MHz	QPSK, 16QAM, 64QAM	1 RB / 5 RB Offset
			132657	3MHz	QPSK, 16QAM, 64QAM	6 RB / 0 RB Offset
		131997 to 132647	131997	5MHz	QPSK, 16QAM, 64QAM	1 RB / 0 RB Offset
			132647	5MHz	QPSK, 16QAM, 64QAM	15 RB / 0 RB Offset
		132022 to 132622	131997	5MHz	QPSK, 16QAM, 64QAM	1 RB / 14 RB Offset
			132647	5MHz	QPSK, 16QAM, 64QAM	15 RB / 0 RB Offset
		132022 to 132622	132022	10MHz	QPSK, 16QAM, 64QAM	1 RB / 0 RB Offset
			132622	10MHz	QPSK, 16QAM, 64QAM	25 RB / 0 RB Offset
		132022 to 132622	132022	10MHz	QPSK, 16QAM, 64QAM	1 RB / 24 RB Offset
			132622	10MHz	QPSK, 16QAM, 64QAM	25 RB / 0 RB Offset
B	BAND EDGE	132047 to 132597	132047	15MHz	QPSK, 16QAM, 64QAM	1 RB / 0 RB Offset
			132597	15MHz	QPSK, 16QAM, 64QAM	75 RB / 0 RB Offset
		132072 to 132572	132072	20MHz	QPSK, 16QAM, 64QAM	1 RB / 74 RB Offset
			132572	20MHz	QPSK, 16QAM, 64QAM	75 RB / 0 RB Offset
		132072 to 132572	132072	20MHz	QPSK, 16QAM, 64QAM	1 RB / 0 RB Offset
		132072 to 132572	132572	20MHz	QPSK, 16QAM, 64QAM	100 RB / 0 RB Offset
B	CONDCUETED EMISSION	131979 to 132665	131979, 132322, 132665	1.4MHz	QPSK	1 RB / 0 RB Offset
		131987 to 132657	131987, 132322, 132657	3MHz	QPSK	1 RB / 0 RB Offset
		131997 to 132647	131997, 132322, 132647	5MHz	QPSK	1 RB / 0 RB Offset
		132022 to 132622	132022, 132322, 132622	10MHz	QPSK	1 RB / 0 RB Offset
		132047 to 132597	132047, 132322, 132597	15MHz	QPSK	1 RB / 0 RB Offset
		132072 to 132572	132072, 132322, 132572	20MHz	QPSK	1 RB / 0 RB Offset
A	RADIATED EMISSION	131979 to 132665	132322	1.4MHz	QPSK	1 RB / 0 RB Offset
		131987 to 132657	132322	3MHz	QPSK	1 RB / 0 RB Offset
		131997 to 132647	131997, 132322, 132647	5MHz	QPSK	1 RB / 0 RB Offset
		132022 to 132622	132322	10MHz	QPSK	1 RB / 0 RB Offset
		132047 to 132597	132322	15MHz	QPSK	1 RB / 0 RB Offset
		132072 to 132572	132322	20MHz	QPSK	1 RB / 0 RB Offset

Note: This device was tested under all bandwidths, RB configurations and modulations. The worst case was found in QPSK modulation.



Test Report No.: RF181119W003-7

TEST CONDITION:

TEST ITEM	ENVIRONMENTAL CONDITIONS	INPUT POWER	TESTED BY
EIRP(ERP)	24deg. C, 60%RH	3.85Vdc from Battery	Rose Ma
FREQUENCY STABILITY	24deg. C, 61%RH	DC 3.5V/3.8V/4.4V	Rain Wang
OCCUPIED BANDWIDTH	24deg. C, 61%RH	3.85Vdc from Battery	Rain Wang
PEAK TO AVERAGE RATIO	24deg. C, 61%RH	3.85Vdc from Battery	Rain Wang
BAND EDGE	24deg. C, 61%RH	3.85Vdc from Battery	Rain Wang
CONDCUDED EMISSION	24deg. C, 61%RH	3.85Vdc from Battery	Rain Wang
RADIATED EMISSION	23deg. C, 70%RH	DC 5V from adaptor	Rose Ma

2.5 GENERAL DESCRIPTION OF APPLIED STANDARDS

The EUT is a RF product. According to the specifications of the manufacturer, it must comply with the requirements of the following standards:

FCC 47 CFR Part 2

FCC 47 CFR Part 27

KDB 971168 D01 Power Meas License Digital Systems v03r01

ANSI/TIA/EIA-603-D

ANSI/TIA/EIA-603-E

ANSI C63.26-2015

NOTE: All test items have been performed and recorded as per the above standards.



3 TEST TYPES AND RESULTS

3.1 OUTPUT POWER MEASUREMENT

3.1.1 LIMITS OF OUTPUT POWER MEASUREMENT

Fixed, mobile, and portable (hand-held) stations operating in the 1710–1780 MHz band are limited to 1 watt EIRP.

3.1.2 TEST PROCEDURES

EIRP / ERP MEASUREMENT:

- a. The EUT was set up for the maximum power with LTE link data modulation. The power was measured with R&S Spectrum Analyzer. All measurements were done at 3 channels (low, middle and high operational frequency range). RBW and VBW is 10MHz for LTE.
- b. E.I.R.P power measurement. In the semi-anechoic chamber, EUT placed on the 0.8m height of Turn Table, rotated the table around 360 degrees to search the maximum radiation power and receiver antenna shall be rotated vertical and horizontal polarization and moved height from 1m to 4m to find the maximum polar radiated power. The “Read Value” is the spectrum reading the maximum power value.
- c. The substitution horn antenna is substituted for EUT at the same position and signals generator export the CW signal to the substitution antenna via a TX cable. Rotated the Turn Table and moved receiving antenna to find the maximum radiation power. Adjust output power level of S.G to get a Value of spectrum reading equal to “Read Value” of step a. Record the power level of S.G
- d. $EIRP = \text{Output power level of S.G} - \text{TX cable loss} + \text{Antenna gain of substitution horn}$
- e. $E.R.P = E.I.R.P - 2.15 \text{ dB}$

CONDUCTED POWER MEASUREMENT:

- a. The EUT was set up for the maximum power with LTE link data modulation and link up with simulator.
- b. Set the EUT to transmit under low, middle and high channel and record the power level shown on simulator.

3.1.3 TEST SETUP

ERP MEASUREMENT:

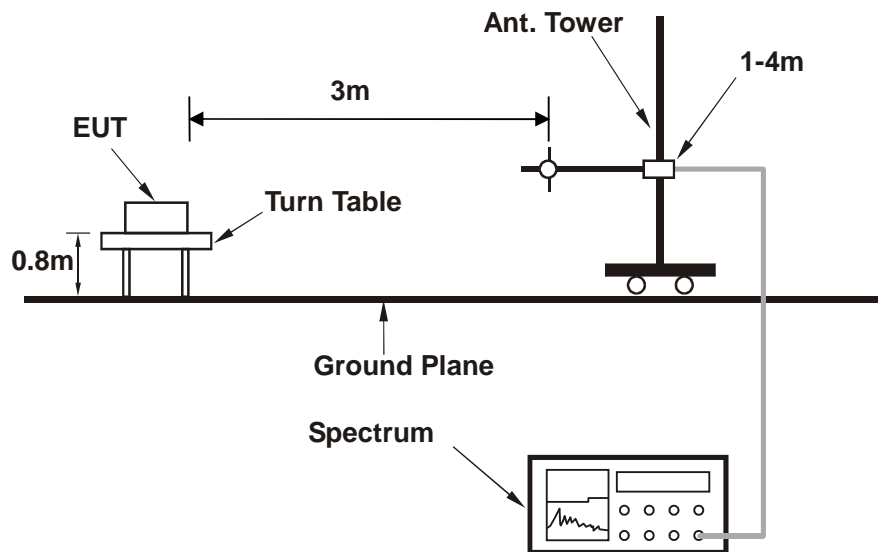

EIRP MEASUREMENT:

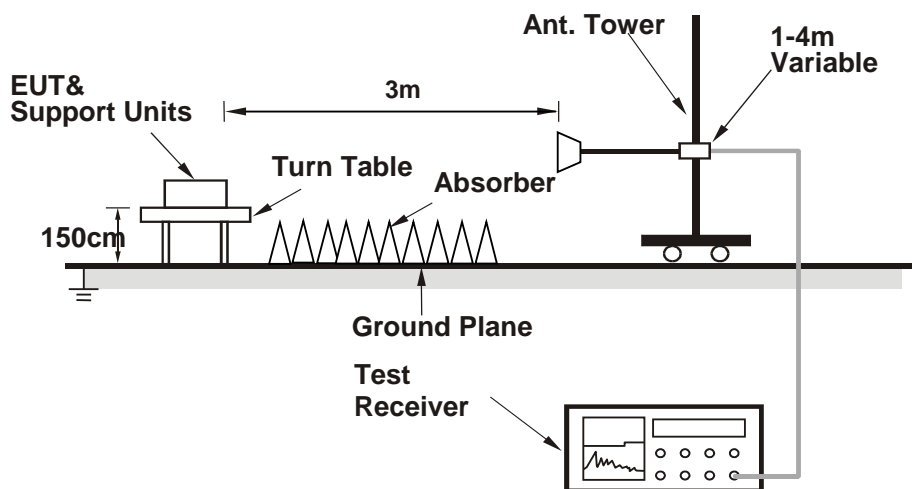

For the actual test configuration, please refer to the attached file (Test Setup Photo).

CONDUCTED POWER MEASUREMENT:

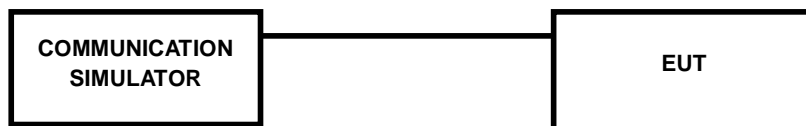

For the actual test configuration, please refer to the attached file (Test Setup Photo).



3.1.4 TEST RESULTS

AVERAGE CONDUCTED OUTPUT POWER (dBm)

LTE Band 66							
BW	Modulation	RB Size	RB Offset	Low CH 131979	Mid CH 132322	High CH 132665	MPR
				Frequency 1710.7 MHz	Frequency 1745 MHz	Frequency 1779.3 MHz	
1.4MHz	QPSK	1	0	22.30	22.41	22.38	0
		1	2	22.33	22.37	22.39	0
		1	5	22.28	22.30	22.30	0
		3	0	22.38	22.43	22.47	0
		3	1	22.51	22.57	22.49	0
		3	3	22.38	22.42	22.42	0
		6	0	21.44	21.46	21.48	1
	16QAM	1	0	21.62	21.67	21.67	1
		1	2	21.53	21.54	21.58	1
		1	5	21.42	21.46	21.51	1
		3	0	21.56	21.62	21.60	1
		3	1	21.43	21.57	21.51	1
		3	3	21.44	21.50	21.52	1
		6	0	20.49	20.60	20.55	2
	64QAM	1	0	21.75	21.84	21.85	2
		1	2	21.67	21.80	21.75	2
		1	5	21.67	21.68	21.72	2
		3	0	21.56	20.65	20.61	3
		3	1	21.54	20.65	20.59	3
		3	3	21.49	20.53	20.58	3
		6	0	20.53	20.59	20.57	3



Test Report No.: RF181119W003-7

LTE Band 66							
BW	Modulation	RB Size	RB Offset	Low CH 131987	Mid CH 132322	High CH 132657	MPR
				Frequency 1711.5 MHz	Frequency 1745 MHz	Frequency 1778.5 MHz	
3 MHz	QPSK	1	0	22.32	22.43	22.37	0
		1	7	22.29	22.38	22.39	0
		1	14	22.24	22.30	22.30	0
		8	0	21.37	21.46	21.47	1
		8	3	21.44	21.57	21.51	1
		8	7	21.35	21.49	21.46	1
		15	0	21.41	21.47	21.42	1
	16QAM	1	0	21.59	21.73	21.70	1
		1	7	21.50	21.57	21.56	1
		1	14	21.45	21.46	21.51	1
		8	0	20.52	20.63	20.60	2
		8	3	20.48	20.52	20.54	2
		8	7	20.46	20.48	20.48	2
		15	0	20.49	20.54	20.58	2
	64QAM	1	0	21.81	21.87	21.79	2
		1	7	21.70	21.74	21.74	2
		1	14	21.68	21.70	21.72	2
		8	0	20.59	20.69	20.62	3
		8	3	20.58	20.59	20.64	3
		8	7	20.46	20.57	20.54	3
		15	0	20.55	20.56	20.61	3



Test Report No.: RF181119W003-7

LTE Band 66							
BW	Modulation	RB Size	RB Offset	Low CH 131997	Mid CH 132322	High CH 132647	MPR
				Frequency 1712.5 MHz	Frequency 1745 MHz	Frequency 1777.5 MHz	
5 MHz	QPSK	1	0	22.33	22.38	22.38	0
		1	12	22.34	22.35	22.39	0
		1	24	22.25	22.29	22.34	0
		12	0	21.40	21.46	21.44	1
		12	6	21.44	21.58	21.52	1
		12	13	21.39	21.45	21.47	1
		25	0	21.39	21.50	21.45	1
	16QAM	1	0	21.60	21.69	21.70	1
		1	12	21.47	21.60	21.55	1
		1	24	21.45	21.46	21.50	1
		12	0	20.52	20.61	20.57	2
		12	6	20.45	20.56	20.50	2
		12	13	20.41	20.50	20.51	2
		25	0	20.49	20.55	20.55	2
	64QAM	1	0	21.75	21.84	21.85	2
		1	12	21.67	21.80	21.74	2
		1	24	21.61	21.75	21.72	2
		12	0	20.60	20.66	20.61	3
		12	6	20.52	20.66	20.63	3
		12	13	20.50	20.56	20.51	3
		25	0	20.51	20.62	20.59	3



Test Report No.: RF181119W003-7

LTE Band 66							
BW	Modulation	RB Size	RB Offset	Low CH 132022	Mid CH 132322	High CH 132622	MPR
				Frequency 1715 MHz	Frequency 1745 MHz	Frequency 1775 MHz	
10 MHz	QPSK	1	0	22.30	22.41	22.38	0
		1	24	22.34	22.35	22.40	0
		1	49	22.22	22.33	22.30	0
		25	0	21.41	21.45	21.47	1
		25	12	21.50	21.52	21.52	1
		25	25	21.37	21.42	21.46	1
		50	0	21.44	21.50	21.42	1
	16QAM	1	0	21.60	21.66	21.66	1
		1	24	21.52	21.56	21.58	1
		1	49	21.45	21.47	21.47	1
		25	0	20.54	20.59	20.63	2
		25	12	20.49	20.50	20.55	2
		25	25	20.40	20.51	20.48	2
		50	0	20.53	20.54	20.59	2
	64QAM	1	0	21.74	21.85	21.82	2
		1	24	21.72	21.76	21.78	2
		1	49	21.67	21.69	21.69	2
		25	0	20.58	20.63	20.67	3
		25	12	20.59	20.65	20.57	3
		25	25	20.49	20.53	20.53	3
		50	0	20.56	20.58	20.60	3



Test Report No.: RF181119W003-7

LTE Band 66							
BW	Modulation	RB Size	RB Offset	Low CH 132047	Mid CH 132322	High CH 132597	MPR
				Frequency 1717.5 MHz	Frequency 1745 MHz	Frequency 1772.5 MHz	
15 MHz	QPSK	1	0	22.37	22.41	22.35	0
		1	37	22.32	22.40	22.35	0
		1	74	22.28	22.36	22.31	0
		36	0	21.38	21.46	21.48	1
		36	19	21.51	21.57	21.52	1
		36	39	21.35	21.43	21.46	1
		75	0	21.44	21.48	21.47	1
	16QAM	1	0	21.64	21.73	21.66	1
		1	37	21.51	21.57	21.58	1
		1	74	21.41	21.52	21.49	1
		36	0	20.58	20.59	20.64	2
		36	19	20.43	20.54	20.51	2
		36	39	20.45	20.49	20.51	2
		75	0	20.54	20.57	20.52	2
	64QAM	1	0	21.76	21.86	21.83	2
		1	37	21.73	21.75	21.75	2
		1	74	21.63	21.68	21.72	2
		36	0	20.63	20.69	20.61	3
		36	19	20.53	20.59	20.59	3
		36	39	20.52	20.60	20.55	3
		75	0	20.55	20.56	20.61	3



Test Report No.: RF181119W003-7

LTE Band 66							
BW	Modulation	RB Size	RB Offset	Low CH 132072	Mid CH 132322	High CH 132572	MPR
				Frequency 1720 MHz	Frequency 1745 MHz	Frequency 1770 MHz	
20 MHz	QPSK	1	0	22.38	22.45	22.43	0
		1	50	22.36	22.43	22.41	0
		1	99	22.30	22.37	22.35	0
		50	0	21.44	21.51	21.49	1
		50	25	21.52	21.59	21.57	1
		50	50	21.43	21.50	21.48	1
		100	0	21.45	21.52	21.50	1
	16QAM	1	0	21.67	21.74	21.72	1
		1	50	21.55	21.62	21.60	1
		1	99	21.47	21.54	21.52	1
		50	0	20.60	20.67	20.65	2
		50	25	20.51	20.58	20.56	2
		50	50	20.48	20.55	20.53	2
		100	0	20.55	20.62	20.60	2
	64QAM	1	0	21.82	21.89	21.87	2
		1	50	21.75	21.82	21.80	2
		1	99	21.69	21.76	21.74	2
		50	0	20.64	20.71	20.69	3
		50	25	20.60	20.67	20.65	3
		50	50	20.54	20.61	20.59	3
		100	0	20.57	20.64	20.62	3



Test Report No.: RF181119W003-7

EIRP

LTE BAND 66

CHANNEL BANDWIDTH: 1.4MHz QPSK

Channel	Frequency (MHz)	SPA LVL (dBm)	Correction Factor(dB)	EIRP(dBm)	EIRP(mW)	Polarization (H/V)	LIMIT (W)
131979	1710.7	-19.67	41.29	21.62	145.34	H	1
132322	1745	-20.17	41.96	21.79	150.90	H	1
132665	1779.3	-20.54	43.27	22.73	187.50	H	1
131979	1710.7	-25.34	44.25	18.91	77.71	V	1
132322	1745.0	-24.64	43.88	19.24	83.98	V	1
132665	1779.3	-25.05	44.45	19.40	87.10	V	1

CHANNEL BANDWIDTH: 1.4MHz 16QAM

Channel	Frequency (MHz)	SPA LVL (dBm)	Correction Factor(dB)	EIRP(dBm)	EIRP(mW)	Polarization (H/V)	LIMIT (W)
131979	1710.7	-20.54	41.29	20.75	118.96	H	1
132322	1745	-21.10	41.96	20.86	121.81	H	1
132665	1779.3	-21.50	43.27	21.77	150.31	H	1
131979	1710.7	-26.21	44.25	18.04	63.61	V	1
132322	1745.0	-25.57	43.88	18.31	67.80	V	1
132665	1779.3	-26.01	44.45	18.44	69.82	V	1

CHANNEL BANDWIDTH: 1.4MHz 64QAM

Channel	Frequency (MHz)	SPA LVL (dBm)	Correction Factor(dB)	EIRP(dBm)	EIRP(mW)	Polarization (H/V)	LIMIT (W)
131979	1710.7	-21.77	41.29	19.52	89.62	H	1
132322	1745.0	-21.51	41.96	20.45	110.84	H	1
132665	1779.3	-22.42	43.27	20.85	121.62	H	1
131979	1710.7	-27.22	44.25	17.03	50.41	V	1
132322	1745.0	-26.76	43.88	17.12	51.55	V	1
132665	1779.3	-26.56	44.45	17.89	61.52	V	1



Test Report No.: RF181119W003-7

LTE BAND 66

CHANNEL BANDWIDTH: 3MHz QPSK

Channel	Frequency (MHz)	SPA LVL (dBm)	Correction Factor(dB)	EIRP(dBm)	EIRP(mW)	Polarization (H/V)	LIMIT (W)
131987	1711.5	-19.65	41.27	21.62	145.11	H	1
132322	1745	-20.23	41.96	21.73	148.83	H	1
132657	1778.5	-20.49	43.16	22.67	184.93	H	1
131987	1711.5	-25.32	44.26	18.94	78.38	V	1
132322	1745.0	-24.70	43.88	19.18	82.83	V	1
132657	1778.5	-25.00	44.37	19.37	86.50	V	1

CHANNEL BANDWIDTH: 3MHz 16QAM

Channel	Frequency (MHz)	SPA LVL (dBm)	Correction Factor(dB)	EIRP(dBm)	EIRP(mW)	Polarization (H/V)	LIMIT (W)
131987	1711.5	-20.72	41.27	20.55	113.42	H	1
132322	1745	-21.12	41.96	20.84	121.26	H	1
132657	1778.5	-21.48	43.16	21.68	147.23	H	1
131987	1711.5	-26.39	44.26	17.87	61.26	V	1
132322	1745.0	-25.59	43.88	18.29	67.48	V	1
132657	1778.5	-25.99	44.37	18.38	68.87	V	1

CHANNEL BANDWIDTH: 3MHz 64QAM

Channel	Frequency (MHz)	SPA LVL (dBm)	Correction Factor(dB)	EIRP(dBm)	EIRP(mW)	Polarization (H/V)	LIMIT (W)
131987	1711.5	-21.75	41.27	19.52	89.47	H	1
132322	1745.0	-21.57	41.96	20.39	109.32	H	1
132657	1778.5	-22.37	43.16	20.79	119.95	H	1
131987	1711.5	-27.20	44.26	17.06	50.84	V	1
132322	1745.0	-26.82	43.88	17.06	50.84	V	1
132657	1778.5	-26.51	44.37	17.86	61.09	V	1



Test Report No.: RF181119W003-7

LTE BAND 66

CHANNEL BANDWIDTH: 5MHz QPSK

Channel	Frequency (MHz)	SPA LVL (dBm)	Correction Factor(dB)	EIRP(dBm)	EIRP(mW)	Polarization (H/V)	LIMIT (W)
131997	1712.5	-19.71	41.39	21.68	147.20	H	1
132322	1745	-20.18	41.96	21.78	150.56	H	1
132647	1777.5	-20.44	43.09	22.65	184.08	H	1
131997	1712.5	-25.38	44.17	18.79	75.61	V	1
132322	1745.0	-24.65	43.88	19.23	83.79	V	1
132647	1777.5	-24.95	44.32	19.37	86.40	V	1

CHANNEL BANDWIDTH: 5MHz 16QAM

Channel	Frequency (MHz)	SPA LVL (dBm)	Correction Factor(dB)	EIRP(dBm)	EIRP(mW)	Polarization (H/V)	LIMIT (W)
131997	1712.5	-20.54	41.39	20.85	121.59	H	1
132322	1745	-21.20	41.96	20.76	119.04	H	1
132647	1777.5	-21.54	43.09	21.55	142.89	H	1
131997	1712.5	-26.21	44.17	17.96	62.46	V	1
132322	1745.0	-25.67	43.88	18.21	66.25	V	1
132647	1777.5	-26.05	44.32	18.27	67.07	V	1

CHANNEL BANDWIDTH: 5MHz 64QAM

Channel	Frequency (MHz)	SPA LVL (dBm)	Correction Factor(dB)	EIRP(dBm)	EIRP(mW)	Polarization (H/V)	LIMIT (W)
131997	1712.5	-21.81	41.39	19.58	90.76	H	1
132322	1745.0	-21.52	41.96	20.44	110.59	H	1
132647	1777.5	-22.32	43.09	20.77	119.40	H	1
131997	1712.5	-27.26	44.17	16.91	49.05	V	1
132322	1745.0	-26.77	43.88	17.11	51.43	V	1
132647	1777.5	-26.46	44.32	17.86	61.02	V	1



Test Report No.: RF181119W003-7

LTE BAND 66

CHANNEL BANDWIDTH: 10MHz QPSK

Channel	Frequency (MHz)	SPA LVL (dBm)	Correction Factor(dB)	EIRP(dBm)	EIRP(mW)	Polarization (H/V)	LIMIT (W)
132022	1715.0	-19.52	41.49	21.97	157.25	H	1
132322	1745	-20.12	41.96	21.84	152.65	H	1
132622	1775.0	-20.31	43.00	22.69	185.78	H	1
132022	1715.0	-25.19	44.06	18.87	77.14	V	1
132322	1745.0	-24.59	43.88	19.29	84.96	V	1
132622	1775.0	-24.82	44.26	19.44	87.90	V	1

CHANNEL BANDWIDTH: 10MHz 16QAM

Channel	Frequency (MHz)	SPA LVL (dBm)	Correction Factor(dB)	EIRP(dBm)	EIRP(mW)	Polarization (H/V)	LIMIT (W)
132022	1715.0	-20.67	41.49	20.82	120.67	H	1
132322	1745	-21.22	41.96	20.74	118.49	H	1
132622	1775.0	-21.47	43.00	21.53	142.23	H	1
132022	1715.0	-26.34	44.06	17.72	59.20	V	1
132322	1745.0	-25.69	43.88	18.19	65.95	V	1
132622	1775.0	-25.98	44.26	18.28	67.30	V	1

CHANNEL BANDWIDTH: 10MHz 64QAM

Channel	Frequency (MHz)	SPA LVL (dBm)	Correction Factor(dB)	EIRP(dBm)	EIRP(mW)	Polarization (H/V)	LIMIT (W)
132022	1715.0	-21.62	41.49	19.87	96.96	H	1
132322	1745.0	-21.46	41.96	20.50	112.12	H	1
132622	1775.0	-22.19	43.00	20.81	120.50	H	1
132022	1715.0	-27.07	44.06	16.99	50.04	V	1
132322	1745.0	-26.71	43.88	17.17	52.14	V	1
132622	1775.0	-26.33	44.26	17.93	62.09	V	1



LTE BAND 66

CHANNEL BANDWIDTH: 15MHz QPSK

Channel	Frequency (MHz)	SPA LVL (dBm)	Correction Factor(dB)	EIRP(dBm)	EIRP(mW)	Polarization (H/V)	LIMIT (W)
132047	1717.5	-19.53	41.34	21.81	151.64	H	1
132322	1745	-20.19	41.96	21.77	150.21	H	1
132597	1772.5	-20.38	42.96	22.58	181.13	H	1
132047	1717.5	-25.20	44.04	18.84	76.63	V	1
132322	1745.0	-24.66	43.88	19.22	83.60	V	1
132597	1772.5	-24.89	44.18	19.29	84.82	V	1

CHANNEL BANDWIDTH: 15MHz 16QAM

Channel	Frequency (MHz)	SPA LVL (dBm)	Correction Factor(dB)	EIRP(dBm)	EIRP(mW)	Polarization (H/V)	LIMIT (W)
132047	1717.5	-20.39	41.34	20.95	124.39	H	1
132322	1745	-21.06	41.96	20.90	122.94	H	1
132597	1772.5	-21.23	42.96	21.73	148.94	H	1
132047	1717.5	-26.06	44.04	17.98	62.86	V	1
132322	1745.0	-25.53	43.88	18.35	68.42	V	1
132597	1772.5	-25.74	44.18	18.44	69.74	V	1

CHANNEL BANDWIDTH: 15MHz 64QAM

Channel	Frequency (MHz)	SPA LVL (dBm)	Correction Factor(dB)	EIRP(dBm)	EIRP(mW)	Polarization (H/V)	LIMIT (W)
132047	1717.5	-21.63	41.34	19.71	93.50	H	1
132322	1745.0	-21.53	41.96	20.43	110.33	H	1
132597	1772.5	-22.26	42.96	20.70	117.49	H	1
132047	1717.5	-27.08	44.04	16.96	49.70	V	1
132322	1745.0	-26.78	43.88	17.10	51.31	V	1
132597	1772.5	-26.40	44.18	17.78	59.91	V	1



Test Report No.: RF181119W003-7

LTE BAND 66

CHANNEL BANDWIDTH: 20MHz QPSK

Channel	Frequency (MHz)	SPA LVL (dBm)	Correction Factor(dB)	EIRP(dBm)	EIRP(mW)	Polarization (H/V)	LIMIT (W)
132072	1720.0	-20.11	41.28	21.17	130.95	H	1
132322	1745.0	-20.64	41.96	21.32	135.43	H	1
132572	1770.0	-20.96	42.91	21.95	156.68	H	1
132072	1720.0	-25.78	44.14	18.36	68.47	V	1
132322	1745.0	-25.11	43.88	18.77	75.37	V	1
132572	1770.0	-25.47	44.16	18.69	73.96	V	1

CHANNEL BANDWIDTH: 20MHz 16QAM

Channel	Frequency (MHz)	SPA LVL (dBm)	Correction Factor(dB)	EIRP(dBm)	EIRP(mW)	Polarization (H/V)	LIMIT (W)
132072	1720.0	-21.04	41.28	20.24	105.71	H	1
132322	1745.0	-21.71	41.96	20.25	105.85	H	1
132572	1770.0	-21.79	42.91	21.12	129.42	H	1
132072	1720.0	-26.71	44.14	17.43	55.27	V	1
132322	1745.0	-26.18	43.88	17.70	58.91	V	1
132572	1770.0	-26.30	44.16	17.86	61.09	V	1

CHANNEL BANDWIDTH: 20MHz 64QAM

Channel	Frequency (MHz)	SPA LVL (dBm)	Correction Factor(dB)	EIRP(dBm)	EIRP(mW)	Polarization (H/V)	LIMIT (W)
132072	1720.0	-22.21	41.28	19.07	80.74	H	1
132322	1745.0	-21.98	41.96	19.98	99.47	H	1
132572	1770.0	-22.84	42.91	20.07	101.62	H	1
132072	1720.0	-27.66	44.14	16.48	44.41	V	1
132322	1745.0	-27.23	43.88	16.65	46.26	V	1
132572	1770.0	-26.98	44.16	17.18	52.24	V	1

REMARKS: 1. EIRP Output Power (dBm) = SPA LVL (dBm) + Correction Factor (dB).
 2. Correction factor (dB) = Free Space Loss + Antenna Factor + Cable Loss

3.2 FREQUENCY STABILITY MEASUREMENT

3.2.1 LIMITS OF FREQUENCY STABILITY MEASUREMENT

The frequency stability shall be sufficient to ensure that the fundamental emissions stay within the authorized bands of operation.

3.2.2 TEST PROCEDURE

- a. Device is placed at the oven room. The oven room could control the temperatures and humidity. Power warm up is at least 15 min and power applied should perform before recording frequency error.
- b. EUT is connected the external power supply to control the DC input power. The test voltage range is from minimum to maximum working voltage. Each step shall be record the frequency error rate.
- c. The temperature range step is 10 degrees in this test items. All temperature levels shall be hold the $\pm 0.5^{\circ}\text{C}$ during the measurement testing. The each temperature step shall be at least 0.5 hours, consider the EUT could be test under the stability condition.

NOTE: The frequency error was recorded frequency error from the communication simulator.

3.2.3 TEST SETUP

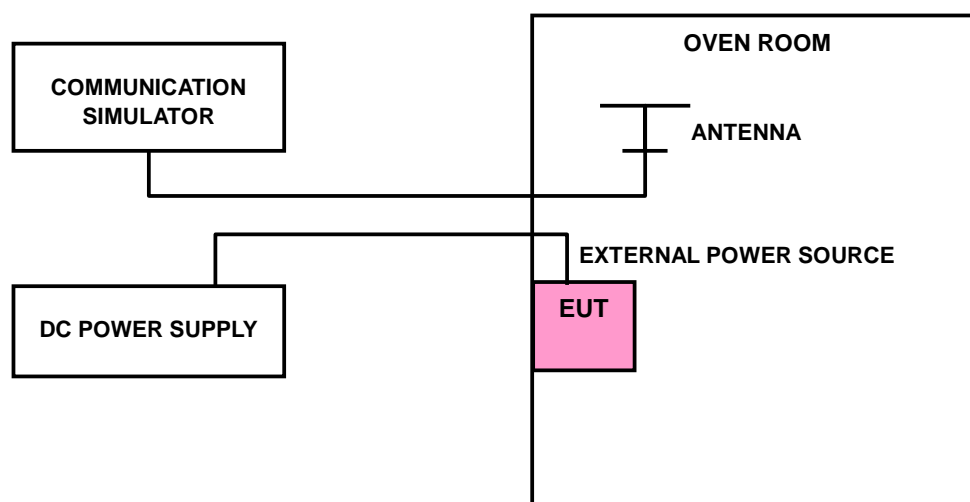



3.2.4 TEST RESULTS

LTE BAND 66

FREQUENCY ERROR VS. VOLTAGE

VOLTAGE (Volts)	1.4MHz		LIMIT (ppm)
	FREQUENCY ERROR (ppm)		
	Low Channel	High Channel	
3.8	0.0006	0.0006	2.5
3.5	-0.0007	-0.0007	2.5
4.4	0.0006	0.0005	2.5

NOTE: The applicant defined the normal working voltage of the battery is from 3.5Vdc to 4.4Vdc.

FREQUENCY ERROR vs. TEMPERATURE.

TEMP. (°C)	1.4MHz		LIMIT (ppm)
	FREQUENCY ERROR (ppm)		
	Low Channel	High Channel	
-30	-0.0048	-0.0045	2.5
-20	-0.0046	-0.0043	2.5
-10	-0.0043	-0.0043	2.5
0	-0.0034	-0.0038	2.5
10	-0.0033	-0.0034	2.5
20	-0.0028	-0.0031	2.5
30	-0.0025	-0.0030	2.5
40	-0.0016	-0.0013	2.5
50	0.0002	0.0003	2.5



Test Report No.: RF181119W003-7

FREQUENCY ERROR VS. VOLTAGE

VOLTAGE (Volts)	3MHz		LIMIT (ppm)
	FREQUENCY ERROR (ppm)		
	Low Channel	High Channel	
3.8	0.0007	0.0007	2.5
3.5	-0.0006	-0.0008	2.5
4.4	0.0006	0.0006	2.5

NOTE: The applicant defined the normal working voltage of the battery is from 3.5Vdc to 4.4Vdc.

FREQUENCY ERROR vs. TEMPERATURE.

TEMP. (°C)	3MHz		LIMIT (ppm)
	FREQUENCY ERROR (ppm)		
	Low Channel	High Channel	
-30	-0.0047	-0.0049	2.5
-20	-0.0044	-0.0047	2.5
-10	-0.0041	-0.0044	2.5
0	-0.0037	-0.0038	2.5
10	-0.0030	-0.0032	2.5
20	-0.0023	-0.0025	2.5
30	-0.0022	-0.0023	2.5
40	-0.0018	-0.0019	2.5
50	0.0003	0.0003	2.5



Test Report No.: RF181119W003-7

FREQUENCY ERROR VS. VOLTAGE

VOLTAGE (Volts)	5MHz		LIMIT (ppm)
	FREQUENCY ERROR (ppm)		
	Low Channel	High Channel	
3.8	0.0006	0.0005	2.5
3.5	-0.0007	-0.0006	2.5
4.4	0.0006	0.0005	2.5

NOTE: The applicant defined the normal working voltage of the battery is from 3.5Vdc to 4.4Vdc.

FREQUENCY ERROR vs. TEMPERATURE.

TEMP. (°C)	5MHz		LIMIT (ppm)
	FREQUENCY ERROR (ppm)		
	Low Channel	High Channel	
-30	-0.0045	-0.0053	2.5
-20	-0.0041	-0.0045	2.5
-10	-0.0033	-0.0040	2.5
0	-0.0029	-0.0035	2.5
10	-0.0023	-0.0027	2.5
20	-0.0018	-0.0028	2.5
30	-0.0010	-0.0012	2.5
40	-0.0007	-0.0010	2.5
50	0.0002	0.0002	2.5



Test Report No.: RF181119W003-7

FREQUENCY ERROR VS. VOLTAGE

VOLTAGE (Volts)	10MHz		LIMIT (ppm)
	FREQUENCY ERROR (ppm)		
	Low Channel	High Channel	
3.8	0.0007	0.0006	2.5
3.5	-0.0006	-0.0006	2.5
4.4	0.0005	0.0005	2.5

NOTE: The applicant defined the normal working voltage of the battery is from 3.5Vdc to 4.4Vdc.

FREQUENCY ERROR vs. TEMPERATURE.

TEMP. (°C)	10MHz		LIMIT (ppm)
	FREQUENCY ERROR (ppm)		
	Low Channel	High Channel	
-30	-0.0045	-0.0050	2.5
-20	-0.0043	-0.0049	2.5
-10	-0.0040	-0.0047	2.5
0	-0.0037	-0.0043	2.5
10	-0.0029	-0.0038	2.5
20	-0.0024	-0.0026	2.5
30	-0.0020	-0.0022	2.5
40	-0.0010	-0.0016	2.5
50	0.0001	0.0001	2.5



Test Report No.: RF181119W003-7

FREQUENCY ERROR VS. VOLTAGE

VOLTAGE (Volts)	15MHz		LIMIT (ppm)
	FREQUENCY ERROR (ppm)		
	Low Channel	High Channel	
3.8	-0.0045	-0.0050	2.5
3.5	-0.0043	-0.0049	2.5
4.4	-0.0040	-0.0047	2.5

NOTE: The applicant defined the normal working voltage of the battery is from 3.5Vdc to 4.4Vdc.

FREQUENCY ERROR vs. TEMPERATURE.

TEMP. (°C)	15MHz		LIMIT (ppm)
	FREQUENCY ERROR (ppm)		
	Low Channel	High Channel	
-30	-0.0056	-0.0066	2.5
-20	-0.0052	-0.0058	2.5
-10	-0.0044	-0.0047	2.5
0	-0.0031	-0.0038	2.5
10	-0.0026	-0.0033	2.5
20	-0.0021	-0.0022	2.5
30	-0.0013	-0.0013	2.5
40	-0.0007	-0.0004	2.5
50	0.0002	0.0004	2.5



Test Report No.: RF181119W003-7

FREQUENCY ERROR VS. VOLTAGE

VOLTAGE (Volts)	20MHz		LIMIT (ppm)
	FREQUENCY ERROR (ppm)		
	Low Channel	High Channel	
3.8	0.0013	0.0013	2.5
3.5	-0.0012	-0.0013	2.5
4.4	0.0010	0.0012	2.5

NOTE: The applicant defined the normal working voltage of the battery is from 3.5Vdc to 4.4Vdc.

FREQUENCY ERROR vs. TEMPERATURE.

TEMP. (°C)	20MHz		LIMIT (ppm)
	FREQUENCY ERROR (ppm)		
	Low Channel	High Channel	
-30	-0.0053	-0.0065	2.5
-20	-0.0046	-0.0058	2.5
-10	-0.0039	-0.0044	2.5
0	-0.0031	-0.0036	2.5
10	-0.0025	-0.0028	2.5
20	-0.0020	-0.0019	2.5
30	-0.0012	-0.0013	2.5
40	-0.0005	-0.0002	2.5
50	0.0002	0.0003	2.5

3.3 OCCUPIED BANDWIDTH MEASUREMENT

3.3.1 LIMITS OF OCCUPIED BANDWIDTH MEASUREMENT

The width of a frequency band such that, below the lower and above the upper frequency limits, the mean powers emitted are each equal to a specified percentage 0.5 % of the total mean power of a given emission.

3.3.2 TEST SETUP

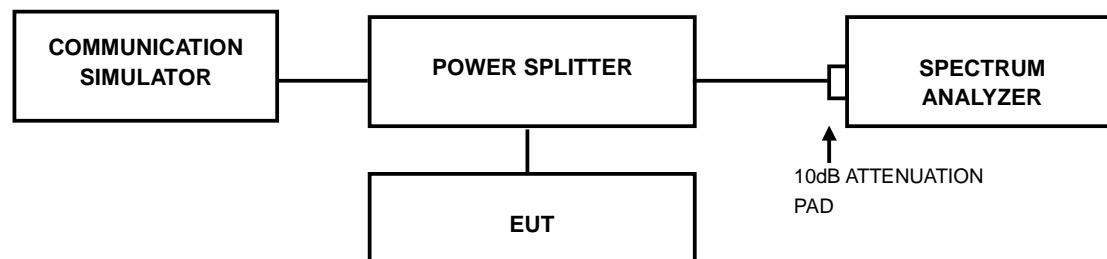

3.3.3 TEST PROCEDURES

- The conducted occupied bandwidth used the power splitter via EUT RF power connector between simulation base station and spectrum analyzer.
- Use OBW measurement function of Spectrum analyzer to measure 99 % occupied bandwidth.



3.3.4 TEST RESULTS

LTE BAND 66

CHANNEL BANDWIDTH: 1.4MHz				
CHANNEL	Frequency (MHz)	99% OCCUPIED Bandwidth (MHz)		
		QPSK	16QAM	64QAM
131979	1710.7	1.09	1.09	1.09
132322	1745	1.09	1.09	1.09
132665	1779.3	1.09	1.09	1.09

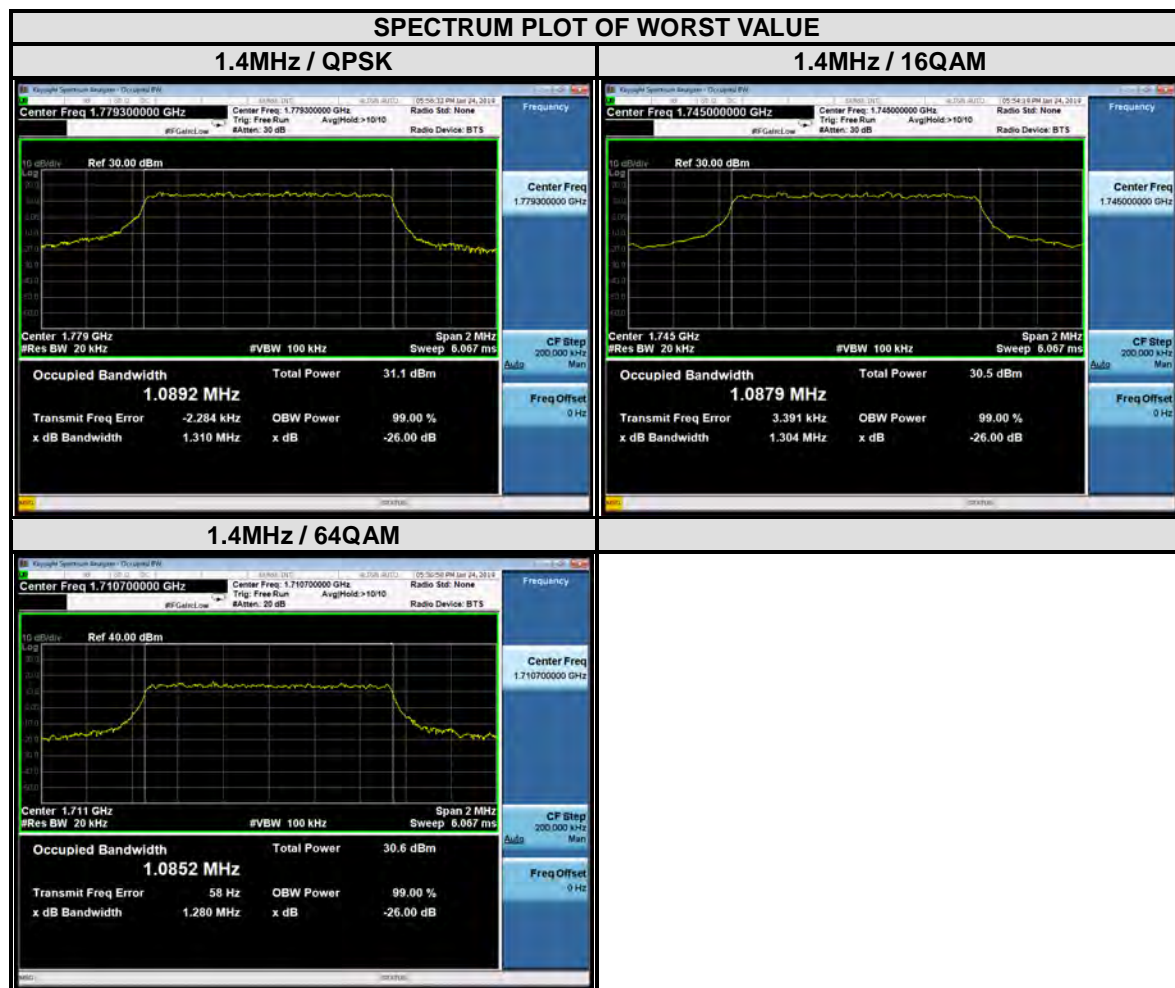



Test Report No.: RF181119W003-7

CHANNEL BANDWIDTH: 3MHz				
CHANNEL	Frequency (MHz)	99% OCCUPIED Bandwidth (MHz)		
		QPSK	16QAM	64QAM
131987	1711.5	2.68	2.69	2.69
132322	1745	2.68	2.69	2.69
132657	1778.5	2.69	2.69	2.69





Test Report No.: RF181119W003-7

LTE BAND 66

CHANNEL BANDWIDTH: 5MHz				
CHANNEL	Frequency (MHz)	99% OCCUPIED Bandwidth (MHz)		
		QPSK	16QAM	64QAM
131997	1712.5	4.47	4.47	4.48
132322	1745	4.47	4.47	4.48
132647	1777.5	4.47	4.47	4.48





Test Report No.: RF181119W003-7

LTE BAND 66

CHANNEL BANDWIDTH: 10MHz				
CHANNEL	Frequency (MHz)	99% OCCUPIED Bandwidth (MHz)		
		QPSK	16QAM	64QAM
132022	1715	8.96	8.92	8.94
132322	1745	8.95	8.92	8.94
132622	1775	8.96	8.92	8.94





Test Report No.: RF181119W003-7

LTE BAND 66

CHANNEL BANDWIDTH: 15MHz				
CHANNEL	Frequency (MHz)	99% OCCUPIED Bandwidth (MHz)		
		QPSK	16QAM	64QAM
132047	1717.5	13.41	13.41	13.44
132322	1745	13.41	13.40	13.43
132597	1772.5	13.40	13.40	13.43





Test Report No.: RF181119W003-7

LTE BAND 66

CHANNEL BANDWIDTH: 20MHz				
CHANNEL	Frequency (MHz)	99% OCCUPIED Bandwidth (MHz)		
		QPSK	16QAM	64QAM
132072	1720	17.92	17.88	17.89
132322	1745	17.95	17.91	17.89
132572	1770	17.93	17.88	17.89

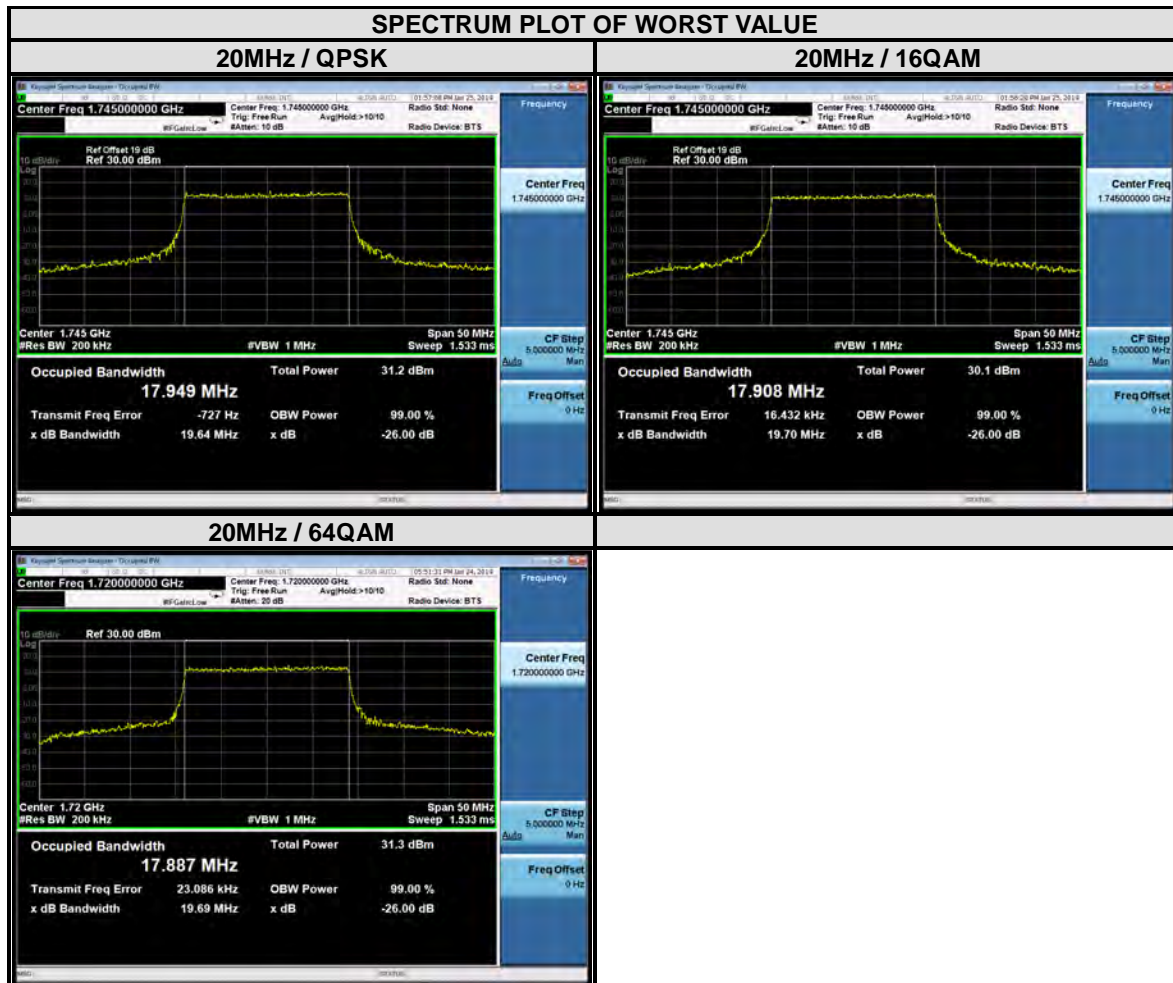

3.4 PEAK TO AVERAGE RATIO

3.4.1 LIMITS OF PEAK TO AVERAGE RATIO MEASUREMENT

In measuring transmissions in this band using an average power technique, the peak to-average ratio (PAR) of the transmission may not exceed 13 dB

3.4.2 TEST SETUP

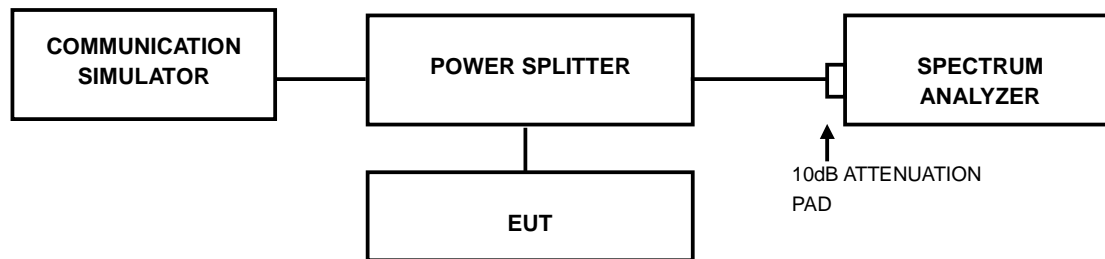

3.4.3 TEST PROCEDURES

1. Set resolution/measurement bandwidth \geq signal's occupied bandwidth;
2. Set the number of counts to a value that stabilizes the measured CCDF curve;
3. Record the maximum PAPR level associated with a probability of 0.1%.



3.4.4 TEST RESULTS

LTE BAND 66

CHANNEL BANDWIDTH: 1.4MHz				
CHANNEL	Frequency (MHz)	PEAK TO AVERAGE RATIO (dB)		
		QPSK	16QAM	64QAM
131979	1710.7	4.54	5.35	5.42
132322	1745	5.13	5.87	5.85
132665	1779.3	4.87	5.65	5.63

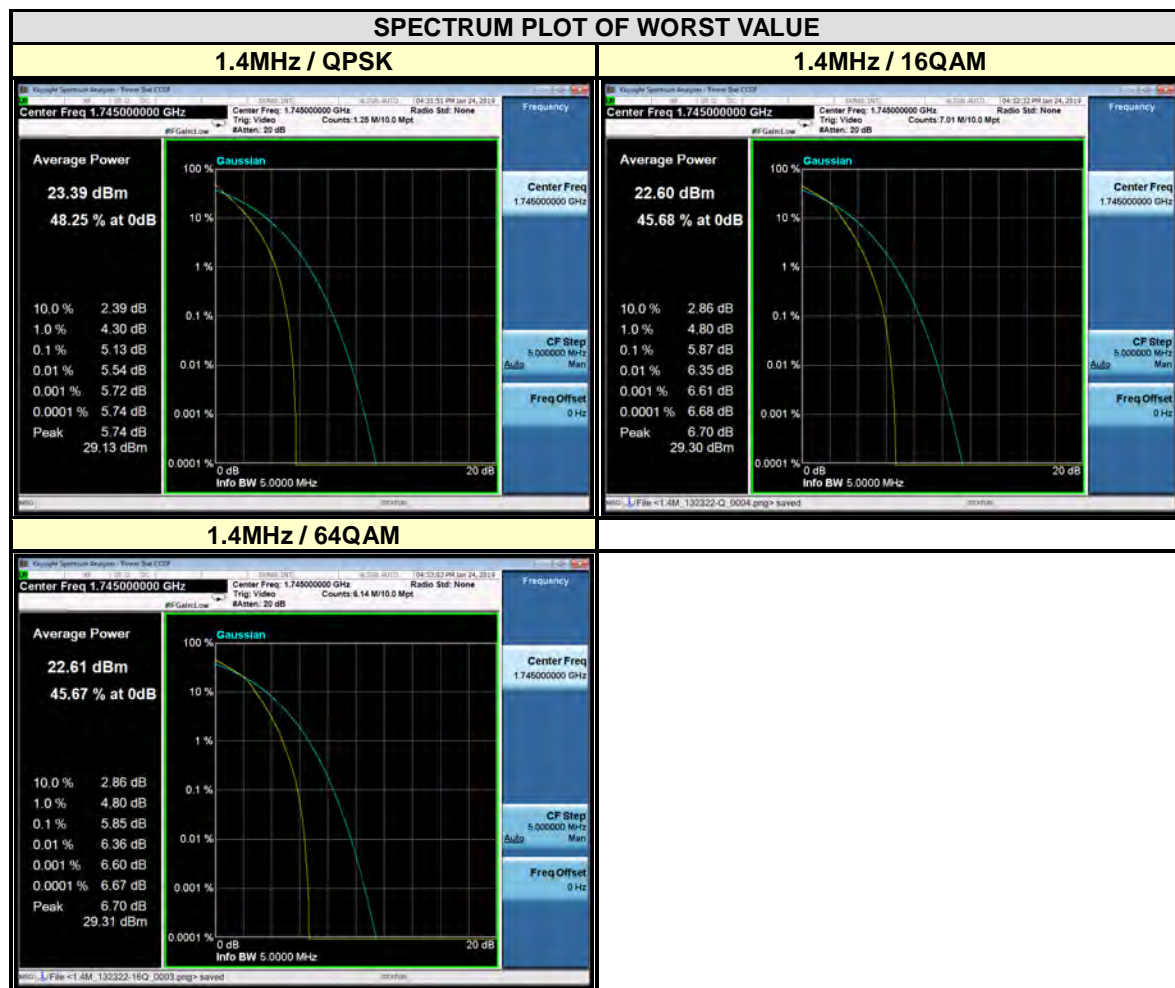



Test Report No.: RF181119W003-7

CHANNEL BANDWIDTH: 3MHz				
CHANNEL	Frequency (MHz)	PEAK TO AVERAGE RATIO (dB)		
		QPSK	16QAM	64QAM
131987	1711.5	4.69	5.30	5.34
132322	1745	5.17	5.78	5.89
132657	1778.5	4.96	5.60	5.65

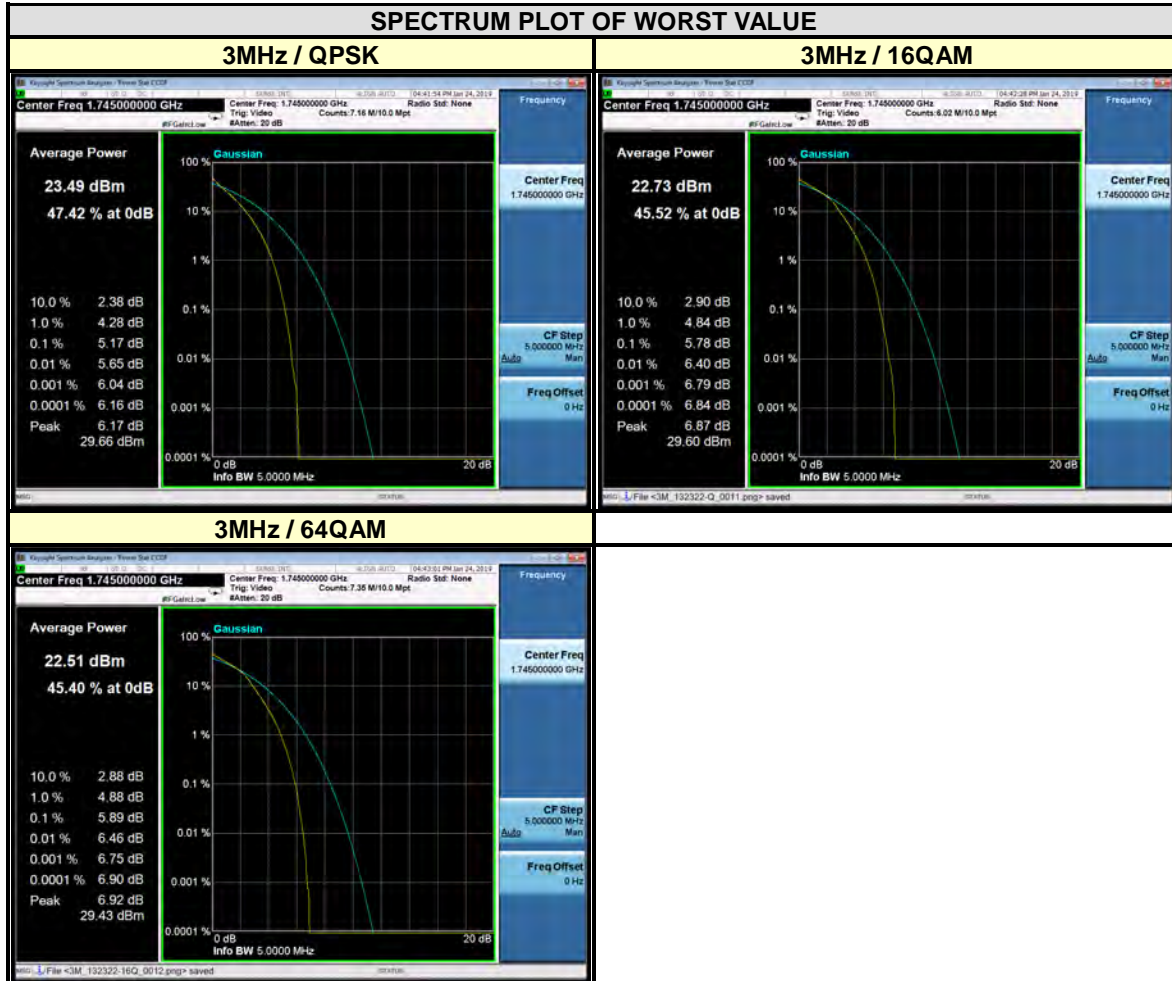



Test Report No.: RF181119W003-7

CHANNEL BANDWIDTH: 5MHz				
CHANNEL	Frequency (MHz)	PEAK TO AVERAGE RATIO (dB)		
		QPSK	16QAM	64QAM
131997	1712.5	4.98	5.64	5.60
132322	1745	5.32	6.02	5.93
132647	1777.5	5.10	5.84	5.78

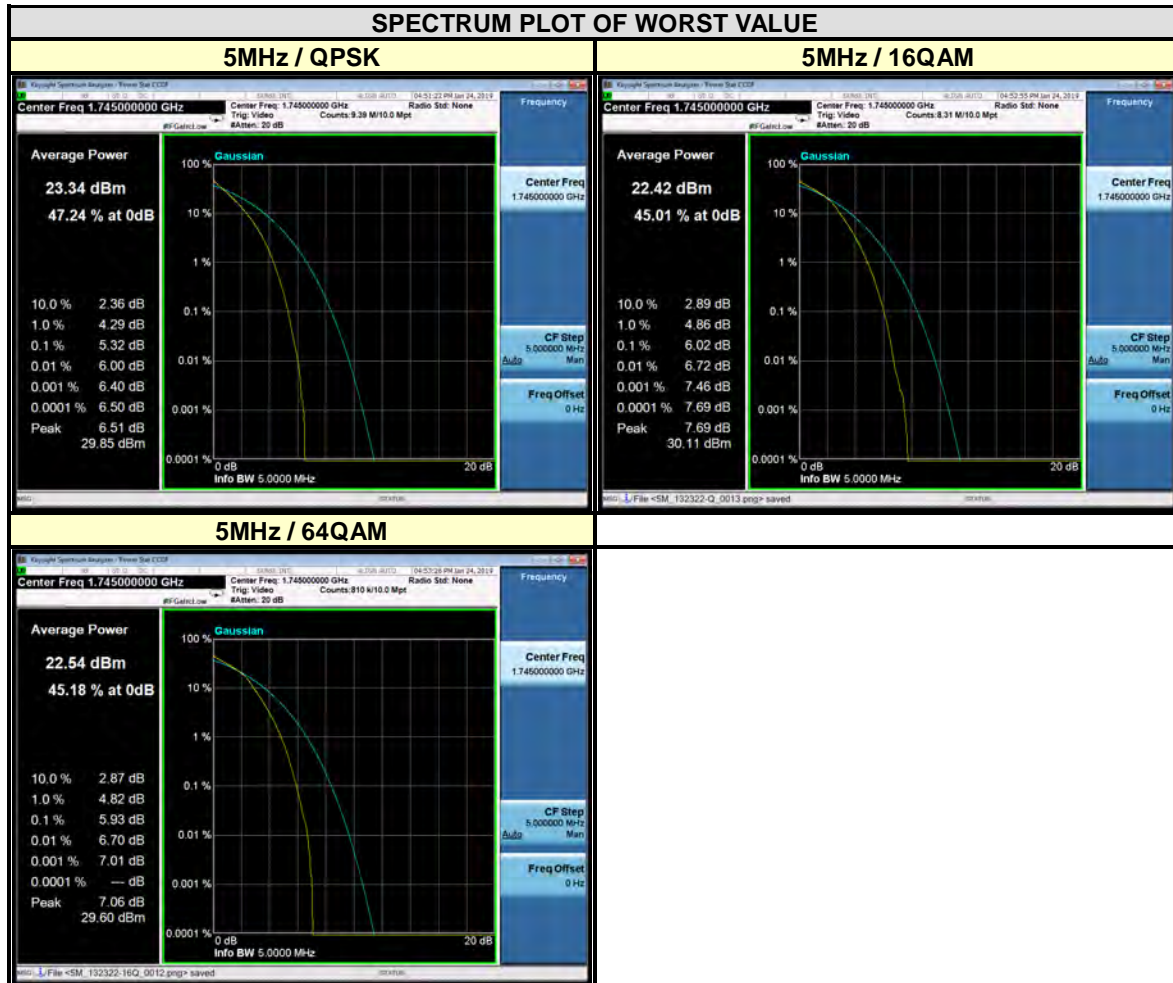



Test Report No.: RF181119W003-7

CHANNEL BANDWIDTH: 10MHz				
CHANNEL	Frequency (MHz)	PEAK TO AVERAGE RATIO (dB)		
		QPSK	16QAM	64QAM
132022	1715	4.67	5.37	5.35
132322	1745	5.17	5.82	5.82
132622	1775	4.94	5.64	5.63

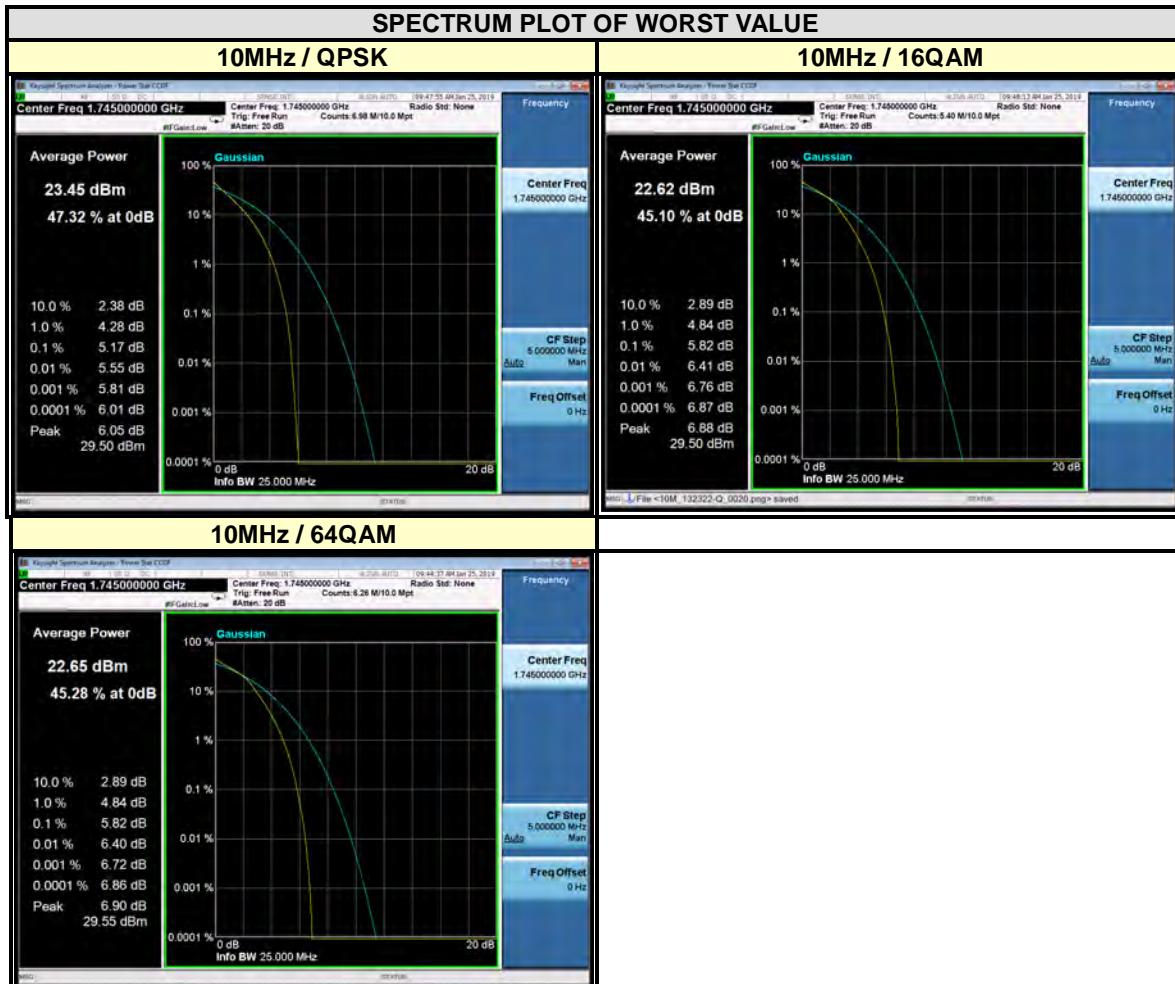



Test Report No.: RF181119W003-7

CHANNEL BANDWIDTH: 15MHz				
CHANNEL	Frequency (MHz)	PEAK TO AVERAGE RATIO (dB)		
		QPSK	16QAM	64QAM
132047	1717.5	4.85	5.52	5.53
132322	1745	5.20	5.92	5.90
132597	1772.5	5.04	5.78	5.76

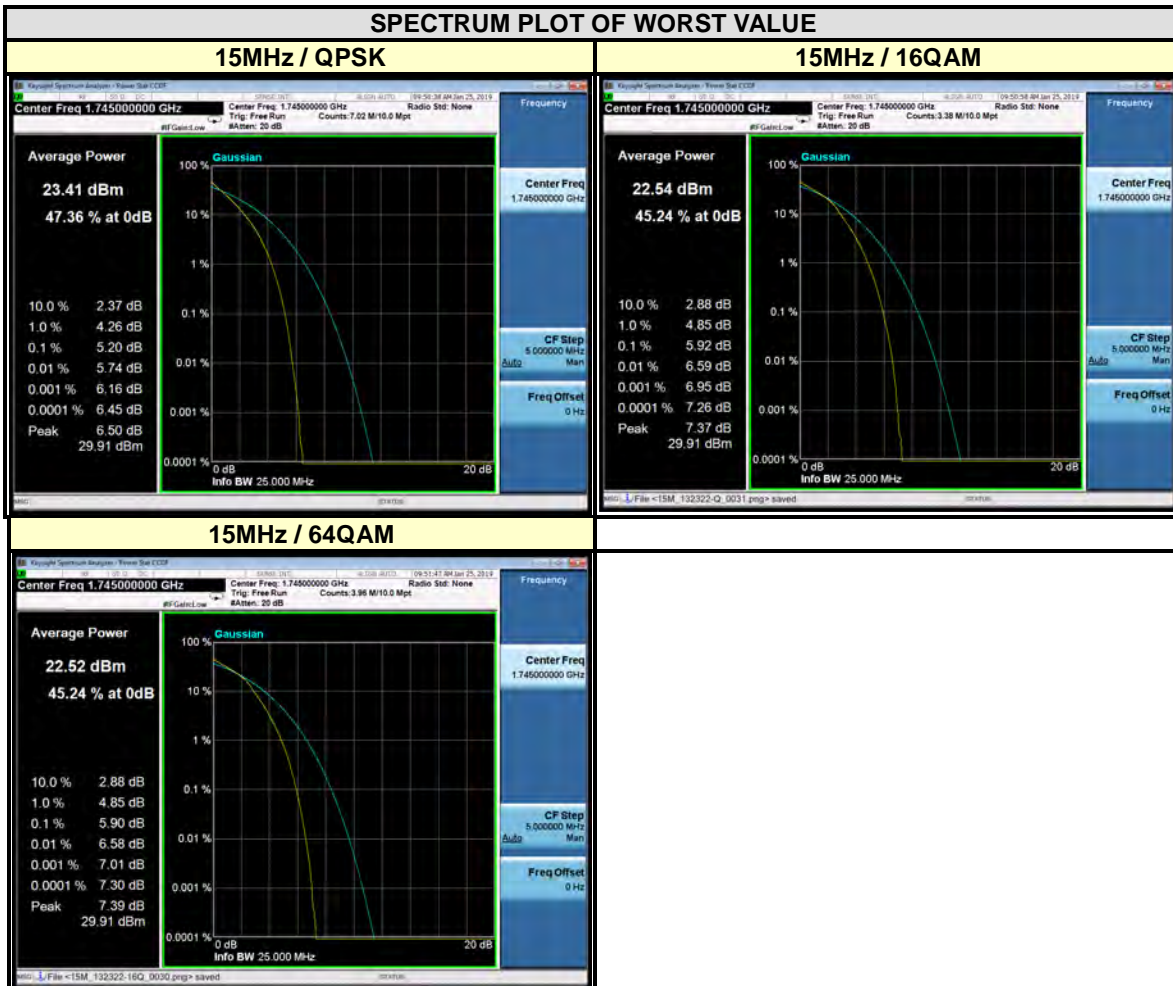



Test Report No.: RF181119W003-7

CHANNEL BANDWIDTH: 20MHz				
CHANNEL	Frequency (MHz)	PEAK TO AVERAGE RATIO (dB)		
		QPSK	16QAM	64QAM
132072	1720	5.09	5.76	5.78
132322	1745	5.60	6.28	6.27
132572	1770	5.51	6.23	6.22

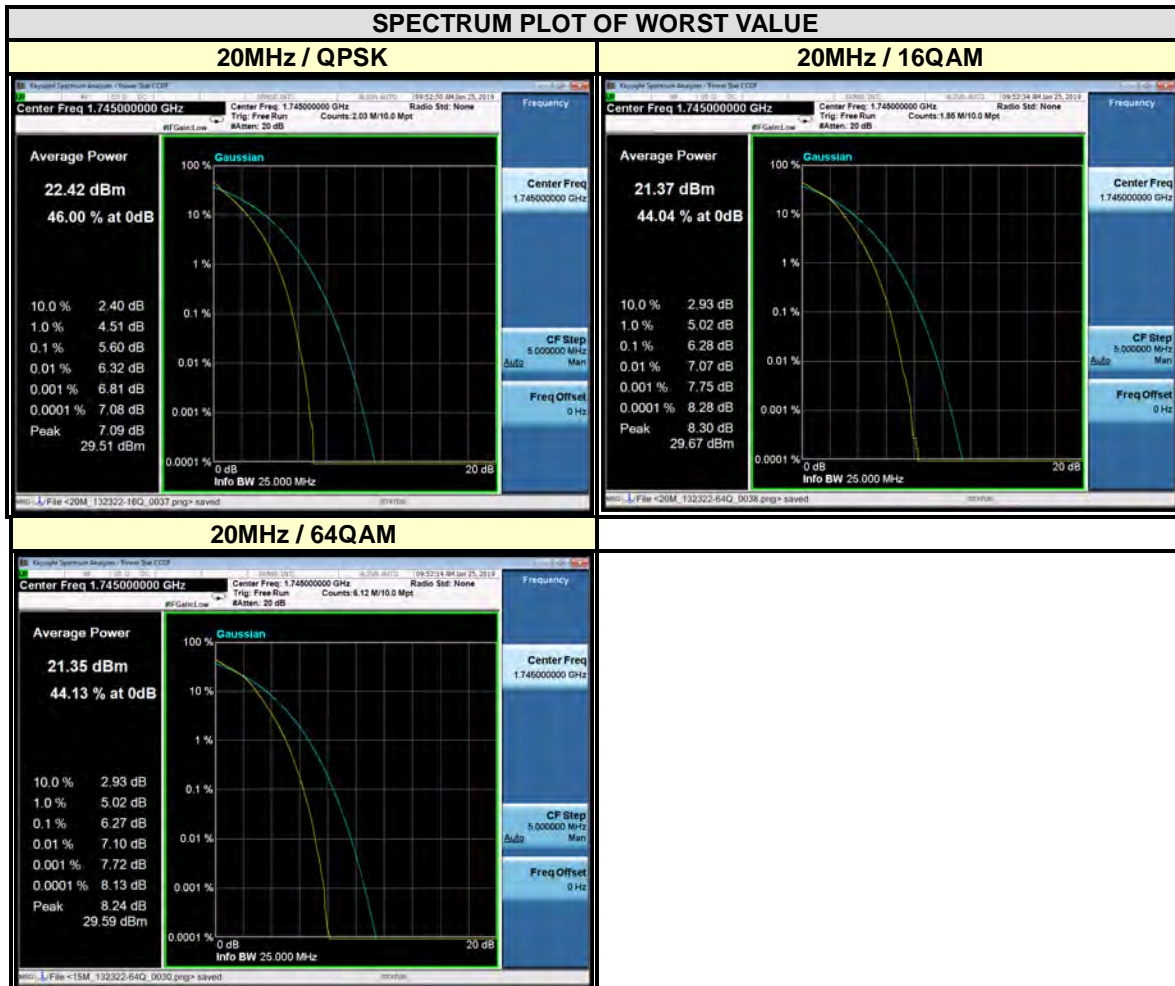

3.5 BAND EDGE MEASUREMENT

3.5.1 LIMITS OF BAND EDGE MEASUREMENT

The power of any emission outside a licensee's frequency band(s) of operation shall be attenuated below the transmitter power (P) within the licensed band(s) of operation, measured in watts, by at least $43 + 10 \log (P)$ dB. Compliance with this provision is based on the use of measurement instrumentation employing a resolution bandwidth of 100 kilohertz or greater.

However, in the 100 kilohertz bands immediately outside and adjacent to a licensee's frequency block, a resolution bandwidth of at least 30 kHz may be employed.

3.5.2 TEST SETUP

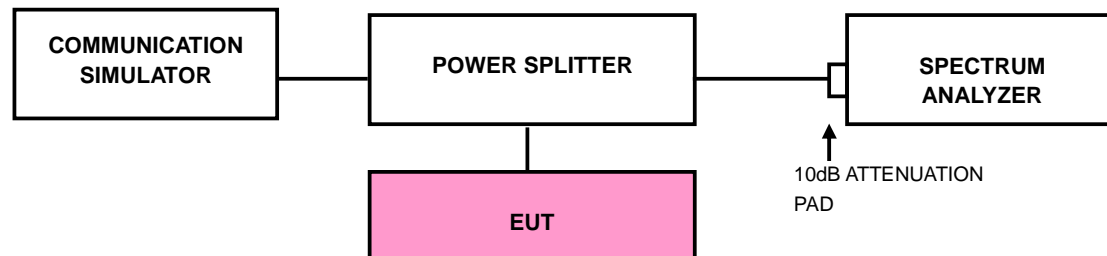



3.5.3 TEST PROCEDURES

- a. The EUT was set up for the maximum peak power with LTE link data modulation. The power was measured with R&S Spectrum Analyzer. All measurements were done at 2 channels (low and high operational frequency range.).
- b. The band edge measurement used the power splitter via EUT RF power connector between simulation base station and spectrum analyzer.
- c. The center frequency of spectrum is the band edge frequency and span is 1~5 MHz. RBW of the spectrum is 20kHz and VBW of the spectrum is 100 kHz. (LTE bandwidth 1.4MHz)
- d. The center frequency of spectrum is the band edge frequency and span is 1~5 MHz. RBW of the spectrum is 30kHz and VBW of the spectrum is 100kHz. (LTE bandwidth 3MHz)
- e. The center frequency of spectrum is the band edge frequency and span is 1~5 MHz. RBW of the spectrum is 50kHz and VBW of the spectrum is 200kHz. (LTE bandwidth 5MHz)
- f. The center frequency of spectrum is the band edge frequency and span is 1~5 MHz. RBW of the spectrum is 100kHz and VBW of the spectrum is 300kHz. (LTE bandwidth 10MHz)
- g. The center frequency of spectrum is the band edge frequency and span is 1~5 MHz. RBW of the spectrum is 200kHz and VBW of the spectrum is 1MHz. (LTE bandwidth 15MHz)
- h. The center frequency of spectrum is the band edge frequency and span is 1~5 MHz. RBW of the spectrum is 200kHz and VBW of the spectrum is 1MHz. (LTE bandwidth 20MHz)
- i. Record the max trace plot into the test report.



Test Report No.: RF181119W003-7

3.5.4 TEST RESULTS

LTE BAND 66

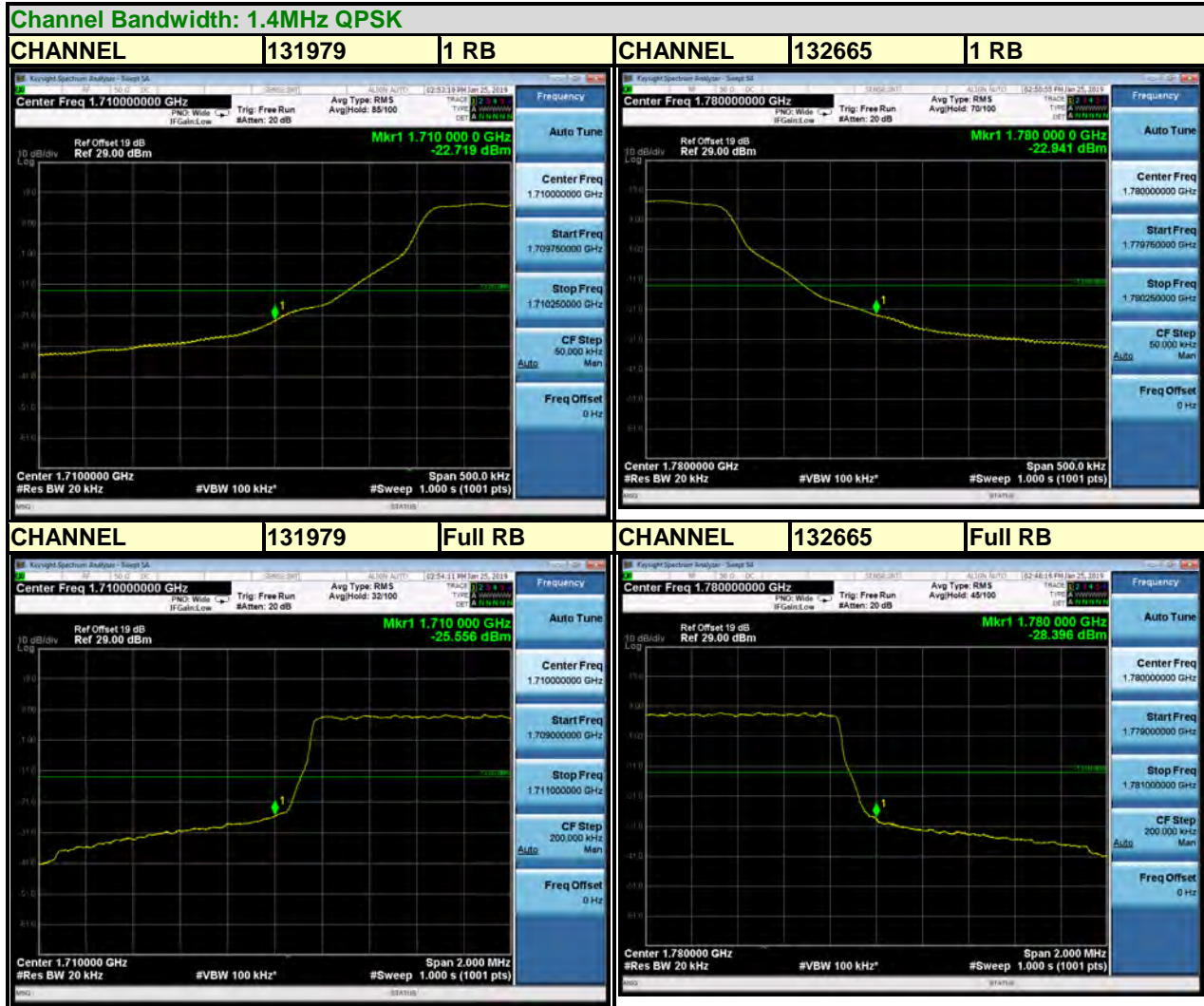



Test Report No.: RF181119W003-7

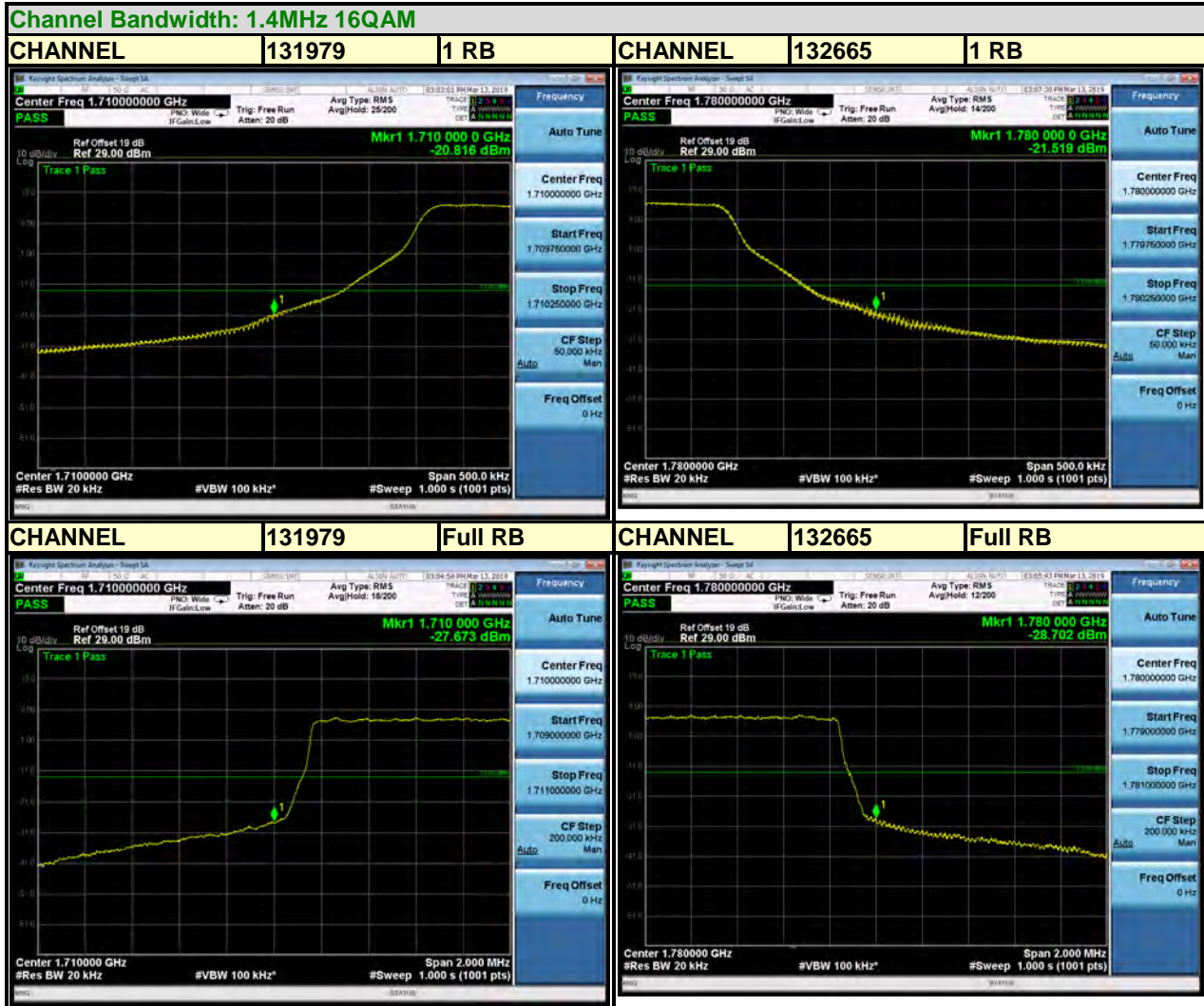



Test Report No.: RF181119W003-7

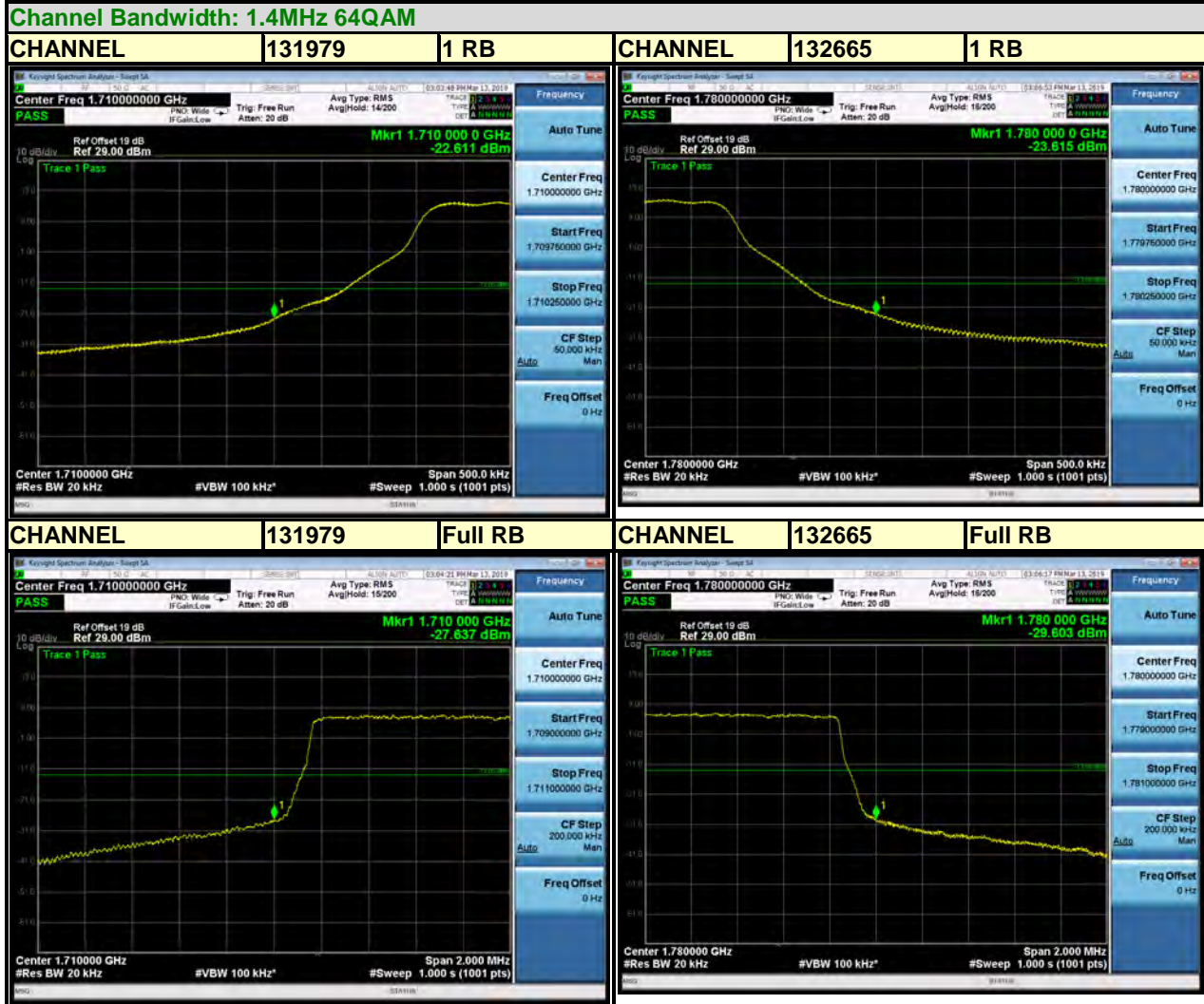



Test Report No.: RF181119W003-7

LTE BAND 66

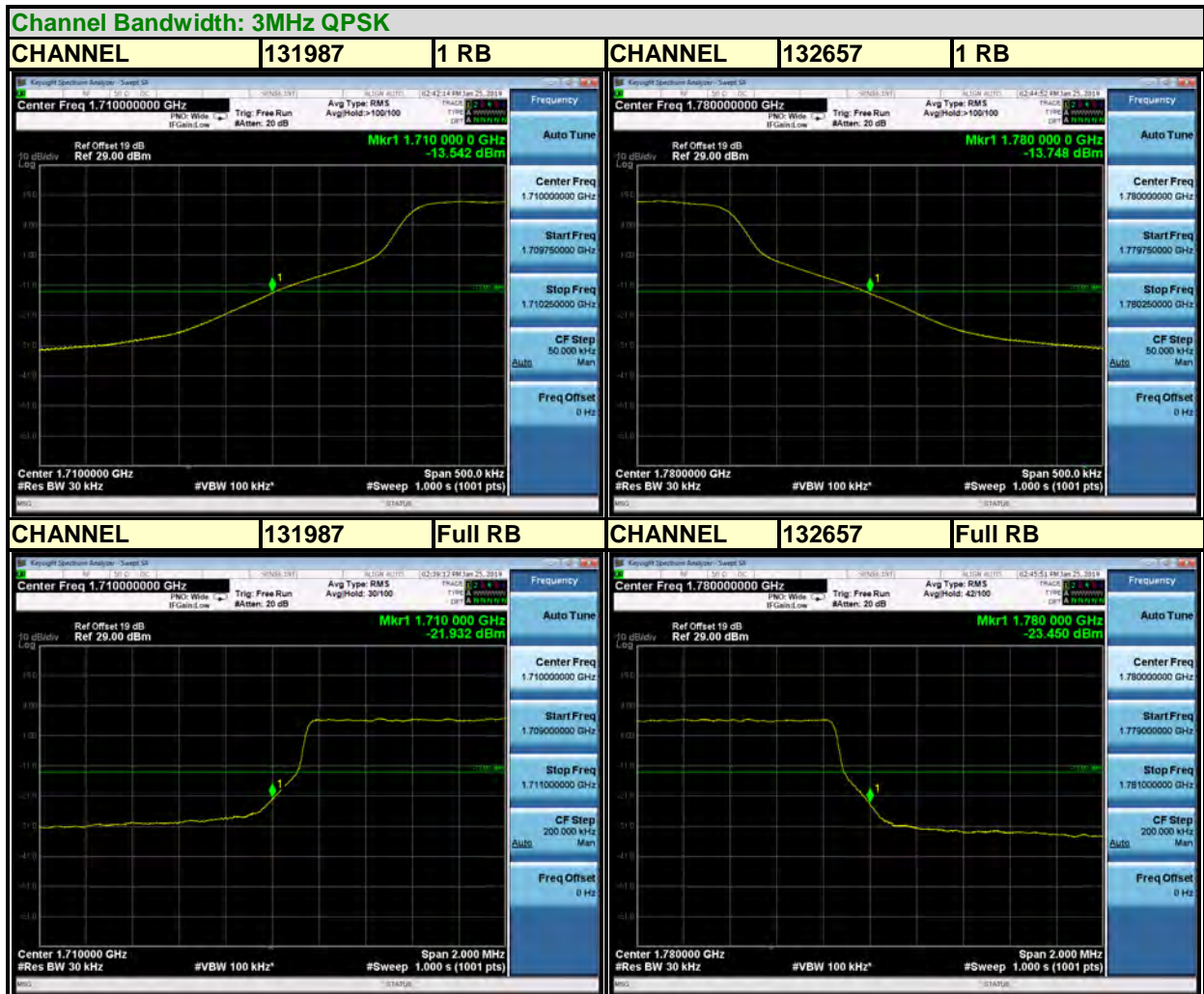



Test Report No.: RF181119W003-7

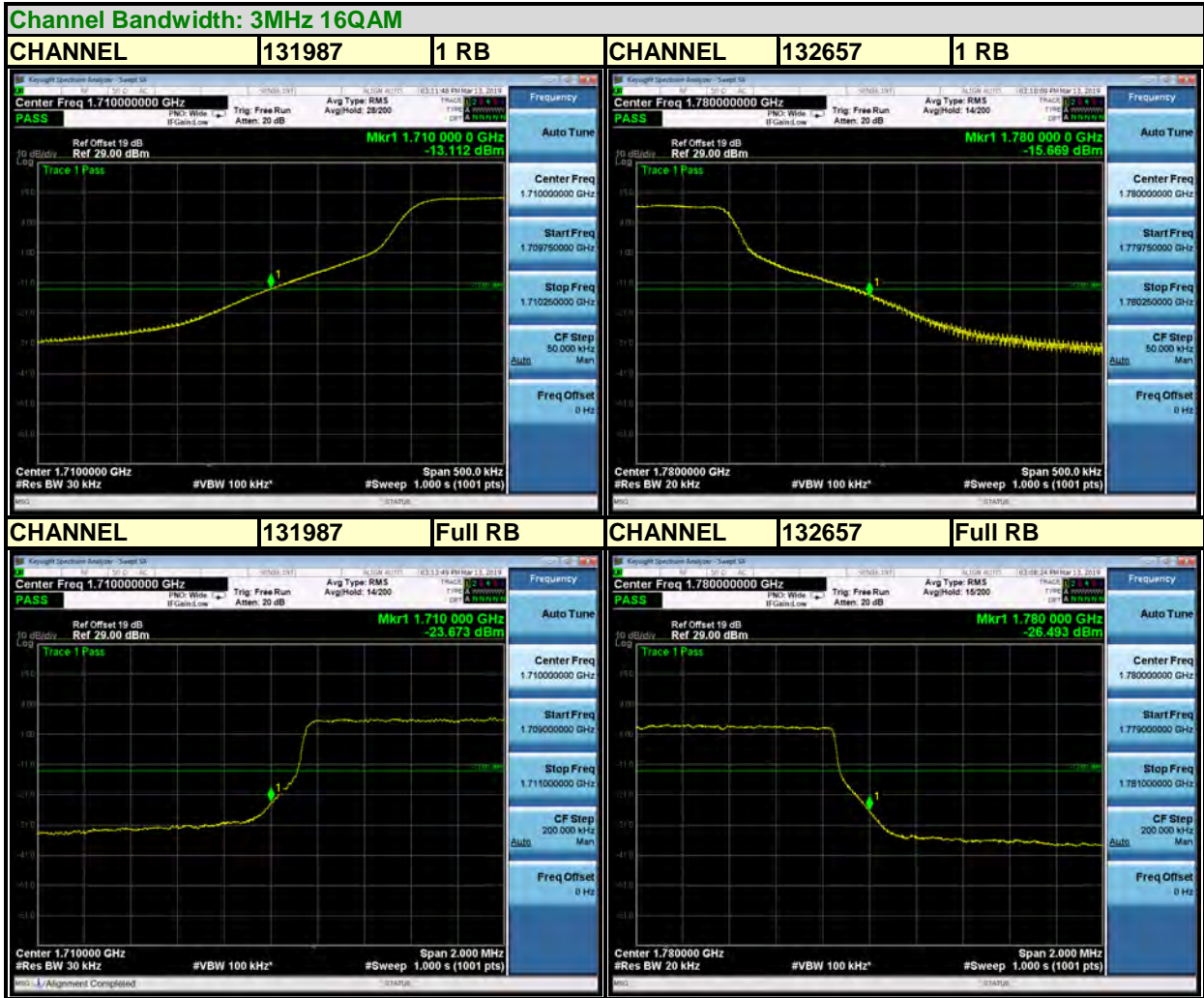



Test Report No.: RF181119W003-7

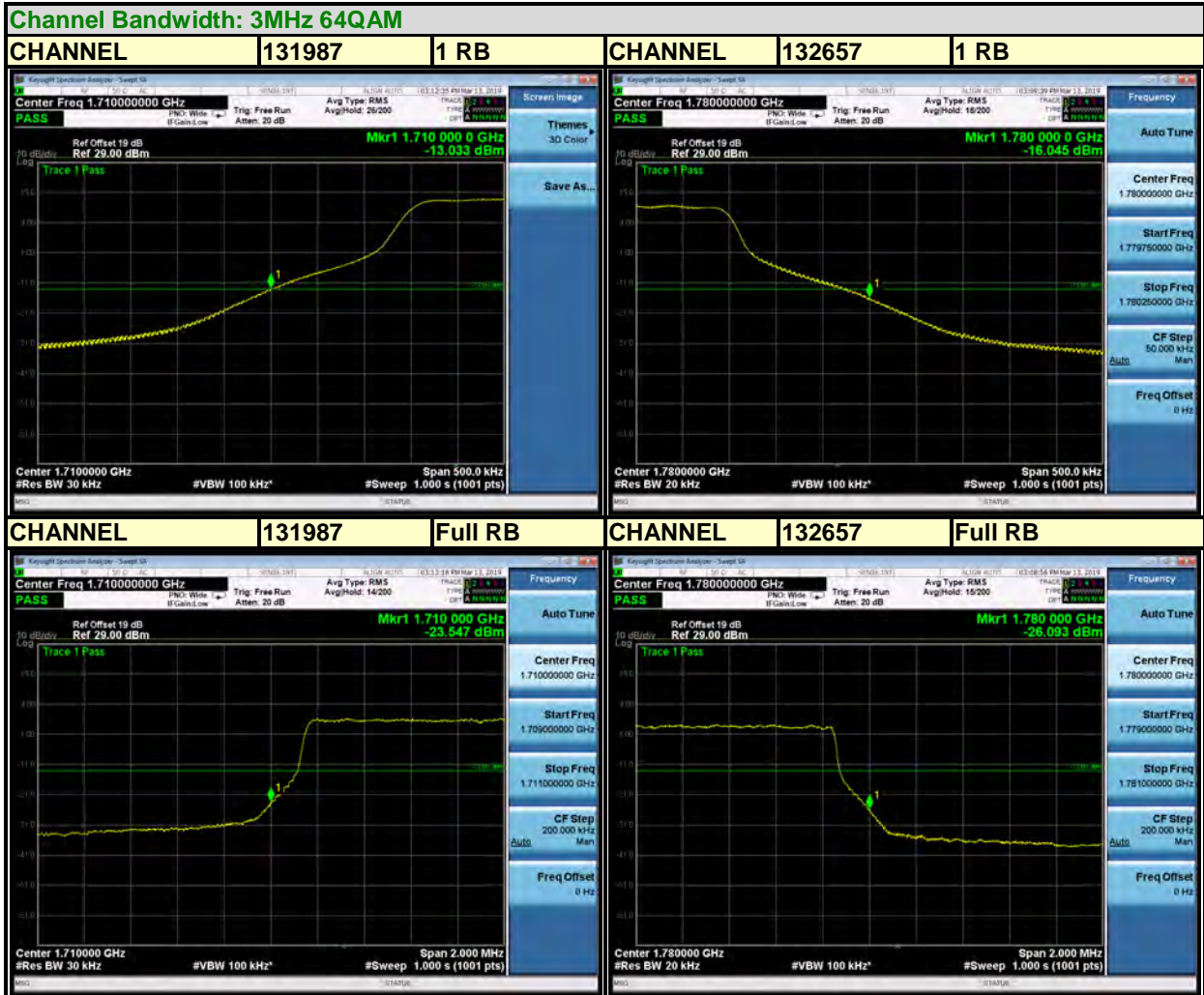



Test Report No.: RF181119W003-7

LTE BAND 66

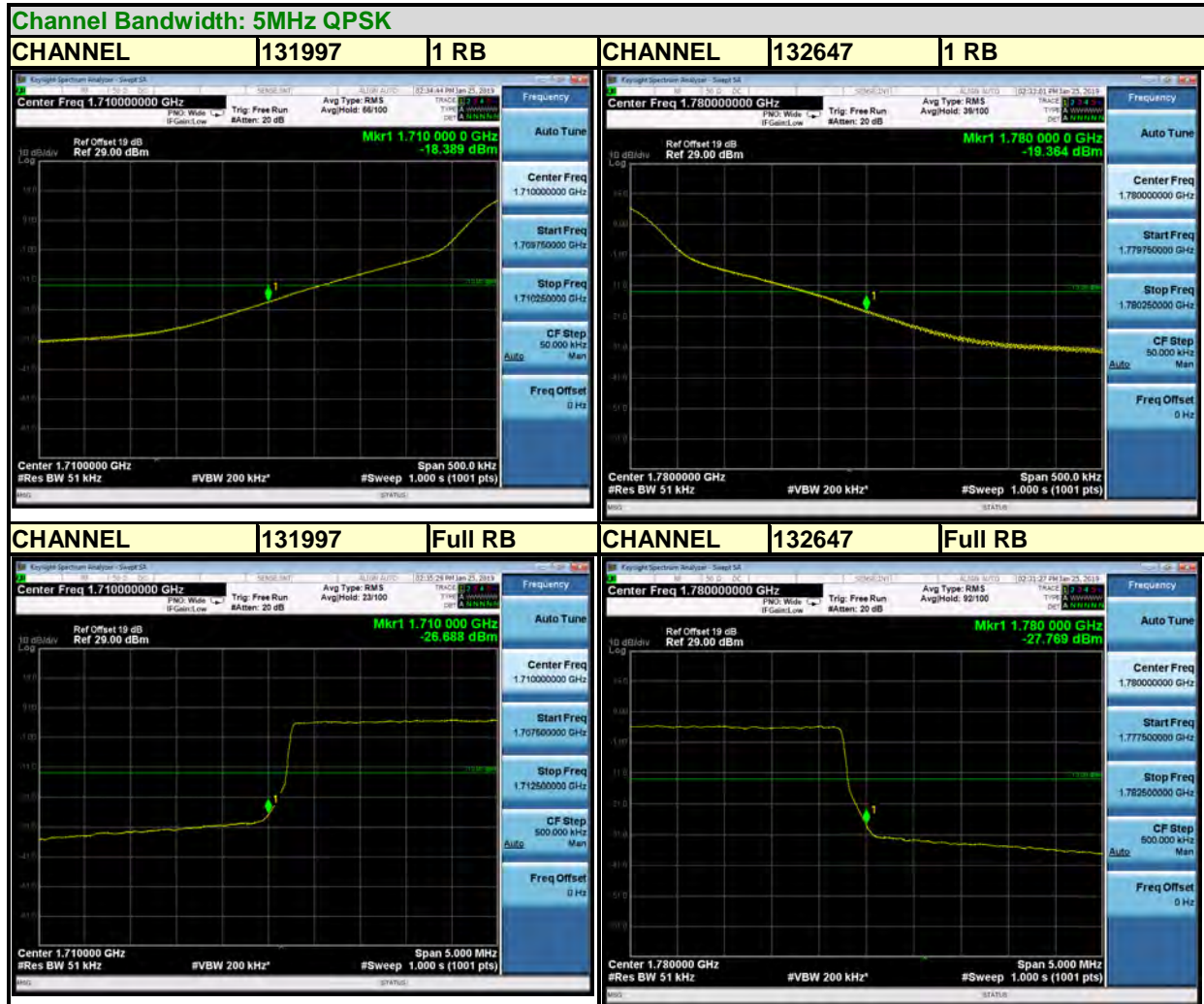



Test Report No.: RF181119W003-7

Channel Bandwidth: 5MHz 16QAM

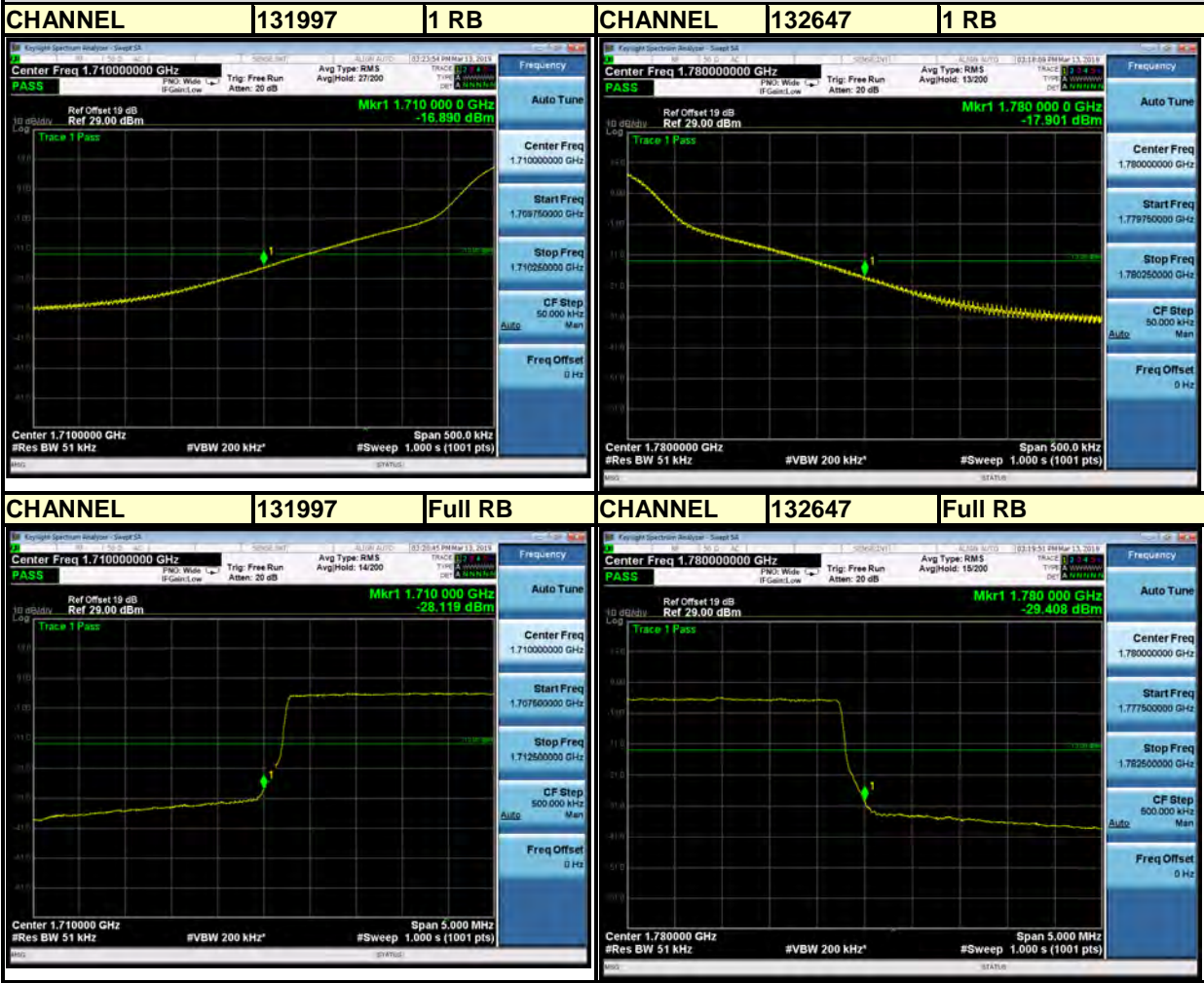



Test Report No.: RF181119W003-7

Channel Bandwidth: 5MHz 64QAM

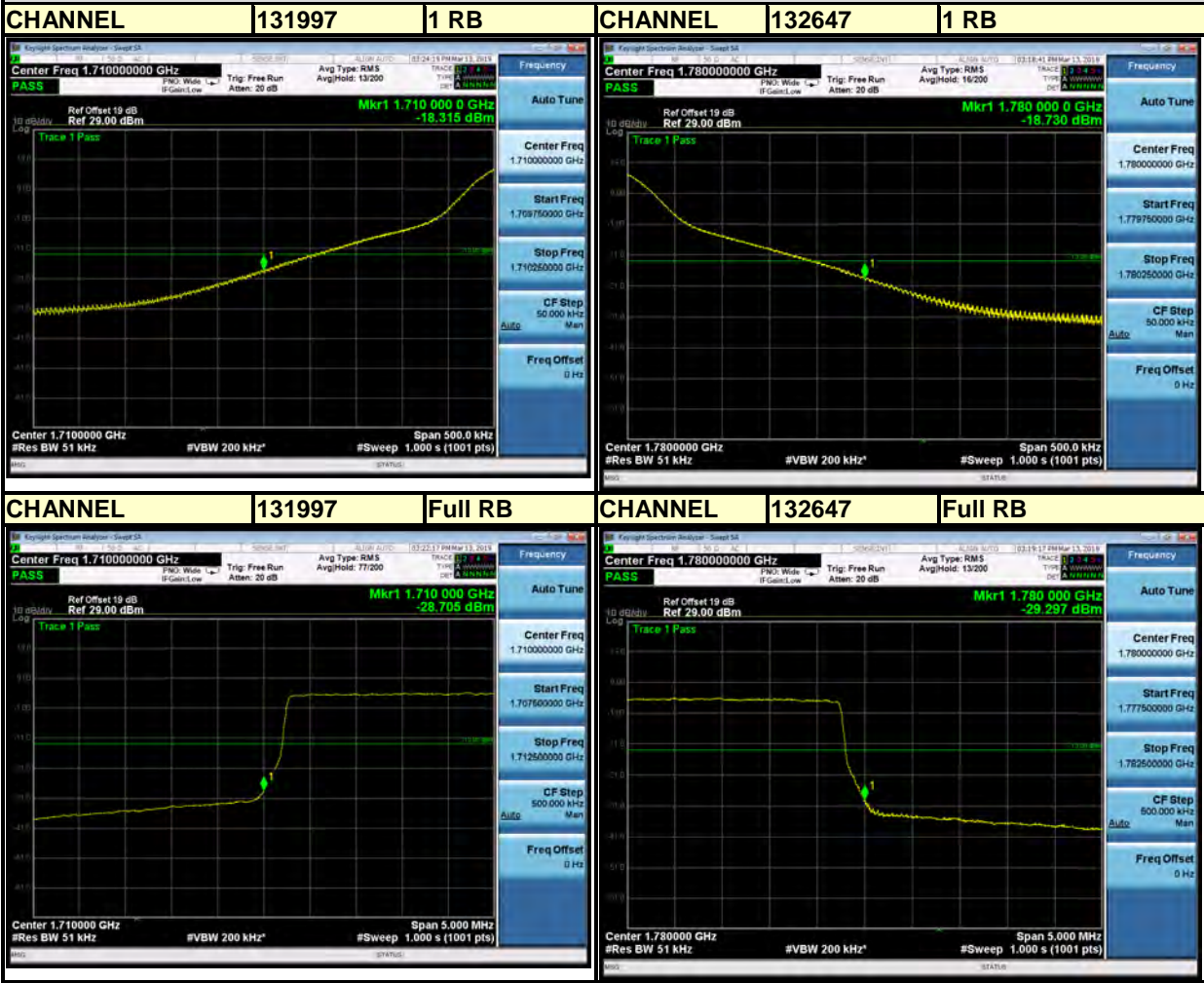



Test Report No.: RF181119W003-7

LTE BAND 66





Test Report No.: RF181119W003-7

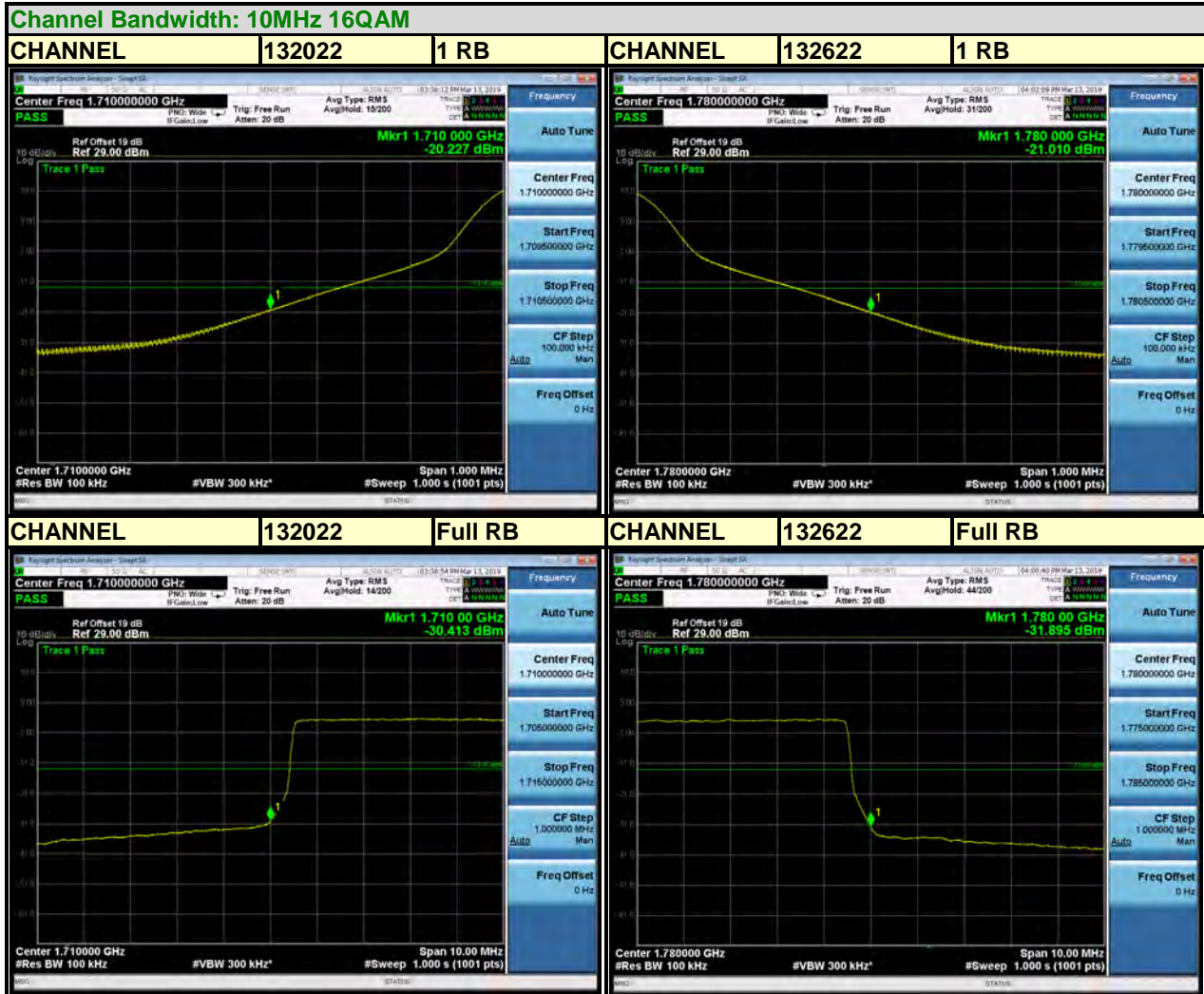



Test Report No.: RF181119W003-7

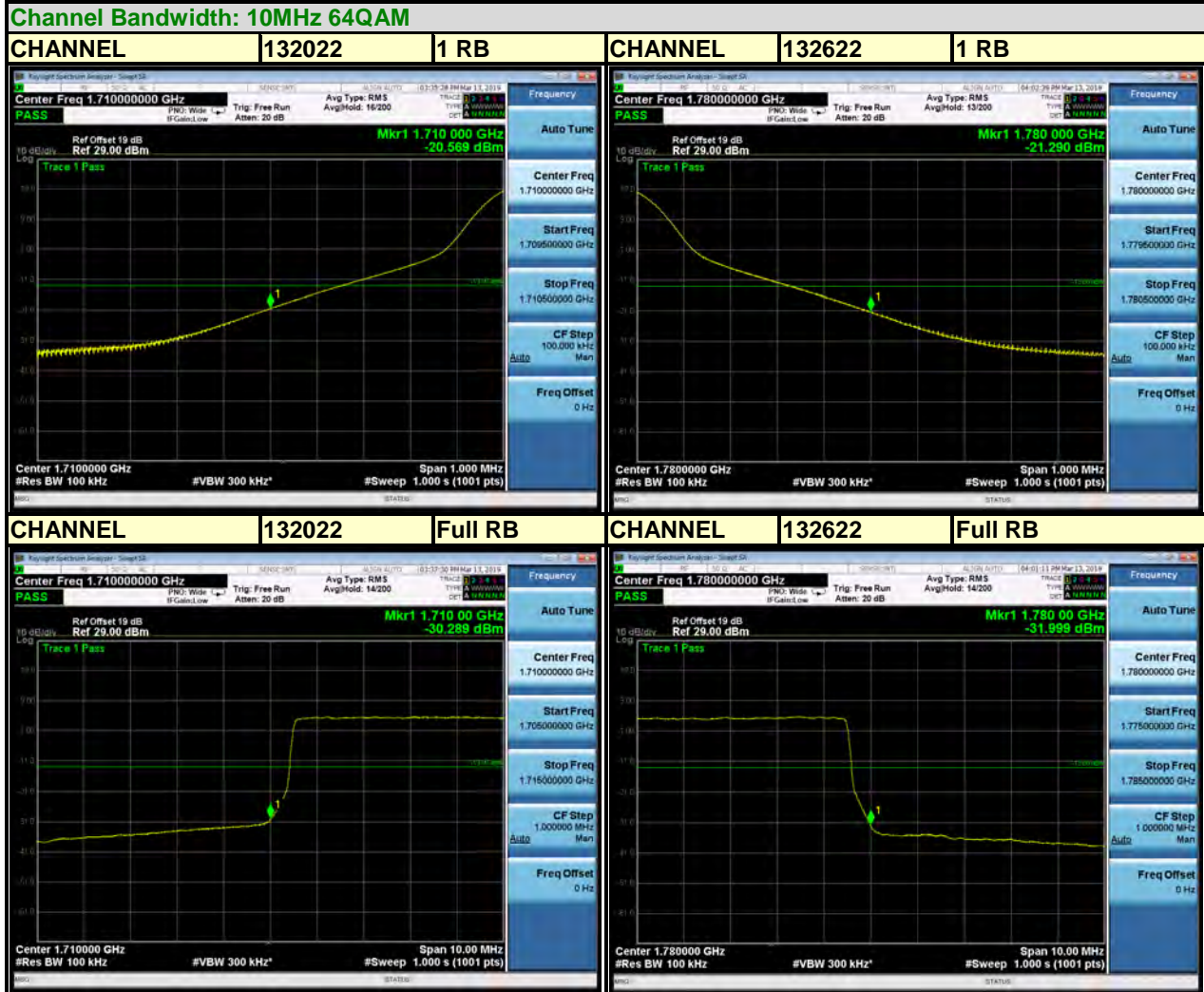



Test Report No.: RF181119W003-7

LTE BAND 66

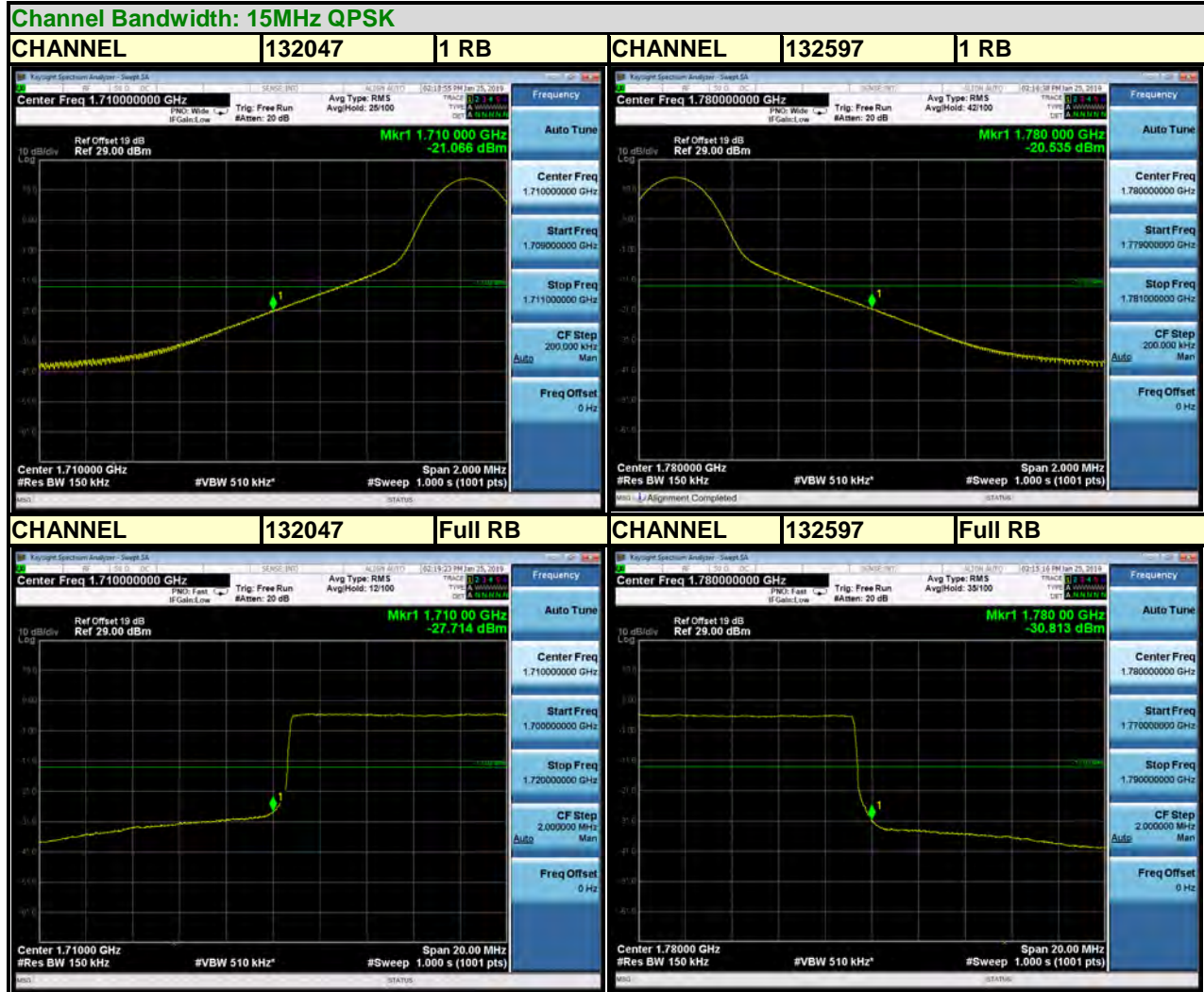



Test Report No.: RF181119W003-7

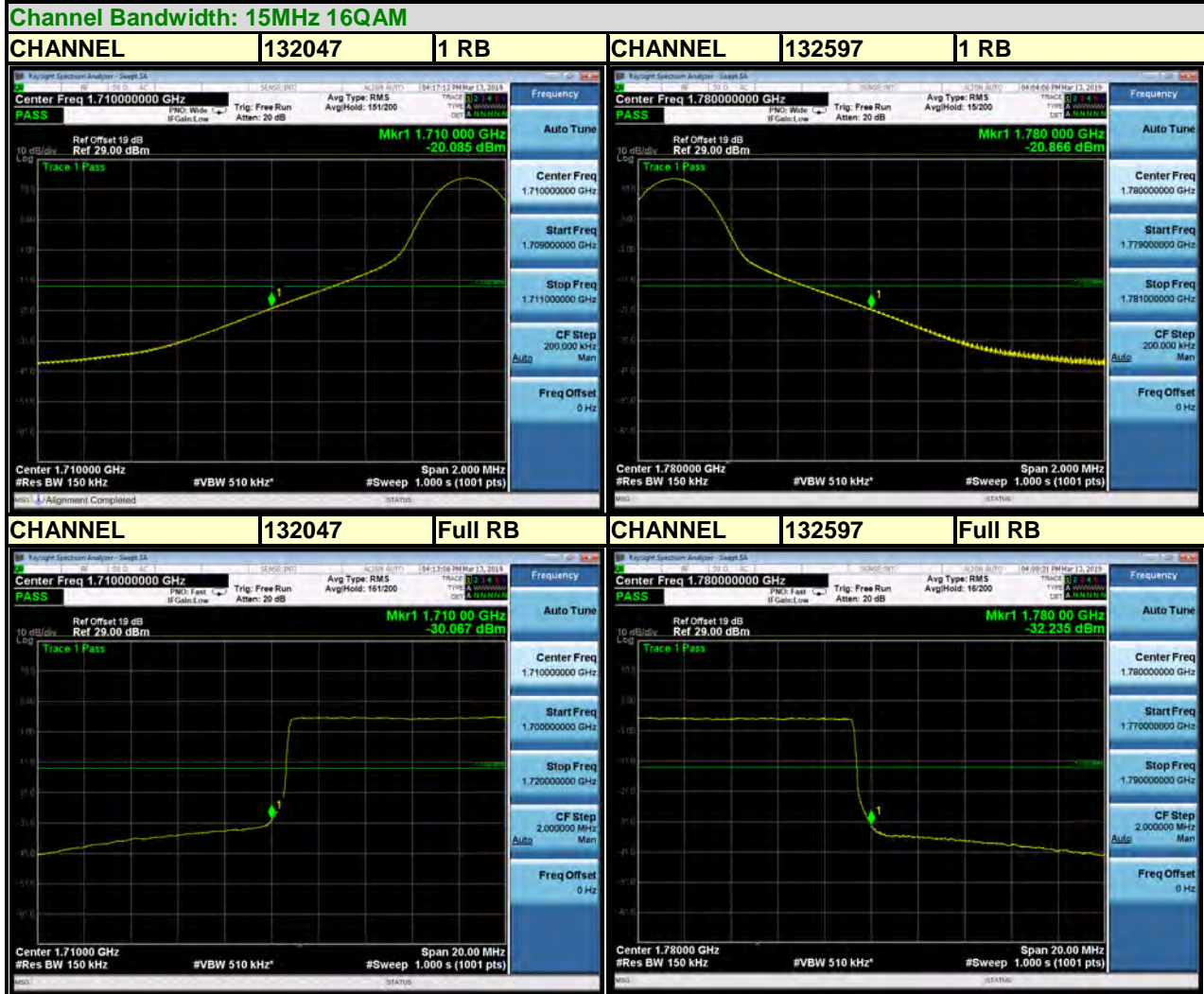



Test Report No.: RF181119W003-7





Test Report No.: RF181119W003-7

LTE BAND 66

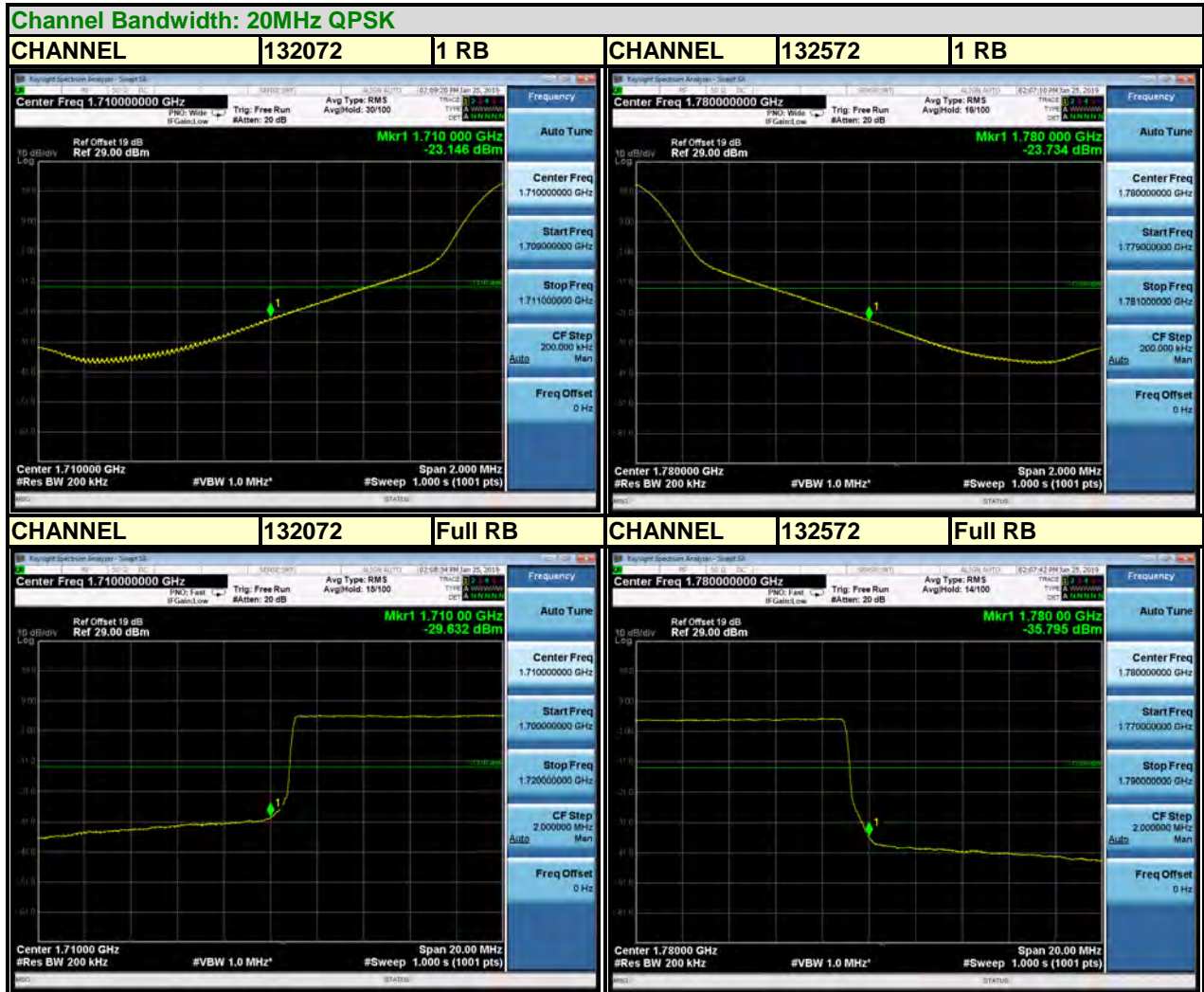



Test Report No.: RF181119W003-7





Test Report No.: RF181119W003-7



3.6 CONDUCTED SPURIOUS EMISSIONS

3.6.1 LIMITS OF CONDUCTED SPURIOUS EMISSIONS MEASUREMENT

The power of any emission outside a licensee's frequency block shall be attenuated below the transmitter power (P) by at least $43 + 10 \log_{10}(P)$ dB. The limit of emission equal to -13dBm

3.6.2 TEST PROCEDURE

- a. The EUT makes a phone call to the communication simulator. All measurements were done at middle operational frequency range.
- b. Measuring frequency range is from 30 MHz to 17.8GHz for LTE Band 66. 10dB attenuation pad is connected with spectrum. RBW=1MHz and VBW=3MHz are used for conducted emission measurement.

3.6.3 TEST SETUP

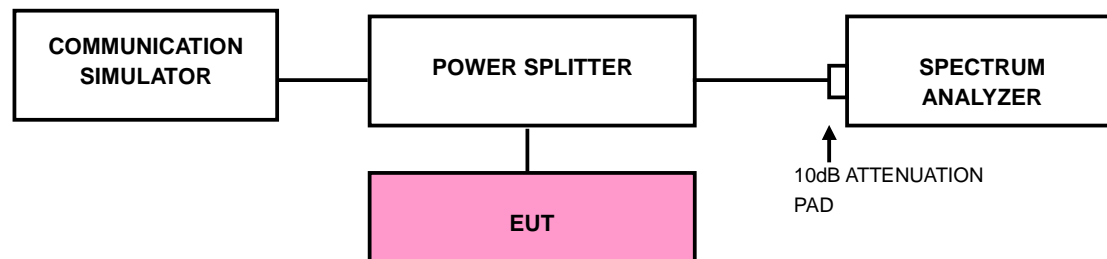



3.6.4 TEST RESULTS

LTE BAND 66

1.4MHz / QPSK

CHANNEL 131979

FREQUENCY RANGE : 30MHz~17.8GHz

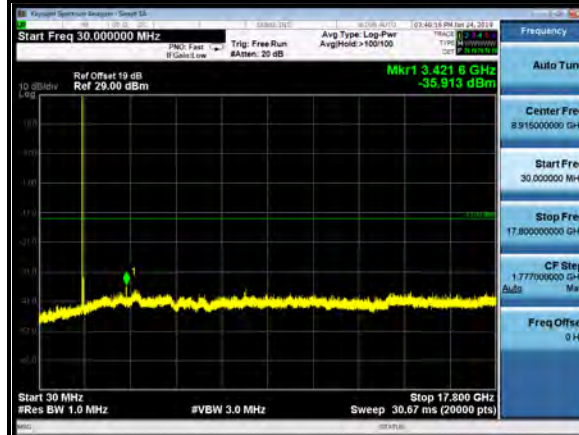

CHANNEL 132322

FREQUENCY RANGE : 30MHz~17.77GHz

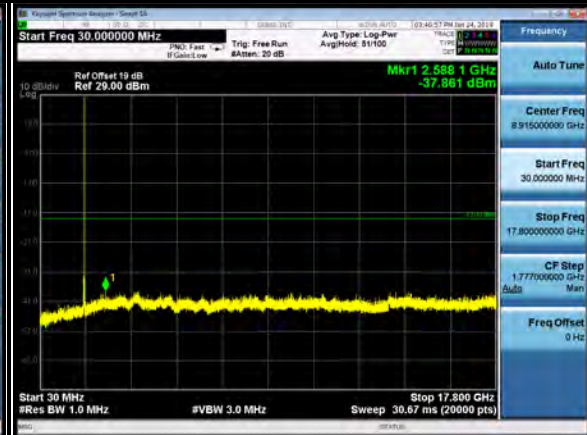

CHANNEL 132665

FREQUENCY RANGE : 30MHz~17.8GHz

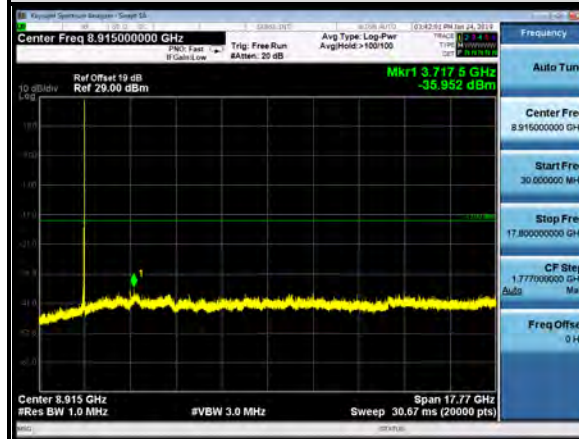



Test Report No.: RF181119W003-7

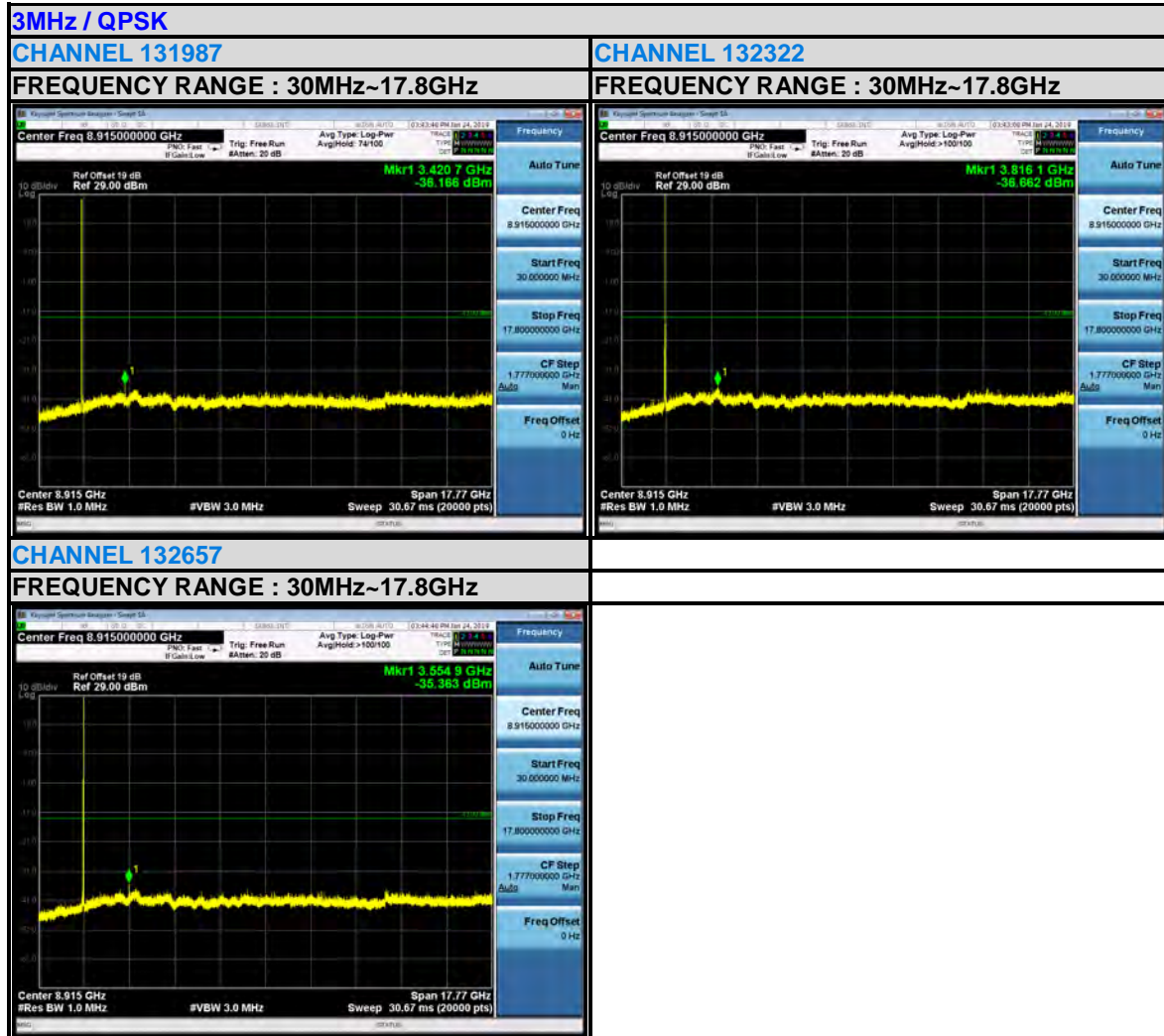



Test Report No.: RF181119W003-7





Test Report No.: RF181119W003-7





Test Report No.: RF181119W003-7





Test Report No.: RF181119W003-7





3.7 RADIATED EMISSION MEASUREMENT

3.7.1 LIMITS OF RADIATED EMISSION MEASUREMENT

The power of any emission outside a licensee's frequency block shall be attenuated below the transmitter power (P) by at least $43 + 10 \log_{10}(P)$ dB. The limit of emission equal to -13dBm

3.7.2 TEST PROCEDURES

- a. Substitution method is used for E.I.R.P measurement. In the semi-anechoic chamber, EUT placed on the 0.8m height of Turn Table, rotated the table around 360 degrees to search the maximum radiation power and receiver antenna shall be rotated vertical and horizontal polarization and moved height from 1m to 4m to find the maximum polar radiated power. The "Read Value" is the spectrum reading the maximum power value.
- b. The substitution horn antenna is substituted for EUT at the same position and signals generator export the CW signal to the substitution antenna via a TX cable. Rotated the Turn Table and moved receiving antenna to find the maximum radiation power. Adjust output power level of S.G to get a Value of spectrum reading equal to "Read Value" of step a. Record the power level of S.G
- c. $\text{EIRP} = \text{Output power level of S.G} - \text{TX cable loss} + \text{Antenna gain of substitution horn}$.
- d. E.R.P power can be calculated form E.I.R.P power by subtracting the gain of dipole,
 $\text{E.R.P power} = \text{E.I.P.R power} - 2.15\text{dBi}$.

NOTE: The resolution bandwidth of spectrum analyzer is 1 MHz and the video bandwidth is 3 MHz.

3.7.3 DEVIATION FROM TEST STANDARD

No deviation

3.7.4 TEST SETUP

<Below 30MHz>

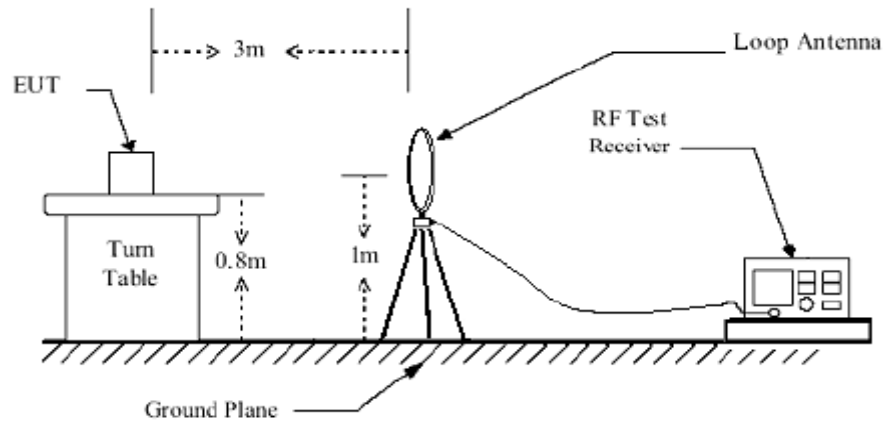

< Frequency Range 30MHz~1GHz >

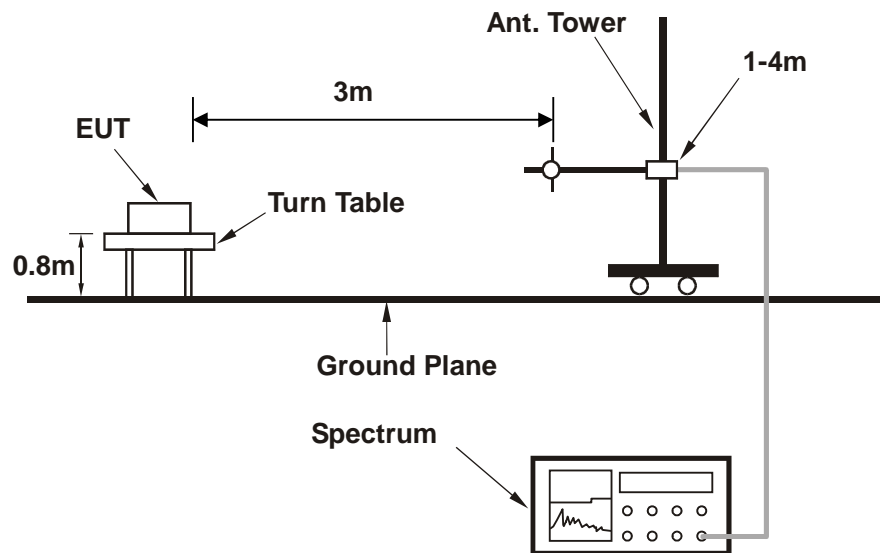

< Frequency Range above 1GHz >

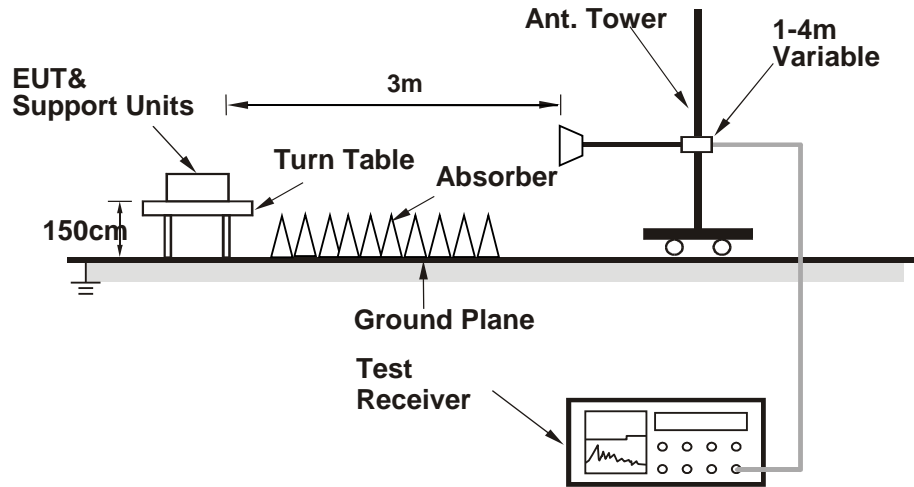

For the actual test configuration, please refer to the attached file (Test Setup Photo).



Test Report No.: RF181119W003-7

3.7.5 TEST RESULTS

BELOW 1GHz WORST-CASE DATA

9 KHz – 30 MHz data: the amplitude of spurious emissions attenuated more than 20 dB below the permissible value is not required in the report.

30 MHz – 1GHz data:

LTE Band 66:

MODE	TX channel 132322	FREQUENCY RANGE	Below 1000MHz
ENVIRONMENTAL CONDITIONS	23deg. C, 70%RH	INPUT POWER	DC 5V from adapter
TESTED BY	Rose Ma		
ANTENNA POLARITY & TEST DISTANCE: HORIZONTAL AT 3 M			

	Freq	Level	Read Level	Limit Line	Over Limit	Factor	Remark	Pol/Phase
	MHz	dBm/m	dBm	dBm/m	dB	dB/m		
1 PP	42.350	-46.16	-56.17	-13.00	-33.16	10.01	Peak	Horizontal
2	88.560	-60.09	-51.24	-13.00	-47.09	-8.85	Peak	Horizontal
3	105.470	-55.55	-43.25	-13.00	-42.55	-12.30	Peak	Horizontal
4	135.720	-65.86	-47.89	-13.00	-52.86	-17.97	Peak	Horizontal
5	205.780	-63.71	-46.59	-13.00	-50.71	-17.12	Peak	Horizontal
6	343.720	-56.67	-44.33	-13.00	-43.67	-12.34	Peak	Horizontal

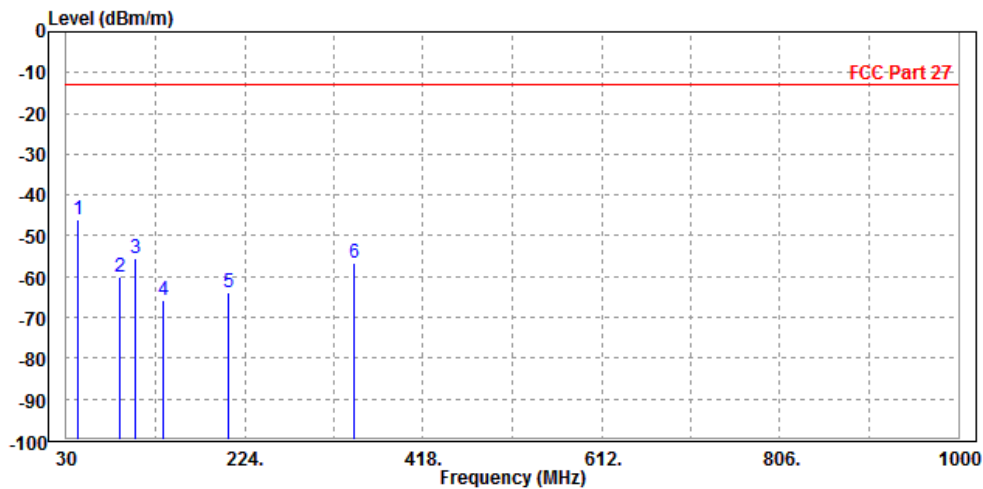



Test Report No.: RF181119W003-7

MODE	TX channel 132322	FREQUENCY RANGE	Below 1000MHz
ENVIRONMENTAL CONDITIONS	23deg. C, 70%RH	INPUT POWER	DC 5V from adapter
TESTED BY	Rose Ma		
ANTENNA POLARITY & TEST DISTANCE: VERTICAL AT 3 M			

	Freq	Level	Read Level	Limit Line	Over Limit	Factor	Remark	Pol/Phase
	MHz	dBm/m	dBm	dBm/m	dB	dB/m		
1 PP	39.780	-47.86	-46.58	-13.00	-34.86	-1.28	Peak	Vertical
2	69.940	-64.38	-48.82	-13.00	-51.38	-15.56	Peak	Vertical
3	112.790	-61.41	-49.05	-13.00	-48.41	-12.36	Peak	Vertical
4	178.870	-55.62	-42.33	-13.00	-42.62	-13.29	Peak	Vertical
5	213.650	-60.91	-50.03	-13.00	-47.91	-10.88	Peak	Vertical
6	298.160	-50.73	-39.43	-13.00	-37.73	-11.30	Peak	Vertical

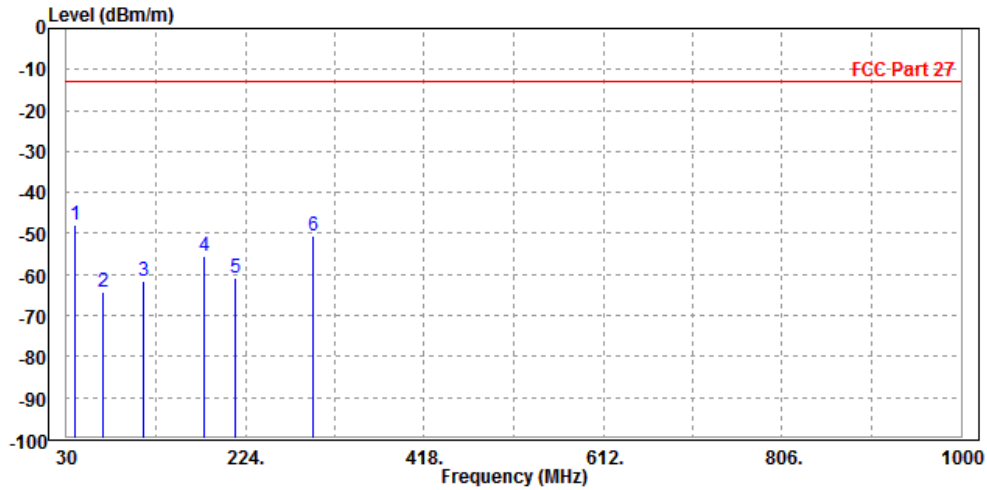



Test Report No.: RF181119W003-7

ABOVE 1GHz

Note: For higher frequency, the emission is too low to be detected.

LTE BAND 66

CHANNEL BANDWIDTH: 1.4MHz / QPSK

MODE	TX channel 132322	FREQUENCY RANGE	Above 1000MHz
ENVIRONMENTAL CONDITIONS	23deg. C, 70%RH	INPUT POWER	DC 5V from adapter
TESTED BY	Rose Ma		
ANTENNA POLARITY & TEST DISTANCE: HORIZONTAL AT 3 M			

	Freq	Level	Read Level	Limit Line	Over Limit	Factor	Remark	Pol/Phase
	MHz	dBm/m	dBm	dBm/m	dB	dB/m		
1	3522.000	-54.22	-56.49	-13.00	-41.22	2.27	Peak	Horizontal
2 PP	5265.000	-48.25	-56.94	-13.00	-35.25	8.69	Peak	Horizontal

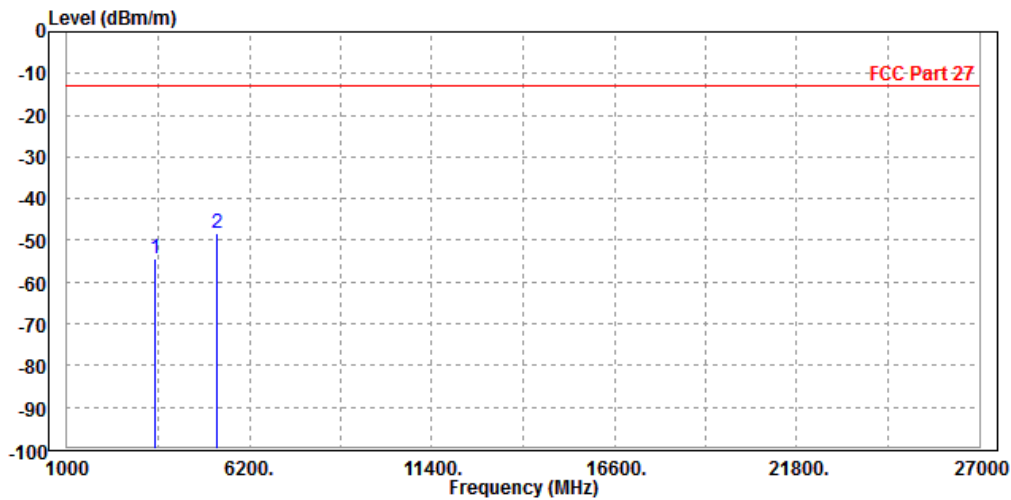



Test Report No.: RF181119W003-7

MODE	TX channel 132322	FREQUENCY RANGE	Above 1000MHz
ENVIRONMENTAL CONDITIONS	23deg. C, 70%RH	INPUT POWER	DC 5V from adapter
TESTED BY	Rose Ma		
ANTENNA POLARITY & TEST DISTANCE: VERTICAL AT 3 M			

	Freq	Level	Read Level	Limit Line	Over Limit	Factor	Remark	Pol/Phase
	MHz	dBm/m	dBm	dBm/m	dB	dB/m		
1	3522.000	-53.89	-56.57	-13.00	-40.89	2.68	Peak	Vertical
2	PP 5265.000	-49.27	-57.25	-13.00	-36.27	7.98	Peak	Vertical

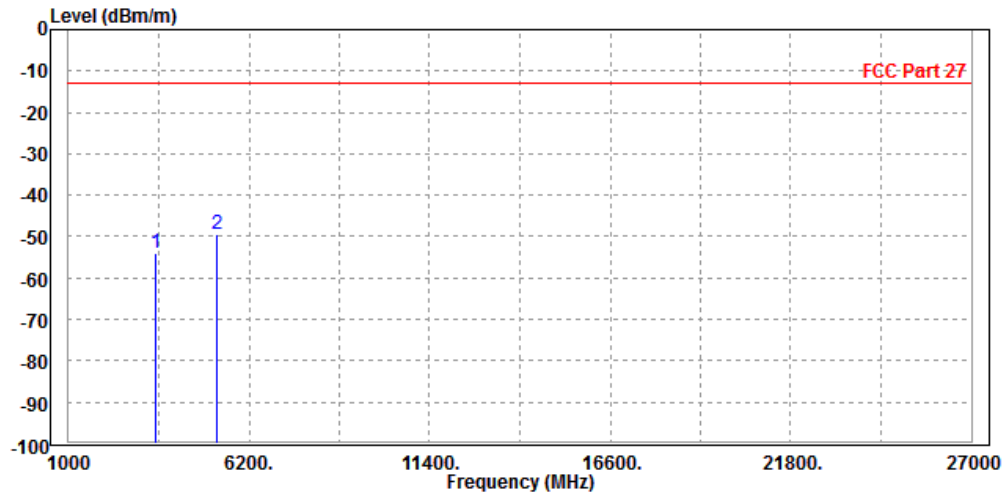



Test Report No.: RF181119W003-7

CHANNEL BANDWIDTH: 3MHz / QPSK

MODE	TX channel 132322	FREQUENCY RANGE	Above 1000MHz
ENVIRONMENTAL CONDITIONS	23deg. C, 70%RH	INPUT POWER	DC 5V from adapter
TESTED BY	Rose Ma		
ANTENNA POLARITY & TEST DISTANCE: HORIZONTAL AT 3 M			

	Freq	Level	Read Level	Limit Line	Over Limit	Factor	Remark	Pol/Phase
	MHz	dBm/m	dBm	dBm/m	dB	dB/m		
1	3522.000	-53.87	-56.14	-13.00	-40.87	2.27	Peak	Horizontal
2 PP	5265.000	-48.01	-56.70	-13.00	-35.01	8.69	Peak	Horizontal

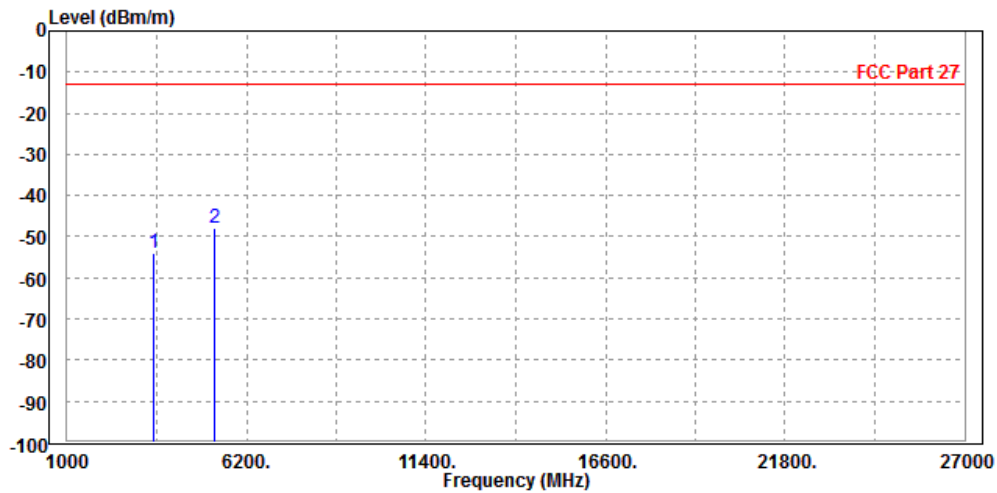



Test Report No.: RF181119W003-7

MODE	TX channel 132322	FREQUENCY RANGE	Above 1000MHz
ENVIRONMENTAL CONDITIONS	23deg. C, 70%RH	INPUT POWER	DC 5V from adapter
TESTED BY	Rose Ma		
ANTENNA POLARITY & TEST DISTANCE: VERTICAL AT 3 M			

	Freq	Level	Read Level	Limit Line	Over Limit	Factor	Remark	Pol/Phase
	MHz	dBm/m	dBm	dBm/m	dB	dB/m		
1	3522.000	-54.08	-56.76	-13.00	-41.08	2.68	Peak	Vertical
2 PP	5265.000	-49.23	-57.21	-13.00	-36.23	7.98	Peak	Vertical

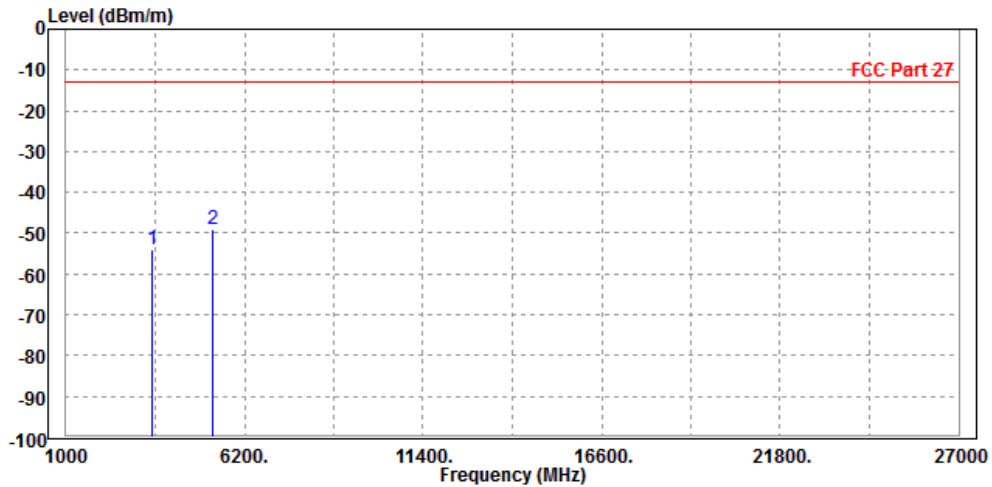



Test Report No.: RF181119W003-7

CHANNEL BANDWIDTH: 5MHz / QPSK

CH131997

MODE	TX channel 131997	FREQUENCY RANGE	Above 1000MHz
ENVIRONMENTAL CONDITIONS	23deg. C, 70%RH	INPUT POWER	DC 5V from adapter
TESTED BY	Rose Ma		
ANTENNA POLARITY & TEST DISTANCE: HORIZONTAL AT 3 M			

	Freq	Level	Read Level	Limit Line	Over Limit	Factor	Remark	Pol/Phase
	MHz	dBm/m	dBm	dBm/m	dB	dB/m		
1	3418.000	-52.17	-54.02	-13.00	-39.17	1.85	Peak	Horizontal
2 PP	5137.500	-47.12	-55.66	-13.00	-34.12	8.54	Peak	Horizontal

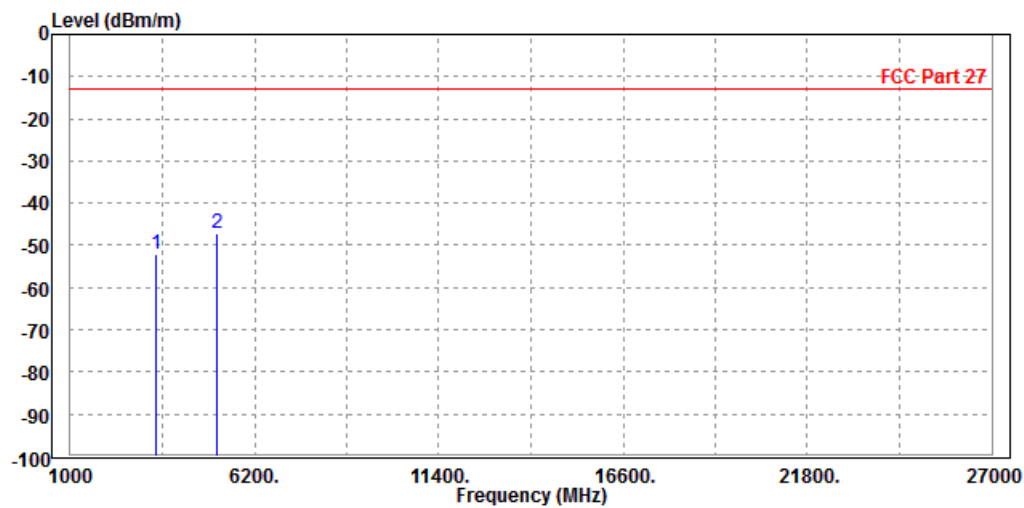



Test Report No.: RF181119W003-7

MODE	TX channel 131997	FREQUENCY RANGE	Above 1000MHz
ENVIRONMENTAL CONDITIONS	23deg. C, 70%RH	INPUT POWER	DC 5V from adapter
TESTED BY	Rose Ma		
ANTENNA POLARITY & TEST DISTANCE: VERTICAL AT 3 M			

	Freq	Level	Read Level	Limit Line	Over Limit	Factor	Remark	Pol/Phase
	MHz	dBm/m	dBm	dBm/m	dB	dB/m		
1	3418.000	-52.09	-54.56	-13.00	-39.09	2.47	Peak	Vertical
2 PP	5137.500	-49.09	-57.08	-13.00	-36.09	7.99	Peak	Vertical

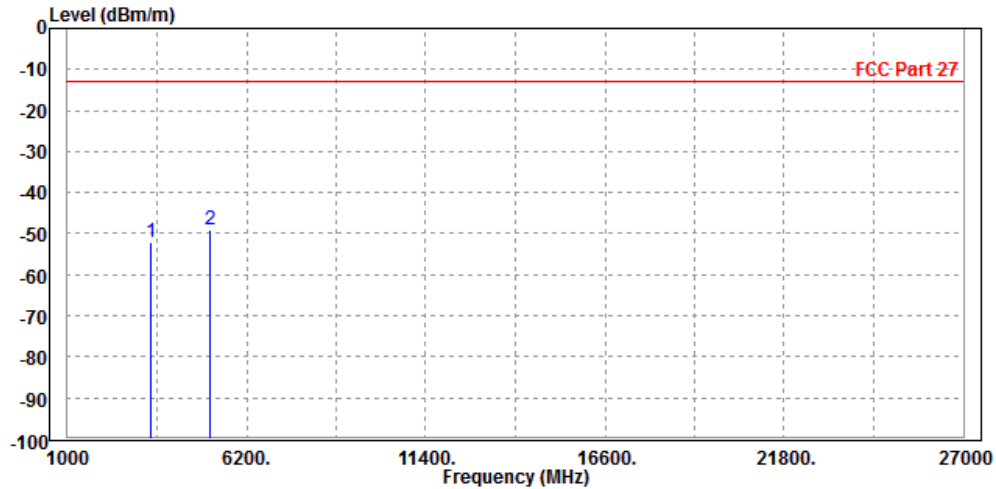



Test Report No.: RF181119W003-7

CH132322

MODE	TX channel 132322	FREQUENCY RANGE	Above 1000MHz
ENVIRONMENTAL CONDITIONS	23deg. C, 70%RH	INPUT POWER	DC 5V from adapter
TESTED BY	Rose Ma		
ANTENNA POLARITY & TEST DISTANCE: HORIZONTAL AT 3 M			

	Freq	Level	Read Level	Limit Line	Over Limit	Factor	Remark	Pol/Phase
	MHz	dBm/m	dBm	dBm/m	dB	dB/m		
1	3522.000	-53.82	-56.09	-13.00	-40.82	2.27	Peak	Horizontal
2 PP	5265.000	-48.77	-57.46	-13.00	-35.77	8.69	Peak	Horizontal

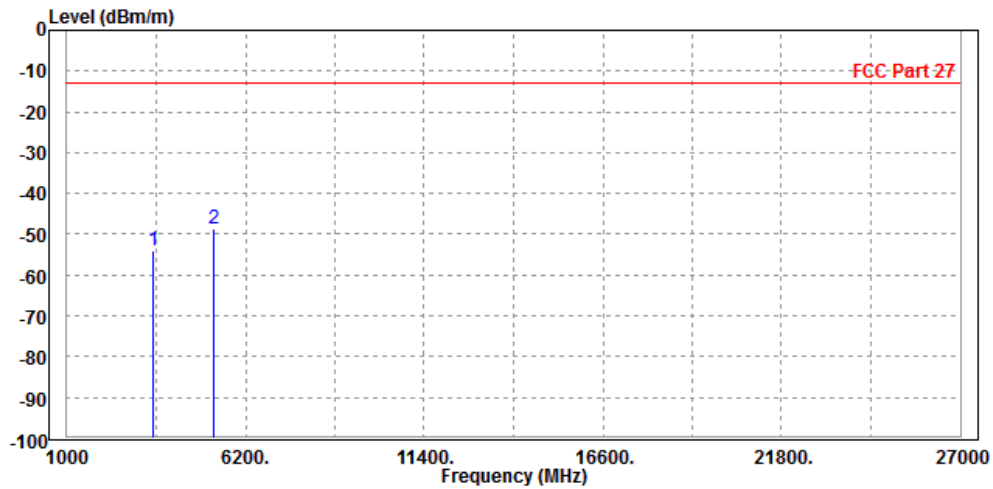



Test Report No.: RF181119W003-7

MODE	TX channel 132322	FREQUENCY RANGE	Above 1000MHz
ENVIRONMENTAL CONDITIONS	23deg. C, 70%RH	INPUT POWER	DC 5V from adapter
TESTED BY	Rose Ma		
ANTENNA POLARITY & TEST DISTANCE: VERTICAL AT 3 M			

	Freq	Level	Read Level	Limit Line	Over Limit	Factor	Remark	Pol/Phase
	MHz	dBm/m	dBm	dBm/m	dB	dB/m		
1	3522.000	-53.99	-56.67	-13.00	-40.99	2.68	Peak	Vertical
2	PP 5265.000	-47.52	-55.50	-13.00	-34.52	7.98	Peak	Vertical

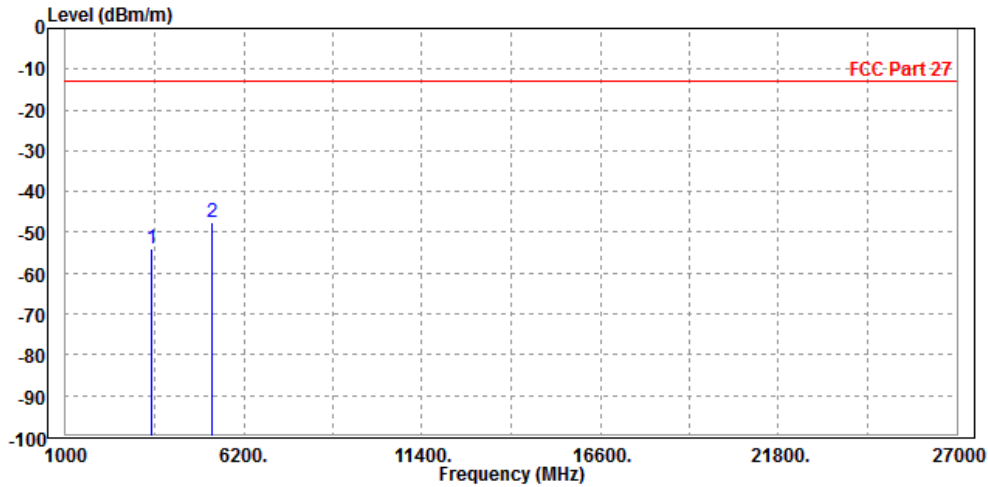



Test Report No.: RF181119W003-7

CH132647

MODE	TX channel 132647	FREQUENCY RANGE	Above 1000MHz
ENVIRONMENTAL CONDITIONS	23deg. C, 70%RH	INPUT POWER	DC 5V from adapter
TESTED BY	Rose Ma		
ANTENNA POLARITY & TEST DISTANCE: HORIZONTAL AT 3 M			

	Freq	Level	Read Level	Limit Line	Over Limit	Factor	Remark	Pol/Phase
	MHz	dBm/m	dBm	dBm/m	dB	dB/m		
1	3548.000	-53.90	-56.29	-13.00	-40.90	2.39	Peak	Horizontal
2 PP	5332.500	-48.51	-57.28	-13.00	-35.51	8.77	Peak	Horizontal

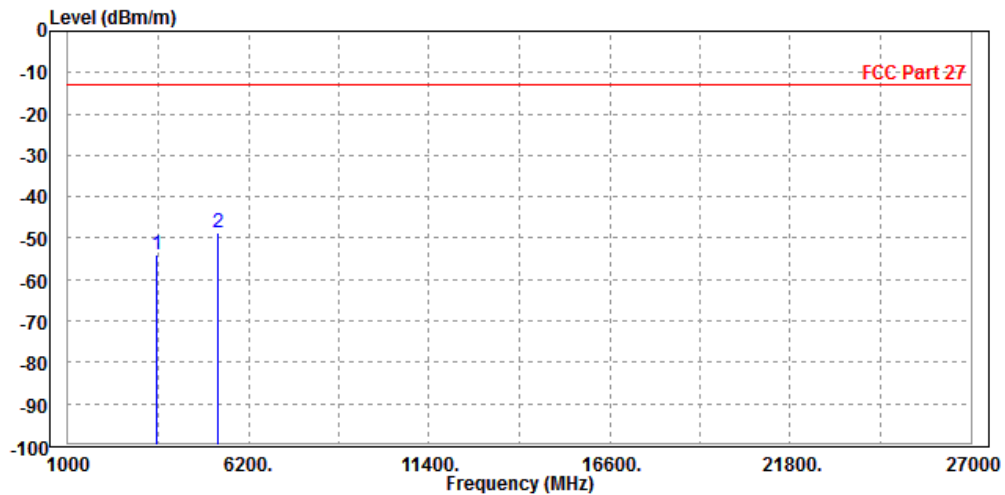



Test Report No.: RF181119W003-7

MODE	TX channel 132647	FREQUENCY RANGE	Above 1000MHz
ENVIRONMENTAL CONDITIONS	23deg. C, 70%RH	INPUT POWER	DC 5V from adapter
TESTED BY	Rose Ma		
ANTENNA POLARITY & TEST DISTANCE: VERTICAL AT 3 M			

	Freq	Level	Read Level	Limit Line	Over Limit	Factor	Remark	Pol/Phase
	MHz	dBm/m	dBm	dBm/m	dB	dB/m		
1	3548.000	-52.85	-55.66	-13.00	-39.85	2.81	Peak	Vertical
2 PP	5332.500	-49.51	-57.49	-13.00	-36.51	7.98	Peak	Vertical

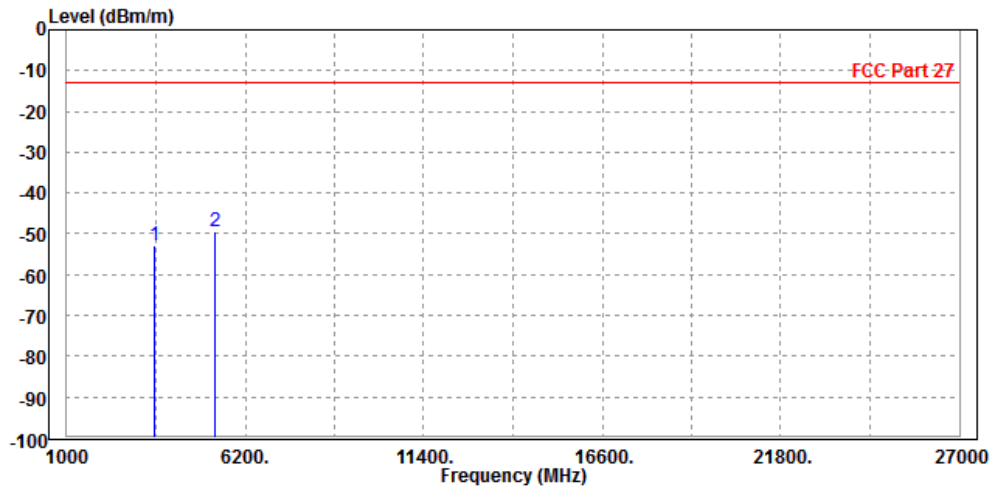



Test Report No.: RF181119W003-7

CHANNEL BANDWIDTH: 10MHz / QPSK

MODE	TX channel 132322	FREQUENCY RANGE	Above 1000MHz
ENVIRONMENTAL CONDITIONS	23deg. C, 70%RH	INPUT POWER	DC 5V from adapter
TESTED BY	Rose Ma		
ANTENNA POLARITY & TEST DISTANCE: HORIZONTAL AT 3 M			

	Freq	Level	Read Level	Limit Line	Over Limit	Factor	Remark	Pol/Phase
	MHz	dBm/m	dBm	dBm/m	dB	dB/m		
1	3522.000	-54.18	-56.45	-13.00	-41.18	2.27	Peak	Horizontal
2 PP	5265.000	-48.16	-56.85	-13.00	-35.16	8.69	Peak	Horizontal

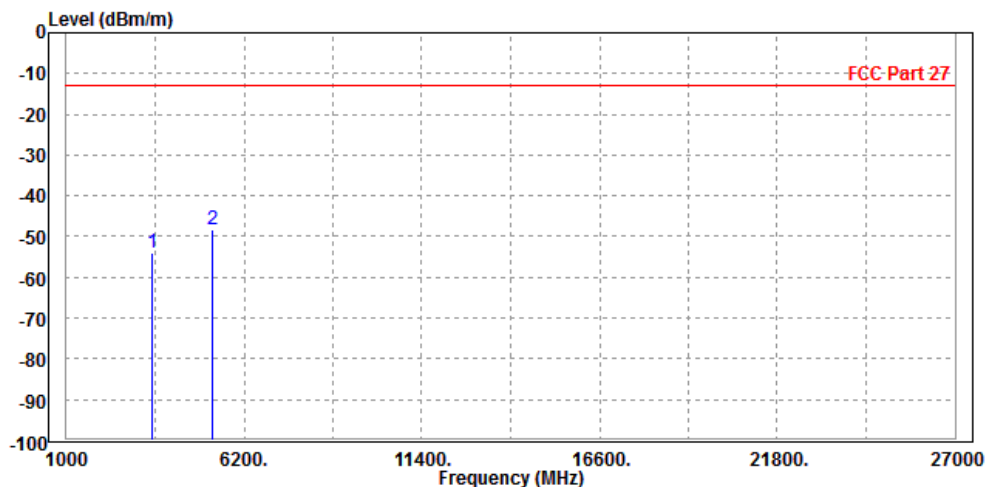



Test Report No.: RF181119W003-7

MODE	TX channel 132322	FREQUENCY RANGE	Above 1000MHz
ENVIRONMENTAL CONDITIONS	23deg. C, 70%RH	INPUT POWER	DC 5V from adapter
TESTED BY	Rose Ma		
ANTENNA POLARITY & TEST DISTANCE: VERTICAL AT 3 M			

	Freq	Level	Read Level	Limit Line	Over Limit	Factor	Remark	Pol/Phase
	MHz	dBm/m	dBm	dBm/m	dB	dB/m		
1	3522.000	-54.24	-56.92	-13.00	-41.24	2.68	Peak	Vertical
2 PP	5265.000	-49.31	-57.29	-13.00	-36.31	7.98	Peak	Vertical

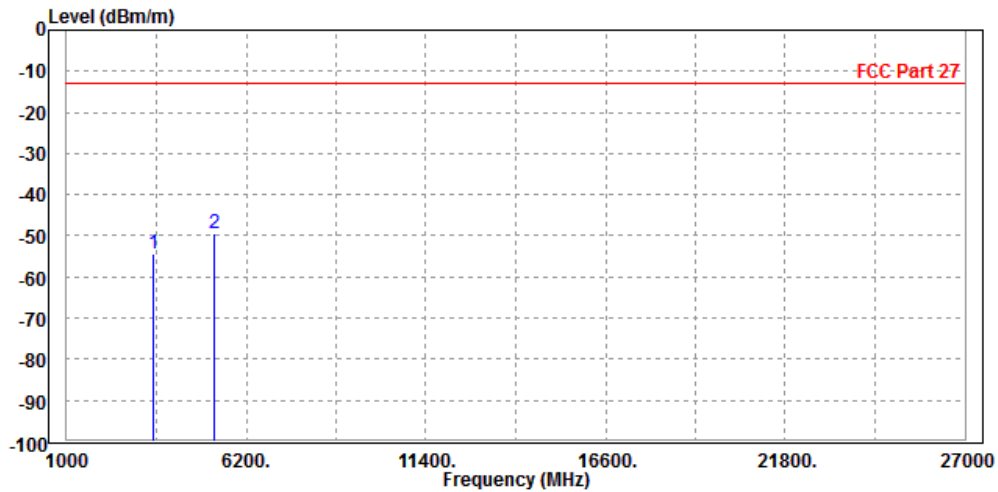



Test Report No.: RF181119W003-7

CHANNEL BANDWIDTH: 15MHz / QPSK

MODE	TX channel 132322	FREQUENCY RANGE	Above 1000MHz
ENVIRONMENTAL CONDITIONS	23deg. C, 70%RH	INPUT POWER	DC 5V from adapter
TESTED BY	Rose Ma		
ANTENNA POLARITY & TEST DISTANCE: HORIZONTAL AT 3 M			

	Freq	Level	Read Level	Limit Line	Over Limit	Factor	Remark	Pol/Phase
	MHz	dBm/m	dBm	dBm/m	dB	dB/m		
1	3522.000	-53.98	-56.25	-13.00	-40.98	2.27	Peak	Horizontal
2 PP	5265.000	-48.27	-56.96	-13.00	-35.27	8.69	Peak	Horizontal

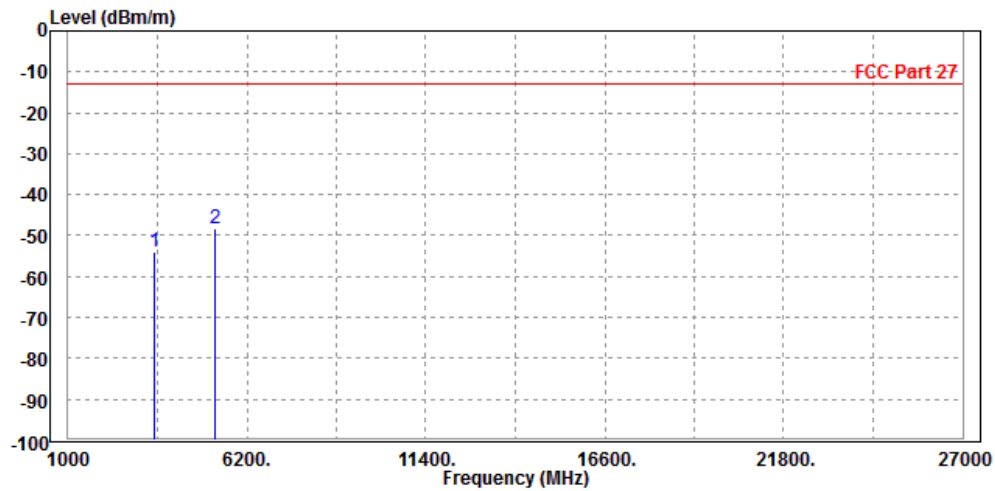



Test Report No.: RF181119W003-7

MODE	TX channel 132322	FREQUENCY RANGE	Above 1000MHz
ENVIRONMENTAL CONDITIONS	23deg. C, 70%RH	INPUT POWER	DC 5V from adapter
TESTED BY	Rose Ma		
ANTENNA POLARITY & TEST DISTANCE: VERTICAL AT 3 M			

	Freq	Level	Read Level	Limit Line	Over Limit	Factor	Remark	Pol/Phase
	MHz	dBm/m	dBm	dBm/m	dB	dB/m		
1	3522.000	-53.75	-56.43	-13.00	-40.75	2.68	Peak	Vertical
2 PP	5265.000	-49.07	-57.05	-13.00	-36.07	7.98	Peak	Vertical

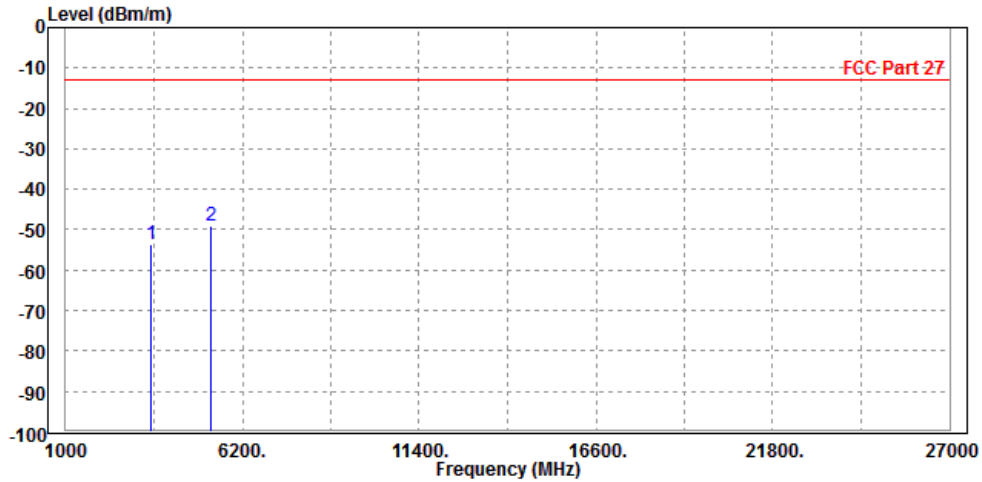



Test Report No.: RF181119W003-7

CHANNEL BANDWIDTH: 20MHz / QPSK

MODE	TX channel 132322	FREQUENCY RANGE	Above 1000MHz
ENVIRONMENTAL CONDITIONS	23deg. C, 70%RH	INPUT POWER	DC 5V from adapter
TESTED BY	Rose Ma		
ANTENNA POLARITY & TEST DISTANCE: HORIZONTAL AT 3 M			

	Freq	Level	Read Level	Limit Line	Over Limit	Factor	Remark	Pol/Phase
	MHz	dBm/m	dBm	dBm/m	dB	dB/m		
1	3522.000	-54.57	-56.84	-13.00	-41.57	2.27	Peak	Horizontal
2 PP	5265.000	-48.63	-57.32	-13.00	-35.63	8.69	Peak	Horizontal

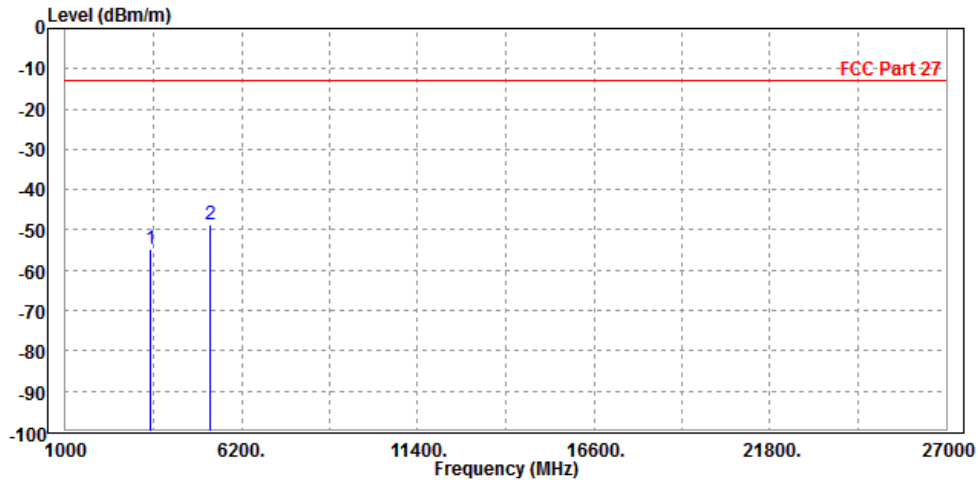



Test Report No.: RF181119W003-7

MODE	TX channel 132322	FREQUENCY RANGE	Above 1000MHz
ENVIRONMENTAL CONDITIONS	23deg. C, 70%RH	INPUT POWER	DC 5V from adapter
TESTED BY	Rose Ma		
ANTENNA POLARITY & TEST DISTANCE: VERTICAL AT 3 M			

	Freq	Level	Read Level	Limit Line	Over Limit	Factor	Remark	Pol/Phase
	MHz	dBm/m	dBm	dBm/m	dB	dB/m		
1	3522.000	-53.97	-56.65	-13.00	-40.97	2.68	Peak	Vertical
2 PP	5265.000	-49.01	-56.99	-13.00	-36.01	7.98	Peak	Vertical

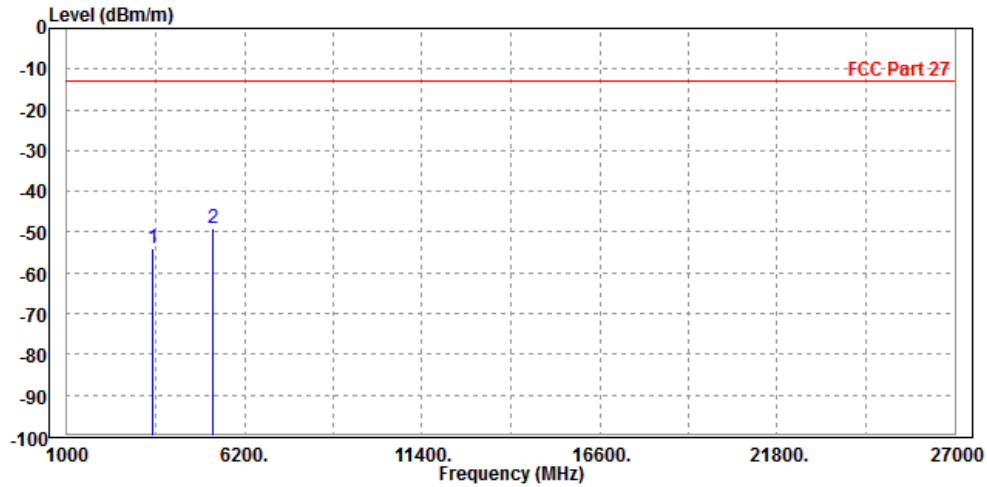



Test Report No.: RF181119W003-7

4 INFORMATION ON THE TESTING LABORATORIES

We, BV 7LAYERS COMMUNICATIONS TECHNOLOGY (SHENZHEN) CO. LTD., were founded in 2015 to provide our best service in EMC, Radio, Telecom and Safety consultation. Our laboratories are accredited and approved according to ISO/IEC 17025.

If you have any comments, please feel free to contact us at the following:

Shenzhen EMC/RF Lab:

Tel: +86-755-88696566

Fax: +86-755-88696577

Email: customerservice.dg@cn.bureauveritas.com

Web Site: www.adt.com.tw

The address and road map of all our labs can be found in our web site also.



Test Report No.: RF181119W003-7

5 APPENDIX A – MODIFICATIONS RECORDERS FOR ENGINEERING CHANGES TO THE EUT BY THE LAB

No modifications were made to the EUT by the lab during the test.

---END---