



Test Report No.: RF181120W002-5

FCC TEST REPORT (PART 27)



Applicant:	TCL Communication Ltd.
Address:	7/F, Block F4, TCL Communication Technology Building, TCL International E City, Zhong Shan Yuan Road, Nanshan District, Shenzhen, Guangdong, P.R. China 518052

Manufacturer or Supplier:	TCL Communication Ltd.
Address:	7/F, Block F4, TCL Communication Technology Building, TCL International E City, Zhong Shan Yuan Road, Nanshan District, Shenzhen, Guangdong, P.R. China 518052
Product:	UMTS/GSM Smartphone
Brand Name:	Alcatel
Model Name:	5003G
FCC ID:	2ACCJB105
Date of tests:	Nov. 21, 2018 ~ Dec. 19, 2018

The tests have been carried out according to the requirements of the following standard:

- FCC Part 27, Subpart C, L ANSI/TIA/EIA-603- D
- FCC Part 2 ANSI/TIA/EIA-603-E ANSI C63.26-2015

CONCLUSION: The submitted sample was found to COMPLY with the test requirement

Prepared by Roger Li Engineer / Mobile Department	Approved by Sam Tung Manager / Mobile Department
	
Date: Dec. 20, 2018	Date: Dec. 20, 2018

This report is governed by, and incorporates by reference, CPS Conditions of Service as posted at the date of issuance of this report at <http://www.bureauveritas.com/home/about-us/our-business/gps/about-us/terms-conditions> and is intended for your exclusive use. Any copying or replication of this report to or for any other person or entity, or use of our name or trademark, is permitted only with our prior written permission. This report sets forth our findings solely with respect to the test samples identified herein. The results set forth in this report are not indicative or representative of the quality or characteristics of the lot from which a test sample was taken or any similar or identical product unless specifically and expressly noted. Our report includes all of the tests requested by you and the results thereof based upon the information that you provided to us. Measurement uncertainty is only provided upon request for accredited tests. You have 60 days from date of issuance of this report to notify us of any material error or omission caused by our negligence or if you require measurement uncertainty; provided, however, that such notice shall be in writing and shall specifically address the issue you wish to raise. A failure to raise such issue within the prescribed time shall constitute your unqualified acceptance of the completeness of this report, the tests conducted and the correctness of the report contents.



TABLE OF CONTENTS

RELEASE CONTROL RECORD 4

1 SUMMARY OF TEST RESULTS 5

1.1 MEASUREMENT UNCERTAINTY 5

1.2 TEST SITE AND INSTRUMENTS 6

2 GENERAL INFORMATION..... 7

2.1 GENERAL DESCRIPTION OF EUT 7

2.2 CONFIGURATION OF SYSTEM UNDER TEST 8

2.3 DESCRIPTION OF SUPPORT UNITS 9

2.4 DESCRIPTION OF TEST MODES..... 9

2.5 GENERAL DESCRIPTION OF APPLIED STANDARDS 10

3 TEST TYPES AND RESULTS11

3.1 OUTPUT POWER MEASUREMENT11

3.1.1 LIMITS OF OUTPUT POWER MEASUREMENT11

3.1.2 TEST PROCEDURES11

3.1.3 TEST SETUP 12

3.1.4 TEST RESULTS 13

3.2 FREQUENCY STABILITY MEASUREMENT 15

3.2.1 LIMITS OF FREQUENCY STABILITY MEASUREMENT..... 15

3.2.2 TEST PROCEDURE..... 15

3.2.3 TEST SETUP..... 15

3.2.4 TEST RESULTS 16

3.3 OCCUPIED BANDWIDTH MEASUREMENT 17

3.3.1 LIMITS OF OCCUPIED BANDWIDTH MEASUREMENT 17

3.3.2 TEST SETUP..... 17

3.3.3 TEST PROCEDURES 17

3.3.4 TEST RESULTS 18

3.4 PEAK TO AVERAGE RATIO 19

3.4.1 LIMITS OF PEAK TO AVERAGE RATIO MEASUREMENT..... 19

3.4.2 TEST SETUP..... 19

3.4.3 TEST PROCEDURES 19

3.4.4 TEST RESULTS 20

3.5 BAND EDGE MEASUREMENT 23

3.5.1 LIMITS OF BAND EDGE MEASUREMENT..... 23

3.5.2 TEST SETUP..... 23

3.5.3 TEST PROCEDURES 24

3.5.4 TEST RESULTS 24

3.6 CONDUCTED SPURIOUS EMISSIONS..... 25

3.6.1 LIMITS OF CONDUCTED SPURIOUS EMISSIONS MEASUREMENT 25

3.6.2 TEST PROCEDURE..... 25

3.6.3 TEST SETUP..... 25

3.6.4 TEST RESULTS 26

3.7 RADIATED EMISSION MEASUREMENT 27

3.7.1 LIMITS OF RADIATED EMISSION MEASUREMENT 27

3.7.2 TEST PROCEDURES 27

3.7.3 DEVIATION FROM TEST STANDARD 27

3.7.4 TEST SETUP..... 28

3.7.5 TEST RESULTS 30



Test Report No.: RF181120W002-5

4	INFORMATION ON THE TESTING LABORATORIES	38
5	APPENDIX A – MODIFICATIONS RECORDERS FOR ENGINEERING CHANGES TO THE EUT BY THE LAB	39



Test Report No.: RF181120W002-5

RELEASE CONTROL RECORD

ISSUE NO.	REASON FOR CHANGE	DATE ISSUED
RF181120W002-5	Original release	Dec. 20, 2018

1 SUMMARY OF TEST RESULTS

The EUT has been tested according to the following specifications:

APPLIED STANDARD: FCC Part 27 & Part 2			
STANDARD SECTION	TEST TYPE AND LIMIT	RESULT	REMARK
2.1046 27.50(d)(4)	Maximum Peak Output Power	PASS	Meet the requirement of limit.
2.1055 27.54	Frequency Stability	PASS	Meet the requirement of limit.
2.1049 27.53(h)	Occupied Bandwidth	PASS	Meet the requirement of limit.
27.50(d)(5)	Peak to average ratio	PASS	Meet the requirement of limit.
27.53(h)	Band Edge Measurements	PASS	Meet the requirement of limit.
2.1051 27.53(h)	Conducted Spurious Emissions	PASS	Meet the requirement of limit.
2.1053 27.53(h)	Radiated Spurious Emissions	PASS	Meet the requirement of limit. Minimum passing margin is -21.47dB at 45.120MHz.

1.1 MEASUREMENT UNCERTAINTY

Where relevant, the following measurement uncertainty levels have been estimated for tests performed on the EUT as specified in CISPR 16-4-2:

MEASUREMENT	FREQUENCY	UNCERTAINTY
Conducted emissions	9kHz~30MHz	2.66dB
Radiated emissions	9KHz ~ 30MHz	2.68dB
	30MHz ~ 1GMHz	3.26dB
	1GHz ~ 18GHz	4.48dB
	18GHz ~ 40GHz	4.12dB

This uncertainty represents an expanded uncertainty expressed at approximately the 95% confidence level using a coverage factor of k=2.



1.2 TEST SITE AND INSTRUMENTS

Equipment	Manufacturer	Model No.	Serial No.	Last Cal.	Next Cal.
MXE EMI Receiver	KEYSIGHT	N9038A-544	MY54450026	Mar. 16,18	Mar. 15,19
EXA Signal Analyzer	KEYSIGHT	N9010A-526	MY54510322	Mar. 16,18	Mar. 15,19
Bilog Antenna 1	ETS-LINDGREN	3143B	00161964	Mar. 15,18	Mar. 14,19
Bilog Antenna 2	ETS-LINDGREN	3143B	00161965	Mar. 15,18	Mar. 14,19
Horn Antenna 1	ETS-LINDGREN	3117	00168728	Mar. 15,18	Mar. 14,19
Horn Antenna 2	ETS-LINDGREN	3117	00168692	Nov. 30, 18	Nov. 29, 19
Loop antenna	Daze	ZN30900A	0708	Oct. 23,18	Oct. 22, 19
Horn Antenna (18GHz-40GHz)	N/A	QWH-SL-18-40-K-SG/QMS-00361	15433	Nov. 21, 18	Nov. 20, 19
Radio Communication Analyzer	ANRITSU	MT8820C	6201465426	Mar. 02,18	Mar. 01,19
Signal Pre-Amplifier	EMSI	EMC 9135	980249	Jul. 09,18	Jul. 08,19
Signal Pre-Amplifier	EMSI	EMC 012645B	980257	Jul. 09,18	Jul. 08,19
Signal Pre-Amplifier	EMSI	EMC 184045B	980259	Jul. 09,18	Jul. 08,19
3m Semi-anechoic Chamber	ETS-LINDGREN	9m*6m*6m	Euroshieldpn-CT0001143-1216	Apr. 21,18	Apr. 20,19
Test Software	E3	V 9.160323	N/A	N/A	N/A
Test Software	ADT	ADT_Radiated_V7.6.15.9.2	N/A	N/A	N/A
10dB Attenuator	JFW/USA	50HF-010-SM A	1505	Jul. 09,18	Jul. 08,19
Power Meter	Anritsu	ML2495A	1506002	Mar. 02,18	Mar. 01,19
Power Sensor	Anritsu	MA2411B	1339352	Mar. 16,18	Mar. 15,19
Humid & Temp Programmable Tester	Juyi	ITH-120-45-CP-AR	IAA1504-001	Jul. 09,18	Jul. 08,19
MXG Analog Microwave Signal Generator	KEYSIGHT	N5183A	MY50143024	Mar. 13,18	Mar. 12,19

- NOTE:**
1. The calibration interval of the above test instruments is 12 months or 24 months and the calibrations are traceable to CEPREI/CHINA, GRGT/CHINA and NIM/CHINA.
 2. The test was performed in 3m Semi-anechoic Chamber and RF Oven Room.
 3. The horn antenna is used only for the measurement of emission frequency above 1GHz if tested.
 4. The FCC Site Registration No. is 525120; The Designation No. is CN1171.

2 GENERAL INFORMATION

2.1 GENERAL DESCRIPTION OF EUT

PRODUCT	UMTS/GSM Smartphone	
BRAND NAME	Alcatel	
MODEL NAME	5003G	
TYPE NUMBER	PG2212	
POWER SUPPLY	5.0Vdc (adapter or host equipment) 3.8Vdc (Li-ion, battery)	
MODULATION TECHNOLOGY	WCDMA IV	BPSK
FREQUENCY RANGE	WCDMA IV	1712.4MHz ~ 1752.6MHz
EMISSION DESIGNATOR	WCDMA IV	4M15F9W
MAX. ERP/EIRP POWER	WCDMA IV	1119mW
ANTENNA TYPE	WCDMA IV	IFIA Antenna with 1.2dBi
HW VERSION	PIO	
SW VERSION	V1.0	
ACCESSORY DEVICE	Refer to note as below	
DATA CABLE	N/A	

NOTE:

1. For a more detailed features description, please refer to the manufacturer's specifications or the user's manual.
2. For the test results, the EUT had been tested with all conditions. But only the worst case was shown in test report.

List of Accessory:

ACCESSORIES	BRAND	MODEL	Manufacturer	SPECIFICATION
AC Adapter 1	alcatel	CBA0066AGAC5(PA-5V550mA-005)	PUAN	I/P:100-240Vac, 150mA O/P: 5Vdc, 550mA
AC Adapter 2	alcatel	CBA0066AGAC7(CY050055US-L)	chenyang	I/P:100-240Vac, 150mA O/P: 5Vdc, 550mA
Battery 1	alcatel	CAB2000080C7(TLi020F7)	VEKEN	Rating: 3.8Vdc, 2050mAh
Battery 2	alcatel	CAB2000070C1(TLi020F1)	BYD	Rating: 3.8Vdc, 2050mAh
Battery 3	alcatel	CAB2000095CA (TLi020FA)	Tianmao	Rating: 3.8Vdc, 2050mAh

2.2 CONFIGURATION OF SYSTEM UNDER TEST

FOR RADIATION EMISSION

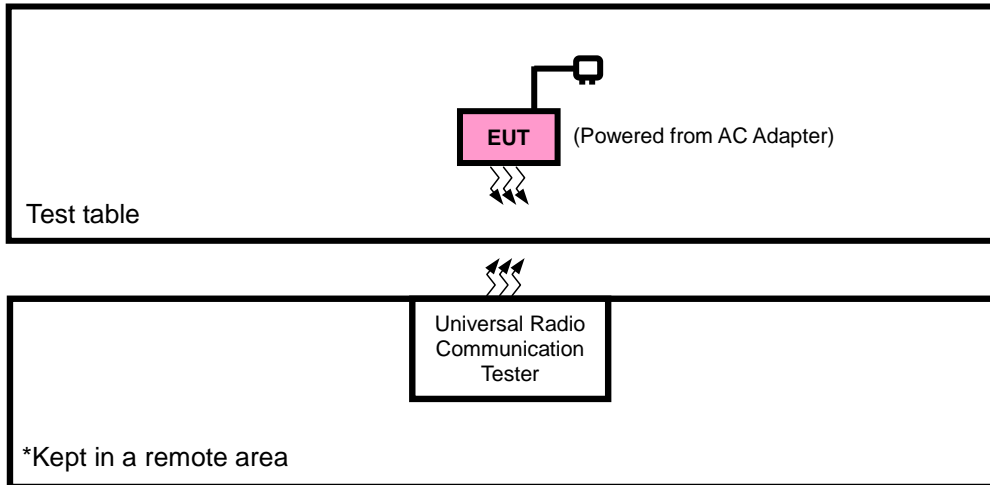

FOR CONDUCTED & E.R.P./E.I.R.P TEST

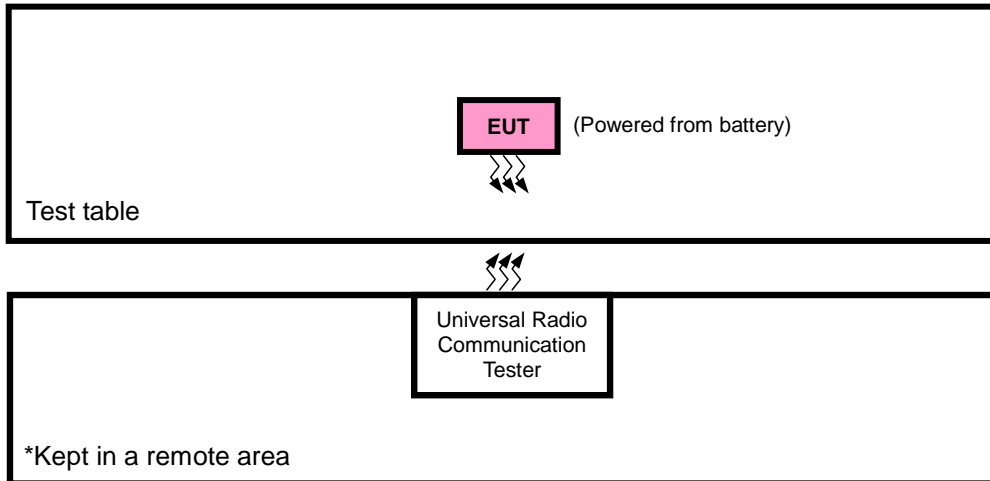

2.3 DESCRIPTION OF SUPPORT UNITS

The EUT has been tested as an independent unit together with other necessary accessories or support units. The following support units or accessories were used to form a representative test configuration during the tests.

NO.	PRODUCT	BRAND	MODEL NO.	SERIAL NO.	FCC ID
1	DC source	LONG WEI	PS-6403D	010934269	N/A
2	PC	HP	A6608CN	3CR83825X3	N/A

NO.	SIGNAL CABLE DESCRIPTION OF THE ABOVE SUPPORT UNITS
1	DC Line: Unshielded, Detachable 1.0m
2	AC Line: Unshielded, Detachable 1.5m

NOTE:

1. All power cords of the above support units are non shielded (1.8m).

2.4 DESCRIPTION OF TEST MODES

Pre-Scan has been conducted to determine the worst-case mode from all possible combinations between available modulations, data rates, XYZ axis and antenna ports. The worst case in ERP/EIRP and radiated emission was found when positioned on X-plane for WCDMA. Following channel(s) was (were) selected for the final test as listed below:

EUT CONFIGURE MODE	DESCRIPTION
A	EUT + Adapter with WCDMA link
B	EUT + Battery with WCDMA link

WCDMA MODE

EUT CONFIGURE MODE	TEST ITEM	AVAILABLE CHANNEL	TESTED CHANNEL	MODE
B	EIRP	1312 to 1513	1312, 1413, 1513	WCDMA
B	FREQUENCY STABILITY	1312 to 1513	1312, 1513	WCDMA
B	OCCUPIED BANDWIDTH	1312 to 1513	1312, 1413, 1513	WCDMA
B	BAND EDGE	1312 to 1513	1312, 1513	WCDMA
B	PEAK TO AVERAGE RATIO	1312 to 1513	1312, 1413, 1513	WCDMA
B	CONDCUDED EMISSION	1312 to 1513	1312, 1413, 1513	WCDMA
A	RADIATED EMISSION	1312 to 1513	1312, 1413, 1513	WCDMA



TEST CONDITION:

TEST ITEM	ENVIRONMENTAL CONDITIONS	INPUT POWER	TESTED BY
EIRP(ERP)	24deg. C, 60%RH	3.8Vdc from Battery	Rose Ma
FREQUENCY STABILITY	24deg. C, 61%RH	DC 3.4V/3.8V/4.35V	Rain Wang
OCCUPIED BANDWIDTH	24deg. C, 61%RH	3.8Vdc from Battery	Rain Wang
PEAK TO AVERAGE RATIO	24deg. C, 61%RH	3.8Vdc from Battery	Rain Wang
BAND EDGE	24deg. C, 61%RH	3.8Vdc from Battery	Rain Wang
CONDCUDED EMISSION	24deg. C, 61%RH	3.8Vdc from Battery	Rain Wang
RADIATED EMISSION	23deg. C, 70%RH	DC 5V from adaptor	Rose Ma

2.5 GENERAL DESCRIPTION OF APPLIED STANDARDS

The EUT is a RF product. According to the specifications of the manufacturer, it must comply with the requirements of the following standards:

FCC 47 CFR Part 2

FCC 47 CFR Part 27

KDB 971168 D01 Power Meas License Digital Systems v03

ANSI/TIA/EIA-603-D

ANSI/TIA/EIA-603-E

ANSI C63.26-2015

NOTE: All test items have been performed and recorded as per the above standards.



3 TEST TYPES AND RESULTS

3.1 OUTPUT POWER MEASUREMENT

3.1.1 LIMITS OF OUTPUT POWER MEASUREMENT

Fixed, mobile, and portable (hand-held) stations operating in the 1710–1755 MHz band are limited to 1 watt EIRP.

Portable stations (hand-held devices) operating in the 699-716 MHz and 777-7887 bands are limited to 3 watts ERP.

3.1.2 TEST PROCEDURES

EIRP / ERP MEASUREMENT:

- a. The EUT was set up for the maximum power with WCDMA link data modulation. The power was measured with R&S Spectrum Analyzer. All measurements were done at 3 channels (low, middle and high operational frequency range).
- b. E.I.R.P power measurement. In the semi-anechoic chamber, EUT placed on the 0.8m height of Turn Table, rotated the table around 360 degrees to search the maximum radiation power and receiver antenna shall be rotated vertical and horizontal polarization and moved height from 1m to 4m to find the maximum polar radiated power. The “Read Value” is the spectrum reading the maximum power value.
- c. The substitution horn antenna is substituted for EUT at the same position and signals generator export the CW signal to the substitution antenna via a TX cable. Rotated the Turn Table and moved receiving antenna to find the maximum radiation power. Adjust output power level of S.G to get a Value of spectrum reading equal to “Read Value” of step a. Record the power level of S.G
- d. $EIRP = \text{Output power level of S.G} - \text{TX cable loss} + \text{Antenna gain of substitution horn}$
- e. $E.R.P = E.I.R.P - 2.15 \text{ dB}$

CONDUCTED POWER MEASUREMENT:

- a. The EUT was set up for the maximum power with WCDMA link data modulation and link up with simulator.
- b. Set the EUT to transmit under low, middle and high channel and record the power level shown on simulator.

3.1.3 TEST SETUP

ERP MEASUREMENT:

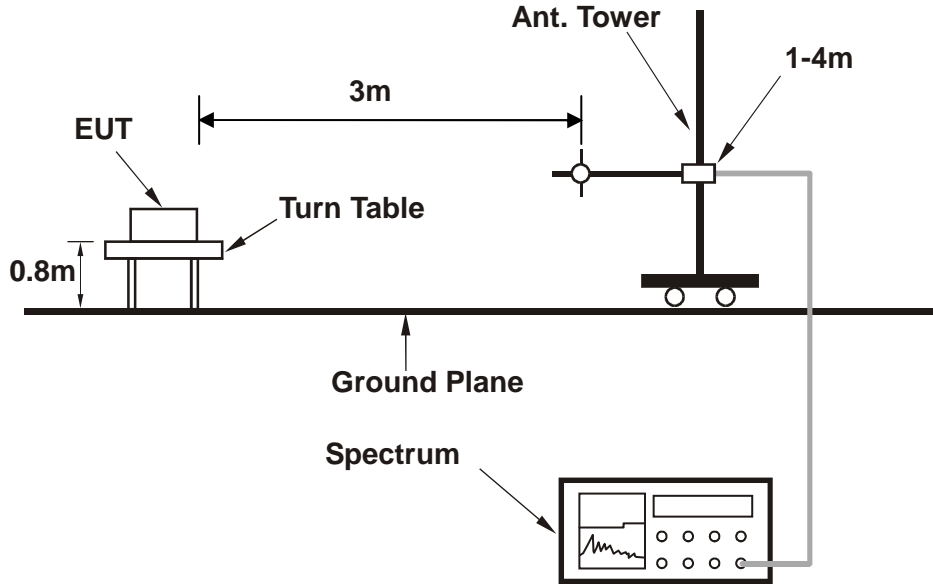

EIRP MEASUREMENT:

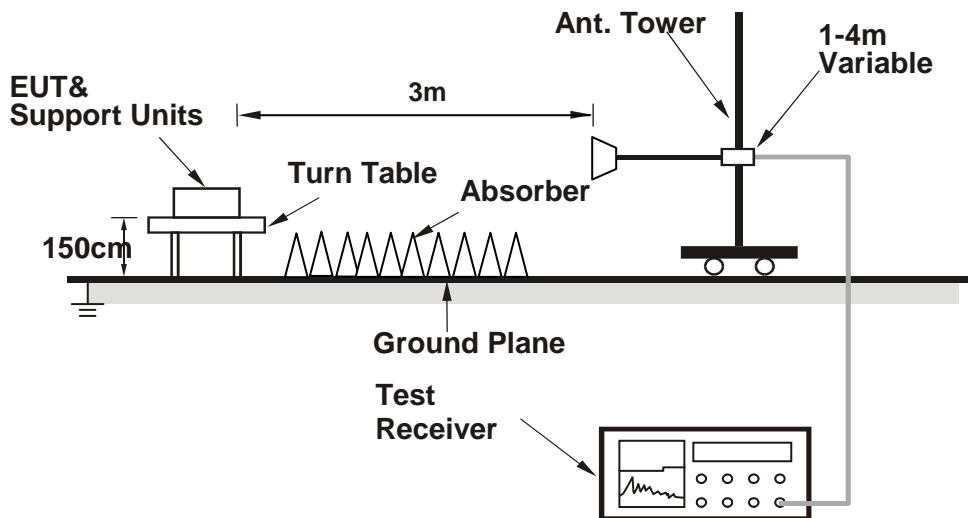

For the actual test configuration, please refer to the attached file (Test Setup Photo).

CONDUCTED POWER MEASUREMENT:



For the actual test configuration, please refer to the attached file (Test Setup Photo).



**BUREAU
VERITAS**

Test Report No.: RF181120W002-5

3.1.4 TEST RESULTS

AVERAGE CONDUCTED OUTPUT POWER (dBm)

Band	WCDMA IV		
	1312	1413	1513
Channel	1712.4	1732.6	1752.6
Frequency (MHz)	1712.4	1732.6	1752.6
RMC 12.2K	22.62	22.14	22.29
HSPA			
HSDPA Subtest-1	21.77	21.29	21.44
HSDPA Subtest-2	21.70	21.22	21.37
HSDPA Subtest-3	21.26	20.78	20.93
HSDPA Subtest-4	21.21	20.73	20.88
HSUPA Subtest-1	22.13	21.65	21.80
HSUPA Subtest-2	20.09	19.61	19.76
HSUPA Subtest-3	21.06	20.58	20.73
HSUPA Subtest-4	20.17	19.69	19.84
HSUPA Subtest-5	22.19	21.71	21.86



Test Report No.: RF181120W002-5

EIRP

WCDMA IV

Channel	Frequency (MHz)	SPA LVL (dBm)	Correction Factor(dB)	EIRP(dBm)	EIRP(mW)	Polarization (H/V)
1312	1712.40	-24.12	41.39	17.27	1119.18	H
1413	1732.60	-24.44	41.36	16.92	1095.97	H
1513	1752.60	-24.87	42.63	17.76	1110.18	H
1312	1712.4	-21.31	44.17	22.86	193.02	V
1413	1732.6	-21.67	44.20	22.53	179.06	V
1513	1752.6	-21.98	44.35	22.37	66.71	V

REMARKS: 1. EIRP Output Power (dBm) = SPA LVL (dBm) + Correction Factor (dB).
2. Correction factor (dB) = Free Space Loss + Antenna Factor + Cable Loss

3.2 FREQUENCY STABILITY MEASUREMENT

3.2.1 LIMITS OF FREQUENCY STABILITY MEASUREMENT

The frequency stability shall be sufficient to ensure that the fundamental emissions stay within the authorized bands of operation.

3.2.2 TEST PROCEDURE

- a. Device is placed at the oven room. The oven room could control the temperatures and humidity. Power warm up is at least 15 min and power applied should perform before recording frequency error.
- b. EUT is connected the external power supply to control the DC input power. The test voltage range is from minimum to maximum working voltage. Each step shall be record the frequency error rate.
- c. The temperature range step is 10 degrees in this test items. All temperature levels shall be hold the $\pm 0.5^{\circ}\text{C}$ during the measurement testing. The each temperature step shall be at least 0.5 hours, consider the EUT could be test under the stability condition.

NOTE: The frequency error was recorded frequency error from the communication simulator.

3.2.3 TEST SETUP

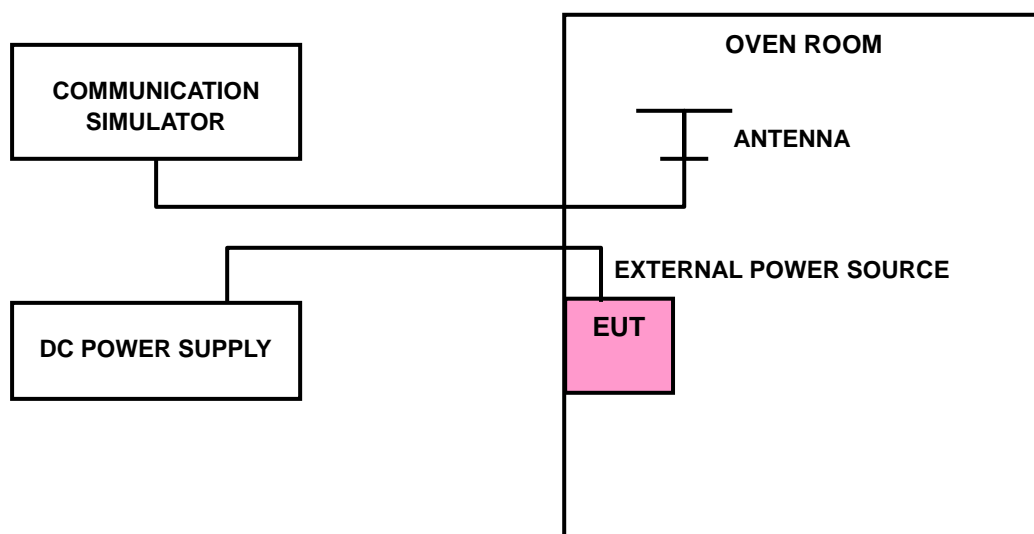

3.2.4 TEST RESULTS

WCDMA BAND IV

FREQUENCY ERROR VS. VOLTAGE

VOLTAGE (Volts)	FREQUENCY ERROR (ppm)		LIMIT (ppm)
	Low Channel	High Channel	
3.8	0.0019	0.0017	2.5
3.4	-0.0023	-0.0021	2.5
4.35	0.0019	0.0018	2.5

NOTE: The applicant defined the normal working voltage of the battery is from 3.4Vdc to 4.35Vdc.

FREQUENCY ERROR vs. TEMPERATURE.

TEMP. (°C)	FREQUENCY ERROR (ppm)		LIMIT (ppm)
	Low Channel	High Channel	
-30	-0.0128	-0.0122	2.5
-20	-0.0116	-0.0111	2.5
-10	-0.0098	-0.0094	2.5
0	-0.0087	-0.0083	2.5
10	-0.0062	-0.0059	2.5
20	-0.0050	-0.0048	2.5
30	-0.0044	-0.0042	2.5
40	-0.0027	-0.0026	2.5
50	-0.0013	-0.0013	2.5

3.3 OCCUPIED BANDWIDTH MEASUREMENT

3.3.1 LIMITS OF OCCUPIED BANDWIDTH MEASUREMENT

The width of a frequency band such that, below the lower and above the upper frequency limits, the mean powers emitted are each equal to a specified percentage 0.5 %of the total mean power of a given emission.

3.3.2 TEST SETUP

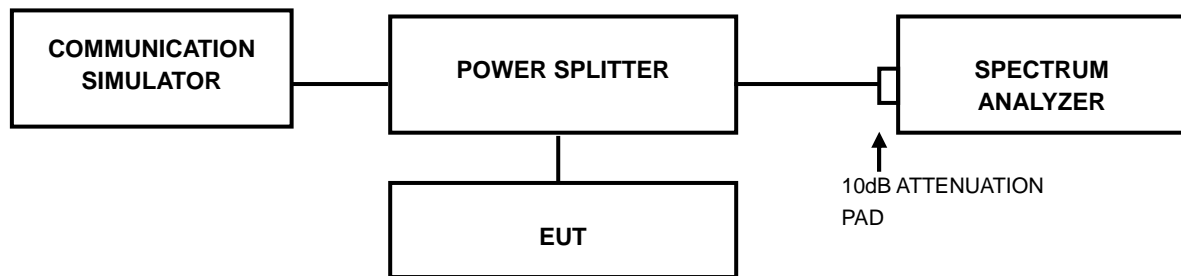

3.3.3 TEST PROCEDURES

- The conducted occupied bandwidth used the power splitter via EUT RF power connector between simulation base station and spectrum analyzer.
- Use OBW measurement function of Spectrum analyzer to measure 99 % occupied bandwidth.

3.3.4 TEST RESULTS

WCDMA BAND IV

Channel	FREQ. (MHz)	99% Occupied Bandwidth (MHz)	Channel	FREQ. (MHz)	26dB Bandwidth (MHz)
		WCDMA			WCDMA
1312	1712.40	4.13	1312	1712.40	4.65
1413	1732.60	4.14	1413	1732.60	4.64
1513	1752.60	4.15	1513	1752.60	4.65

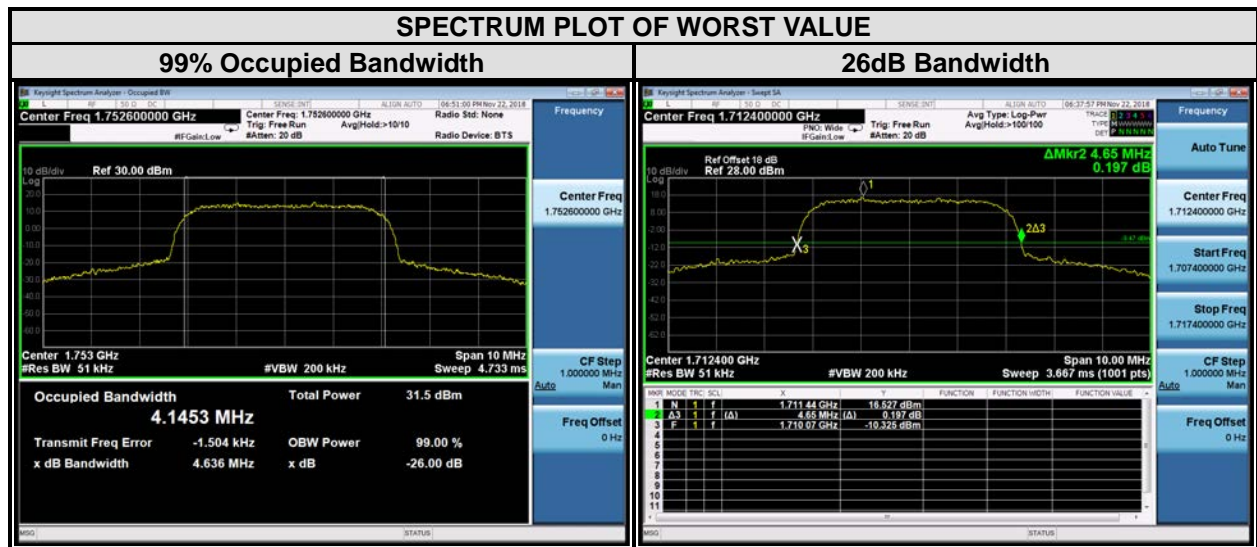

3.4 PEAK TO AVERAGE RATIO

3.4.1 LIMITS OF PEAK TO AVERAGE RATIO MEASUREMENT

In measuring transmissions in this band using an average power technique, the peak to-average ratio (PAR) of the transmission may not exceed 13 dB

3.4.2 TEST SETUP

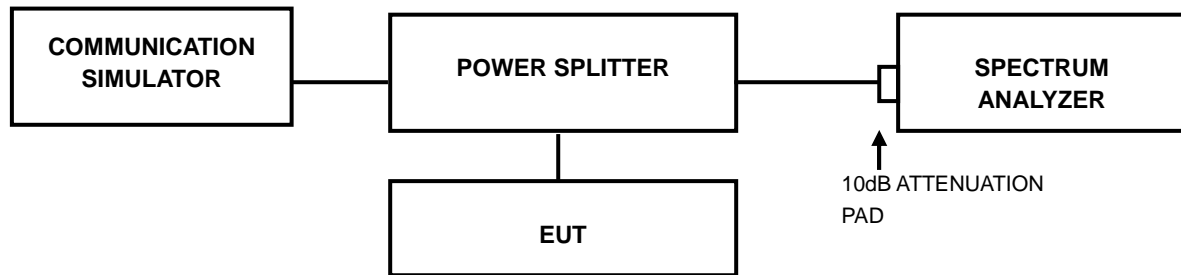

3.4.3 TEST PROCEDURES

1. Set resolution/measurement bandwidth \geq signal's occupied bandwidth;
2. Set the number of counts to a value that stabilizes the measured CCDF curve;
3. Record the maximum PAPR level associated with a probability of 0.1%.



Test Report No.: RF181120W002-5

3.4.4 TEST RESULTS

WCDMA Band IV

CHANNEL	FREQUENCY (MHz)	PEAK TO AVERAGE RATIO (dB)
1312	1712.4	3.11

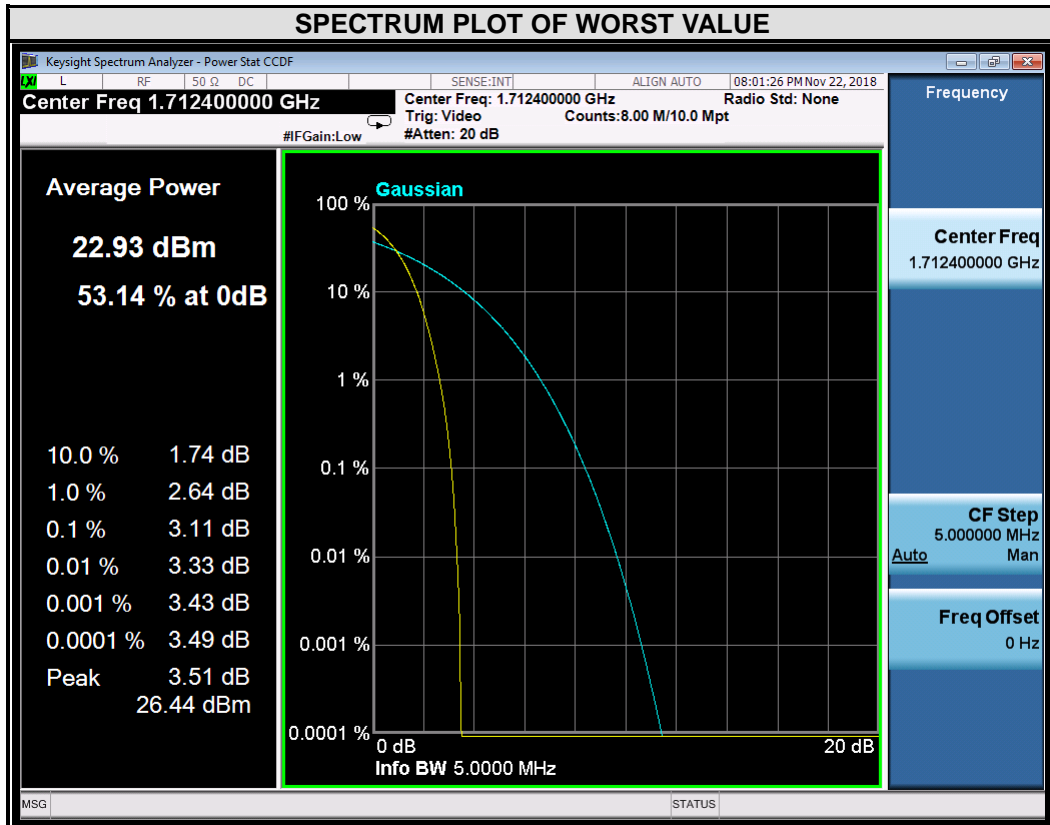



Test Report No.: RF181120W002-5

CHANNEL	FREQUENCY (MHz)	PEAK TO AVERAGE RATIO (dB)
1413	1732.6	3.12

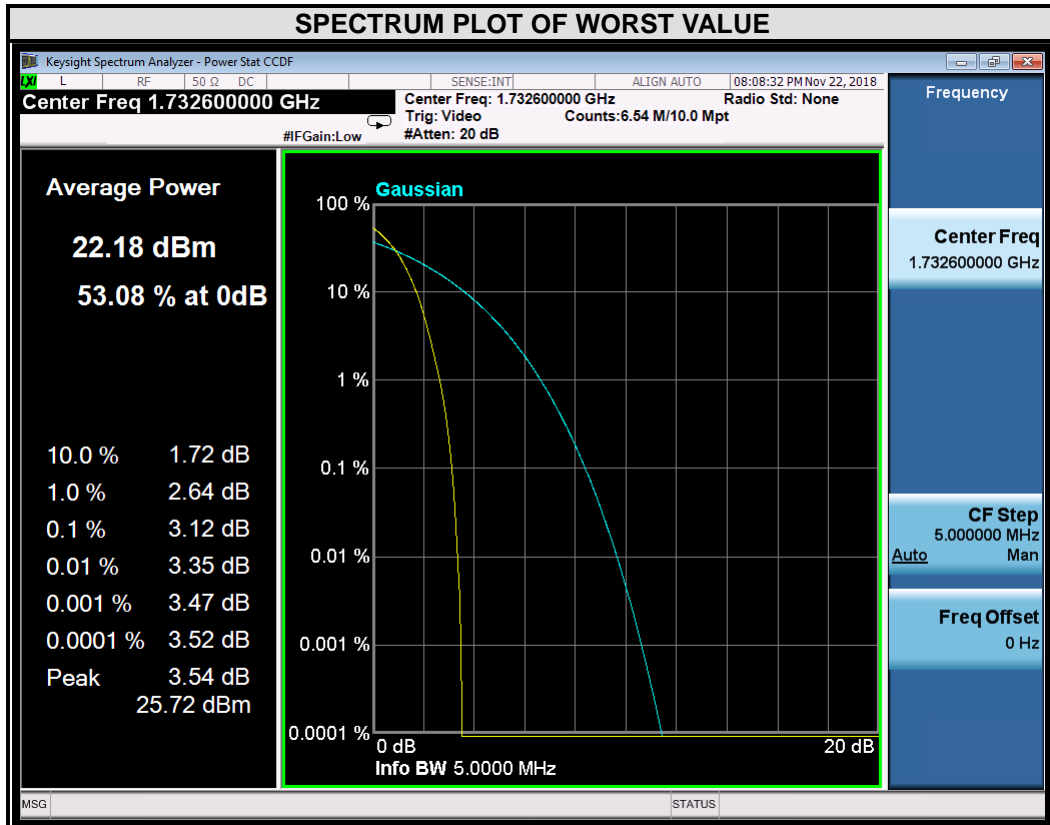



Test Report No.: RF181120W002-5

CHANNEL	FREQUENCY (MHz)	PEAK TO AVERAGE RATIO (dB)
1513	1752.6	2.92

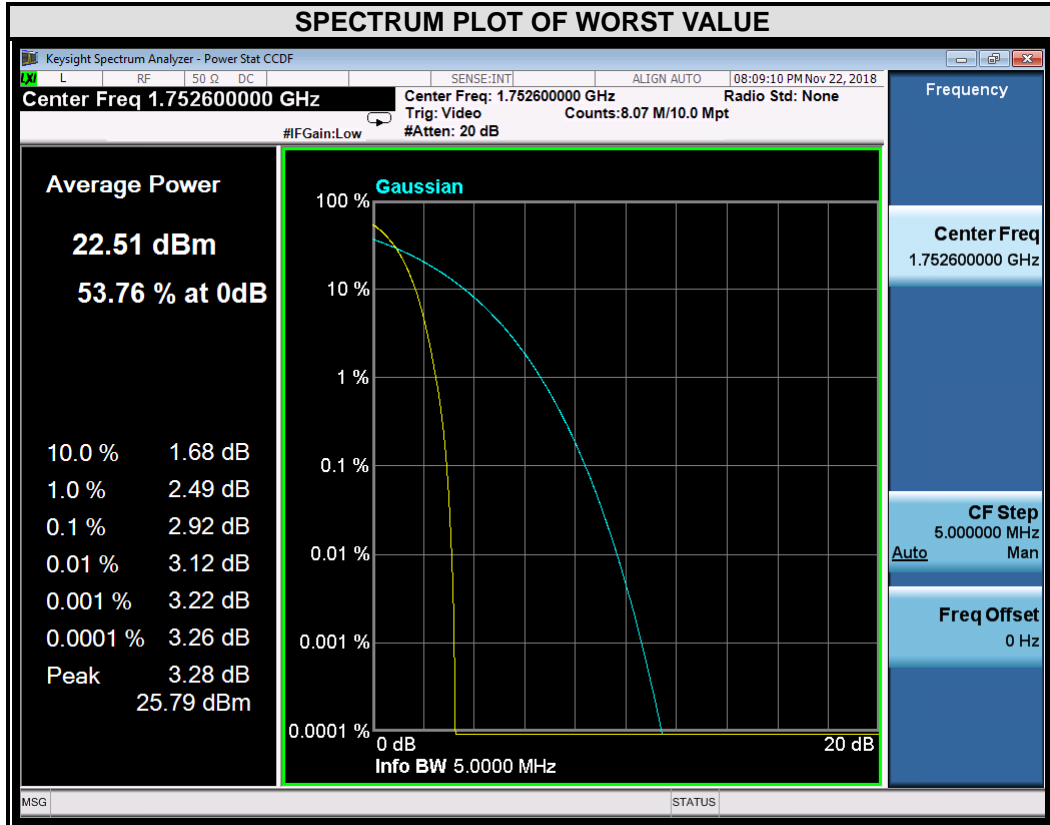

3.5 BAND EDGE MEASUREMENT

3.5.1 LIMITS OF BAND EDGE MEASUREMENT

The power of any emission outside a licensee's frequency band(s) of operation shall be attenuated below the transmitter power (P) within the licensed band(s) of operation, measured in watts, by at least $43 + 10 \log (P)$ dB. Compliance with this provision is based on the use of measurement instrumentation employing a resolution bandwidth of 100 kilohertz or greater.

However, in the 100 kilohertz bands immediately outside and adjacent to a licensee's frequency block, a resolution bandwidth of at least 30 kHz may be employed.

3.5.2 TEST SETUP

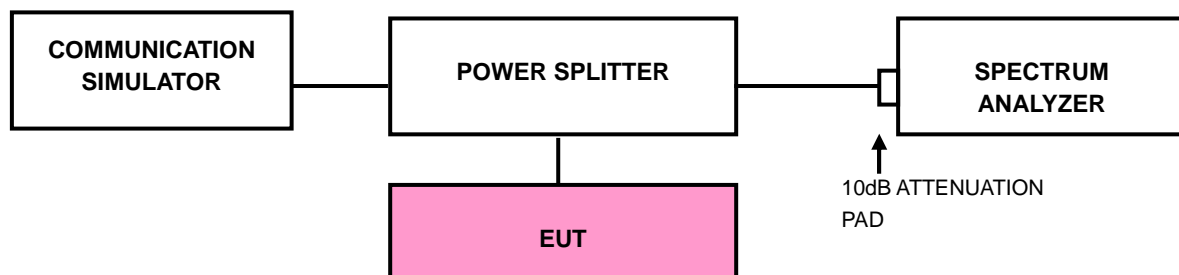

3.5.3 TEST PROCEDURES

- The EUT was set up for the maximum peak power with WCDMA link data modulation. The power was measured with R&S Spectrum Analyzer. All measurements were done at 2 channels (low and high operational frequency range.).
- The band edge measurement used the power splitter via EUT RF power connector between simulation base station and spectrum analyzer.
- The center frequency of spectrum is the band edge frequency and span is 10MHz. RBW of the spectrum is 100kHz and VBW of the spectrum is 300kHz (WCDMA).
- Record the max trace plot into the test report.

3.5.4 TEST RESULTS

WCDMA BAND 4

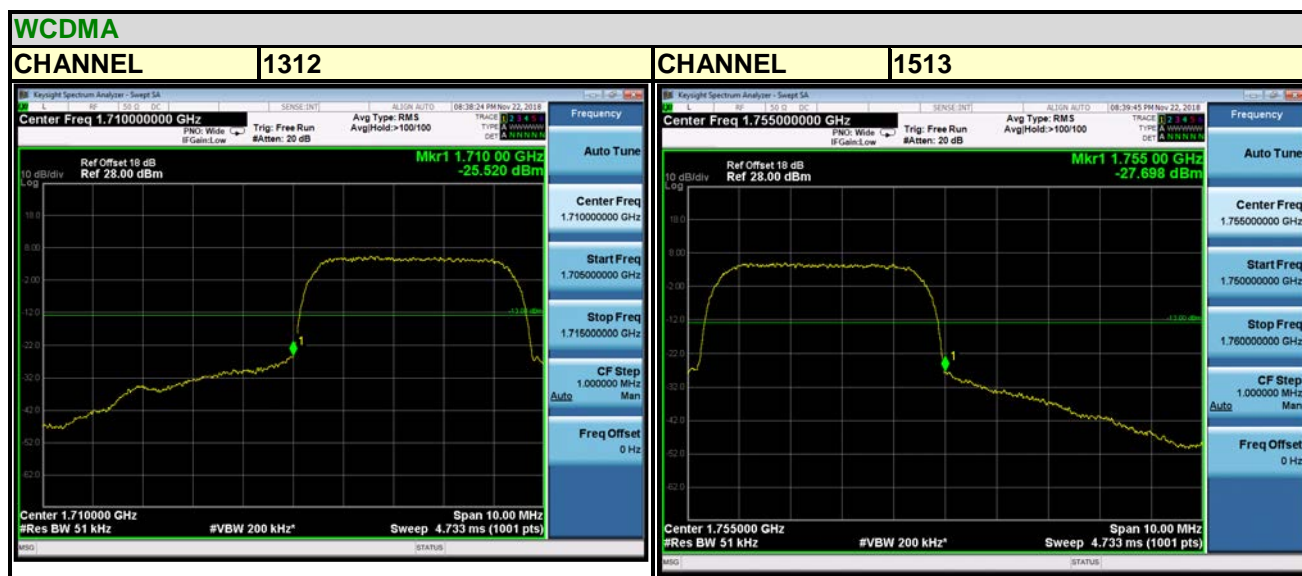

3.6 CONDUCTED SPURIOUS EMISSIONS

3.6.1 LIMITS OF CONDUCTED SPURIOUS EMISSIONS MEASUREMENT

The power of any emission outside a licensee's frequency block shall be attenuated below the transmitter power (P) by at least $43 + 10 \log_{10}(P)$ dB. The limit of emission equal to -13dBm

On all frequencies between 763-775 MHz and 793-805 MHz, by a factor not less than $65 + 10 \log (P)$ dB in a 6.25 kHz band segment, for mobile and portable stations.

3.6.2 TEST PROCEDURE

- a. The EUT makes a phone call to the communication simulator. All measurements were done at middle operational frequency range.
- b. Measuring frequency range is from 30 MHz to 17.5GHz for WCDMA Band 4. 10dB attenuation pad is connected with spectrum. RBW=1MHz and VBW=3MHz are used for conducted emission measurement.

3.6.3 TEST SETUP

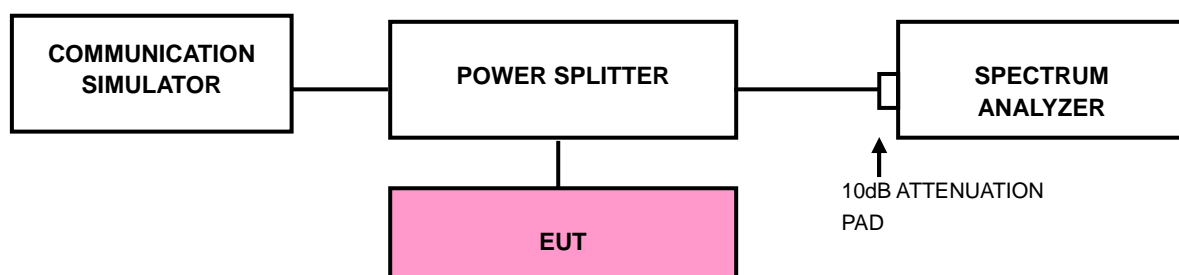



BUREAU VERITAS

Test Report No.: RF181120W002-5

3.6.4 TEST RESULTS

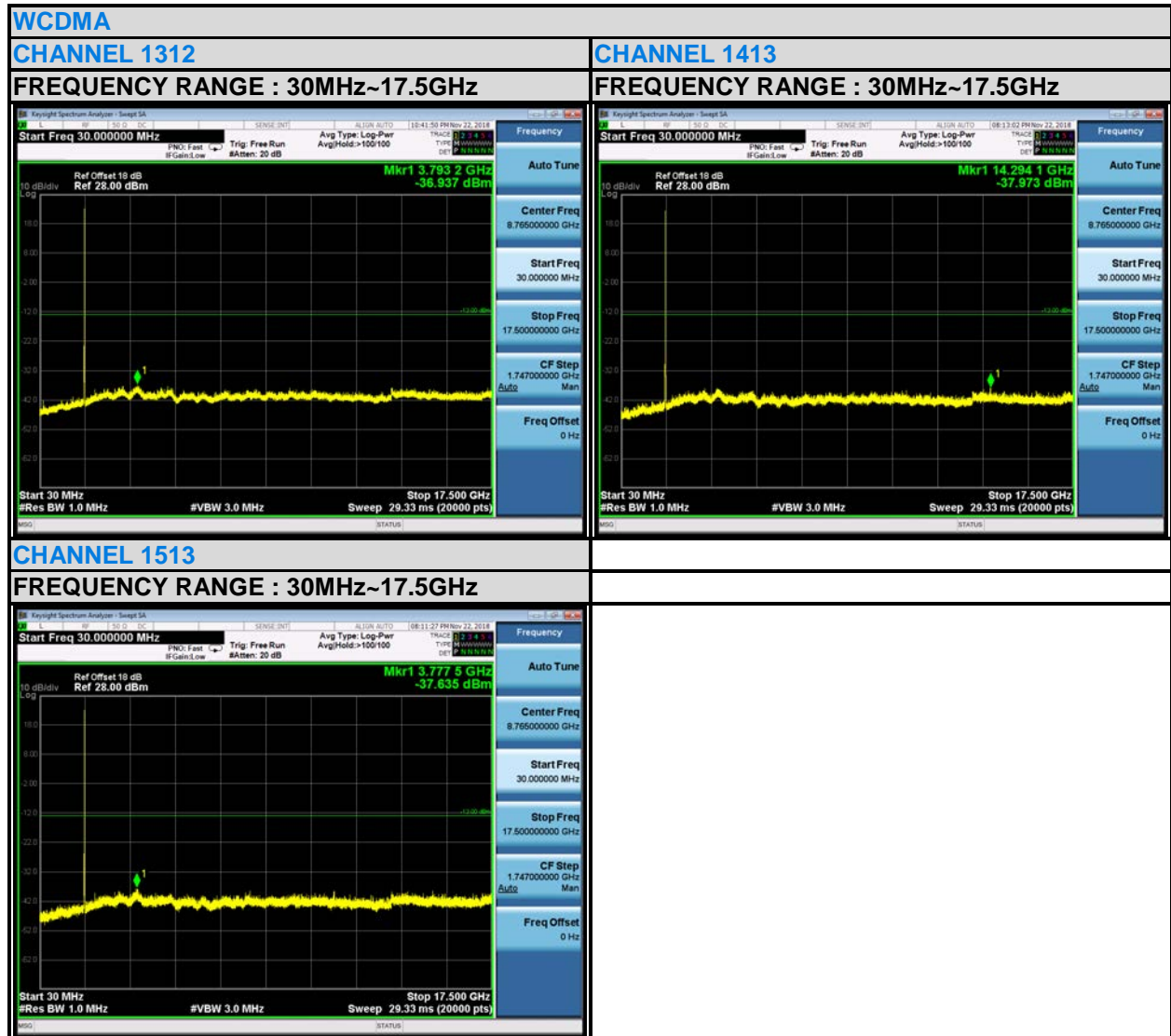



3.7 RADIATED EMISSION MEASUREMENT

3.7.1 LIMITS OF RADIATED EMISSION MEASUREMENT

The power of any emission outside a licensee's frequency block shall be attenuated below the transmitter power (P) by at least $43 + 10 \log_{10}(P)$ dB. The limit of emission equal to -13dBm

3.7.2 TEST PROCEDURES

- a. Substitution method is used for E.I.R.P measurement. In the semi-anechoic chamber, EUT placed on the 0.8m height of Turn Table, rotated the table around 360 degrees to search the maximum radiation power and receiver antenna shall be rotated vertical and horizontal polarization and moved height from 1m to 4m to find the maximum polar radiated power. The "Read Value" is the spectrum reading the maximum power value.
- b. The substitution horn antenna is substituted for EUT at the same position and signals generator export the CW signal to the substitution antenna via a TX cable. Rotated the Turn Table and moved receiving antenna to find the maximum radiation power. Adjust output power level of S.G to get a Value of spectrum reading equal to "Read Value" of step a. Record the power level of S.G
- c. $\text{EIRP} = \text{Output power level of S.G} - \text{TX cable loss} + \text{Antenna gain of substitution horn.}$
- d. E.R.P power can be calculated form E.I.R.P power by subtracting the gain of dipole, $\text{E.R.P power} = \text{E.I.P.R power} - 2.15\text{dBi.}$

NOTE: The resolution bandwidth of spectrum analyzer is 1 MHz and the video bandwidth is 3 MHz.

3.7.3 DEVIATION FROM TEST STANDARD

No deviation

3.7.4 TEST SETUP

<Below 30MHz>

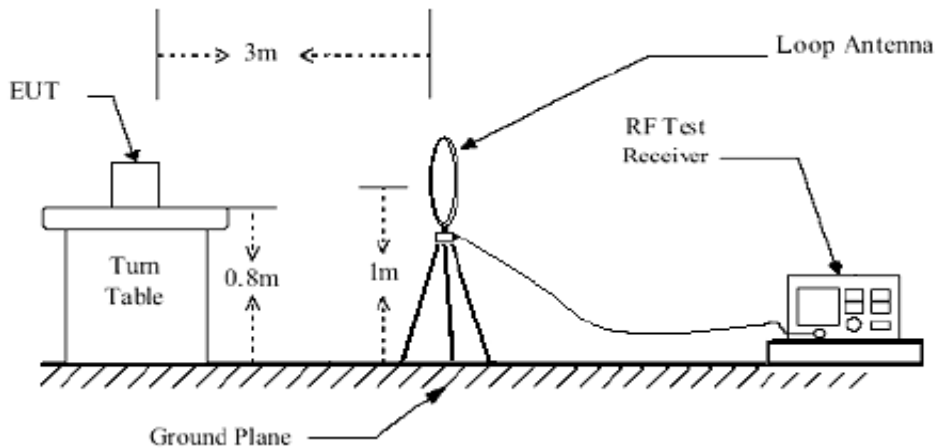

< Frequency Range 30MHz~1GHz >

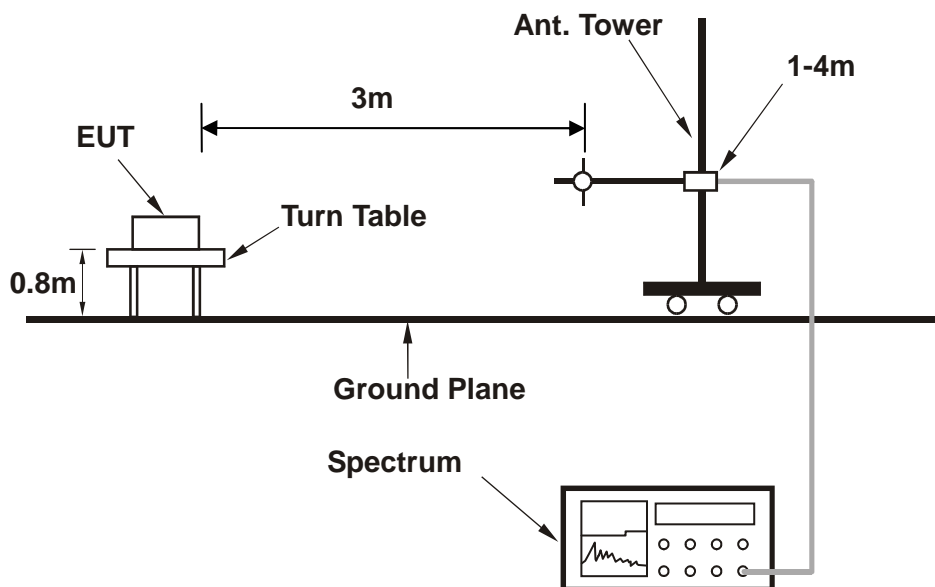

< Frequency Range above 1GHz >

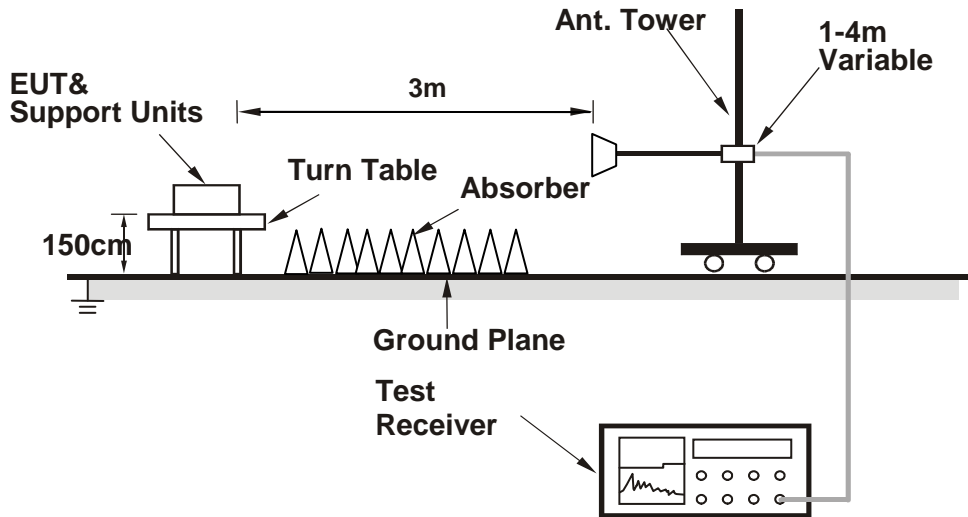

For the actual test configuration, please refer to the attached file (Test Setup Photo).



3.7.5 TEST RESULTS

BELOW 1GHz WORST-CASE DATA

9 KHz – 30 MHz data: the amplitude of spurious emissions attenuated more than 20 dB below the permissible value is not required in the report.

30 MHz – 1GHz data:

WCDMA Band IV:

MODE	TX channel 1413	FREQUENCY RANGE	Below 1000MHz
ENVIRONMENTAL CONDITIONS	23deg. C, 70%RH	INPUT POWER	DC 5V from adapter
TESTED BY	Rose Ma		
ANTENNA POLARITY & TEST DISTANCE: HORIZONTAL AT 3 M			

	Freq	Level	Read Level	Limit Line	Over Limit	Factor	Remark	Pol/Phase
	MHz	dBm/m	dBm	dBm/m	dB	dB/m		
1	54.510	-57.41	-55.89	-13.00	-44.41	-1.52	Peak	Horizontal
2	78.220	-53.06	-44.58	-13.00	-40.06	-8.48	Peak	Horizontal
3	99.200	-59.33	-48.35	-13.00	-46.33	-10.98	Peak	Horizontal
4	154.720	-59.59	-40.77	-13.00	-46.59	-18.82	Peak	Horizontal
5	189.520	-56.50	-38.99	-13.00	-43.50	-17.51	Peak	Horizontal
6	256.830	-57.50	-41.56	-13.00	-44.50	-15.94	Peak	Horizontal

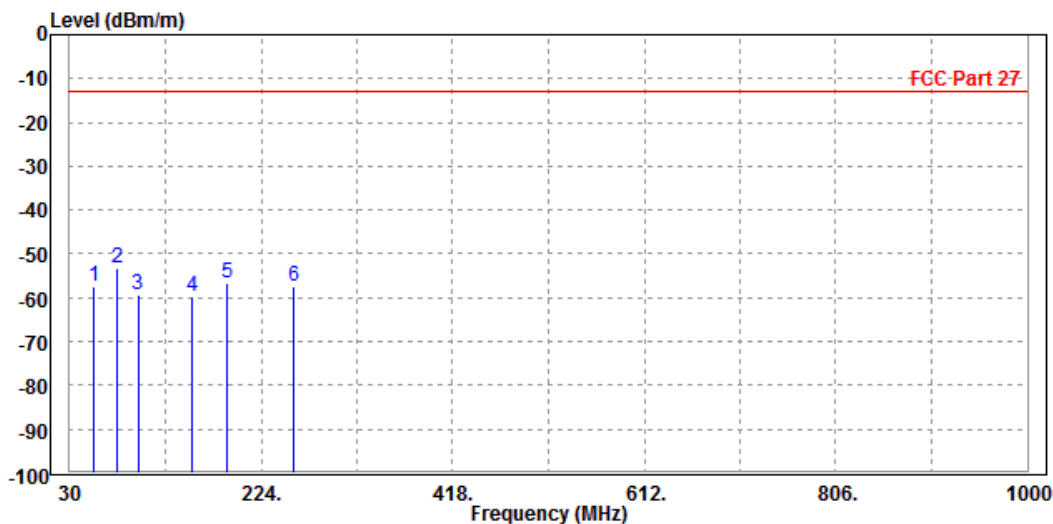



Test Report No.: RF181120W002-5

MODE	TX channel 1413	FREQUENCY RANGE	Below 1000MHz
ENVIRONMENTAL CONDITIONS	23deg. C, 70%RH	INPUT POWER	DC 5V from adapter
TESTED BY	Rose Ma		
ANTENNA POLARITY & TEST DISTANCE: VERTICAL AT 3 M			

	Freq	Level	Read Level	Limit Line	Over Limit	Factor	Remark	Pol/Phase	
	MHz	dBm/m	dBm	dBm/m	dB	dB/m			
1	PP	45.120	-34.47	-31.25	-13.00	-21.47	-3.22	Peak	Vertical
2		70.850	-56.40	-41.28	-13.00	-43.40	-15.12	Peak	Vertical
3		103.690	-48.05	-36.89	-13.00	-35.05	-11.16	Peak	Vertical
4		168.590	-60.22	-45.85	-13.00	-47.22	-14.37	Peak	Vertical
5		189.670	-50.58	-38.64	-13.00	-37.58	-11.94	Peak	Vertical
6		214.560	-56.52	-45.63	-13.00	-43.52	-10.89	Peak	Vertical

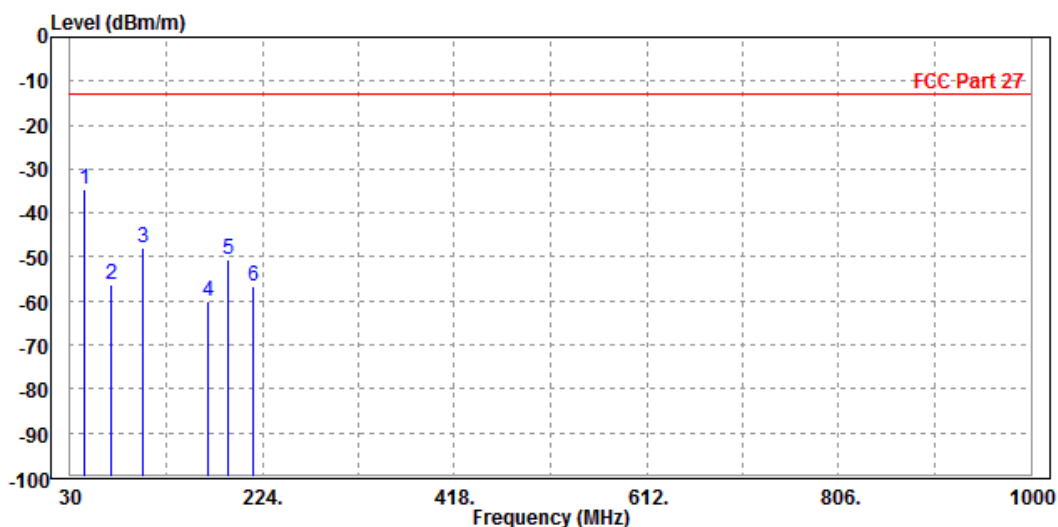



Test Report No.: RF181120W002-5

ABOVE 1GHz

Note: For higher frequency, the emission is too low to be detected.

WCDMA Band IV:

CH 1312

MODE	TX channel 1312	FREQUENCY RANGE	Above 1000MHz
ENVIRONMENTAL CONDITIONS	23deg. C, 70%RH	INPUT POWER	DC 5V from adapter
TESTED BY	Rose Ma		
ANTENNA POLARITY & TEST DISTANCE: HORIZONTAL AT 3 M			

	Freq	Level	Read Level	Limit Line	Over Limit	Factor	Remark	Pol/Phase
	MHz	dBm/m	dBm	dBm/m	dB	dB/m		
1	3418.000	-56.52	-58.37	-13.00	-43.52	1.85	Peak	Horizontal
2	PP 5137.000	-49.28	-57.82	-13.00	-36.28	8.54	Peak	Horizontal

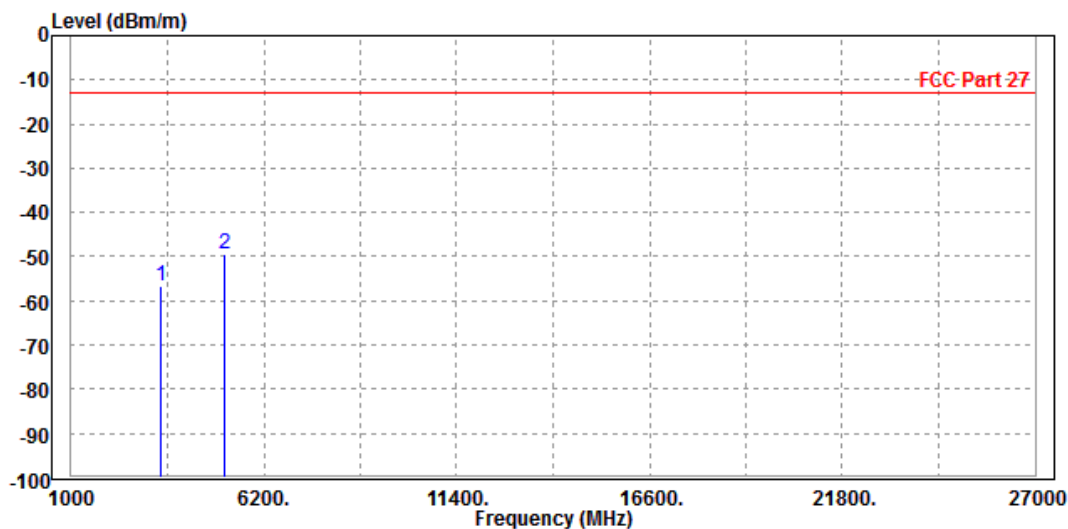



Test Report No.: RF181120W002-5

MODE	TX channel 1312	FREQUENCY RANGE	Above 1000MHz
ENVIRONMENTAL CONDITIONS	23deg. C, 70%RH	INPUT POWER	DC 5V from adapter
TESTED BY	Rose Ma		
ANTENNA POLARITY & TEST DISTANCE: VERTICAL AT 3 M			

	Freq	Level	Read Level	Limit	Over Limit	Factor	Remark	Pol/Phase
	MHz	dBm/m	dBm	dBm/m	dB	dB/m		
1	3418.000	-55.64	-58.11	-13.00	-42.64	2.47	Peak	Vertical
2 PP	5137.000	-48.81	-56.80	-13.00	-35.81	7.99	Peak	Vertical

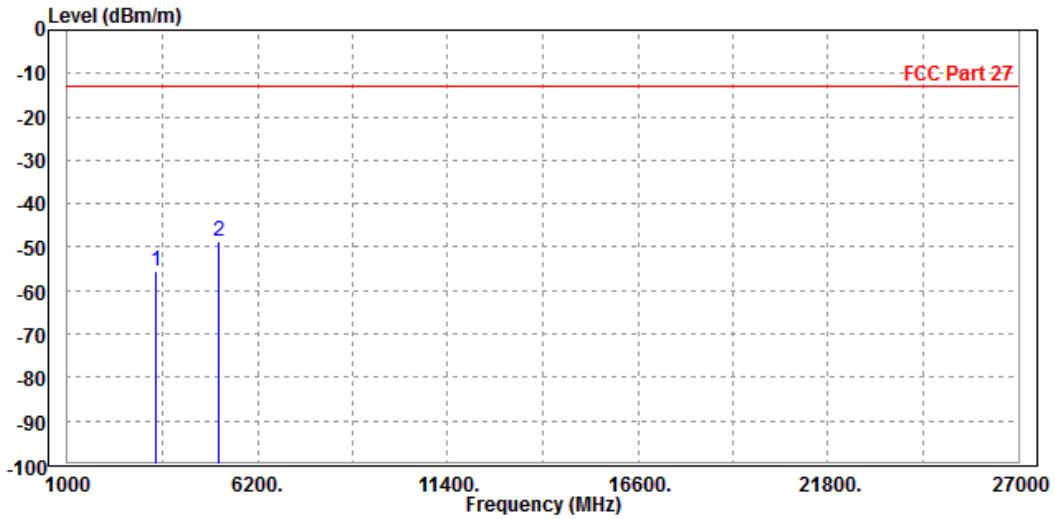



Test Report No.: RF181120W002-5

CH 1413

MODE	TX channel 1413	FREQUENCY RANGE	Above 1000MHz
ENVIRONMENTAL CONDITIONS	23deg. C, 70%RH	INPUT POWER	DC 5V from adapter
TESTED BY	Rose Ma		
ANTENNA POLARITY & TEST DISTANCE: HORIZONTAL AT 3 M			

	Freq	Level	Read Level	Limit Line	Over Limit	Factor	Remark	Pol/Phase
	MHz	dBm/m	dBm	dBm/m	dB	dB/m		
1	3470.000	-53.63	-55.68	-13.00	-40.63	2.05	Peak	Horizontal
2 PP	5197.000	-48.20	-56.81	-13.00	-35.20	8.61	Peak	Horizontal

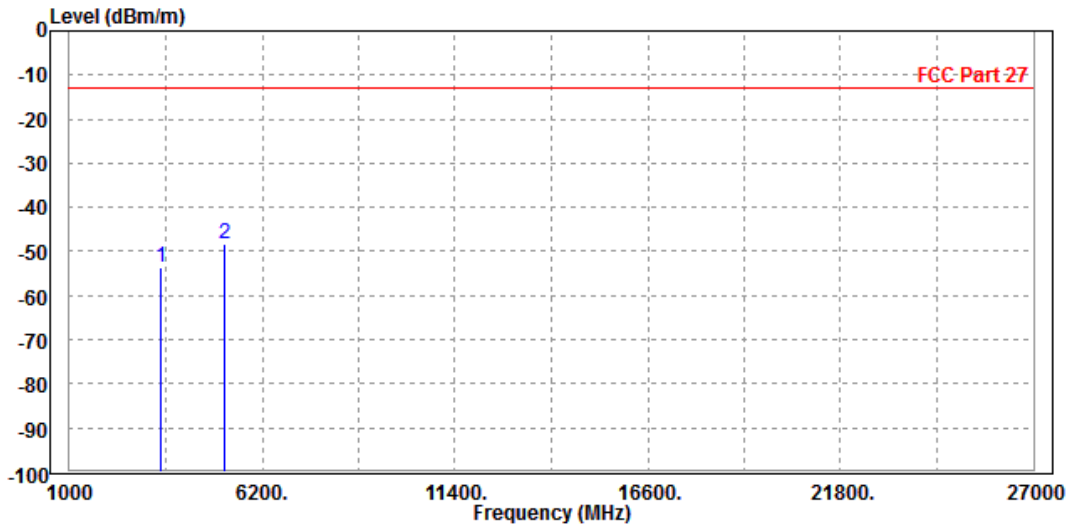



Test Report No.: RF181120W002-5

MODE	TX channel 1413	FREQUENCY RANGE	Above 1000MHz
ENVIRONMENTAL CONDITIONS	23deg. C, 70%RH	INPUT POWER	DC 5V from adapter
TESTED BY	Rose Ma		
ANTENNA POLARITY & TEST DISTANCE: VERTICAL AT 3 M			

	Freq	Level	Read Level	Limit Line	Over Limit	Factor	Remark	Pol/Phase
	MHz	dBm/m	dBm	dBm/m	dB	dB/m		
1	3470.000	-51.89	-54.42	-13.00	-38.89	2.53	Peak	Vertical
2 PP	5197.000	-48.14	-56.12	-13.00	-35.14	7.98	Peak	Vertical

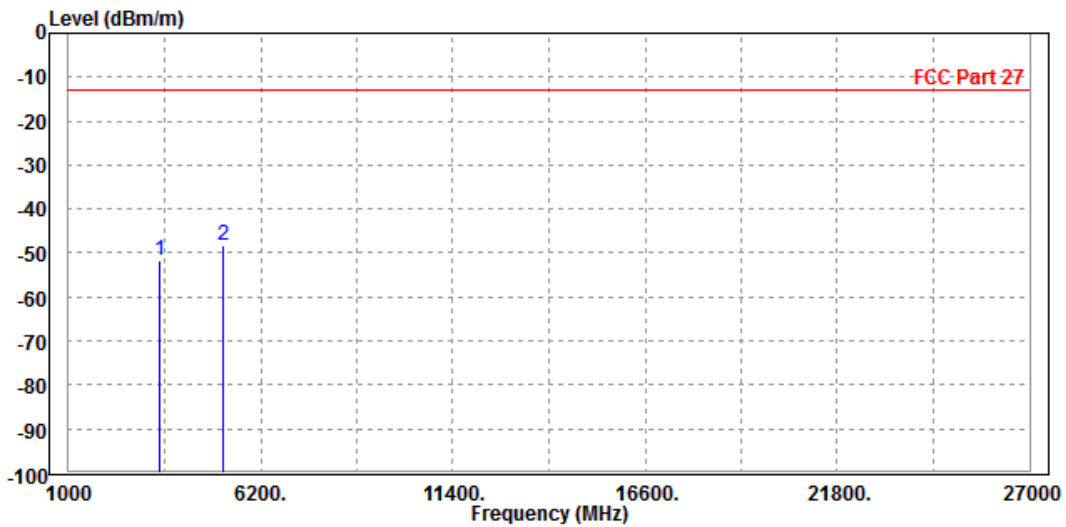



Test Report No.: RF181120W002-5

CH 1513

MODE	TX channel 1513	FREQUENCY RANGE	Above 1000MHz
ENVIRONMENTAL CONDITIONS	23deg. C, 70%RH	INPUT POWER	DC 5V from adapter
TESTED BY	Rose Ma		
ANTENNA POLARITY & TEST DISTANCE: HORIZONTAL AT 3 M			

	Freq	Level	Read Level	Limit Line	Over Limit	Factor	Remark	Pol/Phase
	MHz	dBm/m	dBm	dBm/m	dB	dB/m		
1	3496.000	-56.36	-58.51	-13.00	-43.36	2.15	Peak	Horizontal
2	PP 5257.000	-48.77	-57.45	-13.00	-35.77	8.68	Peak	Horizontal

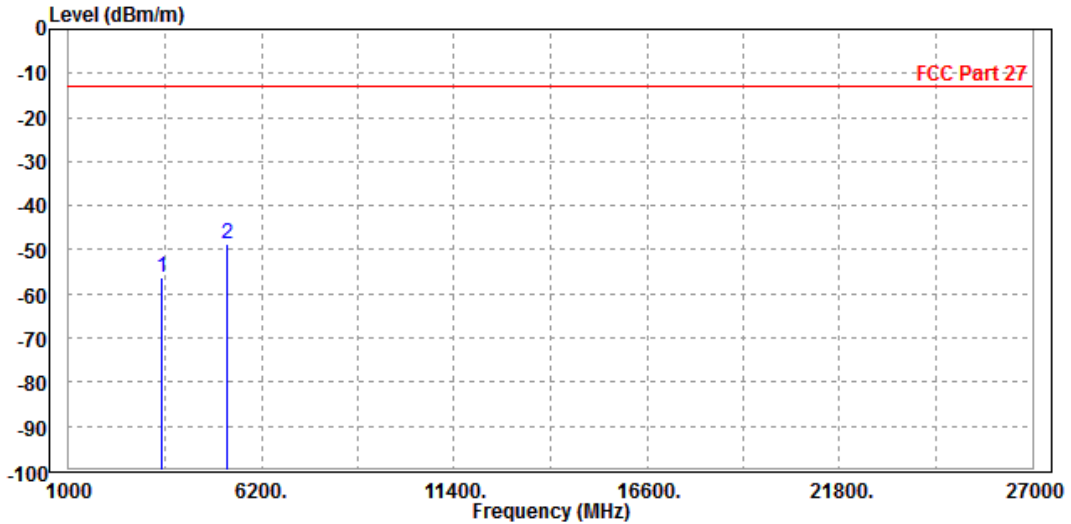



Test Report No.: RF181120W002-5

MODE	TX channel 1513	FREQUENCY RANGE	Above 1000MHz
ENVIRONMENTAL CONDITIONS	23deg. C, 70%RH	INPUT POWER	DC 5V from adapter
TESTED BY	Rose Ma		
ANTENNA POLARITY & TEST DISTANCE: VERTICAL AT 3 M			

	Freq	Level	Read Level	Limit Line	Over Limit	Factor	Remark	Pol/Phase
	MHz	dBm/m	dBm	dBm/m	dB	dB/m		
1	3496.000	-55.54	-58.10	-13.00	-42.54	2.56	Peak	Vertical
2	PP 5257.000	-50.83	-58.81	-13.00	-37.83	7.98	Peak	Vertical

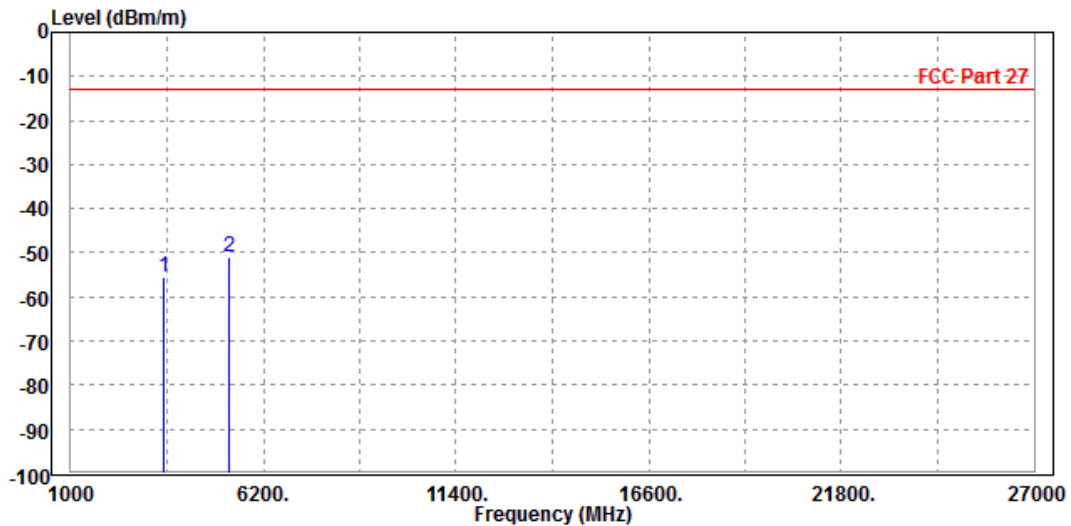



Test Report No.: RF181120W002-5

4 INFORMATION ON THE TESTING LABORATORIES

We, BV 7LAYERS COMMUNICATIONS TECHNOLOGY (SHENZHEN) CO. LTD., were founded in 2015 to provide our best service in EMC, Radio, Telecom and Safety consultation. Our laboratories are accredited and approved according to ISO/IEC 17025.

If you have any comments, please feel free to contact us at the following:

Shenzhen EMC/RF Lab:

Tel: +86-755-88696566

Fax: +86-755-88696577

Email: customerservice.dg@cn.bureauveritas.com

Web Site: www.adt.com.tw

The address and road map of all our labs can be found in our web site also.



Test Report No.: RF181120W002-5

5 APPENDIX A – MODIFICATIONS RECORDERS FOR ENGINEERING CHANGES TO THE EUT BY THE LAB

No modifications were made to the EUT by the lab during the test.

---END---