

# FCC TEST REPORT (PART 24)



Applicant:	TCL Communication Ltd.
Address:	7/F, Block F4, TCL Communication Technology Building, TCL International E City, Zhong Shan Yuan Road, Nanshan District, Shenzhen, Guangdong, P.R. China 518052

Manufacturer or Supplier:	TCL Communication Ltd.
Address:	7/F, Block F4, TCL Communication Technology Building, TCL International E City, Zhong Shan Yuan Road, Nanshan District, Shenzhen, Guangdong, P.R. China 518052
Product:	UMTS/GSM Smartphone
Brand Name:	Alcatel
Model Name:	5003G
FCC ID:	2ACCJB105
Date of tests:	Nov. 21, 2018 ~ Dec. 19, 2018

The tests have been carried out according to the requirements of the following standard:

- FCC PART 24, Subpart E**     **ANSI C63.26-2015**  
 **ANSI/TIA/EIA-603-D**         **ANSI/TIA/EIA-603-E**

**CONCLUSION:** The submitted sample was found to COMPLY with the test requirement

Prepared by Roger Li Engineer / Mobile Department	Approved by Sam Tung Manager / Mobile Department
 Date: Dec. 20, 2018	 Date: Dec. 20, 2018
<small>This report is governed by, and incorporates by reference, CPS Conditions of Service as posted at the date of issuance of this report at <a href="http://www.bureauveritas.com/home/about-us/our-business/cps/about-us/terms-conditions">http://www.bureauveritas.com/home/about-us/our-business/cps/about-us/terms-conditions</a> and is intended for your exclusive use. Any copying or replication of this report to or for any other person or entity, or use of our name or trademark, is permitted only with our prior written permission. This report sets forth our findings solely with respect to the test samples identified herein. The results set forth in this report are not indicative or representative of the quality or characteristics of the lot from which a test sample was taken or any similar or identical product unless specifically and expressly noted. Our report includes all of the tests requested by you and the results thereof based upon the information that you provided to us. Measurement uncertainty is only provided upon request for accredited tests. You have 60 days from date of issuance of this report to notify us of any material error or omission caused by our negligence or if you require measurement uncertainty; provided, however, that such notice shall be in writing and shall specifically address the issue you wish to raise. A failure to raise such issue within the prescribed time shall constitute your unqualified acceptance of the completeness of this report, the tests conducted and the correctness of the report contents.</small>	



# TABLE OF CONTENTS

<b>RELEASE CONTROL RECORD .....</b>	<b>4</b>
<b>1 SUMMARY OF TEST RESULTS .....</b>	<b>5</b>
1.1 MEASUREMENT UNCERTAINTY .....	5
1.2 TEST SITE AND INSTRUMENTS .....	6
<b>2 GENERAL INFORMATION .....</b>	<b>7</b>
2.1 GENERAL DESCRIPTION OF EUT .....	7
2.2 CONFIGURATION OF SYSTEM UNDER TEST .....	8
2.3 DESCRIPTION OF SUPPORT UNITS .....	9
2.4 TEST ITEM AND TEST CONFIGURATION .....	9
2.5 EUT OPERATING CONDITIONS .....	11
2.6 GENERAL DESCRIPTION OF APPLIED STANDARDS .....	11
<b>3 TEST TYPES AND RESULTS .....</b>	<b>12</b>
3.1 OUTPUT POWER MEASUREMENT .....	12
3.1.1 LIMITS OF OUTPUT POWER MEASUREMENT .....	12
3.1.2 TEST PROCEDURES .....	12
3.1.3 TEST SETUP .....	13
3.1.4 TEST RESULTS .....	14
3.2 FREQUENCY STABILITY MEASUREMENT .....	16
3.2.1 LIMITS OF FREQUENCY STABILITY MEASUREMENT .....	16
3.2.2 TEST PROCEDURE .....	16
3.2.3 TEST SETUP .....	16
3.2.4 TEST RESULTS .....	17
3.3 OCCUPIED BANDWIDTH MEASUREMENT .....	19
3.3.1 TEST PROCEDURES .....	19
3.3.2 TEST SETUP .....	19
3.3.3 TEST RESULTS .....	20
3.4 BAND EDGE MEASUREMENT .....	22
3.4.1 LIMITS OF BAND EDGE MEASUREMENT .....	22
3.4.2 TEST SETUP .....	22
3.4.3 TEST PROCEDURES .....	22
3.4.4 TEST RESULTS .....	23
3.5 CONDUCTED SPURIOUS EMISSIONS .....	24
3.5.1 LIMITS OF CONDUCTED SPURIOUS EMISSIONS MEASUREMENT .....	24
3.5.2 TEST PROCEDURE .....	24
3.5.3 TEST SETUP .....	24
3.5.4 TEST RESULTS .....	25
3.6 RADIATED EMISSION MEASUREMENT .....	27
3.6.1 LIMITS OF RADIATED EMISSION MEASUREMENT .....	27
3.6.2 TEST PROCEDURES .....	27
3.6.3 DEVIATION FROM TEST STANDARD .....	27
3.6.4 TEST SETUP .....	28
3.6.5 TEST RESULTS .....	30
3.7 PEAK TO AVERAGE RATIO .....	44
3.7.1 LIMITS OF PEAK TO AVERAGE RATIO MEASUREMENT .....	44
3.7.2 TEST SETUP .....	44
3.7.3 TEST PROCEDURES .....	44
3.7.4 TEST RESULTS .....	45



**BUREAU VERITAS** Test Report No.: RF181120W002-4

<b>4</b>	<b>INFORMATION ON THE TESTING LABORATORIES.....</b>	<b>51</b>
<b>5</b>	<b>APPENDIX A – MODIFICATIONS RECORDERS FOR ENGINEERING CHANGES TO THE EUT BY THE LAB.....</b>	<b>52</b>



**BUREAU**  
**VERITAS**

Test Report No.: RF181120W002-4

## RELEASE CONTROL RECORD

ISSUE NO.	REASON FOR CHANGE	DATE ISSUED
RF181120W002-4	Original release	Dec. 20, 2018



# 1 SUMMARY OF TEST RESULTS

The EUT has been tested according to the following specifications:

APPLIED STANDARD: FCC Part 24 & Part 2			
STANDARD SECTION	TEST TYPE	RESULT	REMARK
2.1046 24.232	Equivalent Isotropic Radiated Power	PASS	Meet the requirement of limit.
2.1055 24.235	Frequency Stability	PASS	Meet the requirement of limit.
2.1049 24.238(b)	Occupied Bandwidth	PASS	Meet the requirement of limit.
24.232(d)	Peak to average ratio	PASS	Meet the requirement of limit.
24.238(b)	Band Edge Measurements	PASS	Meet the requirement of limit.
2.1051 24.238	Conducted Spurious Emissions	PASS	Meet the requirement of limit.
2.1053 24.238	Radiated Spurious Emissions	PASS	Meet the requirement of limit. Minimum passing margin is -25.47dB at 37.820MHz.

## 1.1 MEASUREMENT UNCERTAINTY

Where relevant, the following measurement uncertainty levels have been estimated for tests performed on the EUT as specified in CISPR 16-4-2:

MEASUREMENT	FREQUENCY	UNCERTAINTY
Conducted emissions	9kHz~30MHz	2.66dB
Radiated emissions	9KHz ~ 30MHz	2.68dB
	30MHz ~ 1GHz	3.26dB
	1GHz ~ 18GHz	4.48dB
	18GHz ~ 40GHz	4.12dB

This uncertainty represents an expanded uncertainty expressed at approximately the 95% confidence level using a coverage factor of k=2.



## 1.2 TEST SITE AND INSTRUMENTS

Equipment	Manufacturer	Model No.	Serial No.	Last Cal.	Next Cal.
MXE EMI Receiver	KEYSIGHT	N9038A-544	MY54450026	Mar. 16,18	Mar. 15,19
EXA Signal Analyzer	KEYSIGHT	N9010A-526	MY54510322	Mar. 16,18	Mar. 15,19
Bilog Antenna 1	ETS-LINDGREN	3143B	00161964	Mar. 15,18	Mar. 14,19
Bilog Antenna 2	ETS-LINDGREN	3143B	00161965	Mar. 15,18	Mar. 14,19
Horn Antenna 1	ETS-LINDGREN	3117	00168728	Mar. 15,18	Mar. 14,19
Horn Antenna 2	ETS-LINDGREN	3117	00168692	Nov. 30, 18	Nov. 29, 19
Loop antenna	Daze	ZN30900A	0708	Oct. 23,18	Oct. 22, 19
Horn Antenna (18GHz-40GHz)	N/A	QWH-SL-18-40-K-SG/QMS-00361	15433	Nov. 21, 18	Nov. 20, 19
Radio Communication Analyzer	ANRITSU	MT8820C	6201465426	Mar. 02,18	Mar. 01,19
Signal Pre-Amplifier	EMSI	EMC 9135	980249	Jul. 09,18	Jul. 08,19
Signal Pre-Amplifier	EMSI	EMC 012645B	980257	Jul. 09,18	Jul. 08,19
Signal Pre-Amplifier	EMSI	EMC 184045B	980259	Jul. 09,18	Jul. 08,19
3m Semi-anechoic Chamber	ETS-LINDGREN	9m*6m*6m	Euroshieldpn-CT0001143-1216	Apr. 21,18	Apr. 20,19
Test Software	E3	V 9.160323	N/A	N/A	N/A
Test Software	ADT	ADT_Radiated_V7.6.15.9.2	N/A	N/A	N/A
10dB Attenuator	JFW/USA	50HF-010-SM A	1505	Jul. 09,18	Jul. 08,19
Power Meter	Anritsu	ML2495A	1506002	Mar. 02,18	Mar. 01,19
Power Sensor	Anritsu	MA2411B	1339352	Mar. 16,18	Mar. 15,19
Humid & Temp Programmable Tester	Juyi	ITH-120-45-CP-AR	IAA1504-001	Jul. 09,18	Jul. 08,19
MXG Analog Microvave Signal Generator	KEYSIGHT	N5183A	MY50143024	Mar. 13,18	Mar. 12,19

- NOTE:**
1. The calibration interval of the above test instruments is 12 months or 24 months and the calibrations are traceable to CEPREI/CHINA, GRGT/CHINA and NIM/CHINA.
  2. The test was performed in 3m Semi-anechoic Chamber and RF Oven Room.
  3. The horn antenna is used only for the measurement of emission frequency above 1GHz if tested.
  4. The FCC Site Registration No. is 525120; The Designation No. is CN1171.



## 2 GENERAL INFORMATION

### 2.1 GENERAL DESCRIPTION OF EUT

<b>PRODUCT</b>	UMTS/GSM Smartphone	
<b>BRAND NAME</b>	Alcatel	
<b>MODEL NAME</b>	5003G	
<b>POWER SUPPLY</b>	5.0Vdc (adapter or host equipment) 3.8Vdc (Li-ion, battery)	
<b>MODULATION TYPE</b>	<b>GSM: GMSK</b> <b>WCDMA : BPSK</b>	
<b>FREQUENCY RANGE</b>	<b>GSM</b>	1850.2MHz ~ 1909.8MHz
	<b>WCDMA</b>	1852.4MHz ~ 1907.6MHz
<b>MAX. EIRP POWER</b>	<b>GSM</b>	134mW
	<b>WCDMA</b>	145mW
<b>EMISSION DESIGNATOR</b>	<b>GSM</b>	244KGXW
	<b>WCDMA</b>	4M16F9W
<b>ANTENNA TYPE</b>	IFIA antenna with -1.4dBi gain	
<b>HW VERSION</b>	PIO	
<b>SW VERSION</b>	V1.0	
<b>I/O PORTS</b>	Refer to user's manual	
<b>CABLE SUPPLIED</b>	N/A	

**NOTE:**

1. For a more detailed features description, please refer to the manufacturer's specifications or the user's manual.
2. For the test results, the EUT had been tested with all conditions. But only the worst case was shown in test report.

**List of Accessory:**

ACCESSORIES	BRAND	MODEL	Manufacturer	SPECIFICATION
AC Adapter 1	alcatel	CBA0066AGAC5(PA-5V550mA-005 )	PUAN	I/P:100-240Vac, 150mA O/P: 5Vdc, 550mA
AC Adapter 2	alcatel	CBA0066AGAC7(CY050055US-L)	chenyang	I/P:100-240Vac, 150mA O/P: 5Vdc, 550mA
Battery 1	alcatel	CAB2000080C7(TLi020F7)	VEKEN	Rating: 3.8Vdc, 2050mAh
Battery 2	alcatel	CAB2000070C1(TLi020F1)	BYD	Rating: 3.8Vdc, 2050mAh
Battery 3	alcatel	CAB2000095CA (TLi020FA)	Tianmao	Rating: 3.8Vdc, 2050mAh



## 2.2 CONFIGURATION OF SYSTEM UNDER TEST

### FOR RADIATION EMISSION

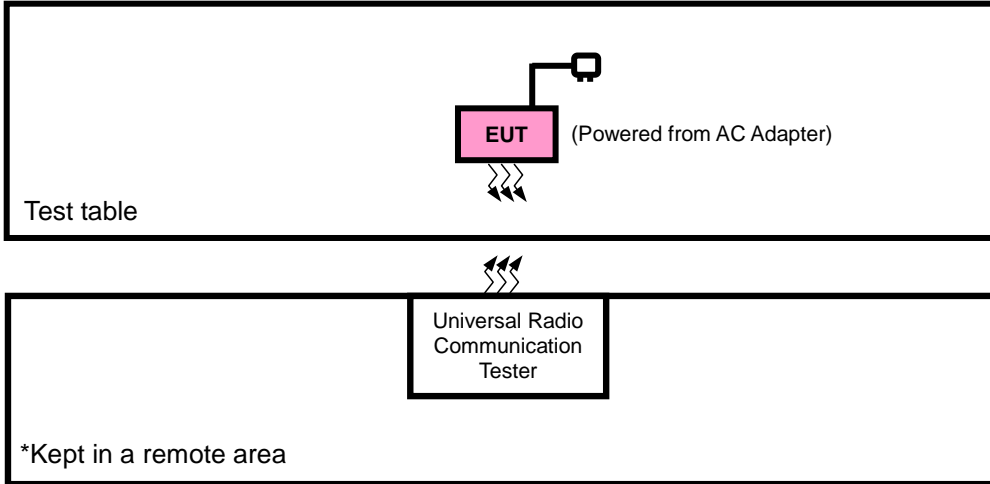

### FOR CONDUCTED & E.I.R.P. TEST

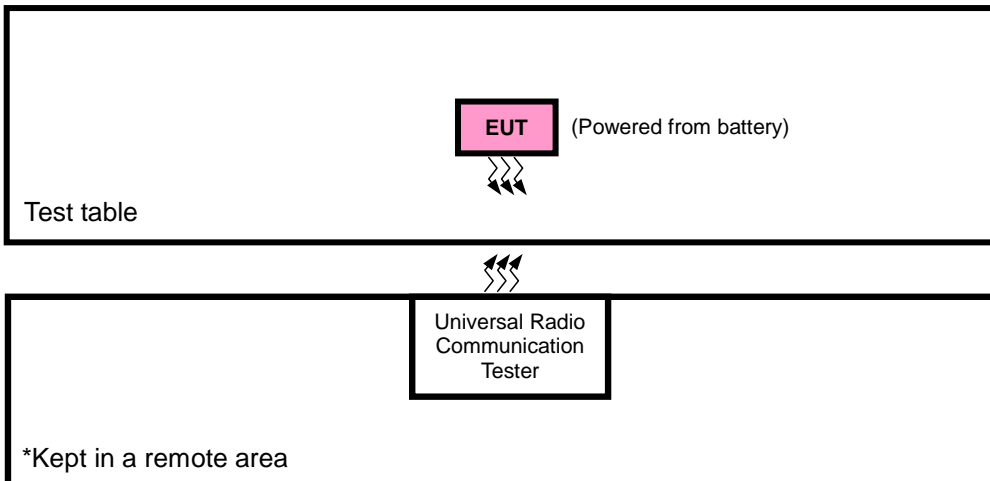





### 2.3 DESCRIPTION OF SUPPORT UNITS

The EUT has been tested as an independent unit together with other necessary accessories or support units. The following support units or accessories were used to form a representative test configuration during the tests.

NO.	PRODUCT	BRAND	MODEL NO.	SERIAL NO.	FCC ID
1	DC source	LONG WEI	PS-6403D	010934269	N/A
2	PC	HP	A6608CN	3CR83825X3	N/A

NO.	SIGNAL CABLE DESCRIPTION OF THE ABOVE SUPPORT UNITS
1	DC Line: Unshielded, Detachable 1.0m
2	AC Line: Unshielded, Detachable 1.5m

**NOTE:**

1. All power cords of the above support units are non shielded (1.8m).

### 2.4 TEST ITEM AND TEST CONFIGURATION

Pre-Scan has been conducted to determine the worst-case mode from all possible combinations between available modulations, data rates, XYZ axis and antenna ports

The worst case in EIRP and radiated emission was found when positioned on X-plane for GSM/WCDMA. Following channel(s) was (were) selected for the final test as listed below:

EUT CONFIGURE MODE	DESCRIPTION
A	EUT + Adapter with GSM or WCDMA link
B	EUT + Battery with GSM or WCDMA link



**GSM MODE**

EUT CONFIGURE MODE	TEST ITEM	AVAILABLE CHANNEL	TESTED CHANNEL	MODE
B	EIRP	512 to 810	512, 661, 810	GSM, GPRS
B	FREQUENCY STABILITY	512 to 810	512, 810	GSM, GPRS
B	OCCUPIED BANDWIDTH	512 to 810	512, 661, 810	GSM, GPRS
B	PEAK TO AVERAGE RATIO	512 to 810	512, 661, 810	GSM, GPRS
B	BAND EDGE	512 to 810	512, 810	GSM, GPRS
B	CONDCUDED EMISSION	512 to 810	512, 661, 810	GSM, GPRS
A	RADIATED EMISSION	512 to 810	512, 661, 810	GSM, GPRS

**WCDMA MODE**

EUT CONFIGURE MODE	TEST ITEM	AVAILABLE CHANNEL	TESTED CHANNEL	MODE
B	EIRP	9262 to 9538	9262, 9400, 9538	WCDMA
B	FREQUENCY STABILITY	9262 to 9538	9262, 9538	WCDMA
B	OCCUPIED BANDWIDTH	9262 to 9538	9262, 9400, 9538	WCDMA
B	PEAK TO AVERAGE RATIO	9262 to 9538	9262, 9400, 9538	WCDMA
B	BAND EDGE	9262 to 9538	9262, 9538	WCDMA
B	CONDCUDED EMISSION	9262 to 9538	9262, 9400, 9538	WCDMA
A	RADIATED EMISSION	9262 to 9538	9262, 9400, 9538	WCDMA

**TEST CONDITION:**

TEST ITEM	ENVIRONMENTAL CONDITIONS	INPUT POWER	TESTED BY
EIRP	25deg. C, 57%RH	3.8Vdc from Battery	Rose Ma
FREQUENCY STABILITY	23deg. C, 61%RH	DC 3.4V/3.8V/4.35V	Rain Wang
OCCUPIED BANDWIDTH	23deg. C, 61%RH	3.8Vdc from Battery	Rain Wang
PEAK TO AVERAGE RATIO	23deg. C, 61%RH	3.8Vdc from Battery	Rain Wang
BAND EDGE	23deg. C, 61%RH	3.8Vdc from Battery	Rain Wang
CONDCUDED EMISSION	23deg. C, 61%RH	3.8Vdc from Battery	Rain Wang
RADIATED EMISSION	23deg. C, 70%RH	5Vdc from adapter	Rose Ma



## **2.5 EUT OPERATING CONDITIONS**

The EUT makes a call to the communication simulator. The communication simulator station system controlled a EUT to export maximum output power under transmission mode and specific channel frequency

## **2.6 GENERAL DESCRIPTION OF APPLIED STANDARDS**

The EUT is a RF product. According to the specifications of the manufacturer, it must comply with the requirements of the following standards:

**FCC 47 CFR Part 2**

**FCC 47 CFR Part 24**

**KDB 971168 D01 Power Meas License Digital Systems v03**

**ANSI/TIA/EIA-603-D**

**ANSI/TIA/EIA-603-E**

**ANSI C63.26-2015**

**NOTE:** All test items have been performed and recorded as per the above standards.



### 3 TEST TYPES AND RESULTS

#### 3.1 OUTPUT POWER MEASUREMENT

##### 3.1.1 LIMITS OF OUTPUT POWER MEASUREMENT

Mobile and portable stations are limited to 2 watts EIRP.

##### 3.1.2 TEST PROCEDURES

###### **EIRP MEASUREMENT:**

- a. All measurements were done at low, middle and high operational frequency range. RBW and VBW is 1MHz for GSM and 5MHz for WCDMA mode.
- b. Substitution method is used for E.I.R.P measurement. In the semi-anechoic chamber, EUT placed on the 0.8m height of Turn Table, rotated the table around 360 degrees to search the maximum radiation power and receiver antenna shall be rotated vertical and horizontal polarization and moved height from 1m to 4m to find the maximum polar radiated power. The “Read Value” is the spectrum reading the maximum power value.
- c. The substitution horn antenna is substituted for EUT at the same position and signals generator export the CW signal to the substitution antenna via a tx cable. Rotated the Turn Table and moved receiving antenna to find the maximum radiation power. Adjust output power level of S.G to get a Value of spectrum reading equal to “Read Value “ of step b. Record the power level of S.G
- d.  $EIRP = \text{Output power level of S.G} - \text{TX cable loss} + \text{Antenna gain of substitution horn.}$

###### **CONDUCTED POWER MEASUREMENT:**

The EUT was set up for the maximum power with GSM & WCDMA link data modulation and link up with simulator. Set the EUT to transmit under low, middle and high channel and record the power level shown on simulator.



### 3.1.3 TEST SETUP

**EIRP / ERP Measurement:**  
<Radiated Emission below or equal 1 GHz>

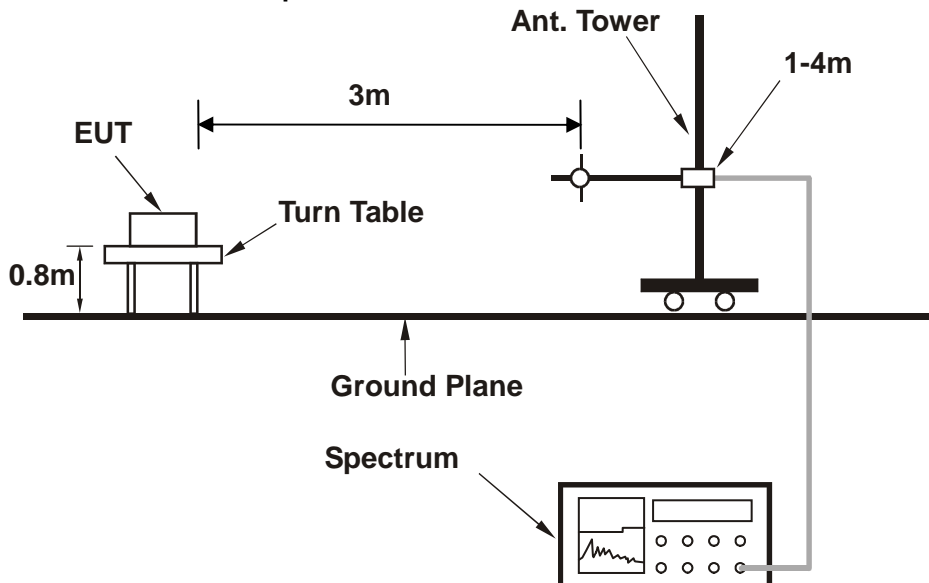

<Radiated Emission above 1 GHz>

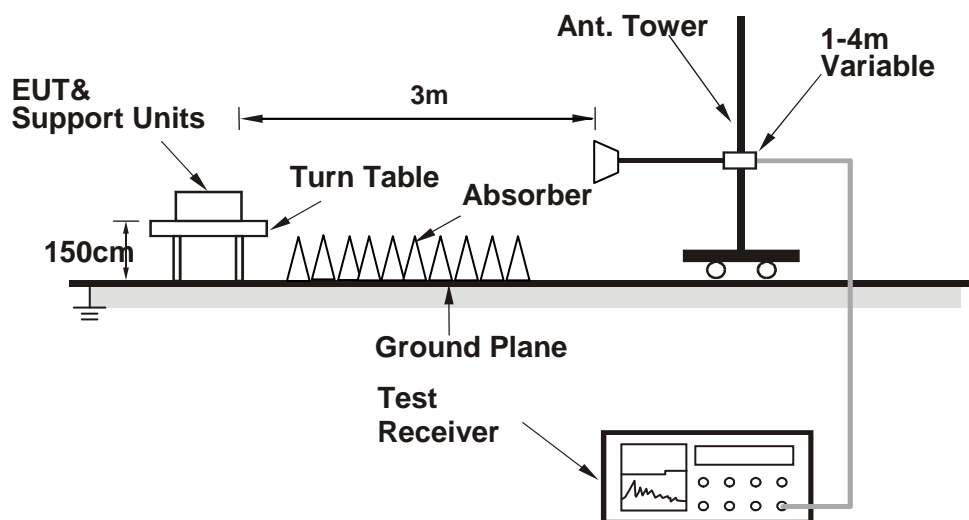

For the actual test configuration, please refer to the attached file (Test Setup Photo).

#### CONDUCTED POWER MEASUREMENT:

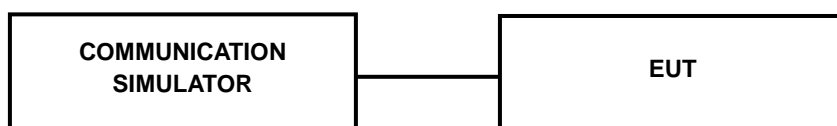



### 3.1.4 TEST RESULTS

#### CONDUCTED OUTPUT POWER (dBm)

Band	GSM1900		
Channel	512	661	810
Frequency (MHz)	1850.2	1880.0	1909.8
GSM	29.42	29.42	<b>29.61</b>
GPRS 8	29.39	29.37	29.57
GPRS 10	27.59	27.55	27.74
GPRS 11	26.24	26.20	26.40
GPRS 12	24.45	24.41	24.59

Band	WCDMA II		
Channel	9262	9400	9538
Frequency (MHz)	1852.4	1880.0	1907.6
RMC 12.2K	22.74	<b>23.30</b>	22.98
HSPA			
HSDPA Subtest-1	21.89	22.45	22.13
HSDPA Subtest-2	21.82	22.38	22.06
HSDPA Subtest-3	21.38	21.94	21.62
HSDPA Subtest-4	21.33	21.89	21.57
HSUPA Subtest-1	22.25	22.81	22.49
HSUPA Subtest-2	20.21	20.77	20.45
HSUPA Subtest-3	21.18	21.74	21.42
HSUPA Subtest-4	20.29	20.85	20.53
HSUPA Subtest-5	22.31	22.87	22.55



**EIRP POWER (dBm)**

**GSM**

Channel	Frequency (MHz)	SPA LVL (dBm)	Correction Factor(dB)	EIRP(dBm)	EIRP(mW)	Polarization (H/V)
512	1850.2	-27.01	43.83	16.82	48.08	H
661	1880.0	-27.56	43.57	16.01	39.90	H
810	1909.8	-28.21	44.57	16.36	43.25	H
512	1850.2	-25.12	46.39	21.27	<b>133.97</b>	V
661	1880.0	-25.89	47.10	21.21	132.07	V
810	1909.8	-26.35	45.98	19.63	91.75	V

**REMARKS:** 1. EIRP Output Power (dBm) = SPA LVL (dBm) + Correction Factor (dB).  
 2. Correction factor (dB) = Free Space Loss + Antenna Factor + Cable Loss

**WCDMA**

Channel	Frequency (MHz)	SPA LVL (dBm)	Correction Factor(dB)	EIRP(dBm)	EIRP(mW)	Polarization (H/V)
9262	1852.4	-30.42	43.83	13.41	21.93	H
9400	1880.0	-31.25	43.57	12.32	17.06	H
9538	1907.6	-31.68	44.57	12.89	19.45	H
9262	1852.4	-24.78	46.39	21.61	<b>144.88</b>	V
9400	1880.0	-25.51	47.10	21.59	144.15	V
9538	1907.6	-26.12	45.98	19.86	96.74	V

**REMARKS:** 1. EIRP Output Power (dBm) = SPA LVL (dBm) + Correction Factor (dB).  
 2. Correction factor (dB) = Free Space Loss + Antenna Factor + Cable Loss



### 3.2 FREQUENCY STABILITY MEASUREMENT

#### 3.2.1 LIMITS OF FREQUENCY STABILITY MEASUREMENT

The frequency stability shall be sufficient to ensure that the fundamental emission stays within the authorized frequency block.

#### 3.2.2 TEST PROCEDURE

- a. Device is placed at the oven room. The oven room could control the temperatures and humidity. Power warm up is at least 15 min and power applied should perform before recording frequency error.
- b. EUT is connected the external power supply to control the DC input power. The test voltage range is from minimum to maximum working voltage. Each step shall be record the frequency error rate.
- c. The temperature range step is 10 degrees in this test items. All temperature levels shall be hold the  $\pm 0.5^{\circ}\text{C}$  during the measurement testing. The each temperature step shall be at least 0.5 hours, consider the EUT could be test under the stability condition.

**NOTE:** The frequency error was recorded frequency error from the communication simulator.

#### 3.2.3 TEST SETUP

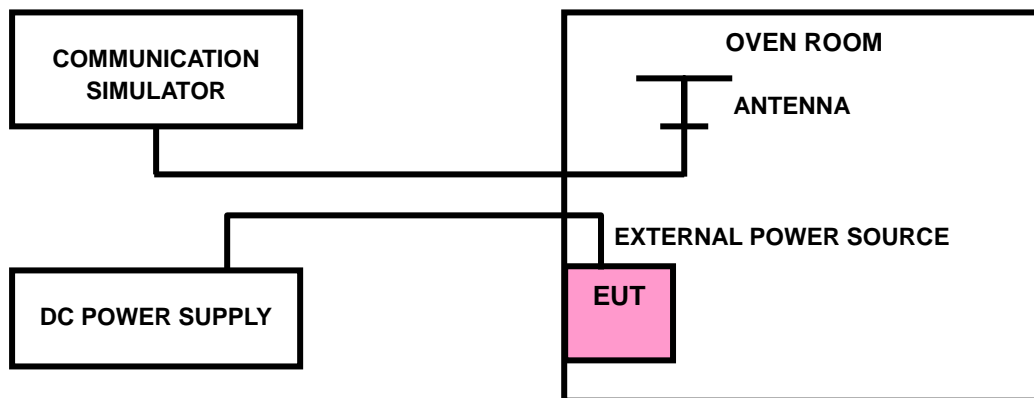





### 3.2.4 TEST RESULTS

#### PCS1900

#### FREQUENCY ERROR VS. VOLTAGE

VOLTAGE (Volts)	FREQUENCY ERROR (ppm)		LIMIT (ppm)
	Low Channel	High Channel	
3.8	0.0010	0.0012	2.5
3.4	-0.0012	-0.0012	2.5
4.35	0.0009	0.0011	2.5

**NOTE:** The applicant defined the normal working voltage of the battery is from 3.4Vdc to 4.35Vdc.

#### FREQUENCY ERROR vs. TEMPERATURE.

TEMP. (°C)	FREQUENCY ERROR (ppm)		LIMIT (ppm)
	Low Channel	High Channel	
-30	-0.0055	-0.0053	2.5
-20	-0.0051	-0.0048	2.5
-10	-0.0046	-0.0043	2.5
0	-0.0037	-0.0035	2.5
10	-0.0030	-0.0028	2.5
20	-0.0023	-0.0021	2.5
30	-0.0017	-0.0015	2.5
40	-0.0014	-0.0012	2.5
50	-0.0005	-0.0003	2.5



**WCDMA BAND II**

**FREQUENCY ERROR VS. VOLTAGE**

VOLTAGE (Volts)	FREQUENCY ERROR (ppm)		LIMIT (ppm)
	Low Channel	High Channel	
3.8	0.0009	0.0008	2.5
3.4	-0.0010	-0.0011	2.5
4.35	0.0009	0.0010	2.5

**NOTE:** The applicant defined the normal working voltage of the battery is from 3.4Vdc to 4.35Vdc.

**FREQUENCY ERROR vs. TEMPERATURE.**

TEMP. (°C)	FREQUENCY ERROR (ppm)		LIMIT (ppm)
	Low Channel	High Channel	
-30	-0.0055	-0.0051	2.5
-20	-0.0051	-0.0048	2.5
-10	-0.0044	-0.0042	2.5
0	-0.0039	-0.0037	2.5
10	-0.0029	-0.0027	2.5
20	-0.0023	-0.0022	2.5
30	-0.0017	-0.0016	2.5
40	-0.0012	-0.0011	2.5
50	-0.0005	-0.0005	2.5



### 3.3 OCCUPIED BANDWIDTH MEASUREMENT

#### 3.3.1 TEST PROCEDURES

The EUT makes a call to the communication simulator. All measurements were done at low, middle and high operational frequency range. The communication simulator station system controlled a EUT to export maximum output power under transmission mode and specific channel frequency. Use OBW measurement function of Spectrum analyzer to measure 99 % occupied bandwidth.

#### 3.3.2 TEST SETUP

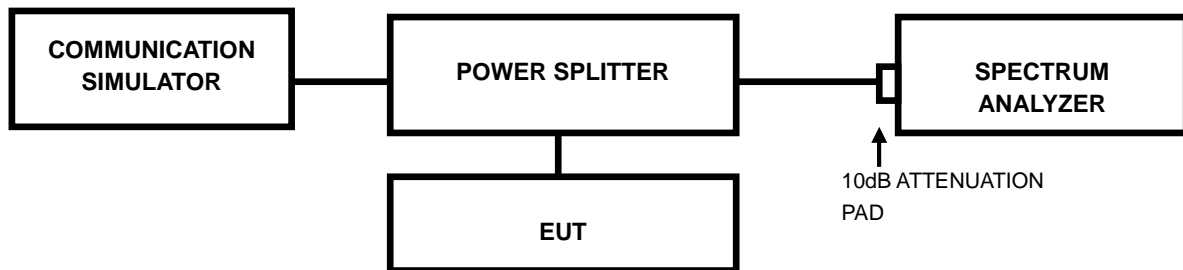



### 3.3.3 TEST RESULTS

Channel	Frequency (MHz)	99% Occupied bandwidth (kHz)	Channel	Frequency (MHz)	99% Occupied bandwidth (MHz)
		GSM			WCDMA
512	1850.2	241.00	9262	1852.4	4.14
661	1880.0	244.00	9400	1880.0	4.14
810	1909.8	244.00	9538	1907.6	4.16

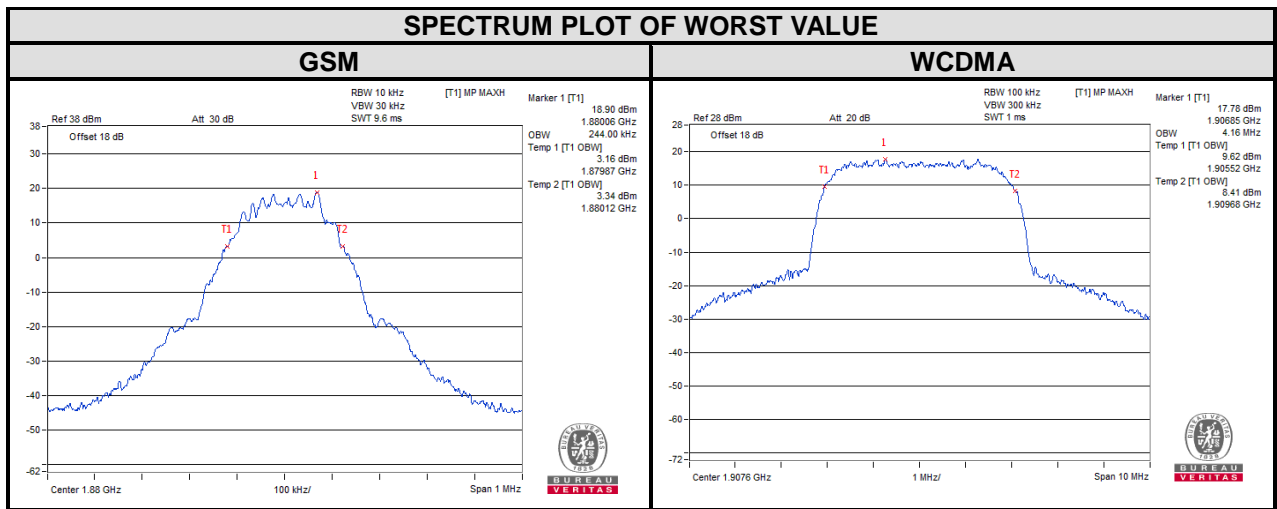



BUREAU VERITAS

Test Report No.: RF181120W002-4

Channel	Frequency (MHz)	26dB bandwidth (kHz)	CHANNEL	FREQUENCY (MHz)	26dB bandwidth (MHz)
		GSM			WCDMA
512	1850.2	271.161	9262	1852.4	4.682
661	1880.0	274.332	9400	1880.0	4.704
810	1909.8	275.725	9538	1907.6	4.706

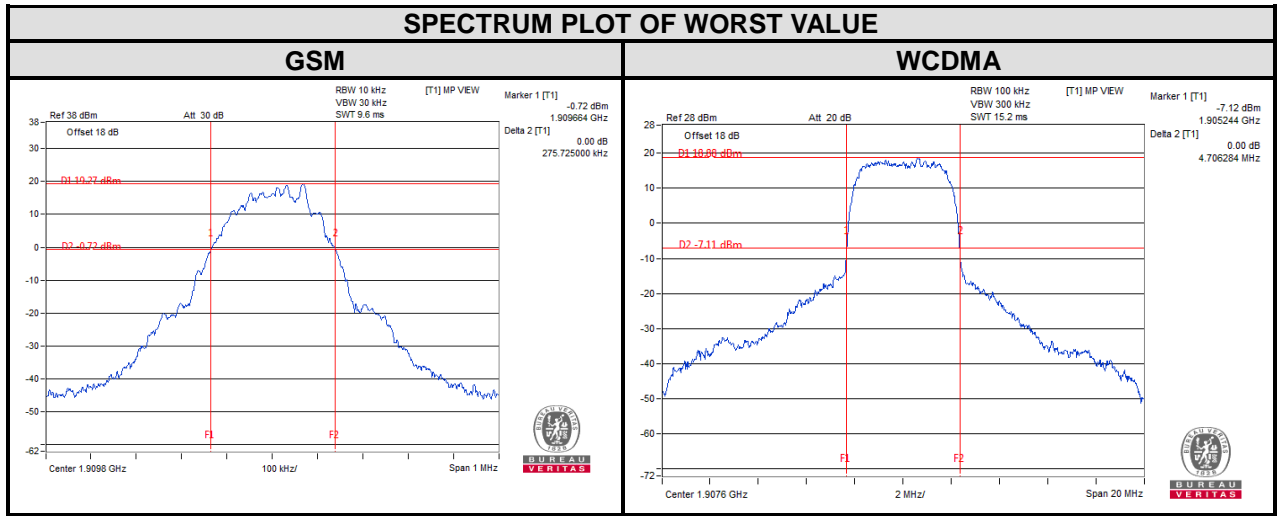



### 3.4 BAND EDGE MEASUREMENT

#### 3.4.1 LIMITS OF BAND EDGE MEASUREMENT

Power of any emission outside of the authorized operating frequency ranges must be attenuated below the transmitting power (P) by a factor of at least  $43 + 10 \log(P)$  dB. In the 1 MHz bands immediately outside and adjacent to the frequency block a resolution bandwidth of at least one percent of the emission bandwidth of the fundamental emission of the transmitter may be employed.

#### 3.4.2 TEST SETUP

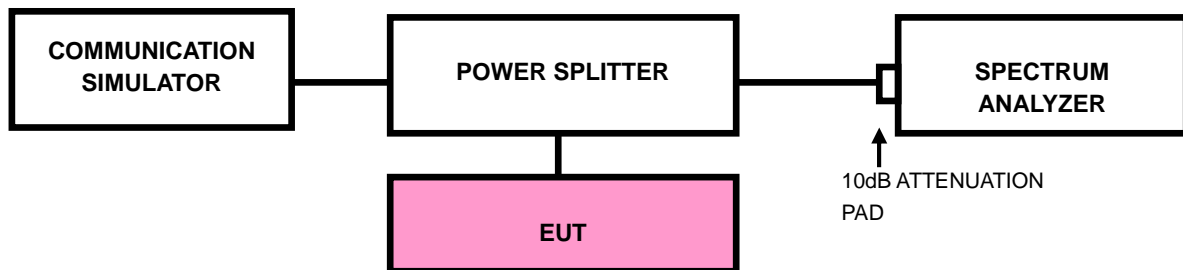

#### 3.4.3 TEST PROCEDURES

- All measurements were done at low and high operational frequency range.
- The center frequency of spectrum is the band edge frequency and span is 1.5 MHz. RBW of the spectrum is 10kHz and VBW of the spectrum is 30kHz (GSM).
- The center frequency of spectrum is the band edge frequency and span is 10MHz. RBW of the spectrum is 100kHz and VBW of the spectrum is 300kHz (WCDMA).
- Record the max trace plot into the test report.



**BUREAU  
VERITAS**

Test Report No.: RF181120W002-4

### 3.4.4. TEST RESULTS

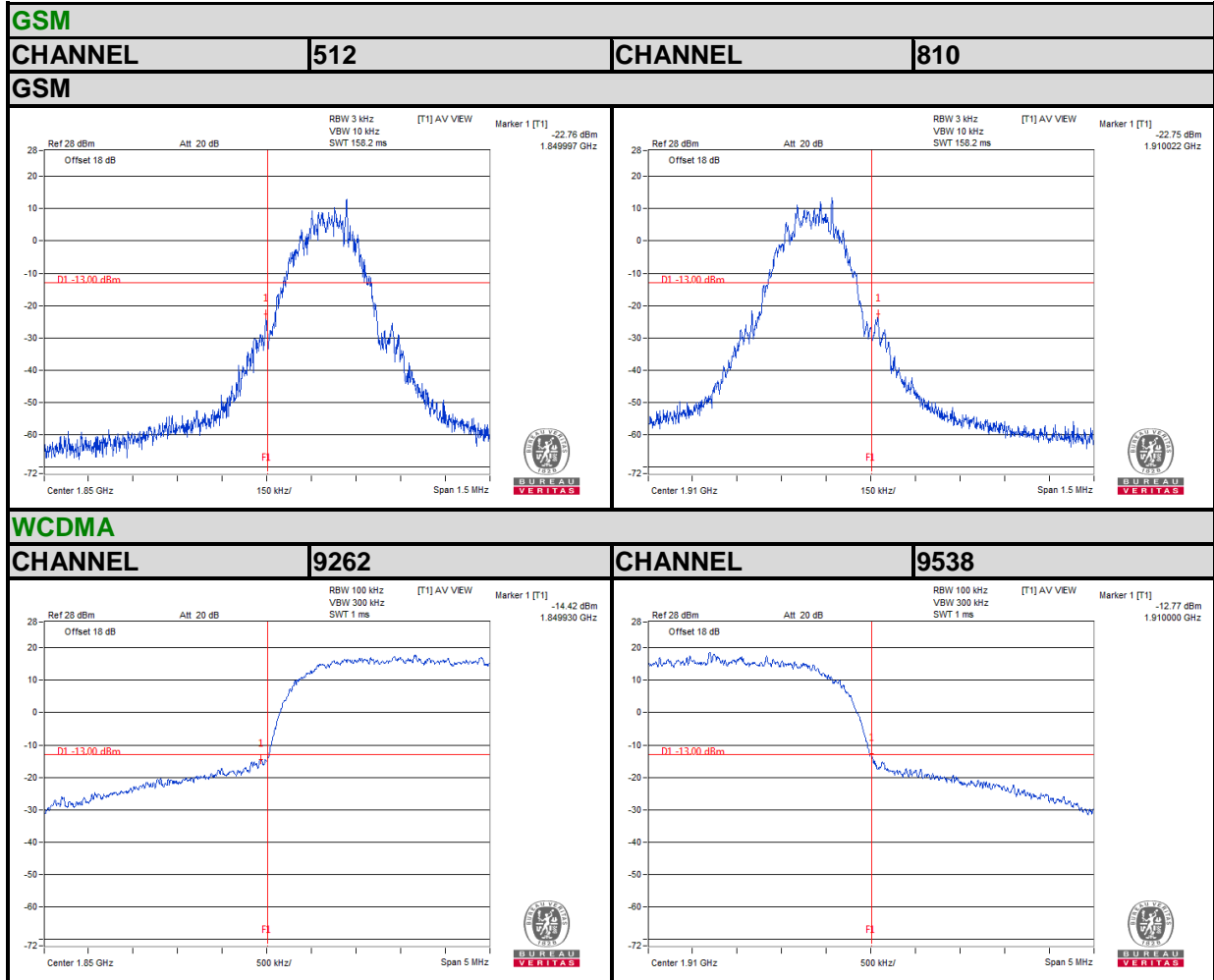



### 3.5 CONDUCTED SPURIOUS EMISSIONS

#### 3.5.1 LIMITS OF CONDUCTED SPURIOUS EMISSIONS MEASUREMENT

The power of any emission outside of the authorized operating frequency ranges must be attenuated below the transmitting power (P) by a factor of at least  $43 + 10 \log(P)$  dB. The emission limit equal to  $-13\text{dBm}$ .

#### 3.5.2 TEST PROCEDURE

- a. The EUT makes a phone call to the communication simulator. All measurements were done at low, middle and high operational frequency range.
- b. Measuring frequency range is from 9 kHz to 19.1GHz. 10dB attenuation pad is connected with spectrum. RBW=1MHz and VBW=3MHz is used for conducted emission measurement.

#### 3.5.3 TEST SETUP

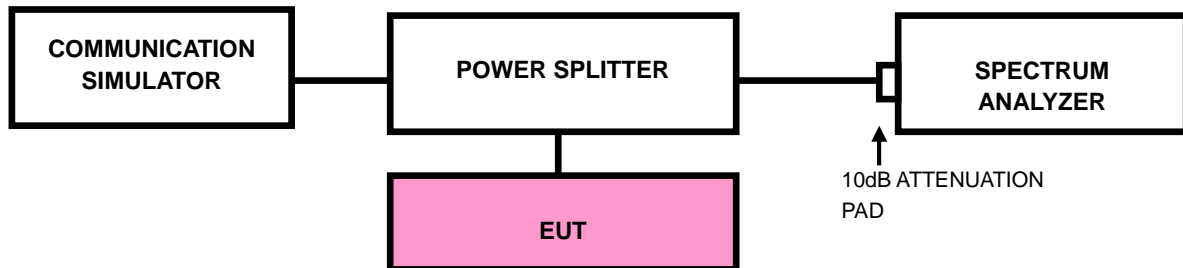





### 3.5.4 TEST RESULTS

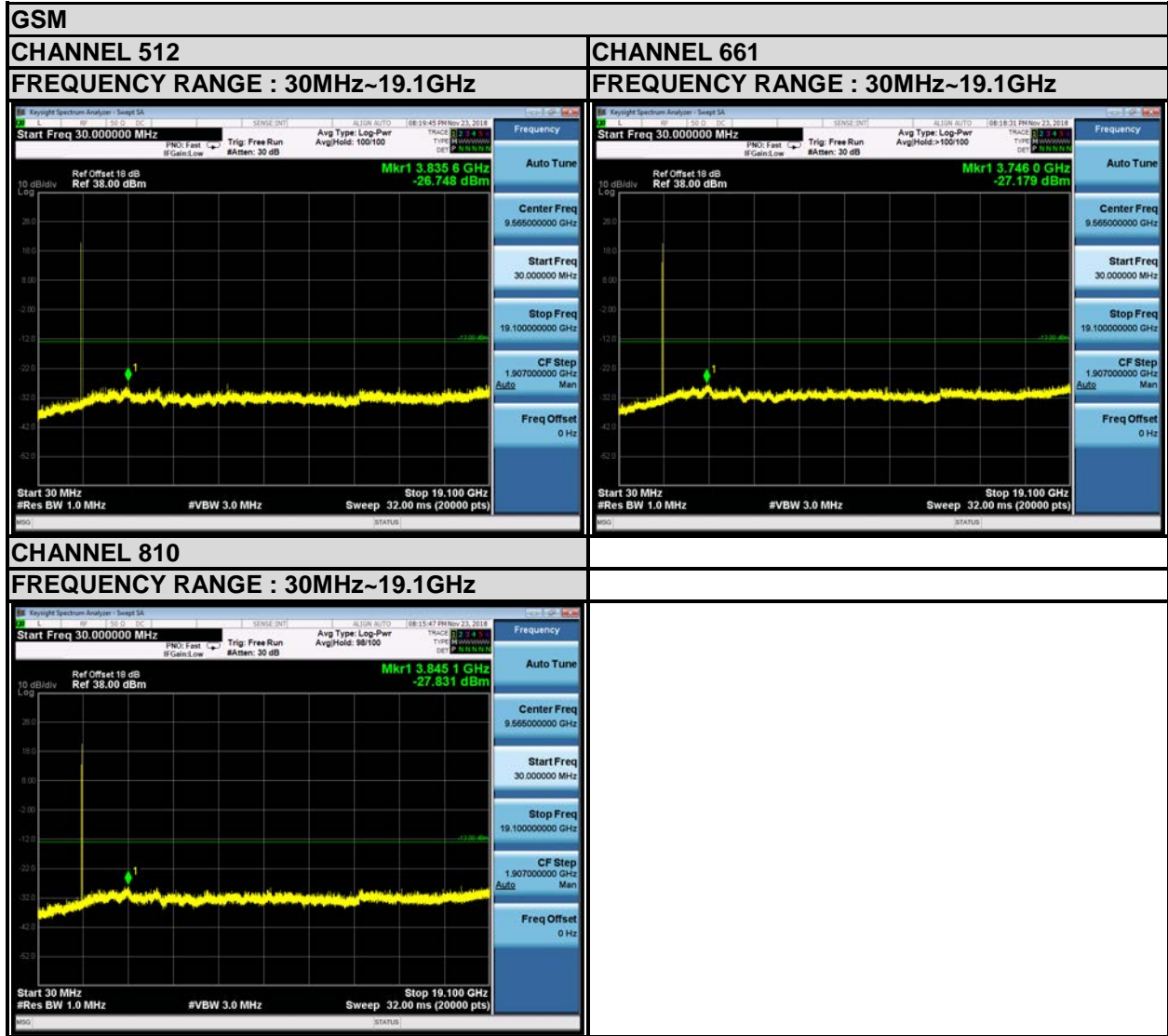



BUREAU VERITAS

Test Report No.: RF181120W002-4

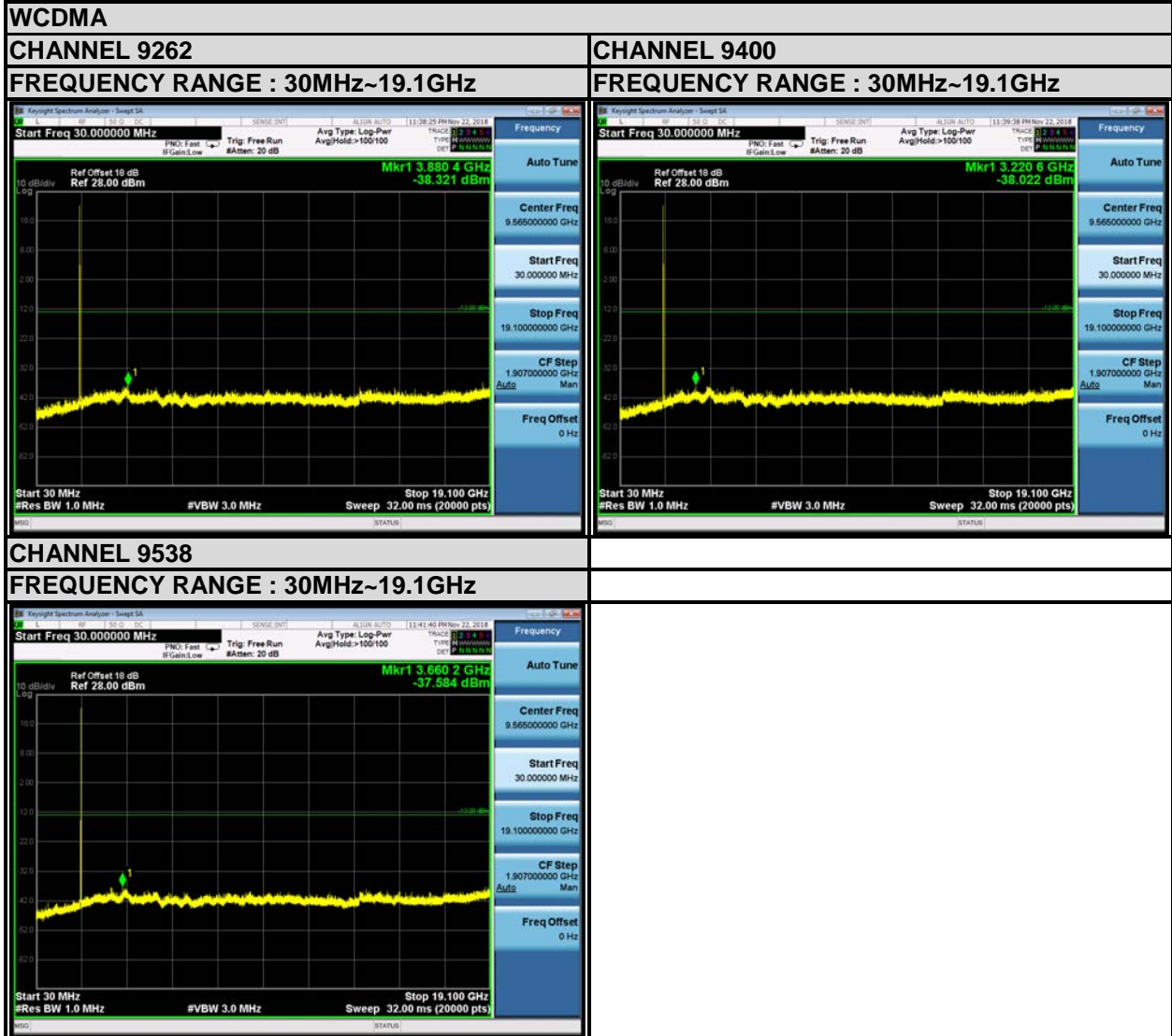



### 3.6 RADIATED EMISSION MEASUREMENT

#### 3.6.1 LIMITS OF RADIATED EMISSION MEASUREMENT

The power of any emission outside of the authorized operating frequency ranges must be attenuated below the transmitting power (P) by a factor of at least  $43 + 10 \log(P)$  dB. The emission limit equal to  $-13\text{dBm}$ .

#### 3.6.2 TEST PROCEDURES

- a. Substitution method is used for E.I.R.P measurement. In the semi-anechoic chamber, EUT placed on the 0.8m height of Turn Table, rotated the table around 360 degrees to search the maximum radiation power and receiver antenna shall be rotated vertical and horizontal polarization and moved height from 1m to 4m to find the maximum polar radiated power. The “Read Value” is the spectrum reading the maximum power value.
- b. The substitution horn antenna is substituted for EUT at the same position and signals generator export the CW signal to the substitution antenna via a TX cable. Rotated the Turn Table and moved receiving antenna to find the maximum radiation power. Adjust output power level of S.G to get a Value of spectrum reading equal to “Read Value “ of step a. Record the power level of S.G
- c.  $\text{EIRP} = \text{Output power level of S.G} - \text{TX cable loss} + \text{Antenna gain of substitution horn}$ .

**NOTE:** The resolution bandwidth and video bandwidth of test receiver/spectrum analyzer is 1MHz/3MHz.

#### 3.6.3 DEVIATION FROM TEST STANDARD

No deviation



### 3.6.4 TEST SETUP

#### <Below 30MHz>

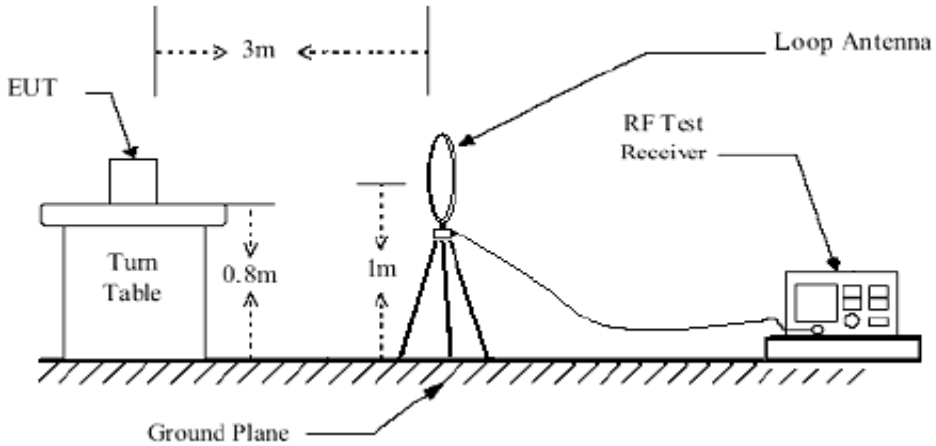

#### < Frequency Range 30MHz~1GHz >

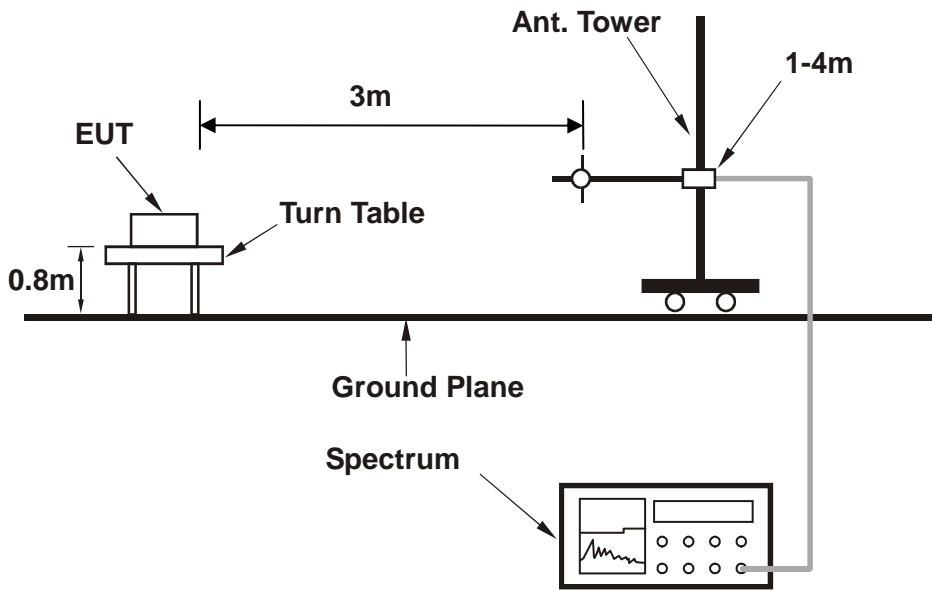



< Frequency Range above 1GHz >

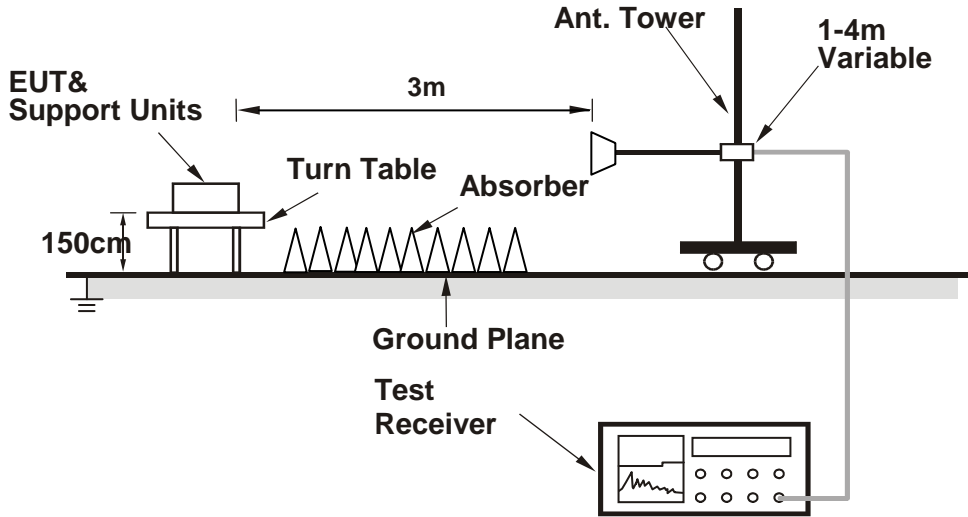

For the actual test configuration, please refer to the attached file (Test Setup Photo).



### 3.6.5 TEST RESULTS

#### BELOW 1GHz WORST-CASE DATA

**9 KHz – 30 MHz data:** the amplitude of spurious emissions attenuated more than 20 dB below the permissible value is not required in the report.

**30 MHz – 1GHz data:**

**WCDMA Band II:**

<b>MODE</b>	TX channel 9400	<b>FREQUENCY RANGE</b>	Below 1000MHz
<b>ENVIRONMENTAL CONDITIONS</b>	23deg. C, 70%RH	<b>INPUT POWER</b>	DC 5V from adapter
<b>TESTED BY</b>	Rose Ma		
<b>ANTENNA POLARITY &amp; TEST DISTANCE: HORIZONTAL AT 3 M</b>			

	Freq	Level	Read Level	Limit Line	Over Limit	Factor	Remark	Pol/Phase
	MHz	dBm/m	dBm	dBm/m	dB	dB/m		
1 PP	37.820	-38.47	-50.71	-13.00	-25.47	12.24	Peak	Horizontal
2	62.510	-57.16	-48.69	-13.00	-44.16	-8.47	Peak	Horizontal
3	106.590	-51.08	-38.55	-13.00	-38.08	-12.53	Peak	Horizontal
4	173.560	-58.76	-40.77	-13.00	-45.76	-17.99	Peak	Horizontal
5	239.620	-57.79	-41.31	-13.00	-44.79	-16.48	Peak	Horizontal
6	320.120	-59.58	-46.45	-13.00	-46.58	-13.13	Peak	Horizontal

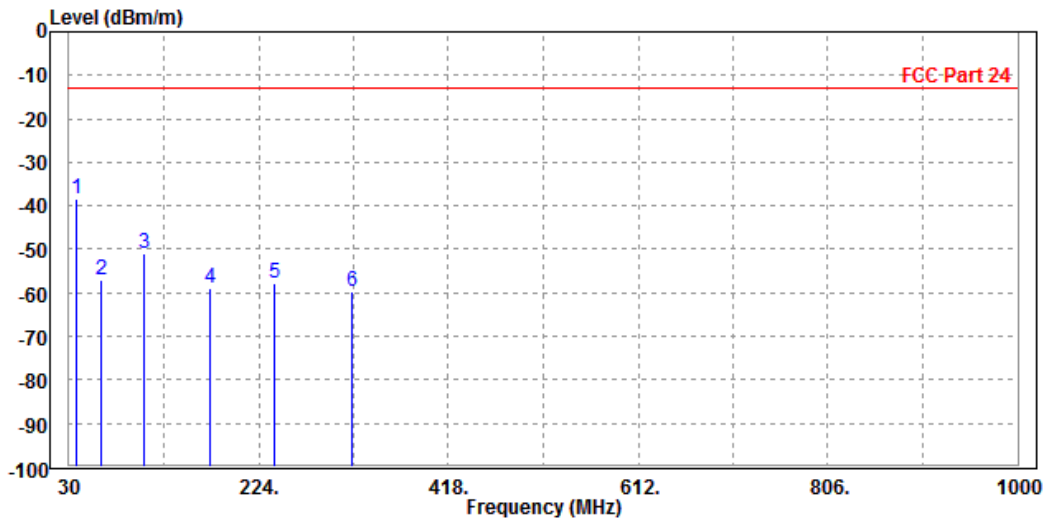



<b>MODE</b>	TX channel 9400	<b>FREQUENCY RANGE</b>	Below 1000MHz
<b>ENVIRONMENTAL CONDITIONS</b>	23deg. C, 70%RH	<b>INPUT POWER</b>	DC 5V from adapter
<b>TESTED BY</b>	Rose Ma		
<b>ANTENNA POLARITY &amp; TEST DISTANCE: VERTICAL AT 3 M</b>			

	Freq	Level	Read Level	Limit Line	Over Limit	Factor	Remark	Pol/Phase
	MHz	dBm/m	dBm	dBm/m	dB	dB/m		
1	59.120	-49.85	-38.15	-13.00	-36.85	-11.70	Peak	Vertical
2 PP	98.260	-49.41	-38.76	-13.00	-36.41	-10.65	Peak	Vertical
3	166.770	-56.92	-42.36	-13.00	-43.92	-14.56	Peak	Vertical
4	200.250	-51.03	-40.39	-13.00	-38.03	-10.64	Peak	Vertical
5	226.380	-50.09	-38.99	-13.00	-37.09	-11.10	Peak	Vertical
6	299.360	-61.47	-50.17	-13.00	-48.47	-11.30	Peak	Vertical

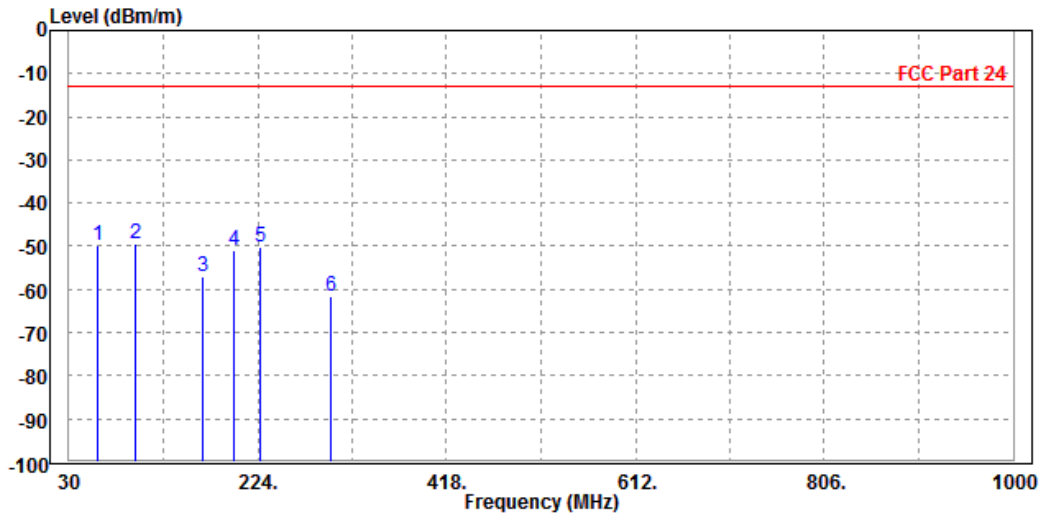



**ABOVE 1GHz DATA**

**Note:** For higher frequency, the emission is too low to be detected.

**PCS 1900:**

**CH 512**

<b>MODE</b>	TX channel 512	<b>FREQUENCY RANGE</b>	Above 1000MHz
<b>ENVIRONMENTAL CONDITIONS</b>	23deg. C, 70%RH	<b>INPUT POWER</b>	DC 5V from adapter
<b>TESTED BY</b>	Rose Ma		
<b>ANTENNA POLARITY &amp; TEST DISTANCE: HORIZONTAL AT 3 M</b>			

	Freq	Level	Read Level	Limit Line	Over Limit	Factor	Remark	Pol/Phase
	MHz	dBm/m	dBm	dBm/m	dB	dB/m		
1	3698.000	-51.77	-54.88	-13.00	-38.77	3.11	Peak	Horizontal
2 PP	5550.000	-45.71	-54.73	-13.00	-32.71	9.02	Peak	Horizontal

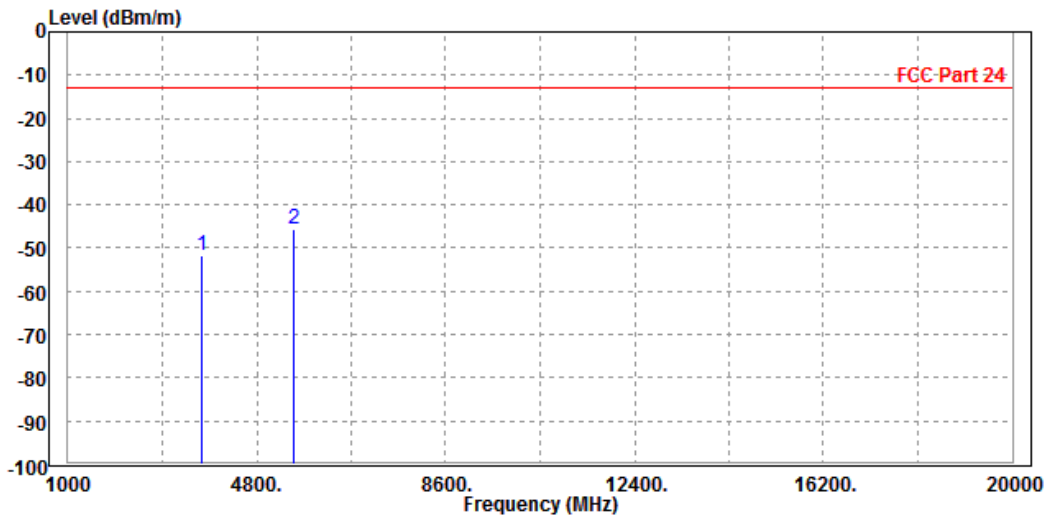





BUREAU VERITAS

Test Report No.: RF181120W002-4

MODE	TX channel 512	FREQUENCY RANGE	Above 1000MHz
ENVIRONMENTAL CONDITIONS	23deg. C, 70%RH	INPUT POWER	DC 5V from adapter
TESTED BY	Rose Ma		
<b>ANTENNA POLARITY &amp; TEST DISTANCE: VERTICAL AT 3 M</b>			

	Freq	Level	Read Level	Limit Line	Over Limit	Factor	Remark	Pol/Phase
	MHz	dBm/m	dBm	dBm/m	dB	dB/m		
1	3698.000	-53.26	-56.83	-13.00	-40.26	3.57	Peak	Vertical
2 PP	5550.000	-47.91	-55.98	-13.00	-34.91	8.07	Peak	Vertical

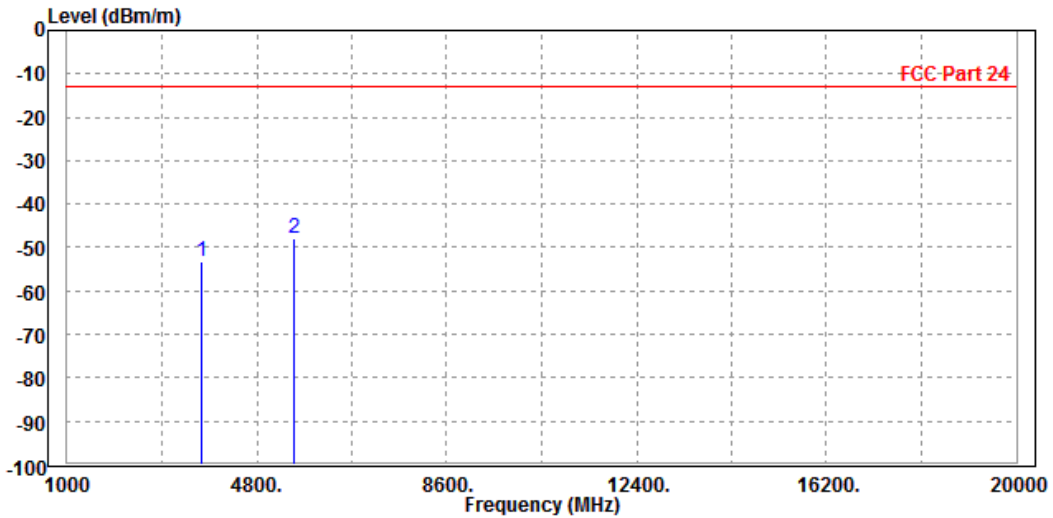



CH 661

MODE	TX channel 661	FREQUENCY RANGE	Above 1000MHz
ENVIRONMENTAL CONDITIONS	23deg. C, 70%RH	INPUT POWER	DC 5V from adapter
TESTED BY	Rose Ma		
<b>ANTENNA POLARITY &amp; TEST DISTANCE: HORIZONTAL AT 3 M</b>			

	Freq	Level	Read Level	Limit Line	Over Limit	Factor	Remark	Pol/Phase
	MHz	dBm/m	dBm	dBm/m	dB	dB/m		
1	3755.000	-51.73	-55.12	-13.00	-38.73	3.39	Peak	Horizontal
2 PP	5640.000	-47.85	-56.97	-13.00	-34.85	9.12	Peak	Horizontal

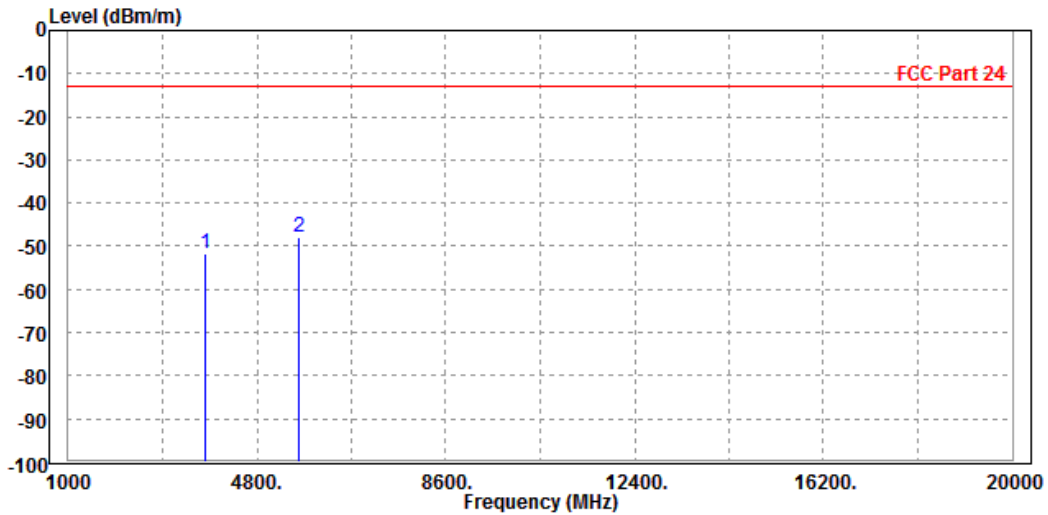



**BUREAU  
VERITAS**

Test Report No.: RF181120W002-4

<b>MODE</b>	TX channel 661	<b>FREQUENCY RANGE</b>	Above 1000MHz
<b>ENVIRONMENTAL CONDITIONS</b>	23deg. C, 70%RH	<b>INPUT POWER</b>	DC 5V from adapter
<b>TESTED BY</b>	Rose Ma		
<b>ANTENNA POLARITY &amp; TEST DISTANCE: VERTICAL AT 3 M</b>			

	Freq	Level	Read Level	Limit Line	Over Limit	Factor	Remark	Pol/Phase
	MHz	dBm/m	dBm	dBm/m	dB	dB/m		
1	3755.000	-52.58	-56.43	-13.00	-39.58	3.85	Peak	Vertical
2 PP	5636.000	-49.60	-57.85	-13.00	-36.60	8.25	Peak	Vertical

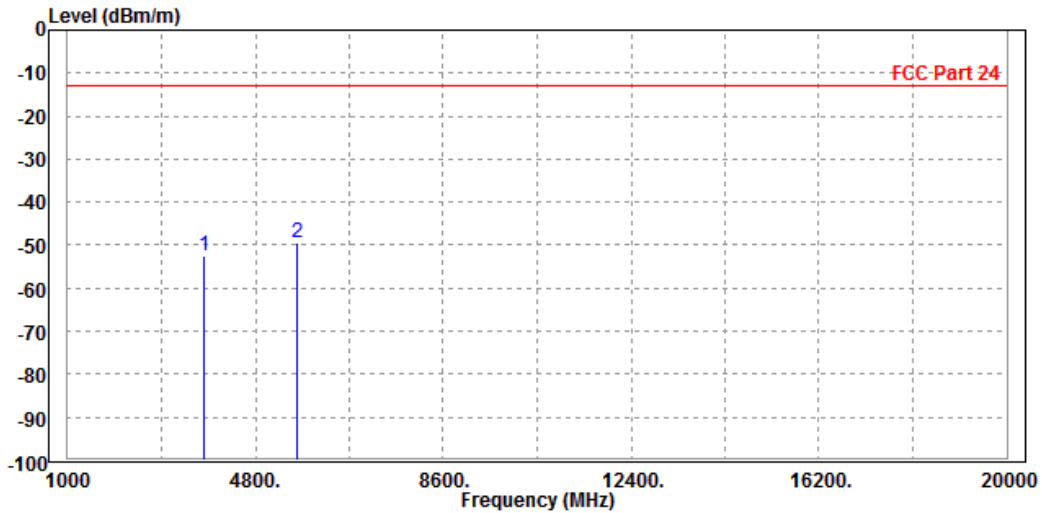



CH 810

MODE	TX channel 810	FREQUENCY RANGE	Above 1000MHz
ENVIRONMENTAL CONDITIONS	23deg. C, 70%RH	INPUT POWER	DC 5V from adapter
TESTED BY	Rose Ma		
<b>ANTENNA POLARITY &amp; TEST DISTANCE: HORIZONTAL AT 3 M</b>			

	Freq	Level	Read Level	Limit Line	Over Limit	Factor	Remark	Pol/Phase
	MHz	dBm/m	dBm	dBm/m	dB	dB/m		
1	3812.000	-50.30	-53.96	-13.00	-37.30	3.66	Peak	Horizontal
2 PP	5730.000	-44.27	-53.49	-13.00	-31.27	9.22	Peak	Horizontal

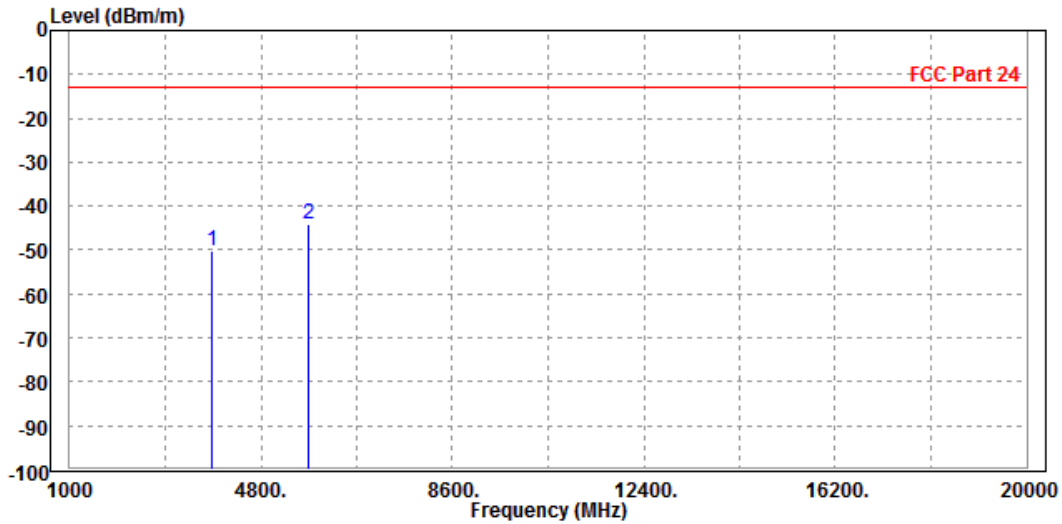



<b>MODE</b>	TX channel 810	<b>FREQUENCY RANGE</b>	Above 1000MHz
<b>ENVIRONMENTAL CONDITIONS</b>	23deg. C, 70%RH	<b>INPUT POWER</b>	DC 5V from adapter
<b>TESTED BY</b>	Rose Ma		
<b>ANTENNA POLARITY &amp; TEST DISTANCE: VERTICAL AT 3 M</b>			

	Freq	Level	Read Level	Limit	Over Limit	Factor	Remark	Pol/Phase
	MHz	dBm/m	dBm	dBm/m	dB	dB/m		
1	3812.000	-52.21	-56.35	-13.00	-39.21	4.14	Peak	Vertical
2	PP 5730.000	-48.61	-57.05	-13.00	-35.61	8.44	Peak	Vertical

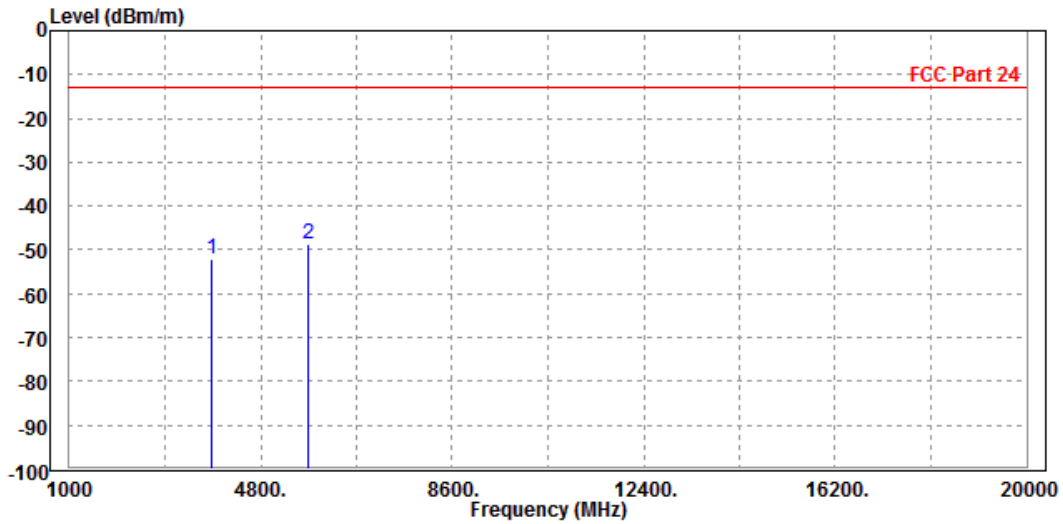



WCDMA Band II

CH 9262

MODE	TX channel 9262	FREQUENCY RANGE	Above 1000MHz
ENVIRONMENTAL CONDITIONS	23deg. C, 70%RH	INPUT POWER	DC 5V from adapter
TESTED BY	Rose Ma		
<b>ANTENNA POLARITY &amp; TEST DISTANCE: HORIZONTAL AT 3 M</b>			

	Freq	Level	Read Level	Limit Line	Over Limit	Factor	Remark	Pol/Phase
	MHz	dBm/m	dBm	dBm/m	dB	dB/m		
1	3698.000	-50.55	-53.66	-13.00	-37.55	3.11	Peak	Horizontal
2 PP	5557.000	-45.18	-54.21	-13.00	-32.18	9.03	Peak	Horizontal

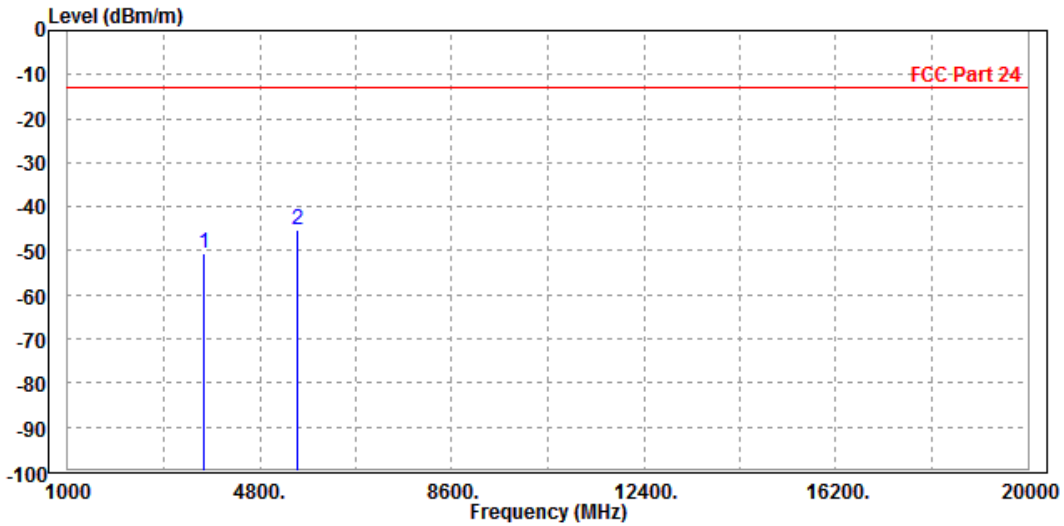



MODE	TX channel 9262	FREQUENCY RANGE	Above 1000MHz
ENVIRONMENTAL CONDITIONS	23deg. C, 70%RH	INPUT POWER	DC 5V from adapter
TESTED BY	Rose Ma		
ANTENNA POLARITY & TEST DISTANCE: VERTICAL AT 3 M			

	Freq	Level	Read Level	Limit Line	Over Limit	Factor	Remark	Pol/Phase
	MHz	dBm/m	dBm	dBm/m	dB	dB/m		
1	3698.000	-52.99	-56.56	-13.00	-39.99	3.57	Peak	Vertical
2 PP	5557.000	-48.91	-57.00	-13.00	-35.91	8.09	Peak	Vertical

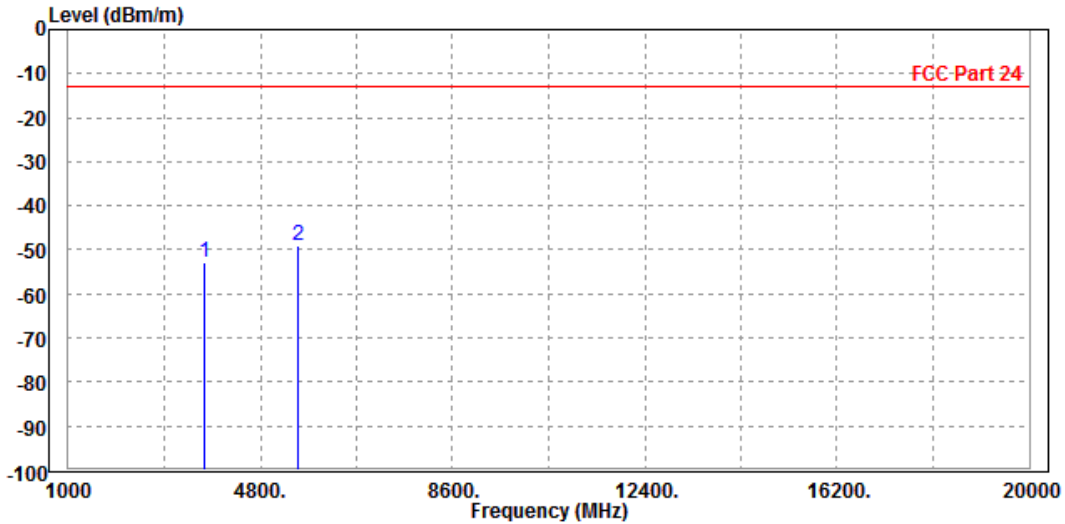



BUREAU VERITAS

Test Report No.: RF181120W002-4

CH 9400

MODE	TX channel 9400	FREQUENCY RANGE	Above 1000MHz
ENVIRONMENTAL CONDITIONS	23deg. C, 70%RH	INPUT POWER	DC 5V from adapter
TESTED BY	Rose Ma		
<b>ANTENNA POLARITY &amp; TEST DISTANCE: HORIZONTAL AT 3 M</b>			

	Freq	Level	Read Level	Limit Line	Over Limit	Factor	Remark	Pol/Phase
	MHz	dBm/m	dBm	dBm/m	dB	dB/m		
1	3755.000	-49.24	-52.63	-13.00	-36.24	3.39	Peak	Horizontal
2 PP	5640.000	-45.71	-54.83	-13.00	-32.71	9.12	Peak	Horizontal

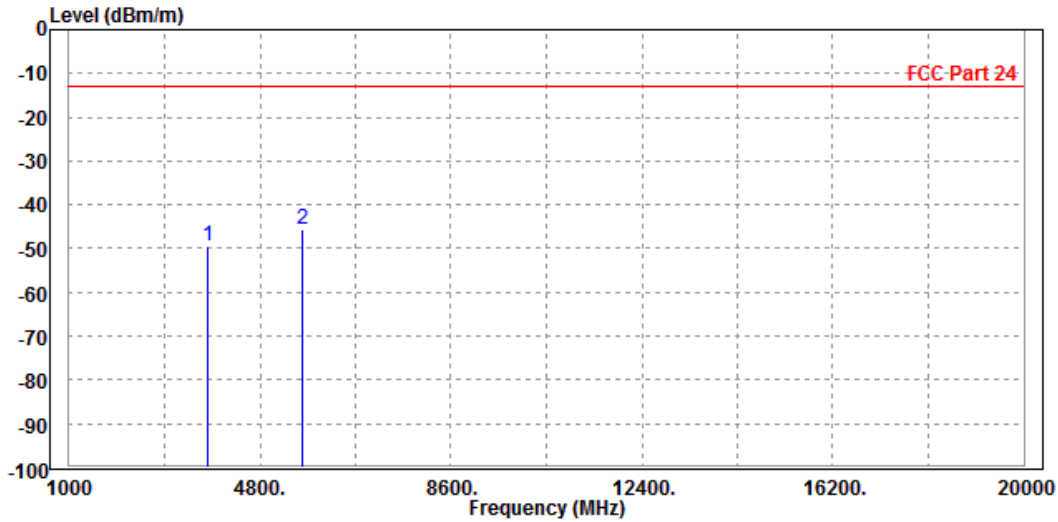





MODE	TX channel 9400	FREQUENCY RANGE	Above 1000MHz
ENVIRONMENTAL CONDITIONS	23deg. C, 70%RH	INPUT POWER	DC 5V from adapter
TESTED BY	Rose Ma		
<b>ANTENNA POLARITY &amp; TEST DISTANCE: VERTICAL AT 3 M</b>			

	Freq	Level	Read Level	Limit Line	Over Limit	Factor	Remark	Pol/Phase
	MHz	dBm/m	dBm	dBm/m	dB	dB/m		
1	3755.000	-50.60	-54.45	-13.00	-37.60	3.85	Peak	Vertical
2 PP	5640.000	-48.65	-56.91	-13.00	-35.65	8.26	Peak	Vertical

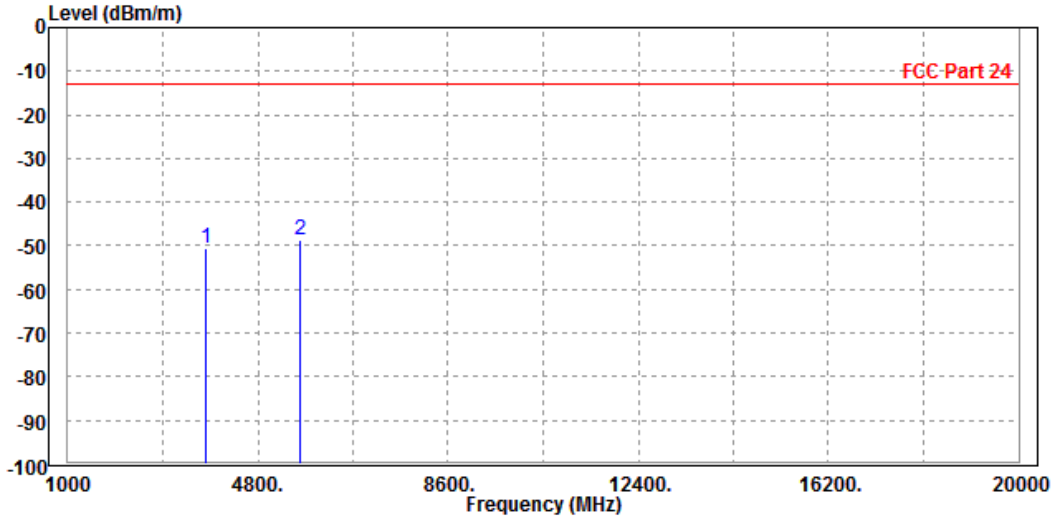



CH 9538

MODE	TX channel 9538	FREQUENCY RANGE	Above 1000MHz
ENVIRONMENTAL CONDITIONS	23deg. C, 70%RH	INPUT POWER	DC 5V from adapter
TESTED BY	Rose Ma		
ANTENNA POLARITY & TEST DISTANCE: HORIZONTAL AT 3 M			

	Freq	Level	Read Level	Limit Line	Over Limit	Factor	Remark	Pol/Phase
	MHz	dBm/m	dBm	dBm/m	dB	dB/m		
1	3812.000	-51.08	-54.74	-13.00	-38.08	3.66	Peak	Horizontal
2 PP	5722.000	-44.11	-53.32	-13.00	-31.11	9.21	Peak	Horizontal

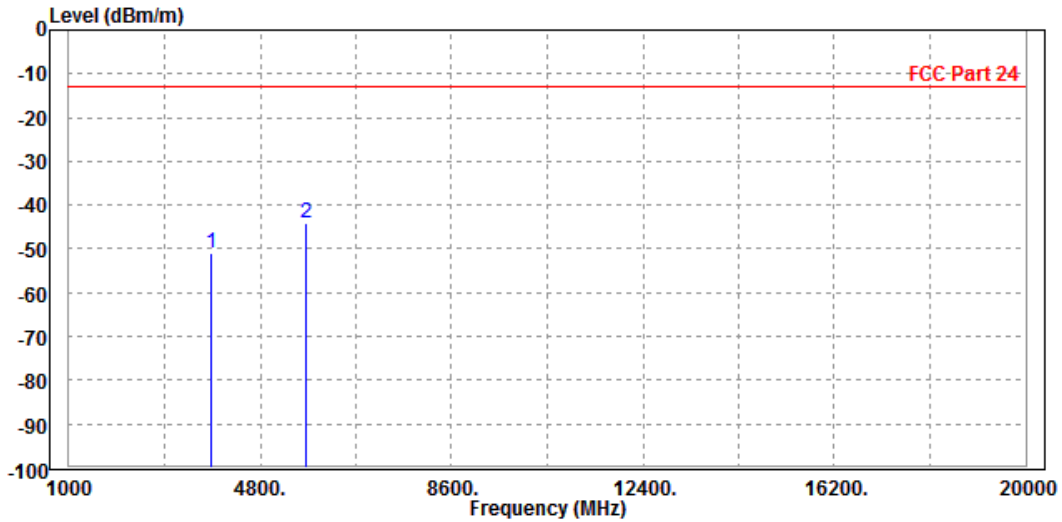



MODE	TX channel 9538	FREQUENCY RANGE	Above 1000MHz
ENVIRONMENTAL CONDITIONS	23deg. C, 70%RH	INPUT POWER	DC 5V from adapter
TESTED BY	Rose Ma		
<b>ANTENNA POLARITY &amp; TEST DISTANCE: VERTICAL AT 3 M</b>			

	Freq	Level	Read Level	Limit Line	Over Limit	Factor	Remark	Pol/Phase
	MHz	dBm/m	dBm	dBm/m	dB	dB/m		
1	3812.000	-52.47	-56.61	-13.00	-39.47	4.14	Peak	Vertical
2 PP	5722.000	-49.41	-57.83	-13.00	-36.41	8.42	Peak	Vertical

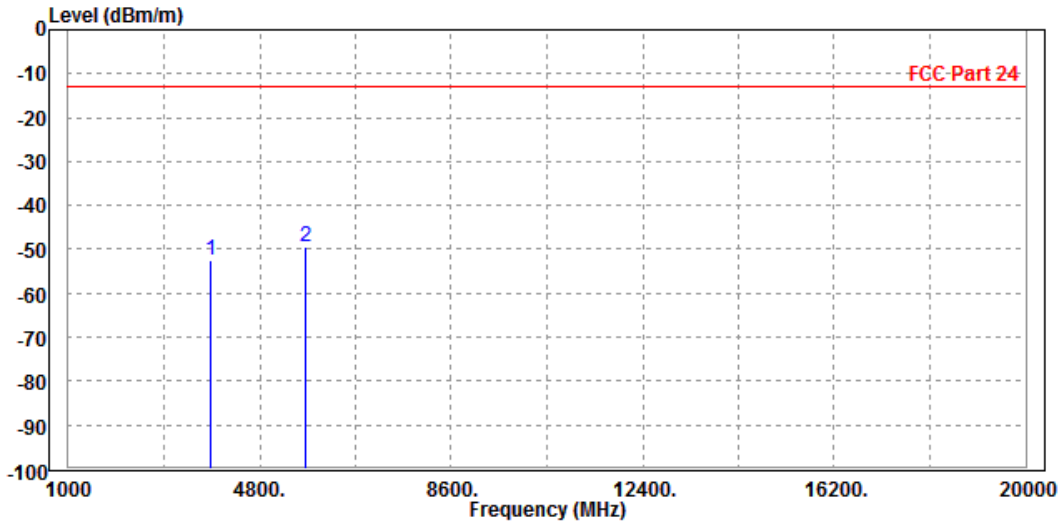



### 3.7 PEAK TO AVERAGE RATIO

#### 3.7.1 LIMITS OF peak to average ratio MEASUREMENT

In measuring transmissions in this band using an average power technique, the peak to-average ratio (PAR) of the transmission may not exceed 13 dB

#### 3.7.2 TEST SETUP

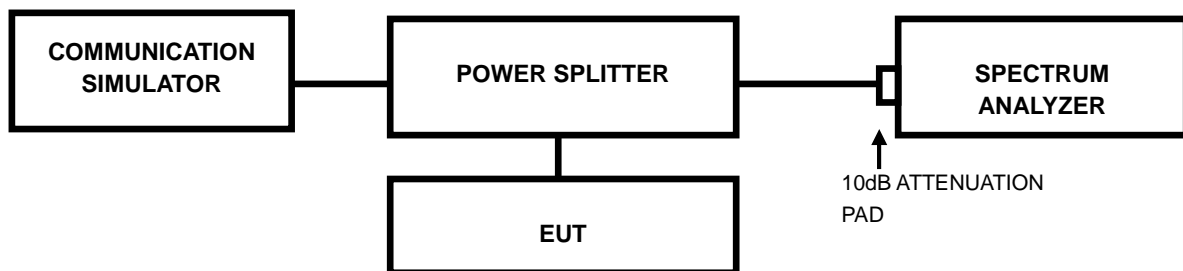

#### 3.7.3 TEST PROCEDURES

1. Set resolution/measurement bandwidth  $\geq$  signal's occupied bandwidth;
2. Set the number of counts to a value that stabilizes the measured CCDF curve;
3. Record the maximum PAPR level associated with a probability of 0.1%.



### 3.7.4 TEST RESULTS

#### GSM

CHANNEL	FREQUENCY (MHz)	PEAK TO AVERAGE RATIO (dB)
512	1850.2	2.69

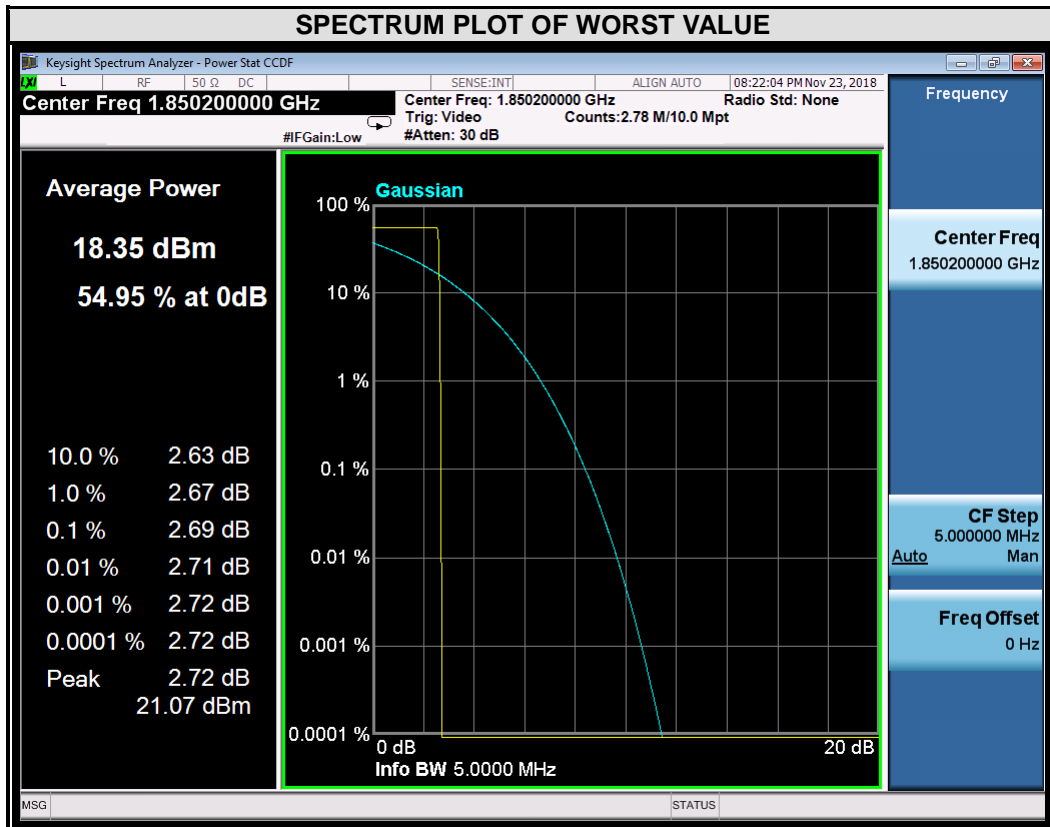



BUREAU VERITAS

Test Report No.: RF181120W002-4

CHANNEL	FREQUENCY (MHz)	PEAK TO AVERAGE RATIO (dB)
661	1880	2.68

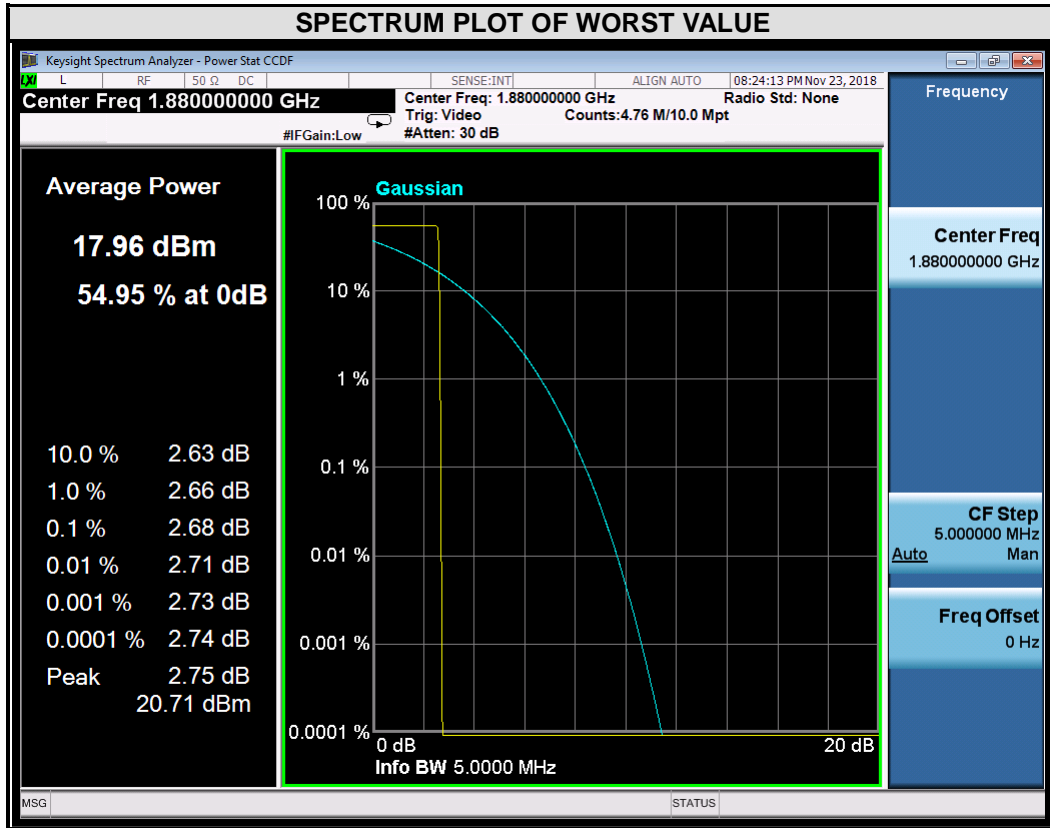



**BUREAU  
VERITAS**

Test Report No.: RF181120W002-4

CHANNEL	FREQUENCY (MHz)	PEAK TO AVERAGE RATIO (dB)
810	1909.8	2.68

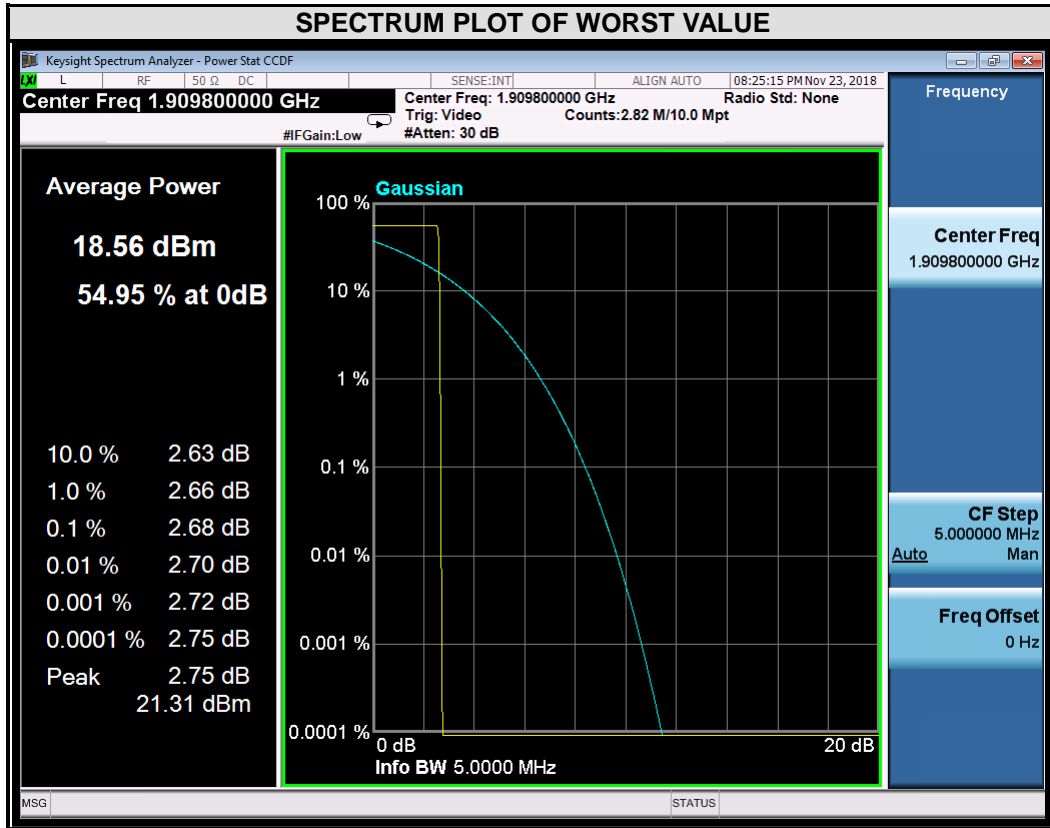



BUREAU VERITAS

Test Report No.: RF181120W002-4

WCDMA

CHANNEL	FREQUENCY (MHz)	PEAK TO AVERAGE RATIO (dB)
9262	1852.4	3.00

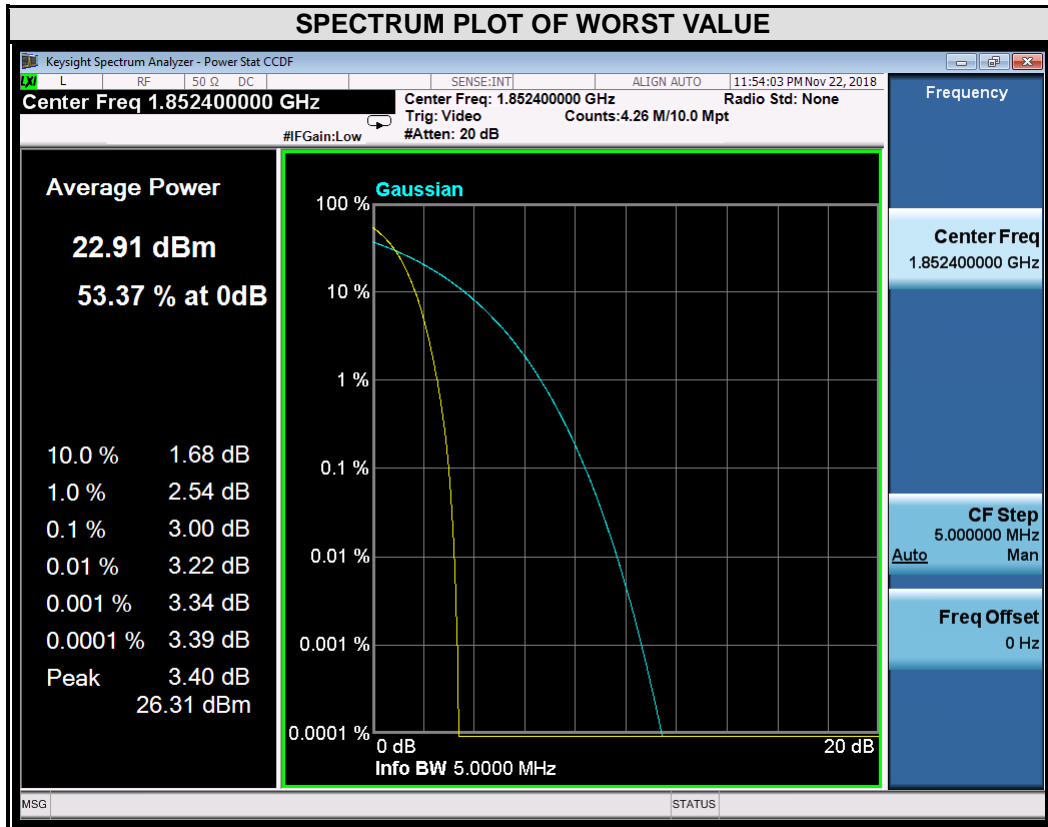





CHANNEL	FREQUENCY (MHz)	PEAK TO AVERAGE RATIO (dB)
9400	1880.0	2.73

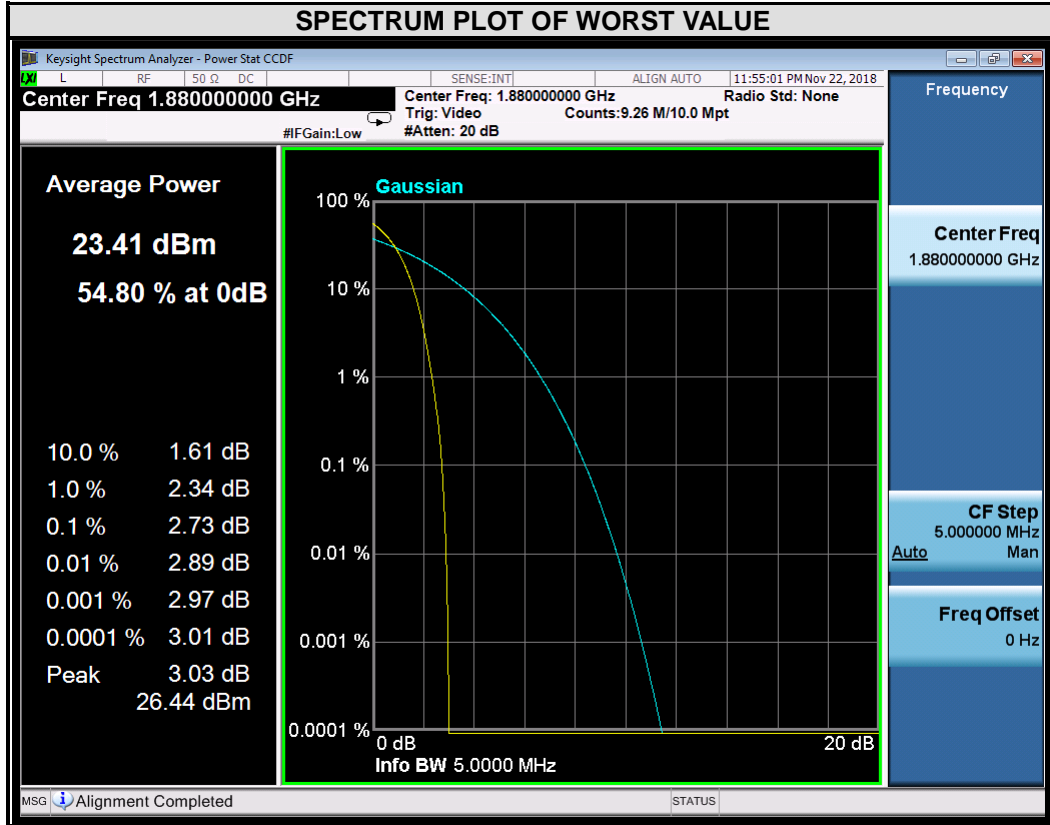



**BUREAU  
VERITAS**

Test Report No.: RF181120W002-4

CHANNEL	FREQUENCY (MHz)	PEAK TO AVERAGE RATIO (dB)
9538	1907.6	2.58

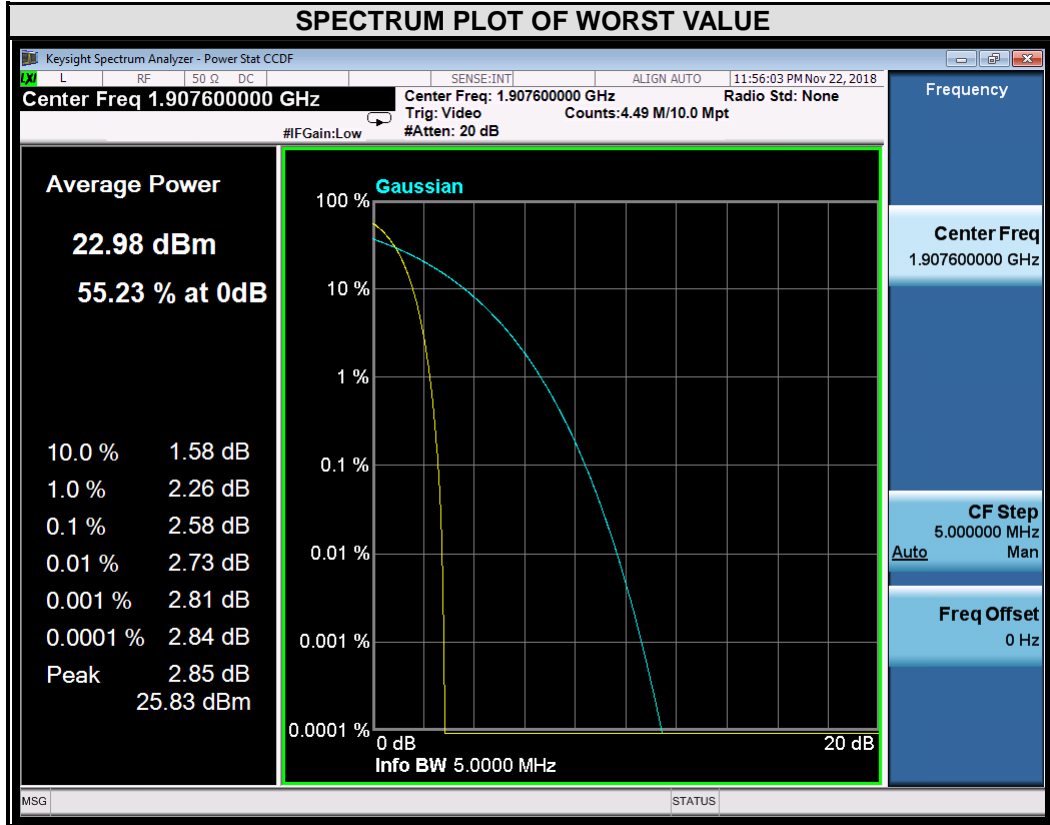



**BUREAU VERITAS** Test Report No.: RF181120W002-4

## 4 INFORMATION ON THE TESTING LABORATORIES

We, BV 7LAYERS COMMUNICATIONS TECHNOLOGY (SHENZHEN) CO. LTD., were founded in 2015 to provide our best service in EMC, Radio, Telecom and Safety consultation. Our laboratories are accredited and approved according to ISO/IEC 17025.

If you have any comments, please feel free to contact us at the following:

**Shenzhen EMC/RF Lab:**

Tel: +86-755-88696566

Fax: +86-755-88696577

**Email:** [customerservice.dg@cn.bureauveritas.com](mailto:customerservice.dg@cn.bureauveritas.com)

**Web Site:** [www.adt.com.tw](http://www.adt.com.tw)

The address and road map of all our labs can be found in our web site also.



**BUREAU VERITAS** Test Report No.: RF181120W002-4

## **5 APPENDIX A – MODIFICATIONS RECORDERS FOR ENGINEERING CHANGES TO THE EUT BY THE LAB**

No any modifications are made to the EUT by the lab during the test.

**---END---**