



# SGS-CSTC Standards Technical Services Co., Ltd. Shenzhen Branch

No. 1 Workshop, M-10, Middle section, Science & Technology Park, Nanshan District, Shenzhen, Guangdong, China 518057

Telephone: +86 (0) 755 2601 2053  
Fax: +86 (0) 755 2671 0594  
Email: ee.shenzhen@sgs.com

Report No.: SZEM180700656301  
Page: 1 of 22

## FCC TEST REPORT

**Application No:** SZEM1807006563RG  
**Applicant:** TCL Communication Ltd.  
**Address of Applicant:** 7/F, Block F4, TCL Communication Technology Building, TCL International E City, Zhong Shan Yuan Road, Nanshan District, Shenzhen, Guangdong, P.R. China 518052  
**Manufacturer:** TCL Communication Ltd.  
**Address of Manufacturer:** 7/F, Block F4, TCL Communication Technology Building, TCL International E City, Zhong Shan Yuan Road, Nanshan District, Shenzhen, Guangdong, P.R. China 518052  
**Product Name:** UMTS/GSM Mobile Phone  
**Model No.(EUT):** 3026G  
**Trade Mark:** alcatel  
**FCC ID:** 2ACCJB103  
**Standards:** 47 CFR Part 2  
47 CFR Part 22 subpart H  
47 CFR Part 24 subpart E  
**Test Method:** FCC KDB 971168 D01 Power Meas License Digital Systems V03r01  
TIA-603-E 2016  
**Date of Receipt:** 2018-08-05  
**Date of Test:** 2018-08-05 to 2018-08-12  
**Date of Issue:** 2018-08-12

<b>Test Result:</b>	<b>PASS *</b>
---------------------	---------------

\* In the configuration tested, the EUT detailed in this report complied with the standards specified above.

Authorized Signature:

Derek Yang  
Wireless Laboratory Manager

The manufacturer should ensure that all products in series production are in conformity with the product sample detailed in this report. If the product in this report is used in any configuration other than that detailed in the report, the manufacturer must ensure the new system complies with all relevant standards. Any mention of SGS International Electrical Approvals or testing done by SGS International Electrical Approvals in connection with, distribution or use of the product described in this report must be approved by SGS International Electrical Approvals in writing.

This document is issued by the Company subject to its General Conditions of Service printed overleaf, -available on request or accessible at <http://www.sgs.com/en/Terms-and-Conditions.aspx> and, for electronic format documents, subject to Terms and Conditions for Electronic Documents at <http://www.sgs.com/en/Terms-and-Conditions/Terms-e-Document.aspx>. Attention is drawn to the limitation of liability, indemnification and jurisdiction issues defined therein. Any holder of this document is advised that information contained hereon reflects the Company's findings at the time of its intervention only and within the limits of Client's instructions, if any. The Company's sole responsibility is to its Client and this document does not exonerate parties to a transaction from exercising all their rights and obligations under the transaction documents. This document cannot be reproduced except in full, without prior written approval of the Company. Any unauthorized alteration, forgery or falsification of the content or appearance of this document is unlawful and offenders may be prosecuted to the fullest extent of the law. Unless otherwise stated the results shown in this test report refer only to the sample(s) tested and such sample(s) are retained for 30 days only.



## 1 Version

Revision Record				
Version	Chapter	Date	Modifier	Remark
01		2018-08-12		Original

Authorized for issue by:				
Tested By				2018-08-12
				Date
Checked By				2018-08-12
				Date
		(Mike Hu) /Project Engineer		
		(David Chen) /Reviewer		



## Content

	Page
<b>1 VERSION</b>	<b>2</b>
<b>2 GENERAL INFORMATION</b>	<b>5</b>
2.1 CLIENT INFORMATION	5
2.2 GENERAL DESCRIPTION OF EUT	5
2.3 TEST MODE	5
2.4 TEST ENVIRONMENT	6
<b>3 TEST SUMMARY</b>	<b>7</b>
1.1 GSM850/UMTS BAND 5	7
1.2 GSM1900/UMTS BAND 2	7
3.1 TEST FREQUENCIES	8
3.2 TEST LOCATION	8
3.3 TEST FACILITY	9
3.4 DEVIATION FROM STANDARDS	9
3.5 ABNORMALITIES FROM STANDARD CONDITIONS	9
3.6 OTHER INFORMATION REQUESTED BY THE CUSTOMER	9
3.7 TECHNICAL SPECIFICATION	10
<b>4 DESCRIPTION OF TESTS</b>	<b>11</b>
4.1 CONDUCTED OUTPUT POWER	11
4.2 EFFECTIVE (ISOTROPIC) RADIATED POWER OF TRANSMITTER	11
4.3 OCCUPIED BANDWIDTH	12
4.4 BAND EDGE AT ANTENNA TERMINALS	12
4.5 SPURIOUS AND HARMONIC EMISSIONS AT ANTENNA TERMINAL	13
4.6 PEAK-AVERAGE RATIO	13
4.7 FIELD STRENGTH OF SPURIOUS RADIATION	14
4.8 FREQUENCY STABILITY / TEMPERATURE VARIATION	15
4.9 TEST SETUPS	16
4.9.1 Test Setup 1	16
4.9.2 Test Setup 2	16
4.9.3 Test Setup 3	17
4.9.4 Test Setup 4	17
4.10 TEST CONDITIONS	18



<b>5</b>	<b>MAIN TEST INSTRUMENTS</b>	<b>20</b>
<b>6</b>	<b>MEASUREMENT UNCERTAINTY</b>	<b>22</b>
<b>7</b>	<b>PHOTOGRAPHS - EUT CONSTRUCTIONAL DETAILS</b>	<b>22</b>



## 2 General Information

### 2.1 Client Information

Applicant:	TCL Communication Ltd.
Address of Applicant:	7/F, Block F4, TCL Communication Technology Building, TCL International E City, Zhong Shan Yuan Road, Nanshan District, Shenzhen, Guangdong, P.R. China 518052
Manufacturer:	TCL Communication Ltd.
Address of Manufacturer:	7/F, Block F4, TCL Communication Technology Building, TCL International E City, Zhong Shan Yuan Road, Nanshan District, Shenzhen, Guangdong, P.R. China 518052

### 2.2 General Description of EUT

Product Name:	UMTS/GSM Mobile Phone
Model No.:	3026G
Trade Mark:	alcatel
Hardware Version:	PIO
Software Version:	010 01
Sample Type:	Portable production
Antenna Type:	PIFA Antenna
Antenna Gain:	GSM850: -0.5dBi; GSM1900:1.4dBi WCDMA BAND II:1.77dBi WCDMA BAND V:-0.57dBi

### 2.3 Test Mode

Test Mode	Test Modes Description
GSM/TM1	GSM system, GSM/GPRS, GMSK modulation
UMTS/TM1	UMTS system, WCDMA, QPSK modulation

NOTE: The test mode(s) are selected according to relevant radio technology specifications.



## 2.4 Test Environment

Environment Parameter	Selected Values During Tests	
Relative Humidity	52%	
Atmospheric Pressure:	101.32 KPa	
Temperature	NT	25 °C
Voltage:	LV	3.5V
	NV	4.2V
	HV	3.7V

NOTE: LV= lower extreme test voltage; NV= nominal voltage  
HV= upper extreme test voltage; NT= normal temperature



### 3 Test Summary

#### 1.1 GSM850/UMTS BAND 5

Test Item	FCC Rule No.	Requirements	Test Result	Verdict
Effective (Isotropic) Radiated Power Output Data	§2.1046, §22.913	FCC: ERP ≤ 7 W	Section 1 of Appendix B	Pass
Peak-Average Ratio	---	Limit≤13 dB	Section 2 of Appendix B	Pass
Modulation Characteristics	§2.1047	Digital modulation	Section 3 of Appendix B	Pass
Bandwidth	§2.1049	OBW: No limit. EBW: No limit.	Section 4 of Appendix B	Pass
Band Edges Compliance	§2.1051, §22.917	≤ -13 dBm/1%*EBW, in 1 MHz bands immediately outside and adjacent to the frequency block.	Section 5 of Appendix B	Pass
Spurious Emission at Antenna Terminals	§2.1051, §22.917	FCC: ≤ -13 dBm/100 kHz, from 9 kHz to 10 <sup>th</sup> harmonics but outside authorized operating frequency ranges.	Section 6 of Appendix B	Pass
Field Strength of Spurious Radiation	§2.1053, §22.917	FCC: ≤ -13 dBm/100 kHz.	Section 7 of Appendix B	Pass
Frequency Stability	§2.1055, §22.355	≤ ±2.5ppm.	Section 8 of Appendix B	Pass

#### 1.2 GSM1900/UMTS BAND 2

Test Item	FCC Rule No.	Requirements	Test Result	Verdict
Effective (Isotropic) Radiated Power Output Data	§2.1046, §24.232	EIRP ≤ 2 W	Section 1 of Appendix B	Pass
Peak-Average Ratio	§2.1046, §24.232	Limit≤13 dB	Section 2 of Appendix B	Pass
Modulation Characteristics	§2.1047	Digital modulation	Section 3 of Appendix B	Pass
Bandwidth	§2.1049	OBW: No limit. EBW: No limit.	Section 4 of Appendix B	Pass
Band Edges Compliance	§2.1051, §24.238	≤ -13 dBm/1%*EBW, in 1 MHz bands immediately outside and adjacent to the frequency block.	Section 5 of Appendix B	Pass
Spurious Emission at Antenna Terminals	§2.1051, §24.238	≤ -13 dBm/1 MHz, from 9 kHz to 10 <sup>th</sup> harmonics but outside authorized operating frequency ranges.	Section 6 of Appendix B	Pass
Field Strength of Spurious Radiation	§2.1053, §24.238	≤ -13 dBm/1 MHz.	Section 7 of Appendix B	Pass
Frequency Stability	§2.1055, §24.235	≤ ±2.5 ppm.	Section 8 of Appendix B	Pass

NOTE: For the verdict, the "N/A" denotes "not applicable", the "N/T" denotes "not tested".



### 3.1 Test Frequencies

Test Mode	TX / RX	RF Channel		
		Low (L)	Middle (M)	High (H)
GSM850	TX	Channel 128	Channel 190	Channel 251
		824.2MHz	836.6 MHz	848.8 MHz
	RX	Channel 128	Channel 190	Channel 251
		869.2 MHz	881.6 MHz	893.8 MHz

Test Mode	TX / RX	RF Channel		
		Low (L)	Middle (M)	High (H)
GSM1900	TX	Channel 512	Channel 661	Channel 810
		1850.2MHz	1880.0 MHz	1909.8 MHz
	RX	Channel 512	Channel 661	Channel 810
		1930.2 MHz	1960.0 MHz	1989.8 MHz

Test Mode	TX / RX	RF Channel		
		Low (L)	Middle (M)	High (H)
WCDMA BAND V	TX	Channel 4132	Channel 4182	Channel 4233
		826.4MHz	836.4 MHz	846.6 MHz
	RX	Channel 4357	Channel 4407	Channel 4458
		871.4 MHz	881.4 MHz	891.6 MHz

Test Mode	TX / RX	RF Channel		
		Low (L)	Middle (M)	High (H)
WCDMA BAND II	TX	Channel 9262	Channel 9400	Channel 9538
		1852.4 MHz	1880.0 MHz	1907.6 MHz
	RX	Channel 9662	Channel 9800	Channel 9938
		1932.4 MHz	1960.0 MHz	1987.6 MHz

### 3.2 Test Location

All tests were performed at:

SGS-CSTC Standards Technical Services Co., Ltd., Shenzhen Branch

No. 1 Workshop, M-10, Middle Section, Science & Technology Park, Shenzhen, Guangdong, China.  
518057.

Tel: +86 755 2601 2053 Fax: +86 755 2671 0594

No tests were sub-contracted.





### **3.3 Test Facility**

The test facility is recognized, certified, or accredited by the following organizations:

- **CNAS (No. CNAS L2929)**

CNAS has accredited SGS-CSTC Standards Technical Services Co., Ltd. Shenzhen Branch EMC Lab to ISO/IEC 17025:2005 General Requirements for the Competence of Testing and Calibration Laboratories (CNAS-CL01 Accreditation Criteria for the Competence of Testing and Calibration Laboratories) for the competence in the field of testing.

- **A2LA (Certificate No. 3816.01)**

SGS-CSTC Standards Technical Services Co., Ltd., Shenzhen EMC Laboratory is accredited by the American Association for Laboratory Accreditation(A2LA). Certificate No. 3816.01.

- **VCCI**

The 3m Fully-anechoic chamber for above 1GHz, 10m Semi-anechoic chamber for below 1GHz, Shielded Room for Mains Port Conducted Interference Measurement and Telecommunication Port Conducted Interference Measurement of SGS-CSTC Standards Technical Services Co., Ltd. have been registered in accordance with the Regulations for Voluntary Control Measures with Registration No.: G-20026, R-14188, C-12383 and T-11153 respectively.

- **FCC –Designation Number: CN1178**

SGS-CSTC Standards Technical Services Co., Ltd., Shenzhen EMC Laboratory has been recognized as an accredited testing laboratory.

Designation Number: CN1178. Test Firm Registration Number: 406779.

- **Industry Canada (IC)**

Two 3m Semi-anechoic chambers and the 10m Semi-anechoic chamber of SGS-CSTC Standards Technical Services Co., Ltd. Shenzhen Branch EMC Lab have been registered by Certification and Engineering Bureau of Industry Canada for radio equipment testing with Registration No.: 4620C-1, 4620C-2, 4620C-3.

### **3.4 Deviation from Standards**

None.

### **3.5 Abnormalities from Standard Conditions**

None.

### **3.6 Other Information Requested by the Customer**

None.



### 3.7 Technical Specification

Characteristics	Description	
Radio System Type	<input checked="" type="checkbox"/> GSM	
	<input checked="" type="checkbox"/> UMTS	
Supported Frequency Range	GSM850	Transmission (TX):824 to 849 MHz
		Receiving (RX):869 to 894 MHz
	GSM1900	Transmission (TX):1850 to 1910 MHz
		Receiving (RX): 1930 to 1990 MHz
	UMTS BAND II	Transmission (TX):1850 to 1910 MHz
		Receiving (RX):1930 to 1990 MHz
	UMTS BAND V	Transmission (TX):824 to 849 MHz
		Receiving (RX):869 to 894 MHz
Target TX Output Power	GSM850:32.5 dBm GSM1900: 29dBm UMTS BAND II: 22.5dBm UMTS BAND V: 22.5dBm	
Supported Channel Bandwidth	GSM system:	<input checked="" type="checkbox"/> 0.2 MHz
	UMTS system:	<input checked="" type="checkbox"/> 5 MHz
Characteristics	Description	
Designation of Emissions (Note: the necessary bandwidth of which is the worst value from the measured occupied bandwidths for each type of channel bandwidth configuration.)	GSM850	310KGXW;
	GSM1900	311KGXW;
	UMTS BAND II	4M10F9W
	UMTS BAND V	4M10F9W



## 4 Description of Tests

### 4.1 Conducted Output Power

Measurement Procedure: FCC KDB 971168 D01 V03r01

The transmitter output was connected to a calibrated coaxial cable, attenuator and power meter, the other end of which was connected to a Base Station Simulator. The Base Station Simulator was set to force the EUT to its maximum power setting. The power output at the transmitter antenna port was determined by adding the value of the cable insertion loss to the power reading. The tests were performed at three frequencies (low channel, middle channel and high channel) and on the highest power levels, which can be setup on the transmitters.

**Note: Reference test setup 1**

### 4.2 Effective (Isotropic) Radiated Power of Transmitter

Measurement Procedure: FCC KDB 971168 D01 V03r01 ; ANSI/TIA-603-E-2016-Section 2.2.17

**Below 1GHz test procedure as below:**

- 1). The EUT was powered ON and placed on a 0.8m high table in the chamber. The antenna of the transmitter was extended to its maximum length.
- 2). The disturbance of the transmitter was maximized on the test receiver display by raising and lowering from 1m to 4m the receive antenna and by rotating through 360° the turntable. After the fundamental emission was maximized, a field strength measurement was made.
- 3). Steps 1) and 2) were performed with the EUT and the receive antenna in both vertical and horizontal polarization.
- 4). The transmitter was then removed and replaced with another antenna. The center of the antenna was approximately at the same location as the center of the transmitter.
- 5). A signal at the disturbance was fed to the substitution antenna by means of a non-radiating cable. With both the substitution and the receive antennas horizontally polarized, the receive antenna was raised and lowered to obtain a maximum reading at the test receiver. The level of the signal generator was adjusted until the measured field strength level in step 2) is obtained for this set of conditions.
- 6). The output power into the substitution antenna was then measured.
- 7). Steps 5) and 6) were repeated with both antennas polarized.
- 8). Calculate power in dBm by the following formula:

$$\text{ERP (dBm)} = \text{Pg(dBm)} - \text{cable loss (dB)} + \text{antenna gain (dBd)}$$

Where:

Pg is the generator output power into the substitution antenna.

**Above 1GHz test procedure as below:**

- 1). Different between above is the test site, change from Semi- Anechoic Chamber to fully Anechoic Chamber
- 2). Calculate power in dBm by the following formula:

$$\text{EIRP(dBm)} = \text{Pg(dBm)} - \text{cable loss (dB)} + \text{antenna gain (dBi)}$$

$$\text{EIRP} = \text{ERP} + 2.15\text{dB}$$

Where:

Pg is the generator output power into the substitution antenna.



- 3). Test the EUT in the lowest channel, the middle channel the Highest channel
- 4). The radiation measurements are performed in X, Y, Z axis positioning. And found the X axis positioning which it is worse case, Only the test worst case mode is recorded in the report.
- 5). Repeat above procedures until all frequencies measured was complete.

**Note: Reference test setup 2**

### **4.3 Occupied Bandwidth**

Measurement Procedure: FCC KDB 971168 D01 V03r01 Section 4.2

The occupied bandwidth, that is the frequency bandwidth such that, below its lower and above its upper frequency limits, the mean powers radiated are each equal to 0.5 percent of the total mean power radiated by a given emission shall be measured. The transmitter output was connected to a calibrated coaxial cable, attenuator and Spectrum analyser, the other end of which was connected to a Base Station Simulator. The Base Station Simulator was set to force the EUT to its maximum power setting. The tests were performed at three frequencies (low channel, middle channel and high channel). The span of the analyzer shall be set to capture all products of the modulation process, including the emission skirts. The resolution bandwidth shall be set to as close to 1 percent of the selected span as is possible without being below 1 percent. The video bandwidth shall be set to 3 times the resolution bandwidth. Video averaging is not permitted. Where practical, a sampling detector shall be used since a peak or, peak hold, may produce a wider bandwidth than actual. The trace data points are recovered and are directly summed in linear terms. The recovered amplitude data points, beginning at the lowest frequency, are placed in a running sum until 0.5 percent of the total is reached and that frequency recorded. The process is repeated for the highest frequency data points. This frequency is recorded. The span between the two recorded frequencies is the occupied bandwidth.

**Note: Reference test setup 1**

#### Test Settings

1. The signal analyzer's automatic bandwidth measurement capability was used to perform the 99% occupied bandwidth and the 26dB bandwidth. The bandwidth measurement was not influenced by any intermediate power nulls in the fundamental emission.
2. RBW = 1 – 5% of the expected OBW
3. VBW  $\geq$  3 x RBW
4. Detector = Peak
5. Trace mode = max hold
6. Sweep = auto couple
7. The trace was allowed to stabilize
8. If necessary, steps 2 – 7 were repeated after changing the RBW such that it would be within 1 – 5% of the 99% occupied bandwidth observed in Step 7

### **4.4 Band Edge at Antenna Terminals**

Measurement Procedure: FCC KDB 971168 D01 V03r01 Section 6.0

The transmitter output was connected to a calibrated coaxial cable, attenuator and Spectrum analyser, the other end of which was connected to a Base Station Simulator. The Base Station Simulator was set to force the EUT to its maximum power setting. The tests were performed at three frequencies (low channel and high channel). in the 1MHz bands immediately outside and adjacent to the frequency block a resolution



bandwidth of 100kHz or 1% of the emission bandwidth of the fundamental emission of the transmitter may be employed. The EUT emission bandwidth is measured as the width of the signal between two points, outside of which all emission are attenuated at least 26dB below the transmitter power. The video bandwidth of the spectrum analyzer was set at thrice the resolution bandwidth. Detector Mode was set to peak or peak hold power.

**Note: Reference test setup 1**

Test Settings

1. Start and stop frequency were set such that the band edge would be placed in the center of the plot
2. Span was set large enough so as to capture all out of band emissions near the band edge
3.  $RBW \geq 1\%$  of the emission bandwidth
4.  $VBW \geq 3 \times RBW$
5. Detector = RMS
6. Number of sweep points  $\geq 2 \times \text{Span}/RBW$
7. Trace mode = trace average for continuous emissions, max hold for pulse emissions
8. Sweep time = auto couple
9. The trace was allowed to stabilize

## 4.5 Spurious And Harmonic Emissions at Antenna Terminal

Measurement Procedure: FCC KDB 971168 D01 V03r01

The transmitter output was connected to a calibrated coaxial cable, attenuator and Spectrum analyzer, the other end of which was connected to a Base Station Simulator. The Base Station Simulator was set to force the EUT to its maximum power setting. The tests were performed at three frequencies (low channel and high channel). The level of the carrier and the various conducted spurious and harmonic frequencies is measured by means of a calibrated spectrum analyzer. The spectrum is scanned from the lowest frequency generated in the equipment up to a frequency including its 10th harmonic. On any frequency outside a licensee's frequency block, the power of any emission shall be attenuated below the transmitter power (P) by at least  $43 + 10 \log(P)$  dB. Compliance with these provisions is based on the use of measurement instrumentation employing a resolution bandwidth of 1 MHz or greater. However, in the 1 MHz bands immediately outside and adjacent to the frequency block a resolution bandwidth of at least one percent of the emission bandwidth of the fundamental emission of the transmitter may be employed. The emission bandwidth is defined as the width of the signal between two points, one below the carrier center frequency and one above the carrier center frequency, outside of which all emission are attenuated at least 26 dB below the transmitter power.

**Note: Reference test setup 1**

Test Settings

1. Start frequency was set to 30MHz and stop frequency was set to at least  $10 \times$  the fundamental frequency (separated into at least two plots per channel)
2. Detector = RMS
3. Trace mode = trace average for continuous emissions, max hold for pulse emissions
4. Sweep time = auto couple
5. The trace was allowed to stabilize
6. Please see test notes below for RBW and VBW settings

## 4.6 Peak-Average Ratio

Measurement Procedure: FCC KDB 971168 D01 V03r01 Section 5.7.1

A peak to average ratio measurement is performed at the conducted port of the EUT. For WCDMA signals, the spectrum analyzers Complementary Cumulative Distribution Function (CCDF) measurement profile is used to determine the largest deviation between the average and the peak power of the EUT in a



given bandwidth. The CCDF curve shows how much time the peak waveform spends at or above a given average power level. The percent of time the signal spends at or above the level defines the probability for that particular power level. For GSM signals, an average and a peak trace are used on a spectrum analyzer to determine the largest deviation between the average and the peak power of the EUT in a bandwidth greater than the emission bandwidth. The traces are generated with the spectrum analyzer set to zero span mode.

**Note: Reference test setup 1**

Test Settings

1. The signal analyzer's CCDF measurement profile is enabled
2. Frequency = carrier center frequency
3. Measurement BW > Emission bandwidth of signal
4. The signal analyzer was set to collect one million samples to generate the CCDF curve
5. The measurement interval was set depending on the type of signal analyzed. For continuous signals (>98% duty cycle), the measurement interval was set to 1ms. For burst transmissions, the spectrum analyzer is set to use an internal "RF Burst" trigger that is synced with an incoming pulse and the measurement interval is set to less than the duration of the "on time" of one burst to ensure that energy is only captured during a time in which the transmitter is operating at maximum power

## 4.7 Field Strength of Spurious Radiation

Measurement Procedure: FCC KDB 971168 D01 V03r01

**Below 1GHz test procedure as below:**

- 1). The EUT was powered ON and placed on a 80cm high table in the chamber. The antenna of the transmitter was extended to its maximum length.
- 2). The disturbance of the transmitter was maximized on the test receiver display by raising and lowering from 1m to 4m (for the test frequency of below 30MHz, the antenna was tuned to heights 1 meter) the receive antenna and by rotating through 360° the turntable. After the fundamental emission was maximized, a field strength measurement was made.
- 3). Steps 1) and 2) were performed with the EUT and the receive antenna in both vertical and horizontal polarization.
- 4). The transmitter was then removed and replaced with another antenna. The center of the antenna was approximately at the same location as the center of the transmitter.
- 5). A signal at the disturbance was fed to the substitution antenna by means of a non-radiating cable. With both the substitution and the receive antennas horizontally polarized, the receive antenna was raised and lowered to obtain a maximum reading at the test receiver. The level of the signal generator was adjusted until the measured field strength level in step 2) is obtained for this set of conditions.
- 6). The output power into the substitution antenna was then measured.
- 7). Steps 5) and 6) were repeated with both antennas polarized.
- 8) Calculate power in dBm by the following formula:

$$\text{ERP(dBm)} = \text{Pg(dBm)} - \text{cable loss (dB)} + \text{antenna gain (dBd)}$$

Where:

$P_d$  is the dipole equivalent power,  $P_g$  is the generator output into the substitution antenna, and the antenna gain is the gain of the substitute antenna used relative to either a half-wave dipole (dBd) or an isotropic source (dBi). The substitute level is equal to  $P_g$  [dBm] – cable loss [dB]. The calculated  $P_d$  levels are then compared to the absolute spurious emission limit of -13dBm which is equivalent to the required minimum attenuation of  $43 + 10\log_{10}(\text{Power [Watts]})$ .



**Above 1GHz test procedure as below:**

- 1) Different between above is the test site, change from Semi- Anechoic Chamber to fully Anechoic Chamber
- 2) Calculate power in dBm by the following formula:

$$\text{EIRP(dBm)} = \text{Pg(dBm)} - \text{cable loss (dB)} + \text{antenna gain (dBi)}$$

$$\text{EIRP} = \text{ERP} + 2.15\text{dB}$$

Where:

Pg is the generator output power into the substitution antenna.

3. Test the EUT in the lowest channel, the middle channel the Highest channel
4. The radiation measurements are performed in X, Y, Z axis positioning. And found the X axis positioning which it is worse case, Only the test worst case mode is recorded in the report.
5. Repeat above procedures until all frequencies measured was complete

**Note: Reference test setup 3**

## **4.8 Frequency Stability / Temperature Variation**

Measurement Procedure:

Frequency stability testing is performed in accordance with the guidelines of FCC KDB 971168 D01 V03r01; ANSI/TIA-603-E-2016

. The frequency stability of the transmitter is measured by:

- a.) **Temperature:** The temperature is varied from -30°C to +50°C in 10°C increments using an environmental chamber.
- b.) **Primary Supply Voltage:** The primary supply voltage is varied from 85% to 115% of the nominal value for non hand-carried battery and AC powered equipment. For hand-carried, battery-powered equipment, primary supply voltage is reduced to the battery operating end point which shall be specified by the manufacturer.

Specification – The frequency stability shall be sufficient to ensure that the fundamental emission stays within the authorized frequency block. The frequency stability of the transmitter shall be maintained within  $\pm 0.00025\%$  ( $\pm 2.5$  ppm ) of the center frequency.

### **Time Period and Procedure:**

1. The carrier frequency of the transmitter is measured at room temperature (20°C to provide a reference).
2. The equipment is turned on in a “standby” condition for fifteen minutes before applying power to the transmitter. Measurement of the carrier frequency of the transmitter is made within one minute after applying power to the transmitter.
3. Frequency measurements are made at 10°C intervals ranging from -30°C to +50°C. A period of at least one half-hour is provided to allow stabilization of the equipment at each temperature level.

**Note: Reference test setup 4**

## 4.9 Test Setups

### 4.9.1 Test Setup 1

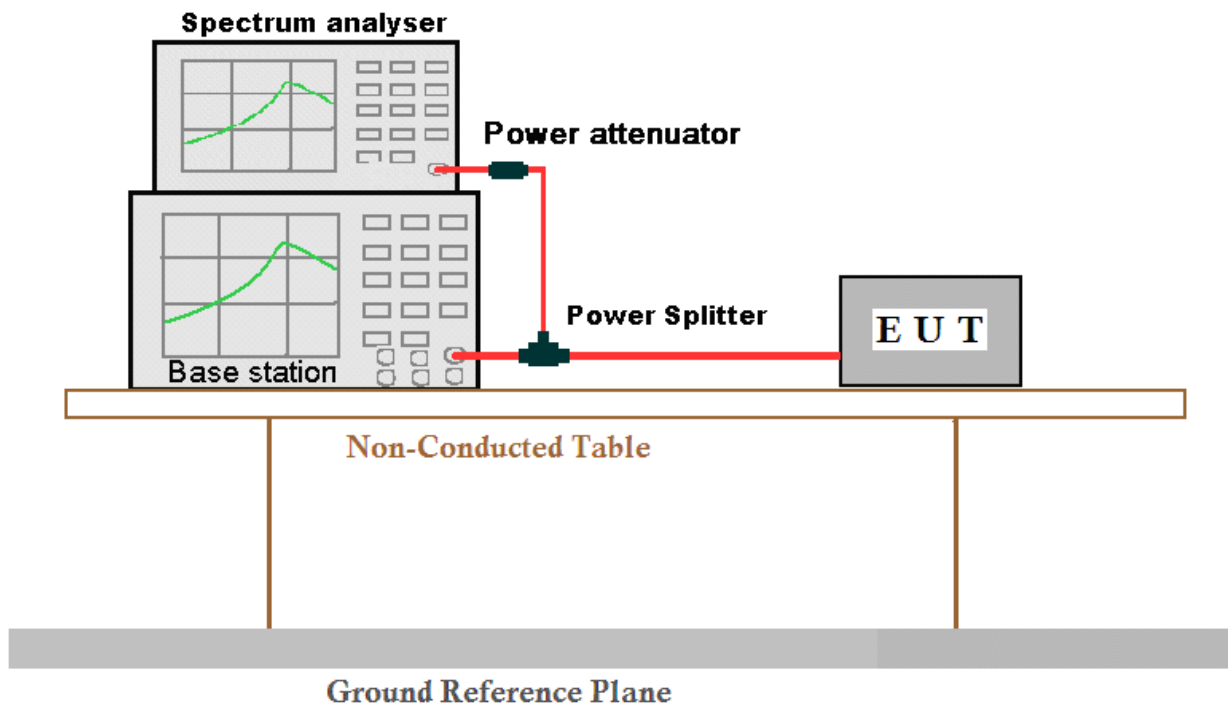

### 4.9.2 Test Setup 2

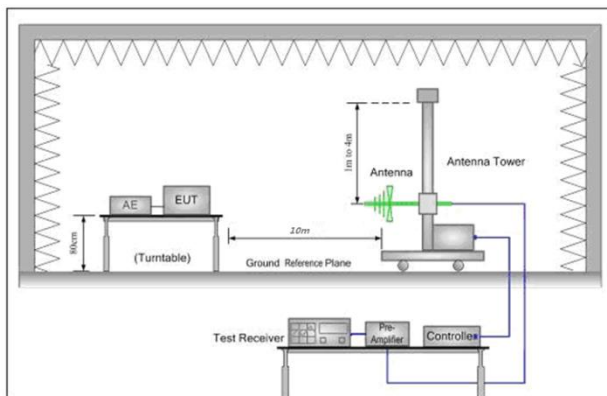

Figure 1. 30MHz to 1GHz

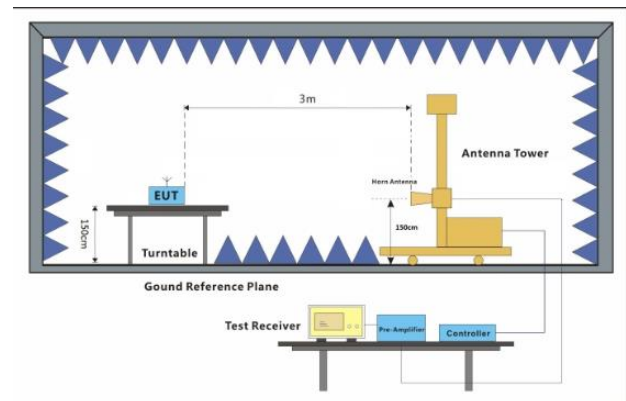

Figure 2. above 1GHz



### 4.9.3 Test Setup 3

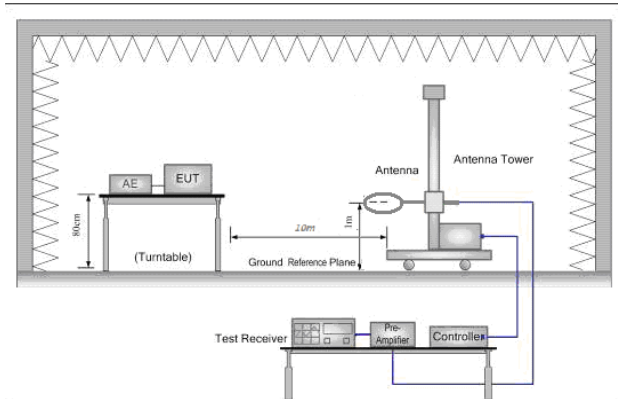

Figure 1. Below 30MHz

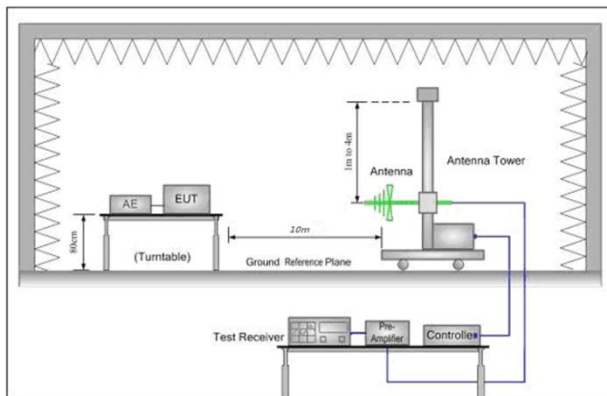

Figure 2. 30MHz to 1GHz

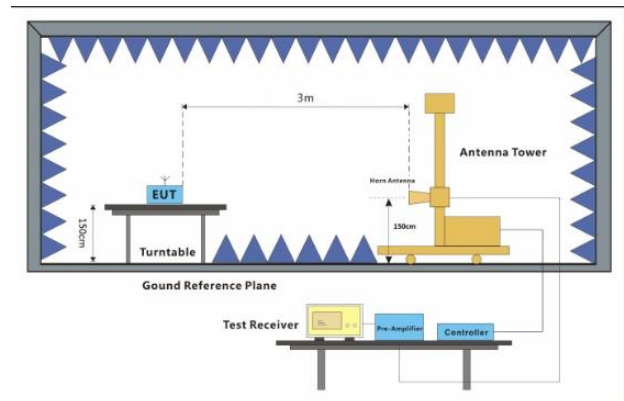
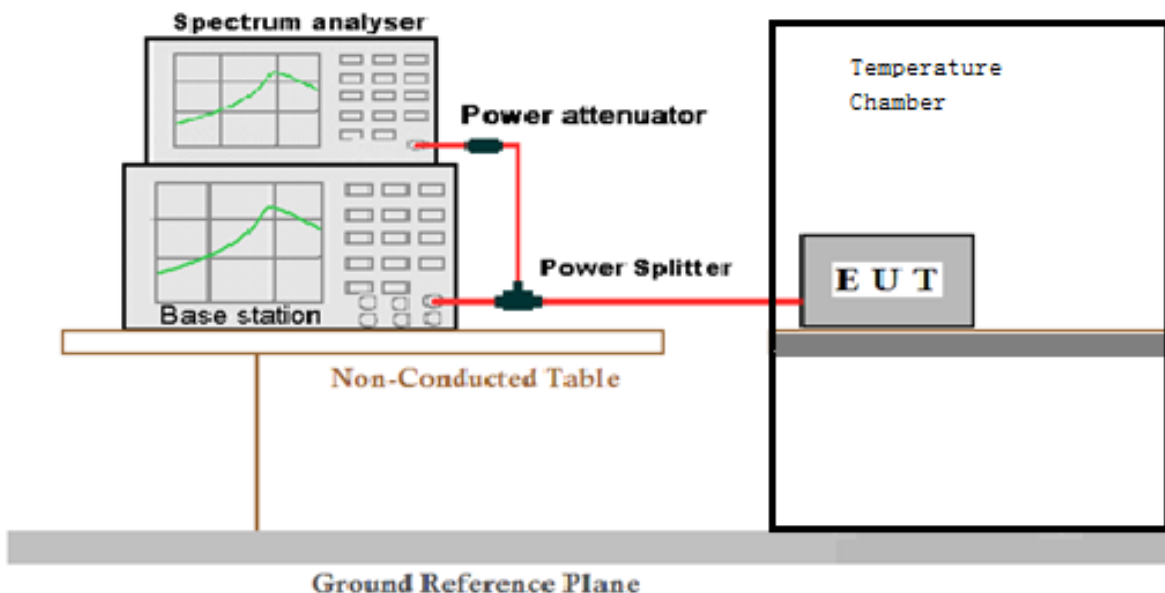

Figure 3. above 1GHz

### 4.9.4 Test Setup 4





### 4.10 Test Conditions

Test Case		Test Conditions	
Transmit Output Power Data	Average Power, Total	Test Environment	Ambient Climate & Rated Voltage
		Test Setup	Test Setup 1
		RF Channels (TX)	L, M, H (L= low channel, M= middle channel, H= high channel )
		Test Mode	GSM/TM1;UMTS/TM1;
	Average Power, Spectral Density (if required)	Test Environment	Ambient Climate & Rated Voltage
		Test Setup	Test Setup 1
		RF Channels (TX)	L, M, H (L= low channel, M= middle channel, H= high channel )
		Test Mode	GSM/TM1;UMTS/TM1;
Peak-to-Average Ratio (if required)	Test Environment	Ambient Climate & Rated Voltage	
	Test Setup	Test Setup 1	
	RF Channels (TX)	L, M, H (L= low channel, M= middle channel, H= high channel )	
	Test Mode	GSM/TM1;UMTS/TM1;	
Modulation Characteristics	Test Environment	Ambient Climate & Rated Voltage	
	Test Setup	Test Setup 1	
	RF Channels (TX)	M (M= middle channel )	
	Test Mode	GSM/TM1;UMTS/TM1;	
Bandwidth	Occupied Bandwidth	Test Environment	Ambient Climate & Rated Voltage
		Test Setup	Test Setup 1
		RF Channels (TX)	L, M, H (L= low channel, M= middle channel, H= high channel )
		Test Mode	GSM/TM1;UMTS/TM1;
	Emission Bandwidth (if required)	Test Environment	Ambient Climate & Rated Voltage
		Test Setup	Test Setup 1
		RF Channels (TX)	L, M, H (L= low channel, M= middle channel, H= high channel )
		Test Mode	GSM/TM1;UMTS/TM1;
Band Edges Compliance	Test Environment	Ambient Climate & Rated Voltage	
	Test Setup	Test Setup 1	
	RF Channels (TX)	L, H (L= low channel, H= high channel )	
	Test Mode	GSM/TM1;UMTS/TM1;	
Spurious Emission at	Test Environment	Ambient Climate & Rated Voltage	



**SGS-CSTC Standards Technical Services Co., Ltd.**  
**Shenzhen Branch**

Report No.: SZEM180700656301

Page: 19 of 22

Antenna Terminals	Test Setup	Test Setup 1
	RF Channels (TX)	L,M, H (L= low channel, M= middle channel, H= high channel )
	Test Mode	GSM/TM1;UMTS/TM1;
Field Strength of Spurious Radiation	Test Environment	Ambient Climate & Rated Voltage
	Test Setup	Test Setup 2
	Test Mode	GSM/TM1;UMTS/TM1; NOTE: If applicable, the EUT conf. that has maximum power density (based on the equivalent power level) is selected.
	RF Channels (TX)	L, M, H (L= low channel, M= middle channel, H= high channel )
Frequency Stability	Test Environment	(1) -30 °C to +50 °C with step 10 °C at Rated Voltage; (2) VL, VN and VH of Rated Voltage at Ambient Climate.
	Test Setup	Test Setup 4
	RF Channels (TX)	L, M, H (L= low channel, M= middle channel, H= high channel )
	Test Mode	GSM/TM1;UMTS/TM1;



## 5 Main Test Instruments

RE in Chamber						
Item	Test Equipment	Manufacturer	Model No.	Inventory No.	Cal. date (yyyy-mm-dd)	Cal.Due date (yyyy-mm-dd)
1	3m Semi-Anechoic Chamber	ETS-LINDGREN	N/A	SEM001-01	2018/03/13	2021/03/12
2	3m Semi-Anechoic Chamber	AUDIX	N/A	SEM001-02	2018/03/13	2021/03/12
3	EMI Test Receiver	Agilent Technologies	N9038A	SEM004-05	2017/10/09	2018/10/09
4	EXA Signal Analyzer (10Hz-26.5GHz)	Agilent Technologies Inc	N9010A	SEM004-09	2018/04/13	2019/04/12
5	BiConiLog Antenna (26-3000MHz)	ETS-LINDGREN	3142C	SEM003-02	201711/15	2020/11/15
6	Double-ridged horn (1-18GHz)	ETS-LINDGREN	3117	SEM003-11	2015/10/17	2018/10/17
7	Horn Antenna (18-26GHz)	ETS-LINDGREN	3160	SEM003-12	2017/11/24	2020/11/24
8	Horn Antenna (15GHz-40GHz)	Schwarzbeck	BBHA 9170	SEM003-15	2017/10/17	2020/10/17
9	Low Noise Amplifier (100MHz-18GHz)	Black Diamond Series	BDLNA-0118-352810	SEM005-05	2017/09/27	2018/09/26
10	Band filter	N/A	N/A	N/A	N/A	N/A
11	Pre-amplifier (0.1-1300MHz)	Agilent Technologies	8447D	SEM005-01	2018/03/13	2019/03/12
12	Pre-Amplifier (0.1-26.5GHz)	Compliance Directions Systems Inc.	PAP-0126	SEM004-10	2017/10/17	2018/10/17
13	Pre-amplifier (26GHz-40GHz)	Compliance Directions Systems Inc.	PAP-2640-50	SEM005-08	2018/03/14	2019/03/14
14	Band filter	Amindeon	82346	SEM023-01	N/A	N/A
15	Universal radio communication tester	Rohde &Schwarz	CMU200	SEM010-01	2017/10/09	2018/10/09
16	Universal radio communication tester	Rohde &Schwarz	CMW500	SEM010-03	2017/10/23	2018/10/23
17	DC Power Supply	Zhao Xin	RXN-305D	SEM011-02	2017/10/09	2018/10/09
18	BiConiLog Antenna	Schwarzbeck	VULB9163	SEM003-05	2015/10/17	2018/10/17



	(30MHz-3GHz)					
19	Horn Antenna (800MHz-18GHz)	Rohde & Schwarz	HF907	SEM003-06	2018/06/06	2021/06/06

RE in Chamber						
Item	Test Equipment	Manufacturer	Model No.	Inventory No.	Cal. Date (yyyy-mm-dd)	Cal. Due date (yyyy-mm-dd)
1	10m Semi-Anechoic Chamber	SAEMC	FSAC1018	SEM001-03	2018/3/10	2019/3/9
2	EMI Test Receiver (9k-7GHz)	Rohde & Schwarz	ESR	SEM004-03	2018/2/14	2019/2/13
3	Trilog-Broadband Antenna(30M-1GHz)	Schwarzbeck	VULB9168	SEM003-18	2016/6/29	2019/6/29
4	Pre-amplifier	Sonoma Instrument Co	310N	SEM005-03	2018/6/6	2019/6/5
5	.Loop Antenna	ETS-Lindgren	6502	SEM003-08	2018/7/14	2021/7/13

RF connected test						
Item	Test Equipment	Manufacturer	Model No.	Inventory No.	Cal. date (yyyy-mm-dd)	Cal.Due date (yyyy-mm-dd)
1	Humi/ Temp Indicator	MingGao	TH101B	W006-09	2018/03/13	2019/03/12
2	Signal Analyzer	Rohde Schwarz	FSV	W025-02	2018/03/13	2019/03/12
3	Spectrum Analyzer (20Hz-43GHz)	Rohde & Schwarz	FSU43	SEM004-08	2018/04/14	2019/04/13
4	Barometer	ChangChun	DYM3	SEL0088	2018/05/24	2019/05/24
5	Dual Output Mobile Communication DC Source	Agilent Technologies Inc	66311B	W009-09	2018/4/28	2019/4/28
6	Digital Multimeter	Fluke	15B+	W055-01	2018/03/13	2019/03/12
7	Wideband Radio Communication Tester	Rohde & Schwarz	CMW500	W005-02	2018/03/13	2019/03/12
8	Wideband Radio Communication Tester	Rohde & Schwarz	CMW500	W005-02	2018/03/13	2019/03/12
9	Temperature Chamber	GIANT FORCE	ICT-150-40-CP-AR	W027-04	2017/12/04	2018/12/04
10	Wideband Radio Communication Teste	Anristu	MT8821C	6201462742	2018/5/2	2019/5/1



## 6 Measurement Uncertainty

For a 95% confidence level ( $k = 2$ ), the measurement expanded uncertainties for defined systems, in accordance with the recommendations of ISO 17025 as following:

Test Item	Extended Uncertainty	Data
Transmit Output Power Data	Power [dBm]	$U = \pm 0.37$ dB
Bandwidth	Magnitude [%]	$U = \pm 0.2\%$
Band Edge Compliance	Disturbance Power [dBm]	$U = \pm 2.0$ dB
Spurious Emissions, Conducted	Disturbance Power [dBm]	$U = \pm 2.0$ dB
Field Strength of Spurious Radiation	ERP[dBm]/EIRP [dBm]	For 3 m Chamber: $U = \pm 4.5$ dB (30 MHz to 1GHz) $U = \pm 3.3$ dB (above 1 GHz) For 10 m Chamber: $U = \pm 4.5$ dB (30 MHz to 1GHz) $U = \pm 3.2$ dB (above 1 GHz)
Frequency Stability	Frequency Accuracy [ppm]	$U = \pm 0.24$ ppm

## 7 Photographs - EUT Constructional Details

Refer to Appendix A - Photographs of EUT Constructional Details for SZEM1807006563RG.

---

The End