



SAR TEST REPORT

No. I17Z62255-SEM01

For

TCL Communication Ltd.

LTE/UMTS/GSM Smartphone

Model Name: 5059A

With

Hardware Version: PIO

Software Version: 6J1B

FCC ID: 2ACCJB101

Issued Date: 2018-3-27



Note:

The test results in this test report relate only to the devices specified in this report. This report shall not be reproduced except in full without the written approval of CTTL.

The report must not be used by the client to claim product certification, approval, or endorsement by NVLAP, NIST, or any agency of the U.S. Government.

Test Laboratory:

CTTL, Telecommunication Technology Labs, CAICT

No. 51, Huayuan North Road, Haidian District, Beijing, P. R. China 100191.

Tel:+86(0)10-62304633-2512, Fax:+86(0)10-62304633-2504

Email: ctl_terminals@caict.ac.cn, website: www.caict.ac.cn



REPORT HISTORY

| Report Number | Revision | Issue Date | Description |
|----------------------|-----------------|-------------------|---------------------------------|
| I17Z62255-SEM01 | Rev.0 | 2018-3-27 | Initial creation of test report |



TABLE OF CONTENT

| | | |
|-----------|--|-----------|
| 1 | TEST LABORATORY | 5 |
| 1.1 | TESTING LOCATION | 5 |
| 1.2 | TESTING ENVIRONMENT | 5 |
| 1.3 | PROJECT DATA | 5 |
| 1.4 | SIGNATURE | 5 |
| 2 | STATEMENT OF COMPLIANCE | 6 |
| 3 | CLIENT INFORMATION | 8 |
| 3.1 | APPLICANT INFORMATION | 8 |
| 3.2 | MANUFACTURER INFORMATION | 8 |
| 4 | EQUIPMENT UNDER TEST (EUT) AND ANCILLARY EQUIPMENT (AE) | 9 |
| 4.1 | ABOUT EUT | 9 |
| 4.2 | INTERNAL IDENTIFICATION OF EUT USED DURING THE TEST | 9 |
| 4.3 | INTERNAL IDENTIFICATION OF AE USED DURING THE TEST | 9 |
| 5 | TEST METHODOLOGY | 10 |
| 5.1 | APPLICABLE LIMIT REGULATIONS | 10 |
| 5.2 | APPLICABLE MEASUREMENT STANDARDS | 10 |
| 6 | SPECIFIC ABSORPTION RATE (SAR) | 11 |
| 6.1 | INTRODUCTION | 11 |
| 6.2 | SAR DEFINITION | 11 |
| 7 | TISSUE SIMULATING LIQUIDS | 12 |
| 7.1 | TARGETS FOR TISSUE SIMULATING LIQUID | 12 |
| 7.2 | DIELECTRIC PERFORMANCE | 12 |
| 8 | SYSTEM VERIFICATION | 19 |
| 8.1 | SYSTEM SETUP | 19 |
| 8.2 | SYSTEM VERIFICATION | 20 |
| 9 | MEASUREMENT PROCEDURES | 21 |
| 9.1 | TESTS TO BE PERFORMED | 21 |
| 9.2 | GENERAL MEASUREMENT PROCEDURE | 23 |
| 9.3 | WCDMA MEASUREMENT PROCEDURES FOR SAR | 24 |
| 9.4 | SAR MEASUREMENT FOR LTE | 25 |
| 9.5 | BLUETOOTH & WI-FI MEASUREMENT PROCEDURES FOR SAR | 25 |
| 9.6 | POWER DRIFT | 26 |
| 10 | AREA SCAN BASED 1-G SAR | 26 |
| 10.1 | REQUIREMENT OF KDB | 26 |
| 10.2 | FAST SAR ALGORITHMS | 26 |
| 11 | CONDUCTED OUTPUT POWER | 27 |



| | | |
|----------------|---|------------|
| 11.1 | GSM MEASUREMENT RESULT | 27 |
| 11.2 | WCDMA MEASUREMENT RESULT..... | 28 |
| 11.3 | LTE MEASUREMENT RESULT | 29 |
| 11.4 | WI-FI AND BT MEASUREMENT RESULT | 40 |
| 12 | SIMULTANEOUS TX SAR CONSIDERATIONS | 43 |
| 12.1 | INTRODUCTION..... | 43 |
| 12.2 | TRANSMIT ANTENNA SEPARATION DISTANCES | 43 |
| 12.3 | SAR MEASUREMENT POSITIONS | 44 |
| 12.4 | STANDALONE SAR TEST EXCLUSION CONSIDERATIONS..... | 44 |
| 13 | EVALUATION OF SIMULTANEOUS | 45 |
| 14 | SAR TEST RESULT | 46 |
| 14.1 | EVALUATION OF MULTI-BATTERIES AND SIM SLOTS | 46 |
| 14.2 | SAR RESULTS | 47 |
| 14.3 | FULL SAR | 64 |
| 15 | SAR MEASUREMENT VARIABILITY | 65 |
| 16 | MEASUREMENT UNCERTAINTY | 66 |
| 16.1 | MEASUREMENT UNCERTAINTY FOR NORMAL SAR TESTS (300MHZ~3GHZ) | 66 |
| 16.2 | MEASUREMENT UNCERTAINTY FOR NORMAL SAR TESTS (3~6GHZ)..... | 67 |
| 16.3 | MEASUREMENT UNCERTAINTY FOR FAST SAR TESTS (300MHZ~3GHZ)..... | 68 |
| 16.4 | MEASUREMENT UNCERTAINTY FOR FAST SAR TESTS (3~6GHZ)..... | 69 |
| 17 | MAIN TEST INSTRUMENTS..... | 71 |
| ANNEX A | GRAPH RESULTS..... | 72 |
| ANNEX B | SYSTEM VERIFICATION RESULTS..... | 102 |
| ANNEX C | SAR MEASUREMENT SETUP | 115 |
| ANNEX D | POSITION OF THE WIRELESS DEVICE IN RELATION TO THE PHANTOM | 121 |
| ANNEX E | EQUIVALENT MEDIA RECIPES | 124 |
| ANNEX F | SYSTEM VALIDATION | 125 |
| ANNEX G | PROBE CALIBRATION CERTIFICATE | 126 |
| ANNEX H | DIPOLE CALIBRATION CERTIFICATE..... | 137 |
| ANNEX I | ACCREDITATION CERTIFICATE..... | 199 |

1 Test Laboratory

1.1 Testing Location

| | |
|---------------|---|
| Company Name: | CTTL(Shouxiang) |
| Address: | No. 51 Shouxiang Science Building, Xueyuan Road, Haidian District, Beijing, P. R. China100191 |

1.2 Testing Environment

| | |
|-----------------------------|----------------|
| Temperature: | 18°C~25 °C, |
| Relative humidity: | 30%~ 70% |
| Ground system resistance: | < 0.5 Ω |
| Ambient noise & Reflection: | < 0.012 W/kg |

1.3 Project Data

| | |
|---------------------|---------------|
| Project Leader: | Qi Dianyuan |
| Test Engineer: | Lin Xiaojun |
| Testing Start Date: | March 1, 2018 |
| Testing End Date: | March 6, 2018 |

1.4 Signature



Lin Xiaojun

(Prepared this test report)

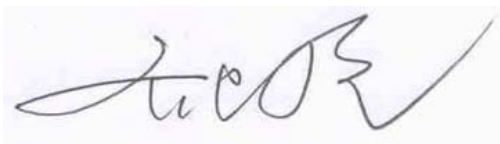

Qi Dianyuan

(Reviewed this test report)



Lu Bingsong

Deputy Director of the laboratory
(Approved this test report)

2 Statement of Compliance

The maximum results of SAR found during testing for TCL Communication Ltd. LTE/UMTS/GSM Smartphone 5059A is as follows:

Table 2.1: Highest Reported SAR (1g)

| Exposure Configuration | Technology Band | Highest Reported SAR 1g (W/Kg) | Equipment Class |
|---------------------------------------|-----------------|--------------------------------|-----------------|
| Head (Separation Distance 0mm) | GSM 850 | 0.23 | PCE |
| | PCS 1900 | 0.19 | |
| | UMTS FDD 5 | 0.19 | |
| | UMTS FDD 4 | 0.14 | |
| | UMTS FDD 2 | 0.22 | |
| | LTE Band 2 | 0.11 | |
| | LTE Band 4 | 0.16 | |
| | LTE Band 5 | 0.17 | |
| | LTE Band 7 | 0.11 | |
| | LTE Band 12 | 0.18 | |
| | LTE Band 13 | 0.09 | |
| | WLAN 2.4 GHz | <0.01 | DTS |
| Hotspot (Separation Distance 10mm) | GSM 850 | 0.38 | PCE |
| | PCS 1900 | 1.19 | |
| | UMTS FDD 5 | 1.27 | |
| | UMTS FDD 4 | 0.50 | |
| | UMTS FDD 2 | 0.42 | |
| | LTE Band 2 | 1.06 | |
| | LTE Band 4 | 0.52 | |
| | LTE Band 5 | 0.36 | |
| | LTE Band 7 | 0.69 | |
| | LTE Band 12 | 0.31 | |
| | LTE Band 13 | 0.23 | |
| | WLAN 2.4 GHz | / | DTS |

The SAR values found for the Mobile Phone are below the maximum recommended levels of 1.6 W/Kg as averaged over any 1g tissue according to the ANSI C95.1-1992.

For body worn operation, this device has been tested and meets FCC RF exposure guidelines when used with any accessory that contains no metal and which provides a minimum separation distance of 10 mm between this device and the body of the user. Use of other accessories may not ensure compliance with FCC RF exposure guidelines.

The EUT battery must be fully charged and checked periodically during the test to ascertain uniform power output.

The measurement together with the test system set-up is described in annex C of this test report. A detailed description of the equipment under test can be found in chapter 4 of this test report.

The highest reported SAR value is obtained at the case of (**Table 2.1**), and the values are: **1.27 W/kg (1g)**.

Table 2.2: The sum of reported SAR values for main antenna and WiFi

| | Position | Main antenna | WiFi | Sum |
|--|------------------------|--------------|-------|-------------|
| Highest reported SAR value for Head | Left hand, Touch cheek | 0.23 | <0.01 | 0.23 |
| Highest reported SAR value for Body | Bottom | 1.27 | / | 1.27 |

Table 2.3: The sum of reported SAR values for main antenna and BT

| | Position | Main antenna | BT | Sum |
|--|------------------------|--------------|------|-------------|
| Maximum reported SAR value for Head | Left hand, Touch cheek | 0.23 | 0.21 | 0.44 |
| Maximum reported SAR value for Body | Bottom | 1.27 | 0.10 | 1.37 |

[1] - Estimated SAR for Bluetooth (see the table 13.3)

According to the above tables, the highest sum of reported SAR values is **1.37 W/kg (1g)**. The detail for simultaneous transmission consideration is described in chapter 13.



3 Client Information

3.1 Applicant Information

| | |
|-----------------|--|
| Company Name | TCL Communication Ltd. |
| Company Address | 7/F, Block F4, TCL Communication Technology Building, TCL International E City, Zhong Shan Yuan Road, Nanshan District, Shenzhen, Guangdong, P.R. China 518052 |
| Post Code | 518052 |
| Contact Person | Zhizhou Gong |
| Tel | 0086-755-36611722 |
| Mobile | 0086-18217635320 |
| Fax | 0086-755-36612000 ext: 81722 |
| E-Mail | zhizhou.gong@tcl.com |
| Company URL | www.alcatel-mobile.com |

3.2 Manufacturer Information

| | |
|-----------------|--|
| Company Name | TCL Communication Ltd. |
| Company Address | 7/F, Block F4, TCL Communication Technology Building, TCL International E City, Zhong Shan Yuan Road, Nanshan District, Shenzhen, Guangdong, P.R. China 518052 |
| Post Code | 518052 |
| Contact Person | Zhizhou Gong |
| Tel | 0086-755-36611722 |
| Mobile | 0086-18217635320 |
| Fax | 0086-755-36612000 ext: 81722 |
| E-Mail | zhizhou.gong@tcl.com |
| Company URL | www.alcatel-mobile.com |

4 Equipment Under Test (EUT) and Ancillary Equipment (AE)

4.1 About EUT

| | |
|---------------------------------------|---|
| Description: | LTE/UMTS/GSM Smartphone |
| Model name: | 5059A |
| Operating mode(s): | GSM 850/900/1800/1900 WCDMA850/900/1700/1900/2100 LTE B1/2/3/4/5/7/8/12/13/17/28, BT, WLAN |
| Tested Tx Frequency: | 825 – 848.8 MHz (GSM 850) |
| | 1850.2 – 1910 MHz (GSM 1900) |
| | 826.4–846.6 MHz (WCDMA 850 Band V) |
| | 1712.4 – 1752.6 MHz (WCDMA 1700 Band IV) |
| | 1852.4–1907.6 MHz (WCDMA1900 Band II) |
| | 1860 – 1900 MHz (LTE Band 2) |
| | 1720 – 1745 MHz (LTE Band 4) |
| | 824.7 – 848.3 MHz (LTE Band 5) |
| | 2502.5 – 2567.5 MHz (LTE Band 7) |
| | 699.7 – 715.3 MHz (LTE Band 12) |
| 779.5 –784.5 MHz (LTE Band 13) | |
| 2412 – 2462 MHz (Wi-Fi 2.4G) | |
| GPRS/EGPRS Multislot Class: | 12 |
| GPRS capability Class: | B |
| Test device Production information: | Production unit |
| Device type: | Portable device |
| Antenna type: | Integrated antenna |
| Accessories/Body-worn configurations: | Headset |
| Hotspot mode: | Support |
| Product dimension | Long 147.5mm ;Wide 70.6mm ; Overall Diagonal 158.4mm |

4.2 Internal Identification of EUT used during the test

| EUT | | | |
|-------|-----------------|------------|------------|
| EUTID | IMEI | HW Version | SW Version |
| 1 | 354454090002834 | PIO | 6J1B |
| 2 | 354454090003840 | PIO | 6J1B |
| 3 | 354454090003212 | PIO | 6J1B |

*EUT ID: is used to identify the test sample in the lab internally.

Note: It is performed to test SAR with the EUT1&2 and conducted power with the EUT3.

4.3 Internal Identification of AE used during the test

| AE ID | Description | Model | SN | Manufacturer |
|-------|-------------|-----------------|--------------|--------------|
| AE1 | Battery | Li-Polymer | CAC2400008C1 | BYD |
| AE2 | Battery | Li-Polymer | CAC2400009C7 | VEKEN |
| AE3 | Headset | Stereo Earphone | CCB0046A10C1 | JUWEI |
| AE4 | Headset | Stereo Earphone | CCB0046A10C4 | MEIHAO |

*AE ID: is used to identify the test sample in the lab internally.



5 TEST METHODOLOGY

5.1 Applicable Limit Regulations

ANSI C95.1–1992: IEEE Standard for Safety Levels with Respect to Human Exposure to Radio Frequency Electromagnetic Fields, 3 kHz to 300 GHz.

It specifies the maximum exposure limit of **1.6 W/kg** as averaged over any 1 gram of tissue for portable devices being used within 20 cm of the user in the uncontrolled environment.

5.2 Applicable Measurement Standards

IEEE 1528–2013: Recommended Practice for Determining the Peak Spatial-Average Specific Absorption Rate (SAR) in the Human Head from Wireless Communications Devices: Measurement Techniques.

KDB447498 D01 General RF Exposure Guidance v06: Mobile and Portable Devices RF Exposure Procedures and Equipment Authorization Policies.

KDB648474 D04 Handset SAR v01r03: SAR Evaluation Considerations for Wireless Handsets.

KDB941225 D01 SAR test for 3G devices v03r01: SAR Measurement Procedures for 3G Devices

KDB941225 D05 SAR for LTE Devices v02r05: SAR Evaluation Considerations for LTE Devices

KDB248227 D01 802.11 Wi-Fi SAR v02r02: SAR GUIDANCE FOR IEEE 802.11 (Wi-Fi) TRANSMITTERS

KDB865664 D01 SAR measurement 100 MHz to 6 GHz v01r04: SAR Measurement Requirements for 100 MHz to 6 GHz.

KDB865664 D02 RF Exposure Reporting v01r02: RF Exposure Compliance Reporting and Documentation Considerations

6 Specific Absorption Rate (SAR)

6.1 Introduction

SAR is related to the rate at which energy is absorbed per unit mass in an object exposed to a radio field. The SAR distribution in a biological body is complicated and is usually carried out by experimental techniques or numerical modeling. The standard recommends limits for two tiers of groups, occupational/controlled and general population/uncontrolled, based on a person's awareness and ability to exercise control over his or her exposure. In general, occupational/controlled exposure limits are higher than the limits for general population/uncontrolled.

6.2 SAR Definition

The SAR definition is the time derivative (rate) of the incremental energy (dW) absorbed by (dissipated in) an incremental mass (dm) contained in a volume element (dv) of a given density (ρ). The equation description is as below:

$$SAR = \frac{d}{dt} \left(\frac{dW}{dm} \right) = \frac{d}{dt} \left(\frac{dW}{\rho dv} \right)$$

SAR is expressed in units of Watts per kilogram (W/kg)

SAR measurement can be either related to the temperature elevation in tissue by

$$SAR = c \left(\frac{\delta T}{\delta t} \right)$$

Where: C is the specific heat capacity, δT is the temperature rise and δt is the exposure duration, or related to the electrical field in the tissue by

$$SAR = \frac{\sigma |E|^2}{\rho}$$

Where: σ is the conductivity of the tissue, ρ is the mass density of tissue and E is the RMS electrical field strength.

However for evaluating SAR of low power transmitter, electrical field measurement is typically applied.

7 Tissue Simulating Liquids

7.1 Targets for tissue simulating liquid

Table 7.1: Targets for tissue simulating liquid

| Frequency(MHz) | Liquid Type | Conductivity(σ) | $\pm 5\%$ Range | Permittivity(ϵ) | $\pm 5\%$ Range |
|----------------|-------------|--------------------------|-----------------|----------------------------|-----------------|
| 835 | Head | 0.90 | 0.86~0.95 | 41.5 | 39.4~43.6 |
| 835 | Body | 0.97 | 0.92~1.02 | 55.2 | 52.4~58.0 |
| 1900 | Head | 1.40 | 1.33~1.47 | 40.0 | 38.0~42.0 |
| 1900 | Body | 1.52 | 1.44~1.60 | 53.3 | 50.6~56.0 |
| 2450 | Head | 1.80 | 1.71~1.89 | 39.2 | 37.2~41.2 |
| 2450 | Body | 1.95 | 1.85~2.05 | 52.7 | 50.1~55.3 |
| 2600 | Head | 1.96 | 1.86~2.06 | 39.01 | 37.06~40.96 |
| 2600 | Body | 2.16 | 2.05~2.27 | 52.5 | 49.9~55.1 |
| 5250 | Head | 4.71 | 4.47~4.95 | 35.93 | 34.1~37.7 |
| 5250 | Body | 5.36 | 5.09~5.63 | 48.9 | 46.5~51.3 |
| 5600 | Head | 5.07 | 4.82~5.32 | 35.53 | 33.8~37.3 |
| 5600 | Body | 5.77 | 5.48~6.06 | 48.5 | 46.1~50.9 |
| 5750 | Head | 5.22 | 4.96~5.48 | 35.36 | 33.6~37.1 |
| 5750 | Body | 5.94 | 5.64~6.24 | 48.3 | 45.9~50.7 |

7.2 Dielectric Performance

Table 7.2: Dielectric Performance of Tissue Simulating Liquid

| Measurement Date yyyy/mm/dd | Frequency | Type | Permittivity ϵ | Drift (%) | Conductivity σ (S/m) | Drift (%) |
|--------------------------------|-----------|------|-------------------------|-----------|--------------------------------|-----------|
| 2018/3/1 | 750 MHz | Head | 41.35 | -1.41 | 0.888 | -0.22 |
| | | Body | 55.95 | 0.81 | 0.955 | -0.52 |
| 2018/3/2 | 835 MHz | Head | 41.1 | -0.96 | 0.892 | -0.89 |
| | | Body | 54.29 | -1.65 | 0.977 | 0.72 |
| 2018/3/3 | 1750 MHz | Head | 40.82 | 1.85 | 1.377 | 0.51 |
| | | Body | 52.58 | -1.54 | 1.485 | -0.34 |
| 2018/3/4 | 1900 MHz | Head | 39.99 | -0.02 | 1.428 | 2.00 |
| | | Body | 53.11 | -0.36 | 1.51 | -0.66 |
| 2018/3/5 | 2450 MHz | Head | 38.99 | -0.54 | 1.78 | -1.11 |
| | | Body | 53.49 | 1.50 | 1.957 | 0.36 |
| 2018/3/6 | 2600 MHz | Head | 39.06 | 0.13 | 1.925 | -1.79 |
| | | Body | 52.63 | 0.25 | 2.179 | 0.88 |

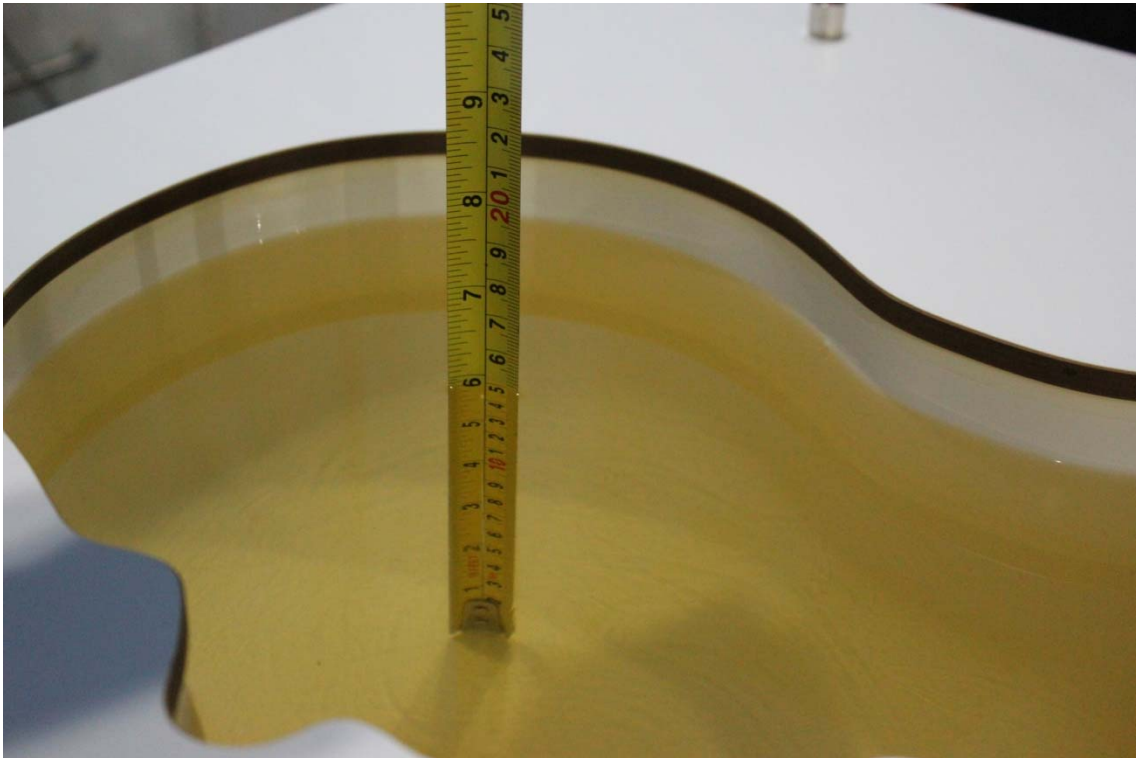

Picture 7-1 Liquid depth in the Head Phantom (750 MHz)



Picture 7-2 Liquid depth in the Flat Phantom (750 MHz)

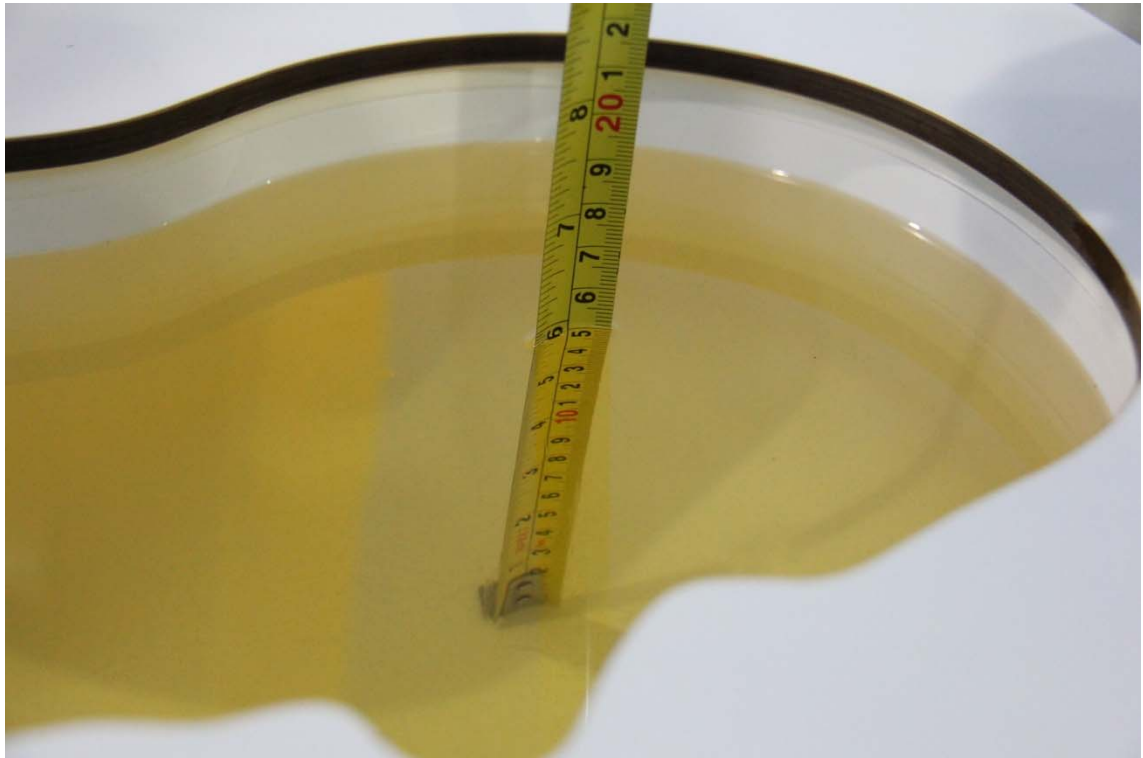

Picture 7-3 Liquid depth in the Head Phantom (835MHz)



Picture 7-4 Liquid depth in the Flat Phantom (835MHz)



Picture 7-5 Liquid depth in the Head Phantom (1750 MHz)

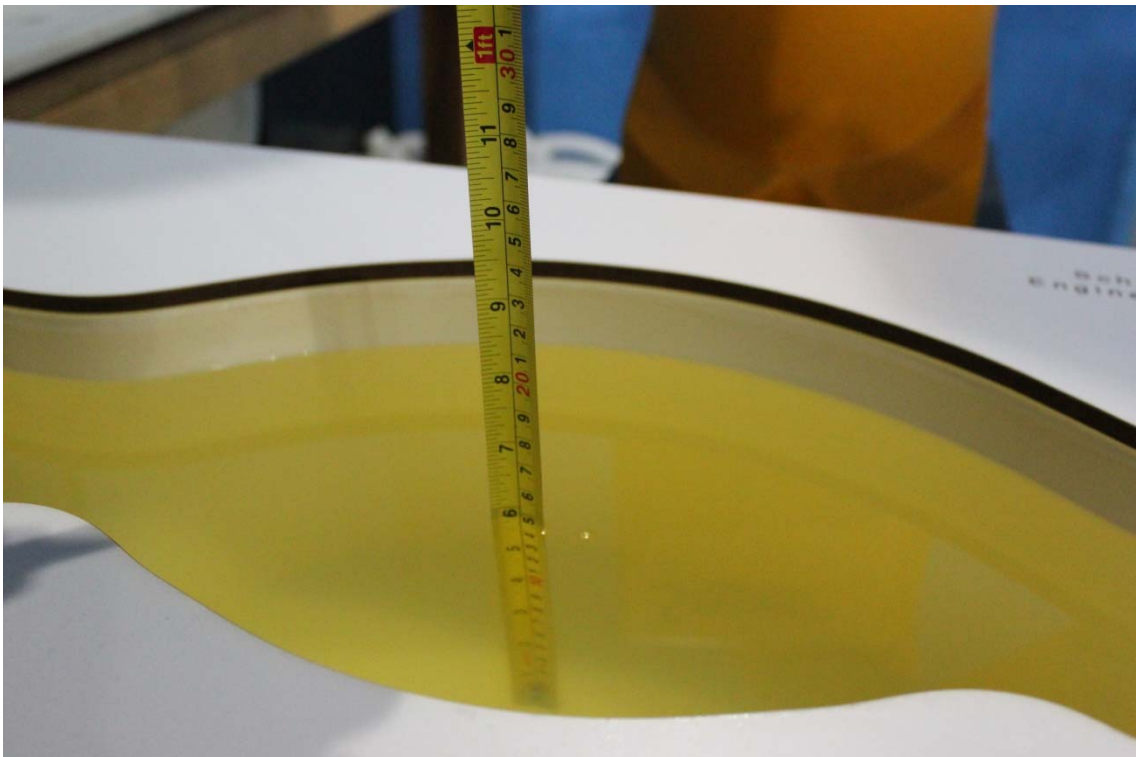

Picture 7-6 Liquid depth in the Flat Phantom (1750MHz)



Picture 7-7 Liquid depth in the Head Phantom (1900 MHz)



Picture 7-8 Liquid depth in the Flat Phantom (1900MHz)



Picture 7-9 Liquid depth in the Head Phantom (2450MHz)

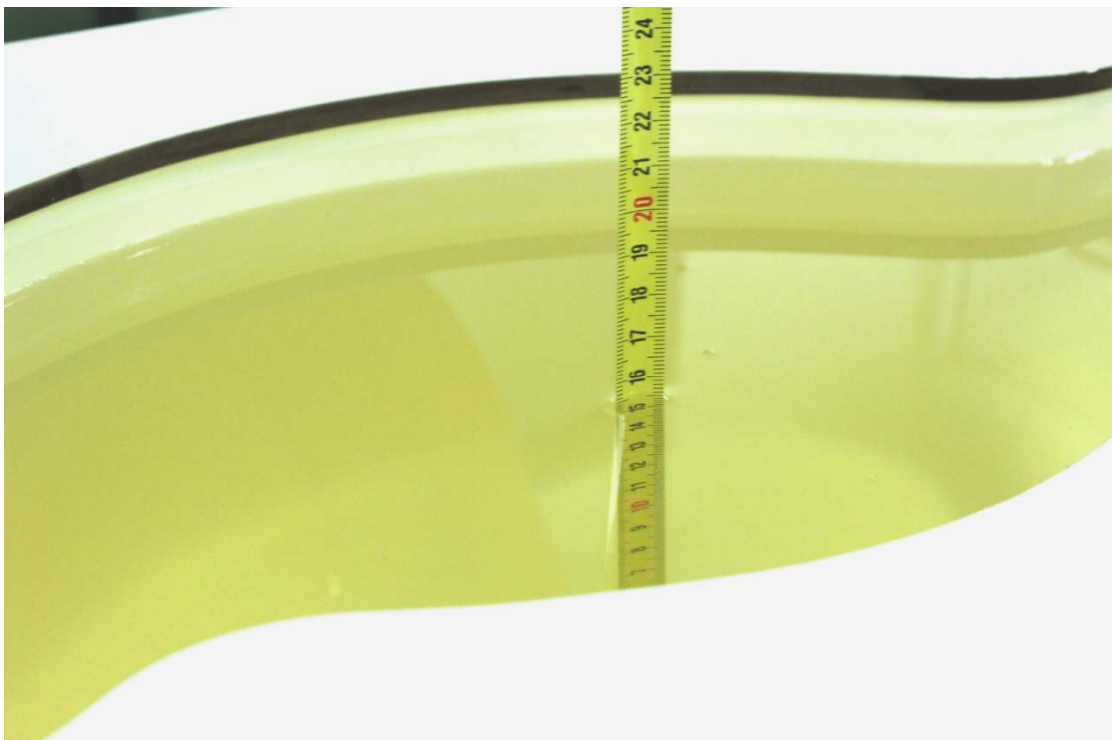

Picture 7-10 Liquid depth in the Flat Phantom (2450MHz)

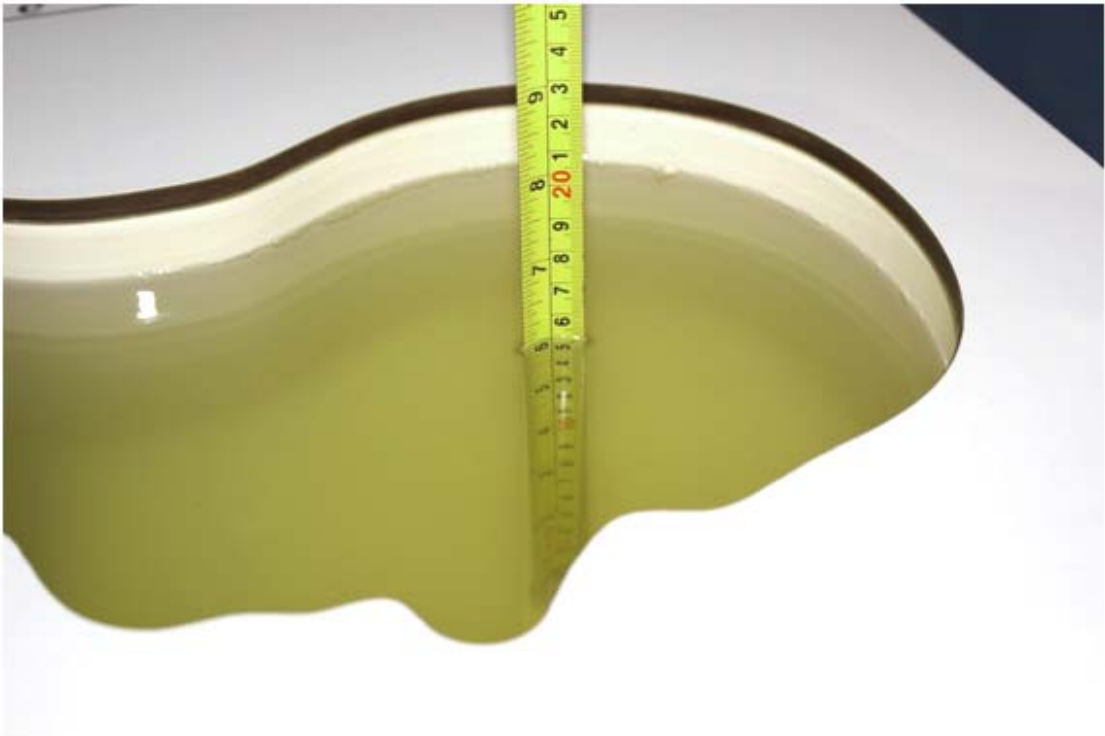

Picture 7-11 Liquid depth in the Head Phantom (2600 MHz Head)

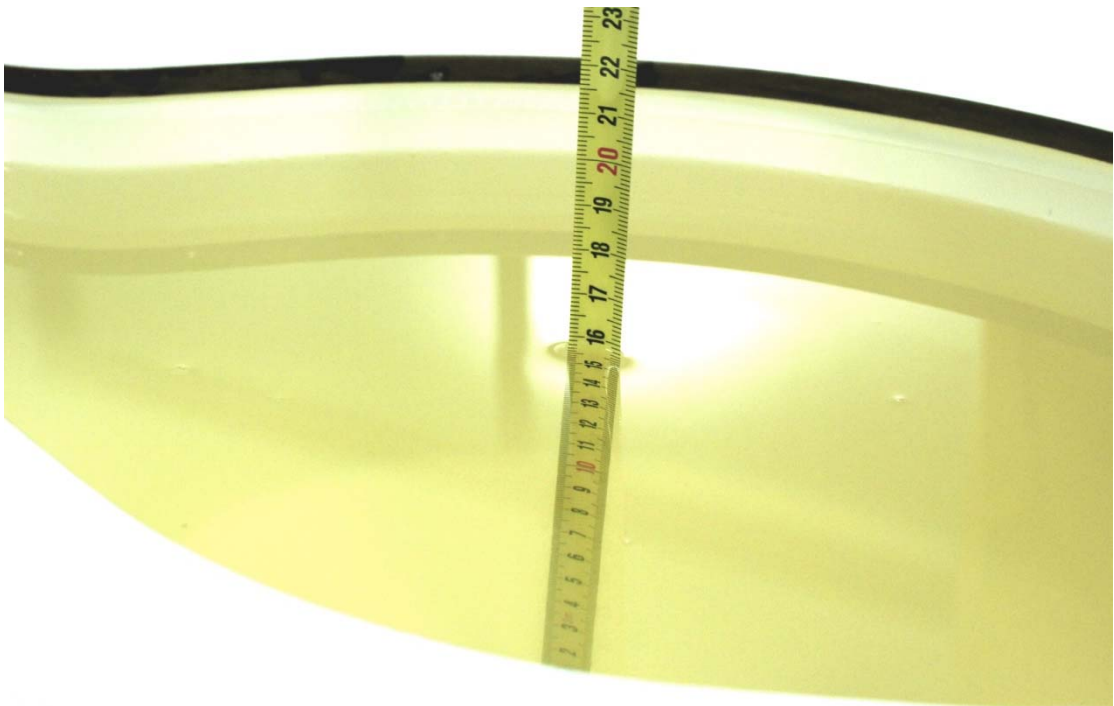

Picture 7-12 Liquid depth in the Flat Phantom (2600MHz)

8 System verification

8.1 System Setup

In the simplified setup for system evaluation, the DUT is replaced by a calibrated dipole and the power source is replaced by a continuous wave that comes from a signal generator. The calibrated dipole must be placed beneath the flat phantom section of the SAM twin phantom with the correct distance holder. The distance holder should touch the phantom surface with a light pressure at the reference marking and be oriented parallel to the long side of the phantom. The equipment setup is shown below:

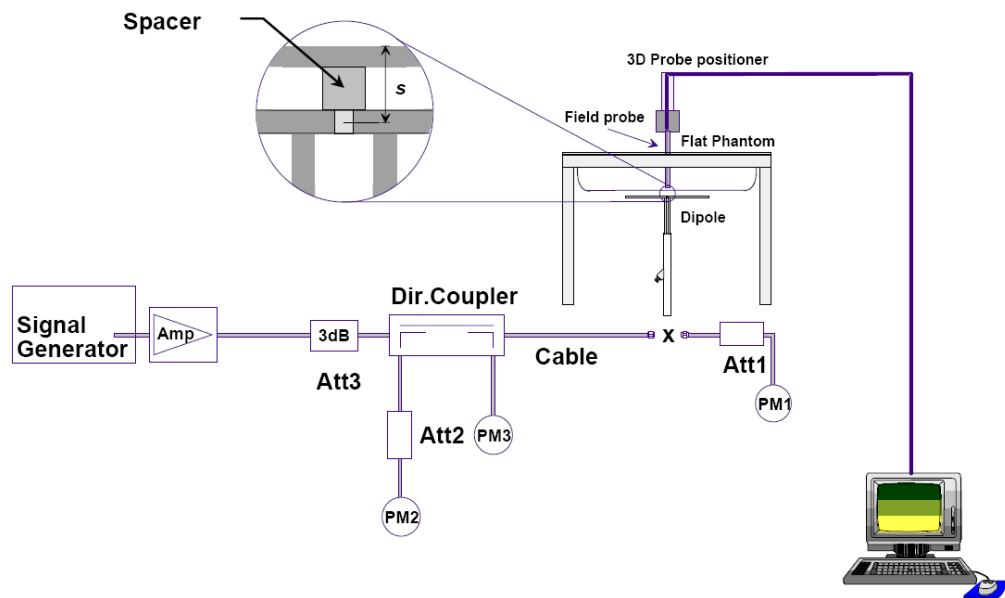

Picture 8.1 System Setup for System Evaluation



Picture 8.2 Photo of Dipole Setup

8.2 System Verification

SAR system verification is required to confirm measurement accuracy, according to the tissue dielectric media, probe calibration points and other system operating parameters required for measuring the SAR of a test device. The system verification must be performed for each frequency band and within the valid range of each probe calibration point required for testing the device.

The system verification results are required that the area scan estimated 1-g SAR is within 3% of the zoom scan 1-g SAR. The details are presented in annex B.

Table 8.1: System Verification of Head

| Measurement Date (yyyy-mm-dd) | Frequency | Target value (W/kg) | | Measured value (W/kg) | | Deviation | |
|----------------------------------|-----------|---------------------|-------------|-----------------------|-------------|--------------|-------------|
| | | 10 g Average | 1 g Average | 10 g Average | 1 g Average | 10 g Average | 1 g Average |
| 2018/3/1 | 750 MHz | 5.42 | 8.32 | 5.52 | 8.36 | 1.85% | 0.48% |
| 2018/3/2 | 835 MHz | 6.06 | 9.37 | 6.08 | 9.24 | 0.33% | -1.39% |
| 2018/3/3 | 1750 MHz | 19.4 | 36.7 | 19.44 | 36.76 | 0.21% | 0.16% |
| 2018/3/4 | 1900 MHz | 21.0 | 40.0 | 21.32 | 40 | 1.52% | 0.00% |
| 2018/3/5 | 2450 MHz | 24.7 | 52.2 | 25 | 51.28 | 1.21% | -1.76% |
| 2018/3/6 | 2600 MHz | 25.8 | 57.9 | 25.68 | 56.76 | -0.47% | -1.97% |

Table 8.2: System Verification of Body

| Measurement Date (yyyy-mm-dd) | Frequency | Target value (W/kg) | | Measured value (W/kg) | | Deviation | |
|----------------------------------|-----------|---------------------|-------------|-----------------------|-------------|--------------|-------------|
| | | 10 g Average | 1 g Average | 10 g Average | 1 g Average | 10 g Average | 1 g Average |
| 2018/3/1 | 750 MHz | 5.68 | 8.66 | 5.6 | 8.56 | -1.41% | -1.15% |
| 2018/3/2 | 835 MHz | 6.12 | 9.41 | 6.2 | 9.56 | 1.31% | 1.59% |
| 2018/3/3 | 1750 MHz | 19.8 | 37.1 | 19.72 | 37.72 | -0.40% | 1.67% |
| 2018/3/4 | 1900 MHz | 21.5 | 40.5 | 21.4 | 40.8 | -0.47% | 0.74% |
| 2018/3/5 | 2450 MHz | 23.8 | 50.4 | 23.68 | 49.52 | -0.50% | -1.75% |
| 2018/3/6 | 2600 MHz | 24.8 | 55.5 | 24.56 | 55.36 | -0.97% | -0.25% |

9 Measurement Procedures

9.1 Tests to be performed

In order to determine the highest value of the peak spatial-average SAR of a handset, all device positions, configurations and operational modes shall be tested for each frequency band according to steps 1 to 3 below. A flowchart of the test process is shown in picture 9.1.

Step 1: The tests described in 9.2 shall be performed at the channel that is closest to the center of the transmit frequency band (f_c) for:

- a) all device positions (cheek and tilt, for both left and right sides of the SAM phantom, as described in annex D),
- b) all configurations for each device position in a), e.g., antenna extended and retracted, and
- c) all operational modes, e.g., analogue and digital, for each device position in a) and configuration in b) in each frequency band.

If more than three frequencies need to be tested according to 11.1 (i.e., $N_c > 3$), then all frequencies, configurations and modes shall be tested for all of the above test conditions.

Step 2: For the condition providing highest peak spatial-average SAR determined in Step 1, perform all tests described in 9.2 at all other test frequencies, i.e., lowest and highest frequencies. In addition, for all other conditions (device position, configuration and operational mode) where the peak spatial-average SAR value determined in Step 1 is within 3 dB of the applicable SAR limit, it is recommended that all other test frequencies shall be tested as well.

Step 3: Examine all data to determine the highest value of the peak spatial-average SAR found in Steps 1 to 2.

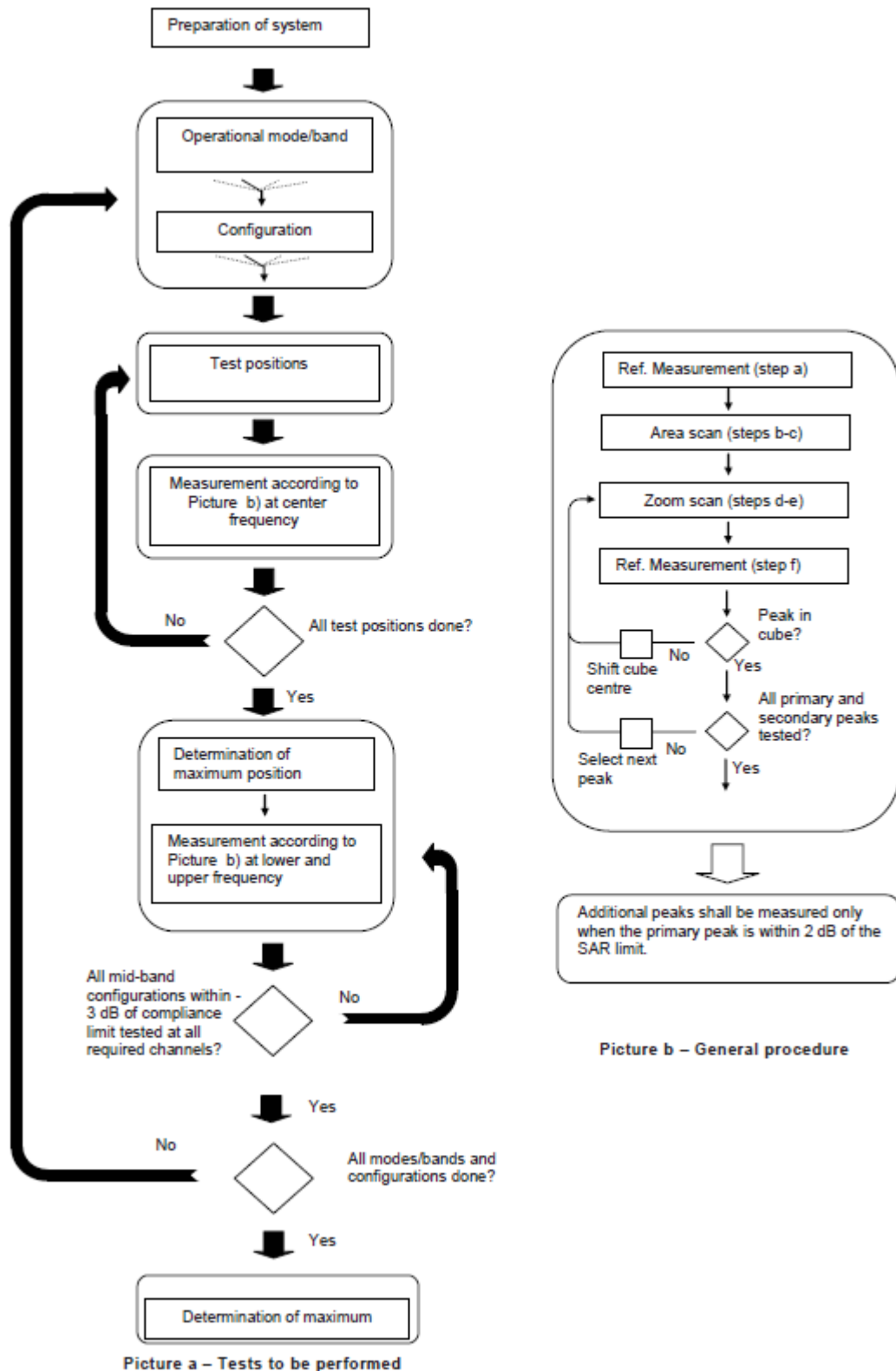

Picture 9.1 Block diagram of the tests to be performed

9.2 General Measurement Procedure

The area and zoom scan resolutions specified in the table below must be applied to the SAR measurements and fully documented in SAR reports to qualify for TCB approval. Probe boundary effect error compensation is required for measurements with the probe tip closer than half a probe tip diameter to the phantom surface. Both the probe tip diameter and sensor offset distance must satisfy measurement protocols; to ensure probe boundary effect errors are minimized and the higher fields closest to the phantom surface can be correctly measured and extrapolated to the phantom surface for computing 1-g SAR. Tolerances of the post-processing algorithms must be verified by the test laboratory for the scan resolutions used in the SAR measurements, according to the reference distribution functions specified in IEEE Std 1528-2013. The results should be documented as part of the system validation records and may be requested to support test results when all the measurement parameters in the following table are not satisfied.

| | | ≤ 3 GHz | > 3 GHz |
|---|---|--|---|
| Maximum distance from closest measurement point (geometric center of probe sensors) to phantom surface | | 5 ± 1 mm | $\frac{1}{2} \cdot \delta \cdot \ln(2) \pm 0.5$ mm |
| Maximum probe angle from probe axis to phantom surface normal at the measurement location | | $30^\circ \pm 1^\circ$ | $20^\circ \pm 1^\circ$ |
| Maximum area scan spatial resolution: Δx_{Area} , Δy_{Area} | | ≤ 2 GHz: ≤ 15 mm 2 – 3 GHz: ≤ 12 mm | 3 – 4 GHz: ≤ 12 mm 4 – 6 GHz: ≤ 10 mm |
| | | When the x or y dimension of the test device, in the measurement plane orientation, is smaller than the above, the measurement resolution must be \leq the corresponding x or y dimension of the test device with at least one measurement point on the test device. | |
| Maximum zoom scan spatial resolution: Δx_{Zoom} , Δy_{Zoom} | | ≤ 2 GHz: ≤ 8 mm 2 – 3 GHz: ≤ 5 mm* | 3 – 4 GHz: ≤ 5 mm* 4 – 6 GHz: ≤ 4 mm* |
| Maximum zoom scan spatial resolution, normal to phantom surface | uniform grid: $\Delta z_{Zoom}(n)$ | ≤ 5 mm | 3 – 4 GHz: ≤ 4 mm 4 – 5 GHz: ≤ 3 mm 5 – 6 GHz: ≤ 2 mm |
| | graded grid $\Delta z_{Zoom}(1)$: between 1 st two points closest to phantom surface | ≤ 4 mm | 3 – 4 GHz: ≤ 3 mm 4 – 5 GHz: ≤ 2.5 mm 5 – 6 GHz: ≤ 2 mm |
| | $\Delta z_{Zoom}(n>1)$: between subsequent points | $\leq 1.5 \cdot \Delta z_{Zoom}(n-1)$ | |
| Minimum zoom scan volume | x, y, z | ≥ 30 mm | 3 – 4 GHz: ≥ 28 mm 4 – 5 GHz: ≥ 25 mm 5 – 6 GHz: ≥ 22 mm |
| Note: δ is the penetration depth of a plane-wave at normal incidence to the tissue medium; see draft standard IEEE P1528-2011 for details. * When zoom scan is required and the <i>reported</i> SAR from the area scan based 1-g SAR estimation procedures of KDB 447498 is ≤ 1.4 W/kg, ≤ 8 mm, ≤ 7 mm and ≤ 5 mm zoom scan resolution may be applied, respectively, for 2 GHz to 3 GHz, 3 GHz to 4 GHz and 4 GHz to 6 GHz. | | | |

9.3 WCDMA Measurement Procedures for SAR

The following procedures are applicable to WCDMA handsets operating under 3GPP Release99, Release 5 and Release 6. The default test configuration is to measure SAR with an established radio link between the DUT and a communication test set using a 12.2kbps RMC (reference measurement channel) configured in Test Loop Mode 1. SAR is selectively confirmed for other physical channel configurations (DPCCH & DPDCH_n), HSDPA and HSPA (HSUPA/HSDPA) modes according to output power, exposure conditions and device operating capabilities. Both uplink and downlink should be configured with the same RMC or AMR, when required. SAR for Release 5 HSDPA and Release 6 HSPA are measured using the applicable FRC (fixed reference channel) and E-DCH reference channel configurations. Maximum output power is verified according to applicable versions of 3GPP TS 34.121 and SAR must be measured according to these maximum output conditions. When Maximum Power Reduction (MPR) is not implemented according to Cubic Metric (CM) requirements for Release 6 HSPA, the following procedures do not apply.

For Release 5 HSDPA Data Devices:

| Sub-test | β_c | β_d | β_d (SF) | β_c / β_d | β_{hs} | CM/dB |
|----------|-----------|-----------|----------------|---------------------|--------------|-------|
| 1 | 2/15 | 15/15 | 64 | 2/15 | 4/15 | 0.0 |
| 2 | 12/15 | 15/15 | 64 | 12/15 | 24/25 | 1.0 |
| 3 | 15/15 | 8/15 | 64 | 15/8 | 30/15 | 1.5 |
| 4 | 15/15 | 4/15 | 64 | 15/4 | 30/15 | 1.5 |

For Release 6 HSPA Data Devices

| Sub-test | β_c | β_d | β_d (SF) | β_c / β_d | β_{hs} | β_{ec} | β_{ed} | β_{ed} (SF) | β_{ed} (codes) | CM (dB) | MPR (dB) | AG Index | E-TFCI |
|----------|-----------|-----------|----------------|---------------------|--------------|--------------|--|-------------------|----------------------|---------|----------|----------|--------|
| 1 | 11/15 | 15/15 | 64 | 11/15 | 22/15 | 209/225 | 1039/225 | 4 | 1 | 1.5 | 1.5 | 20 | 75 |
| 2 | 6/15 | 15/15 | 64 | 6/15 | 12/15 | 12/15 | 12/15 | 4 | 1 | 1.5 | 1.5 | 12 | 67 |
| 3 | 15/15 | 9/15 | 64 | 15/9 | 30/15 | 30/15 | $\beta_{ed1}:47/15$ $\beta_{ed2}:47/15$ | 4 | 2 | 1.5 | 1.5 | 15 | 92 |
| 4 | 2/15 | 15/15 | 64 | 2/15 | 4/15 | 4/15 | 56/75 | 4 | 1 | 1.5 | 1.5 | 17 | 71 |
| 5 | 15/15 | 15/15 | 64 | 15/15 | 24/15 | 30/15 | 134/15 | 4 | 1 | 1.5 | 1.5 | 21 | 81 |

Rel.8 DC-HSDPA (Cat 24)

SAR test exclusion for Rel.8 DC-HSDPA must satisfy the SAR test exclusion requirements of Rel.5 HSDPA. SAR test exclusion for DC-HSDPA devices is determined by power measurements according to the H-Set 12, Fixed Reference Channel (FRC) configuration in Table C.8.1.12 of 3GPP TS 34.121-1. A primary and a secondary serving HS-DSCH Cell are required to perform the power measurement and for the results to qualify for SAR test exclusion.

9.4 SAR Measurement for LTE

SAR tests for LTE are performed with a base station simulator, Rohde & Schwarz CMW500. Closed loop power control was used so the UE transmits with maximum output power during SAR testing. All powers were measured with the CMW 500.

It is performed for conducted power and SAR based on the KDB941225 D05.

SAR is evaluated separately according to the following procedures for the different test positions in each exposure condition – head, body, body-worn accessories and other use conditions. The procedures in the following subsections are applied separately to test each LTE frequency band.

1) QPSK with 1 RB allocation

Start with the largest channel bandwidth and measure SAR for QPSK with 1 RB allocation, using the RB offset and required test channel combination with the highest maximum output power among RB offsets at the upper edge, middle and lower edge of each required test channel. When the reported SAR is ≤ 0.8 W/kg, testing of the remaining RB offset configurations and required test channels is not required for 1 RB allocation; otherwise, SAR is required for the remaining required test channels and only for the RB offset configuration with the highest output power for that channel. When the reported SAR of a required test channel is > 1.45 W/kg, SAR is required for all three RB offset configurations for that required test channel.

2) QPSK with 50% RB allocation

The procedures required for 1 RB allocation in 1) are applied to measure the SAR for QPSK with 50% RB allocation.

3) QPSK with 100% RB allocation

For QPSK with 100% RB allocation, SAR is not required when the highest maximum output power for 100 % RB allocation is less than the highest maximum output power in 50% and 1 RB allocations and the highest reported SAR for 1 RB and 50% RB allocation in 1) and 2) are ≤ 0.8 W/kg. Otherwise, SAR is measured for the highest output power channel; and if the reported SAR is > 1.45 W/kg, the remaining required test channels must also be tested.

9.5 Bluetooth & Wi-Fi Measurement Procedures for SAR

Normal network operating configurations are not suitable for measuring the SAR of 802.11 transmitters in general. Unpredictable fluctuations in network traffic and antenna diversity conditions can introduce undesirable variations in SAR results. The SAR for these devices should be measured using chipset based test mode software to ensure that the results are consistent and reliable.

Chipset based test mode software is hardware dependent and generally varies among manufacturers. The device operating parameters established in a test mode for SAR measurements must be identical to those programmed in production units, including output power levels, amplifier gain settings and other RF performance tuning parameters. The test frequencies should correspond to actual channel frequencies defined for domestic use. SAR for devices with switched diversity should be measured with only one antenna transmitting at a time during each SAR measurement, according to a fixed modulation and data rate. The same data pattern should be used for all measurements.

9.6 Power Drift

To control the output power stability during the SAR test, DASY4 system calculates the power drift by measuring the E-field at the same location at the beginning and at the end of the measurement for each test position. These drift values can be found in section 14 labeled as: (Power Drift [dB]). This ensures that the power drift during one measurement is within 5%.

10 Area Scan Based 1-g SAR

10.1 Requirement of KDB

According to the KDB447498 D01 v05, when the implementation is based the specific polynomial fit algorithm as presented at the 29th Bioelectromagnetics Society meeting (2007) and the estimated 1-g SAR is ≤ 1.2 W/kg, a zoom scan measurement is not required provided it is also not needed for any other purpose; for example, if the peak SAR location required for simultaneous transmission SAR test exclusion can be determined accurately by the SAR system or manually to discriminate between distinctive peaks and scattered noisy SAR distributions from area scans.

There must not be any warning or alert messages due to various measurement concerns identified by the SAR system; for example, noise in measurements, peaks too close to scan boundary, peaks are too sharp, spatial resolution and uncertainty issues etc. The SAR system verification must also demonstrate that the area scan estimated 1-g SAR is within 3% of the zoom scan 1-g SAR (See Annex B). When all the SAR results for each exposure condition in a frequency band and wireless mode are based on estimated 1-g SAR, the 1-g SAR for the highest SAR configuration must be determined by a zoom scan.

10.2 Fast SAR Algorithms

The approach is based on the area scan measurement applying a frequency dependent attenuation parameter. This attenuation parameter was empirically determined by analyzing a large number of phones. The MOTOROLA FAST SAR was developed and validated by the MOTOROLA Research Group in Ft. Lauderdale.

In the initial study, an approximation algorithm based on Linear fit was developed. The accuracy of the algorithm has been demonstrated across a broad frequency range (136-2450 MHz) and for both 1- and 10-g averaged SAR using a sample of 264 SAR measurements from 55 wireless handsets. For the sample size studied, the root-mean-squared errors of the algorithm are 1.2% and 5.8% for 1- and 10-g averaged SAR, respectively. The paper describing the algorithm in detail is expected to be published in August 2004 within the Special Issue of Transactions on MTT.

In the second step, the same research group optimized the fitting algorithm to an Polynomial fit whereby the frequency validity was extended to cover the range 30-6000MHz. Details of this study can be found in the BEMS 2007 Proceedings.

Both algorithms are implemented in DASY software.

11 Conducted Output Power

11.1 GSM Measurement result

During the process of testing, the EUT was controlled via Agilent Digital Radio Communication tester (E5515C) to ensure the maximum power transmission and proper modulation. This result contains conducted output power for the EUT. In all cases, the measured peak output power should be greater and within 5% than EMI measurement.

Table 11-1 GSM850 #1

| GSM850 #1 | | | | | | | | |
|----------------------|---------|----------------------|--------------------|--------------------|-------------|-------------------------|--------------------|--------------------|
| Config | Tune-up | Measured Power (dBm) | | | Calculation | Frame Burst Power (dBm) | | |
| | | CH251 848.8 MHz | CH190 836.6 MHz | CH128 824.2 MHz | | CH251 848.8 MHz | CH190 836.6 MHz | CH128 824.2 MHz |
| GSM Speech | 34.00 | 33.09 | 33.08 | 32.99 | | | | |
| GPRS 1 Txslot | 34.00 | 33.12 | 33.09 | 32.99 | -9.03 | 24.09 | 24.06 | 23.96 |
| GPRS 2 Txslots | 30.50 | 29.72 | 29.65 | 29.51 | -6.02 | 23.70 | 23.63 | 23.49 |
| GPRS 3 Txslots | 28.50 | 27.66 | 27.59 | 27.47 | -4.26 | 23.40 | 23.33 | 23.21 |
| GPRS 4 Txslots | 28.00 | 27.06 | 27.02 | 26.86 | -3.01 | 24.05 | 24.01 | 23.85 |
| EGPRS GMSK 1 Txslot | 34.00 | 33.09 | 33.07 | 32.98 | -9.03 | 24.06 | 24.04 | 23.95 |
| EGPRS GMSK 2 Txslots | 30.50 | 29.70 | 29.63 | 29.50 | -6.02 | 23.68 | 23.61 | 23.48 |
| EGPRS GMSK 3 Txslots | 28.50 | 27.64 | 27.57 | 27.46 | -4.26 | 23.38 | 23.31 | 23.20 |
| EGPRS GMSK 4 Txslots | 28.00 | 27.04 | 27.00 | 26.85 | -3.01 | 24.03 | 23.99 | 23.84 |
| EGPRS 8PSK 1 Txslot | 27.00 | 26.27 | 26.06 | 25.95 | -9.03 | 17.24 | 17.03 | 16.92 |
| EGPRS 8PSK 2 Txslots | 26.00 | 25.06 | 25.37 | 25.22 | -6.02 | 19.04 | 19.35 | 19.20 |
| EGPRS 8PSK 3 Txslots | 25.50 | 24.46 | 24.45 | 24.29 | -4.26 | 20.20 | 20.19 | 20.03 |
| EGPRS 8PSK 4 Txslots | 24.25 | 23.19 | 23.11 | 23.02 | -3.01 | 20.18 | 20.10 | 20.01 |

Table 11-2 PCS1900 #1

| PCS1900 #1 | | | | | | | | |
|----------------------|---------|----------------------|-------------------|---------------------|-------------|-------------------------|-------------------|---------------------|
| Config | Tune-up | Measured Power (dBm) | | | Calculation | Frame Burst Power (dBm) | | |
| | | CH810 1909.8 MHz | CH661 1880 MHz | CH512 1850.2 MHz | | CH810 1909.8 MHz | CH661 1880 MHz | CH512 1850.2 MHz |
| GSM Speech | 31.00 | 30.11 | 30.16 | 30.25 | | | | |
| GPRS 1 Txslot | 31.00 | 30.13 | 30.16 | 30.25 | -9.03 | 21.10 | 21.13 | 21.22 |
| GPRS 2 Txslots | 28.00 | 27.04 | 27.05 | 27.13 | -6.02 | 21.02 | 21.03 | 21.11 |
| GPRS 3 Txslots | 26.00 | 24.98 | 24.99 | 25.06 | -4.26 | 20.72 | 20.73 | 20.80 |
| GPRS 4 Txslots | 25.00 | 23.90 | 23.91 | 23.98 | -3.01 | 20.89 | 20.90 | 20.97 |
| EGPRS GMSK 1 Txslot | 31.00 | 30.08 | 30.14 | 30.23 | -9.03 | 21.05 | 21.11 | 21.20 |
| EGPRS GMSK 2 Txslots | 28.00 | 27.00 | 27.03 | 27.13 | -6.02 | 20.98 | 21.01 | 21.11 |
| EGPRS GMSK 3 Txslots | 26.00 | 24.95 | 24.97 | 25.05 | -4.26 | 20.69 | 20.71 | 20.79 |
| EGPRS GMSK 4 Txslots | 25.00 | 23.87 | 23.88 | 23.97 | -3.01 | 20.86 | 20.87 | 20.96 |
| EGPRS 8PSK 1 Txslot | 26.50 | 25.39 | 25.46 | 25.49 | -9.03 | 16.36 | 16.43 | 16.46 |
| EGPRS 8PSK 2 Txslots | 25.80 | 24.81 | 24.76 | 24.79 | -6.02 | 18.79 | 18.74 | 18.77 |
| EGPRS 8PSK 3 Txslots | 25.50 | 24.23 | 24.16 | 24.18 | -4.26 | 19.97 | 19.90 | 19.92 |
| EGPRS 8PSK 4 Txslots | 25.00 | 23.52 | 23.54 | 23.61 | -3.01 | 20.51 | 20.53 | 20.60 |

NOTES:

Division Factors

To average the power, the division factor is as follows:

1TX-slot = 1 transmit time slot out of 8 time slots=> conducted power divided by (8/1) => -9.03dB

2TX-slots = 2 transmit time slots out of 8 time slots=> conducted power divided by (8/2) => -6.02dB

3TX-slots = 3 transmit time slots out of 8 time slots=> conducted power divided by (8/3) => -4.26dB

4TX-slots = 4 transmit time slots out of 8 time slots=> conducted power divided by (8/4) => -3.01dB

According to the conducted power as above, the body measurements are performed with 1Txslot for 850MHz and 1900MHz GPRS&EGPRS.

11.2 WCDMA Measurement result

| WCDMA1900-BII #1 | | | | | |
|------------------|----------|---------|----------------------|--------------------|----------------------|
| Item | | Tune-up | Measured Power (dBm) | | |
| | | | CH9538 1907.6 MHz | CH9400 1880 MHz | CH9262 1852.4 MHz |
| WCDMA | RMC | 24.00 | 22.95 | 22.89 | 22.84 |
| HSUPA | subtest1 | 21.00 | 19.80 | 19.82 | 19.77 |
| | subtest2 | 21.00 | 19.76 | 19.83 | 19.71 |
| | subtest3 | 22.00 | 20.79 | 20.81 | 20.75 |
| | subtest4 | 21.00 | 19.30 | 19.33 | 19.26 |
| | subtest5 | 22.00 | 20.64 | 20.73 | 20.69 |
| HSPA+ | \ | 22.00 | 20.69 | 20.63 | 20.55 |
| DC-HSDPA | subtest1 | 22.00 | 21.52 | 21.48 | 21.42 |
| | subtest2 | 22.00 | 21.53 | 21.49 | 21.41 |
| | subtest3 | 22.00 | 21.51 | 21.50 | 21.39 |
| | subtest4 | 22.00 | 21.51 | 21.49 | 21.43 |

| WCDMA1700-BIV #1 | | | | | |
|------------------|----------|---------|----------------------|----------------------|----------------------|
| Item | | Tune-up | Measured Power (dBm) | | |
| | | | CH1513 1752.6 MHz | CH1412 1732.4 MHz | CH1312 1712.4 MHz |
| WCDMA | RMC | 23.00 | 22.78 | 22.74 | 22.81 |
| HSUPA | subtest1 | 21.00 | 19.56 | 19.56 | 19.63 |
| | subtest2 | 21.00 | 19.52 | 19.55 | 19.57 |
| | subtest3 | 22.00 | 20.54 | 20.55 | 20.62 |
| | subtest4 | 21.00 | 19.04 | 19.03 | 19.14 |
| | subtest5 | 22.00 | 20.45 | 20.53 | 20.52 |
| HSPA+ | \ | 22.00 | 20.45 | 20.39 | 20.34 |
| DC-HSDPA | subtest1 | 22.00 | 21.30 | 21.25 | 21.22 |
| | subtest2 | 22.00 | 21.31 | 21.26 | 21.23 |
| | subtest3 | 22.00 | 21.30 | 21.24 | 21.23 |
| | subtest4 | 22.00 | 21.32 | 21.27 | 21.25 |

| WCDMA850-BV #1 | | | | | |
|----------------|----------|---------|----------------------|---------------------|---------------------|
| Item | | Tune-up | Measured Power (dBm) | | |
| | | | CH4233 846.6 MHz | CH4182 835.4 MHz | CH4132 826.4 MHz |
| WCDMA | RMC | 24.50 | 23.18 | 23.13 | 23.23 |
| HSUPA | subtest1 | 21.50 | 19.96 | 19.89 | 20.06 |
| | subtest2 | 21.50 | 19.99 | 19.91 | 20.04 |
| | subtest3 | 22.50 | 20.98 | 20.90 | 21.05 |
| | subtest4 | 21.00 | 19.46 | 19.39 | 19.57 |
| | subtest5 | 22.00 | 20.83 | 20.89 | 20.94 |
| HSPA+ | \ | 22.00 | 20.76 | 20.73 | 20.82 |
| DC-HSDPA | subtest1 | 22.00 | 21.63 | 21.55 | 21.65 |
| | subtest2 | 22.00 | 21.64 | 21.56 | 21.67 |
| | subtest3 | 22.00 | 21.63 | 21.55 | 21.68 |
| | subtest4 | 22.00 | 21.65 | 21.54 | 21.67 |

11.3 LTE Measurement result

Table 11-3 LTE1900-FDD2 #1

| LTE1900-FDD2 #1 | | | | | | | | | |
|-----------------|-----------|--------------|---------|---------|----------------------------|-------|----------------|-------|---|
| SN | BandWidth | RB No./Start | Channel | Tune-up | Measured Power (dBm) & MPR | | | | |
| | | | | | QPSK | | 16QAM | | |
| | | | | | Measured Power | MPR | Measured Power | MPR | |
| 1.4MHz | 1H | | 19193 | 24 | 22.92 | 0 | 21.89 | 1 | |
| | | | 18900 | 24 | 22.91 | 0 | 22.24 | 1 | |
| | | | 18607 | 24 | 22.90 | 0 | 21.91 | 1 | |
| | 1M | | 19193 | 24 | 23.00 | 0 | 21.99 | 1 | |
| | | | 18900 | 24 | 23.10 | 0 | 22.37 | 1 | |
| | | | 18607 | 24 | 23.50 | 0 | 22.06 | 1 | |
| | 1L | | 19193 | 24 | 22.84 | 0 | 21.88 | 1 | |
| | | | 18900 | 24 | 22.87 | 0 | 22.23 | 1 | |
| | | | 18607 | 24 | 22.90 | 0 | 21.89 | 1 | |
| | 3H | | 19193 | 24 | 22.94 | 0 | 21.88 | 1 | |
| | | | 18900 | 24 | 22.98 | 0 | 22.10 | 1 | |
| | | | 18607 | 24 | 22.90 | 0 | 22.12 | 1 | |
| | 3M | | 19193 | 24 | 22.96 | 0 | 21.95 | 1 | |
| | | | 18900 | 24 | 22.97 | 0 | 22.14 | 1 | |
| | | | 18607 | 24 | 22.99 | 0 | 22.16 | 1 | |
| | 3L | | 19193 | 24 | 22.90 | 0 | 21.90 | 1 | |
| | | | 18900 | 24 | 22.94 | 0 | 22.10 | 1 | |
| | | | 18607 | 24 | 22.86 | 0 | 22.12 | 1 | |
| | 6 | | 19193 | 24 | 21.90 | 1 | 21.02 | 2 | |
| | | | 18900 | 24 | 21.99 | 1 | 20.91 | 2 | |
| | | | 18607 | 24 | 21.91 | 1 | 21.16 | 2 | |
| | 3MHz | 1H | | 19185 | 24 | 22.93 | 0 | 21.74 | 1 |
| | | | | 18900 | 24 | 22.94 | 0 | 22.26 | 1 |
| | | | | 18615 | 24 | 22.90 | 0 | 21.89 | 1 |
| | | 1M | | 19185 | 24 | 23.08 | 0 | 21.86 | 1 |
| | | | | 18900 | 24 | 23.06 | 0 | 22.41 | 1 |
| | | | | 18615 | 24 | 23.09 | 0 | 22.09 | 1 |
| 1L | | | 19185 | 24 | 22.68 | 0 | 21.76 | 1 | |
| | | | 18900 | 24 | 22.71 | 0 | 22.28 | 1 | |
| | | | 18615 | 24 | 22.90 | 0 | 21.96 | 1 | |
| 8H | | | 19185 | 24 | 21.92 | 1 | 20.98 | 2 | |
| | | | 18900 | 24 | 21.97 | 1 | 21.01 | 2 | |
| | | | 18615 | 24 | 21.93 | 1 | 21.01 | 2 | |
| 8M | | | 19185 | 24 | 21.89 | 1 | 21.03 | 2 | |
| | | | 18900 | 24 | 21.97 | 1 | 21.06 | 2 | |
| | | | 18615 | 24 | 21.91 | 1 | 21.00 | 2 | |
| 8L | | | 19185 | 24 | 21.89 | 1 | 20.98 | 2 | |
| | | | 18900 | 24 | 21.92 | 1 | 21.06 | 2 | |
| | | | 18615 | 24 | 21.93 | 1 | 20.98 | 2 | |
| 15 | | | 19185 | 24 | 21.85 | 1 | 20.94 | 2 | |
| | | | 18900 | 24 | 21.91 | 1 | 20.98 | 2 | |
| | | | 18615 | 24 | 21.87 | 1 | 20.90 | 2 | |
| 5MHz | | 1H | | 19175 | 24 | 22.81 | 0 | 21.86 | 1 |
| | | | | 18900 | 24 | 22.92 | 0 | 21.98 | 1 |
| | | | | 18625 | 24 | 22.83 | 0 | 22.28 | 1 |
| | | 1M | | 19175 | 24 | 23.05 | 0 | 22.08 | 1 |
| | | | | 18900 | 24 | 23.18 | 0 | 22.21 | 1 |
| | | | | 18625 | 24 | 23.07 | 0 | 22.59 | 1 |
| | 1L | | 19175 | 24 | 22.79 | 0 | 21.81 | 1 | |
| | | | 18900 | 24 | 22.93 | 0 | 21.96 | 1 | |
| | | | 18625 | 24 | 22.85 | 0 | 22.31 | 1 | |
| | 12H | | 19175 | 24 | 21.79 | 1 | 20.89 | 2 | |
| | | | 18900 | 24 | 22.02 | 1 | 20.92 | 2 | |
| | | | 18625 | 24 | 21.83 | 1 | 21.10 | 2 | |
| | 12M | | 19175 | 24 | 21.90 | 1 | 20.98 | 2 | |
| | | | 18900 | 24 | 21.91 | 1 | 21.02 | 2 | |
| | | | 18625 | 24 | 21.92 | 1 | 21.14 | 2 | |
| | 12L | | 19175 | 24 | 21.88 | 1 | 20.97 | 2 | |
| | | | 18900 | 24 | 21.89 | 1 | 20.98 | 2 | |
| | | | 18625 | 24 | 21.85 | 1 | 21.07 | 2 | |
| | 25 | | 19175 | 24 | 21.87 | 1 | 20.83 | 2 | |
| | | | 18900 | 24 | 21.93 | 1 | 20.89 | 2 | |
| | | | 18625 | 24 | 21.93 | 1 | 21.00 | 2 | |

| | | | | | | | | |
|-------|-------|-------|-------|-------|-------|-------|-------|---|
| 10MHz | 1H | 19150 | 24 | 22.80 | 0 | 21.84 | 1 | |
| | | 18900 | 24 | 22.90 | 0 | 21.84 | 1 | |
| | | 18650 | 24 | 22.96 | 0 | 22.23 | 1 | |
| | 1M | 19150 | 24 | 22.92 | 0 | 21.88 | 1 | |
| | | 18900 | 24 | 23.00 | 0 | 21.83 | 1 | |
| | | 18650 | 24 | 23.02 | 0 | 22.36 | 1 | |
| | 1L | 19150 | 24 | 22.87 | 0 | 21.82 | 1 | |
| | | 18900 | 24 | 22.89 | 0 | 21.79 | 1 | |
| | | 18650 | 24 | 22.90 | 0 | 22.21 | 1 | |
| | 25H | 19150 | 24 | 21.79 | 1 | 20.86 | 2 | |
| | | 18900 | 24 | 21.97 | 1 | 20.97 | 2 | |
| | | 18650 | 24 | 21.94 | 1 | 21.00 | 2 | |
| | 25M | 19150 | 24 | 21.89 | 1 | 20.94 | 2 | |
| | | 18900 | 24 | 21.94 | 1 | 20.98 | 2 | |
| | | 18650 | 24 | 21.92 | 1 | 21.00 | 2 | |
| | 25L | 19150 | 24 | 21.91 | 1 | 20.99 | 2 | |
| | | 18900 | 24 | 21.94 | 1 | 20.95 | 2 | |
| | | 18650 | 24 | 21.90 | 1 | 20.96 | 2 | |
| | 50 | 19150 | 24 | 21.91 | 1 | 20.87 | 2 | |
| | | 18900 | 24 | 21.89 | 1 | 20.89 | 2 | |
| | | 18650 | 24 | 21.89 | 1 | 20.96 | 2 | |
| | 15MHz | 1H | 19125 | 24 | 22.76 | 0 | 22.10 | 1 |
| | | | 18900 | 24 | 22.75 | 0 | 21.73 | 1 |
| | | | 18675 | 24 | 22.86 | 0 | 22.13 | 1 |
| | | 1M | 19125 | 24 | 22.94 | 0 | 22.21 | 1 |
| | | | 18900 | 24 | 22.92 | 0 | 21.82 | 1 |
| | | | 18675 | 24 | 22.97 | 0 | 22.25 | 1 |
| 1L | | 19125 | 24 | 22.84 | 0 | 22.22 | 1 | |
| | | 18900 | 24 | 22.84 | 0 | 21.69 | 1 | |
| | | 18675 | 24 | 22.86 | 0 | 22.14 | 1 | |
| 36H | | 19125 | 24 | 21.86 | 1 | 20.86 | 2 | |
| | | 18900 | 24 | 21.97 | 1 | 20.98 | 2 | |
| | | 18675 | 24 | 21.92 | 1 | 21.05 | 2 | |
| 36M | | 19125 | 24 | 21.89 | 1 | 20.87 | 2 | |
| | | 18900 | 24 | 21.97 | 1 | 20.99 | 2 | |
| | | 18675 | 24 | 21.93 | 1 | 20.98 | 2 | |
| 36L | | 19125 | 24 | 21.89 | 1 | 20.90 | 2 | |
| | | 18900 | 24 | 21.99 | 1 | 20.99 | 2 | |
| | | 18675 | 24 | 21.90 | 1 | 20.99 | 2 | |
| 75 | | 19125 | 24 | 21.86 | 1 | 20.81 | 2 | |
| | | 18900 | 24 | 21.96 | 1 | 20.96 | 2 | |
| | | 18675 | 24 | 21.94 | 1 | 20.97 | 2 | |
| 20MHz | | 1H | 19100 | 24 | 22.56 | 0 | 21.99 | 1 |
| | | | 18900 | 24 | 22.59 | 0 | 22.03 | 1 |
| | | | 18700 | 24 | 22.67 | 0 | 22.13 | 1 |
| | | 1M | 19100 | 24 | 23.03 | 0 | 22.39 | 1 |
| | | | 18900 | 24 | 23.04 | 0 | 22.38 | 1 |
| | | | 18700 | 24 | 23.05 | 0 | 22.53 | 1 |
| | 1L | 19100 | 24 | 22.59 | 0 | 22.05 | 1 | |
| | | 18900 | 24 | 22.62 | 0 | 21.95 | 1 | |
| | | 18700 | 24 | 22.61 | 0 | 22.08 | 1 | |
| | 50H | 19100 | 24 | 21.62 | 1 | 20.66 | 2 | |
| | | 18900 | 24 | 21.91 | 1 | 20.81 | 2 | |
| | | 18700 | 24 | 21.90 | 1 | 20.90 | 2 | |
| | 50M | 19100 | 24 | 21.87 | 1 | 20.88 | 2 | |
| | | 18900 | 24 | 21.92 | 1 | 20.89 | 2 | |
| | | 18700 | 24 | 21.91 | 1 | 20.94 | 2 | |
| | 50L | 19100 | 24 | 21.86 | 1 | 20.86 | 2 | |
| | | 18900 | 24 | 21.96 | 1 | 20.92 | 2 | |
| | | 18700 | 24 | 21.84 | 1 | 20.89 | 2 | |
| | 100 | 19100 | 24 | 21.78 | 1 | 20.75 | 2 | |
| | | 18900 | 24 | 21.94 | 1 | 20.96 | 2 | |
| | | 18700 | 24 | 21.88 | 1 | 20.93 | 2 | |

Table 11-4 LTE1700-FDD4 #1

| LTE1700-FDD4 #1 | | | | | | | | | |
|-----------------|-----------|--------------|---------|---------|----------------------------|-------|----------------|-------|---|
| SN | BandWidth | RB No./Start | Channel | Tune-up | Measured Power (dBm) & MPR | | | | |
| | | | | | QPSK | | 16QAM | | |
| | | | | | Measured Power | MPR | Measured Power | MPR | |
| 1.4MHz | 1H | | 20393 | 24 | 23.00 | 0 | 21.92 | 1 | |
| | | | 20175 | 24 | 22.41 | 0 | 21.92 | 1 | |
| | | | 19957 | 24 | 22.56 | 0 | 22.23 | 1 | |
| | 1M | | 20393 | 24 | 23.12 | 0 | 22.07 | 1 | |
| | | | 20175 | 24 | 23.16 | 0 | 22.13 | 1 | |
| | | | 19957 | 24 | 23.06 | 0 | 22.42 | 1 | |
| | 1L | | 20393 | 24 | 22.95 | 0 | 21.90 | 1 | |
| | | | 20175 | 24 | 22.89 | 0 | 21.94 | 1 | |
| | | | 19957 | 24 | 22.86 | 0 | 22.24 | 1 | |
| | 3H | | 20393 | 24 | 22.94 | 0 | 22.13 | 1 | |
| | | | 20175 | 24 | 22.92 | 0 | 21.94 | 1 | |
| | | | 19957 | 24 | 22.93 | 0 | 22.16 | 1 | |
| | 3M | | 20393 | 24 | 23.03 | 0 | 22.17 | 1 | |
| | | | 20175 | 24 | 23.00 | 0 | 21.98 | 1 | |
| | | | 19957 | 24 | 22.99 | 0 | 22.17 | 1 | |
| | 3L | | 20393 | 24 | 22.96 | 0 | 22.10 | 1 | |
| | | | 20175 | 24 | 22.92 | 0 | 21.93 | 1 | |
| | | | 19957 | 24 | 22.95 | 0 | 22.13 | 1 | |
| | 6 | | 20393 | 24 | 22.01 | 1 | 21.14 | 2 | |
| | | | 20175 | 24 | 21.95 | 1 | 21.06 | 2 | |
| | | | 19957 | 24 | 21.95 | 1 | 20.85 | 2 | |
| | 3MHz | 1H | | 20385 | 24 | 22.57 | 0 | 21.89 | 1 |
| | | | | 20175 | 24 | 22.34 | 0 | 21.74 | 1 |
| | | | | 19965 | 24 | 22.58 | 0 | 22.32 | 1 |
| | | 1M | | 20385 | 24 | 23.17 | 0 | 22.12 | 1 |
| | | | | 20175 | 24 | 23.10 | 0 | 21.92 | 1 |
| | | | | 19965 | 24 | 23.08 | 0 | 22.46 | 1 |
| 1L | | | 20385 | 24 | 22.77 | 0 | 21.97 | 1 | |
| | | | 20175 | 24 | 22.97 | 0 | 21.79 | 1 | |
| | | | 19965 | 24 | 22.90 | 0 | 22.27 | 1 | |
| 8H | | | 20385 | 24 | 22.01 | 1 | 21.01 | 2 | |
| | | | 20175 | 24 | 21.94 | 1 | 21.01 | 2 | |
| | | | 19965 | 24 | 21.90 | 1 | 21.03 | 2 | |
| 8M | | | 20385 | 24 | 22.02 | 1 | 21.07 | 2 | |
| | | | 20175 | 24 | 21.99 | 1 | 21.08 | 2 | |
| | | | 19965 | 24 | 21.95 | 1 | 21.10 | 2 | |
| 8L | | | 20385 | 24 | 22.00 | 1 | 21.04 | 2 | |
| | | | 20175 | 24 | 21.94 | 1 | 21.06 | 2 | |
| | | | 19965 | 24 | 21.96 | 1 | 21.06 | 2 | |
| 15 | | | 20385 | 24 | 21.95 | 1 | 20.95 | 2 | |
| | | | 20175 | 24 | 21.92 | 1 | 20.95 | 2 | |
| | | | 19965 | 24 | 21.94 | 1 | 20.97 | 2 | |
| 5MHz | | 1H | | 20375 | 24 | 22.92 | 0 | 21.97 | 1 |
| | | | | 20175 | 24 | 22.83 | 0 | 21.93 | 1 |
| | | | | 19975 | 24 | 22.98 | 0 | 22.35 | 1 |
| | | 1M | | 20375 | 24 | 23.13 | 0 | 22.20 | 1 |
| | | | | 20175 | 24 | 23.13 | 0 | 22.23 | 1 |
| | | | | 19975 | 24 | 23.09 | 0 | 22.62 | 1 |
| | 1L | | 20375 | 24 | 22.87 | 0 | 21.98 | 1 | |
| | | | 20175 | 24 | 22.88 | 0 | 21.99 | 1 | |
| | | | 19975 | 24 | 22.84 | 0 | 22.37 | 1 | |
| | 12H | | 20375 | 24 | 21.90 | 1 | 20.98 | 2 | |
| | | | 20175 | 24 | 21.85 | 1 | 20.95 | 2 | |
| | | | 19975 | 24 | 21.88 | 1 | 21.09 | 2 | |
| | 12M | | 20375 | 24 | 22.00 | 1 | 21.08 | 2 | |
| | | | 20175 | 24 | 21.96 | 1 | 21.04 | 2 | |
| | | | 19975 | 24 | 21.96 | 1 | 21.15 | 2 | |
| | 12L | | 20375 | 24 | 21.89 | 1 | 20.97 | 2 | |
| | | | 20175 | 24 | 21.86 | 1 | 20.96 | 2 | |
| | | | 19975 | 24 | 21.90 | 1 | 21.08 | 2 | |
| | 25 | | 20375 | 24 | 21.95 | 1 | 20.90 | 2 | |
| | | | 20175 | 24 | 21.86 | 1 | 20.90 | 2 | |
| | | | 19975 | 24 | 21.91 | 1 | 20.99 | 2 | |

| | | | | | | | | |
|-------|-------|-------|-------|-------|-------|-------|-------|---|
| 10MHz | 1H | 20350 | 24 | 22.20 | 0 | 22.24 | 1 | |
| | | 20175 | 24 | 22.35 | 0 | 21.81 | 1 | |
| | | 20000 | 24 | 22.73 | 0 | 21.85 | 1 | |
| | 1M | 20350 | 24 | 23.05 | 0 | 22.35 | 1 | |
| | | 20175 | 24 | 23.04 | 0 | 21.97 | 1 | |
| | | 20000 | 24 | 23.06 | 0 | 21.97 | 1 | |
| | 1L | 20350 | 24 | 22.99 | 0 | 22.26 | 1 | |
| | | 20175 | 24 | 22.16 | 0 | 21.92 | 1 | |
| | | 20000 | 24 | 22.92 | 0 | 21.88 | 1 | |
| | 25H | 20350 | 24 | 21.92 | 1 | 20.97 | 2 | |
| | | 20175 | 24 | 21.88 | 1 | 20.95 | 2 | |
| | | 20000 | 24 | 21.95 | 1 | 21.00 | 2 | |
| | 25M | 20350 | 24 | 21.95 | 1 | 21.00 | 2 | |
| | | 20175 | 24 | 21.97 | 1 | 21.04 | 2 | |
| | | 20000 | 24 | 22.01 | 1 | 21.05 | 2 | |
| | 25L | 20350 | 24 | 21.94 | 1 | 21.00 | 2 | |
| | | 20175 | 24 | 21.92 | 1 | 20.99 | 2 | |
| | | 20000 | 24 | 21.97 | 1 | 20.98 | 2 | |
| | 50 | 20350 | 24 | 21.91 | 1 | 20.94 | 2 | |
| | | 20175 | 24 | 21.88 | 1 | 20.92 | 2 | |
| | | 20000 | 24 | 22.01 | 1 | 20.99 | 2 | |
| | 15MHz | 1H | 20325 | 24 | 22.90 | 0 | 22.23 | 1 |
| | | | 20175 | 24 | 22.84 | 0 | 21.68 | 1 |
| | | | 20025 | 24 | 22.88 | 0 | 22.10 | 1 |
| 1M | | 20325 | 24 | 23.07 | 0 | 22.43 | 1 | |
| | | 20175 | 24 | 23.02 | 0 | 21.86 | 1 | |
| | | 20025 | 24 | 23.08 | 0 | 22.38 | 1 | |
| 1L | | 20325 | 24 | 22.94 | 0 | 22.30 | 1 | |
| | | 20175 | 24 | 22.92 | 0 | 21.81 | 1 | |
| | | 20025 | 24 | 22.97 | 0 | 22.26 | 1 | |
| 36H | | 20325 | 24 | 21.97 | 1 | 20.98 | 2 | |
| | | 20175 | 24 | 21.96 | 1 | 20.96 | 2 | |
| | | 20025 | 24 | 21.95 | 1 | 21.03 | 2 | |
| 36M | | 20325 | 24 | 22.04 | 1 | 21.03 | 2 | |
| | | 20175 | 24 | 22.01 | 1 | 21.03 | 2 | |
| | | 20025 | 24 | 21.98 | 1 | 21.07 | 2 | |
| 36L | | 20325 | 24 | 22.04 | 1 | 21.02 | 2 | |
| | | 20175 | 24 | 21.98 | 1 | 20.98 | 2 | |
| | | 20025 | 24 | 21.98 | 1 | 21.08 | 2 | |
| 75 | | 20325 | 24 | 22.02 | 1 | 21.01 | 2 | |
| | | 20175 | 24 | 21.95 | 1 | 20.95 | 2 | |
| | | 20025 | 24 | 21.98 | 1 | 21.02 | 2 | |
| 20MHz | | 1H | 20300 | 24 | 22.71 | 0 | 22.13 | 1 |
| | | | 20175 | 24 | 22.58 | 0 | 21.97 | 1 |
| | | | 20050 | 24 | 22.64 | 0 | 22.08 | 1 |
| | 1M | 20300 | 24 | 23.14 | 0 | 22.55 | 1 | |
| | | 20175 | 24 | 23.11 | 0 | 22.44 | 1 | |
| | | 20050 | 24 | 23.12 | 0 | 22.64 | 1 | |
| | 1L | 20300 | 24 | 22.76 | 0 | 22.14 | 1 | |
| | | 20175 | 24 | 22.73 | 0 | 22.17 | 1 | |
| | | 20050 | 24 | 22.72 | 0 | 22.26 | 1 | |
| | 50H | 20300 | 24 | 21.93 | 1 | 20.93 | 2 | |
| | | 20175 | 24 | 21.87 | 1 | 20.82 | 2 | |
| | | 20050 | 24 | 22.03 | 1 | 21.06 | 2 | |
| | 50M | 20300 | 24 | 22.00 | 1 | 21.02 | 2 | |
| | | 20175 | 24 | 21.99 | 1 | 20.99 | 2 | |
| | | 20050 | 24 | 22.04 | 1 | 21.09 | 2 | |
| | 50L | 20300 | 24 | 22.09 | 1 | 21.11 | 2 | |
| | | 20175 | 24 | 21.93 | 1 | 20.92 | 2 | |
| | | 20050 | 24 | 22.05 | 1 | 21.09 | 2 | |
| | 100 | 20300 | 24 | 22.05 | 1 | 21.05 | 2 | |
| | | 20175 | 24 | 21.90 | 1 | 20.88 | 2 | |
| | | 20050 | 24 | 22.03 | 1 | 21.07 | 2 | |

Table 11-5 LTE850-FDD5 #1

| LTE850-FDD5 #1 | | | | | | | | |
|----------------|--------------|---------|---------|----------------------------|-------|----------------|-------|---|
| BandWidth | RB No./Start | Channel | Tune-up | Measured Power (dBm) & MPR | | | | |
| | | | | QPSK | | 16QAM | | |
| | | | | Measured Power | MPR | Measured Power | MPR | |
| 1.4MHz | 1H | 20643 | 24 | 22.74 | 0 | 21.81 | 1 | |
| | | 20525 | 24 | 22.71 | 0 | 21.97 | 1 | |
| | | 20407 | 24 | 22.72 | 0 | 21.70 | 1 | |
| | 1M | 20643 | 24 | 22.75 | 0 | 22.03 | 1 | |
| | | 20525 | 24 | 22.78 | 0 | 21.92 | 1 | |
| | | 20407 | 24 | 22.85 | 0 | 21.80 | 1 | |
| | 1L | 20643 | 24 | 22.63 | 0 | 21.80 | 1 | |
| | | 20525 | 24 | 22.65 | 0 | 22.00 | 1 | |
| | | 20407 | 24 | 22.13 | 0 | 21.68 | 1 | |
| | 3H | 20643 | 24 | 22.72 | 0 | 21.84 | 1 | |
| | | 20525 | 24 | 22.69 | 0 | 21.94 | 1 | |
| | | 20407 | 24 | 22.71 | 0 | 21.83 | 1 | |
| | 3M | 20643 | 24 | 22.83 | 0 | 21.87 | 1 | |
| | | 20525 | 24 | 22.79 | 0 | 21.93 | 1 | |
| | | 20407 | 24 | 22.78 | 0 | 21.86 | 1 | |
| | 3L | 20643 | 24 | 22.77 | 0 | 21.84 | 1 | |
| | | 20525 | 24 | 22.77 | 0 | 21.90 | 1 | |
| | | 20407 | 24 | 22.71 | 0 | 21.87 | 1 | |
| | 6 | 20643 | 24 | 21.73 | 1 | 20.91 | 2 | |
| | | 20525 | 24 | 21.71 | 1 | 20.66 | 2 | |
| | | 20407 | 24 | 21.75 | 1 | 20.89 | 2 | |
| | 3MHz | 1H | 20635 | 24 | 22.83 | 0 | 22.21 | 1 |
| | | | 20525 | 24 | 22.71 | 0 | 21.66 | 1 |
| | | | 20415 | 24 | 22.87 | 0 | 21.71 | 1 |
| | | 1M | 20635 | 24 | 22.73 | 0 | 21.75 | 1 |
| | | | 20525 | 24 | 22.71 | 0 | 21.85 | 1 |
| | | | 20415 | 24 | 22.78 | 0 | 21.83 | 1 |
| 1L | | 20635 | 24 | 22.74 | 0 | 22.15 | 1 | |
| | | 20525 | 24 | 22.72 | 0 | 21.79 | 1 | |
| | | 20415 | 24 | 22.75 | 0 | 21.69 | 1 | |
| 8H | | 20635 | 24 | 21.73 | 1 | 20.91 | 2 | |
| | | 20525 | 24 | 21.76 | 1 | 20.81 | 2 | |
| | | 20415 | 24 | 21.72 | 1 | 20.89 | 2 | |
| 8M | | 20635 | 24 | 21.75 | 1 | 20.95 | 2 | |
| | | 20525 | 24 | 21.78 | 1 | 20.84 | 2 | |
| | | 20415 | 24 | 21.85 | 1 | 20.98 | 2 | |
| 8L | | 20635 | 24 | 21.75 | 1 | 20.91 | 2 | |
| | | 20525 | 24 | 21.73 | 1 | 20.79 | 2 | |
| | | 20415 | 24 | 21.81 | 1 | 20.92 | 2 | |
| 15 | | 20635 | 24 | 21.78 | 1 | 20.84 | 2 | |
| | | 20525 | 24 | 21.76 | 1 | 20.74 | 2 | |
| | | 20415 | 24 | 21.77 | 1 | 20.79 | 2 | |
| 5MHz | | 1H | 20625 | 24 | 22.66 | 0 | 21.82 | 1 |
| | | | 20525 | 24 | 22.64 | 0 | 21.76 | 1 |
| | | | 20425 | 24 | 22.73 | 0 | 22.19 | 1 |
| | | 1M | 20625 | 24 | 22.90 | 0 | 22.06 | 1 |
| | | | 20525 | 24 | 22.91 | 0 | 22.08 | 1 |
| | | | 20425 | 24 | 22.97 | 0 | 22.44 | 1 |
| | 1L | 20625 | 24 | 22.67 | 0 | 21.78 | 1 | |
| | | 20525 | 24 | 22.70 | 0 | 21.87 | 1 | |
| | | 20425 | 24 | 22.70 | 0 | 22.15 | 1 | |
| | 12H | 20625 | 24 | 21.80 | 1 | 20.92 | 2 | |
| | | 20525 | 24 | 21.70 | 1 | 20.86 | 2 | |
| | | 20425 | 24 | 21.76 | 1 | 20.89 | 2 | |
| | 12M | 20625 | 24 | 21.76 | 1 | 20.90 | 2 | |
| | | 20525 | 24 | 21.76 | 1 | 20.91 | 2 | |
| | | 20425 | 24 | 21.82 | 1 | 21.03 | 2 | |
| | 12L | 20625 | 24 | 21.75 | 1 | 20.90 | 2 | |
| | | 20525 | 24 | 21.67 | 1 | 20.83 | 2 | |
| | | 20425 | 24 | 21.74 | 1 | 20.92 | 2 | |
| | 25 | 20625 | 24 | 21.80 | 1 | 20.80 | 2 | |
| | | 20525 | 24 | 21.74 | 1 | 20.77 | 2 | |
| | | 20425 | 24 | 21.77 | 1 | 20.84 | 2 | |



| | | | | | | | |
|-------|-----|-------|----|-------|---|--------------|---|
| 10MHz | 1H | 20600 | 24 | 22.78 | 0 | 21.86 | 1 |
| | | 20525 | 24 | 22.88 | 0 | 21.65 | 1 |
| | | 20450 | 24 | 22.83 | 0 | 22.19 | 1 |
| | 1M | 20600 | 24 | 22.86 | 0 | 21.81 | 1 |
| | | 20525 | 24 | 22.91 | 0 | 21.82 | 1 |
| | | 20450 | 24 | 22.90 | 0 | 22.28 | 1 |
| | 1L | 20600 | 24 | 22.73 | 0 | 21.67 | 1 |
| | | 20525 | 24 | 22.76 | 0 | 21.75 | 1 |
| | | 20450 | 24 | 22.75 | 0 | 21.84 | 1 |
| | 25H | 20600 | 24 | 21.85 | 1 | 20.96 | 2 |
| | | 20525 | 24 | 21.79 | 1 | 20.83 | 2 |
| | | 20450 | 24 | 21.93 | 1 | 20.97 | 2 |
| | 25M | 20600 | 24 | 21.88 | 1 | 20.96 | 2 |
| | | 20525 | 24 | 21.85 | 1 | 20.88 | 2 |
| | | 20450 | 24 | 21.89 | 1 | 20.96 | 2 |
| | 25L | 20600 | 24 | 21.97 | 1 | 21.02 | 2 |
| | | 20525 | 24 | 21.77 | 1 | 20.85 | 2 |
| | | 20450 | 24 | 21.95 | 1 | 21.02 | 2 |
| | 50 | 20600 | 24 | 21.93 | 1 | 20.97 | 2 |
| | | 20525 | 24 | 21.79 | 1 | 20.75 | 2 |
| | | 20450 | 24 | 21.93 | 1 | 20.99 | 2 |

Table 11-6 LTE2500-FDD7 #1

| LTE2500-FDD7 #1 | | | | | | | | |
|-----------------|--------------|---------|---------|----------------------------|-------|----------------|-------|---|
| BandWidth | RB No./Start | Channel | Tune-up | Measured Power (dBm) & MPR | | | | |
| | | | | QPSK | | 16QAM | | |
| | | | | Measured Power | MPR | Measured Power | MPR | |
| 5MHz | 1H | 21425 | 24 | 23.29 | 0 | 22.31 | 1 | |
| | | 21100 | 24 | 23.25 | 0 | 22.28 | 1 | |
| | | 20775 | 24 | 23.21 | 0 | 22.56 | 1 | |
| | 1M | 21425 | 24 | 23.47 | 0 | 22.47 | 1 | |
| | | 21100 | 24 | 23.46 | 0 | 22.43 | 1 | |
| | | 20775 | 24 | 23.41 | 0 | 22.77 | 1 | |
| | 1L | 21425 | 24 | 23.31 | 0 | 22.25 | 1 | |
| | | 21100 | 24 | 23.29 | 0 | 22.24 | 1 | |
| | | 20775 | 24 | 23.24 | 0 | 22.57 | 1 | |
| | 12H | 21425 | 24 | 22.23 | 1 | 21.26 | 2 | |
| | | 21100 | 24 | 22.18 | 1 | 21.25 | 2 | |
| | | 20775 | 24 | 22.21 | 1 | 21.32 | 2 | |
| | 12M | 21425 | 24 | 22.29 | 1 | 21.30 | 2 | |
| | | 21100 | 24 | 22.21 | 1 | 21.24 | 2 | |
| | | 20775 | 24 | 22.25 | 1 | 21.35 | 2 | |
| | 12L | 21425 | 24 | 22.31 | 1 | 21.27 | 2 | |
| | | 21100 | 24 | 22.13 | 1 | 21.17 | 2 | |
| | | 20775 | 24 | 22.16 | 1 | 21.24 | 2 | |
| | 25 | 21425 | 24 | 22.27 | 1 | 21.16 | 2 | |
| | | 21100 | 24 | 22.19 | 1 | 21.18 | 2 | |
| | | 20775 | 24 | 22.23 | 1 | 21.24 | 2 | |
| | 10MHz | 1H | 21400 | 24 | 23.36 | 0 | 22.24 | 1 |
| | | | 21100 | 24 | 23.28 | 0 | 22.14 | 1 |
| | | | 20800 | 24 | 23.25 | 0 | 22.50 | 1 |
| | | 1M | 21400 | 24 | 23.60 | 0 | 22.33 | 1 |
| | | | 21100 | 24 | 23.36 | 0 | 22.21 | 1 |
| | | | 20800 | 24 | 23.36 | 0 | 22.61 | 1 |
| 1L | | 21400 | 24 | 23.44 | 0 | 22.19 | 1 | |
| | | 21100 | 24 | 23.35 | 0 | 22.13 | 1 | |
| | | 20800 | 24 | 23.32 | 0 | 22.56 | 1 | |
| 25H | | 21400 | 24 | 22.25 | 1 | 21.31 | 2 | |
| | | 21100 | 24 | 22.29 | 1 | 21.27 | 2 | |
| | | 20800 | 24 | 22.34 | 1 | 21.35 | 2 | |
| 25M | | 21400 | 24 | 22.33 | 1 | 21.35 | 2 | |
| | | 21100 | 24 | 22.27 | 1 | 21.26 | 2 | |
| | | 20800 | 24 | 22.26 | 1 | 21.28 | 2 | |
| 25L | | 21400 | 24 | 22.37 | 1 | 21.38 | 2 | |
| | | 21100 | 24 | 22.28 | 1 | 21.22 | 2 | |
| | | 20800 | 24 | 22.18 | 1 | 21.20 | 2 | |
| 50 | | 21400 | 24 | 22.27 | 1 | 21.25 | 2 | |
| | | 21100 | 24 | 22.25 | 1 | 21.21 | 2 | |
| | | 20800 | 24 | 22.22 | 1 | 21.22 | 2 | |
| 15MHz | | 1H | 21375 | 24 | 23.24 | 0 | 22.47 | 1 |
| | | | 21100 | 24 | 23.23 | 0 | 22.49 | 1 |
| | | | 20825 | 24 | 23.08 | 0 | 21.88 | 1 |
| | | 1M | 21375 | 24 | 23.43 | 0 | 22.54 | 1 |
| | | | 21100 | 24 | 23.33 | 0 | 22.56 | 1 |
| | | | 20825 | 24 | 23.29 | 0 | 22.09 | 1 |
| | 1L | 21375 | 24 | 23.33 | 0 | 22.47 | 1 | |
| | | 21100 | 24 | 23.29 | 0 | 22.44 | 1 | |
| | | 20825 | 24 | 23.22 | 0 | 22.06 | 1 | |
| | 36H | 21375 | 24 | 22.33 | 1 | 21.28 | 2 | |
| | | 21100 | 24 | 22.32 | 1 | 21.28 | 2 | |
| | | 20825 | 24 | 22.32 | 1 | 21.27 | 2 | |
| | 36M | 21375 | 24 | 22.46 | 1 | 21.41 | 2 | |
| | | 21100 | 24 | 22.34 | 1 | 21.30 | 2 | |
| | | 20825 | 24 | 22.32 | 1 | 21.29 | 2 | |
| | 36L | 21375 | 24 | 22.45 | 1 | 21.44 | 2 | |
| | | 21100 | 24 | 22.40 | 1 | 21.26 | 2 | |
| | | 20825 | 24 | 22.27 | 1 | 21.21 | 2 | |
| | 75 | 21375 | 24 | 22.41 | 1 | 21.33 | 2 | |
| | | 21100 | 24 | 22.33 | 1 | 21.27 | 2 | |
| | | 20825 | 24 | 22.29 | 1 | 21.25 | 2 | |



| | | | | | | | |
|-------|-----|-------|----|-------|---|-------|---|
| 20MHz | 1H | 21350 | 24 | 23.04 | 0 | 22.36 | 1 |
| | | 21100 | 24 | 23.02 | 0 | 22.27 | 1 |
| | | 20850 | 24 | 22.99 | 0 | 22.27 | 1 |
| | 1M | 21350 | 24 | 23.56 | 0 | 22.71 | 1 |
| | | 21100 | 24 | 23.43 | 0 | 22.67 | 1 |
| | | 20850 | 24 | 23.44 | 0 | 22.78 | 1 |
| | 1L | 21350 | 24 | 23.10 | 0 | 22.38 | 1 |
| | | 21100 | 24 | 23.08 | 0 | 22.24 | 1 |
| | | 20850 | 24 | 23.08 | 0 | 22.46 | 1 |
| | 50H | 21350 | 24 | 22.12 | 1 | 21.06 | 2 |
| | | 21100 | 24 | 22.28 | 1 | 21.21 | 2 |
| | | 20850 | 24 | 22.14 | 1 | 21.12 | 2 |
| | 50M | 21350 | 24 | 22.28 | 1 | 21.22 | 2 |
| | | 21100 | 24 | 22.25 | 1 | 21.22 | 2 |
| | | 20850 | 24 | 22.23 | 1 | 21.22 | 2 |
| | 50L | 21350 | 24 | 22.25 | 1 | 21.25 | 2 |
| | | 21100 | 24 | 22.22 | 1 | 21.14 | 2 |
| | | 20850 | 24 | 22.04 | 1 | 21.04 | 2 |
| | 100 | 21350 | 24 | 22.19 | 1 | 21.15 | 2 |
| | | 21100 | 24 | 22.28 | 1 | 21.23 | 2 |
| | | 20850 | 24 | 22.10 | 1 | 21.12 | 2 |

Table 11-7 LTE700-FDD12 #1

| LTE700-FDD12 #1 | | | | | | | | |
|-----------------|--------------|---------|---------|----------------------------|-------|----------------|-------|---|
| BandWidth | RB No./Start | Channel | Tune-up | Measured Power (dBm) & MPR | | | | |
| | | | | QPSK | | 16QAM | | |
| | | | | Measured Power | MPR | Measured Power | MPR | |
| 1.4MHz | 1H | 23173 | 24 | 22.55 | 0 | 21.64 | 1 | |
| | | 23095 | 24 | 22.60 | 0 | 21.72 | 1 | |
| | | 23017 | 24 | 22.62 | 0 | 21.62 | 1 | |
| | 1M | 23173 | 24 | 22.76 | 0 | 21.70 | 1 | |
| | | 23095 | 24 | 22.77 | 0 | 21.85 | 1 | |
| | | 23017 | 24 | 22.76 | 0 | 21.74 | 1 | |
| | 1L | 23173 | 24 | 22.52 | 0 | 21.59 | 1 | |
| | | 23095 | 24 | 22.62 | 0 | 21.70 | 1 | |
| | | 23017 | 24 | 22.59 | 0 | 21.60 | 1 | |
| | 3H | 23173 | 24 | 22.64 | 0 | 21.84 | 1 | |
| | | 23095 | 24 | 22.62 | 0 | 21.67 | 1 | |
| | | 23017 | 24 | 22.73 | 0 | 21.83 | 1 | |
| | 3M | 23173 | 24 | 22.67 | 0 | 21.86 | 1 | |
| | | 23095 | 24 | 22.68 | 0 | 21.76 | 1 | |
| | | 23017 | 24 | 22.70 | 0 | 21.87 | 1 | |
| | 3L | 23173 | 24 | 22.60 | 0 | 21.90 | 1 | |
| | | 23095 | 24 | 22.61 | 0 | 21.71 | 1 | |
| | | 23017 | 24 | 22.66 | 0 | 21.79 | 1 | |
| | 6 | 23173 | 24 | 21.74 | 1 | 20.84 | 2 | |
| | | 23095 | 24 | 21.67 | 1 | 20.81 | 2 | |
| | | 23017 | 24 | 21.67 | 1 | 20.78 | 2 | |
| | 3MHz | 1H | 23165 | 24 | 22.66 | 0 | 21.64 | 1 |
| | | | 23095 | 24 | 22.62 | 0 | 21.53 | 1 |
| | | | 23025 | 24 | 22.71 | 0 | 22.03 | 1 |
| | | 1M | 23165 | 24 | 22.72 | 0 | 21.75 | 1 |
| | | | 23095 | 24 | 22.77 | 0 | 21.72 | 1 |
| | | | 23025 | 24 | 22.85 | 0 | 22.18 | 1 |
| 1L | | 23165 | 24 | 22.64 | 0 | 21.63 | 1 | |
| | | 23095 | 24 | 22.59 | 0 | 21.58 | 1 | |
| | | 23025 | 24 | 22.69 | 0 | 21.98 | 1 | |
| 8H | | 23165 | 24 | 21.72 | 1 | 20.71 | 2 | |
| | | 23095 | 24 | 21.71 | 1 | 20.77 | 2 | |
| | | 23025 | 24 | 21.73 | 1 | 20.77 | 2 | |
| 8M | | 23165 | 24 | 21.77 | 1 | 20.76 | 2 | |
| | | 23095 | 24 | 21.79 | 1 | 20.83 | 2 | |
| | | 23025 | 24 | 21.77 | 1 | 20.82 | 2 | |
| 8L | | 23165 | 24 | 21.75 | 1 | 20.72 | 2 | |
| | | 23095 | 24 | 21.71 | 1 | 20.80 | 2 | |
| | | 23025 | 24 | 21.71 | 1 | 20.77 | 2 | |
| 15 | | 23165 | 24 | 21.69 | 1 | 20.61 | 2 | |
| | | 23095 | 24 | 21.70 | 1 | 20.70 | 2 | |
| | | 23025 | 24 | 21.71 | 1 | 20.73 | 2 | |
| 5MHz | | 1H | 23155 | 24 | 22.56 | 0 | 21.66 | 1 |
| | | | 23095 | 24 | 22.60 | 0 | 21.69 | 1 |
| | | | 23035 | 24 | 22.57 | 0 | 22.08 | 1 |
| | | 1M | 23155 | 24 | 22.85 | 0 | 21.89 | 1 |
| | | | 23095 | 24 | 22.88 | 0 | 21.94 | 1 |
| | | | 23035 | 24 | 22.82 | 0 | 22.33 | 1 |
| | 1L | 23155 | 24 | 22.51 | 0 | 21.57 | 1 | |
| | | 23095 | 24 | 22.61 | 0 | 21.74 | 1 | |
| | | 23035 | 24 | 22.49 | 0 | 22.02 | 1 | |
| | 12H | 23155 | 24 | 21.60 | 1 | 20.63 | 2 | |
| | | 23095 | 24 | 21.66 | 1 | 20.75 | 2 | |
| | | 23035 | 24 | 21.65 | 1 | 20.80 | 2 | |
| | 12M | 23155 | 24 | 21.75 | 1 | 20.76 | 2 | |
| | | 23095 | 24 | 21.72 | 1 | 20.80 | 2 | |
| | | 23035 | 24 | 21.74 | 1 | 20.84 | 2 | |
| | 12L | 23155 | 24 | 21.70 | 1 | 20.69 | 2 | |
| | | 23095 | 24 | 21.65 | 1 | 20.73 | 2 | |
| | | 23035 | 24 | 21.65 | 1 | 20.79 | 2 | |
| | 25 | 23155 | 24 | 21.70 | 1 | 20.61 | 2 | |
| | | 23095 | 24 | 21.71 | 1 | 20.69 | 2 | |
| | | 23035 | 24 | 21.68 | 1 | 20.69 | 2 | |



| | | | | | | | |
|-------|-----|-------|----|-------|---|--------------|---|
| 10MHz | 1H | 23130 | 24 | 22.68 | 0 | 22.00 | 1 |
| | | 23095 | 24 | 22.56 | 0 | 21.58 | 1 |
| | | 23060 | 24 | 22.62 | 0 | 21.54 | 1 |
| | 1M | 23130 | 24 | 22.73 | 0 | 22.04 | 1 |
| | | 23095 | 24 | 22.69 | 0 | 21.75 | 1 |
| | | 23060 | 24 | 22.73 | 0 | 21.70 | 1 |
| | 1L | 23130 | 24 | 22.64 | 0 | 21.99 | 1 |
| | | 23095 | 24 | 22.59 | 0 | 21.64 | 1 |
| | | 23060 | 24 | 22.58 | 0 | 21.52 | 1 |
| | 25H | 23130 | 24 | 21.60 | 1 | 20.63 | 2 |
| | | 23095 | 24 | 21.73 | 1 | 20.79 | 2 |
| | | 23060 | 24 | 21.77 | 1 | 20.79 | 2 |
| | 25M | 23130 | 24 | 21.68 | 1 | 20.67 | 2 |
| | | 23095 | 24 | 21.74 | 1 | 20.82 | 2 |
| | | 23060 | 24 | 21.76 | 1 | 20.74 | 2 |
| | 25L | 23130 | 24 | 21.65 | 1 | 20.64 | 2 |
| | | 23095 | 24 | 21.72 | 1 | 20.76 | 2 |
| | | 23060 | 24 | 21.73 | 1 | 20.70 | 2 |
| | 50 | 23130 | 24 | 21.65 | 1 | 20.61 | 2 |
| | | 23095 | 24 | 21.75 | 1 | 20.73 | 2 |
| | | 23060 | 24 | 21.77 | 1 | 20.74 | 2 |

Table 11-8 LTE750-FDD13 #1

| LTE750-FDD13 #1 | | | | | | | | |
|-----------------|--------------|---------|---------|----------------------------|-------|----------------|-------|---|
| BandWidth | RB No./Start | Channel | Tune-up | Measured Power (dBm) & MPR | | | | |
| | | | | QPSK | | 16QAM | | |
| | | | | Measured Power | MPR | Measured Power | MPR | |
| 5MHz | 1H | 23255 | 24 | 22.65 | 0 | 21.68 | 1 | |
| | | 23230 | 24 | 22.71 | 0 | 21.76 | 1 | |
| | | 23205 | 24 | 22.66 | 0 | 22.11 | 1 | |
| | 1M | 23255 | 24 | 22.87 | 0 | 21.91 | 1 | |
| | | 23230 | 24 | 22.95 | 0 | 21.96 | 1 | |
| | | 23205 | 24 | 22.88 | 0 | 22.31 | 1 | |
| | 1L | 23255 | 24 | 22.67 | 0 | 21.71 | 1 | |
| | | 23230 | 24 | 22.73 | 0 | 21.73 | 1 | |
| | | 23205 | 24 | 22.60 | 0 | 22.04 | 1 | |
| | 12H | 23255 | 24 | 21.66 | 1 | 20.77 | 2 | |
| | | 23230 | 24 | 21.72 | 1 | 20.84 | 2 | |
| | | 23205 | 24 | 21.70 | 1 | 20.91 | 2 | |
| | 12M | 23255 | 24 | 21.72 | 1 | 20.81 | 2 | |
| | | 23230 | 24 | 21.74 | 1 | 20.86 | 2 | |
| | | 23205 | 24 | 21.74 | 1 | 20.94 | 2 | |
| | 12L | 23255 | 24 | 21.66 | 1 | 20.77 | 2 | |
| | | 23230 | 24 | 21.68 | 1 | 20.84 | 2 | |
| | | 23205 | 24 | 21.66 | 1 | 20.82 | 2 | |
| | 25 | 23255 | 24 | 21.67 | 1 | 20.64 | 2 | |
| | | 23230 | 24 | 21.73 | 1 | 20.75 | 2 | |
| | | 23205 | 24 | 21.75 | 1 | 20.80 | 2 | |
| | 10MHz | 1H | H | 24 | | 0 | | 1 |
| | | | M | 24 | | 0 | | 1 |
| | | | 23230 | 24 | 22.74 | 0 | 21.98 | 1 |
| | | 1M | H | 24 | | 0 | | 1 |
| | | | M | 24 | | 0 | | 1 |
| | | | 23230 | 24 | 22.90 | 0 | 22.23 | 1 |
| 1L | | H | 24 | | 0 | | 1 | |
| | | M | 24 | | 0 | | 1 | |
| | | 23230 | 24 | 22.74 | 0 | 21.96 | 1 | |
| 25H | | H | 24 | | 1 | | 2 | |
| | | M | 24 | | 1 | | 2 | |
| | | 23230 | 24 | 21.79 | 1 | 20.83 | 2 | |
| 25M | | H | 24 | | 1 | | 2 | |
| | | M | 24 | | 1 | | 2 | |
| | | 23230 | 24 | 21.75 | 1 | 20.86 | 2 | |
| 25L | | H | 24 | | 1 | | 2 | |
| | | M | 24 | | 1 | | 2 | |
| | | 23230 | 24 | 21.69 | 1 | 20.78 | 2 | |
| 50 | | H | 24 | | 1 | | 2 | |
| | | M | 24 | | 1 | | 2 | |
| | | 23230 | 24 | 21.78 | 1 | 20.81 | 2 | |

11.4 Wi-Fi and BT Measurement result

The output power of BT antenna is as following:

Table 11-9 Bluetooth Power

| Bluetooth Power | | | | |
|-----------------|---------|-----------|---------|----------|
| Mode | Channel | Frequency | Tune-up | Measured |
| GFSK | 78 | 2480 MHz | 7 | 6.3 |
| | 39 | 2441 MHz | 7 | 6.92 |
| | 0 | 2402 MHz | 7 | 6.52 |
| EDR2M-4_DQPSK | 78 | 2480 MHz | 6 | 4.95 |
| | 39 | 2441 MHz | 6 | 5.71 |
| | 0 | 2402 MHz | 6 | 5.22 |
| EDR3M-8DPSK | 78 | 2480 MHz | 6 | 5.04 |
| | 39 | 2441 MHz | 6 | 5.82 |
| | 0 | 2402 MHz | 6 | 5.35 |



The average conducted power for Wi-Fi is as following:

Table 11-10 WLAN2450 #1

| WLAN2450 #1 | | | | | | |
|------------------|---------|---------|-----------|-----------|---------|----------|
| Band | Mode | Channel | Frequency | Data Rate | Tune-up | Measured |
| WLAN 2.4G 20M | 802.11b | 11 | 2462 MHz | 1Mbps | 10.00 | 9.78 |
| | | 6 | 2437 MHz | | 11.00 | 10.89 |
| | | 1 | 2412 MHz | | 10.00 | 9.09 |
| | | 11 | 2462 MHz | 2Mbps | / | / |
| | | 6 | 2437 MHz | | 11.00 | 10.56 |
| | | 1 | 2412 MHz | | / | / |
| | | 11 | 2462 MHz | 5.5Mbps | / | / |
| | | 6 | 2437 MHz | | 11.00 | 10.57 |
| | | 1 | 2412 MHz | | / | / |
| | | 11 | 2462 MHz | 11Mbps | / | / |
| | | 6 | 2437 MHz | | 11.00 | 10.54 |
| | | 1 | 2412 MHz | | / | / |
| | 802.11g | 6Mbps | 11 | 2462 MHz | 8.50 | 8.44 |
| | | | 6 | 2437 MHz | 8.50 | 8.39 |
| | | | 1 | 2412 MHz | 8.50 | 7.09 |
| | | 9Mbps | 11 | 2462 MHz | 8.50 | 6.67 |
| | | | 6 | 2437 MHz | / | / |
| | | | 1 | 2412 MHz | / | / |
| | | 12Mbps | 11 | 2462 MHz | 8.50 | 7.46 |
| | | | 6 | 2437 MHz | / | / |
| | | | 1 | 2412 MHz | / | / |
| | | 18Mbps | 11 | 2462 MHz | 8.50 | 7.45 |
| | | | 6 | 2437 MHz | / | / |
| | | | 1 | 2412 MHz | / | / |
| | | 24Mbps | 11 | 2462 MHz | 8.50 | 6.61 |
| | | | 6 | 2437 MHz | / | / |
| | | | 1 | 2412 MHz | / | / |
| | | 36Mbps | 11 | 2462 MHz | 8.50 | 6.54 |
| | | | 6 | 2437 MHz | / | / |
| | | | 1 | 2412 MHz | / | / |
| | | 48Mbps | 11 | 2462 MHz | 8.50 | 7.37 |
| | | | 6 | 2437 MHz | / | / |
| | | | 1 | 2412 MHz | / | / |
| | | 54Mbps | 11 | 2462 MHz | 8.50 | 7.36 |
| | | | 6 | 2437 MHz | / | / |
| | | | 1 | 2412 MHz | / | / |
| | 802.11n | MCS0 | 11 | 2462 MHz | 8.00 | 7.73 |
| | | | 6 | 2437 MHz | 8.00 | 6.95 |
| | | | 1 | 2412 MHz | 8.00 | 6.51 |
| | | MCS1 | 11 | 2462 MHz | 8.00 | 7.62 |
| | | | 6 | 2437 MHz | / | / |
| | | | 1 | 2412 MHz | / | / |
| | | MCS2 | 11 | 2462 MHz | 8.00 | 7.68 |
| | | | 6 | 2437 MHz | / | / |
| | | | 1 | 2412 MHz | / | / |
| | | MCS3 | 11 | 2462 MHz | 8.00 | 7.42 |
| | | | 6 | 2437 MHz | / | / |
| | | | 1 | 2412 MHz | / | / |



| | | | | | | | | |
|------------------|----------------|----|----------|------|----------|------|------|------|
| | 20M | 11 | 2462 MHz | MCS4 | 8.00 | 7.59 | | |
| | | 6 | 2437 MHz | | / | / | | |
| | | 1 | 2412 MHz | | / | / | | |
| | | | | 11 | 2462 MHz | MCS5 | 8.00 | 6.56 |
| | | | | 6 | 2437 MHz | | / | / |
| | | | | 1 | 2412 MHz | | / | / |
| | | | | 11 | 2462 MHz | MCS6 | 8.00 | 6.59 |
| | | | | 6 | 2437 MHz | | / | / |
| | | | | 1 | 2412 MHz | | / | / |
| | | | | 11 | 2462 MHz | MCS7 | 8.00 | 6.31 |
| | | | | 6 | 2437 MHz | | / | / |
| | | | | 1 | 2412 MHz | | / | / |
| WLAN 2.4G 40M | 802.11n 40M | 9 | 2452 MHz | MCS0 | 8.00 | 7.75 | | |
| | | 6 | 2437 MHz | | 8.00 | 7.26 | | |
| | | 3 | 2422 MHz | | 8.00 | 6.99 | | |
| | | | | 9 | 2452 MHz | MCS1 | 8.00 | 7.72 |
| | | | | 6 | 2437 MHz | | / | / |
| | | | | 3 | 2422 MHz | | / | / |
| | | | | 9 | 2452 MHz | MCS2 | 8.00 | 7.69 |
| | | | | 6 | 2437 MHz | | / | / |
| | | | | 3 | 2422 MHz | | / | / |
| | | | | 9 | 2452 MHz | MCS3 | 8.00 | 7.63 |
| | | | | 6 | 2437 MHz | | / | / |
| | | | | 3 | 2422 MHz | | / | / |
| | | | | 9 | 2452 MHz | MCS4 | 8.00 | 7.37 |
| | | | | 6 | 2437 MHz | | / | / |
| | | | | 3 | 2422 MHz | | / | / |
| | | | | 9 | 2452 MHz | MCS5 | 8.00 | 6.39 |
| | | | | 6 | 2437 MHz | | / | / |
| | | | | 3 | 2422 MHz | | / | / |
| | | | | 9 | 2452 MHz | MCS6 | 8.00 | 6.43 |
| | | | | 6 | 2437 MHz | | / | / |
| | | | | 3 | 2422 MHz | | / | / |
| | | | | 9 | 2452 MHz | MCS7 | 8.00 | 6.38 |
| | | | | 6 | 2437 MHz | | / | / |
| | | | | 3 | 2422 MHz | | / | / |

12 Simultaneous TX SAR Considerations

12.1 Introduction

The following procedures adopted from “FCC SAR Considerations for Cell Phones with Multiple Transmitters” are applicable to handsets with built-in unlicensed transmitters such as 802.11 a/b/g and Bluetooth devices which may simultaneously transmit with the licensed transmitter. For this device, the BT and Wi-Fi can transmit simultaneous with other transmitters.

12.2 Transmit Antenna Separation Distances

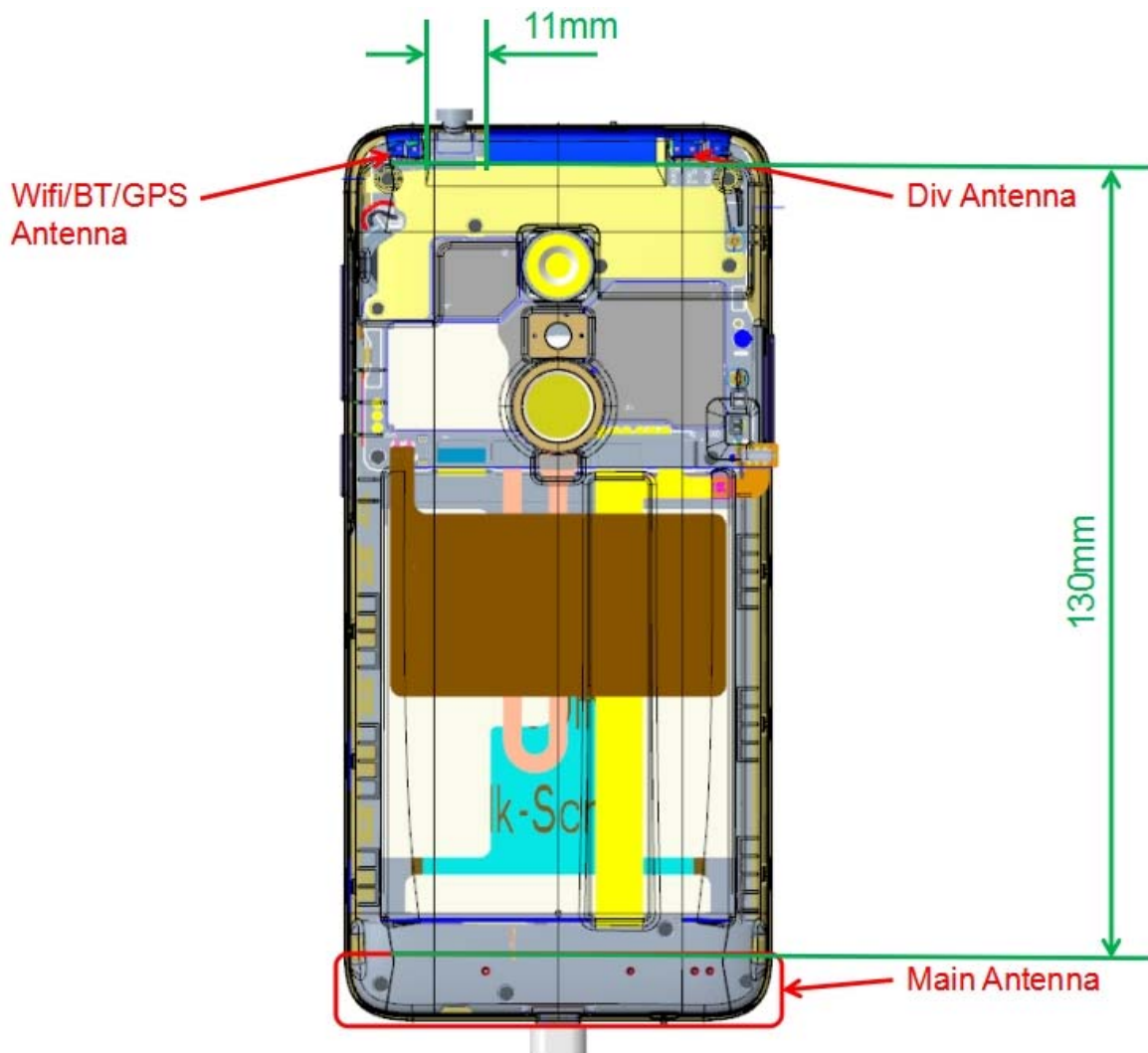

Picture 12.1 Antenna Locations

12.3 SAR Measurement Positions

According to the KDB941225 D06 Hot Spot SAR v01, the edges with less than 2.5 cm distance to the antennas need to be tested for SAR.

| SAR measurement positions | | | | | | |
|---------------------------|-------|------|-----------|------------|----------|-------------|
| Mode | Front | Rear | Left edge | Right edge | Top edge | Bottom edge |
| Main antenna | Yes | Yes | Yes | Yes | No | Yes |
| WLAN | Yes | Yes | No | Yes | Yes | No |

12.4 Standalone SAR Test Exclusion Considerations

Standalone 1-g head or body SAR evaluation by measurement or numerical simulation is not required when the corresponding SAR Exclusion Threshold condition, listed below, is satisfied. The 1-g SAR test exclusion threshold for 100 MHz to 6 GHz at test separation distances ≤ 50 mm are determined by:

$[(\text{max. power of channel, including tune-up tolerance, mW}) / (\text{min. test separation distance, mm})] \cdot [\sqrt{f(\text{GHz})}] \leq 3.0$ for 1-g SAR, where

- $f(\text{GHz})$ is the RF channel transmit frequency in GHz
- Power and distance are rounded to the nearest mW and mm before calculation
- The result is rounded to one decimal place for comparison

Table 12.1: Standalone SAR test exclusion considerations

| Band/Mode | F(GHz) | Position | SAR test exclusion threshold (mW) | RF output power | | SAR test exclusion |
|----------------------|--------|----------|-----------------------------------|-----------------|-------|--------------------|
| | | | | dBm | mW | |
| Bluetooth | 2.441 | Head | 9.6 | 7 | 5.01 | Yes |
| | | Body | 19.2 | 7 | 5.01 | Yes |
| 2.4GHz WLAN 802.11 b | 2.45 | Head | 9.58 | 11 | 12.59 | No |
| | | Body | 19.17 | 11 | 12.59 | Yes |

Note: The result of WLAN Head is lower than 0.01

13 Evaluation of Simultaneous

Table 13.1: The sum of reported SAR values for main antenna and WiFi

| | Position | Main antenna | WiFi | Sum |
|--|------------------------|--------------|-------|-------------|
| Highest reported SAR value for Head | Left hand, Touch cheek | 0.23 | <0.01 | 0.23 |
| Highest reported SAR value for Body | Bottom | 1.27 | / | 1.27 |

Table 13.2: The sum of reported SAR values for main antenna and BT

| | Position | Main antenna | BT | Sum |
|--|------------------------|--------------|------|-------------|
| Maximum reported SAR value for Head | Left hand, Touch cheek | 0.23 | 0.21 | 0.44 |
| Maximum reported SAR value for Body | Bottom | 1.27 | 0.10 | 1.37 |

[1] - Estimated SAR for Bluetooth (see the table 13.3)

Table 13.3: Estimated SAR for WLAN and Bluetooth

| Mode/Band | F (GHz) | Position | Distance (mm) | Upper limit of power * | | Estimated _{1g} (W/kg) |
|-----------|---------|----------|---------------|------------------------|-------|--------------------------------|
| | | | | dBm | mW | |
| Bluetooth | 2.441 | Head | 5 | 7 | 5.01 | 0.21 |
| Bluetooth | 2.441 | Body | 10 | 7 | 5.01 | 0.10 |
| WLAN | 2.441 | Head | 5 | 11 | 12.59 | 0.52 |

* - Maximum possible output power declared by manufacturer

When standalone SAR test exclusion applies to an antenna that transmits simultaneously with other antennas, the standalone SAR must be estimated according to following to determine simultaneous transmission SAR test exclusion:

(max. power of channel, including tune-up tolerance, mW)/(min. test separation distance, mm)·[√f(GHz)/x] W/kg for test separation distances ≤ 50 mm;

where x = 7.5 for 1-g SAR.

When the minimum test separation distance is < 5 mm, a distance of 5 mm is applied to determine SAR test exclusion

Conclusion:

According to the above tables, the sum of reported SAR values is < 1.6W/kg. So the simultaneous transmission SAR with volume scans is not required.

14 SAR Test Result

It is determined by user manual for the distance between the EUT and the phantom bottom.

The distance is 10 mm and just applied to the condition of body worn accessory.

It is performed for all SAR measurements with area scan based 1-g SAR estimation (Fast SAR). A zoom scan measurement is added when the estimated 1-g SAR is the highest measured SAR in each exposure configuration, wireless mode and frequency band combination or more than 1.2W/kg.

The calculated SAR is obtained by the following formula:

$$\text{Reported SAR} = \text{Measured SAR} \times 10^{(P_{\text{Target}} - P_{\text{Measured}})/10}$$

Where P_{Target} is the power of manufacturing upper limit;

P_{Measured} is the measured power in chapter 11.

| Mode | Duty Cycle |
|----------------------------|------------|
| Speech for GSM850/1900 | 1:8.3 |
| GPRS&EGPRS for GSM850/1900 | 1:8.3 |
| WCDMA<E | 1:1 |

14.1 Evaluation of multi-batteries and SIM slots

Note: B1: CAC2400008C1 **B2:** CAC2400009C7

We'll perform the head measurement in all bands with the primary battery depending on the evaluation of multi-batteries retest on highest value point with other battery. Then, repeat the measurement in the Body test.

| frequency | | Mode/Band | Side | Position | BatteryType | 1g SAR (W/kg) | PowerDrift |
|-----------|---------|-----------|-------|----------|--------------|---------------|------------|
| MHz | Channel | | | | | | |
| 1880 | 661 | PCS1900 | Right | Cheek | CAC2400008C1 | 0.139 | 0.08 |
| 1880 | 661 | PCS1900 | Right | Cheek | CAC2400009C7 | 0.154 | 0.15 |

Note: According to the values in the above table, the battery, B2, is the primary

battery. We'll perform the head measurement with this battery and retest on highest value point

with others.

| frequency | | Mode/Band | Position | BatteryType | 1g SAR (W/kg) | PowerDrift |
|-----------|---------|-----------|----------|--------------|---------------|------------|
| MHz | Channel | | | | | |
| 836.6 | 190 | GSM850 | Rear | CAC2400008C1 | 0.292 | 0.11 |
| 836.6 | 190 | GSM850 | Rear | CAC2400009C7 | 0.307 | -0.17 |

Note: According to the values in the above table, the battery, B2, is the primary

battery. We'll perform the Body measurement with this battery and retest on highest value point

with others.

14.2 SAR results

Note: H1: CCB0046A10C1 H2: CCB0046A10C4

Table 14-1 GSM850 #1 Head

| GSM850 #1 Head | | | | | | | | | |
|----------------------|--------------------------|-----------------|---------------------|--------------------|--------------------|---------------------|--------------------|--------------------|------|
| Ambient Temperature: | | | 22.2 | | | Liquid Temperature: | | | 22.1 |
| Mode | Device orientation | SAR measurement | Measured SAR [W/kg] | | | Reported SAR [W/kg] | | | |
| | | | CH251 848.8 MHz | CH190 836.6 MHz | CH128 824.2 MHz | CH251 848.8 MHz | CH190 836.6 MHz | CH128 824.2 MHz | |
| GSM | Tune-up | | 34.00 | 34.00 | 34.00 | Scaling factor* | | | |
| | Slot Average Power [dBm] | | 33.09 | 33.08 | 32.99 | 1.23 | 1.24 | 1.26 | |
| | Left Cheek | 1g SAR | 0.189 | 0.178 | 0.18 | 0.23 | 0.22 | 0.23 | |
| | | 10g SAR | 0.142 | 0.135 | 0.14 | 0.18 | 0.17 | 0.18 | |
| | | Deviation | 0.14 | 0.09 | 0.1 | 0.14 | 0.09 | 0.10 | |
| | Left Tilt | 1g SAR | | 0.105 | | | 0.13 | | |
| | | 10g SAR | | 0.081 | | | 0.10 | | |
| | | Deviation | | -0.04 | | | -0.04 | | |
| | Right Cheek | 1g SAR | | 0.159 | | | 0.20 | | |
| | | 10g SAR | | 0.123 | | | 0.15 | | |
| | | Deviation | | 0.13 | | | 0.13 | | |
| | Right Tilt | 1g SAR | | 0.135 | | | 0.17 | | |
| | | 10g SAR | | 0.105 | | | 0.13 | | |
| | | Deviation | | -0.07 | | | -0.07 | | |
| | GSM B1 | Left Cheek | 1g SAR | 0.163 | | | 0.20 | | |
| 10g SAR | | | 0.117 | | | 0.14 | | | |
| Deviation | | | 0.15 | | | 0.15 | | | |

Table 14-2 GSM850 #1 Body

| GSM850 #1 Body | | | | | | | | | |
|----------------------|--------------------------|-----------------|---------------------|--------------------|--------------------|---------------------|--------------------|--------------------|------|
| Ambient Temperature: | | | 22.2 | | | Liquid Temperature: | | | 22.1 |
| Mode | Device orientation | SAR measurement | Measured SAR [W/kg] | | | Reported SAR [W/kg] | | | |
| | | | CH251 848.8 MHz | CH190 836.6 MHz | CH128 824.2 MHz | CH251 848.8 MHz | CH190 836.6 MHz | CH128 824.2 MHz | |
| GPRS 1 Txslot | Tune-up | | 34.00 | 34.00 | 34.00 | Scaling factor* | | | |
| | Slot Average Power [dBm] | | 33.09 | 33.07 | 32.98 | 1.23 | 1.24 | 1.26 | |
| | Front | 1g SAR | | 0.163 | | | 0.20 | | |
| | | 10g SAR | | 0.125 | | | 0.15 | | |
| | | Deviation | | 0.09 | | | 0.09 | | |
| | Rear | 1g SAR | 0.267 | 0.307 | 0.294 | 0.33 | 0.38 | 0.37 | |
| | | 10g SAR | 0.204 | 0.232 | 0.223 | 0.25 | 0.29 | 0.28 | |
| | | Deviation | -0.09 | -0.17 | -0.1 | -0.09 | -0.17 | -0.10 | |
| | Left edge | 1g SAR | | 0.187 | | | 0.23 | | |
| | | 10g SAR | | 0.125 | | | 0.15 | | |
| | | Deviation | | 0.15 | | | 0.15 | | |
| | Right edge | 1g SAR | | 0.154 | | | 0.19 | | |
| | | 10g SAR | | 0.107 | | | 0.13 | | |
| | | Deviation | | 0.04 | | | 0.04 | | |
| | Bottom edge | 1g SAR | | 0.076 | | | 0.09 | | |
| 10g SAR | | | 0.049 | | | 0.06 | | | |
| Deviation | | | 0.08 | | | 0.08 | | | |
| EGPRS GMSK 1 Txslot | Tune-up | | 34.00 | 34.00 | 34.00 | Scaling factor* | | | |
| | Slot Average Power [dBm] | | 33.09 | 33.07 | 32.98 | 1.23 | 1.24 | 1.26 | |
| | Rear | 1g SAR | | 0.282 | | | 0.35 | | |
| 10g SAR | | | 0.218 | | | 0.27 | | | |
| Deviation | | | 0.02 | | | 0.02 | | | |
| GPRS 1 Txslot B1 | Rear | 1g SAR | | 0.292 | | | 0.36 | | |
| | | 10g SAR | | 0.225 | | | 0.28 | | |
| | | Deviation | | 0.11 | | | 0.11 | | |



Table 14-3 PCS1900 #1 Head

| PCS1900 #1 Head | | | | | | | | | |
|----------------------|--------------------------|-----------------|---------------------|-------------------|-----------------|---------------------|-------------------|-----------------|------|
| Ambient Temperature: | | | 22.2 | | | Liquid Temperature: | | | 22.1 |
| Mode | Device orientation | SAR measurement | Measured SAR [W/kg] | | | Reported SAR [W/kg] | | | |
| | | | CH810 1909.8 | CH661 1880 MHz | CH512 1850.2 | CH810 1909.8 | CH661 1880 MHz | CH512 1850.2 | |
| GSM | Tune-up | | 31.00 | 31.00 | 31.00 | Scaling factor* | | | |
| | Slot Average Power [dBm] | | 30.11 | 30.16 | 30.25 | 1.23 | 1.21 | 1.19 | |
| | Left Cheek | 1g SAR | | 0.109 | | | 0.13 | | |
| | | 10g SAR | | 0.072 | | | 0.09 | | |
| | | Deviation | | 0.02 | | | 0.02 | | |
| | Left Tilt | 1g SAR | | 0.083 | | | 0.10 | | |
| | | 10g SAR | | 0.053 | | | 0.06 | | |
| | | Deviation | | 0.16 | | | 0.16 | | |
| | Right Cheek | 1g SAR | 0.118 | 0.154 | 0.13 | 0.14 | 0.19 | 0.15 | |
| | | 10g SAR | 0.075 | 0.094 | 0.081 | 0.09 | 0.11 | 0.10 | |
| | | Deviation | 0.09 | 0.15 | 0.1 | 0.09 | 0.15 | 0.10 | |
| | Right Tilt | 1g SAR | | 0.067 | | | 0.08 | | |
| | | 10g SAR | | 0.044 | | | 0.05 | | |
| | | Deviation | | -0.14 | | | -0.14 | | |
| | GSM B1 | Right Cheek | 1g SAR | | 0.139 | | | 0.17 | |
| 10g SAR | | | | 0.072 | | | 0.09 | | |
| Deviation | | | | 0.08 | | | 0.08 | | |

Table 14-4 PCS1900 #1 Body

| PCS1900 #1 Body | | | | | | | | | |
|----------------------|--------------------------|--------------------------|---------------------|-------------------|-----------------|---------------------|-------------------|-----------------|------|
| Ambient Temperature: | | | 22.2 | | | Liquid Temperature: | | | 22.1 |
| Mode | Device orientation | SAR measurement | Measured SAR [W/kg] | | | Reported SAR [W/kg] | | | |
| | | | CH810 1909.8 | CH661 1880 MHz | CH512 1850.2 | CH810 1909.8 | CH661 1880 MHz | CH512 1850.2 | |
| GPRS 1 Txslot | Tune-up | | 31.00 | 31.00 | 31.00 | Scaling factor* | | | |
| | Slot Average Power [dBm] | | 30.13 | 30.16 | 30.25 | 1.22 | 1.21 | 1.19 | |
| | Front | 1g SAR | | 0.247 | | | 0.30 | | |
| | | 10g SAR | | 0.135 | | | 0.16 | | |
| | | Deviation | | 0.04 | | | 0.04 | | |
| | Rear | 1g SAR | | 0.607 | | | 0.74 | | |
| | | 10g SAR | | 0.305 | | | 0.37 | | |
| | | Deviation | | 0.13 | | | 0.13 | | |
| | Left edge | 1g SAR | | 0.08 | | | 0.10 | | |
| | | 10g SAR | | 0.047 | | | 0.06 | | |
| | | Deviation | | 0.06 | | | 0.06 | | |
| | Right edge | 1g SAR | | 0.098 | | | 0.12 | | |
| | | 10g SAR | | 0.055 | | | 0.07 | | |
| | | Deviation | | 0.15 | | | 0.15 | | |
| | Bottom edge | 1g SAR | 0.615 | 0.76 | 0.998 | 0.75 | 0.92 | 1.19 | |
| | | 10g SAR | 0.317 | 0.395 | 0.524 | 0.39 | 0.48 | 0.62 | |
| | | Deviation | 0.09 | 0.12 | 0.03 | 0.09 | 0.12 | 0.03 | |
| | EGPRS GMSK 1 Txslot | Tune-up | | 31.00 | 31.00 | 31.00 | Scaling factor* | | |
| | | Slot Average Power [dBm] | | 30.08 | 30.14 | 30.23 | 1.23 | 1.22 | 1.19 |
| | | Bottom edge | 1g SAR | | | 0.976 | | | 1.16 |
| | | | 10g SAR | | | 0.505 | | | 0.60 |
| | Deviation | | | 0.05 | | | 0.05 | | |
| GPRS 1 Txslot B1 | Bottom edge | 1g SAR | | | 0.876 | | | 1.04 | |
| | | 10g SAR | | | 0.441 | | | 0.52 | |
| | Deviation | | | 0.08 | | | 0.08 | | |