



EMI - TEST REPORT

- FCC 15.231 -

Type / Model Name : RKE213U1

Product Description : Radio Frequency Transceiver

Applicant : KATHREIN Automotive GmbH & Co. KG

Address : Römerring 1

31137 Hildesheim

Manufacturer : KATHREIN Automotive Portugal, Sociedade Unipessoal, Lda.

Address : Parque Industrial Constantim

5000-082 Vila Real, Portugal

Licence holder : KATHREIN Automotive GmbH & Co. KG

Address : Römerring 1

31137 Hildesheim

Test Result according to the standards listed in clause 1 test standards:	POSITIVE
---	-----------------

Test Report No. :	T39604-00-00HU	10. June 2015 Date of issue
-------------------	-----------------------	--------------------------------



DAkkS

Deutsche
Akkreditierungsstelle
D-PL-12030-01-01
D-PL-12030-01-02

The test report merely corresponds to the test sample. It is not permitted to copy extracts of these test results without the written permission of the test laboratory.

Contents

1	<u>TEST STANDARDS</u>	3
2	<u>SUMMARY</u>	4
3	<u>EQUIPMENT UNDER TEST</u>	5
3.1	Photo documentation of the EUT – See Attachment A	5
3.2	Power supply system utilised	5
3.3	Short description of the Equipment under Test (EUT)	5
4	<u>TEST ENVIRONMENT</u>	6
4.1	Address of the test laboratory	6
4.2	Statement regarding the usage of logos in test reports	6
4.3	Environmental conditions	6
4.4	Statement of the measurement uncertainty	6
4.5	Measurement Protocol for FCC, VCCI and AUSTEL	7
5	<u>TEST CONDITIONS AND RESULTS</u>	8
5.1	Conducted emissions	8
5.2	Field strength of the fundamental wave	9
5.3	Spurious emissions (magnetic field) 9 kHz – 30 MHz	11
5.4	Spurious emissions radiated (electric field)	13
5.5	Correction for pulse operation (duty cycle)	17
5.6	Emission bandwidth	22
5.7	Signal deactivation	26
6	<u>USED TEST EQUIPMENT AND ACCESSORIES</u>	32

1 TEST STANDARDS

The tests were performed according to following standards:

FCC Rules and Regulations Part 15 Subpart C - Intentional Radiators (October, 2014)

Part 15, Subpart C, Section 15.231	Periodic operation in the band 40.66-40.70 MHz and above 70 MHz §15.231(a) Signal deactivation §15.231(b) Radiated emissions, Fundamental & Harmonics §15.231(c) Emission Bandwidth
Part 15, Subpart C, Section 15.35(c)	Correction for Pulse Operation (Duty Cycle)
Part 15, Subpart C, Section 15.207(a)	AC Line conducted emissions
Part 15, Subpart C, Section 15.209(a)	Radiated emissions, general requirements

FCC Rules and Regulations Part 15 Subpart B - Intentional Radiators (October, 2014)

Part 15, Subpart B, Section 15.107(a)	AC Line conducted emissions
Part 15, Subpart B, Section 15.109(a)	Radiated emissions, general requirements

ANSI C63.4: 2009	Methods of Measurement of Radio-Noise Emissions from Low-Voltage Electrical and Electronic Equipment in the Range of 9 kHz to 40 GHz.
------------------	---

ANSI C95.1:1992	IEEE Standard for Safety Levels with respect to Human Exposure to Radio Frequency Electromagnetic Fields, 3 kHz to 300 GHz
-----------------	--

CISPR 16-4-2: 2003	Uncertainty in EMC measurement
--------------------	--------------------------------

2 SUMMARY

GENERAL REMARKS:

All radiated tests have been performed on a modified sample which are in continuous transmitting mode (modulated and unmodulated).

The values in the test report shows only the maximum measured value.

The other measurements have been performed on a sample which is in original state.

It is not possible to set the EuT only in receiving mode.

Receiver function was tested with complete test setup (test board and handheld transmitter).

This test report covers the complete emissions, Tx and Rx, together.

Declaration from Daimler:

The keyless go system has different sequences and a timely different HF behavior.

The vehicle sends a HF Telegram at different times.

In all cases:

- The duration of the longest HF telegram is 6.7 ms
- In the case if a communication is unsuccessful, it will be repeated 2 times
- The communication will be started with external trigger, for example:
 - o Door handle (has a write-protect, so that these activities can not be repeated)
 - o Push engine start button

For the following considerations a communication "Car closed" was used with repeat requests as worst case within 100ms.

FINAL ASSESSMENT:

The equipment under test **fulfills** the EMI requirements cited in clause 1 test standards.

Date of receipt of test sample : acc. to storage records

Testing commenced on : 29. April 2015

Testing concluded on : 19. May 2015

Checked by:

Tested by:

Klaus Gegenfurtner
Teamleader Radio

Markus Huber

FCC ID: 2ACC7-RKE213U1

3 EQUIPMENT UNDER TEST

3.1 Photo documentation of the EUT – See Attachment A

3.2 Power supply system utilised

Power supply voltage: 13.5 V / DC

3.3 Short description of the Equipment under Test (EUT)

The EuT is a radio frequency transceiver for a keyless entry system for vehicles.
The device sends a signal to a car when the buttons are pushed.

Number of tested samples: 2
Serial number: Prototype

EUT operation mode:

The equipment under test was operated during the measurement under the following conditions:

- Continuous CW transmitting mode at 314.45 MHz, 314.0 MHz, 314.90 MHz

- Continuous CM transmitting mode at 314.45 MHz, 314.0 MHz, 314.90 MHz

- Standby

EUT configuration:

The following peripheral devices and interface cables were connected during the measurements:

- | | |
|----------------|------------------------------|
| - Test antenna | Model : Supplied by KATHREIN |
| - _____ | Model : _____ |
| - _____ | Model : _____ |
| - _____ | Model : _____ |
| - _____ | Model : _____ |
| - _____ | Model : _____ |

4 TEST ENVIRONMENT

4.1 Address of the test laboratory

**CSA Group Bayern GmbH
Ohmstrasse 1-4
94342 STRASSKIRCHEN
GERMANY**

4.2 Statement regarding the usage of logos in test reports

The accreditation and notification body logos displayed in this test report are only valid for standards listed in the accreditation or notification scope of CSA Group Bayern GmbH.

4.3 Environmental conditions

During the measurement the environmental conditions were within the listed ranges:

Temperature: 15-35 ° C

Humidity: 30-60 %

Atmospheric pressure: 86-106 kPa

4.4 Statement of the measurement uncertainty

The data and results referenced in this document are true and accurate. It is noted that the expanded measurement uncertainty corresponds to the measurement results from the standard measurement uncertainty multiplied by the coverage factor $k = 2$. The true value is located in the corresponding interval with a probability of 95 %. The measurement uncertainty was calculated for all measurements listed in this test report acc. to CISPR 16-4-2 / 11.2003 „Uncertainties, statistics and limit modelling – Uncertainty in EMC measurements“ and is documented in the quality system acc. to DIN EN ISO/IEC 17025. For all measurements shown in this report, the measurement uncertainty of the test laboratory, CSA Group Bayern GmbH, is below the measurement uncertainty as defined by CISPR. Therefore, no special measures must be taken into consideration with regard to the limits according to CISPR. Furthermore, component and process variability of devices similar to that tested may result in additional deviation. The manufacturer has the sole responsibility of continued compliance of the device.

4.5 Measurement Protocol for FCC, VCCI and AUSTEL

4.5.1 GENERAL INFORMATION

4.5.1.1 Test Methodology

Conducted and radiated disturbance testing is performed according to the procedures set out by the International Special Committee on Radio Interference (CISPR) Publication 22, European Standard EN 55022 as shown under section 1 of this report.

The test methods used comply with CISPR Publication 22, EN 55022 - "Information technology equipment - Radio disturbance characteristics - Limits and methods of measurement" and with ANSI C63.4 - "Methods of Measurement of Radio-Noise Emissions from Low-Voltage Electrical and Electronic Equipment in the Range of 9 kHz to 40 GHz". In compliance with 47 CFR Part 15 Subpart A, Section 15.38 testing for FCC compliance may be achieved by following the procedures set out in ANSI C63.4 and applying the CISPR 22 limits.

4.5.1.2 Justification

The Equipment Under Test (EUT) is configured in a typical user arrangement in accordance with the manufacturer's instructions. A cable is connected to each available port and either terminated with a peripheral using the appropriate impedance characteristic or left unterminated. Where appropriate, cables are manually manipulated with respect to each other thus obtaining maximum disturbances from the unit.

5 TEST CONDITIONS AND RESULTS

5.1 Conducted emissions

For test instruments and accessories used see section 6 Part A 4.

5.1.1 Description of the test location

Test location: NONE

5.1.2 Photo documentation of the test set-up

5.1.3 Applicable standard

According to FCC Part 15C, Section 15.207(a):

Except as shown in paragraphs (b) and (c) of this Section, for an intentional radiator that is designed to be connected to the public utility (AC) power line, the radio frequency voltage that is conducted back onto the AC power line on any frequency or frequencies within the band 150 kHz to 30 MHz shall not exceed the limits in the following table.

Frequency of Emission (MHz)	Conducted Limit (dB μ V)	
	Quasi-peak	Average
0.15-0.5	66 to 56 *	56 to 46 *
0.5-5	56	46
5-30	60	50

* Decreases with the logarithm of the frequency

5.1.4 Description of Measurement

The measurements are performed on the power interface 120 V / 60 Hz using a receiver, which has CISPR characteristic bandwidth, quasi-peak detection and line impedance stabilization network with 50 Ω /50 μ H (CISPR 16) characteristics. Table top equipment is placed on a non-conducting table 80 cm above the floor and is positioned 40 cm from the vertical ground plane (wall) of the screen room. If the minimum limit margin appears to be less than 20 dB with a peak mode measurement, the emissions are remeasured using a tuned receiver with quasi-peak and average detection and recorded on the data sheets.

To convert between dB μ V and μ V, the following conversions apply:

$$\text{dB}\mu\text{V} = 20 \log \mu\text{V}$$

$$\mu\text{V} = 10^{(\text{dB}\mu\text{V}/20)}$$

5.1.5 Test result

Remarks: The measurement is not applicable.

The EuT has no AC mains connections.

The EuT is separated powered by a 13.5 V vehicle battery.

FCC ID: 2ACC7-RKE213U1

5.2 Field strength of the fundamental wave

For test instruments and accessories used see section 6 Part CPR 2.

5.2.1 Description of the test location

Test location: OATS1

Test distance: 3 metres

5.2.2 Photo documentation of the test set-up

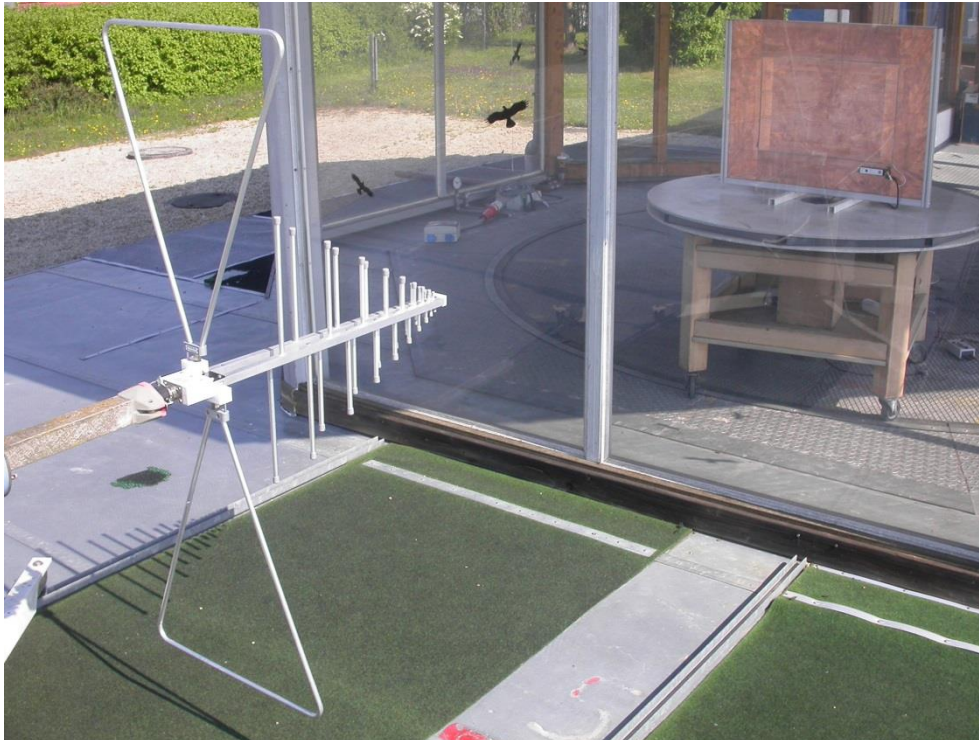

5.2.1 Applicable standard

According to FCC Part 15C, Section 15.231(b):

The field strength of emissions from intentional radiators shall not exceed the effective field strength limits.

5.2.2 Description of Measurement

The radiated power of the fundamental wave from the EUT is measured in the frequency range of 30 to 1000 MHz using a tuned receiver and appropriate broadband linearly polarized antennas. Measurements between 30 MHz and 1000 MHz are made with 120 kHz/6 dB bandwidth and quasi-peak detection. Table top equipment is placed on a 1.0 X 1.5 metres non-conducting table 80 centimetres above the ground plane. Floor standing equipment is placed directly on the turntable/ground plane. The set up of the EUT will be in accordance to ANSI C63.4. The Interface cables that are closer than 40 centimetres to the ground plane are bundled in the centre in a serpentine fashion so they are at least 40 centimetres from the ground plane. Cables to simulators/testers (if used in this test) are routed through the centre of the table and to a screen room located outside the test area. The antenna was positioned 3, 10 or 30 metres horizontally from the EUT. To locate maximum emissions from the test sample the antenna is varied in height from 1 to 4 metres, measurement scans are made in horizontal and vertical antenna polarization's and the EUT is rotated 360 degrees.

FCC ID: 2ACC7-RKE213U1

The resolution bandwidth during the measurement is as follows:

30 MHz – 1000 MHz: RBW: 120 kHz

Example:

Frequency (MHz)	Level (dB μ V)	+	Factor (dB)	=	Level dB(μ V/m)	-	Limit dB(μ V/m)	=	Delta (dB)
170.5	5	+	20	=	25	-	30	=	-5

5.2.3 Test result

Frequency (MHz)	Level Pk (dB μ V)	Level QP (dB μ V)	Bandwidth (kHz)	Correct. factor (dB)	Duty Cycle Correct. factor (dB)	Corrected Pk level dB(μ V/m)	Effective limit dB(μ V/m)	Delta (dB)
314.00	78.2	--	120	17.3	-20.5	75.0	75.56	-0.6
314.45	77.5	--	120	17.4	-20.5	74.4	75.59	-1.2
314.90	78.0	--	120	17.4	-20.5	74.9	75.62	-0.7

Limit according to FCC Section 15.231(b):

Frequency (MHz)	Field strength of fundamental @ 3m		Effective limit for 315.0 MHz	
	(μ V/m)	dB(μ V/m)	(μ V/m)	dB(μ V/m)
40.66 – 40.70	2250	67		
70 - 130	1250	62		
130 - 174	1250 to 3750*	62 to 71.4*		
174 - 260	3750	71.4		
260 - 470	3750 to 12500*	71.4 to 81.9*	6041.67	75.62
Above 470	12500	81.9		

*Linear interpolation

The requirements are **FULFILLED**.

Remarks: The level of fundamental wave from the EuT is identical independent of the button
of the handheld key which was pushed.
The measurement was performed with the modified test sample in continuous transmitting mode.

FCC ID: 2ACC7-RKE213U1

5.3 Spurious emissions (magnetic field) 9 kHz – 30 MHz

For test instruments and accessories used see section 6 Part SER 1.

5.3.1 Description of the test location

Test location: OATS1

Test distance: 3 metres

5.3.2 Photo documentation of the test set-up

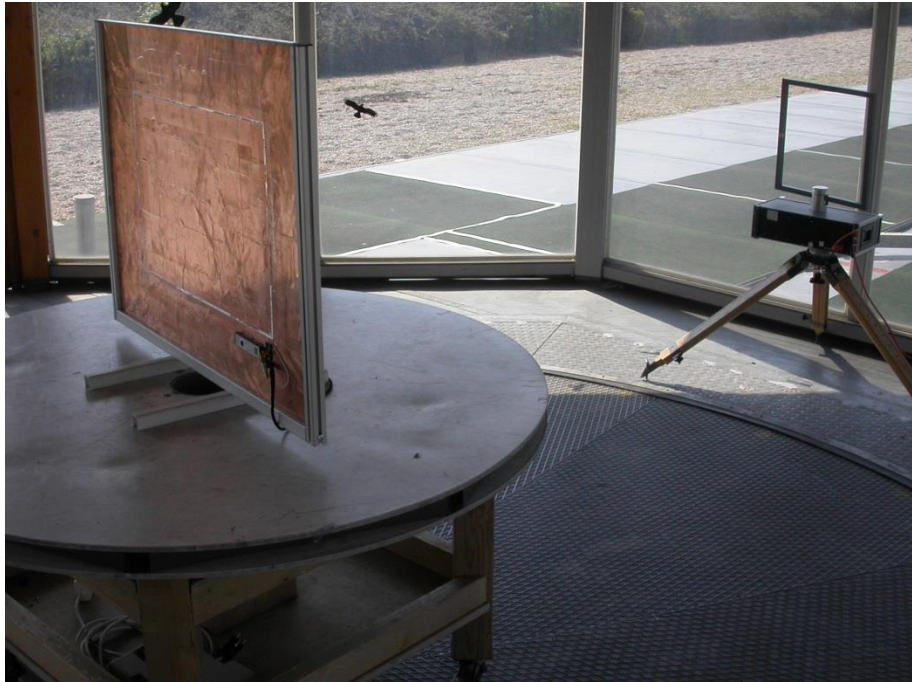

5.3.3 Applicable standard

According to FCC Part 15C, Section 15.209:

The emissions from intentional radiators shall not exceed the effective field strength limits.

5.3.4 Description of Measurement

The magnetic field strength from the EUT will be measured on an open area test site in the frequency range of 9 kHz to 30 MHz using a tuned receiver and a shielded loop antenna. The set up of the Equipment under test will be in accordance to ANSI C63.4. The antenna was positioned 3, 10 or 30 meters horizontally from the EUT. Measurements have been made in all three orthogonal axes and the shielded loop antenna was rotated to locate the maximum of the emissions. In the case where larger measuring distances are required the results will extrapolated based on the values measured on the closer distances according to Section 15.31(f)(2)(2). The final measurement will be performed with an EMI Receiver set to Quasi Peak detector except for the frequency bands 9 kHz to 90 kHz and 110 to 490 kHz where an average detector will be used according to Section 15.209(d)(2).

FCC ID: 2ACC7-RKE213U1

The resolution bandwidth during the measurement is as follows:

9 kHz – 150 kHz: RBW: 200 Hz

150 kHz – 30 MHz: RBW: 9 kHz

Example:

$$\begin{array}{rclclclclcl}
 \text{Frequency} & & \text{Level} & + & \text{Factor} & = & \text{Level} & - & \text{Limit} & = & \text{Delta} \\
 \text{(MHz)} & & \text{(dB}\mu\text{V)} & & \text{(dB)} & & \text{dB}(\mu\text{V/m)} & & \text{dB}(\mu\text{V/m)} & & \text{(dB)} \\
 1.705 & & 5 & + & 20 & = & 25 & - & 30 & = & -5
 \end{array}$$

5.3.5 Test result

Measurement distance: 3 m

Frequency [kHz]	L: QP [dB μ V]	L: AV [dB μ V]	Bandwidth [kHz]	Correct. [dB]	L: QP [dB μ V/m]	L: AV [dB μ V/m]	Limit [dB μ V/m]	Delta [dB]
536.8	24.1	19.7	9.0	20	44.1	39.7	73.0	-33.3
1073.6	23.4	18.0	9.0	20	43.4	38.0	67.0	-29.0
1342.0	21.6	15.9	9.0	20	41.6	35.9	65.0	-29.1

Note: No unwanted emissions from the EuT could be measured in the relevant frequency ranges and the test antenna with the power setting. Only ambient noises could be detected!

Limit according to FCC Part 15C Section 15.209(a):

Frequency (MHz)	Field strength of spurious emissions		Measurement distance (metres)
	(μ V/m)	dB(μ V/m)	
0.009-0.490	2400/F(kHz)	--	300
0.490-1.705	24000/F (kHz)	--	30
1.705-30.0	30	29.5	30

The requirements are **FULFILLED**.

Remarks: All unwanted emissions in the frequency range from 9 kHz to 30 MHz are below 10 dB μ V/m at a test distance of 3 metres.

The measurement was performed with the modified test sample in continuous transmitting mode.

FCC ID: 2ACC7-RKE213U1

5.4 Spurious emissions radiated (electric field)

For test instruments and accessories used see section 6 Part SER 2, SER 3.

5.4.1 Description of the test location

Test location: OATS1
Anechoic Chamber A1

Test distance: 3 metres

5.4.2 Photo documentation of the test set-up

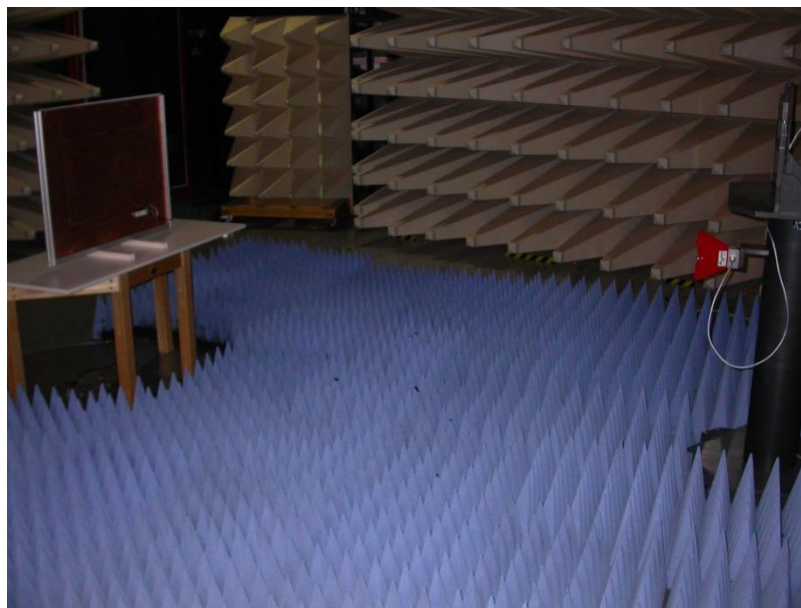
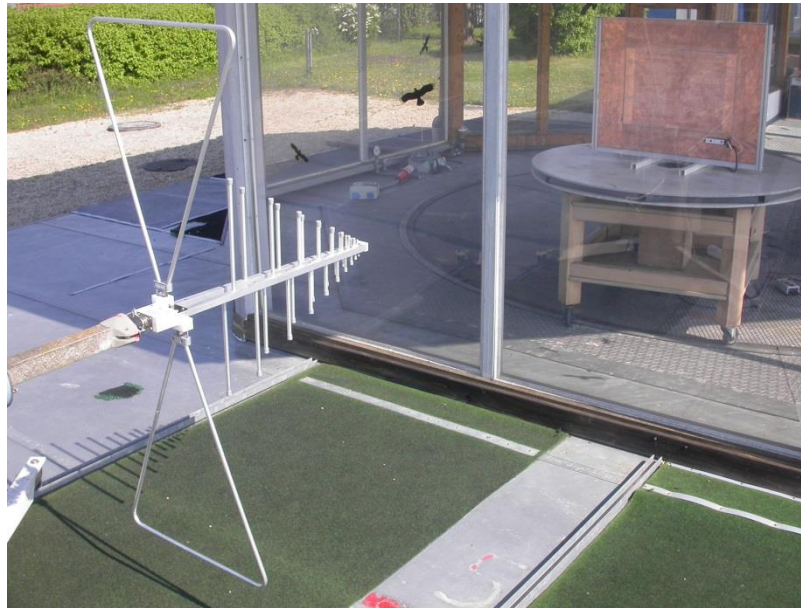

FCC ID: 2ACC7-RKE213U1

5.4.3 Applicable standard

According to FCC Part 15C, Section 15.231(b), Section 15.209(a) and Section 15.205(a):
The emissions from intentional radiators shall not exceed the effective field strength limits.

5.4.4 Description of Measurement

The radiated power of the spurious emission from the EUT is measured in the frequency range of 30 to 1000 MHz using a tuned receiver and appropriate broadband linearly polarized antennas. Measurements between 30 MHz and 1000 MHz are made with 120 kHz/6 dB bandwidth and quasi-peak detection. Table top equipment is placed on a 1.0 X 1.5 m non-conducting table 80 cm above the ground plane. Floor standing equipment is placed directly on the turntable ground plane. The set up of the EUT will be in accordance to ANSI C63.4. The interface cables closer than 40 cm to the ground plane are bundled in the centre in a serpentine fashion so they are at least 40 cm away from the ground plane. Cables to simulators/testers are routed through the centre of the table to a screen room located outside the test area. To locate maximum emission from the test sample the antenna is varied in height from 1 to 4 m, measurement scans are made in horizontal and vertical antenna polarization and the EUT is turned 360 degrees.

The radiated power of the spurious emission from the EUT is measured in the frequency range above 1 GHz using a spectrum analyser and appropriate linear polarised antennas. Measurements are made in the horizontal and vertical polarization of the antenna. The set up of the EUT will be in accordance to ANSI C63.4. The interface cables closer than 40 cm to the ground plane are bundled in the centre in a serpentine fashion so they are at least 40 cm away from the ground plane. Hand-held or body-worn devices are rotated through three orthogonal axes to determine which attitude and configuration results in the highest emission and therefore shall be used for final testing. During the tests the EUT is turned 360 degrees to find the maximum level of emission. For testing above 1 GHz, if the emission level of the EUT in peak mode complies with the average limit is 20 dB lower, then testing will be stopped and peak values of the EUT will be reported, otherwise the emission will be measured in average mode again and reported.

The resolution bandwidth during the measurement is as follows:

30 MHz – 1000 MHz: RBW: 120 kHz
1000 MHz – 18000 MHz RBW: 1 MHz

Example:

Frequency (MHz)	Level (dB μ V)	+	Factor (dB)	=	Level dB(μ V/m)	-	Limit dB(μ V/m)	=	Delta (dB)
170.5	5	+	20	=	25	-	30	=	-5

5.4.5 Test result f < 1 GHz

CH 3 – 314.45 MHz:

Frequency (MHz)	Level Pk (dB μ V)	Level QP (dB μ V)	Bandwidth (kHz)	Correct. factor (dB)	Corrected QP level dB(μ V/m)	Effective limit dB(μ V/m)	Delta (dB)
628.90	--	3.8	120	26.1	29.9	55.59	- 25.7
943.35	--	4.1	120	31.9	36.0	55.59	- 19.6

FCC ID: 2ACC7-RKE213U1
5.4.6 Test result f > 1 GHz

CH3 – 314.45 MHz:

Frequency (MHz)	L: PK (dB μ V)	Bandwidth (kHz)	Correct. (dB)	Duty Cycle Correct. factor (dB)	Corrected Pk level dB(μ V/m)	Effective limit dB(μ V/m)	Delta (dB)
1257.80	56.2	1000	-19.6	-20.5	16.1	55.59	-39.5
1572.25	56.4	1000	-21.1	-20.5	14.8	55.59	-40.8
1886.70	55.3	1000	-16.6	-20.5	18.2	55.59	-37.4
2201.15	54.1	1000	-16.6	-20.5	17.0	55.59	-38.6
2515.60	53.6	1000	-14.2	-20.5	18.9	55.59	-36.7
2830.05	54.6	1000	-13.7	-20.5	20.4	55.59	-35.2
3144.50	53.6	1000	-12.8	-20.5	20.3	55.59	-35.3
3458.95	54.6	1000	-12.9	-20.5	21.2	55.59	-34.4
3773.40	55.3	1000	-12.4	-20.5	22.4	55.59	-33.2

Limit according to FCC Section 15.231(b), Section 15.209(a) and Section 15.205(a):

Frequency (MHz)	Field strength of spurious emissions @ 3m		Effective limit for 314.45 MHz	
	(μ V/m)	dB(μ V/m)	(μ V/m)	dB(μ V/m)
40.66 – 40.70	225	47		
70 - 130	125	42		
130 - 174	125 to 375*	42 to 51.4*		
174 - 260	375	51,4		
260 - 470	375 to 1250*	51.4 to 61.9*	601.88	55.59
Above 470	1250	61.9		

*Linear interpolation

Spurious emissions shall be attenuated to the average (or, alternatively, CISPR quasi-peak) limits shown in the table above or to the general limits shown in the table below according to § 15.209, whichever limit permits a higher field strength.

Frequency (MHz)	15.209 Limits (μ V/m)	15.209 Limits dB(μ V/m)
30 - 88	100	40
88 - 216	150	43.5
216 - 960	200	46
Above 960	500	54

Additionally there is a limit according to §15.35(b) on the radio frequency emissions, as measured with a peak detector, corresponding to 20 dB above the maximum permitted average limits.

FCC ID: 2ACC7-RKE213U1

Restricted bands of operation according to FCC Part 15C, Section 15.205(a):

The field strength of emissions appearing within these frequency bands shall not exceed the limits shown in Section 15.209

MHz	MHz	MHz	GHz
0.090 – 0.110	16.42 – 16.423	399.9 – 410	4.5 – 5.15
0.495 – 0.505	16.69475 – 16.69525	608 – 614	5.35 – 5.46
2.1735 – 2.1905	16.80425 – 16.80475	960 – 1240	7.25 – 7.75
4.125 – 4.128	25.5 – 25.67	1300 – 1427	8.025 – 8.5
4.17725 – 4.17775	37.5 – 38.25	1435 – 1626.5	9.0 – 9.2
4.20725 – 4.20775	73 – 74.6	1645.5 – 1646.5	9.3 – 9.5
6.215 – 6.218	74.8 – 75.2	1660 – 1710	10.6 – 12.7
6.26775 – 6.26825	108 – 121.94	1718.8 – 1722.2	13.25 – 13.4
6.31175 – 6.31225	123 – 138	2200 – 2300	14.47 – 14.5
8.291 – 8.294	149.9 – 150.05	2310 – 2390	15.35 – 16.2
8.362 – 8.366	156.52475 – 156.52525	2483.5 – 2500	17.7 – 21.4
8.37625 – 8.38675	156.7 – 156.9	2690 – 2900	22.01 – 23.12
8.41425 – 8.41475	162.0125 – 167.17	3260 – 3267	23.6 – 24.0
12.29 – 12.293	167.72 – 173.2	3332 – 3339	31.2 – 31.8
12.51975 – 12.52025	240 – 285	3345.8 – 3358	36.43 – 36.5
12.57675 – 12.57725	322 – 335.4	3600 – 4400	Above 38.6

The requirements are **FULFILLED**.

Remarks: The measurement was performed with the modified test sample in continuous transmitting mode.

FCC ID: 2ACC7-RKE213U1

5.5 Correction for pulse operation (duty cycle)

5.5.1 Description of the test location

Test location: Daimler / Sindelfingen

5.5.2 Photo documentation of the test set-up

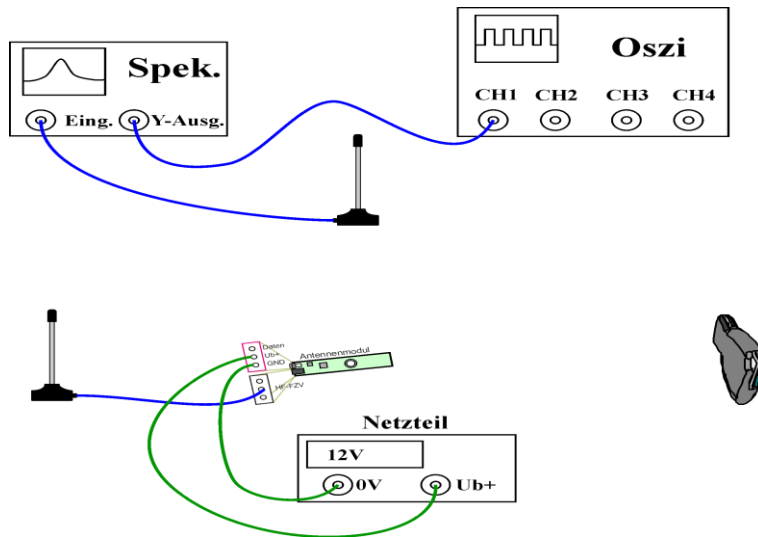

5.5.3 Applicable standard

According to FCC Part 15C, Section 15.35(c):

The emissions from intentional radiators shall not exceed the effective field strength limits.

5.5.4 Test result

The Duty cycle factor (dB) is calculated applying the following formula:

$$KE = 20 \log \left(\frac{t_{dB}}{100} \right)$$

KE: pulse operation correction factor (dB)
 t_{dB}: pulse duration for one pulse (ms)

Maximum transmitting duration in every 100ms period:

$$KE = 20 \log \left(\frac{6.7ms + 2.7ms}{100} \right) = -20.5 \text{ dB}$$

Remarks: For detailed results, please see the test protocol below.

Test was performed from M. Reinhardt at Daimler / Sindelfingen.

FCC ID: 2ACC7-RKE213U1

5.5.5 Test protocol

Correction for pulse operation (duty cycle)
FCC Part 15C, Section 15.35(c)

Complete telegram:

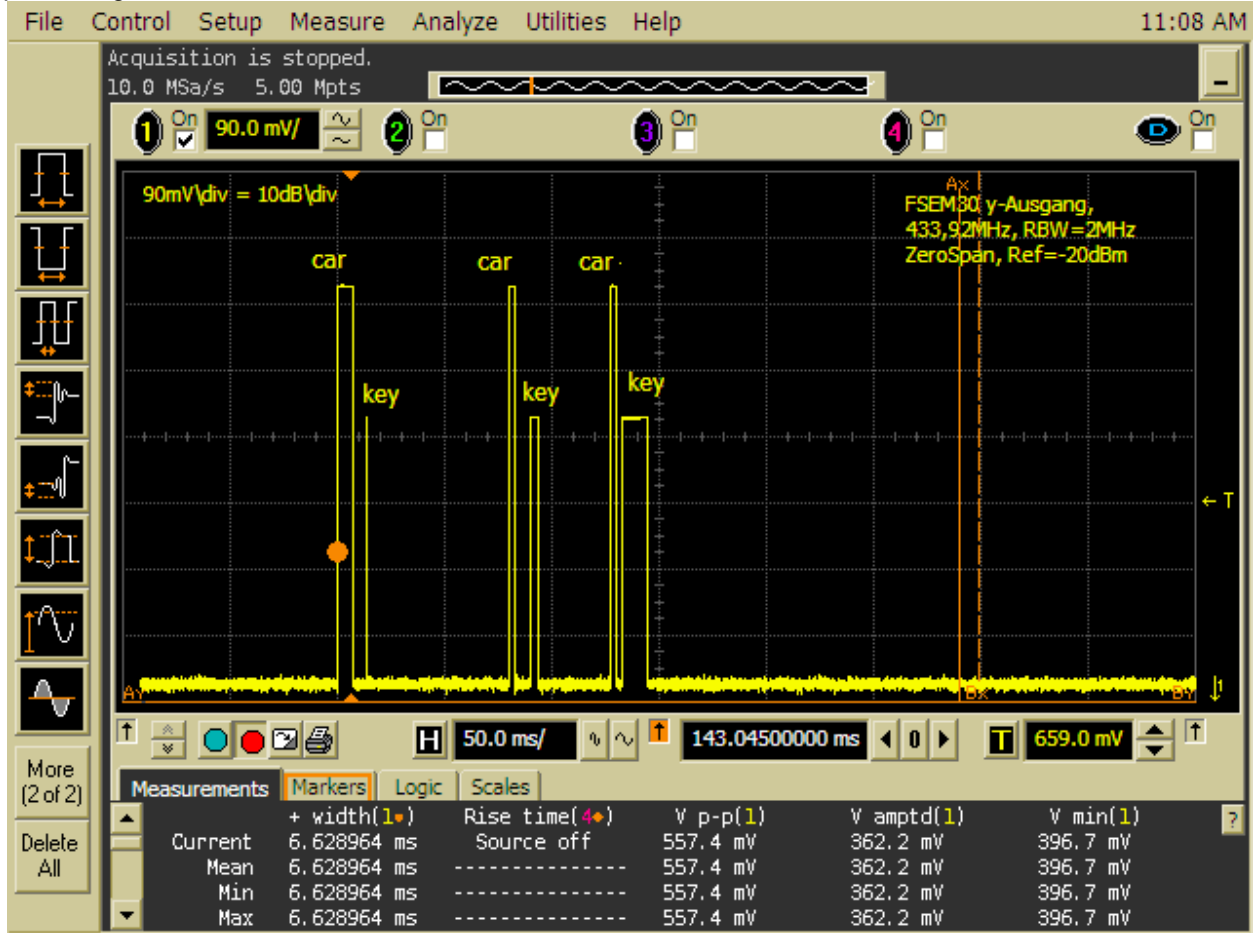

FCC ID: 2ACC7-RKE213U1

First HF-Telegramm vehicle (6.7 ms)

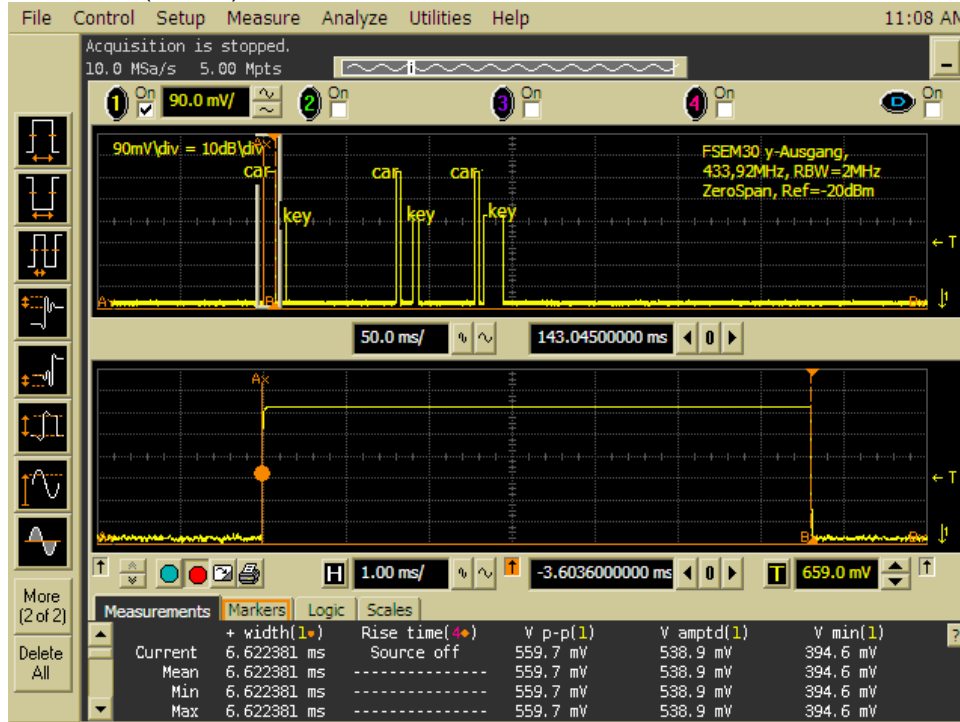

100 ms time window in the range of the first HF-Telegramm

Both Marker show the 100 ms time window.

-> 2 HF-Telegramms which were generated by the vehicle are inside the 100 ms.

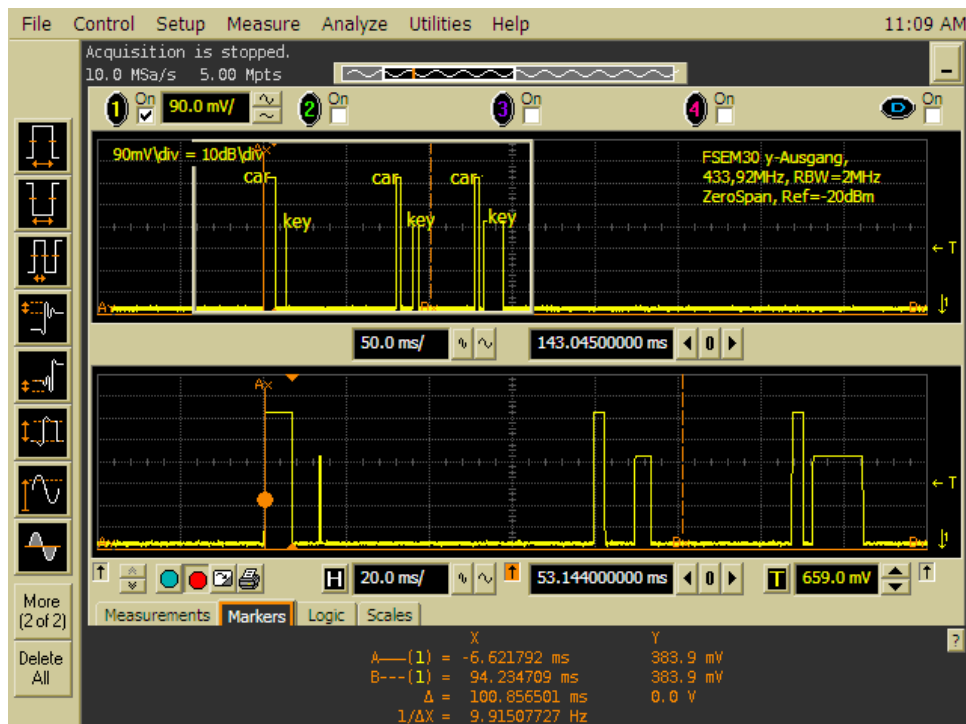

FCC ID: 2ACC7-RKE213U1

Second HF-Telegramm vehicle (2.7 ms)

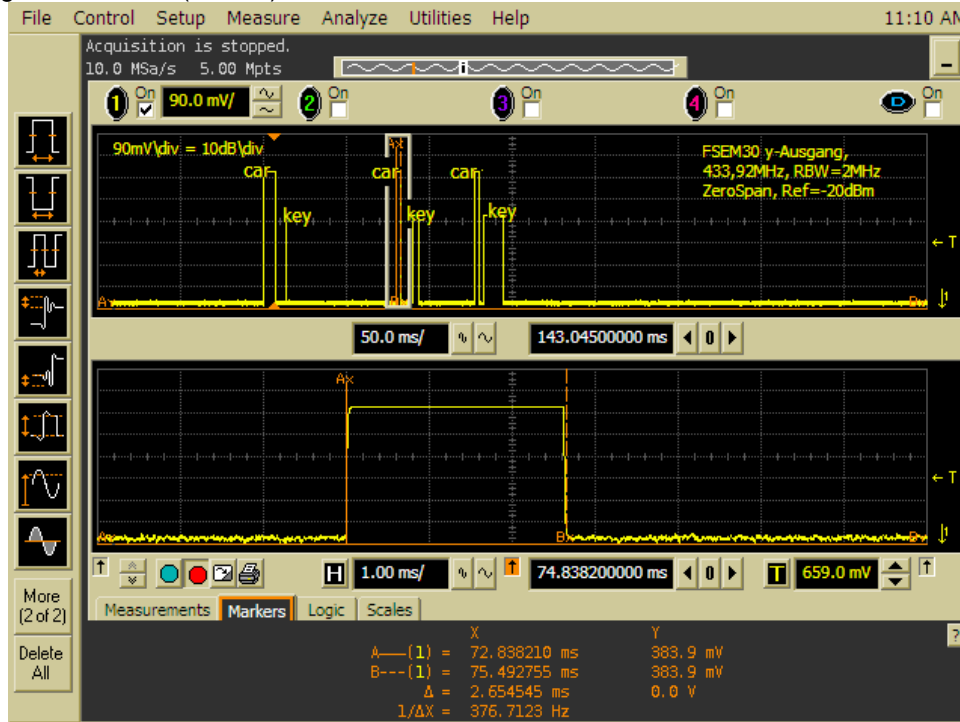

100 ms time window in the range of the first HF-Telegramm

Both Marker show the 100 ms time window.

-> 2 HF-Telegramms which were generated by the vehicle are inside the 100 ms.

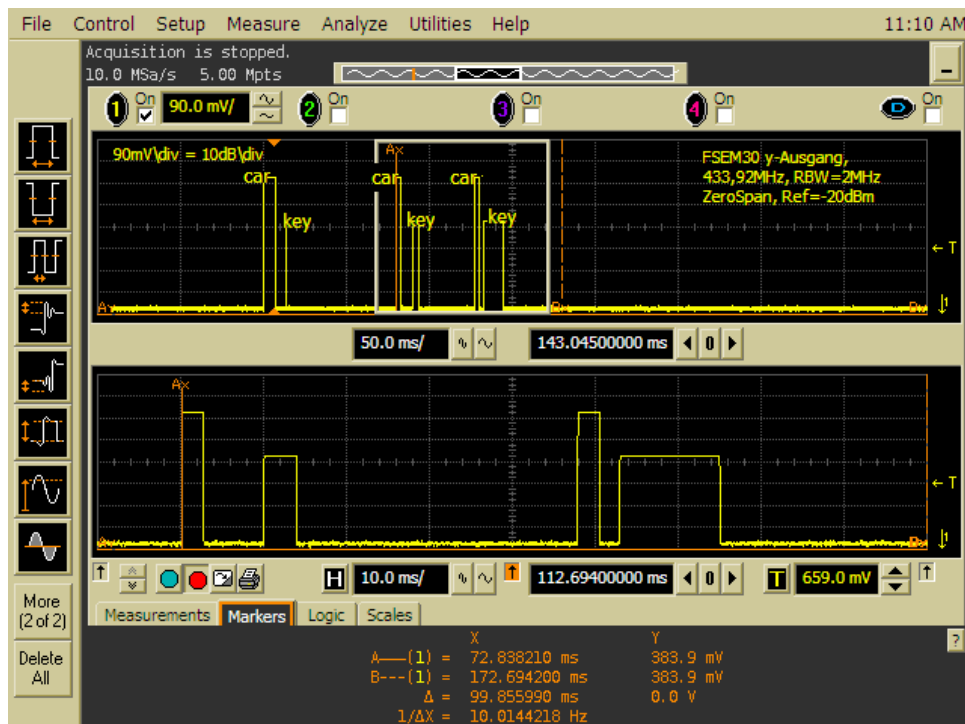

FCC ID: 2ACC7-RKE213U1

Third HF-Telegramm vehicle (2.7 ms)

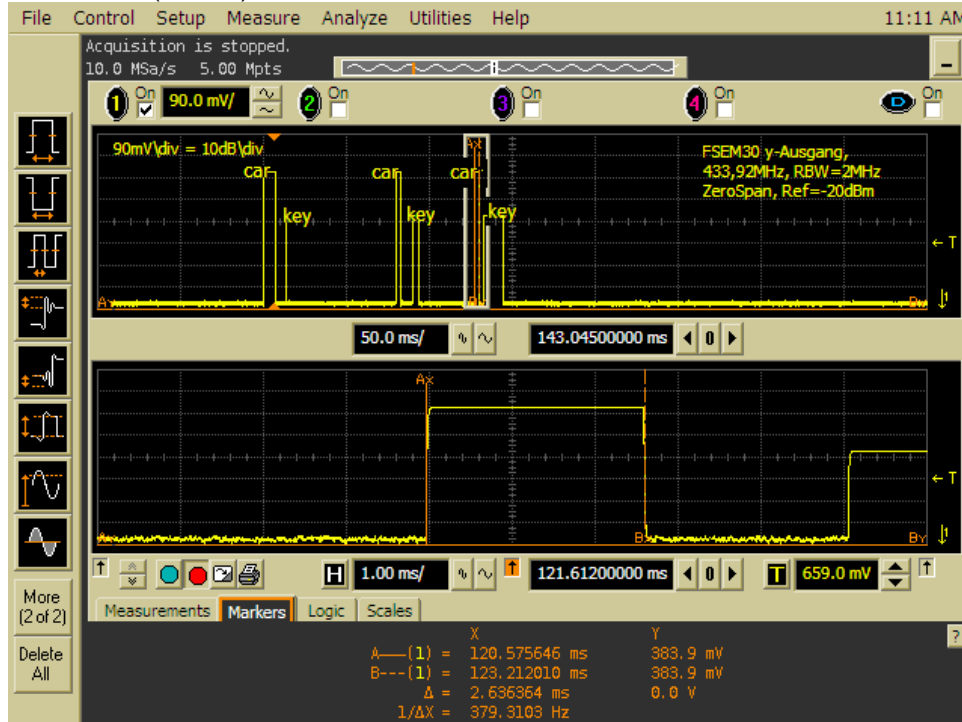

Correction factor (-20.5 dB)

$$(1) \quad DC = \frac{6,7 \text{ ms} + 2,7 \text{ ms}}{100 \text{ ms}} = 9,4\%$$

⇒ Below 10 %.

FCC ID: 2ACC7-RKE213U1

5.6 Emission bandwidth

For test instruments and accessories used see section 6 Part MB.

5.6.1 Description of the test location

Test location: AREA4

5.6.2 Photo documentation of the test set-up

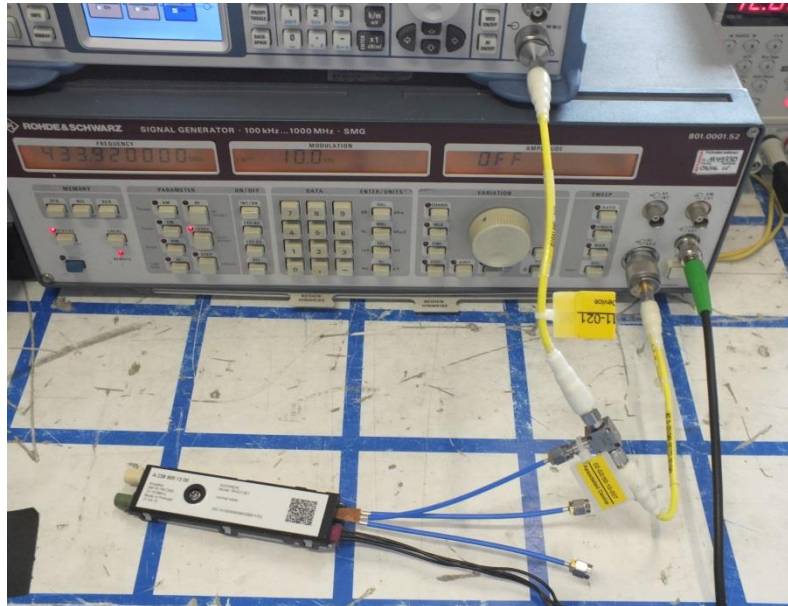

5.6.3 Applicable standard

According to FCC Part 15C, Section 15.231(c):
The bandwidth of the emission shall not exceed the effective limits.

5.6.4 Description of Measurement

The measurement was performed conducted with intentional modulation using a spectrum analyser. The analyser span was set wide enough to capture the most of the power envelope of the signal. The function "20-dB-down" is used to determine the BW. For an overview on the adjacent restricted bands the span was set as wide as needed to show that the restricted bands are not affected.

FCC ID: 2ACC7-RKE213U1
5.6.5 Test result

Fundamental [MHz]	20dB Bandwidth F1 [MHz]	20dB Bandwidth F2 [MHz]	Measured Bandwidth [MHz]	LIMIT Fundamental f*0,0025 [MHz]
314.00	313.9664	314.0322	0.0658	0.785

Fundamental [MHz]	20dB Bandwidth F1 [MHz]	20dB Bandwidth F2 [MHz]	Measured Bandwidth [MHz]	LIMIT Fundamental f*0,0025 [MHz]
314.90	314.865	314.931	0.0651	0.787

Fundamental [MHz]	20dB Bandwidth F1 [MHz]	20dB Bandwidth F2 [MHz]	Measured Bandwidth [MHz]	LIMIT Fundamental f*0,0025 [MHz]
314.45	314.4157	314.4815	0.0658	0.786

Limit according to FCC Part 15C Section 15.231©:

Frequency (MHz)	20 dB BW limit dependent of the carrier (%)
70 – 900	0.25
above 900	0.50

The bandwidth of the emission shall be no wider than 0.25% of the centre frequency for devices operating above 70 MHz and below 900 MHz. Bandwidth is determined at the points 20 dB down from the modulated carrier.

The requirements are **FULFILLED**.

Remarks: For detailed results, please see the test protocol below.

FCC ID: 2ACC7-RKE213U1

5.6.6 Test protocol

Emission bandwidth
FCC Part 15C, Section 15.231

CH 1:

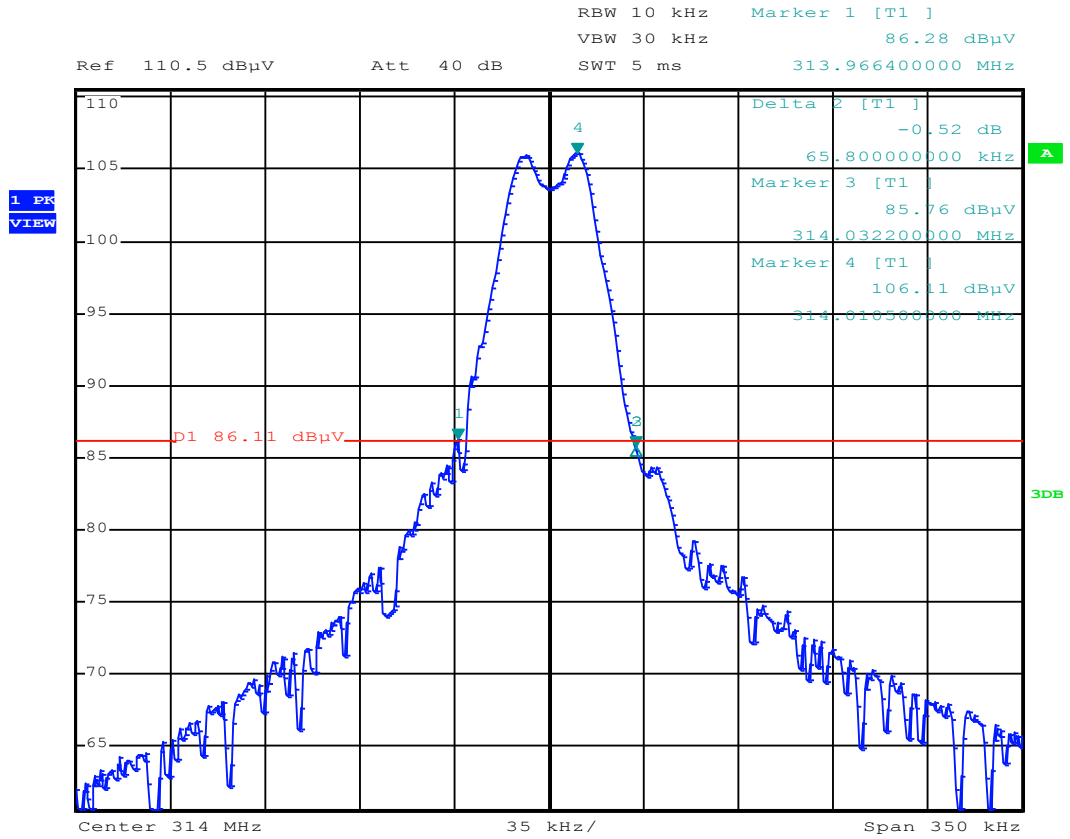

FCC ID: 2ACC7-RKE213U1

CH 2:

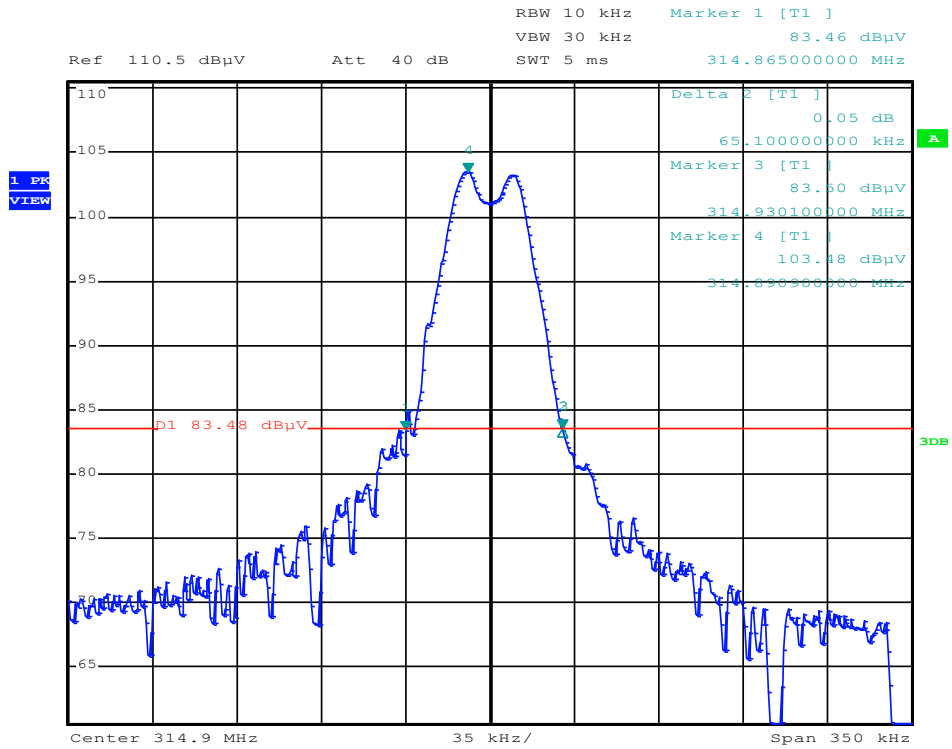

CH 3:

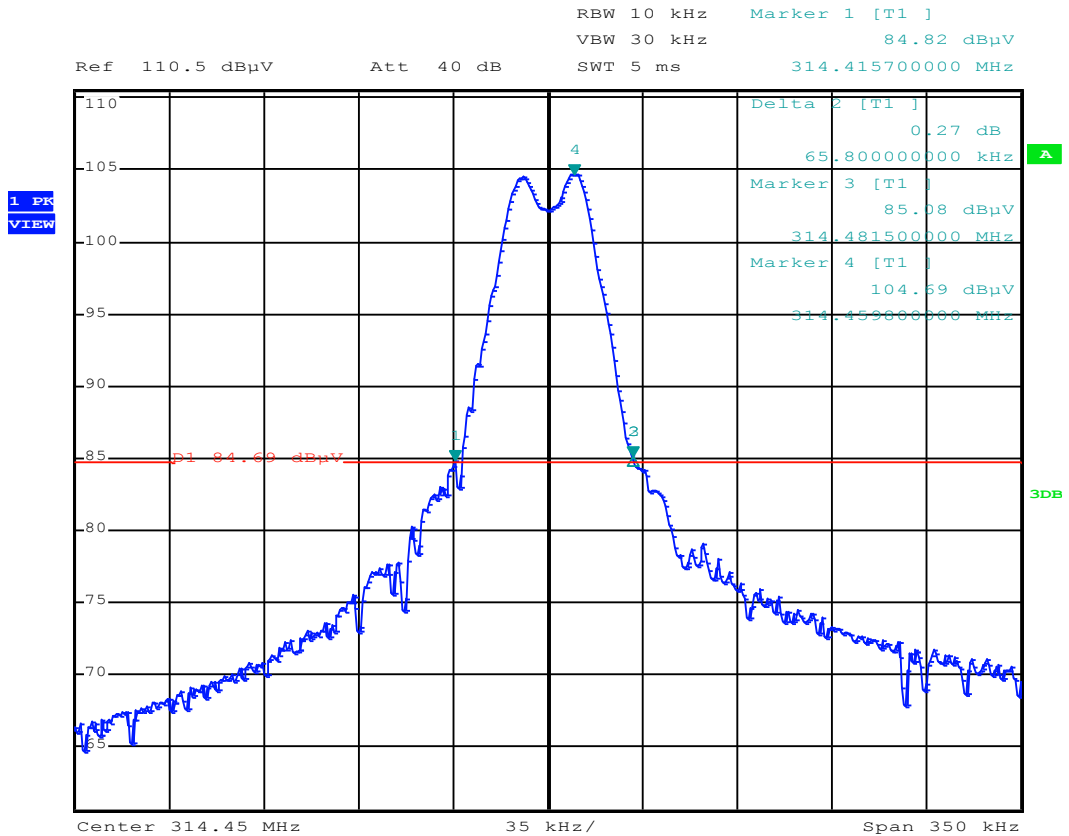

5.7 Signal deactivation

5.7.1 Description of the test location

Test location: Daimler / Sindelfingen

5.7.2 Photo documentation of the test set-up

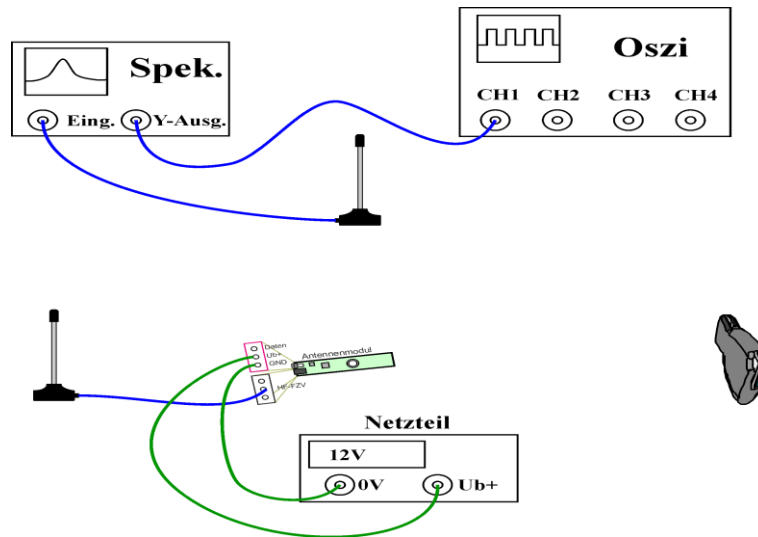

5.7.3 Applicable standard

According to FCC Part 15C, Section 15.231(a)(1):

A manually operated transmitter shall employ a switch that will automatically deactivate the transmitter not exceeding the defined on time limit.

5.7.4 Description of Measurement

The duration of transmission is measured with the spectrum analyzer. The sweep points were set to maximum for higher the time resolution. The signal is modulated; the marker of the analyzer is set to maximum amplitude at normal temperature and zero span. The analyser was set to single sweep and triggered on the button, the marker was set to the edges in order to measure the duration time and then recorded.

FCC ID: 2ACC7-RKE213U1**5.7.5 Test result**

Duration of transmission (ms)
9.4

Limit according to FCC Part 15 Subpart 15.231(a):

A manually operated transmitter shall employ a switch that will automatically deactivate the transmitter within not more than 5 seconds of being released and a transmitter activated automatically shall cease transmission within 5 seconds after activation.

The requirements are **FULFILLED**.

Remarks: For detailed results, please see the test protocol below.

Test was performed from M. Reinhardt at Daimler / Sindelfingen.

FCC ID: 2ACC7-RKE213U1

5.7.6 Test protocol

Signal deactivation
FCC Part 15C, Section 15.231(a)

Complete telegram:

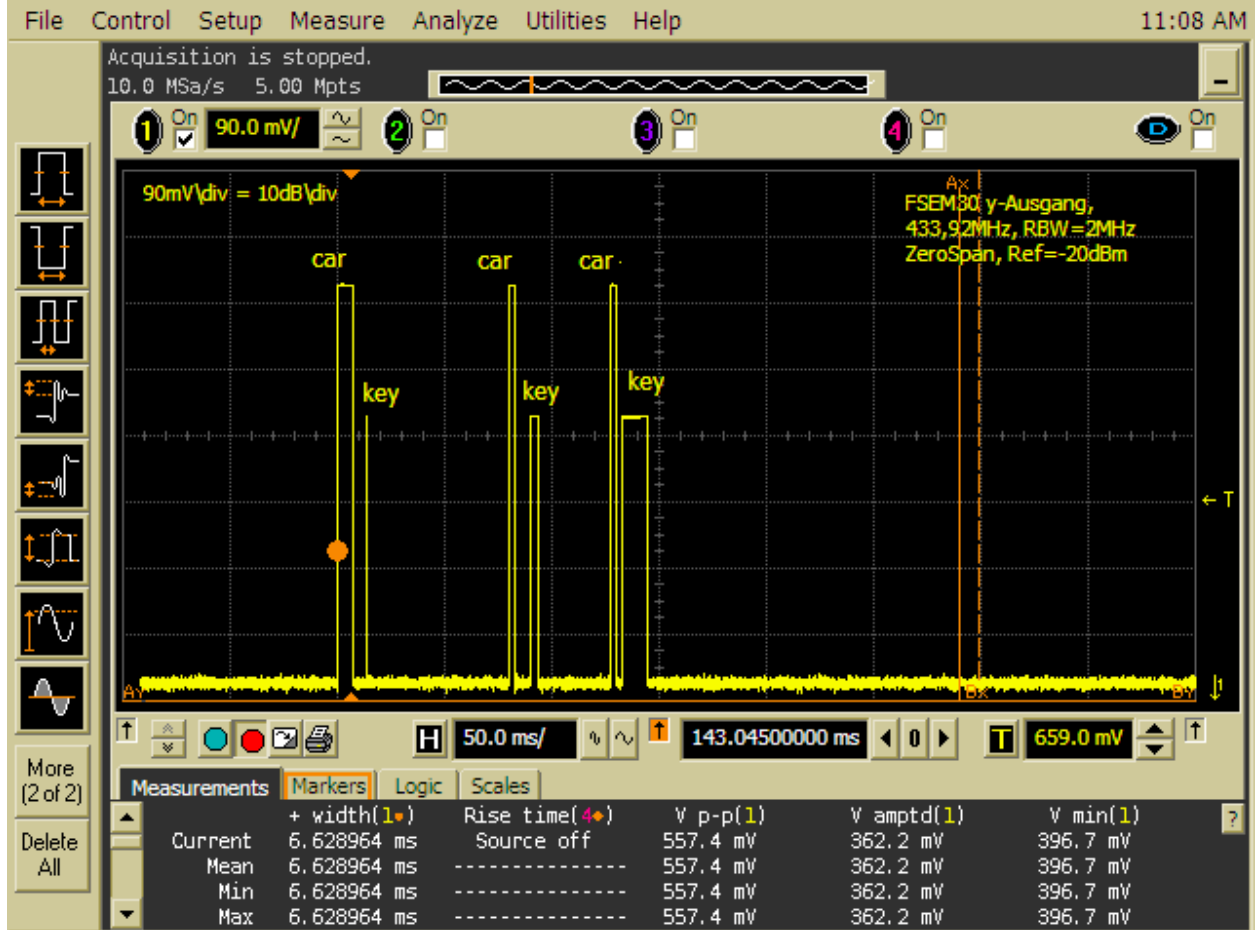

FCC ID: 2ACC7-RKE213U1

First HF-Telegramm vehicle (6.7 ms)

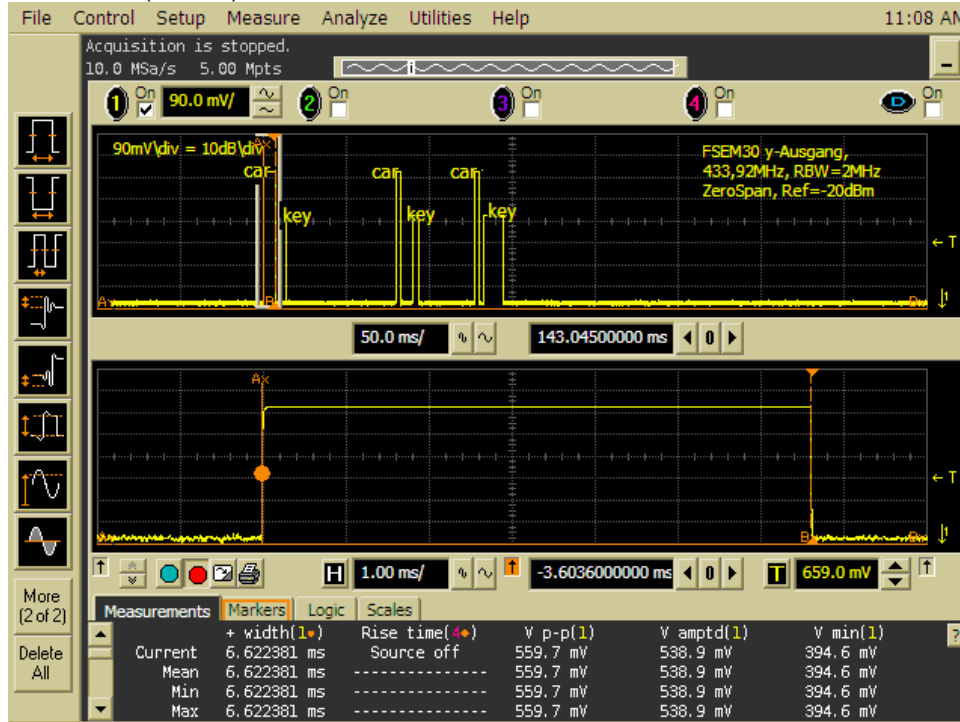

100 ms time window in the range of the first HF-Telegramm

Both Marker show the 100 ms time window.

-> 2 HF-Telegramms which were generated by the vehicle are inside the 100 ms.

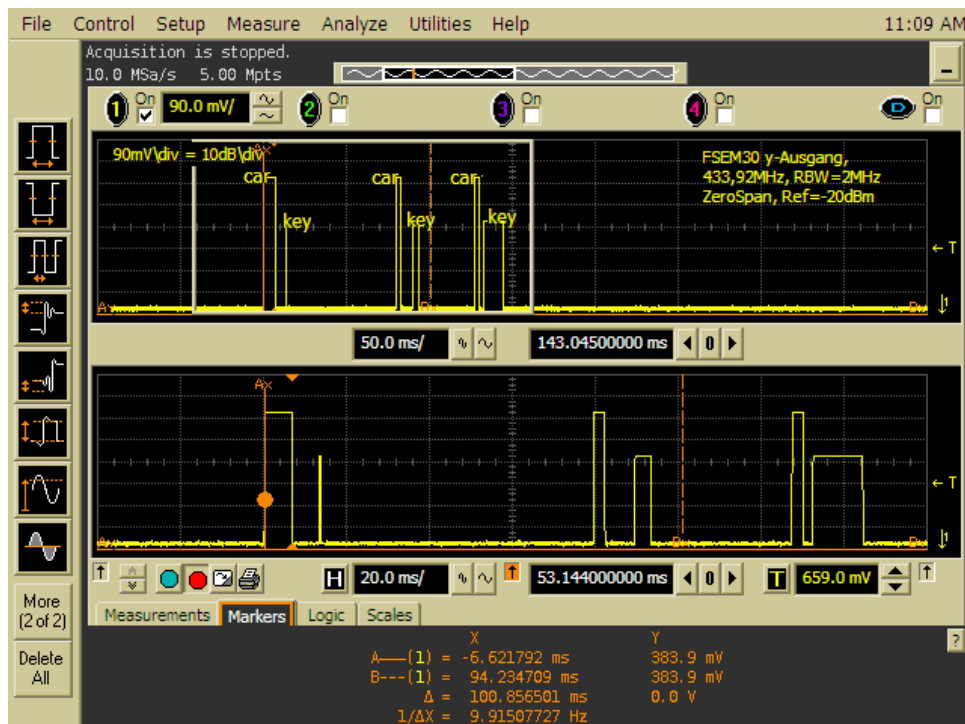

FCC ID: 2ACC7-RKE213U1

Second HF-Telegramm vehicle (2.7 ms)

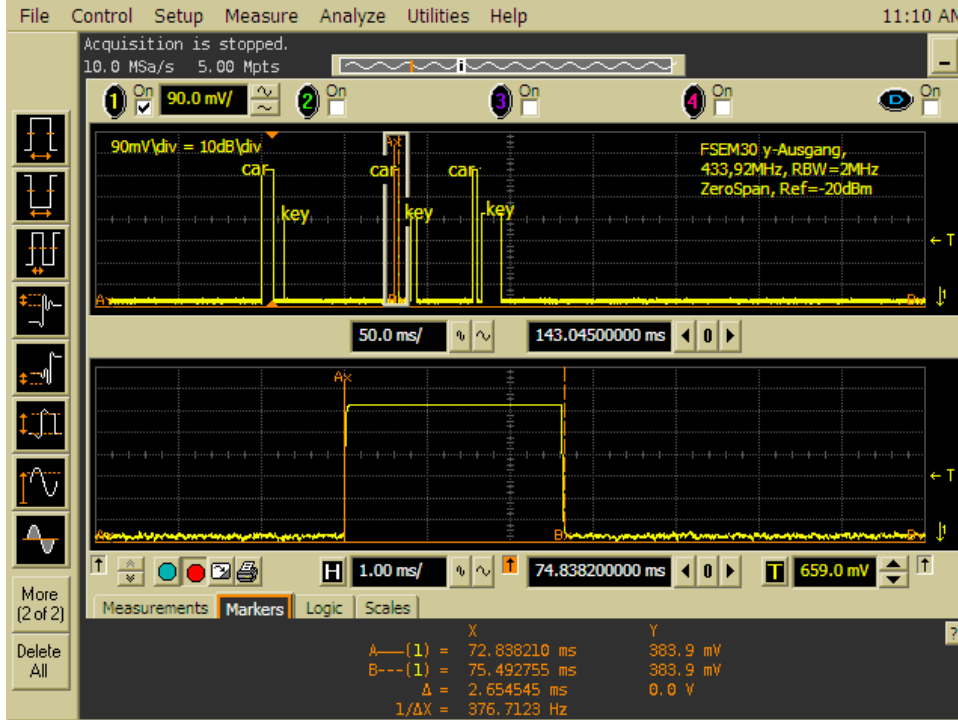

100 ms time window in the range of the first HF-Telegramm

Both Marker show the 100 ms time window.

-> 2 HF-Telegramms which were generated by the vehicle are inside the 100 ms.

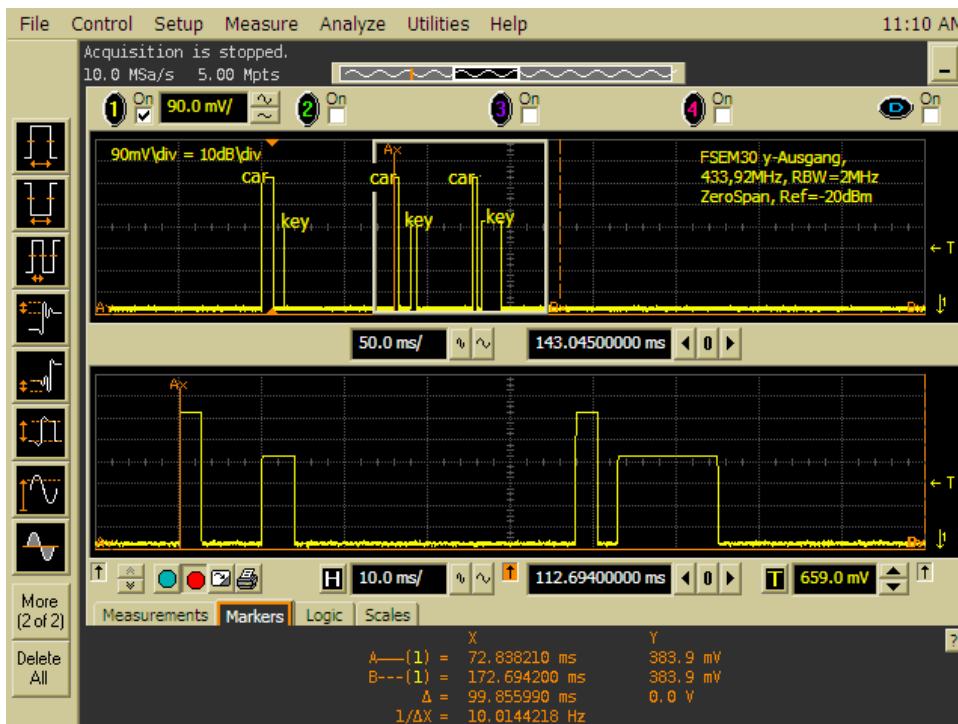

FCC ID: 2ACC7-RKE213U1

Third HF-Telegramm vehicle (2.7 ms)

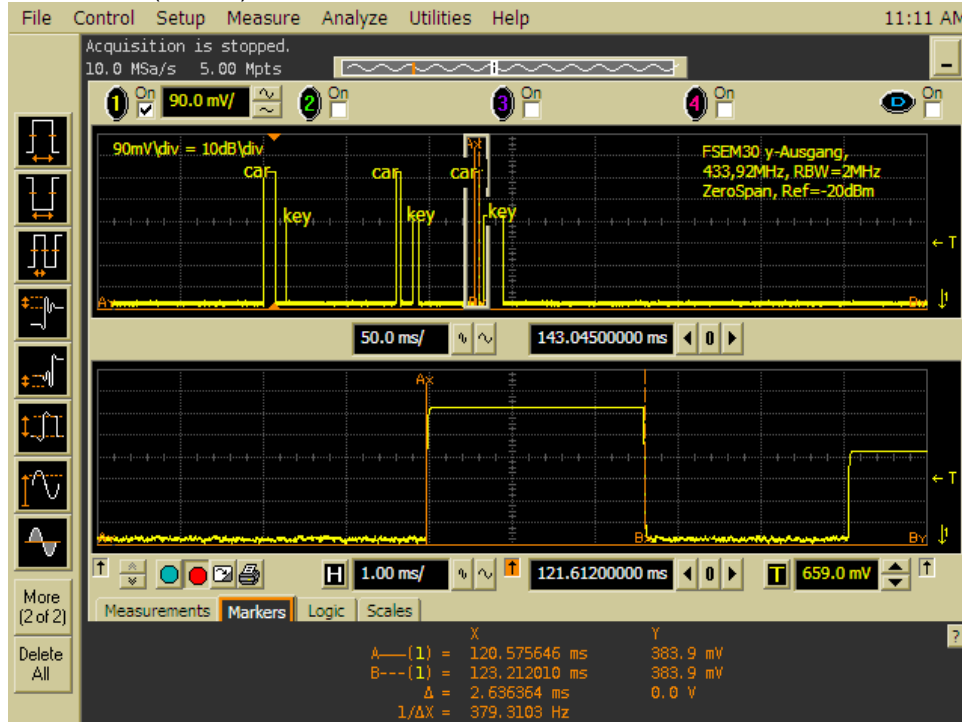

Correction factor (-20.5 dB)

$$(1) \quad DC = \frac{6,7 \text{ ms} + 2,7 \text{ ms}}{100 \text{ ms}} = 9,4\%$$

FCC ID: 2ACC7-RKE213U1
6 USED TEST EQUIPMENT AND ACCESSORIES

All test instruments used are calibrated and verified regularly. The calibration history is available on request.

Test ID	Model Type	Equipment No.	Next Calib.	Last Calib.	Next Verif.	Last Verif.
CPR 2	ESVS 30	02-02/03-05-006	03/07/2015	03/07/2014		
	VULB 9168	02-02/24-05-005	17/04/2016	17/04/2015	20/11/2015	20/05/2015
	NW-2000-NB	02-02/50-05-113				
	KK-EF393/U-16N-21N20 m	02-02/50-12-018				
	KK-SD_7/8-2X21N-33,0M	02-02/50-15-028				
MB	FSP 40	02-02/11-11-001	02/10/2015	02/10/2014		
	METRAHIT WORLD	02-02/32-15-001	26/11/2015	26/11/2014		
	6543A	02-02/50-05-157				
SER 1	FMZB 1516	01-02/24-01-018			19/01/2016	19/01/2015
	ESCI	02-02/03-05-005	09/12/2015	09/12/2014		
	KK-EF393-21N-16	02-02/50-05-033				
	NW-2000-NB	02-02/50-05-113				
	KK-SD_7/8-2X21N-33,0M	02-02/50-15-028				
SER 2	ESVS 30	02-02/03-05-006	03/07/2015	03/07/2014		
	VULB 9168	02-02/24-05-005	17/04/2016	17/04/2015	20/11/2015	20/05/2015
	NW-2000-NB	02-02/50-05-113				
	KK-EF393/U-16N-21N20 m	02-02/50-12-018				
	KK-SD_7/8-2X21N-33,0M	02-02/50-15-028				
SER 3	FSP 40	02-02/11-11-001	02/10/2015	02/10/2014		
	AFS5-12001800-18-10P-6	02-02/17-06-002				
	AFS4-01000400-10-10P-4	02-02/17-13-002				
	AMF-4F-04001200-15-10P	02-02/17-13-003				
	3117	02-02/24-05-009	12/05/2016	12/05/2015		
	Sucoflex N-2000-SMA	02-02/50-05-075				
	SF104/11N/11N/1500MM	02-02/50-13-015				