

# FPC ANTENNA

## RFANT Series – RoHS Compliance

2.4 GHz ISM Band Working Frequency

**model: R3-WIFI**

### CONSTRUCTION

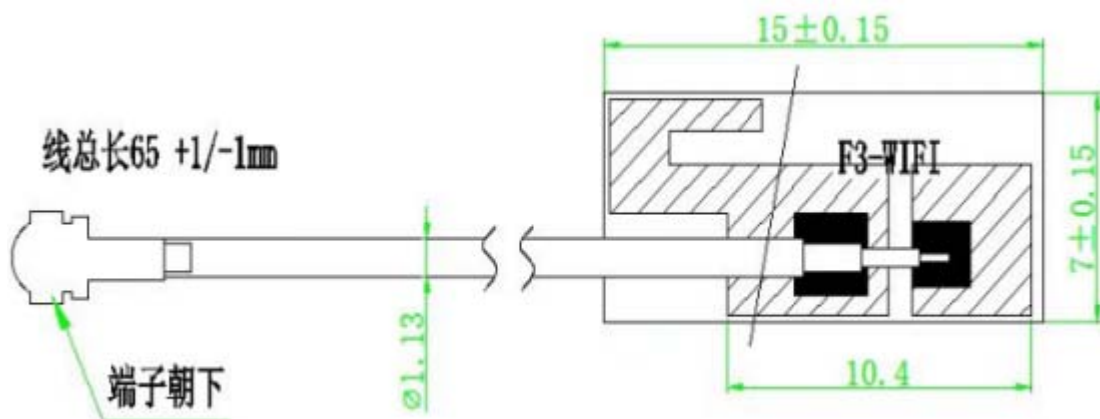

**ELECTRICAL CHARACTERISTICS**

Item	Specification
Working Frequency Range	2.4 GHz ~ 2.5GHz
Gain	2.0 dBi (Typical)
VSWR	2 max.
Polarization	Linear
Azimuth Beamwidth	Omni-directional
Impedance	50Ω
Rated Power (max.)	3 Watts
Maximum Input Power	5 Watts for 5 minutes
Operation Temperature	-40°C ~ +85°C

**Remark: The specification is defined based on the test board dimension as in below**

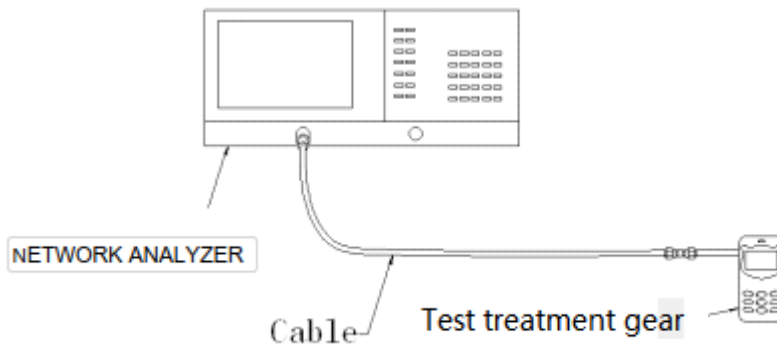

Antenna S11 on Test Board

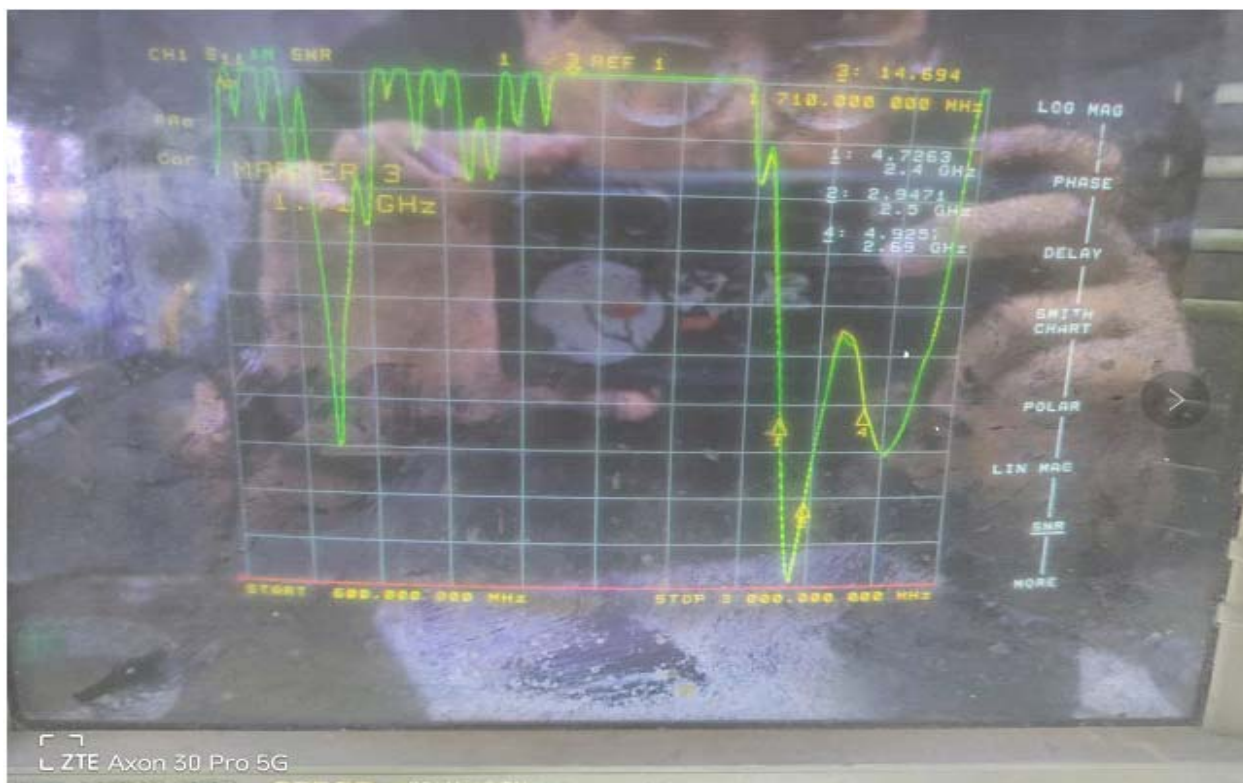

**RADIATION PATTERN**

Radiation Pattern and Gain were dependent on measurement board design. The specification of RFANT5220110A0T antenna was measured based on the PCB size and installation position as shown in the below figure Test Board

**2400.000MHz**

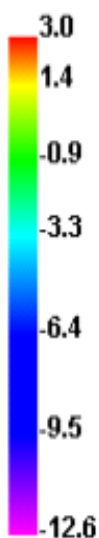
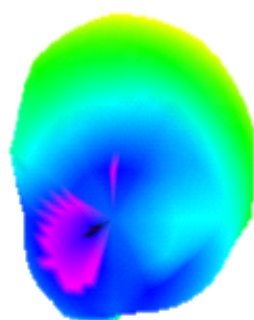

**2400.000MHz H**

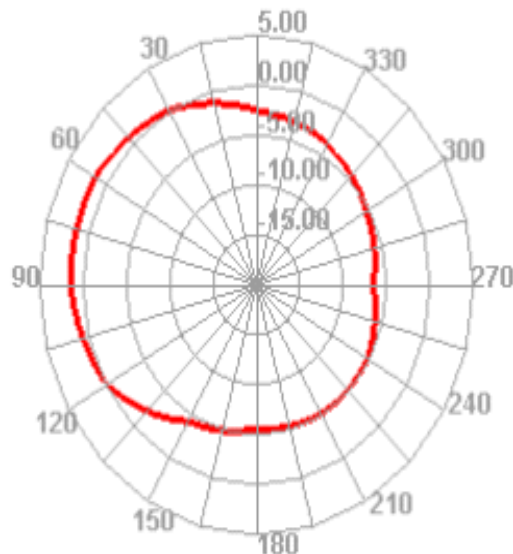

**2400.000MHz E1**

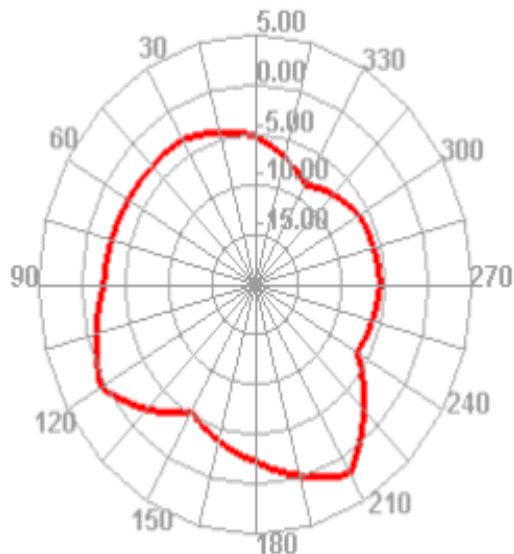

**2400.000MHz E2**

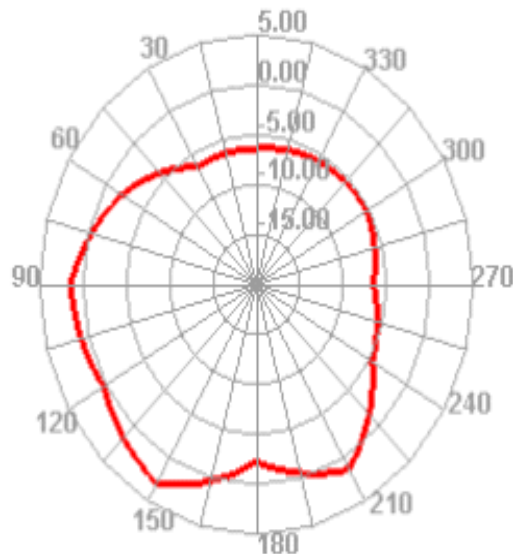

2450.000MHz

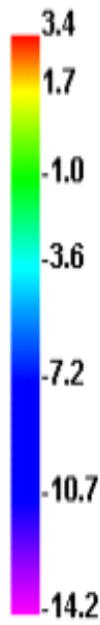
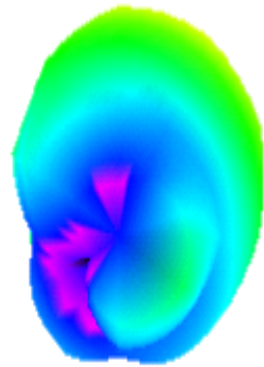

2450.000MHz H

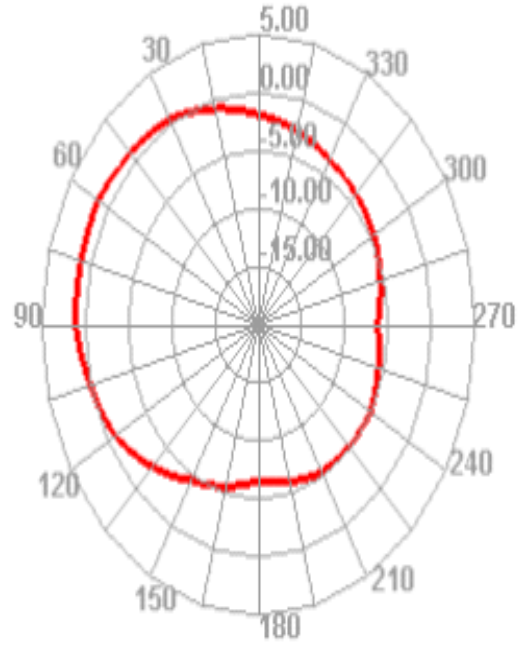

2450.000MHz E1

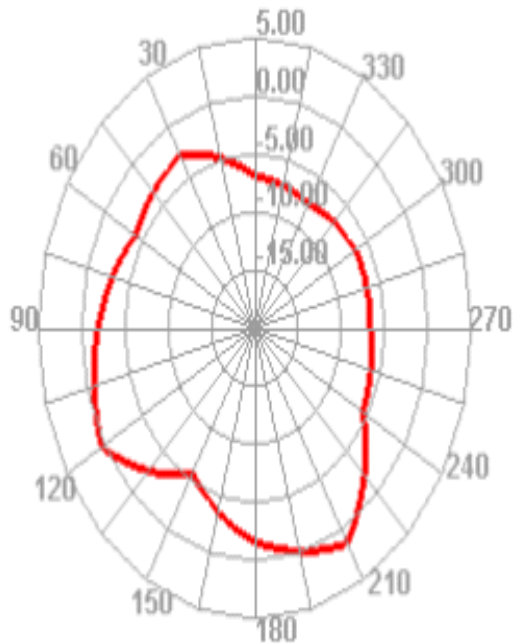

2450.000MHz E2

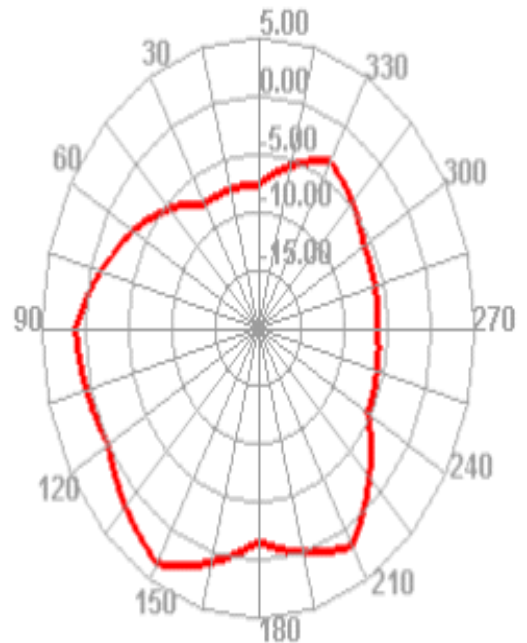

2500.000MHz

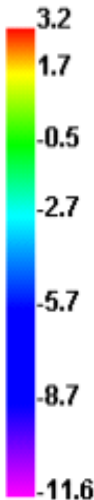
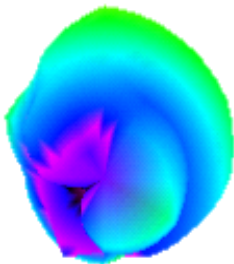

2500.000MHz H

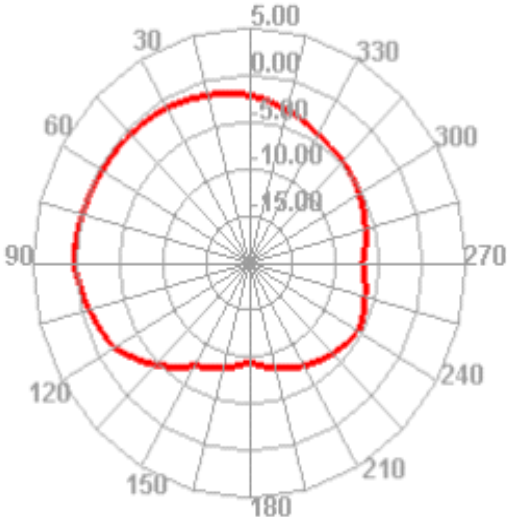

2500.000MHz E1

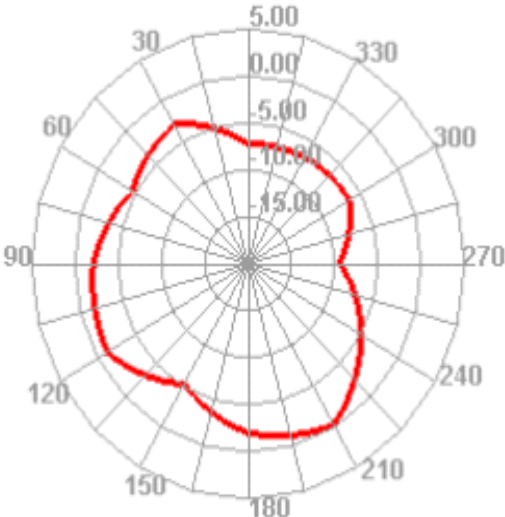

2500.000MHz E2

