



TEST REPORT

FCC PART 15 SUBPART C

Report Reference No..... : CTL2209277011-WF

Compiled by
(position+printed name+signature)

Happy Guo
(File administrators)

Supervised by
(position+printed name+signature)

Cary Gao
(Test Engineer)

Approved by
(position+printed name+signature)

Ivan Xie
(Manager)



Applicant's name..... : Cotton On USA Inc

Address of applicant..... : 16511, Trojan Way, La Miranda, California 90638, United States

Test Firm..... : Shenzhen CTL Testing Technology Co., Ltd.

Address..... : Floor 1-A, Baisha Technology Park, No.3011, Shahexi Road, Nanshan District, Shenzhen, China 518055

Test specification..... :

Standard..... : FCC Part 15C

Master TRF..... : Dated 2011-01

Test item description..... : WIRELESS CHARGING MOUSE PAD

FCC ID..... : 2AC9N1685033

Trade Mark..... : TYPO

Model/Type reference..... : 1685033

List Model(s)..... : 1685033-01, 1685033-XXX(XXX represents 2 or 3 digital numbers from 00 to 999 indicating the external finish of the product)

Transmit Frequency..... : 115~205KHz

Antenna type..... : Loop antenna

Date of receipt of test item..... : Spet. 27, 2022

Date of Test Date..... : Spet. 27, 2022-Oct. 17, 2022

Date of Issue..... : Oct. 17, 2022

Result..... : Pass

Shenzhen CTL Testing Technology Co., Ltd. All rights reserved.

This publication may be reproduced in whole or in part for non-commercial purposes as long as the Shenzhen CTL Testing Technology Co., Ltd. is acknowledged as copyright owner and source of the material. Shenzhen CTL Testing Technology Co., Ltd. takes no responsibility for and will not assume liability for damages resulting from the reader's interpretation of the reproduced material due to its placement and context.

TEST REPORT

Test Report No. :	CTL2209277011-WF	Oct. 17, 2022
		Date of issue

Equipment under Test : WIRELESS CHARGING MOUSE PAD

Sample No : CTL220927701-1-S001

Type / Model(s) : 1685033

List Model(s) : 1685033-01, 1685033-XXX(XXX represents 2 or 3 digital numbers from 00 to 999 indicating the external finish of the product)

Applicant : **Cotton On USA Inc**

Address : 16511, Trojan Way, La Miranda, California 90638, United States

Manufacturer : **DONGGUAN EDO ELECTRONIC TECHNOLOGY CO., LTD**

Address : Room 503, No.6, Donger Road, Yayao Industrial Zone, Humen Town Dongguan

Test result	Pass *
--------------------	---------------

The test results presented in this report relate only to the object tested.

This report shall not be reproduced, except in full, without the written approval of the issuing testing laboratory.

The device (Product Name: WIRELESS CHARGING MOUSE PAD) Models Name: 1685033, 1685033-01, 1685033-XXX(XXX represents 2 or 3 digital numbers from 00 to 999 indicating the external finish of the product) have same electrical, PCB and BOM, only the model's name and colour are different for marketing requirements.

Contents

1. TEST STANDARDS	4
2. SUMMARY	5
2.1. General Remarks	5
2.2. Equipment Under Test	5
2.3. Short description of the Equipment under Test (EUT)	5
2.4. EUT configuration	5
2.5. Related Submittal(s) / Grant (s)	6
2.6. Modifications	6
2.7. Summary of Test Results	6
3. TEST ENVIRONMENT	7
3.1. Address of the test laboratory	7
3.2. Test Facility	7
3.3. Environmental conditions	7
3.4. Statement of the measurement uncertainty	8
3.5. Equipments Used during the Test	8
4. TEST CONDITIONS AND RESULTS	9
4.1. AC Power Conducted Emission	9
4.2. Radiated Emission	12
4.3. 20dB Bandwidth/99% Bandwidth	18
4.4. Antenna Requirement	19
5. TEST SETUP PHOTOS OF THE EUT	20
6. EXTERNAL AND INTERNAL PHOTOS OF EUT	21

1. TEST STANDARDS

The tests were performed according to following standards:

[FCC Rules Part 15.207,15.209, 15.215\(c\)](#)

[ANSI C63.10-2013](#)

2. SUMMARY

2.1. General Remarks

Date of receipt of test sample	:	Spet. 27, 2022
Testing commenced on	:	Spet. 27, 2022
Testing concluded on	:	Oct. 17, 2022

2.2. Equipment Under Test

Product Name:	WIRELESS CHARGING MOUSE PAD
Model/Type reference:	1685033
Power supply:	Input power: 5V/2A Power output: 5V/1A Wireless charging power: 10W Max
Wireless Charger:	
Operation frequency:	115KHz-205KHz
Modulation type:	ASK
Rated power:	10W
Antenna type:	Loop antenna

2.3. Short description of the Equipment under Test (EUT)

Clock wireless charger work frequency range 115-205 KHz.

For more details, refer to the user's manual of the EUT.

EUT operation mode

The EUT has been tested under typical operating condition. The Applicant provides communication tools software to control the EUT for staying in continuous transmitting mode for testing.

Test Mode 1:	Wireless charging mode
Test Mode 2:	Standby mode

Note: We have tested all test mode, only recorded the worst case Test mode 1 in the report.

2.4. EUT configuration

The following peripheral devices and interface cables were connected during the measurement:

- - supplied by the manufacturer
- - supplied by the lab

○	Wireless charging simulates the load	Manufacturer :	Shenzhen Hongxin Electronic Co., LTD
		Model No. :	QI
○	Adapter	Manufacturer :	HUAWEI
		Model No. :	Vostro14-3468

2.5. Related Submittal(s) / Grant (s)

This submittal(s) (test report) is intended for FCC ID:2AC9N1685033 filing to comply with FCC Part 15, Subpart C Rules.

2.6. Modifications

No modifications were implemented to meet testing criteria.

2.7. Summary of Test Results

The EUT is night light with wireless charger, The test summary of the EUT listed as below:

	Test Standards	Test Result
Electric Field Radiated Emissions	FCC Part 15 C (Section15.209)	PASS
20dB Bandwidth/99% Bandwidth	FCC Part 15 C (Section15.215(c))	PASS
Conducted Emissions	FCC Part 15 C (Section15.207)	PASS
Antenna Requirement	FCC Part 15 C (Section15.203)	PASS

Remark: The measurement uncertainty is not included in the test result.

3. TEST ENVIRONMENT

3.1. Address of the test laboratory

Shenzhen CTL Testing Technology Co., Ltd.

Floor 1-A, Baisha Technology Park, No. 3011, Shahexi Road, Nanshan, Shenzhen 518055 China

There is one 3m semi-anechoic chamber and two line conducted labs for final test. The Test Sites meet the requirements in documents ANSI C63.4 and CISPR 32/EN 55032 requirements.

3.2. Test Facility

The test facility is recognized, certified, or accredited by the following organizations:

CNAS-Lab Code: L7497

Shenzhen CTL Testing Technology Co., Ltd. has been assessed and proved to be in compliance with CNAS-CL01 Accreditation Criteria for Testing and Calibration Laboratories (identical to ISO/IEC 17025: 2005 General Requirements) for the Competence of Testing and Calibration Laboratories.

A2LA-Lab Cert. No. 4343.01

Shenzhen CTL Testing Technology Co., Ltd, EMC Laboratory has been accredited by A2LA for technical competence in the field of electrical testing, and proved to be in compliance with ISO/IEC 17025: 2005 General Requirements for the Competence of Testing and Calibration Laboratories and any additional program requirements in the identified field of testing.

IC Registration No.: 9618B

CAB identifier: CN0041

The 3m alternate test site of Shenzhen CTL Testing Technology Co., Ltd. EMC Laboratory has been registered by Innovation, Science and Economic Development Canada to test to Canadian radio equipment requirements with Registration No.: 9618B on Jan. 22, 2019.

FCC-Registration No.: 399832

Designation No.: CN1216

Shenzhen CTL Testing Technology Co., Ltd. EMC Laboratory has been registered and fully described in a report filed with the (FCC) Federal Communications Commission. The acceptance letter from the FCC is maintained in our files. Registration 399832, December 08, 2017.

3.3. Environmental conditions

During the measurement the environmental conditions were within the listed ranges:

Temperature:	<u>15-35 ° C</u>
Humidity:	<u>30-60 %</u>
Atmospheric pressure:	<u>950-1050mbar</u>

3.4. Statement of the measurement uncertainty

The data and results referenced in this document are true and accurate. The reader is cautioned that there may be errors within the calibration limits of the equipment and facilities. The measurement uncertainty was calculated for all measurements listed in this test report acc. to CISPR 16 - 4 „Specification for radio disturbance and immunity measuring apparatus and methods – Part 4: Uncertainty in EMC Measurements“ and is documented in the Shenzhen CTL Testing Technology Co., Ltd. quality system acc. to DIN EN ISO/IEC 17025. Furthermore, component and process variability of devices similar to that tested may result in additional deviation. The manufacturer has the sole responsibility of continued compliance of the device.

Hereafter the best measurement capability for CTL laboratory is reported:

Test	Range	Measurement Uncertainty	Notes
Radiated Emission	0.01-30MHz	4.03dB	(1)
Radiated Emission	30~1000MHz	4.10dB	(1)
Radiated Emission	Above 1GHz	4.32dB	(1)
Conducted Disturbance	0.15~30MHz	3.20dB	(1)

(1) This uncertainty represents an expanded uncertainty expressed at approximately the 95% confidence level using a coverage factor of k=2.

3.5. Equipments Used during the Test

Test Equipment	Manufacturer	Model No.	Serial No.	Calibration Date	Calibration Due Date
LISN	R&S	ESH2-Z5	860014/010	2022/05/06	2023/05/05
LISN	R&S	ENV216	3560.6550.12	2022/05/06	2023/05/05
Double cone logarithmic antenna	Schwarzbeck	VULB 9168	824	2020/04/07	2023/04/06
EMI Test Receiver	R&S	ESCI	1166.5950.03	2022/05/06	2023/05/05
Spectrum Analyzer	Agilent	N9020A	US46220290	2022/05/07	2023/05/06
Spectrum Analyzer	Keysight	N9020A	MY53420874	2022/05/07	2023/05/06
Controller	EM Electronics	EM 1000	060859	2022/05/06	2023/05/05
Horn Antenna	Sunol Sciences Corp.	DRH-118	A062013	2021/12/23	2024/12/22
Ring antenna	BEIJING DA ZE TECHNOLOGY CO., LTD	ZN30900A	N/A	2021/05/13	2024/05/12
Amplifier	Agilent	8449B	3008A02306	2022/05/07	2023/05/06
Amplifier	Agilent	8447D	2944A10176	2022/05/07	2023/05/06
Temperature/Humidity Meter	Gangxing	CTH-608	02	2022/05/06	2023/05/05
Spectrum Analyzer	RS	FSP	1164.4391.38	2022/05/07	2023/05/06

The calibration interval was one year

4. TEST CONDITIONS AND RESULTS

4.1. AC Power Conducted Emission

TEST CONFIGURATION

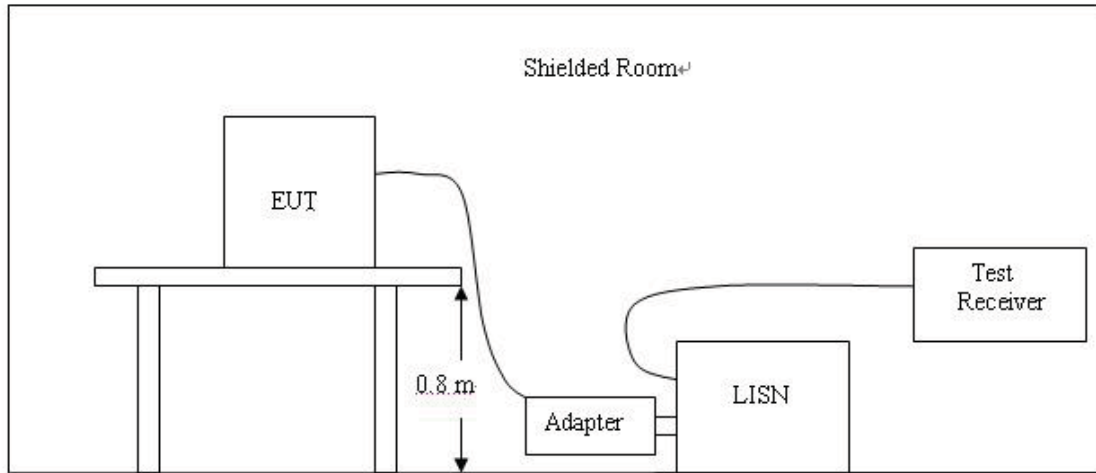

TEST PROCEDURE

- 1 The equipment was set up as per the test configuration to simulate typical actual usage per the user's manual. The EUT is a tabletop system, a wooden table with a height of 0.8 meters is used and is placed on the ground plane as per ANSI C63.10-2013.
- 2 Support equipment, if needed, was placed as per ANSI C63.10-2013
- 3 All I/O cables were positioned to simulate typical actual usage as per ANSI C63.10-2013
- 4 The EUT received DC5V power from the adapter, the adapter received AC120V/60Hz power through a Line Impedance Stabilization Network (LISN) which supplied power source and was grounded to the ground plane.
- 5 All support equipments received AC power from a second LISN, if any.
- 6 The EUT test program was started. Emissions were measured on each current carrying line of the EUT using a spectrum Analyzer / Receiver connected to the LISN powering the EUT. The LISN has two monitoring points: Line 1 (Hot Side) and Line 2 (Neutral Side). Two scans were taken: one with Line 1 connected to Analyzer / Receiver and Line 2 connected to a 50 ohm load; the second scan had Line 1 connected to a 50 ohm load and Line 2 connected to the Analyzer / Receiver.
- 7 Analyzer / Receiver scanned from 150 KHz to 30MHz for emissions in each of the test modes.
- 8 During the above scans, the emissions were maximized by cable manipulation.
Conducted emissions were investigated over the frequency range from 0.15MHz to 30MHz using a receiver bandwidth of 9kHz.

AC Power Conducted Emission Limit

For intentional device, according to § 15.207(a) AC Power Conducted Emission Limits is as following :

Frequency (MHz)	Maximum RF Line Voltage (dB μ V)			
	CLASS A		CLASS B	
	Q.P.	Ave.	Q.P.	Ave.
0.15 - 0.50	79	66	66-56*	56-46*
0.50 - 5.00	73	60	56	46
5.00 - 30.0	73	60	60	50

* Decreasing linearly with the logarithm of the frequency

TEST RESULTS

Line:

L

SCAN TABLE: "Voltage (9K-30M)FIN"
 Short Description: 150K-30M Voltage

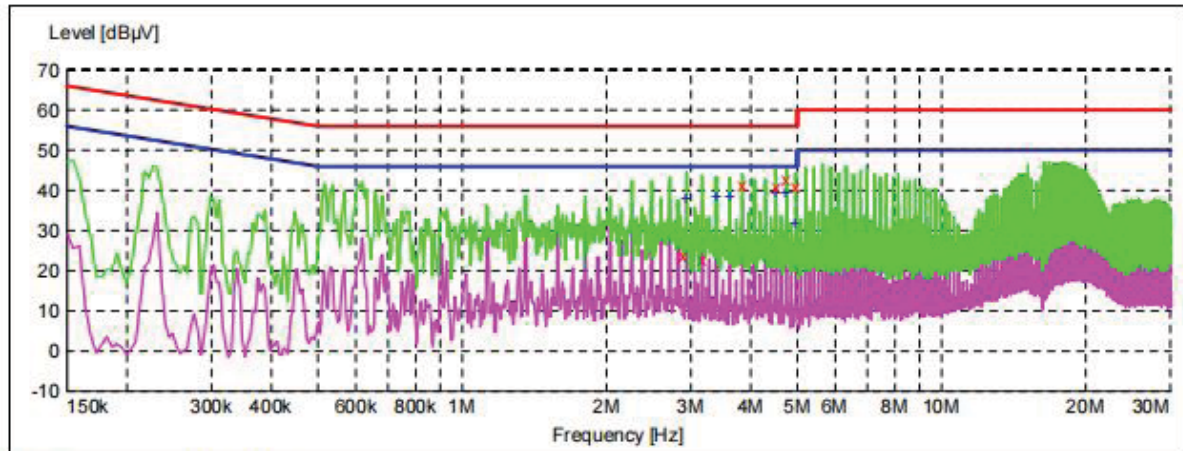

* * * MES CTL220929003_fin

MEASUREMENT RESULT: "CTL220929003_fin"

9/29/2022 9:10AM

Frequency MHz	Level dBµV	Transd dB	Limit dBµV	Margin dB	Detector	Line	PE
2.890500	23.50	10.3	56	32.5	QP	L1	GND
3.192000	22.70	10.3	56	33.3	QP	L1	GND
3.840000	41.50	10.3	56	14.5	QP	L1	GND
4.524000	40.70	10.3	56	15.3	QP	L1	GND
4.744500	42.80	10.3	56	13.2	QP	L1	GND
4.965000	40.70	10.4	56	15.3	QP	L1	GND

MEASUREMENT RESULT: "CTL220929003_fin2"

9/29/2022 9:10AM

Frequency MHz	Level dBµV	Transd dB	Limit dBµV	Margin dB	Detector	Line	PE
2.935500	38.20	10.3	46	7.8	AV	L1	GND
3.390000	38.60	10.3	46	7.4	AV	L1	GND
3.615000	38.60	10.3	46	7.4	AV	L1	GND
4.519500	39.30	10.3	46	6.7	AV	L1	GND
4.744500	39.60	10.3	46	6.4	AV	L1	GND
4.969500	31.60	10.4	46	14.4	AV	L1	GND

Line:

N

SCAN TABLE: "Voltage (9K-30M) FIN"

Short Description: 150K-30M Voltage

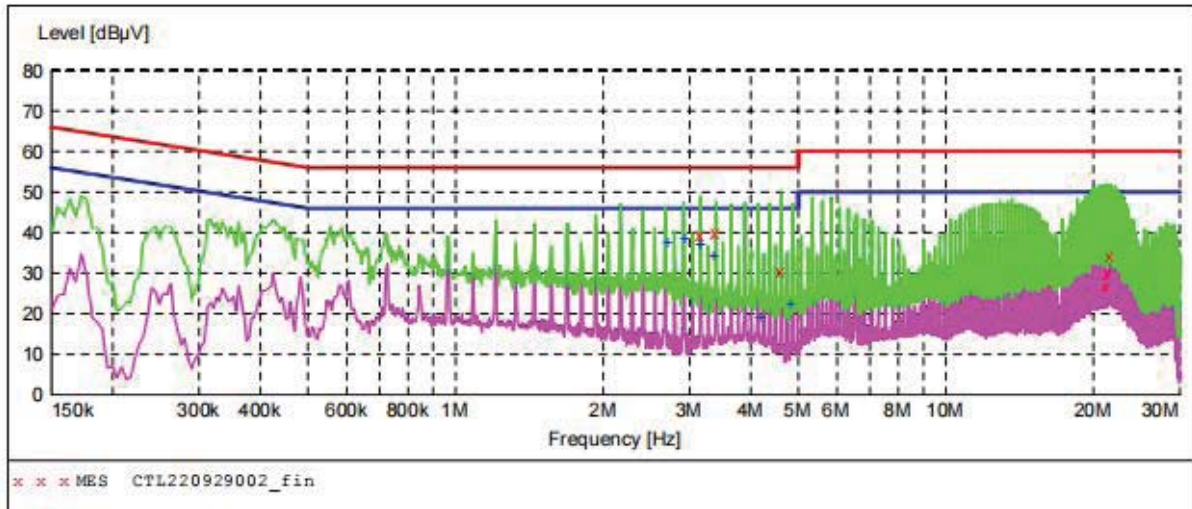

MEASUREMENT RESULT: "CTL220929002_fin"

9/29/2022 9:07AM

Frequency MHz	Level dBµV	Transd dB	Limit dBµV	Margin dB	Detector	Line	PE
3.160500	39.50	10.3	56	16.5	QP	N	GND
3.390000	39.80	10.3	56	16.2	QP	N	GND
4.632000	30.20	10.3	56	25.8	QP	N	GND
21.219000	26.40	11.3	60	33.6	QP	N	GND
21.439500	29.80	11.3	60	30.2	QP	N	GND
21.682500	34.20	11.3	60	25.8	QP	N	GND

MEASUREMENT RESULT: "CTL220929002_fin2"

9/29/2022 9:07AM

Frequency MHz	Level dBµV	Transd dB	Limit dBµV	Margin dB	Detector	Line	PE
2.710500	37.50	10.3	46	8.5	AV	N	GND
2.935500	38.40	10.3	46	7.6	AV	N	GND
3.160500	37.00	10.3	46	9.0	AV	N	GND
3.385500	34.40	10.3	46	11.6	AV	N	GND
4.177500	18.80	10.3	46	27.2	AV	N	GND
4.857000	22.40	10.4	46	23.6	AV	N	GND

4.2. Radiated Emission

TEST CONFIGURATION

Radiated Emission Test Set-Up
Frequency range 9KHz – 30MHz

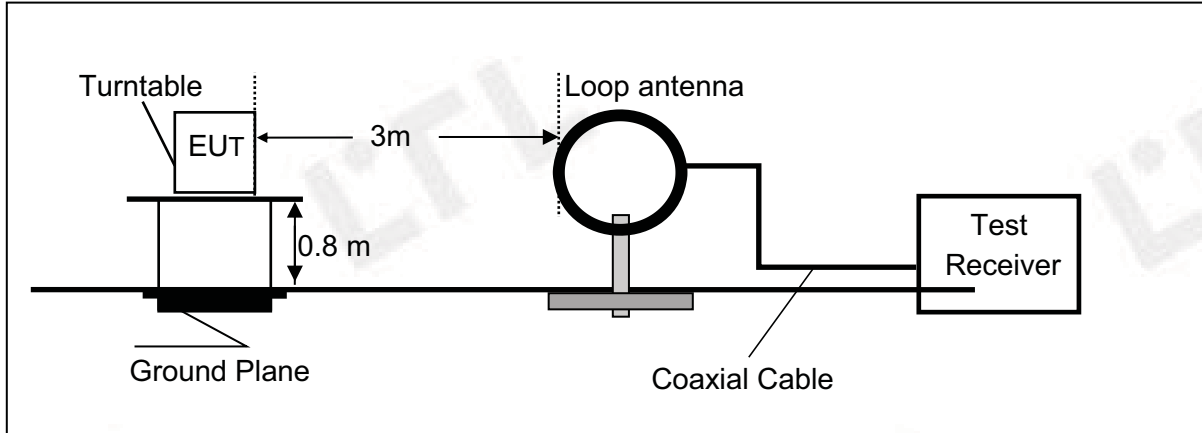

Frequency range 30MHz – 1000MHz

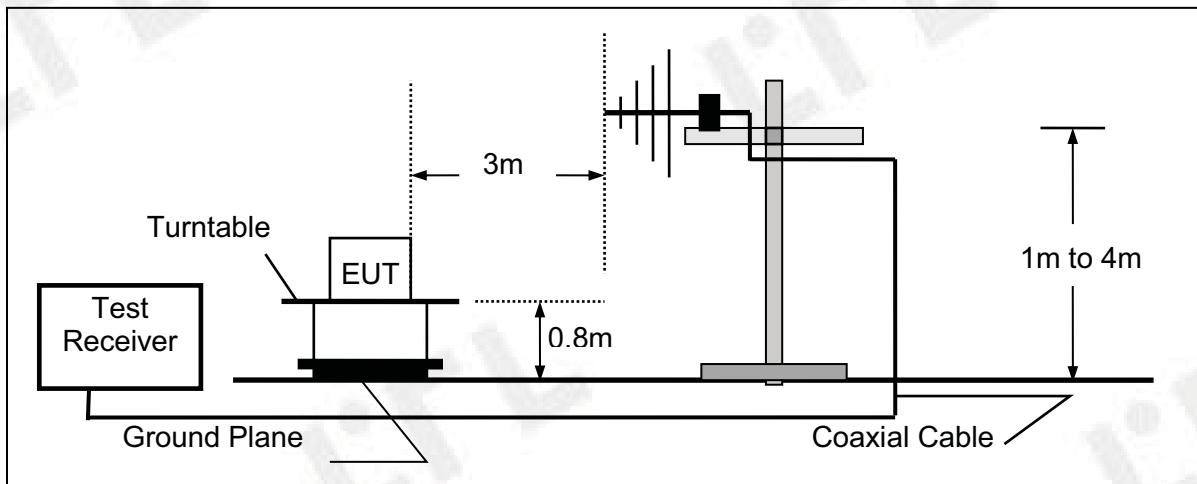

TEST PROCEDURE

- Below 1GHz measurement the EUT is placed on a turntable which is 0.8m above ground plane, and above 1GHz measurement EUT was placed on a low permittivity and low loss tangent turn table which is 1.5m above ground plane.
- Maximum procedure was performed by raising the receiving antenna from 1m to 4m and rotating the turn table from 0°C to 360°C to acquire the highest emissions from EUT
- And also, each emission was to be maximized by changing the polarization of receiving antenna both horizontal and vertical.
- Repeat above procedures until all frequency measurements have been completed.
- Radiated emission test frequency band from 9KHz to 1000MHz.
- The distance between test antenna and EUT as following table states:

Test Frequency range	Test Antenna Type	Test Distance
9KHz-30MHz	Active Loop Antenna	3
30MHz-1GHz	Bilog Antenna	3

- Setting test receiver/spectrum as following table states:

Test Frequency range	Test Receiver/Spectrum Setting	Detector
9KHz-150KHz	RBW=200Hz/VBW=3KHz,Sweep time=Auto	QP
150KHz-30MHz	RBW=9KHz/VBW=100KHz,Sweep time=Auto	QP
30MHz-1GHz	RBW=120KHz/VBW=1000KHz,Sweep time=Auto	QP

Field Strength Calculation

The field strength is calculated by adding the Antenna Factor and Cable Factor and subtracting the Amplifier Gain and Duty Cycle Correction Factor(if any) from the measured reading. The basic equation with a sample calculation is as follows:

$$FS = RA + AF + CL - AG$$

Where FS = Field Strength	CL = Cable Attenuation Factor (Cable Loss)
RA = Reading Amplitude	AG = Amplifier Gain
AF = Antenna Factor	

For example

Frequency (MHz)	FS (dBμV/m)	RA (dBμV/m)	AF (dB)	CL (dB)	AG (dB)	Transd (dB)
300.00	40	58.1	12.2	1.6	31.90	-18.1

$$\text{Transd} = \text{AF} + \text{CL} - \text{AG}$$

RADIATION LIMIT

Except as provided elsewhere in this Subpart, the emissions from an intentional radiator shall not exceed the field strength levels specified in the following table:

9k~30MHz:

Frequency Range (MHz)	E-field Strength Limit @ 30m (mV/m)	E-field Strength Limit @ 3m (dB μ V/m)
0.009-0.490	2400/F(kHz)	129-94
0.490-1.705	24000/F(kHz)	74-63
1.705-30	30	70

Note: Where the limits have been defined at one distance, and a signal level measured at another, the limits have been extrapolated using the following formula:

$$\text{Extrapolation(dB)} = 40\log_{10}(\text{Measurement Distance/Specification Distance})$$

Note:

- (1) The tighter limit shall apply at the edge between two frequency bands.
- (2) dBuV/m = 20*log(uV/m)

30M~1GHz:

Frequency (MHz)	Distance (Meters)	Radiated (dB μ V/m)	Radiated (μ V/m)
30-88	3	40.0	100
88-216	3	43.5	150
216-960	3	46.0	200
Above 960	3	54.0	500

Note:

- (1) The tighter limit shall apply at the edge between two frequency bands.
- (2) Distance refers to the distance in meters between the test instrument antenna and the closest point of any part of the E.U.T.

TEST RESULTS

WORST-CASE RADIATED EMISSION BELOW 30 MHz

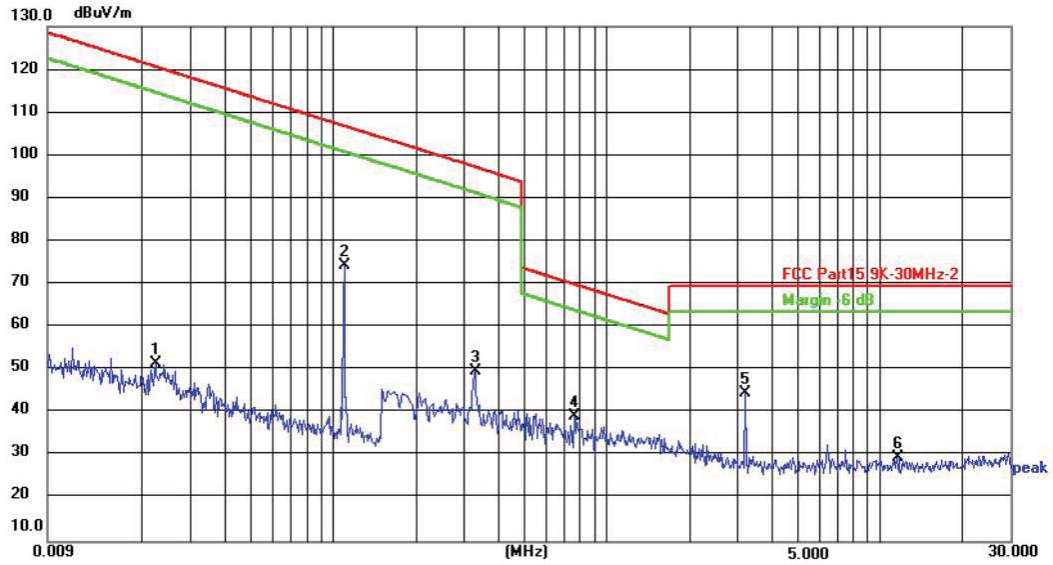

No.	Frequency (MHz)	Reading (dBuV)	Factor (dB/m)	Level (dBuV/m)	Limit (dBuV/m)	Margin (dB)	Detector	Height (cm)	Azimuth (deg.)	P/F	Remark
1	0.0224	31.13	20.48	51.61	120.60	68.99	peak			P	
2	0.1160	54.03	20.24	74.27	106.81	32.54	peak			P	
3	0.3300	29.57	20.12	49.69	97.23	47.54	peak			P	
4	0.7660	19.21	20.06	39.27	69.92	30.65	peak			P	
5	3.2220	24.68	19.99	44.67	69.54	24.87	peak			P	
6	11.5620	9.73	19.79	29.52	69.54	40.02	peak			P	

Radiated Emission Test Data 30-1000MHz:

Horizontal

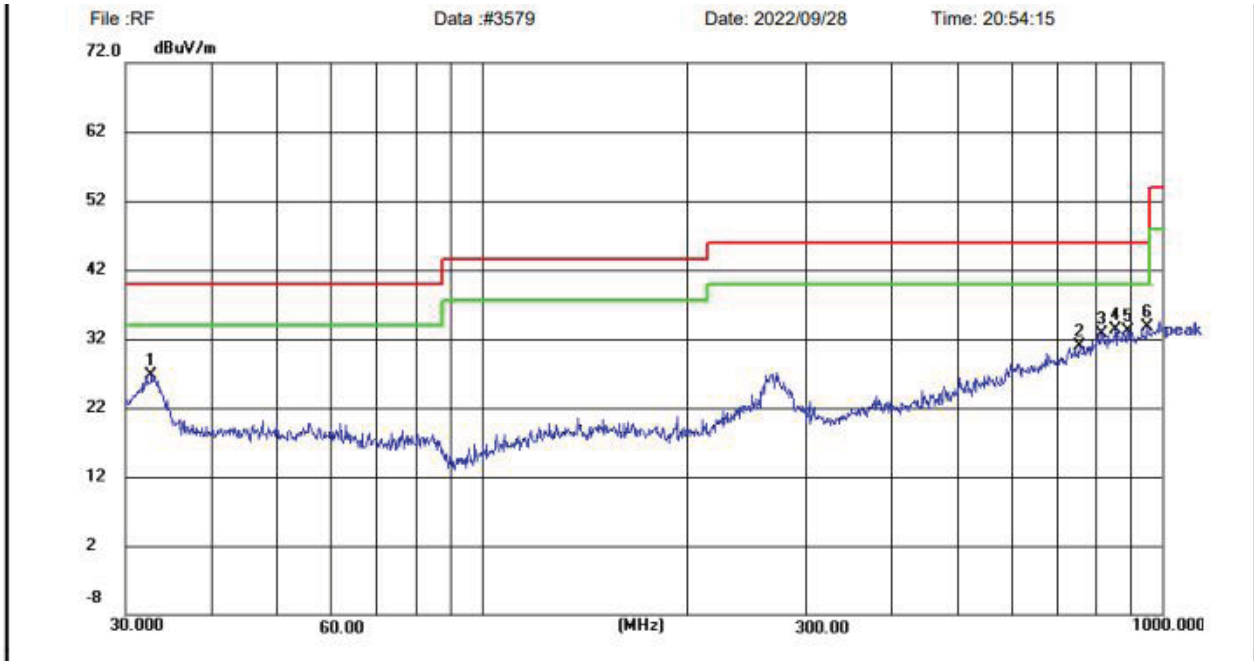

Site LAB Chamber 2
 Limit: FCC Part15 Class C_30-1000MHz
 EUT: /
 M/N: 1685033
 Mode: WORKING
 Note: Cotton On USA Inc

Polarization: **Horizontal**
 Power:
 Distance: 3m

Temperature: 25(C)
 Humidity: 50 %

No.	Frequency (MHz)	Reading (dBuV)	Factor (dB/m)	Level (dBuV/m)	Limit (dBuV/m)	Margin (dB)	Detector	Height (cm)	Azimuth (deg.)	P/F	Remark
1	32.7486	14.26	12.45	26.71	40.00	13.29	peak	100	297	P	
2	755.3873	7.23	23.68	30.91	46.00	15.09	peak	100	172	P	
3	815.9678	7.68	25.00	32.68	46.00	13.32	peak	100	242	P	
4	854.0247	7.74	25.50	33.24	46.00	12.76	peak	100	195	P	
5	890.7277	7.12	25.90	33.02	46.00	12.98	peak	100	0	P	
6	952.0937	7.18	26.57	33.75	46.00	12.25	peak	100	305	P	

Vertical

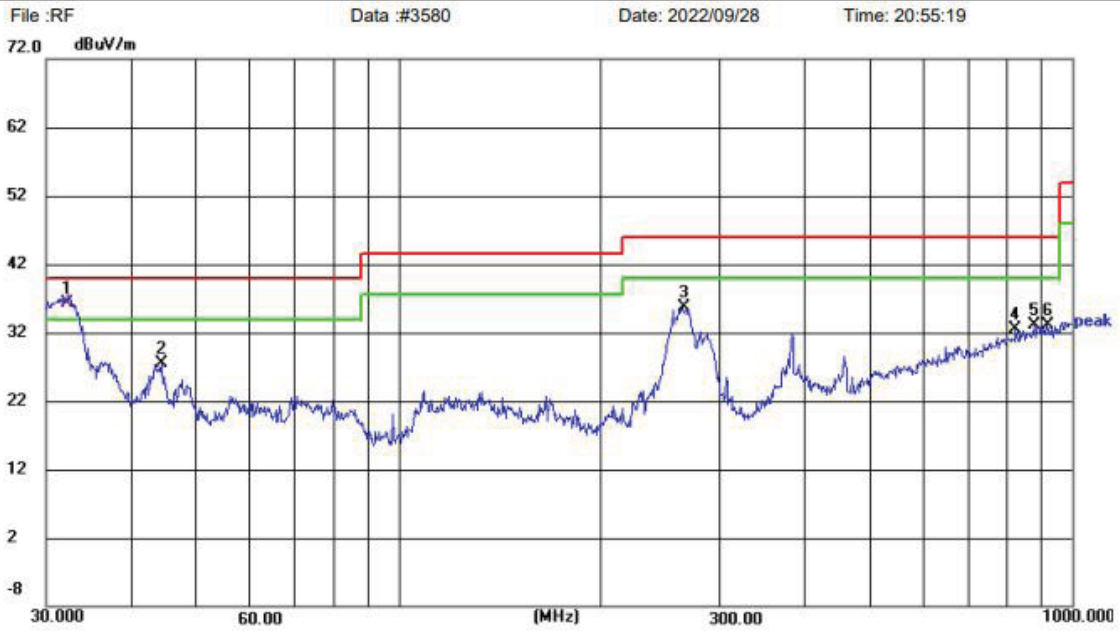

Site LAB Chamber 2
 Limit: FCC Part15 Class C_30-1000MHz
 EUT: /
 M/N: 1685033
 Mode: WORKING
 Note: Cotton On USA Inc

Polarization: **Vertical**
 Power:
 Distance: 3m

Temperature: 25(C)
 Humidity: 50 %

No.	Frequency (MHz)	Reading (dBuV)	Factor (dB/m)	Level (dBuV/m)	Limit (dBuV/m)	Margin (dB)	Detector	Height (cm)	Azimuth (deg.)	P/F	Remark
1	32.3803	23.84	12.38	36.22	40.00	3.78	QP	100	360	P	
2	44.4308	13.85	13.70	27.55	40.00	12.45	peak	100	320	P	
3	264.7457	22.59	13.04	35.63	46.00	10.37	peak	100	78	P	
4	824.5968	7.37	25.12	32.49	46.00	13.51	peak	100	164	P	
5	878.3214	7.41	25.76	33.17	46.00	12.83	peak	100	203	P	
6	916.0687	6.93	26.18	33.11	46.00	12.89	peak	100	188	P	

4.3. 20dB Bandwidth/99% Bandwidth

Limit

The 20dB bandwidth shall be less than 80% of the permitted frequency band.

Test Procedure

The transmitter output was connected to the spectrum analyzer through an attenuator. The bandwidth of the fundamental frequency was measured by spectrum analyzer with 1 KHz RBW and 3 KHz VBW.

The 20dB bandwidth is defined as the total spectrum the power of which is higher than peak power minus 20dB.

Test Configuration



Test Results

Model

Frequency(MHz)	20dB bandwidth(KHz)	99% OBW(KHz)	Result
115.99	2.795	2.415	Pass

115.99 KHz

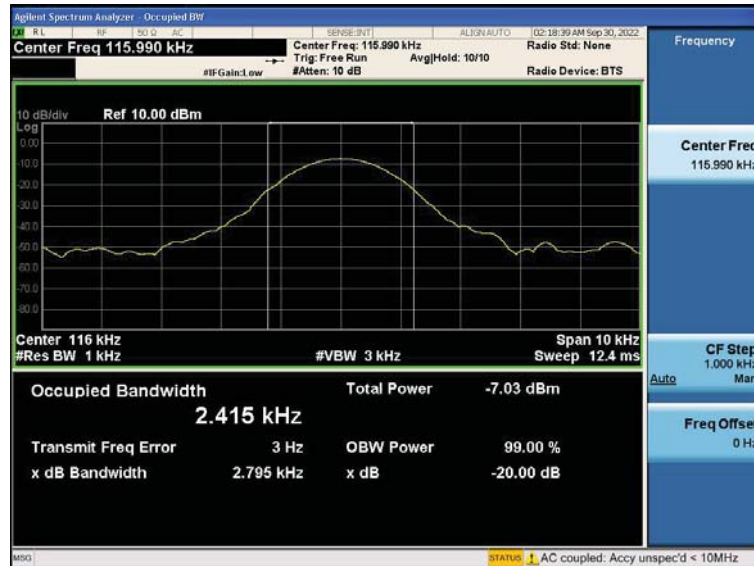

4.4. Antenna Requirement

Standard Applicable

Standard Applicable

For intentional device, according to FCC 47 CFR Section 15.203, an intentional radiator shall be designed to ensure that no antenna other than that furnished by the responsible party shall be used with the device.

Antenna Information

The antenna used in this product is a Loop antenna, The directional gains of antenna used for transmitting is 0dBi

5. Test Setup Photos of the EUT

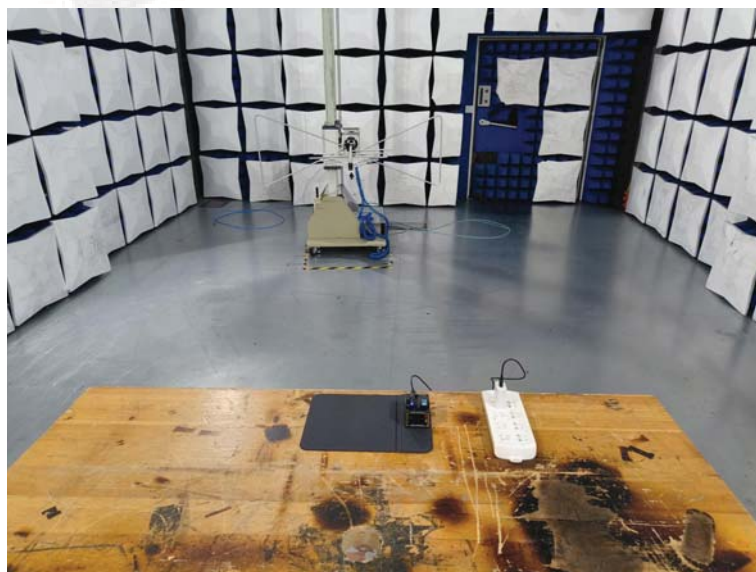
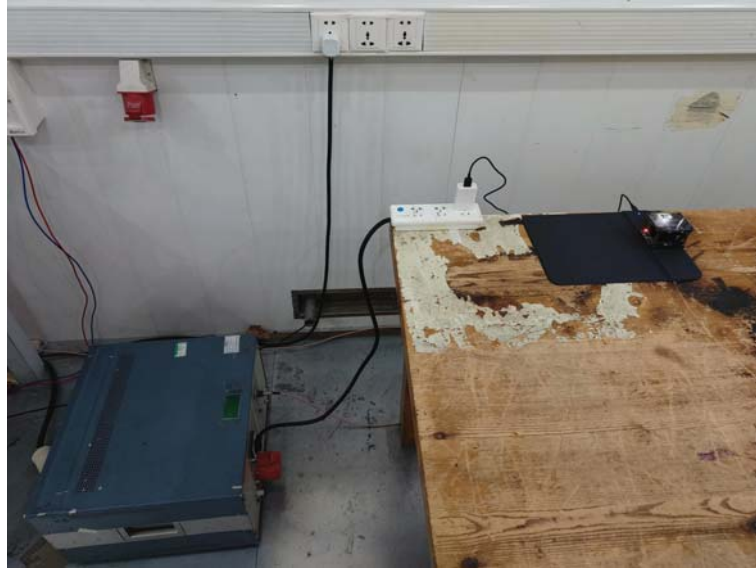

6. External and Internal Photos of EUT

External Photos of the EUT

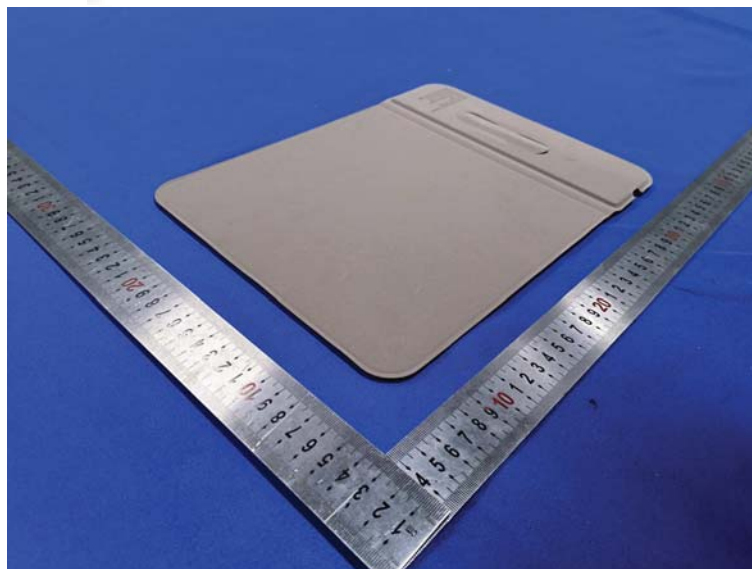
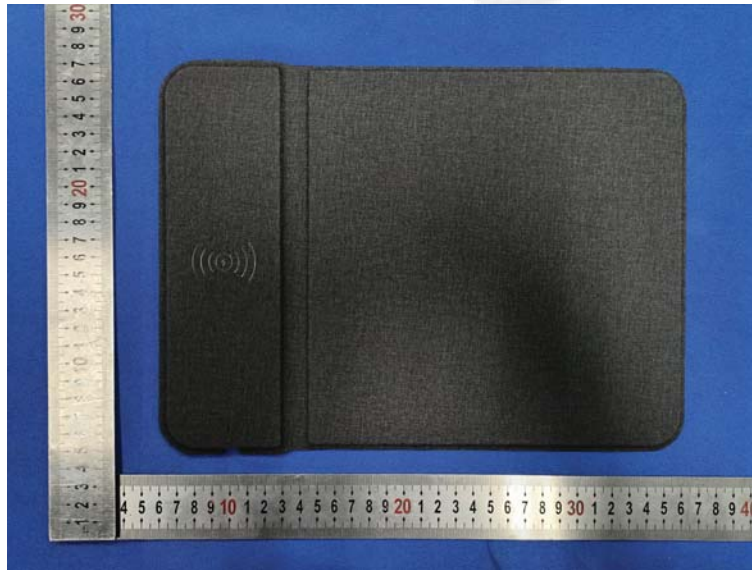



Internal Photos of the EUT

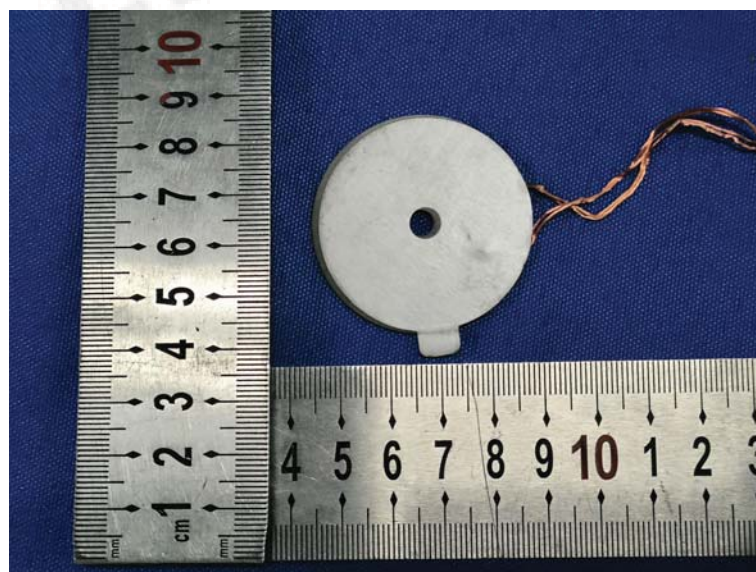
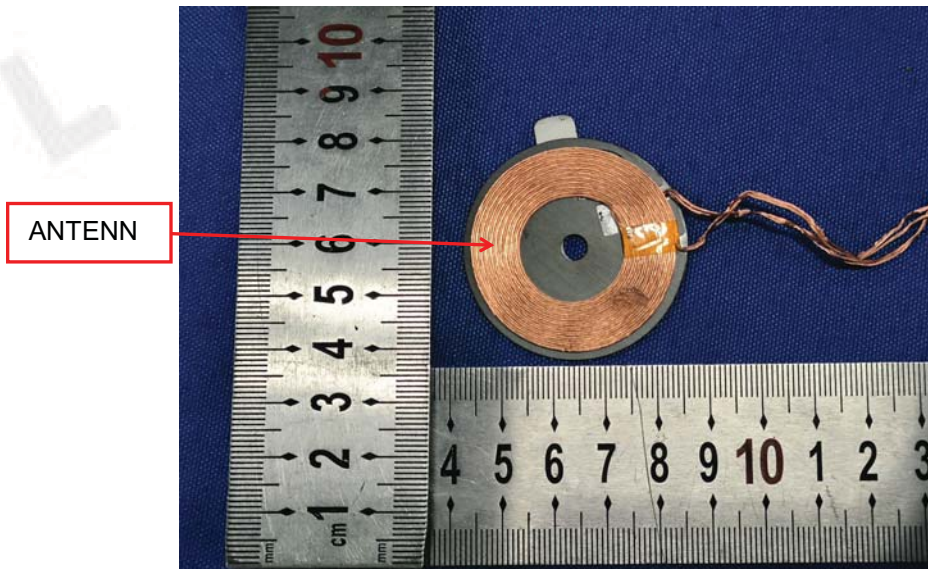

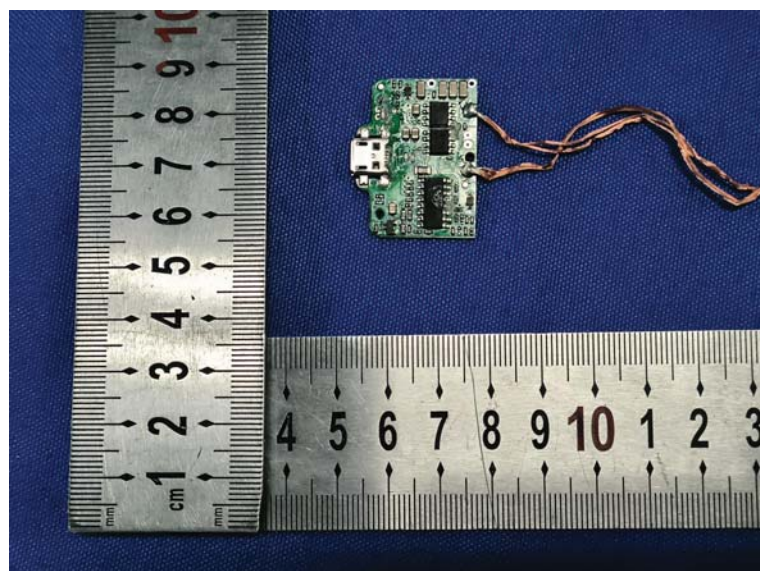
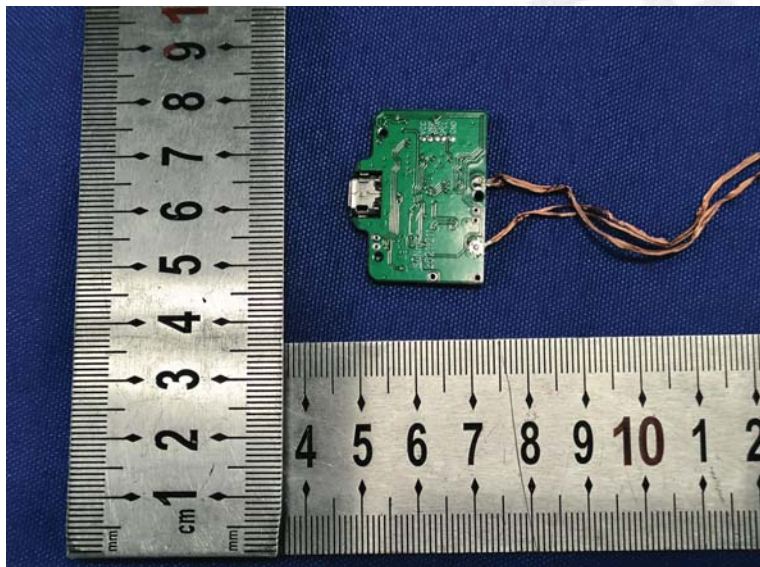

***** End of Report *****