



# TEST REPORT

## 47 CFR Part 15, Subpart C 15.247

**Report Reference No.:** CTL2405117011-WF

Compiled by:  
( position+printed name+signature)

Happy Guo  
(File administrators)

Tested by:  
( position+printed name+signature)

Yapeng Jin  
(Test Engineer)

Approved by:  
( position+printed name+signature)

Ivan Xie  
(Manager)

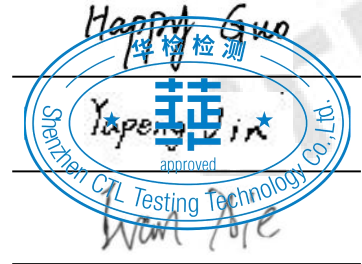

<b>Product Name</b> .....	WIRELESS HEADPHONES 2.0
<b>Model/Type reference</b> .....	1686122-03
<b>List Model(s)</b> .....	Refer to page 2
<b>Trade Mark</b> .....	TYPO
<b>FCC ID</b> .....	<b>2AC9N-1686122-03</b>
<b>Applicant's name</b> .....	<b>Cotton On USA Inc</b>
<b>Address of applicant</b> .....	16511,Trojan Way, La Miranda,California 90638,United States
<b>Test Firm</b> .....	<b>Shenzhen CTL Testing Technology Co., Ltd.</b>
<b>Address of Test Firm</b> .....	Floor 1-A, Baisha Technology Park, No.3011, Shahexi Road, Nanshan District, Shenzhen, China 518055
<b>Test specification</b> .....	
Standard.....	<b>47 CFR Part 15, Subpart C 15.247:</b> Operation within the bands 902-928 MHz, 2400-2483.5 MHz and 5725-5850 MHz.
TRF Originator.....	Shenzhen CTL Testing Technology Co., Ltd.
Master TRF.....	Dated 2011-01
<b>Date of receipt of test item</b> .....	May 11, 2024
<b>Date of Test Date</b> .....	May 13, 2024-May 17, 2024
<b>Date of Issue</b> .....	May 20, 2024
<b>Result</b> .....	<b>Pass</b>

**Shenzhen CTL Testing Technology Co., Ltd. All rights reserved.**  
This publication may be reproduced in whole or in part for non-commercial purposes as long as the Shenzhen CTL Testing Technology Co., Ltd. is acknowledged as copyright owner and source of the material. Shenzhen CTL Testing Technology Co., Ltd. takes no responsibility for and will not assume liability for damages resulting from the reader's interpretation of the reproduced material due to its placement and context.

# TEST REPORT

<b>Test Report No. :</b>	<b>CTL2405117011-WF</b>	May 20, 2024 Date of issue
--------------------------	-------------------------	-------------------------------

Equipment under Test : WIRELESS HEADPHONES 2.0

Sample No : CTL2405117011

Model /Type : 1686122-03

Listed Models : 1686122-01, 1686122-02, 1686122-04, 1685034, 1685034-01, 1685034-XXX, 1686122-XXX(XXX represents 2 or 3 digital numbers from 00 to 999 indicating the external finish of the product)

**Applicant** : **Cotton On USA Inc**

Address : 16511, Trojan Way, La Miranda, California 90638, United States

**Manufacturer** : **TOPAUL TECHNOLOGY LIMITED**

Address : Room 209, Huiju Building, No. 62, Area 1, Longyuan village, Longhua District, Shenzhen, China.

<b>Test result</b>	<b>Pass *</b>
--------------------	---------------

\*In the configuration tested, the EUT complied with the standards specified page 5.

The test results presented in this report relate only to the object tested.

This report shall not be reproduced, except in full, without the written approval of the issuing testing laboratory.



## Table of Contents

## Page

<b>1. SUMMARY .....</b>	<b>5</b>
1.1. TEST STANDARDS .....	5
1.2. TEST DESCRIPTION .....	5
1.3. TEST FACILITY .....	6
1.4. STATEMENT OF THE MEASUREMENT UNCERTAINTY .....	6
<b>2. GENERAL INFORMATION .....</b>	<b>8</b>
2.1. ENVIRONMENTAL CONDITIONS .....	8
2.2. GENERAL DESCRIPTION OF EUT .....	8
2.3. DESCRIPTION OF TEST MODES AND TEST FREQUENCY .....	9
2.4. EQUIPMENTS USED DURING THE TEST .....	10
2.5. RELATED SUBMITTAL(S) / GRANT (S) .....	11
2.6. MODIFICATIONS .....	11
<b>3. TEST CONDITIONS AND RESULTS .....</b>	<b>12</b>
3.1. CONDUCTED EMISSIONS TEST .....	12
3.2. RADIATED EMISSIONS AND BAND EDGE .....	15
3.3. MAXIMUM PEAK OUTPUT POWER .....	25
3.4. 20DB BANDWIDTH .....	26
3.5. FREQUENCY SEPARATION .....	27
3.6. NUMBER OF HOPPING FREQUENCY .....	28
3.7. TIME OF OCCUPANCY (DWELL TIME) .....	29
3.8. OUT-OF-BAND EMISSIONS .....	30
3.9. PSEUDORANDOM FREQUENCY HOPPING SEQUENCE .....	31
3.10. ANTENNA REQUIREMENT .....	32
<b>4. TEST SETUP PHOTOS OF THE EUT .....</b>	<b>33</b>
<b>5. PHOTOS OF THE EUT .....</b>	<b>35</b>

# 1. SUMMARY

## 1.1. TEST STANDARDS

The tests were performed according to following standards:

[47 CFR Part 15, Subpart C 15.247](#): Frequency Hopping, Direct Spread Spectrum and Hybrid Systems that are in operation within the bands of 902-928 MHz, 2400-2483.5 MHz, and 5725-5850 MHz

[ANSI C63.10: 2013](#): American National Standard for Testing Unlicensed Wireless Devices

[KDB 558074 D01 v05r02](#): KDB558074 D01 15.247 Meas Guidance v05r02

## 1.2. Test Description

<b>47 CFR Part 15, Subpart C 15.247</b>		
47 CFR Part 15, Subpart C 15.207	AC Power Conducted Emission	PASS
47 CFR Part 15, Subpart C 15.247(a)(1)(i)	20dB Bandwidth	PASS
47 CFR Part 15, Subpart C 15.247(d)	Spurious RF Conducted Emission	PASS
47 CFR Part 15, Subpart C 15.247(b)	Maximum Peak Output Power	PASS
47 CFR Part 15, Subpart C 15.247(a)	Pseudorandom Frequency Hopping Sequence	PASS
47 CFR Part 15, Subpart C 15.247(a)(1)(iii)	Number of hopping frequency & Time of Occupancy	PASS
47 CFR Part 15, Subpart C 15.247(a)(1)	Frequency Separation	PASS
47 CFR Part 15, Subpart C 15.205/15.209	Radiated Emissions	PASS
47 CFR Part 15, Subpart C 15.247(d)	Band Edge Compliance of RF Emission	PASS
47 CFR Part 15, Subpart C 15.203/15.247 (b)	Antenna Requirement	PASS

### 1.3. Test Facility

#### 1.3.1 Address of the test laboratory

Shenzhen CTL Testing Technology Co., Ltd.  
Floor 1-A, Baisha Technology Park, No.3011, Shahexi Road, Nanshan District, Shenzhen, China  
518055

There is one 3m semi-anechoic chamber and two line conducted labs for final test. The Test Sites meet the requirements in documents ANSI C63.10 and CISPR 32/EN 55032 requirements.

#### 1.3.2 Laboratory accreditation

The test facility is recognized, certified, or accredited by the following organizations:

##### **CNAS-Lab Code: L7497**

Shenzhen CTL Testing Technology Co., Ltd. has been assessed and proved to be in compliance with CNAS-CL01 Accreditation Criteria for Testing and Calibration Laboratories (identical to ISO/IEC 17025: 2017 General Requirements) for the Competence of Testing and Calibration Laboratories.

##### **A2LA-Lab Cert. No. 4343.01**

Shenzhen CTL Testing Technology Co., Ltd, EMC Laboratory has been accredited by A2LA for technical competence in the field of electrical testing, and proved to be in compliance with ISO/IEC 17025: 2017 General Requirements for the Competence of Testing and Calibration Laboratories and any additional program requirements in the identified field of testing.

##### **IC Registration No.: 9618B**

##### **CAB identifier: CN0041**

The 3m alternate test site of Shenzhen CTL Testing Technology Co., Ltd. EMC Laboratory has been registered by Innovation, Science and Economic Development Canada to test to Canadian radio equipment requirements with Registration No.: 9618B.

##### **FCC-Registration No.: 399832**

##### **Designation No.: CN1216**

Shenzhen CTL Testing Technology Co., Ltd. EMC Laboratory has been registered and fully described in a report filed with the (FCC) Federal Communications Commission. The acceptance letter from the FCC is maintained in our files. Registration 399832.

### 1.4. Statement of the measurement uncertainty

The data and results referenced in this document are true and accurate. The reader is cautioned that there may be errors within the calibration limits of the equipment and facilities. The measurement uncertainty was calculated for all measurements listed in this test report acc. to CISPR 16 - 4 "Specification for radio disturbance and immunity measuring apparatus and methods – Part 4: Uncertainty in EMC Measurements" and is documented in the Shenzhen CTL Testing Technology Co., Ltd. quality system acc. to DIN EN ISO/IEC 17025. Furthermore, component and process variability of devices similar to that tested may result in additional deviation. The manufacturer has the sole responsibility of continued compliance of the device.

Hereafter the best measurement capability for CTL laboratory is reported:

Test	Measurement Uncertainty	Notes
Transmitter power Radiated	±2.20dB	(1)
Radiated Emission 9KHz~30MHz	±3.66dB	(1)
Radiated Emission 30~1000MHz	±4.10dB	(1)
Radiated Emission Above 1GHz	±4.32dB	(1)
20dB Emission Bandwidth	±1.9%	(1)

Carrier Frequency Separation	$\pm 1.9\%$	(1)
Maximum Power Spectral Density Level	$\pm 0.98$ dB	(1)
Number of Hopping Channel	$\pm 1.9\%$	(1)
Time of Occupancy	$\pm 0.11\%$	(1)
Max Peak Conducted Output Power	$\pm 0.98$ dB	(1)
Band-edge Spurious Emission	$\pm 1.21$ dB	(1)
Conducted RF Spurious Emission	9kHz-7GHz: $\pm 1.09$ dB 7GHz-26.5GHz: $\pm 3.27$ dB	(1)

(1) This uncertainty represents an expanded uncertainty expressed at approximately the 95% confidence level using a coverage factor of  $k=1.96$ .

## 2. GENERAL INFORMATION

### 2.1. Environmental conditions

During the measurement the environmental conditions were within the listed ranges:

Normal Temperature:	25°C
Relative Humidity:	55 %
Air Pressure:	101 kPa

### 2.2. General Description of EUT

Product Name:	WIRELESS HEADPHONES 2.0
Model/Type reference:	1686122-03
Power supply:	DC 3.7V from battery
<b>Bluetooth:</b>	
Version:	Supported BR/EDR
Modulation:	GFSK, $\pi/4$ DQPSK, 8DPSK
Operation frequency:	2402MHz to 2480MHz
Channel number:	79
Channel separation:	1MHz
Antenna type:	PCB Antenna
Antenna gain:	-0.68dBi

Note1: For more details, please refer to the user's manual of the EUT.

Note2: Antenna gain provided by the applicant.



## 2.3. Description of Test Modes and Test Frequency

The Applicant provides communication tools software to control the EUT for staying in continuous transmitting (Duty Cycle more than 98%) and receiving mode for testing .There are 79 channels provided to the EUT and Channel 00/39/78 were selected to test.

### Operation Frequency :

Channel	Frequency (MHz)
<b>00</b>	<b>2402</b>
01	2403
⋮	⋮
38	2440
<b>39</b>	<b>2441</b>
40	2442
⋮	⋮
77	2479
<b>78</b>	<b>2480</b>

Preliminary tests were performed in each mode and packet length of BT, and found worst case as bellow, finally test were conducted at those mode and recorded in this report.

Test Items	Worst case
Conducted Emissions	DH5 Middle channel
Radiated Emissions and Band Edge	DH5
Maximum Conducted Output Power	DH5/2DH5/3DH5
20dB Bandwidth	DH5/2DH5/3DH5
Frequency Separation	DH5/2DH5/3DH5 Middle channel
Number of hopping frequency	DH5/2DH5/3DH5
Time of Occupancy (Dwell Time)	DH1/DH3/DH5 Middle channel 2DH1/2DH3/2DH5 Middle channel 3DH1/3DH3/3DH5 Middle channel
Out-of-band Emissions	DH5/2DH5/3DH5

## 2.4. Equipments Used during the Test

Conducted Emission						
Item	Test Equipment	Manufacturer	Model No.	Serial No.	Last Cal.	Cal.Due
	EMI Test Receiver	ROHDE & SCHWARZ	ESCI	1166.5950.03	2024/04/30	2025/04/29
	LISN	ROHDE & SCHWARZ	ESH2-Z5	860014/010	2024/04/30	2025/04/29
	Limitator	ROHDE & SCHWARZ	ESH3-Z2	100408	2024/04/30	2025/04/29
Software:						
Name of Software:				Version:		
ES-K1				V1.71		

Radiated Emissions and Band Edge					
Test Equipment	Manufacturer	Model No.	Serial No.	Calibration Date	Calibration Due Date
Active Loop Antenna	Da Ze	ZN30900A	/	2024/04/30	2025/04/29
Double cone logarithmic antenna	Schwarzbeck	VULB 9168	824	2023/02/13	2026/02/12
Horn Antenna	Sunol Sciences Corp.	DRH-118	A062013	2021/12/23	2024/12/22
Horn Antenna	Ocean Microwave	OBH1004 00	26999002	2021/12/22	2024/12/21
Amplifier	MRT Technology(Suzhou)Co., Ltd	MRT-AP0 1M06	S-001	2024/04/30	2025/04/29
Amplifier	Agilent	8449B	3008A02306	2024/04/30	2025/04/29
Amplifier	Brief&Smart	LNA-4018	2104197	2024/05/03	2025/05/02
EMI Test Receiver	ROHDE & SCHWARZ	ESCI	1166.5950.03	2024/04/30	2025/04/29
Spectrum Analyzer	RS	FSP	1164.4391.38	2024/05/03	2025/05/02
Test software					
Name of Software			Version		
EZ_EMG(Below 1GHz)			V1.1.4.2		
EZ_EMG(Above 1GHz)			V1.1.4.2		

Maximum Peak Output Power & 20dB Bandwidth & Frequency Separation & Number of hopping frequency & Dwell Time & Out-of-band Emissions					
Test Equipment	Manufacturer	Model No.	Serial No.	Calibration Date	Calibration Due Date
Spectrum Analyzer	Keysight	N9020A	MY53420874	2024/05/01	2025/04/30
Temperature/Humidity Meter	Ji Yu	MC501	/	2024/05/04	2025/05/03
Test Software					

Name of Software	Version
TST-PASS	V2.0

## 2.5. Related Submittal(s) / Grant (s)

This submittal(s) (test report) is intended to comply with Section 15.247 of the FCC Part 15, Subpart C Rules.

## 2.6. Modifications

No modifications were implemented to meet testing criteria.

### 3. TEST CONDITIONS AND RESULTS

#### 3.1. Conducted Emissions Test

##### LIMIT

FCC CFR Title 47 Part 15 Subpart C Section 15.207

Frequency range (MHz)	Limit (dBuV)	
	Quasi-peak	Average
0.15-0.5	66 to 56*	56 to 46*
0.5-5	56	46
5-30	60	50

\* Decreases with the logarithm of the frequency.

##### TEST CONFIGURATION

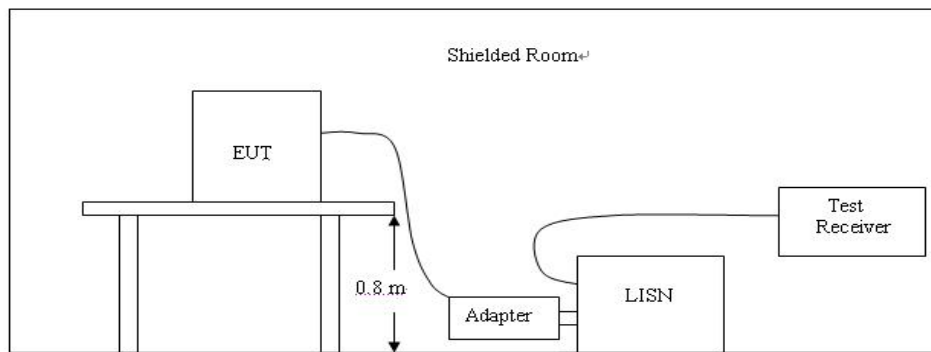

##### TEST PROCEDURE

1. The equipment was set up as per the test configuration to simulate typical actual usage per the user's manual. The EUT is a tabletop system; a wooden table with a height of 0.8 meters is used and is placed on the ground plane as per ANSI C63.10:2013.
2. Support equipment, if needed, was placed as per ANSI C63.10:2013.
3. All I/O cables were positioned to simulate typical actual usage as per ANSI C63.10:2013.
4. The adapter received AC120V/60Hz power through a Line Impedance Stabilization Network (LISN) which supplied power source and was grounded to the ground plane.
5. All support equipments received AC power from a second LISN, if any.
6. The EUT test program was started. Emissions were measured on each current carrying line of the EUT using a spectrum Analyzer / Receiver connected to the LISN powering the EUT. The LISN has two monitoring points: Line 1 (Hot Side) and Line 2 (Neutral Side). Two scans were taken: one with Line 1 connected to Analyzer / Receiver and Line 2 connected to a 50 ohm load; the second scan had Line 1 connected to a 50 ohm load and Line 2 connected to the Analyzer / Receiver.
7. Analyzer / Receiver scanned from 150 KHz to 30MHz for emissions in each of the test modes.
8. During the above scans, the emissions were maximized by cable manipulation.

**TEST RESULTS**

Remark: All modes of GFSK, Pi/4 DQPSK, and 8DPSK were test at Low, Middle, and High channel; only the worst result of GFSK Low Channel was reported as below:

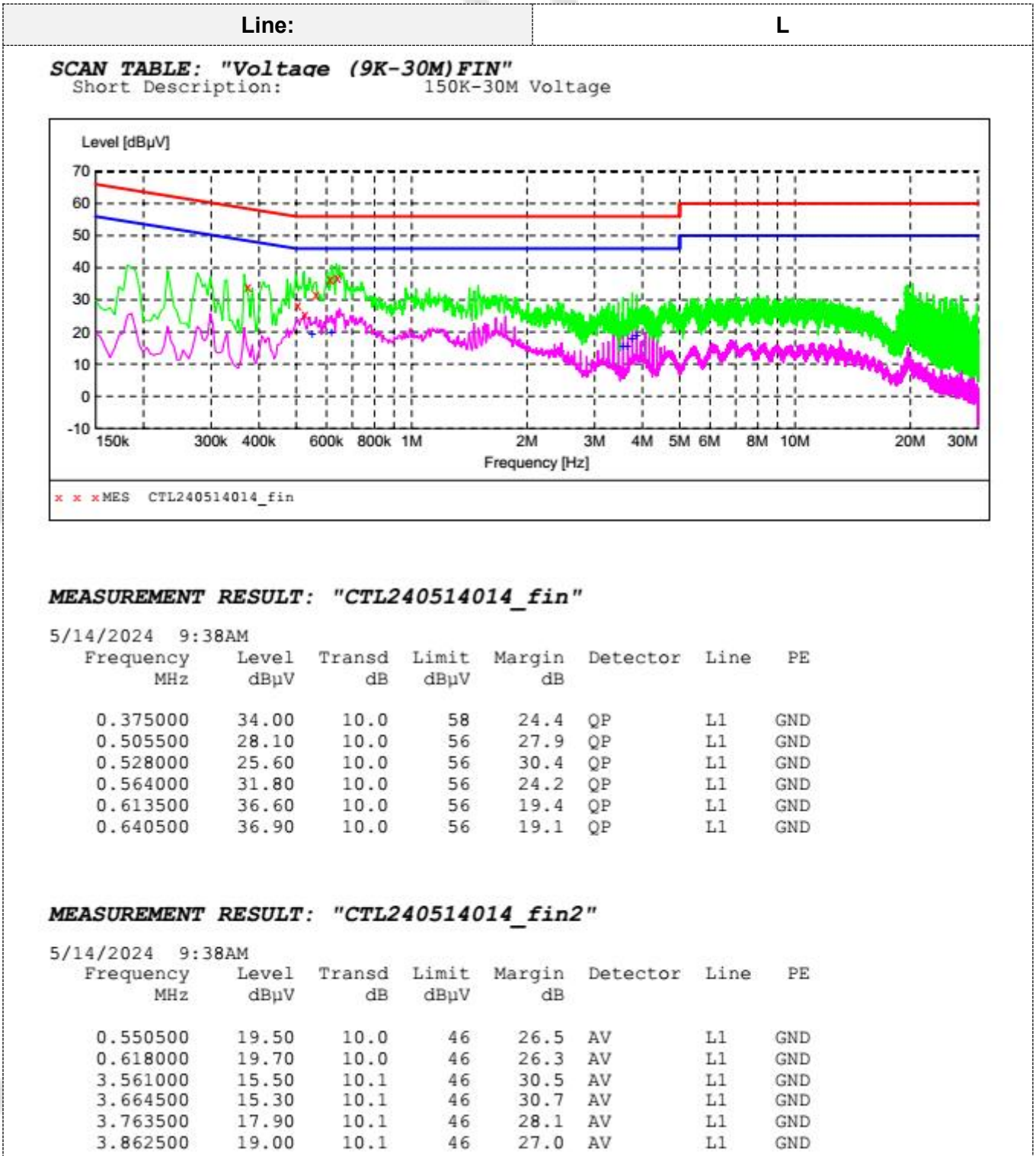

Line:

N

**SCAN TABLE: "Voltage (9K-30M)FIN"**

Short Description: 150K-30M Voltage

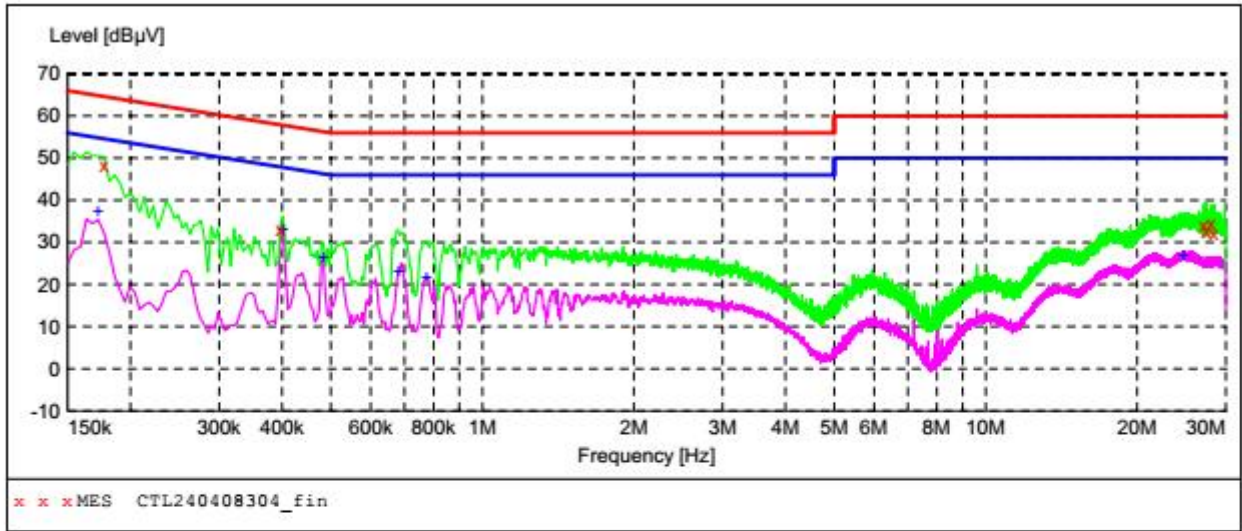

**MEASUREMENT RESULT: "CTL240408304\_fin"**

4/8/2024 6:27PM

Frequency MHz	Level dBµV	Transd dB	Limit dBµV	Margin dB	Detector	Line	PE
0.177000	48.50	10.0	65	16.1	QP	N	GND
0.397500	32.90	10.0	58	25.0	QP	N	GND
27.150000	34.00	10.4	60	26.0	QP	N	GND
27.433500	32.80	10.3	60	27.2	QP	N	GND
28.045500	34.50	10.3	60	25.5	QP	N	GND
28.347000	32.20	10.3	60	27.8	QP	N	GND

**MEASUREMENT RESULT: "CTL240408304\_fin2"**

4/8/2024 6:27PM

Frequency MHz	Level dBµV	Transd dB	Limit dBµV	Margin dB	Detector	Line	PE
0.172500	37.20	10.0	55	17.6	AV	N	GND
0.402000	33.20	10.0	48	14.6	AV	N	GND
0.483000	26.30	10.0	46	20.0	AV	N	GND
0.681000	23.10	10.0	46	22.9	AV	N	GND
0.775500	21.70	10.0	46	24.3	AV	N	GND
24.810000	26.80	10.6	50	23.2	AV	N	GND

### 3.2. Radiated Emissions and Band Edge

#### Limit

For intentional device, according to § 15.209(a), the general requirement of field strength of radiated emission out of authorized band shall not exceed the following table at a 3 meters measurement distance.

In addition, radiated emissions which fall in the restricted bands, as defined in §15.205(a), must also comply with the radiated emission limits specified in §15.209(a)

Radiated emission limits

Frequency (MHz)	Distance (Meters)	Radiated (dBµV/m)	Radiated (µV/m)
0.009-0.49	3	$20\log(2400/F(\text{KHz}))+40\log(300/3)$	$2400/F(\text{KHz})$
0.49-1.705	3	$20\log(24000/F(\text{KHz}))+ 40\log(30/3)$	$24000/F(\text{KHz})$
1.705-30	3	$20\log(30)+ 40\log(30/3)$	30
30-88	3	40.0	100
88-216	3	43.5	150
216-960	3	46.0	200
Above 960	3	54.0	500

#### TEST CONFIGURATION

(A) Radiated Emission Test Set-Up, Frequency Below 30MHz

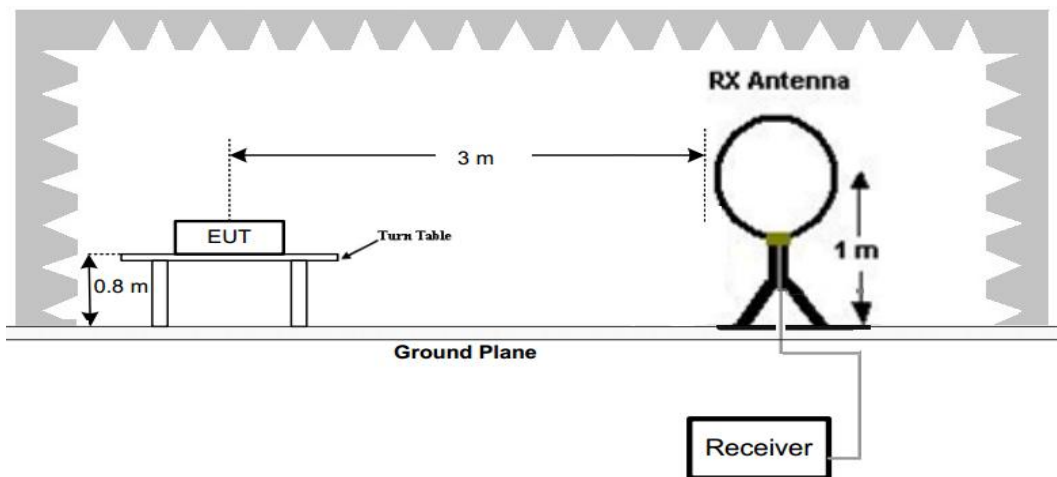

(B) Radiated Emission Test Set-Up, Frequency below 1000MHz

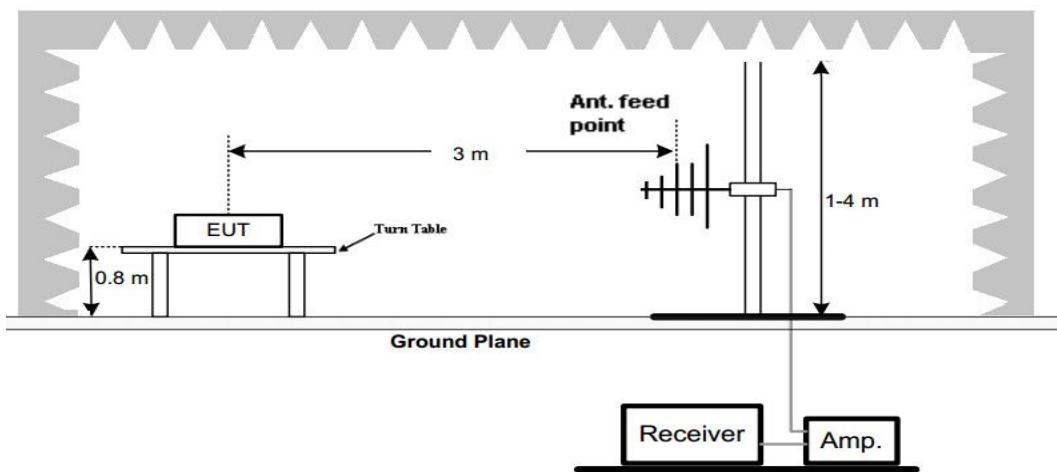

(C) Radiated Emission Test Set-Up, Frequency above 1000MHz

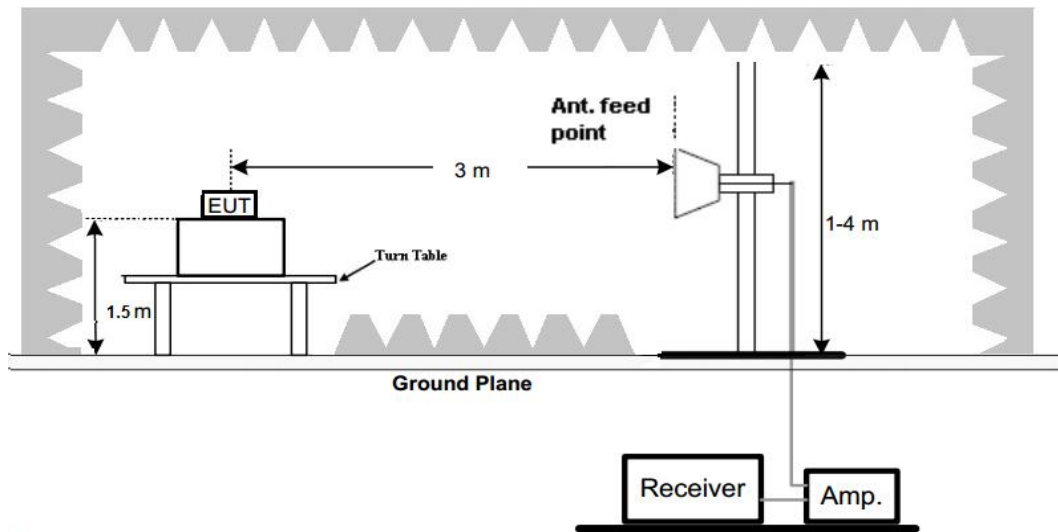

### Test Procedure

1. Below 1GHz measurement the EUT is placed on a turntable which is 0.8m above ground plane, and above 1GHz measurement EUT was placed on a low permittivity and low loss tangent turn table which is 1.5m above ground plane.
2. Maximum procedure was performed by raising the receiving antenna from 1m to 4m and rotating the turn table from 0° to 360° to acquire the highest emissions from EUT
3. And also, each emission was to be maximized by changing the polarization of receiving antenna both horizontal and vertical.
4. Repeat above procedures until all frequency measurements have been completed.
5. The EUT was pretested with 3 orientations placed on the table for the radiated emission measurement –X, Y, and Z-plane. The X-plane results were found as the worst case and were shown in this report.

### TEST RESULTS

#### Remark:

1. We measured Radiated Emission at GFSK,  $\pi/4$  DQPSK and 8DPSK mode from 9 KHz to 25GHz and recorded worst case at GFSK DH5 mode..
2. For below 1GHz testing recorded worst at GFSK DH5 low channel.
3. Radiated emission test from 9 KHz to 10th harmonic of fundamental was verified, Found the emission level are attenuated 20dB below the limits from 9 kHz to 30MHz, so it does not recorded in report.



For 30MHz-1GHz

Horizontal



Shenzhen CTL Testing Technology Co., Ltd  
Tel: +86-755-89486194

Radiated Emission Measurement

File :RF Data :#8822 Date: 2024/05/13 Time: 19:34:25

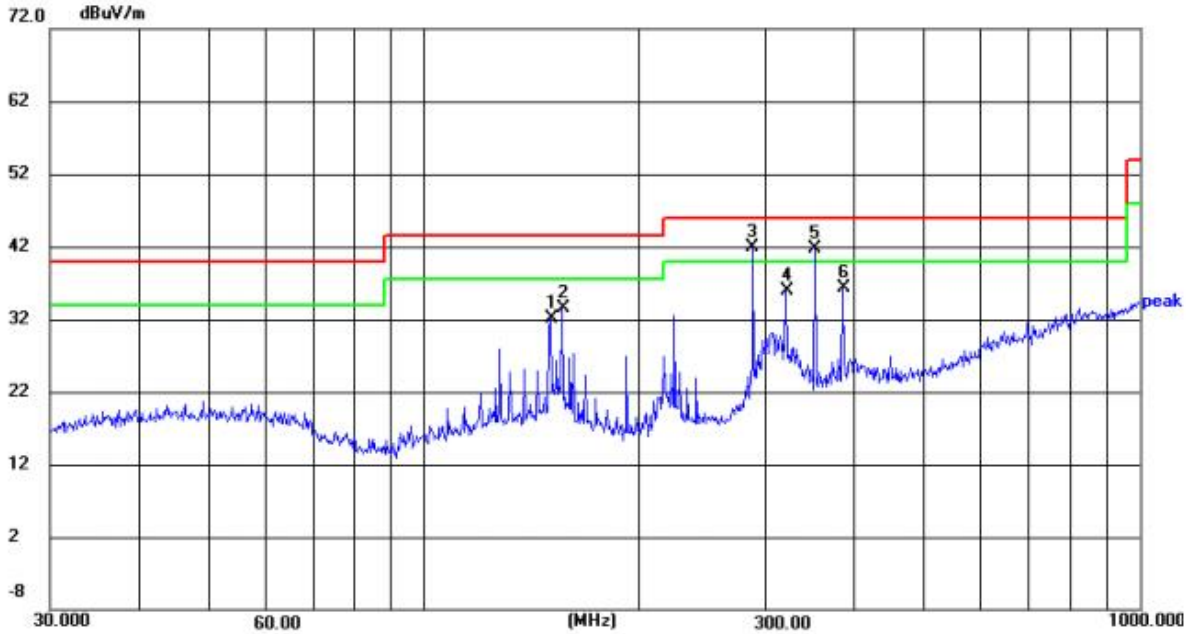

Site LAB Chamber 2 Polarization: **Horizontal** Temperature: 25(C)  
 Limit: FCC Part15 RE-Class C\_30-1000MHz Power: Humidity: 50 %  
 EUT: / Distance: 3m  
 M/N: 1686122-03  
 Mode: BT 2402MHz  
 Note: TOPAUL TECHNOLOGY LIMITED

No.	Frequency (MHz)	Reading (dBuV)	Factor (dB/m)	Level (dBuV/m)	Limit (dBuV/m)	Margin (dB)	Detector	Height (cm)	Azimuth (deg.)	P/F	Remark
1	150.0108	18.22	13.80	32.02	43.50	11.48	peak	100	360	P	
2	156.0468	19.73	13.81	33.54	43.50	9.96	peak	100	14	P	
3	287.9904	27.72	14.12	41.84	46.00	4.16	peak	100	80	P	
4	320.2175	20.84	15.06	35.90	46.00	10.10	peak	100	102	P	
5	352.0163	25.92	15.86	41.78	46.00	4.22	peak	100	135	P	
6	384.1001	19.47	16.91	36.38	46.00	9.62	peak	100	238	P	

Vertical



Shenzhen CTL Testing Technology Co., Ltd  
Tel: +86-755-89486194

Radiated Emission Measurement

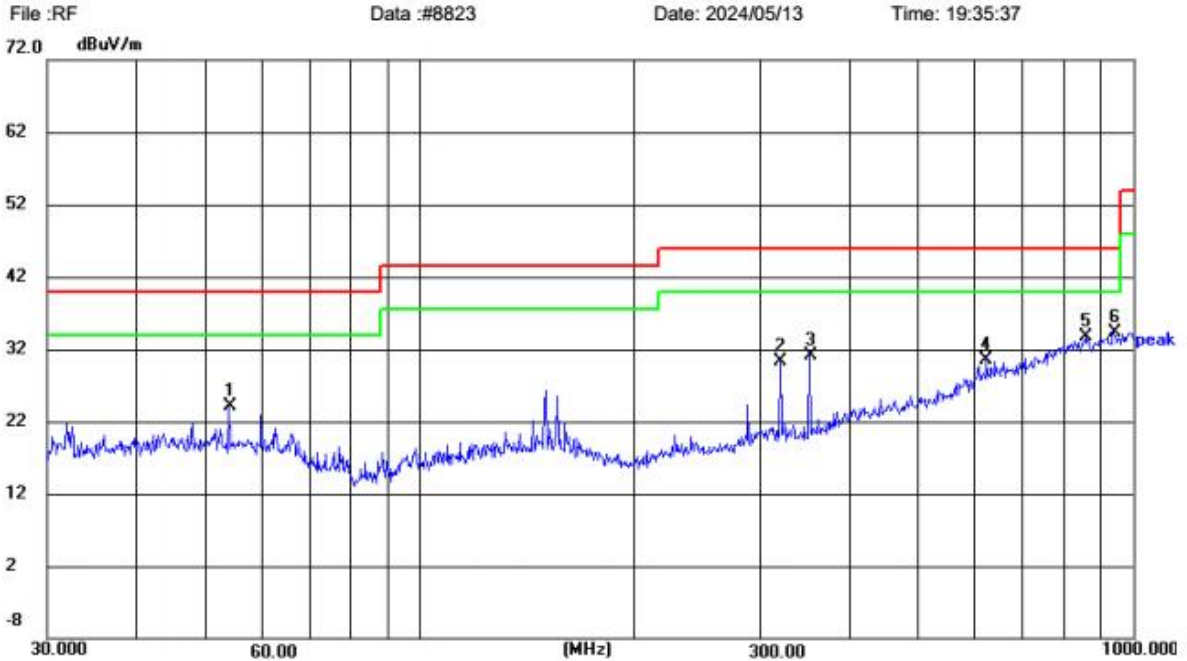

Site LAB Chamber 2 Polarization: **Vertical** Temperature: 25(C)  
 Limit: FCC Part15 RE-Class C\_30-1000MHz Power: Humidity: 50 %  
 EUT: / Distance: 3m  
 M/N: 1686122-03  
 Mode: BT 2402MHz  
 Note: TOPAUL TECHNOLOGY LIMITED

No.	Frequency (MHz)	Reading (dBUV)	Factor (dB/m)	Level (dBUV/m)	Limit (dBUV/m)	Margin (dB)	Detector	Height (cm)	Azimuth (deg.)	P/F	Remark
1	54.0237	9.96	14.22	24.18	40.00	15.82	peak	100	328	P	
2	320.0772	15.34	15.06	30.40	46.00	15.60	peak	100	67	P	
3	352.0164	15.15	15.86	31.01	46.00	14.99	peak	100	144	P	
4	623.4363	8.15	22.26	30.41	46.00	15.59	peak	100	314	P	
5	858.1524	7.29	26.34	33.63	46.00	12.37	peak	100	236	P	
6	940.0680	7.23	27.09	34.32	46.00	11.68	peak	100	225	P	

For 1GHz to 25GHz

Horizontal



Shenzhen CTL Testing Technology Co., Ltd  
Tel: +86-755-89486194

Radiated Emission Measurement

File :RF-RSE 4

Data :#6835

Date: 2024/05/13

Time: 21:17:15

80.0 dBuV/m



Site LAB Chamber 2

Polarization: *Horizontal*

Temperature: 25(C)

Limit: FCC Part15 RE-Class C\_Above 1GHz\_PK

Power:

Humidity: 50 %

EUT:

Distance: 3m

M/N: 1686122-03

Mode: BT 2402MHz TX

Note: TOPAUL TECHNOLOGY LIMITED

No.	Frequency (MHz)	Reading (dBuV)	Factor (dB/m)	Level (dBuV/m)	Limit (dBuV/m)	Margin (dB)	Detector	Height (cm)	Azimuth (deg.)	P/F	Remark
1	4803.750	64.35	-8.09	56.26	74.00	17.74	peak	150	252	P	
2	4804.132	55.83	-8.09	47.74	54.00	6.26	AVG	150	360	P	
3	7205.000	62.36	-3.29	59.07	74.00	14.93	peak	150	279	P	
4	7206.193	53.63	-3.29	50.34	54.00	3.66	AVG	150	0	P	
5	9608.331	47.91	0.45	48.36	54.00	5.64	AVG	150	360	P	
6	9608.375	54.28	0.45	54.73	74.00	19.27	peak	150	313	P	
7	12364.500	47.52	2.21	49.73	74.00	24.27	peak	150	107	P	
8	13762.750	48.76	3.79	52.55	74.00	21.45	peak	150	234	P	
9	16187.375	46.33	5.20	51.53	74.00	22.47	peak	150	155	P	

Vertical



Shenzhen CTL Testing Technology Co., Ltd  
Tel: +86-755-89486194

Radiated Emission Measurement

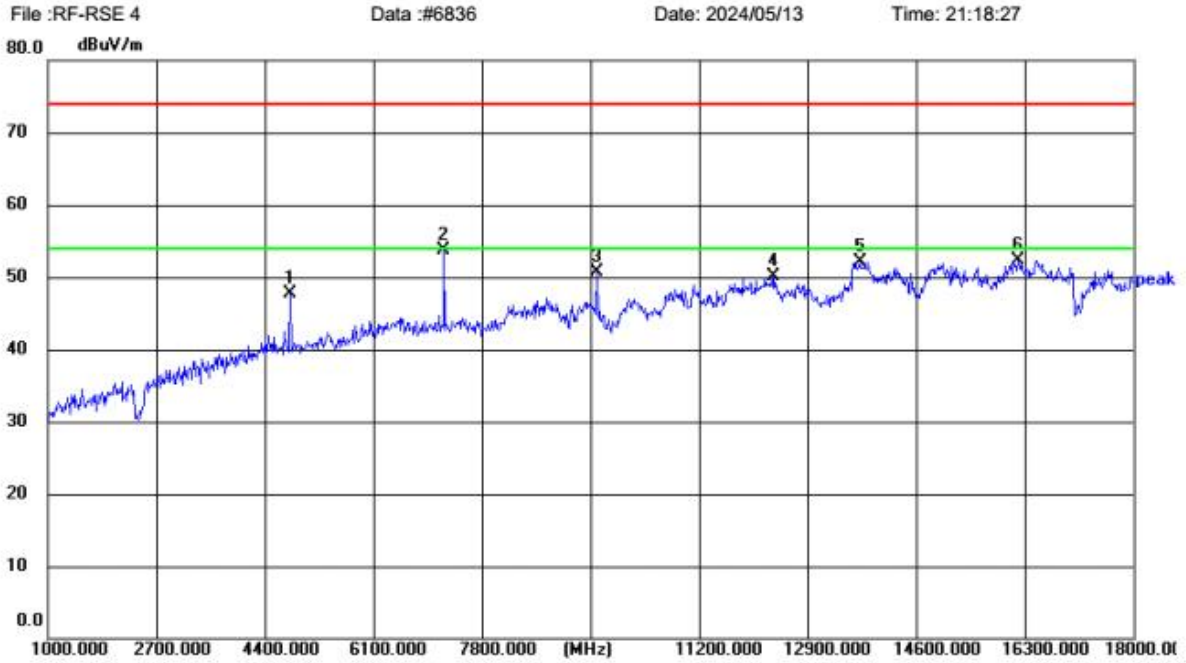

Site LAB Chamber 2      Polarization: **Vertical**      Temperature: 25(C)  
 Limit: FCC Part15 RE-Class C\_Above 1GHz\_PK      Power:      Humidity: 50 %  
 EUT:      Distance: 3m  
 M/N: 1686122-03  
 Mode: BT 2402MHz TX  
 Note: TOPAUL TECHNOLOGY LIMITED

No.	Frequency (MHz)	Reading (dBuV)	Factor (dB/m)	Level (dBuV/m)	Limit (dBuV/m)	Margin (dB)	Detector	Height (cm)	Azimuth (deg.)	P/F	Remark
1	4803.750	55.81	-8.09	47.72	74.00	26.28	peak	150	305	P	
2	7205.000	57.06	-3.29	53.77	74.00	20.23	peak	150	197	P	
3	9608.375	50.21	0.45	50.66	74.00	23.34	peak	150	208	P	
4	12375.125	47.98	2.22	50.20	74.00	23.80	peak	150	182	P	
5	13720.250	48.24	3.86	52.10	74.00	21.90	peak	150	298	P	
6	16212.875	47.04	5.27	52.31	74.00	21.69	peak	150	46	P	

REMARKS:

- 18GHz-26GHz not recorded for no spurious point have a margin of less than 6 dB with respect to the limits.
- PK detector measurement value is lower than the average limit. Therefore, there is no need to test AV detector measurements.

**Results of Band Edges Test (Radiated)**

Note: All modulations have been tested, only worse case GFSK is reported.

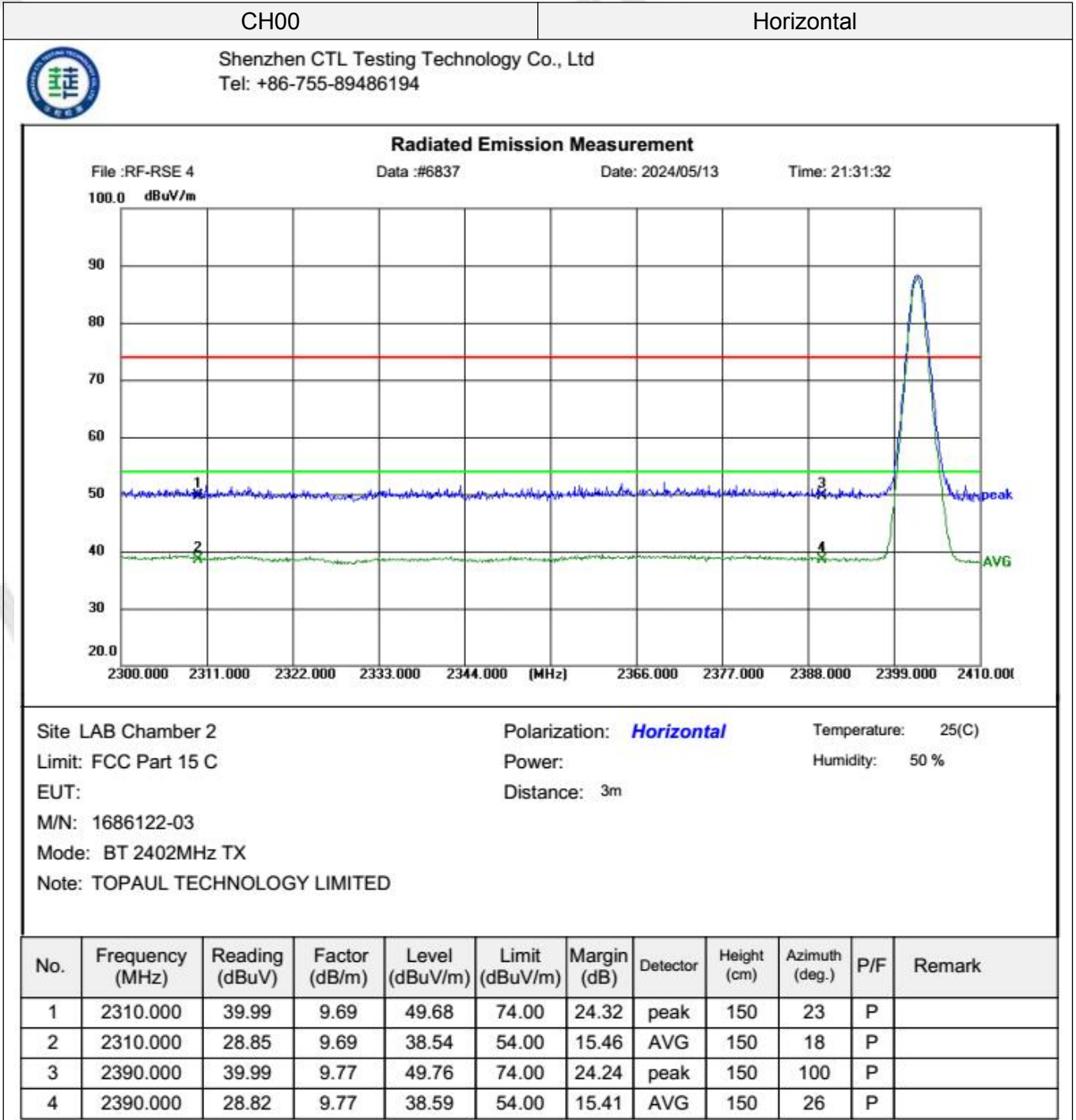

CH00

Vertical



Shenzhen CTL Testing Technology Co., Ltd  
Tel: +86-755-89486194

**Radiated Emission Measurement**

File :RF-RSE 4

Data :#6838

Date: 2024/05/13

Time: 21:32:46

100.0 dBuV/m

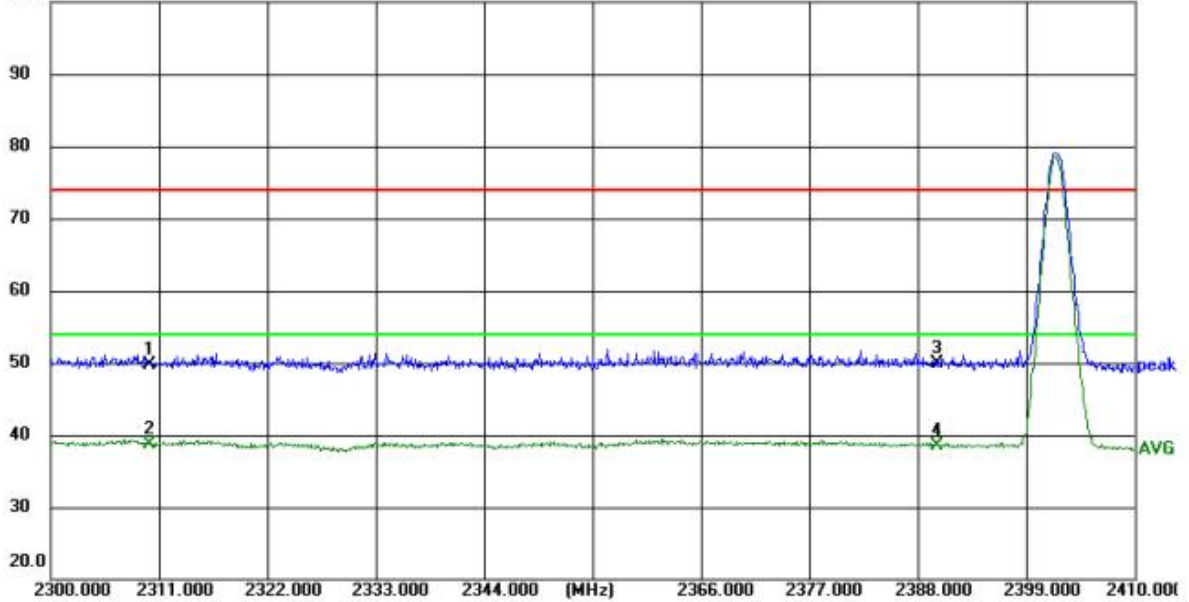

Site LAB Chamber 2

Polarization: **Vertical**

Temperature: 25(C)

Limit: FCC Part 15 C

Power:

Humidity: 50 %

EUT:

Distance: 3m

M/N: 1686122-03

Mode: BT 2402MHz TX

Note: TOPAUL TECHNOLOGY LIMITED

No.	Frequency (MHz)	Reading (dBuV)	Factor (dB/m)	Level (dBuV/m)	Limit (dBuV/m)	Margin (dB)	Detector	Height (cm)	Azimuth (deg.)	P/F	Remark
1	2310.000	40.02	9.69	49.71	74.00	24.29	peak	150	113	P	
2	2310.000	29.07	9.69	38.76	54.00	15.24	AVG	150	113	P	
3	2399.000	40.17	9.77	49.94	74.00	24.06	peak	150	22	P	
4	2399.000	28.83	9.77	38.60	54.00	15.40	AVG	150	47	P	

CH78

Horizontal



Shenzhen CTL Testing Technology Co., Ltd  
Tel: +86-755-89486194

**Radiated Emission Measurement**

File :RF-RSE 4

Data :#6839

Date: 2024/05/13

Time: 21:35:54

100.0 dBuV/m

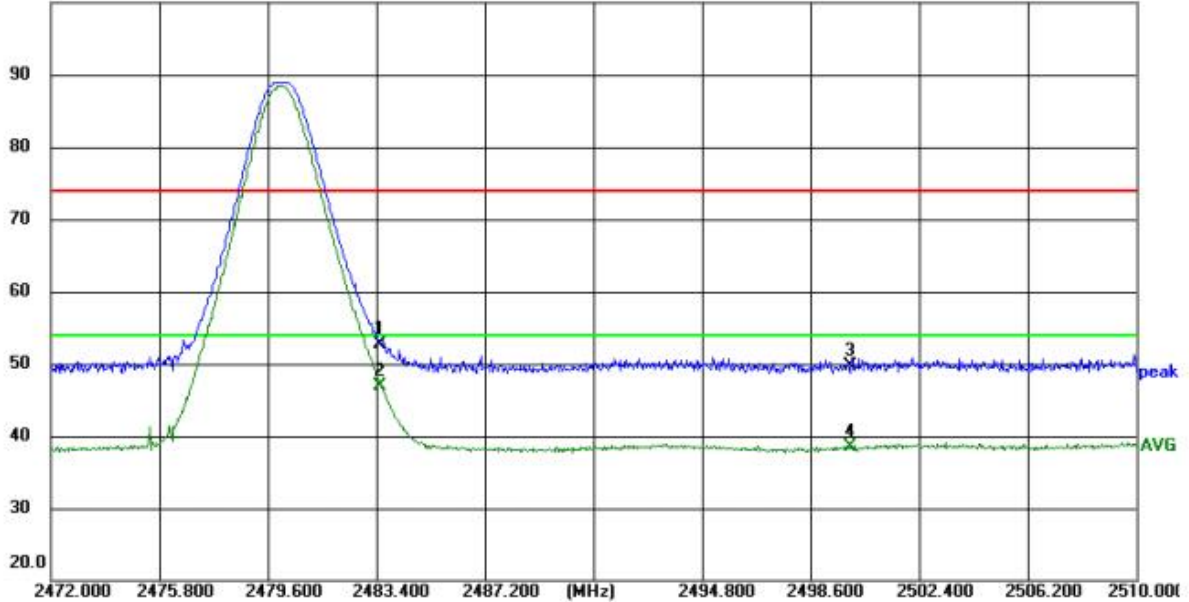

Site LAB Chamber 2

Polarization: **Horizontal**

Temperature: 25(C)

Limit: FCC Part 15 C

Power:

Humidity: 50 %

EUT:

Distance: 3m

M/N: 1686122-03

Mode: BT 2480MHz TX

Note: TOPAUL TECHNOLOGY LIMITED

No.	Frequency (MHz)	Reading (dBuV)	Factor (dB/m)	Level (dBuV/m)	Limit (dBuV/m)	Margin (dB)	Detector	Height (cm)	Azimuth (deg.)	P/F	Remark
1	2483.500	42.74	9.93	52.67	74.00	21.33	peak	150	127	P	
2	2483.500	36.94	9.93	46.87	54.00	7.13	AVG	150	302	P	
3	2500.000	39.61	10.00	49.61	74.00	24.39	peak	150	327	P	
4	2500.000	28.42	10.00	38.42	54.00	15.58	AVG	150	327	P	

CH78

Vertical



Shenzhen CTL Testing Technology Co., Ltd  
Tel: +86-755-89486194

**Radiated Emission Measurement**

File :RF-RSE 4

Data :#6840

Date: 2024/05/13

Time: 21:37:08

100.0 dBuV/m

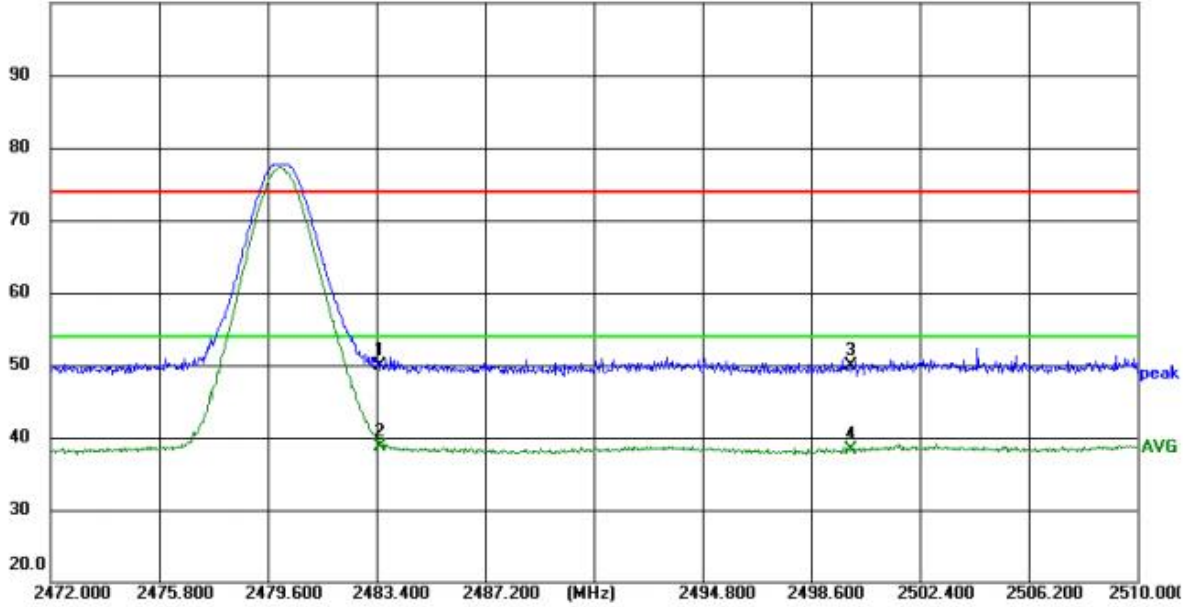

Site LAB Chamber 2

Polarization: **Vertical**

Temperature: 25(C)

Limit: FCC Part 15 C

Power:

Humidity: 50 %

EUT:

Distance: 3m

M/N: 1686122-03

Mode: BT 2480MHz TX

Note: TOPAUL TECHNOLOGY LIMITED

No.	Frequency (MHz)	Reading (dBuV)	Factor (dB/m)	Level (dBuV/m)	Limit (dBuV/m)	Margin (dB)	Detector	Height (cm)	Azimuth (deg.)	P/F	Remark
1	2483.500	39.97	9.93	49.90	74.00	24.10	peak	150	208	P	
2	2483.500	28.80	9.93	38.73	54.00	15.27	AVG	150	83	P	
3	2500.000	39.94	10.00	49.94	74.00	24.06	peak	150	50	P	
4	2500.000	28.34	10.00	38.34	54.00	15.66	AVG	150	50	P	



### 3.3. Maximum Peak Output Power

#### Limit

For frequency hopping systems operating in the 2400-2483.5 MHz band employing at least 75 non-overlapping hopping channels: 1 watt.

For all other frequency hopping systems in the 2400-2483.5 MHz band: 0.125 watts.

#### Test Procedure

Remove the antenna from the EUT and then connect a low loss RF cable from the antenna port to the spectrum.

#### Test Configuration

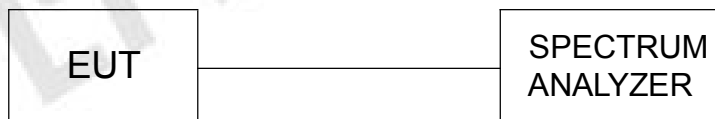

#### Test Results

Raw data reference to Section 2 of document No. CTL2405117011-WF\_Bluetooth\_Appendix.

### 3.4. 20dB Bandwidth

#### Limit

For frequency hopping systems operating in the 2400MHz-2483.5MHz no limit for 20dB bandwidth.

#### Test Procedure

The transmitter output was connected to the spectrum analyzer through an attenuator. The bandwidth of the fundamental frequency was measured by spectrum analyzer with 30 KHz RBW and 91 KHz VBW.

The 20dB bandwidth is defined as the total spectrum the power of which is higher than peak power minus 20dB.

#### Test Configuration



#### Test Results

Raw data reference to Section 1 of document No. CTL2405117011-WF\_Bluetooth\_Appendix.

### 3.5. Frequency Separation

#### LIMIT

According to 15.247(a)(1), frequency hopping systems shall have hopping channel carrier frequencies separated by minimum of 25KHz or the  $2/3 \times 20\text{dB}$  bandwidth of the hopping channel, whichever is greater.

#### TEST PROCEDURE

The transmitter output was connected to the spectrum analyzer through an attenuator. The bandwidth of the fundamental frequency was measured by spectrum analyzer with 300 KHz RBW and 300 KHz VBW.

#### TEST CONFIGURATION



#### TEST RESULTS

Raw data reference to Section 3 of document No. CTL2405117011-WF\_Bluetooth\_Appendix.

### 3.6. Number of hopping frequency

#### Limit

Frequency hopping systems in the 2400–2483.5 MHz band shall use at least 15 channels.

#### Test Procedure

The transmitter output was connected to the spectrum analyzer through an attenuator. Set spectrum analyzer start 2400MHz to 2483.5MHz with 300 KHz RBW and 300 KHz VBW.

#### Test Configuration



#### Test Results

Raw data reference to Section 4 of document No. CTL2405117011-WF\_Bluetooth\_Appendix.

### 3.7. Time of Occupancy (Dwell Time)

#### Limit

The average time of occupancy on any channel shall not be greater than 400 milliseconds within a period of 400 milliseconds multiplied by the number of hopping channels employed.

#### Test Procedure

The transmitter output was connected to the spectrum analyzer through an attenuator. Set center frequency of spectrum analyzer=operating frequency with 910 KHz RBW and 910 KHz VBW, Span 0Hz.

#### Test Configuration



#### Test Results

Raw data reference to Section 5 of document No. CTL2405117011-WF\_Bluetooth\_Appendix.

### 3.8. Out-of-band Emissions

#### Limit

In any 100 kHz bandwidth outside the frequency band in which the spread spectrum or digitally modulated intentional radiator is operating, the radio frequency power that is produced by the intentional radiator shall be at least 20 dB below that in the 100 kHz bandwidth within the band that contains the highest level of the desired power, based on either an RF conducted or a radiated measurement, provided the transmitter demonstrates compliance with the peak conducted power limits. If the transmitter complies with the conducted power limits based on the use of RMS averaging over a time interval, as permitted under paragraph (b)(3) of this section, the attenuation required under this paragraph shall be 30 dB instead of 20 dB. Attenuation below the general limits specified in §15.209(a) is not required.

#### Test Procedure

Connect the transmitter output to spectrum analyzer using a low loss RF cable, and set the spectrum analyzer to RBW=100 kHz, VBW= 300 kHz, peak detector, and max hold. Measurements utilizing these settings are made of the in-band reference level, band-edge and out-of-band emissions.

#### Test Configuration



#### Test Results

Raw data reference to Section 6 of document No. CTL2405117011-WF\_Bluetooth\_Appendix.

### 3.9. Pseudorandom Frequency Hopping Sequence

#### TEST APPLICABLE

#### **For 47 CFR Part 15C section 15.247 (a) (1) requirement:**

Frequency hopping systems shall have hopping channel carrier frequencies separated by a minimum of 25 kHz or the 20 dB bandwidth of the hop-ping channel, whichever is greater. Alternatively, frequency hopping systems operating in the 2400–2483.5 MHz band may have hopping channel carrier frequencies that are separated by 25 kHz or two-thirds of the 20 dB bandwidth of the hopping channel, whichever is greater, provided the systems operate with an output power no greater than 125 mW. The system shall hop to channel frequencies that are selected at the system hopping rate from a pseudo randomly ordered list of hopping frequencies. Each frequency must be used equally on the average by each transmitter. The system receivers shall have input bandwidths that match the hop-ping channel bandwidths of their corresponding transmitters and shall shift frequencies in synchronization with the transmitted signals.

#### **EUT Pseudorandom Frequency Hopping Sequence Requirement**

The pseudorandom frequency hopping sequence may be generated in a nine-stage shift register whose 5<sup>th</sup> and 9<sup>th</sup> stage outputs are added in a modulo-two addition stage. And the result is fed back to the input of the first stage. The sequence begins with the first one of 9 consecutive ones, for example: the shift register is initialized with nine ones.

- Number of shift register stages:9
- Length of pseudo-random sequence:29-1=511 bits
- Longest sequence of zeros:8(non-inverted signal)

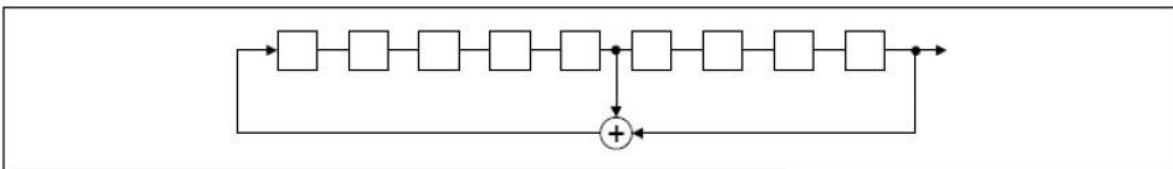

*Linear Feedback Shift Register for Generation of the PRBS sequence*

An example of pseudorandom frequency hopping sequence as follows:

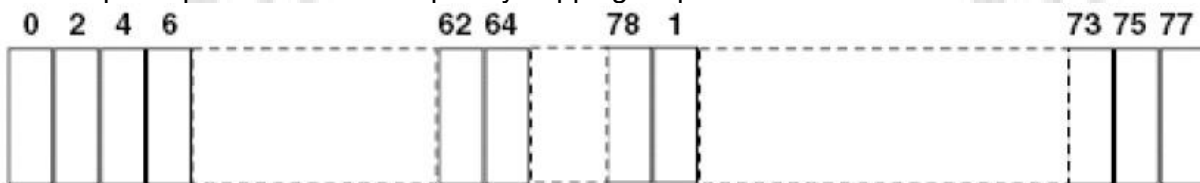

Each frequency used equally one the average by each transmitter.

The system receiver have input bandwidths that match the hopping channel bandwidths of their corresponding transmitter and shift frequencies in synchronization with the transmitted signals.

### 3.10. Antenna Requirement

#### Standard Applicable

For intentional device, according to FCC 47 CFR Section 15.203, an intentional radiator shall be designed to ensure that no antenna other than that furnished by the responsible party shall be used with the device.

And according to FCC 47 CFR Section 15.247 (b), if transmitting antennas of directional gain greater than 6dBi are used, the power shall be reduced by the amount in dB that the directional gain of the antenna exceeds 6dBi.

#### **Refer to statement below for compliance**

The manufacturer may design the unit so that the user can replace a broken antenna, but the use of a standard antenna jack or electrical connector is prohibited. Further, this requirement does not apply to intentional radiators that must be professionally installed.

#### Antenna Connected Construction

The maximum gain of antenna was -0.68dBi.

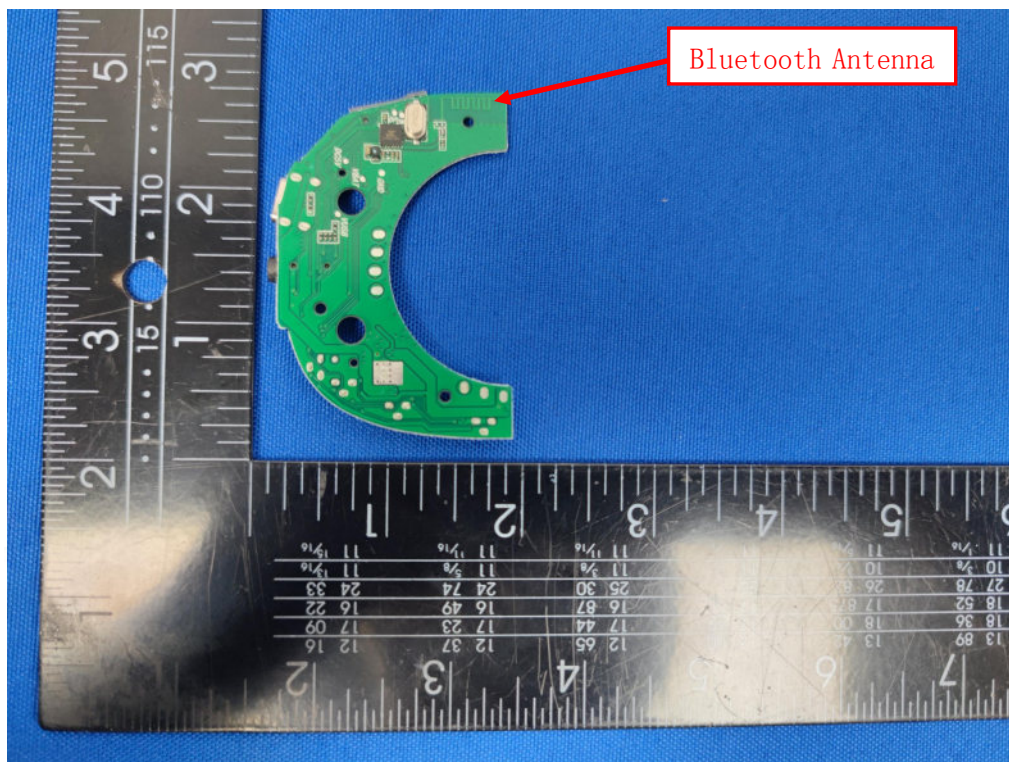



### 4. Test Setup Photos of the EUT

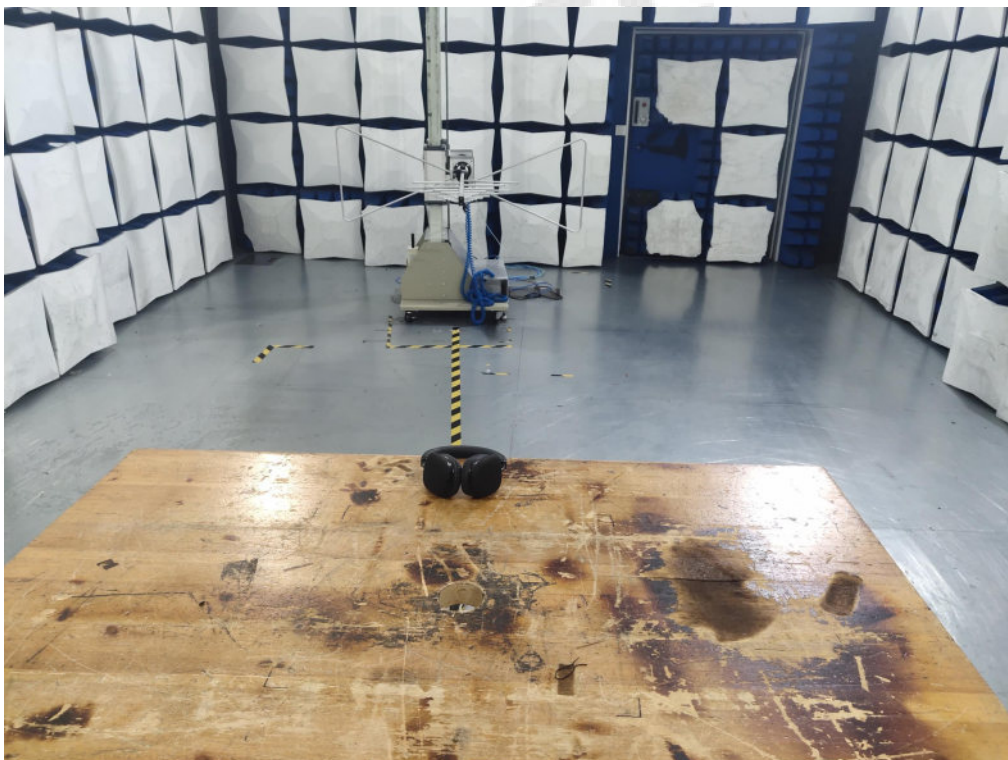



## 5. Photos of the EUT

### External Photos of EUT









Internal Photos of EUT

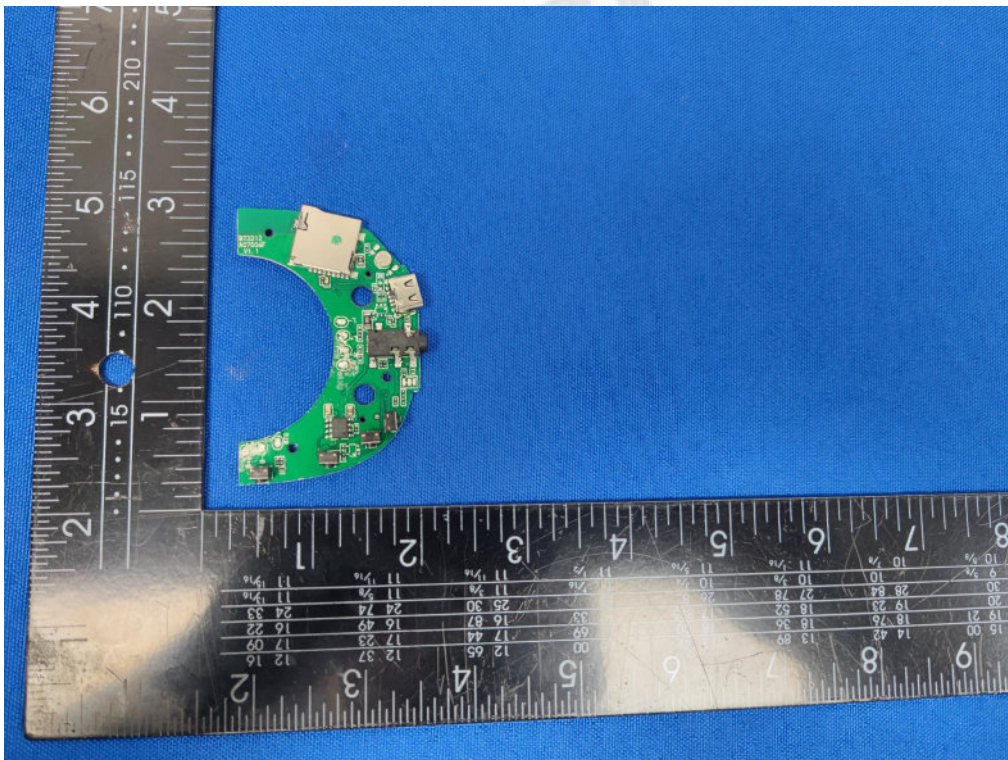

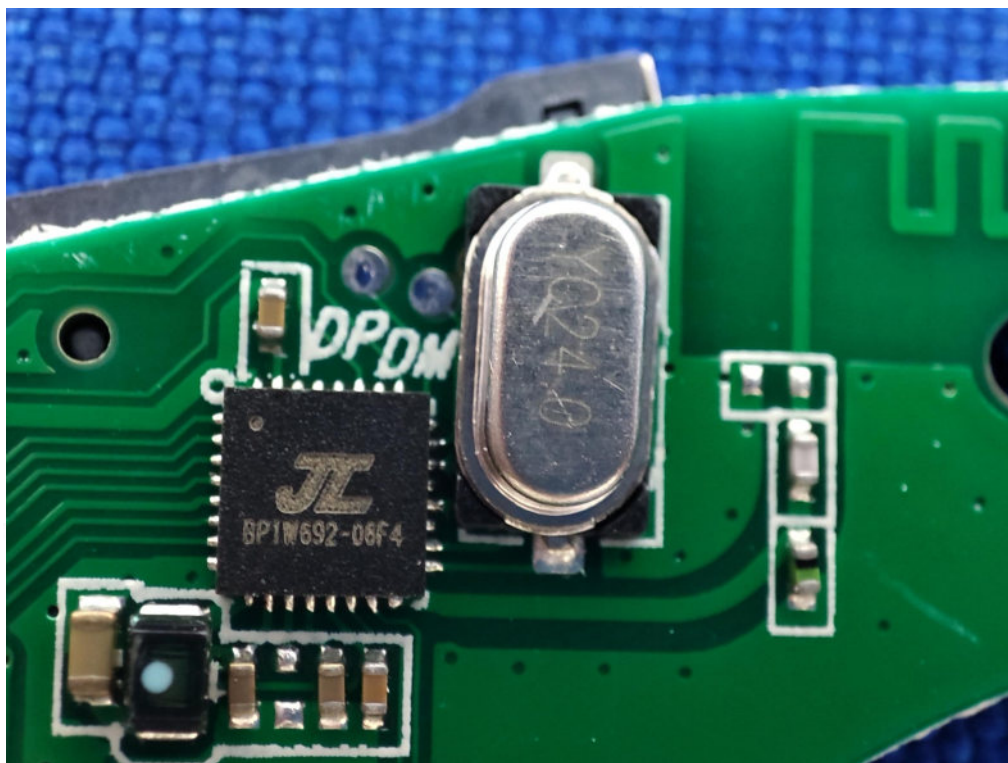
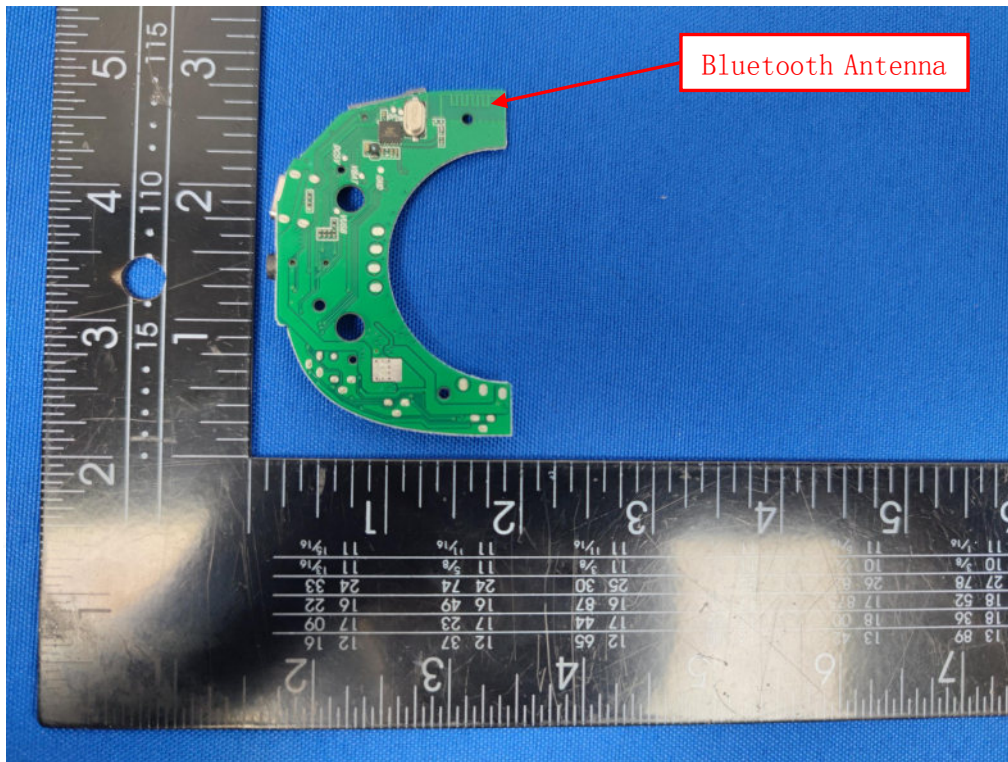



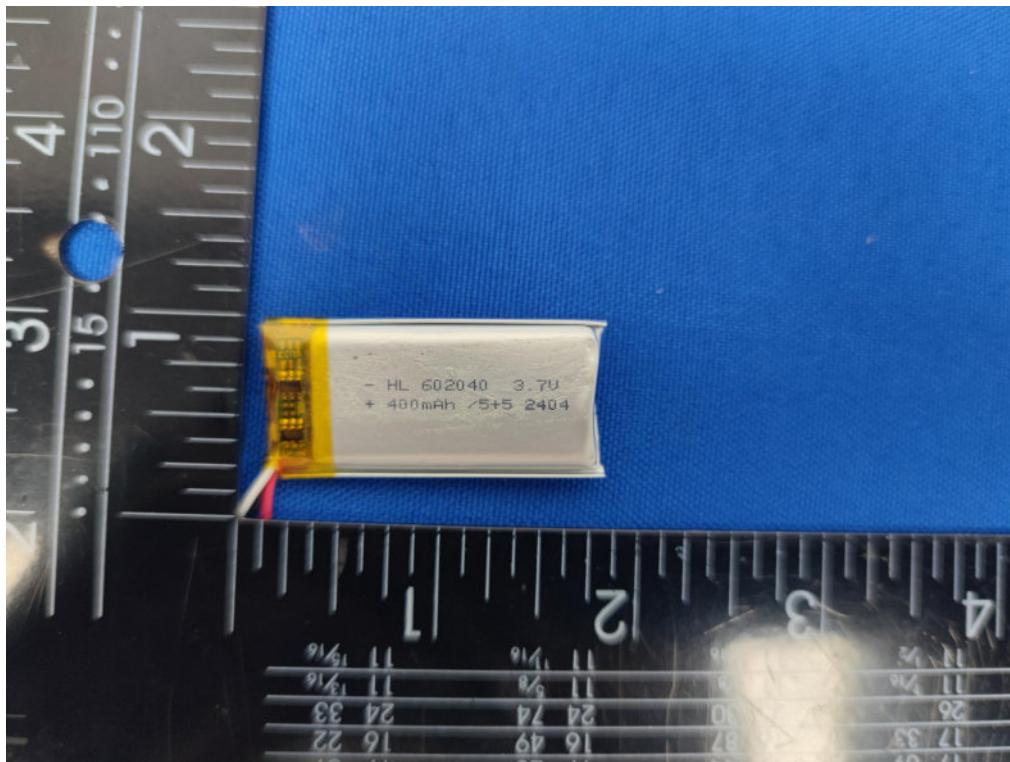

\*\*\*\*\* End of Report \*\*\*\*\*