

FCC TEST REPORT

FOR

Cotton On USA Inc

USB Dongle

Test Model: 141902-00  
Additional No.: 141902-01

Prepared for : **Cotton On USA Inc**  
Address : 16511, Trojan Way, La Miranda, California 90638, United States

Prepared by : Shenzhen LCS Compliance Testing Laboratory Ltd.  
Address : 1/F., Xingyuan Industrial Park, Tongda Road, Bao'an Avenue,  
Bao'an District, Shenzhen,Guangdong, China

Tel : (+86)755-82591330  
Fax : (+86)755-82591332  
Web : www.LCS-cert.com  
Mail : webmaster@LCS-cert.com

Date of receipt of test sample : Oct. 16, 2017  
Number of tested samples : 1  
Serial number : Prototype  
Date of Test : Oct. 16, 2017 –Nov. 14, 2017  
Date of Report : Nov. 14, 2017

<b>FCC TEST REPORT</b>	
<b>FCC CFR 47 PART 15 C(15.247): 2017</b>	
<b>Report Reference No.</b> .....	<b>LCS170831044AE3</b>
<b>Date of Issue</b> .....	<b>Nov. 14, 2017</b>
<b>Testing Laboratory Name</b> .....	<b>Shenzhen LCS Compliance Testing Laboratory Ltd.</b>
<b>Address</b> .....	1/F., Xingyuan Industrial Park, Tongda Road, Bao'an Avenue, Bao'an District, Shenzhen, Guangdong, China
<b>Testing Location/ Procedure</b> .....	<input checked="" type="checkbox"/> Full application of Harmonised standards ■ <input type="checkbox"/> Partial application of Harmonised standards □ <input type="checkbox"/> Other standard testing method □
<b>Applicant's Name</b> .....	<b>Cotton On USA Inc</b>
<b>Address</b> .....	16511, Trojan Way, La Miranda, California 90638, United States
<b>Test Specification</b>	
<b>Standard</b> .....	FCC CFR 47 PART 15 C(15.247): 2017
<b>Test Report Form No.</b> .....	LCSEMC-1.0
<b>TRF Originator</b> .....	Shenzhen LCS Compliance Testing Laboratory Ltd.
<b>Master TRF</b> .....	Dated 2011-03
<b>Shenzhen LCS Compliance Testing Laboratory Ltd. All rights reserved.</b>	
<p>This publication may be reproduced in whole or in part for non-commercial purposes as long as the Shenzhen LCS Compliance Testing Laboratory Ltd. is acknowledged as copyright owner and source of the material. Shenzhen LCS Compliance Testing Laboratory Ltd. takes no responsibility for and will not assume liability for damages resulting from the reader's interpretation of the reproduced material due to its placement and context.</p>	
<b>Test Item Description.</b> .....	<b>USB Dongle</b>
<b>Trade Mark</b> .....	TYPO
<b>Test Model</b> .....	141902-00
<b>PO Number</b> .....	313276, 306024, 306026, 306025, 306032
<b>Ratings</b> .....	DC 5.0V
<b>Result</b> .....	<b>Positive</b>

**Compiled by:**

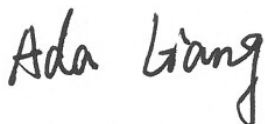

Ada Liang/ File administrators

**Supervised by:**



Glin Lu/ Technique principal

**Approved by:**



Gavin Liang/ Manager

## FCC -- TEST REPORT

<b>Test Report No. :</b> <b>LCS170831044AE3</b>	<u>2017-11-14</u> Date of issue
---	------------------------------------

Test Model.....	: 141902-00
EUT.....	: USB Dongle
<b>Applicant.....</b>	<b>: Cotton On USA Inc</b>
Address.....	: 16511, Trojan Way, La Miranda, California 90638, United States
Telephone.....	: /
Fax.....	: /
<b>Manufacturer.....</b>	<b>: Cotton On USA Inc</b>
Address.....	: 16511, Trojan Way, La Miranda, California 90638, United States
Telephone.....	: /
Fax.....	: /
<b>Factory.....</b>	<b>: Cotton On USA Inc</b>
Address.....	: 16511, Trojan Way, La Miranda, California 90638, United States
Telephone.....	: /
Fax.....	: /

<b>Test Result</b>	<b>Positive</b>
--------------------	-----------------

The test report merely corresponds to the test sample.  
 It is not permitted to copy extracts of these test result without the written permission of the test laboratory.

**Revision History**

Revision	Issue Date	Revisions	Revised By
00	Nov. 14, 2017	Initial Issue	Gavin Liang

**Table of Contents**

**Page**

<b>1. SUMMARY.....</b>	<b>6</b>
1.1. TEST STANDARDS.....	6
1.2. TEST DESCRIPTION.....	6
1.3. TEST FACILITY.....	7
1.4. STATEMENT OF THE MEASUREMENT UNCERTAINTY.....	7
<b>2. GENERAL INFORMATION.....</b>	<b>8</b>
2.1. ENVIRONMENTAL CONDITIONS.....	8
2.2. GENERAL DESCRIPTION OF EUT.....	8
2.3. DESCRIPTION OF TEST MODES AND TEST FREQUENCY.....	8
2.4. EQUIPMENTS USED DURING THE TEST.....	9
2.5. RELATED SUBMITTAL(S) / GRANT (S).....	9
2.6. MODIFICATIONS.....	9
<b>3. TEST CONDITIONS AND RESULTS.....</b>	<b>10</b>
3.1. CONDUCTED EMISSIONS TEST.....	10
3.2. RADIATED EMISSIONS AND BAND EDGE.....	13
3.3. MAXIMUM CONDUCTED OUTPUT POWER.....	20
3.4. POWER SPECTRAL DENSITY.....	21
3.5. 6DB BANDWIDTH.....	23
3.6. OUT-OF-BAND EMISSIONS.....	25
3.7. ANTENNA REQUIREMENT.....	29
<b>4. TEST SETUP PHOTOS OF THE EUT.....</b>	<b>30</b>
<b>5. EXTERNAL AND INTERNAL PHOTOS OF THE EUT.....</b>	<b>31</b>

# 1. SUMMARY

## 1.1. TEST STANDARDS

The tests were performed according to following standards:

**FCC Rules Part 15.247:** Frequency Hopping, Direct Spread Spectrum and Hybrid Systems that are in operation within the bands of 902-928 MHz, 2400-2483.5 MHz, and 5725-5850 MHz

**ANSI C63.10: 2013:** American National Standard for Testing Unlicensed Wireless Devices

**ANSI C63.4: 2014:** –American National Standard for Methods of Measurement of Radio-Noise Emissions from Low-Voltage Electrical and Electronic Equipment in the Range of 9 kHz to 40GHz  
Range of 9 kHz to 40GHz

**KDB558074 D01 V03r05:** Guidance for Performing Compliance Measurements on Digital Transmission Systems (DTS) Operating Under §15.247

## 1.2. Test Description

<b>FCC PART 15.247</b>		
FCC Part 15.207	AC Power Conducted Emission	PASS
FCC Part 15.247(a)(1)(i)	20dB Bandwidth	PASS
FCC Part 15.247(d)	Spurious RF Conducted Emission	PASS
FCC Part 15.247(b)	Maximum Peak Output Power	PASS
FCC Part 15.247(b)	Pseudorandom Frequency Hopping Sequence	PASS
FCC Part 15.247(a)(1)(iii)	Number of hopping frequency& Time of Occupancy	PASS
FCC Part 15.247(a)(1)	Frequency Separation	PASS
FCC Part 15.205/15.209	Radiated Emissions	PASS
FCC Part 15.247(d)	Band Edge Compliance of RF Emission	PASS
FCC Part 15.203/15.247 (b)	Antenna Requirement	PASS

### 1.3. Test Facility

#### 1.3.1 Address of the test laboratory

Shenzhen LCS Compliance Testing Laboratory Ltd.  
 1/F., Xingyuan Industrial Park, Tongda Road, Bao'an Avenue, Bao'an District, Shenzhen, Guangdong, China

There is one 3m semi-anechoic chamber fulfils CISPR 16-1-4 according to ANSI C63.10:2013 and CISPR 16-1-4:2010 SVSWR requirement for radiated emission above 1GHz.

#### 1.3.2 Laboratory accreditation

The test facility is recognized, certified, or accredited by the following organizations:

- CNAS Registration Number. is L4595.
- FCC Registration Number. is 254912.
- Industry Canada Registration Number. is 9642A-1.
- ESMD Registration Number. is ARCB0108.
- UL Registration Number. is 100571-492.
- TUV SUD Registration Number. is SCN1081.
- TUV RH Registration Number. is UA 50296516-001

### 1.4. Statement of the measurement uncertainty

The data and results referenced in this document are true and accurate. The reader is cautioned that there may be errors within the calibration limits of the equipment and facilities. The measurement uncertainty was calculated for all measurements listed in this test report acc. To CISPR 16 – 4 “Specification for radio disturbance and immunity measuring apparatus and methods – Part 4: Uncertainty in EMC Measurements” and is documented in the LCS quality system acc. To DIN EN ISO/IEC 17025. Furthermore, component and process variability of devices similar to that tested may result in additional deviation. The manufacturer has the sole responsibility of continued compliance of the device.

Test Item	Frequency Range	Uncertainty	Note
Radiation Uncertainty	9KHz~30MHz	3.10dB	(1)
	30MHz~200MHz	2.96dB	(1)
	200MHz~1000MHz	3.10dB	(1)
	1GHz~26.5GHz	3.80dB	(1)
	26.5GHz~40GHz	3.90dB	(1)
Conduction Uncertainty	150kHz~30MHz	1.63dB	(1)
Power disturbance	30MHz~300MHz	1.60dB	(1)

(1) This uncertainty represents an expanded uncertainty expressed at approximately the 95% confidence level using a coverage factor of k=2.

## 2. GENERAL INFORMATION

### 2.1. Environmental conditions

During the measurement the environmental conditions were within the listed ranges:

Normal Temperature:	25°C
Relative Humidity:	55 %
Air Pressure:	101 kPa

### 2.2. General Description of EUT

Product Name:	USB Dongle
Model/Type reference:	141902-00
Power supply:	DC 5.0V
<b>2.4GHz Wireless</b>	
Frequency band:	2400 MHz to 2483.5 MHz
Operating frequency:	2405MHz to 2470 MHz
Modulation type:	GFSK
Antenna type:	PCB Antenna
Antenna gain:	0dBi

Note: For more details, please refer to the user's manual of the EUT.

### 2.3. Description of Test Modes and Test Frequency

The Applicant provides communication tools software to control the EUT for staying in continuous transmitting (Duty Cycle more than 98%) and receiving mode for testing.

There are 8 channels provided to the EUT and Channel 01/04/08 were selected for test.

#### Operation Frequency List 2.4GHz Wireless :

Channel	Frequency (MHz)
01	2405
02	2413
03	2422
04	2430
05	2440
06	2450
07	2460
08	2470

Note: The line display in grey were the channel selected for testing



## 2.4. Equipments Used during the Test

Item	Equipment	Manufacturer	Model No.	Serial No.	Last Cal.	Next Cal.
1	EMC Receiver	R&S	ESCS 30	100174	2017-06-18	2018-06-17
2	Signal analyzer	Agilent	E4448A(External mixers to 40GHz)	US44300469	2017-07-16	2018-06-17
3	Spectrum Analyzer	Agilent	N9020A	MY50510140	2017-10-27	2018-10-26
4	LISN	MESS Tec	NNB-2/16Z	99079	2017-06-18	2018-06-17
5	LISN	EMCO	3819/2NM	9703-1839	2017-06-18	2018-06-17
6	RF Cable-CON	UTIFLEX	3102-26886-4	CB049	2017-06-18	2018-06-17
7	ISN	SCHAFFNER	ISN ST08	21653	2017-06-18	2018-06-17
8	3m Semi Anechoic Chamber	SIDT FRANKONIA	SAC-3M	03CH03-HY	2017-06-18	2018-06-17
9	Amplifier	SCHAFFNER	COA9231A	18667	2017-06-18	2018-06-17
10	Amplifier	Agilent	8449B	3008A02120	2017-06-16	2018-06-15
11	Amplifier	MITEQ	AMF-6F-260400	9121372	2017-06-16	2018-06-15
12	Loop Antenna	R&S	HFH2-Z2	860004/001	2017-06-18	2018-06-17
13	By-log Antenna	SCHWARZBECK	VULB9163	9163-470	2017-06-10	2018-06-09
14	Horn Antenna	EMCO	3115	6741	2017-06-10	2018-06-09
15	Horn Antenna	SCHWARZBECK	BBHA9170	BBHA9170154	2017-06-10	2018-06-09
16	RF Cable-R03m	Jye Bao	RG142	CB021	2017-06-18	2018-06-17
17	RF Cable-HIGH	SUHNER	SUCOFLEX 106	03CH03-HY	2017-06-18	2018-06-17
18	Power Sensor	R&S	NRV-Z81	100458	2017-06-18	2018-06-17
19	Power Sensor	R&S	NRV-Z32	10057	2017-06-18	2018-06-17
20	Power Meter	R&S	NRVS	100444	2017-06-18	2018-06-17

The calibration interval was one year

## 2.5. Related Submittal(s) / Grant (s)

This submittal(s) (test report) is intended to comply with Section 15.247 of the FCC Part 15, Subpart C Rules.

## 2.6. Modifications

No modifications were implemented to meet testing criteria.

### 3. TEST CONDITIONS AND RESULTS

#### 3.1. Conducted Emissions Test

**LIMIT**

FCC CFR Title 47 Part 15 Subpart C Section 15.207

Frequency range (MHz)	Limit (dBuV)	
	Quasi-peak	Average
0.15-0.5	66 to 56*	56 to 46*
0.5-5	56	46
5-30	60	50

\* Decreases with the logarithm of the frequency.

**TEST CONFIGURATION**

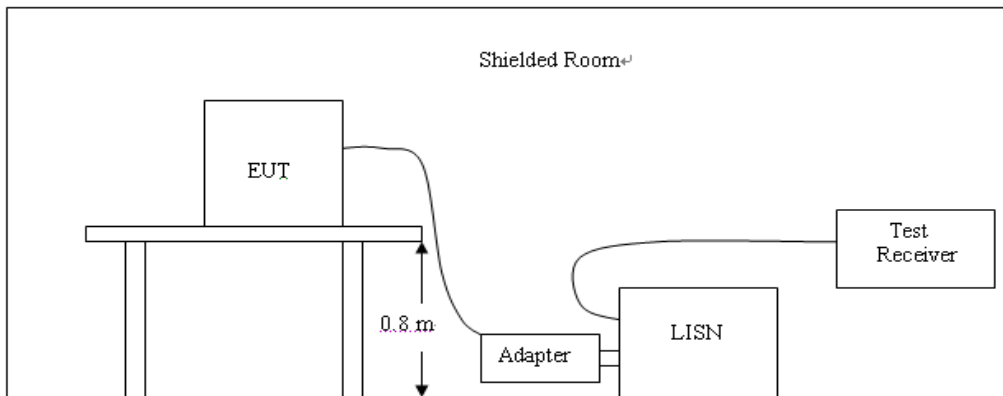

**TEST PROCEDURE**

1. The equipment was set up as per the test configuration to simulate typical actual usage per the user’s manual. The EUT is a tabletop system; a wooden table with a height of 0.8 meters is used and is placed on the ground plane as per ANSI C63.10:2013.
2. Support equipment, if needed, was placed as per ANSI C63.10:2013.
3. All I/O cables were positioned to simulate typical actual usage as per ANSI C63.10:2013.
4. The adapter received AC120V/60Hz power through a Line Impedance Stabilization Network (LISN) which supplied power source and was grounded to the ground plane.
5. All support equipments received AC power from a second LISN, if any.
6. The EUT test program was started. Emissions were measured on each current carrying line of the EUT using a spectrum Analyzer / Receiver connected to the LISN powering the EUT. The LISN has two monitoring points: Line 1 (Hot Side) and Line 2 (Neutral Side). Two scans were taken: one with Line 1 connected to Analyzer / Receiver and Line 2 connected to a 50 ohm load; the second scan had Line 1 connected to a 50 ohm load and Line 2 connected to the Analyzer / Receiver.
7. Analyzer / Receiver scanned from 150 KHz to 30MHz for emissions in each of the test modes.
8. During the above scans, the emissions were maximized by cable manipulation.

**TEST RESULTS**

**SCAN TABLE: "Voltage (9K-30M)FIN"**  
 Short Description: 150K-30M Voltage

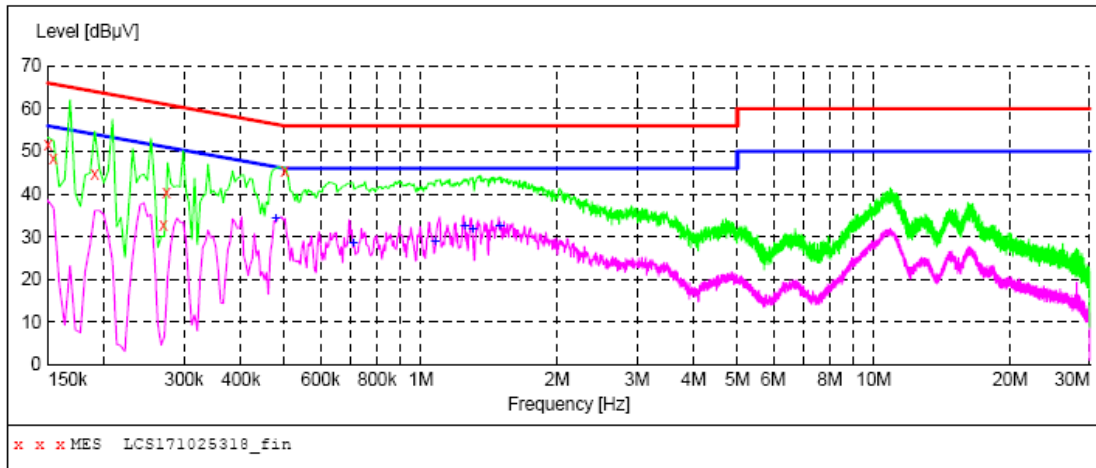

**MEASUREMENT RESULT: "LCS171025318\_fin"**

25/10/2017 14:26

Frequency MHz	Level dBuV	Transd dB	Limit dBuV	Margin dB	Detector	Line	PE
0.150000	51.60	10.2	66	14.4	QP	L1	GND
0.154000	48.50	10.2	66	17.3	QP	L1	GND
0.190000	44.80	10.2	64	19.2	QP	L1	GND
0.270000	32.80	10.2	61	28.3	QP	L1	GND
0.274000	40.30	10.2	61	20.7	QP	L1	GND
0.500000	45.40	10.2	56	10.6	QP	L1	GND

**MEASUREMENT RESULT: "LCS171025318\_fin2"**

25/10/2017 14:26

Frequency MHz	Level dBuV	Transd dB	Limit dBuV	Margin dB	Detector	Line	PE
0.478000	34.30	10.2	46	12.1	AV	L1	GND
0.710000	28.50	10.2	46	17.5	AV	L1	GND
1.076000	28.70	10.3	46	17.3	AV	L1	GND
1.250000	32.30	10.3	46	13.7	AV	L1	GND
1.304000	31.80	10.3	46	14.2	AV	L1	GND
1.496000	32.40	10.3	46	13.6	AV	L1	GND

**SCAN TABLE: "Voltage (9K-30M) FIN"**  
 Short Description: 150K-30M Voltage

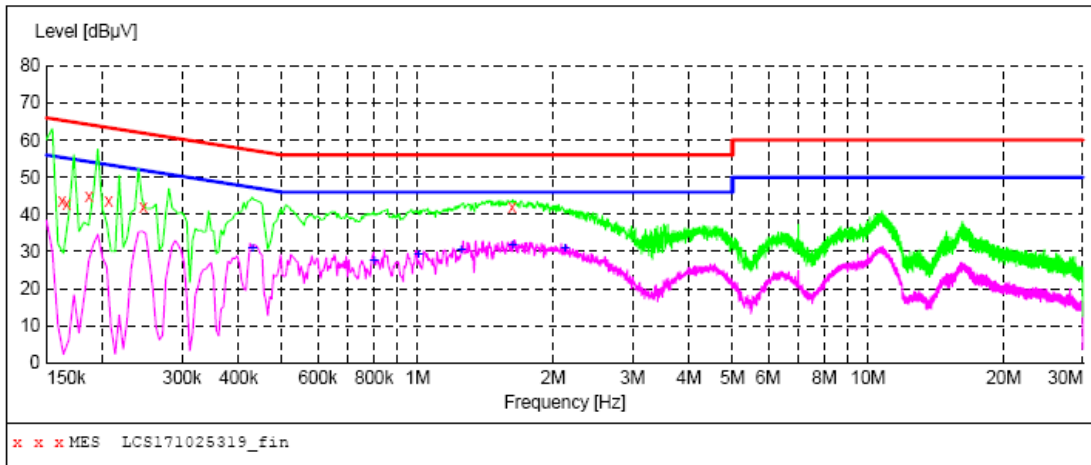

**MEASUREMENT RESULT: "LCS171025319\_fin"**

25/10/2017 14:30

Frequency MHz	Level dBµV	Transd dB	Limit dBµV	Margin dB	Detector	Line	PE
0.162000	43.80	10.2	65	21.6	QP	N	GND
0.166000	42.60	10.2	65	22.6	QP	N	GND
0.186000	45.00	10.2	64	19.2	QP	N	GND
0.206000	43.60	10.2	63	19.8	QP	N	GND
0.246000	42.10	10.2	62	19.8	QP	N	GND
1.622000	42.10	10.3	56	13.9	QP	N	GND

**MEASUREMENT RESULT: "LCS171025319\_fin2"**

25/10/2017 14:30

Frequency MHz	Level dBµV	Transd dB	Limit dBµV	Margin dB	Detector	Line	PE
0.430000	30.70	10.2	47	16.6	AV	N	GND
0.800000	27.50	10.2	46	18.5	AV	N	GND
1.004000	29.20	10.3	46	16.8	AV	N	GND
1.250000	30.50	10.3	46	15.5	AV	N	GND
1.628000	31.50	10.3	46	14.5	AV	N	GND
2.126000	30.60	10.4	46	15.4	AV	N	GND

### 3.2. Radiated Emissions and Band Edge

#### Limit

For intentional device, according to § 15.209(a), the general requirement of field strength of radiated emission out of authorized band shall not exceed the following table at a 3 meters measurement distance.

In addition, radiated emissions which fall in the restricted bands, as defined in §15.205(a), must also comply with the radiated emission limits specified in §15.209(a)

Radiated emission limits

Frequency (MHz)	Distance (Meters)	Radiated (dBµV/m)	Radiated (µV/m)
0.009-0.49	3	$20\log(2400/F(\text{KHz})) + 40\log(300/3)$	$2400/F(\text{KHz})$
0.49-1.705	3	$20\log(24000/F(\text{KHz})) + 40\log(30/3)$	$24000/F(\text{KHz})$
1.705-30	3	$20\log(30) + 40\log(30/3)$	30
30-88	3	40.0	100
88-216	3	43.5	150
216-960	3	46.0	200
Above 960	3	54.0	500

#### TEST CONFIGURATION

(A) Radiated Emission Test Set-Up, Frequency Below 30MHz

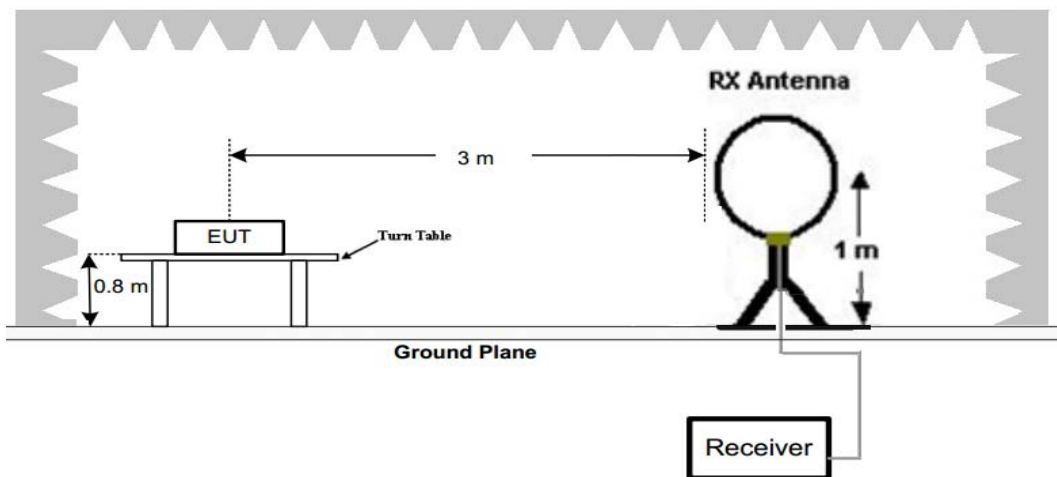

(B) Radiated Emission Test Set-Up, Frequency below 1000MHz

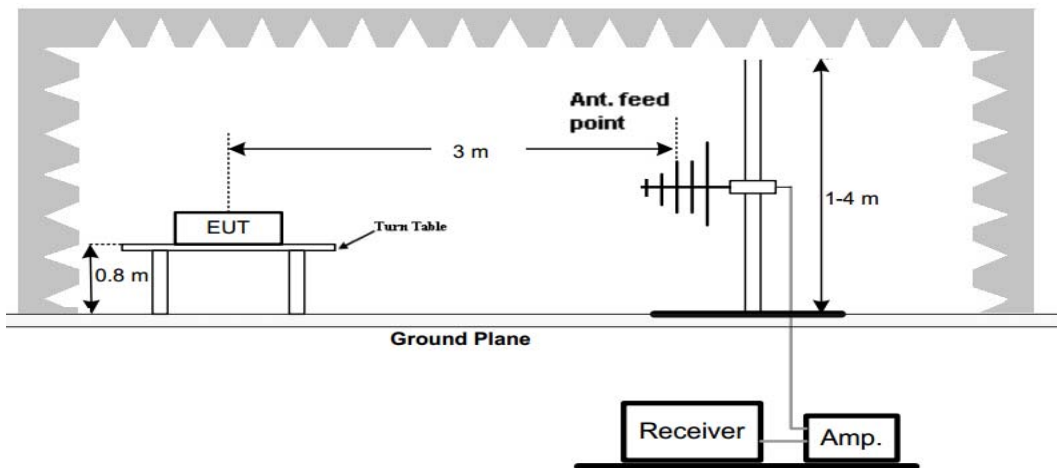

(C) Radiated Emission Test Set-Up, Frequency above 1000MHz

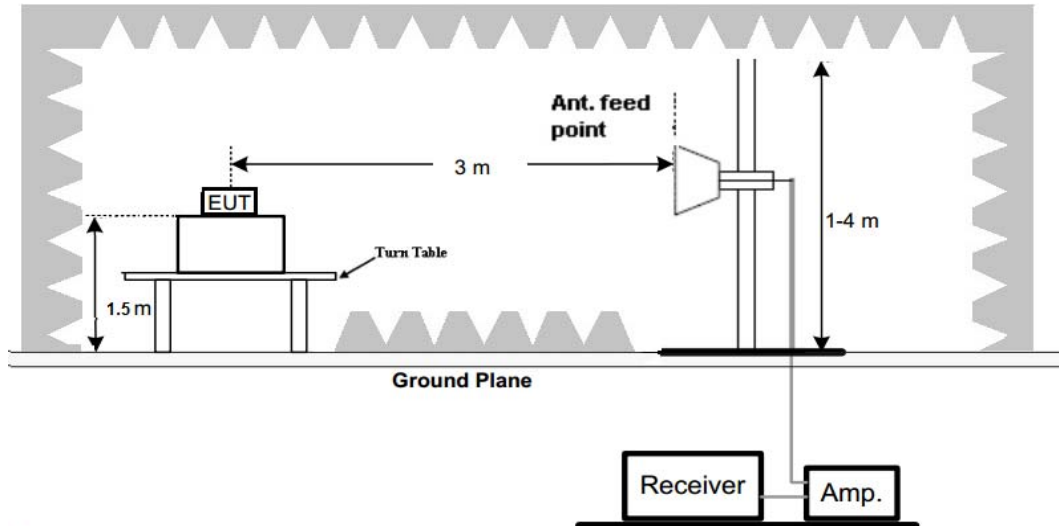

**Test Procedure**

1. Below 1GHz measurement the EUT is placed on a turntable which is 0.8m above ground plane, and above 1GHz measurement EUT was placed on a low permittivity and low loss tangent turn table which is 1.5m above ground plane.
2. Maximum procedure was performed by raising the receiving antenna from 1m to 4m and rotating the turn table from 0° to 360° to acquire the highest emissions from EUT
3. And also, each emission was to be maximized by changing the polarization of receiving antenna both horizontal and vertical.
4. Repeat above procedures until all frequency measurements have been completed.

**TEST RESULTS**

Remark:

1. For below 1GHz testing recorded worst at low channel.
2. Radiated emission test from 9 KHz to 10th harmonic of fundamental was verified, and no emission found except system noise floor in 9 KHz to 30MHz and not recorded in this report.

**For 30MHz-1GHz**

**Horizontal**

**SWEEP TABLE: "test (30M-1G)"**

Short Description:		Field Strength			
Start	Stop	Detector	Meas. Time	IF Bandw.	Transducer
30.0 MHz	1.0 GHz	MaxPeak	300.0 ms	120 kHz	JB1

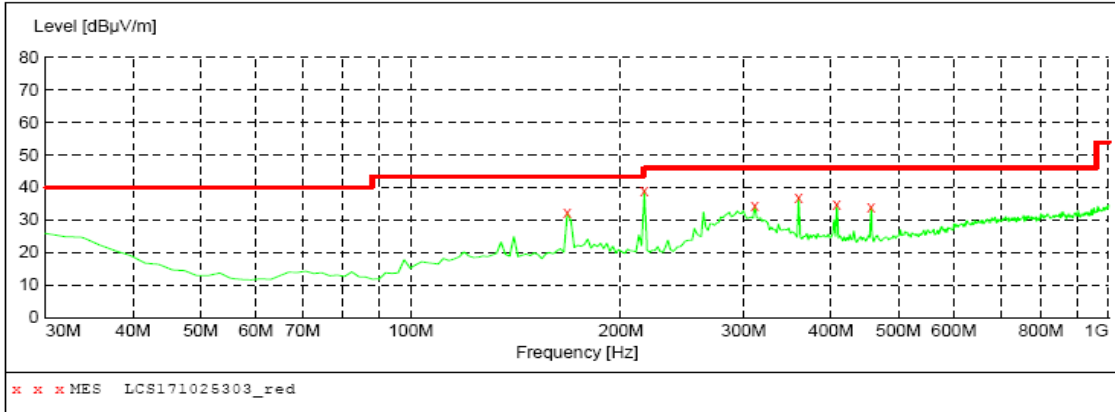

**MEASUREMENT RESULT: "LCS171025303\_red"**

10/25/2017 9:00AM

Frequency MHz	Level dBµV/m	Transd dB	Limit dBµV/m	Margin dB	Det.	Height cm	Azimuth deg	Polarization
167.740000	32.10	14.5	43.5	11.4	---	0.0	0.00	HORIZONTAL
216.240000	39.10	14.4	46.0	6.9	---	0.0	0.00	HORIZONTAL
311.300000	34.30	16.4	46.0	11.7	---	0.0	0.00	HORIZONTAL
359.800000	36.90	17.5	46.0	9.1	---	0.0	0.00	HORIZONTAL
408.300000	34.80	18.4	46.0	11.2	---	0.0	0.00	HORIZONTAL
456.800000	34.00	19.6	46.0	12.0	---	0.0	0.00	HORIZONTAL

**Vertical**

**SWEEP TABLE: "test (30M-1G)"**

Short Description:		Field Strength			
Start	Stop	Detector	Meas. Time	IF Bandw.	Transducer
30.0 MHz	1.0 GHz	MaxPeak	300.0 ms	120 kHz	JB1

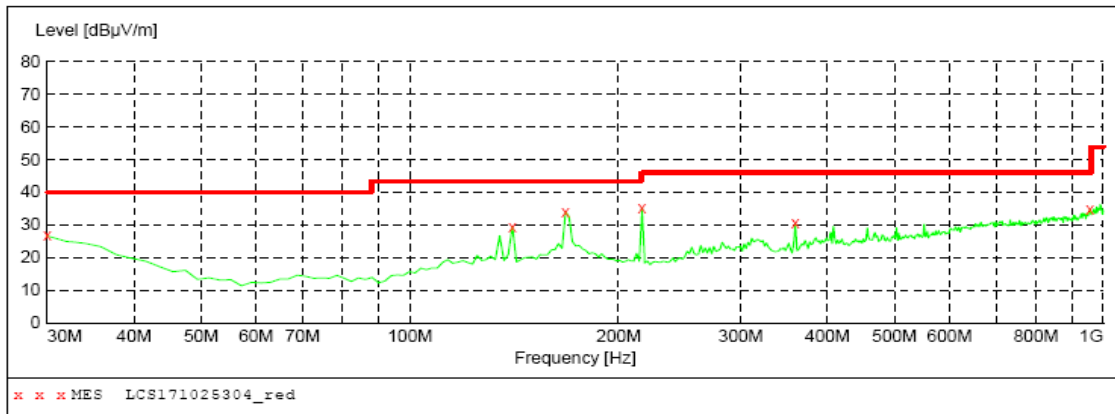

**MEASUREMENT RESULT: "LCS171025304\_red"**

10/25/2017 9:01AM

Frequency MHz	Level dBµV/m	Transd dB	Limit dBµV/m	Margin dB	Det.	Height cm	Azimuth deg	Polarization
30.000000	26.60	22.1	40.0	13.4	---	0.0	0.00	VERTICAL
140.580000	29.50	14.8	43.5	14.0	---	0.0	0.00	VERTICAL
167.740000	34.00	14.5	43.5	9.5	---	0.0	0.00	VERTICAL
216.240000	35.20	14.4	46.0	10.8	---	0.0	0.00	VERTICAL
359.800000	30.40	17.5	46.0	15.6	---	0.0	0.00	VERTICAL
957.320000	34.90	27.4	46.0	11.1	---	0.0	0.00	VERTICAL

**For 1GHz to 25GHz**

**2.4GHz Wireless GFSK (above 1GHz)**

Frequency(MHz):			2405		Polarity:			HORIZONTAL	
Frequency (MHz)	Emission Level (dBuV/m)		Limit (dBuV/m)	Margin (dB)	Raw Value (dBuV)	Antenna Factor (dB/m)	Cable Factor (dB)	Pre-amplifier (dB)	Correction Factor (dB/m)
4810.00	61.33	PK	74	12.67	56.81	33.50	6.92	35.89	4.52
4810.00	50.12	AV	54	3.88	45.60	33.50	6.92	35.89	4.52
5921.45	44.76	PK	74	29.24	36.89	34.88	7.54	34.56	7.87
5921.45	--	AV	54	--	--	--	--	--	--
7215.00	53.09	PK	74	20.91	41.93	36.99	9.19	35.02	11.16
7215.00	--	AV	54	--	--	--	--	--	--

Frequency(MHz):			2405		Polarity:			VERTICAL	
Frequency (MHz)	Emission Level (dBuV/m)		Limit (dBuV/m)	Margin (dB)	Raw Value (dBuV)	Antenna Factor (dB/m)	Cable Factor (dB)	Pre-amplifier (dB)	Correction Factor (dB/m)
4810.00	59.45	PK	74	14.55	54.93	33.50	6.92	35.89	4.52
4810.00	48.37	AV	54	5.63	43.85	33.50	6.92	35.89	4.52
7002.68	45.82	PK	74	28.18	35.56	36.24	9.10	35.08	10.26
7002.68	--	AV	54	--	--	--	--	--	--
7215.00	50.40	PK	74	23.60	39.24	36.99	9.19	35.02	11.16
7215.00	--	AV	54	--	--	--	--	--	--

Frequency(MHz):			2430		Polarity:			HORIZONTAL	
Frequency (MHz)	Emission Level (dBuV/m)		Limit (dBuV/m)	Margin (dB)	Raw Value (dBuV)	Antenna Factor (dB/m)	Cable Factor (dB)	Pre-amplifier (dB)	Correction Factor (dB/m)
4860.00	60.27	PK	74	13.73	55.66	33.57	6.94	35.90	4.61
4860.00	49.44	AV	54	4.56	44.83	33.57	6.94	35.90	4.61
6326.81	43.92	PK	74	30.08	35.39	35.19	8.09	34.75	8.53
6326.81	--	AV	54	--	--	--	--	--	--
7290.00	52.36	PK	74	21.64	40.79	37.36	9.22	35.00	11.57
7290.00	--	AV	54	--	--	--	--	--	--

Frequency(MHz):			2430		Polarity:			VERTICAL	
Frequency (MHz)	Emission Level (dBuV/m)		Limit (dBuV/m)	Margin (dB)	Raw Value (dBuV)	Antenna Factor (dB/m)	Cable Factor (dB)	Pre-amplifier (dB)	Correction Factor (dB/m)
4860.00	58.03	PK	74	15.97	53.42	33.57	6.94	35.90	4.61
4860.00	48.18	AV	54	5.82	43.57	33.57	6.94	35.90	4.61
5077.10	44.50	PK	74	29.50	37.43	34.25	7.08	34.26	7.07
5077.10	--	AV	54	--	--	--	--	--	--
7290.00	49.87	PK	74	24.13	38.30	37.36	9.22	35.00	11.57
7290.00	--	AV	54	--	--	--	--	--	--



Frequency(MHz):			2470		Polarity:			HORIZONTAL	
Frequency (MHz)	Emission Level (dBuV/m)		Limit (dBuV/m)	Margin (dB)	Raw Value (dBuV)	Antenna Factor (dB/m)	Cable Factor (dB)	Pre-amplifier (dB)	Correction Factor (dB/m)
4940.00	60.80	PK	74	13.20	55.96	33.77	6.99	35.92	4.84
4940.00	49.57	AV	54	4.43	44.73	33.77	6.99	35.92	4.84
5851.28	43.31	PK	74	30.69	35.53	34.81	7.51	34.54	7.78
5851.28	--	AV	54	--	--	--	--	--	--
7410.00	51.65	PK	74	22.35	39.72	37.64	9.26	34.97	11.93
7410.00	--	AV	54	--	--	--	--	--	--

Frequency(MHz):			2470		Polarity:			VERTICAL	
Frequency (MHz)	Emission Level (dBuV/m)		Limit (dBuV/m)	Margin (dB)	Raw Value (dBuV)	Antenna Factor (dB/m)	Cable Factor (dB)	Pre-amplifier (dB)	Correction Factor (dB/m)
4940.00	57.92	PK	74	16.08	53.08	33.77	6.99	35.92	4.84
4940.00	47.65	AV	54	6.35	42.81	33.77	6.99	35.92	4.84
7134.46	42.79	PK	74	31.21	32.06	36.62	9.15	35.05	10.73
7134.46	--	AV	54	--	--	--	--	--	--
7410.00	49.41	PK	74	24.59	37.48	37.64	9.26	34.97	11.93
7410.00	--	AV	54	--	--	--	--	--	--

REMARKS:

1. Emission level (dBuV/m) =Raw Value (dBuV)+Correction Factor (dB/m)
2. Correction Factor (dB/m) = Antenna Factor (dB/m)+Cable Factor (dB)-Pre-amplifier Factor
3. Margin value = Limit value- Emission level.
4. -- Mean the PK detector measured value is below average limit.
5. The other emission levels were very low against the limit.
6. RBW1MHz VBW3MHz Peak detector is for PK value; RBW 1MHz VBW10Hz Peak detector is for AV value.

**Results of Band Edges Test (Radiated)**

Frequency(MHz):			2405		Polarity:			HORIZONTAL	
Frequency (MHz)	Emission Level (dBuV/m)		Limit (dBuV/m)	Margin (dB)	Raw Value (dBuV)	Antenna Factor (dB/m)	Cable Factor (dB)	Pre-amplifier (dB)	Correction Factor (dB/m)
2405.00	98.48	PK	--	--	65.08	28.79	4.62	0.00	33.40
2405.00	88.16	AV	--	--	54.76	28.79	4.62	0.00	33.40
2387.75	40.65	PK	74	33.35	7.35	28.70	4.60	0.00	33.30
2387.75	--	AV	54	--	--	--	--	--	--
2390.00	38.70	PK	74	35.30	5.38	28.72	4.60	0.00	33.32
2390.00	--	AV	54	--	--	--	--	--	--
2400.00	42.23	PK	74	31.77	8.84	28.78	4.61	0.00	33.39
2400.00	--	AV	54	--	--	--	--	--	--

Frequency(MHz):			2405		Polarity:			VERTICAL	
Frequency (MHz)	Emission Level (dBuV/m)		Limit (dBuV/m)	Margin (dB)	Raw Value (dBuV)	Antenna Factor (dB/m)	Cable Factor (dB)	Pre-amplifier (dB)	Correction Factor (dB/m)
2405.00	95.94	PK	--	--	62.54	28.79	4.62	0.00	33.40
2405.00	84.43	AV	--	--	51.03	28.79	4.62	0.00	33.40
2387.75	39.71	PK	74	34.29	6.41	28.70	4.60	0.00	33.30
2387.75	--	AV	54	--	--	--	--	--	--
2390.00	37.22	PK	74	36.78	3.90	28.72	4.60	0.00	33.32
2390.00	--	AV	54	--	--	--	--	--	--
2400.00	40.30	PK	74	33.70	6.91	28.78	4.61	0.00	33.39
2400.00	--	AV	54	--	--	--	--	--	--

Frequency(MHz):			2470		Polarity:			HORIZONTAL	
Frequency (MHz)	Emission Level (dBuV/m)		Limit (dBuV/m)	Margin (dB)	Raw Value (dBuV)	Antenna Factor (dB/m)	Cable Factor (dB)	Pre-amplifier (dB)	Correction Factor (dB/m)
2470.00	97.77	PK	--	--	64.18	28.91	4.69	0.00	33.59
2470.00	86.72	AV	--	--	53.13	28.91	4.69	0.00	33.59
2483.50	39.10	PK	74	34.90	5.47	28.93	4.70	0.00	33.63
2483.50	--	AV	54	--	--	--	--	--	--
2496.08	42.06	PK	74	31.94	8.39	28.95	4.72	0.00	33.67
2496.08	--	AV	54	--	--	--	--	--	--
2500.00	38.34	PK	74	35.66	4.66	28.96	4.72	0.00	33.68
2500.00	--	AV	54	--	--	--	--	--	--

Frequency(MHz):			2470		Polarity:			VERTICAL	
Frequency (MHz)	Emission Level (dBuV/m)		Limit (dBuV/m)	Margin (dB)	Raw Value (dBuV)	Antenna Factor (dB/m)	Cable Factor (dB)	Pre-amplifier (dB)	Correction Factor (dB/m)
2470.00	95.83	PK	--	--	62.24	28.91	4.69	0.00	33.59
2470.00	84.65	AV	--	--	51.06	28.91	4.69	0.00	33.59
2483.50	38.69	PK	74	35.31	5.06	28.93	4.70	0.00	33.63
2483.50	--	AV	54	--	--	--	--	--	--
2496.08	40.58	PK	74	33.42	6.91	28.95	4.72	0.00	33.67
2496.08	--	AV	54	--	--	--	--	--	--
2500.00	38.02	PK	74	35.98	4.34	28.96	4.72	0.00	33.68
2500.00	--	AV	54	--	--	--	--	--	--

REMARKS:

1. Emission level (dBuV/m) =Raw Value (dBuV)+Correction Factor (dB/m)
2. Correction Factor (dB/m) = Antenna Factor (dB/m)+Cable Factor (dB)-Pre-amplifier Factor
3. Margin value = Limit value- Emission level.
4. -- Mean the PK detector measured value is below average limit.
5. The other emission levels were very low against the limit.
6. RBW1MHz VBW3MHz Peak detector is for PK value; RBW 1MHz VBW10Hz Peak detector is for AV value.

### 3.3. Maximum Conducted Output Power

#### Limit

The Maximum Peak Output Power Measurement is 30dBm.

#### Test Procedure

Remove the antenna from the EUT and then connect a low loss RF cable from the antenna port to the power sensor.

#### Test Configuration

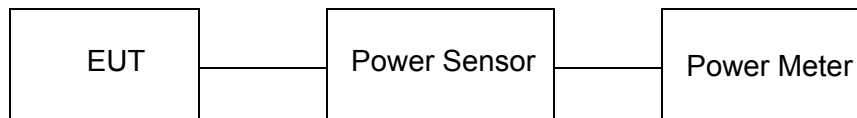

#### Test Results

Type	Channel	PK Output power (dBm)	Limit (dBm)	Result
GFSK	01	4.077	30.00	Pass
	04	3.930		
	08	4.032		

Note: 1.The test results including the cable lose.

### 3.4. Power Spectral Density

#### Limit

For digitally modulated systems, the power spectral density conducted from the intentional radiator to the antenna shall not be greater than 8 dBm in any 3 kHz band during any time interval of continuous transmission.

#### Test Procedure

1. Use this procedure when the maximum peak conducted output power in the fundamental emission is used to demonstrate compliance.
2. Set the RBW  $\geq$  3 kHz.
3. Set the VBW  $\geq$  3 $\times$  RBW.
4. Set the span to 1.5 times the DTS channel bandwidth.
5. Detector = peak.
6. Sweep time = auto couple.
7. Trace mode = max hold.
8. Allow trace to fully stabilize.
9. Use the peak marker function to determine the maximum power level.
10. If measured value exceeds limit, reduce RBW (no less than 3 kHz) and repeat.
11. The resulting peak PSD level must be 8dBm.

#### Test Configuration

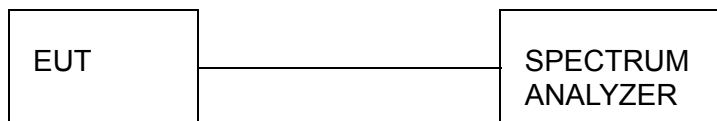

#### Test Results

Type	Channel	Power Spectral Density (dBm/3KHz)	Limit (dBm/3KHz)	Result
GFSK	01	-10.161	8.00	Pass
	04	-10.686		
	08	-10.189		

Test plot as follows:

GFSK

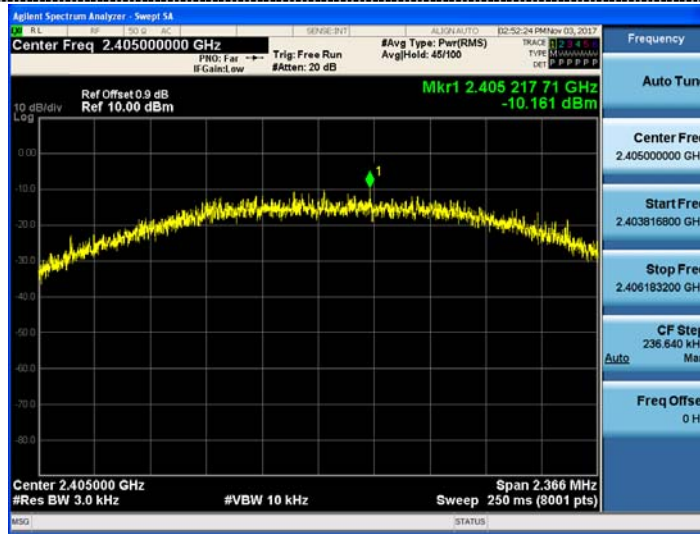

CH01

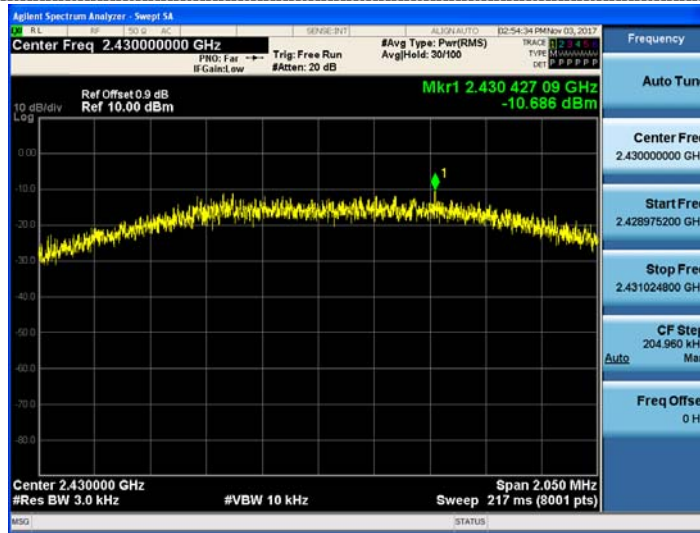

CH04

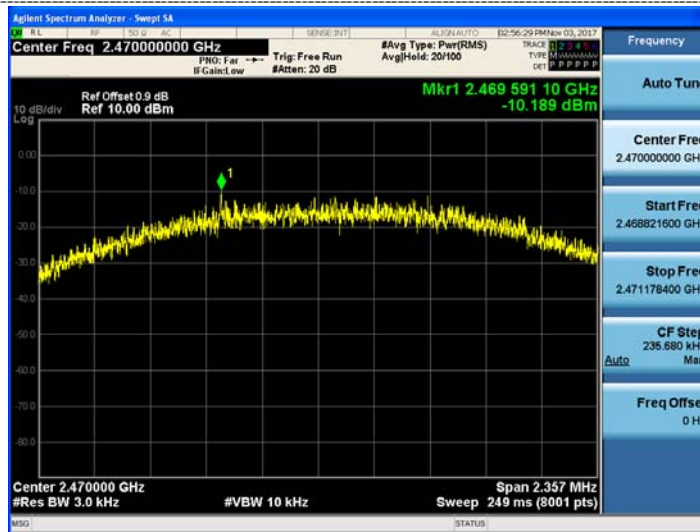

CH08

### 3.5. 6dB Bandwidth

#### Limit

For digital modulation systems, the minimum 6 dB bandwidth shall be at least 500 kHz

#### Test Procedure

The transmitter output was connected to the spectrum analyzer through an attenuator. The bandwidth of the fundamental frequency was measured by spectrum analyzer with 100 KHz RBW and 300 KHz VBW. The 6dB bandwidth is defined as the total spectrum the power of which is higher than peak power minus 6dB.

#### Test Configuration

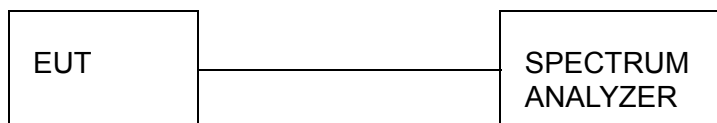

#### Test Results

Type	Channel	6dB Bandwidth (MHz)	99% OBW (MHz)	Limit (KHz)	Result
GFSK	01	1.479	2.2892	≥500	Pass
	04	1.281	2.2905		
	08	1.473	2.3249		

Test plot as follows:

GFSK

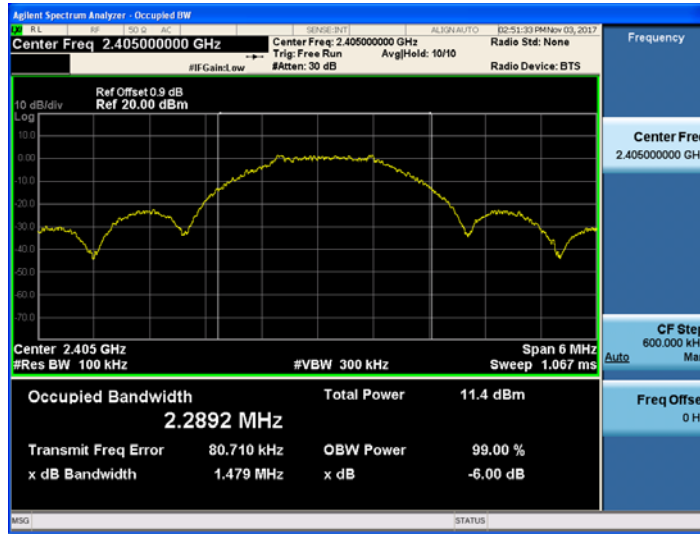

CH01

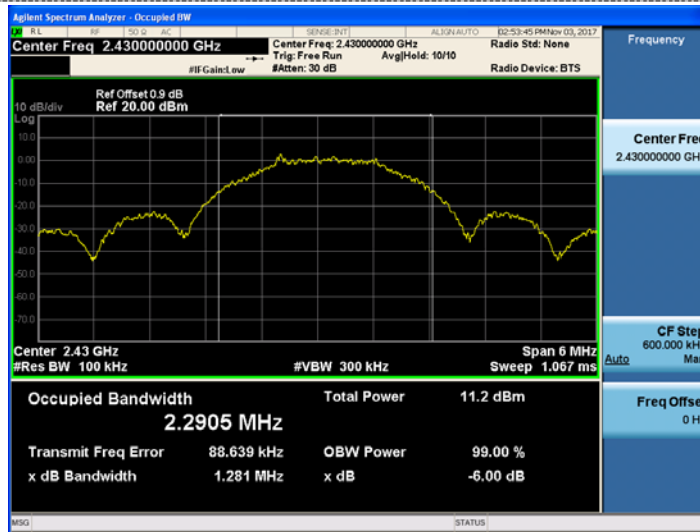

CH04

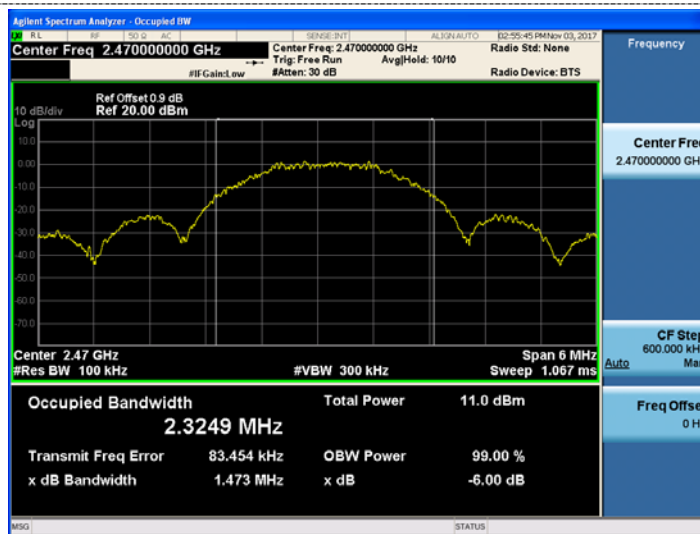

CH08



### 3.6. Out-of-band Emissions

#### Limit

In any 100 kHz bandwidth outside the frequency band in which the spread spectrum or digitally modulated intentional radiator is operating, the radio frequency power that is produced by the intentional radiator shall be at least 20 dB below that in the 100 kHz bandwidth within the band that contains the highest level of the desired power, based on either an RF conducted or a radiated measurement, provided the transmitter demonstrates compliance with the peak conducted power limits. If the transmitter complies with the conducted power limits based on the use of RMS averaging over a time interval, as permitted under paragraph (b)(3) of this section, the attenuation required under this paragraph shall be 30 dB instead of 20 dB. Attenuation below the general limits specified in §15.209(a) is not required.

#### Test Procedure

Connect the transmitter output to spectrum analyzer using a low loss RF cable, and set the spectrum analyzer to RBW=100 kHz, VBW= 300 kHz, peak detector , and max hold. Measurements utilizing these setting are made of the in-band reference level, bandedge and out-of-band emissions.

#### Test Configuration

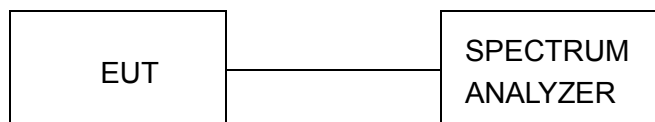

#### Test Results

Remark: The measurement frequency range is from 30MHz to the 10th harmonic of the fundamental frequency. The lowest, middle and highest channels are tested to verify the spurious emissions and bandage measurement data.

Test plot as follows:

CH01



Reference

CH04



Reference

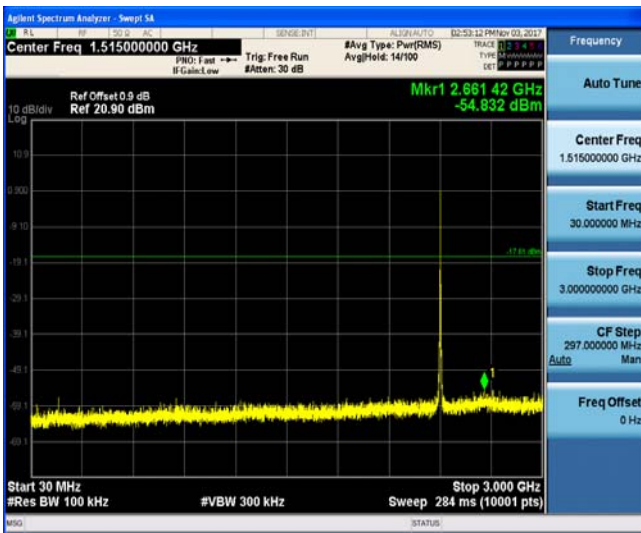

30MHz-3GHz

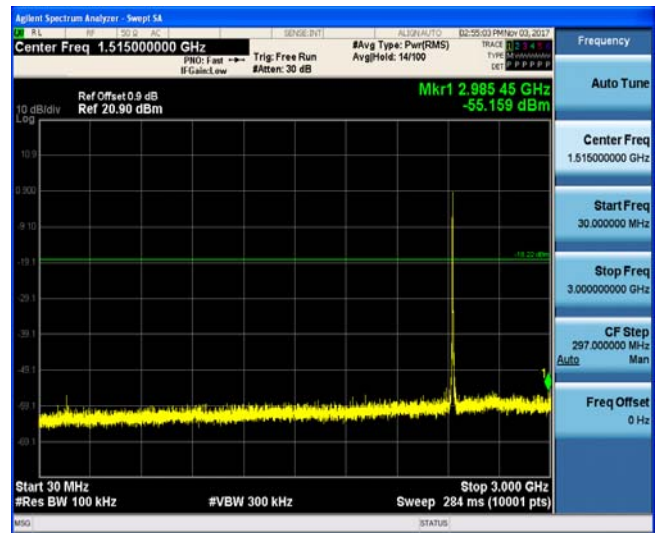

30MHz-3GHz

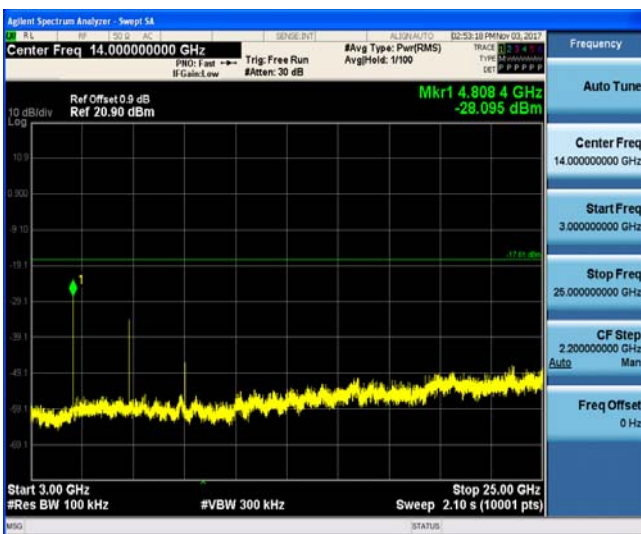

3GHz-25GHz

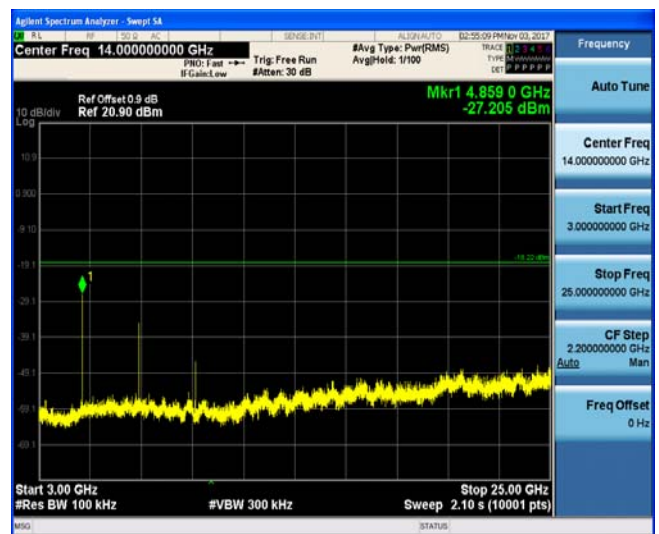

3GHz-25GHz

**CH08**



Reference

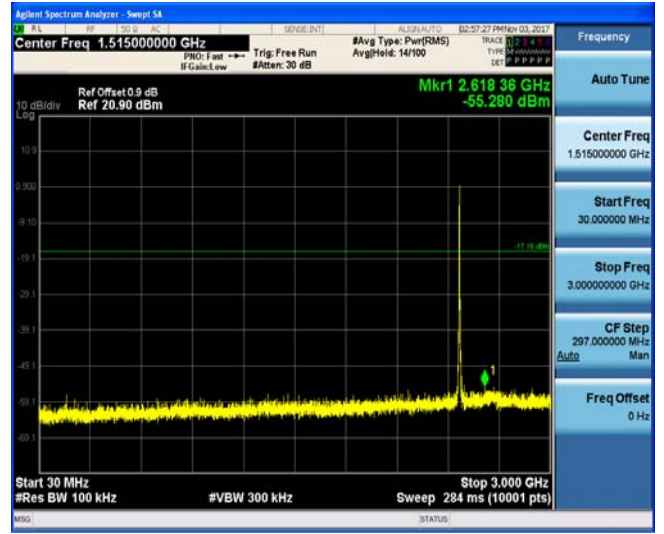

30MHz-3GHz

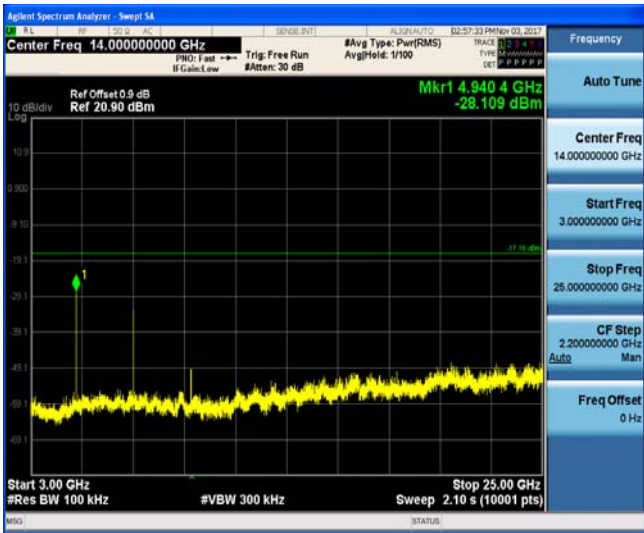

3GHz-25GHz

**Band-edge Measurements for RF Conducted Emissions:**

**GFSK**

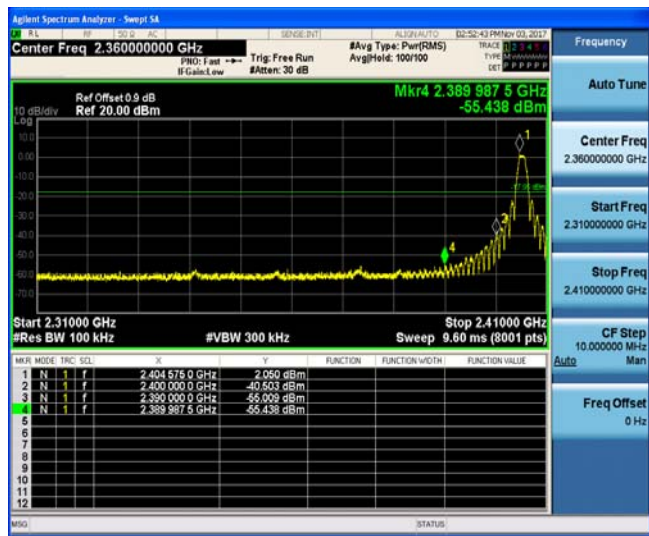

Left bandedge

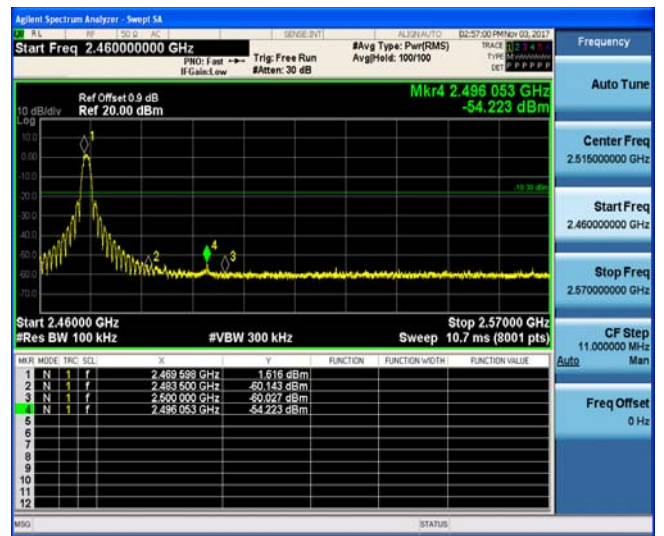

Right bandedge

### 3.7. Antenna Requirement

#### Standard Applicable

**For intentional device, according to FCC 47 CFR Section 15.203:**

An intentional radiator shall be designed to ensure that no antenna other than that furnished by the responsible party shall be used with the device. The use of a permanently attached antenna or of an antenna that uses a unique coupling to the intentional radiator, the manufacturer may design the unit so that a broken antenna can be replaced by the user, but the use of a standard antenna jack or electrical connector is prohibited

**FCC CFR Title 47 Part 15 Subpart C Section 15.247(c) (1) (I):**

(i) Systems operating in the 2400-2483.5 MHz band that is used exclusively for fixed. Point-to-point operations may employ transmitting antennas with directional gain greater than 6dBi provided the maximum conducted output power of the intentional radiator is reduced by 1 dB for every 3 dB that the directional gain of the antenna exceeds 6dBi.

#### Test Result:

The maximum gain of antenna was 0dBi.



## 4. Test Setup Photos of the EUT



## 5. External and Internal Photos of the EUT

### External photos

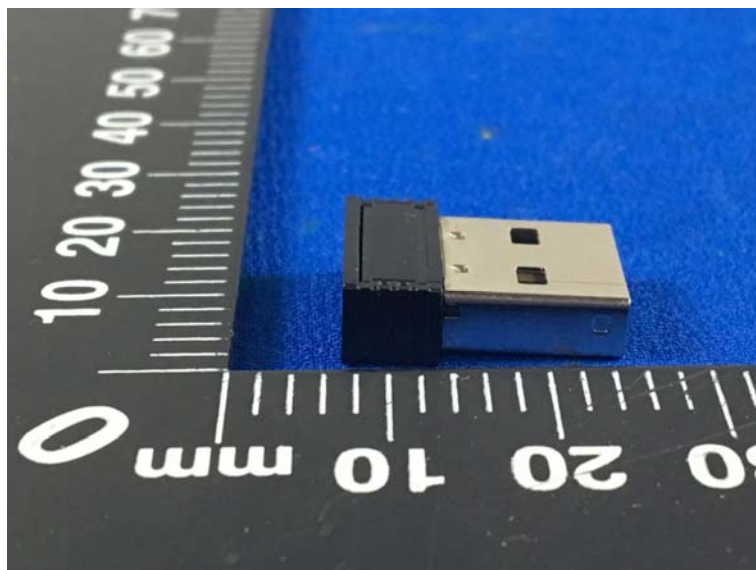
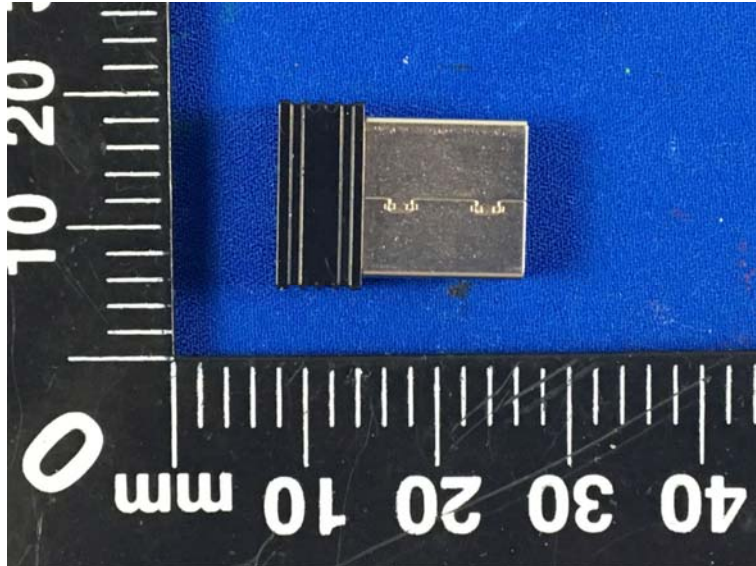
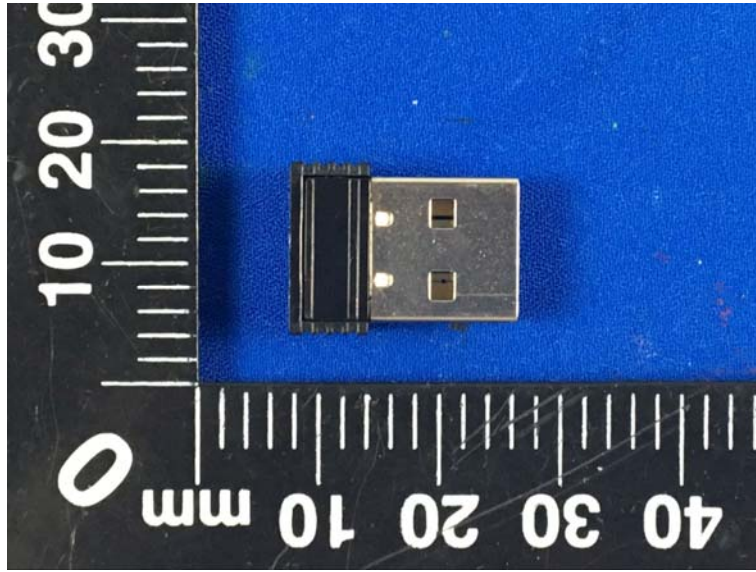

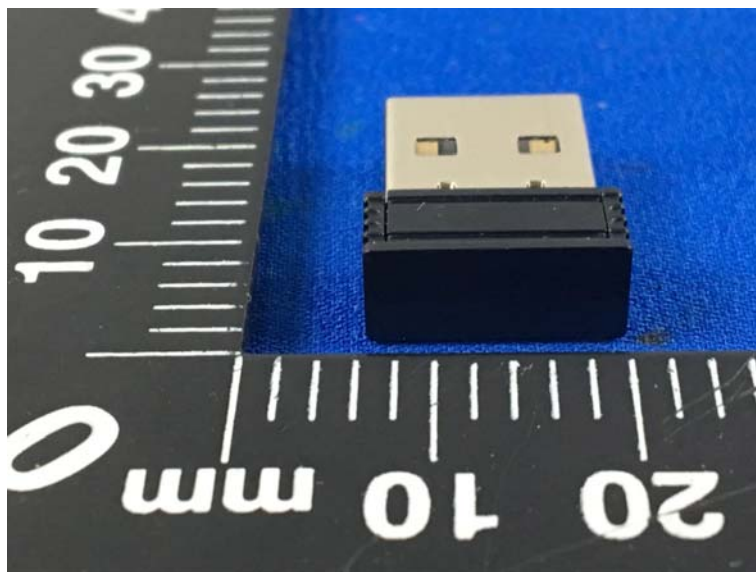



**Internal photos**

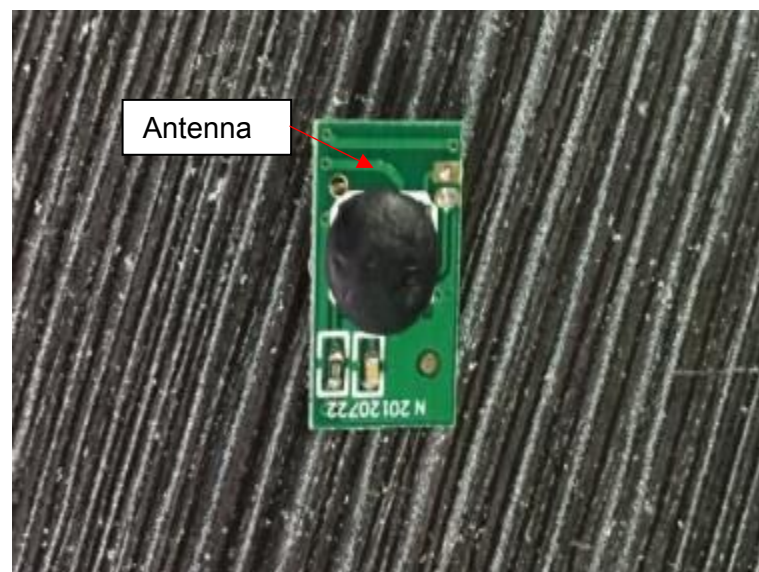
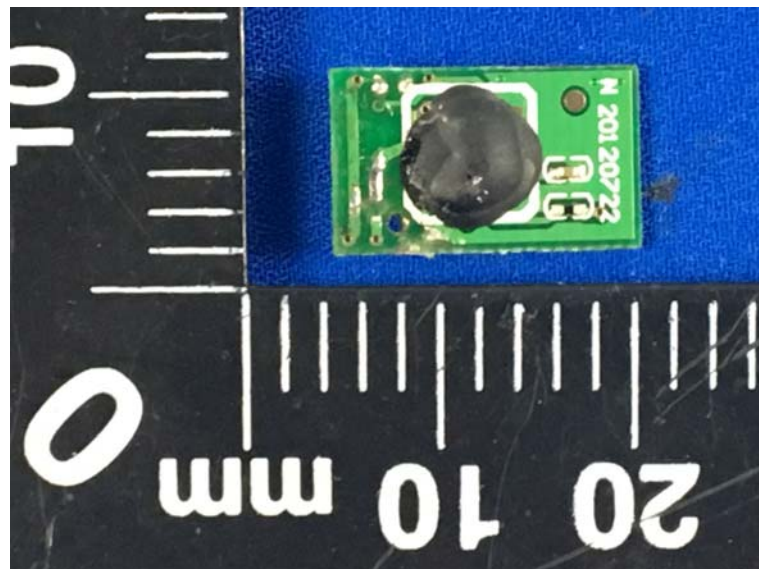
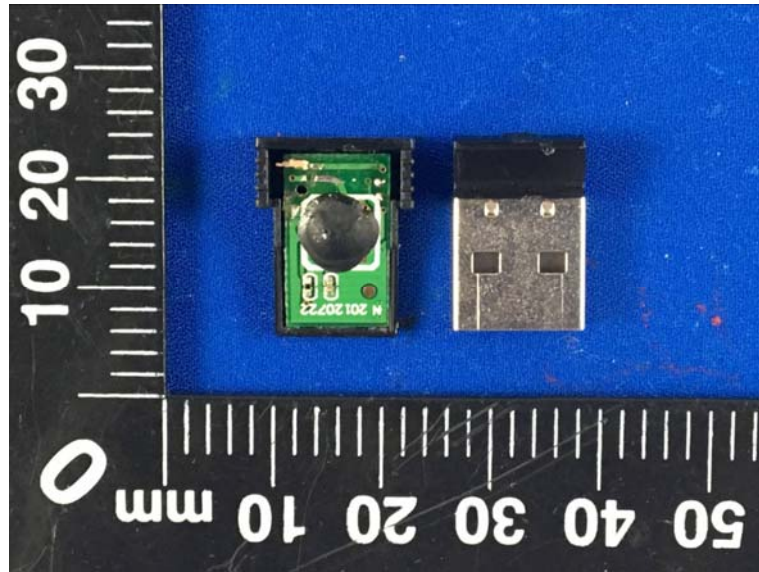

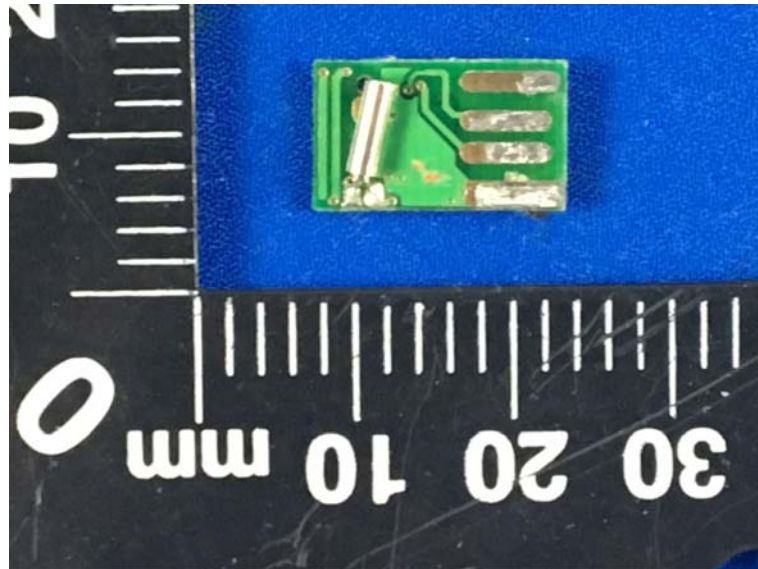

\*\*\*\*\* End of Report \*\*\*\*\*