

FCC/ISED - TEST REPORT

Report Number	: 68.950.23.0229.01	Date of Issue:	2023-03-03
Model/HVIN	: A2292		
Product Type	: Smart watch		
Applicant	: Anhui Huami Information Technology Co., Ltd.		
Address	: 7/F, Building B2, Huami Global Innovation Center, No. 900, Wangjiang West Road, High-tech Zone, Hefei City, Anhui Pilot Free Trade Zone China		
Manufacturer	: Anhui Huami Information Technology Co., Ltd.		
Address	: 7/F, Building B2, Huami Global Innovation Center, No. 900, Wangjiang West Road, High-tech Zone, Hefei City, Anhui Pilot Free Trade Zone China		
Factory	: Shenzhen Yecon Industry Co., Ltd.		
Address	: Section A of Floor 6 and Floor 1 to Floor 5, No. 101, No. 2 Building, District 6th, Cuigang Industrial Zone, Huaide, Fuyong, Bao'an District, Shenzhen City, Guangdong Province, P.R. China		
Test Result	: <input checked="" type="checkbox"/> Positive <input type="checkbox"/> Negative		
Total pages including Appendices	: 71		

Any use for advertising purposes must be granted in writing. This technical report may only be quoted in full. This report is the result of a single examination of the object in question and is not generally applicable evaluation of the quality of other products in regular production. For further details, please see testing and certification regulation, chapter A-3.4.



1 Table of Contents

1	Table of Contents	2
2	Details about the Test Laboratory	3
3	Description of the Equipment Under Test	4
4	Summary of Test Standards	5
5	Summary of Test Results	6
6	General Remarks	7
7	Test Setups	8
8	Systems Test Configuration	10
9	Technical Requirement	11
9.1	Conducted Emission	11
9.2	Conducted Peak Output Power & EIRP	14
9.3	20 dB Bandwidth and 99% Occupied Bandwidth	19
9.4	Carrier Frequency Separation	27
9.5	Number of Hopping Frequencies	30
9.6	Dwell Time.....	33
9.7	Spurious RF Conducted Emissions	37
9.8	Band Edge Testing.....	48
9.9	Spurious Radiated Emissions for Transmitter.....	54
10	Test Equipment List.....	70
11	System Measurement Uncertainty	71



2 Details about the Test Laboratory

Details about the Test Laboratory

Test Site 1

Company name: TÜV SÜD Certification and Testing (China) Co., Ltd. Shenzhen Branch
Building 12 & 13, Zhiheng Wisdomland Business Park, Nantou Checkpoint Road
2, Nanshan District
Shenzhen 518052
P.R. China

Telephone: 86 755 8828 6998

Fax: 86 755 828 5299

FCC Registration
No.: 514049

FCC Designation
Number: CN5009

IC Registration
No.: 10320A

3 Description of the Equipment Under Test

Product:	Smart watch
Model no.:	A2292
Hardware Version Identification No. (HVIN)	A2292
Product Marketing Name (PMN)	A2292
Brand name:	AMAZFIT
FCC ID:	2AC8UA2292
IC:	21806-A2292
Options and accessories:	N/A
Battery information:	Rechargeable Li-ion Battery Model:PL582624 Rated:3.87VDC 440mAh/1.7Wh
Rating:	5VDC 700mA
RF Transmission Frequency:	2402MHz-2480MHz
No. of Operated Channel:	79
Modulation:	GFSK, $\pi/4$ -DQPSK, 8DPSK
Antenna Type:	Metal Case
Antenna	Gain: -2.99dBi
Description of the EUT:	The Equipment Under Test (EUT) is a Smart watch which support Bluetooth function and Wi-Fi operated at 2.4GHz. Only Bluetooth (BR+EDR) included in this report.

NOTE 1: The above EUT's information is declared by manufacturer. Please refer to the specifications or user's manual for more detailed description.

4 Summary of Test Standards

Test Standards	
FCC Part 15 Subpart C 10-1-2021 Edition	PART 15 - RADIO FREQUENCY DEVICES Subpart C - Intentional Radiators
RSS-Gen Issue 5 April 2018 + A1 + A2	General Requirements for Compliance of Radio Apparatus
RSS-247 Issue 2 February 2017	Digital Transmission Systems (DTSS), Frequency Hopping Systems (FHSS) and License-Exempt Local Area Network (LE- LAN) Devices

All the test methods were according to KDB 558074 D01 15.247 Meas Guidance v05r02 Measurement Guidance and ANSI C63.10 (2013).

5 Summary of Test Results

Technical Requirements			
FCC Part 15 Subpart C/ RSS-247 Issue 2/RSS-Gen Issue 5			
Test Condition		Test Site	Test Result
§15.207& RSS-Gen 8.8	Conducted emission AC power port	Site 1	Pass
§15.247(b)(1)	Conducted peak output power	Site 1	Pass
RSS-247 5.4(b)	Conducted peak output power and Equivalent Isotropic Radiated Power	Site 1	Pass
§15.247(a)(1) & RSS-247 5.1(a) & RSS-Gen 6.7	20dB bandwidth and 99% occupied bandwidth	Site 1	Pass
§15.247(a)(1) & RSS-247 5.1(b)	Carrier channel frequency separation	Site 1	Pass
§15.247(a)(1)(iii) & RSS-247 5.1(d)	Number of hopping frequencies	Site 1	Pass
§15.247(a)(1)(iii) & RSS-247 5.1(d)	Dwell Time - Average Time of Occupancy	Site 1	Pass
§15.247(d) & RSS-247 5.5	Spurious RF conducted emissions	Site 1	Pass
§15.247(d) & RSS-247 5.5	Band edge	Site 1	Pass
§15.247(d) & §15.209 & §15.205 & RSS-247 5.5 & RSS-Gen 6.13	Spurious radiated emissions for transmitter	Site 1	Pass
§15.203 & RSS-Gen 6.8	Antenna requirement	See note 2	Pass

Note 1: N/A=Not Applicable.

Note 2: The EUT uses a metal case antenna, which gain is -2.99 dBi. In accordance to §15.203 & RSS-Gen 6.8, it is considered sufficiently to comply with the provisions of this section.

6 General Remarks

Remarks

This submittal(s) (test report) is intended for FCC ID: 2AC8UA2292, IC: 21806-A2292, complies with Section 15.207, 15.209, 15.247 of the FCC Part 15, Subpart C rules and RSS-247, RSS-GEN.

SUMMARY:

All tests according to the regulations cited on page 5 were

■ - Performed

□ - **Not** Performed

The Equipment Under Test

■ - **Fulfills** the general approval requirements.

□ - **Does not** fulfill the general approval requirements.

Sample Received Date: 2023-02-10

Testing Start Date: 2023-02-14

Testing End Date: 2023-03-02

- TÜV SÜD Certification and Testing (China) Co., Ltd. Shenzhen Branch -

Reviewed by:

John Zhi
Section Manager

Prepared by:

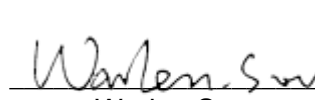
Warlen Song
Project Engineer

Tested by:

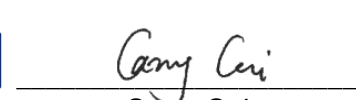
Carry Cai
Test Engineer



7 Test Setups

7.1 AC Power Line Conducted Emission test setups

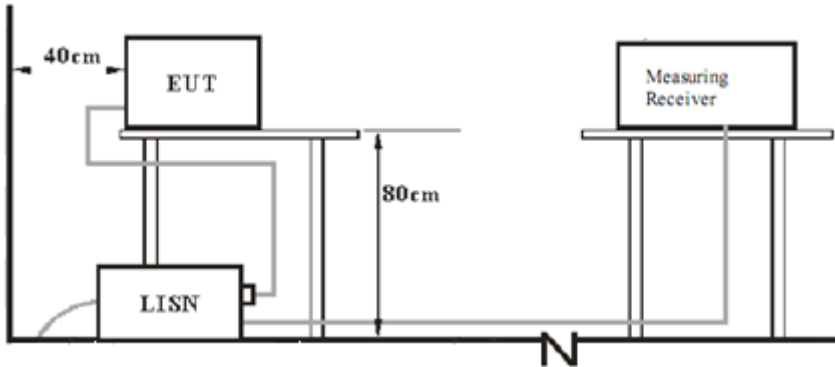

7.2 Radiated test setups 9KHz - 30MHz

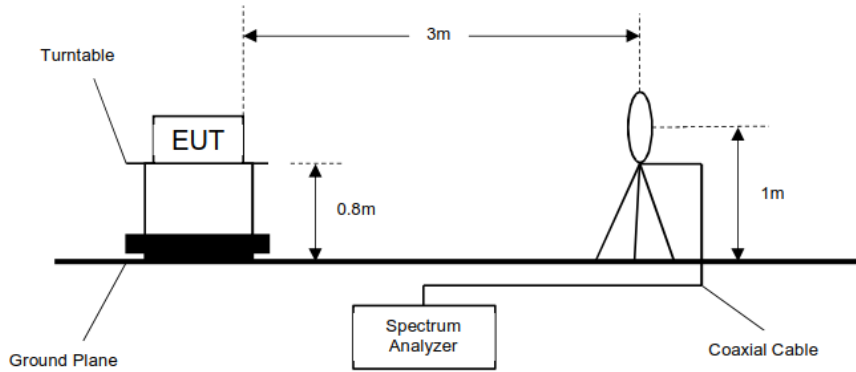

30MHz - 1GHz

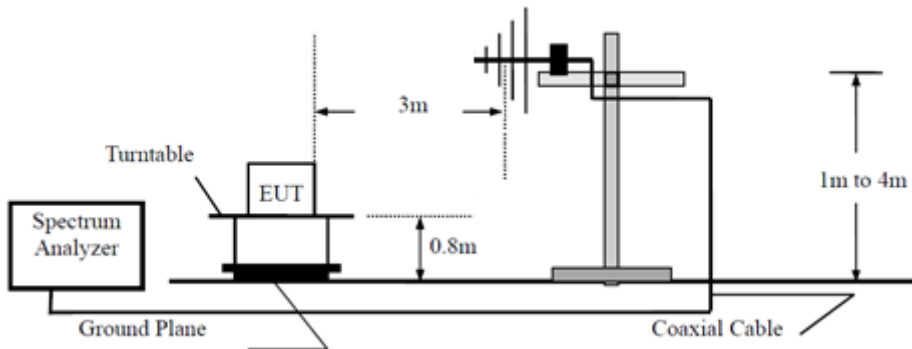

Above 1GHz

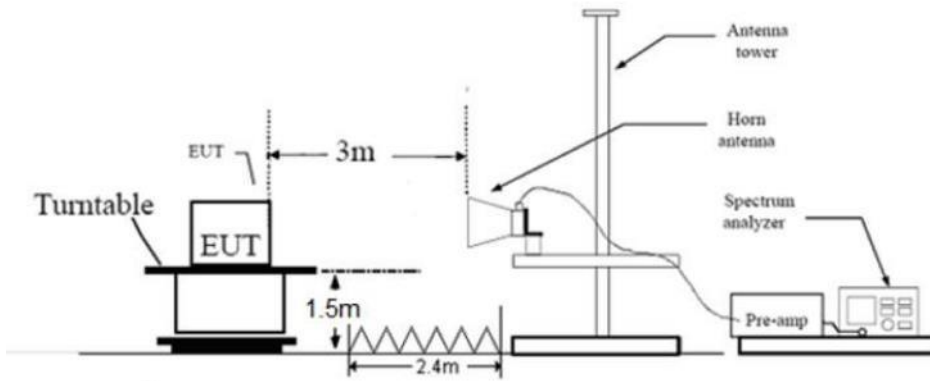

7.3 Conducted RF test setups

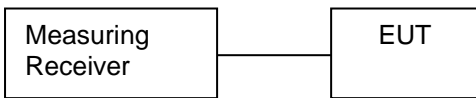

8 Systems Test Configuration

Auxiliary Equipment Used during Test:

Description	Manufacturer	Model NO.	S/N
Adapter	Apple	A1443	---
Notebook	LENOVO	X220	---

Cables Used During Test:

Cable	Length	Shielded/unshielded	With / without ferrite
---	---	---	---

Test software information:

Test Software Version	Broadcom BlueTool	
Modulation	Setting TX Power	Packet Type
GFSK	Default	PRBS9
$\pi/4$ -DQPSK	Default	PRBS9
8DPSK	Default	PRBS9

The system was configured to hopping mode and non-hopping mode.

Hopping mode: typical working mode (normal hopping status)

Non-hopping mode: The system was configured to operate at a signal channel transmitting. The test software allows the configuration and operation at the worst-case duty and the highest transmit power

9 Technical Requirement

9.1 Conducted Emission

Test Method

1. The EUT was placed 0.4 meter from the conducting wall of the shielding room was kept at least 80 centimeters from any other grounded conducting surface.
2. Connect EUT to the power mains through a line impedance stabilization network (LISN).
3. All the support units are connecting to the other LISN.
4. The LISN provides 50 ohm coupling impedance for the measuring instrument.
5. Both sides of AC line were checked for maximum conducted interference.
6. The frequency range from 150 kHz to 30 MHz was searched.
7. Set the test-receiver system to Peak Detect Function and specified bandwidth (IF Bandwidth = 9kHz) with Maximum Hold Mode. Then measurement is also conducted by Average Detector and Quasi-Peak Detector Function respectively.

Limit

Frequency MHz	QP Limit dB μ V	AV Limit dB μ V
0.150-0.500	66-56*	56-46*
0.500-5	56	46
5-30	60	50

*Decreases with the logarithm of the frequency.

Conducted Emission

Product Type : Smart watch
 M/N : A2292
 Operating Condition : Transmit
 Test Specification : Line
 Comment : AC 120V/60Hz

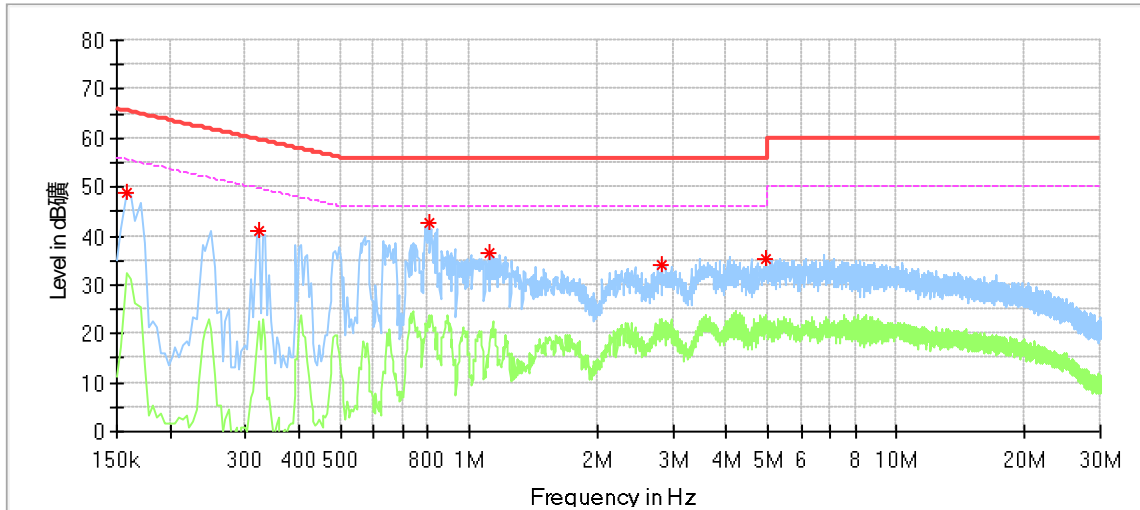

Frequency (MHz)	MaxPea* (dBµV)	Average* (dBµV)	Limit (dBµV)	Margin (dB)	Line	Corr. ** (dB)
0.158000	48.65	---	65.57	16.92	L1	9.58
0.322000	41.16	---	59.66	18.50	L1	9.61
0.806000	42.77	---	56.00	13.23	L1	9.64
1.114000	36.64	---	56.00	19.36	L1	9.64
2.834000	34.04	---	56.00	21.96	L1	9.69
4.954000	35.34	---	56.00	20.66	L1	9.77

Remark:

*Level=Reading Level + Correction Factor

**Correction Factor=Cable Loss + LISN Factor

(The Reading Level is recorded by software which is not shown in the sheet)

Conducted Emission

Product Type : Smart watch
 M/N : A2292
 Operating Condition : Transmit
 Test Specification : Neutral
 Comment : AC 120V/60Hz

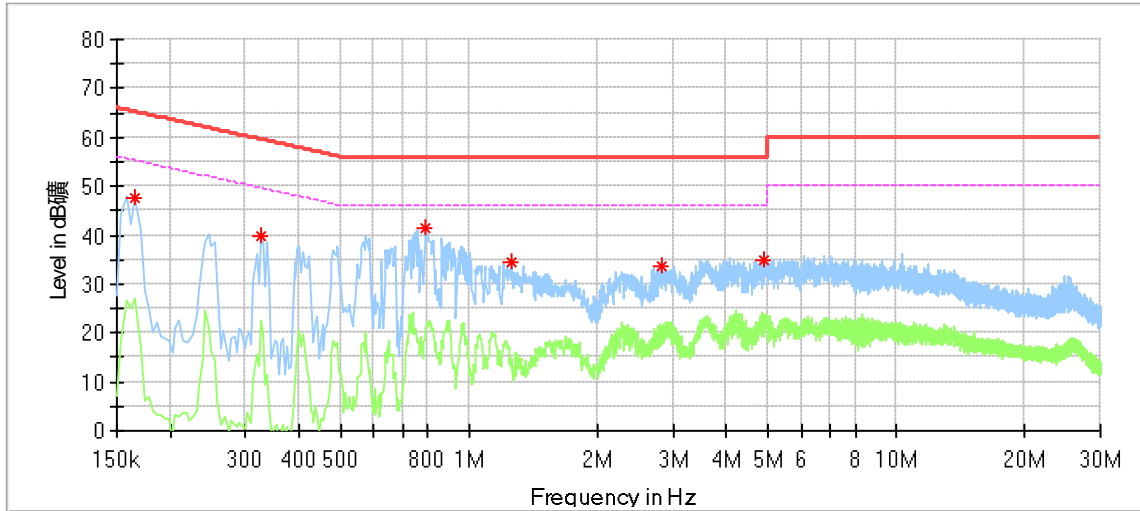

Frequency (MHz)	MaxPeak* (dBµV)	Averag* (dBµV)	Limit (dBµV)	Margin (dB)	Line	Corr. ** (dB)
0.166000	47.55	---	65.16	17.61	N	9.58
0.326000	39.70	---	59.55	19.85	N	9.61
0.794000	41.56	---	56.00	14.44	N	9.64
1.258000	34.47	---	56.00	21.53	N	9.64
2.830000	33.48	---	56.00	22.52	N	9.69
4.874000	35.01	---	56.00	20.99	N	9.76

Remark:

*Level=Reading Level + Correction Factor

**Correction Factor=Cable Loss + LISN Factor

(The Reading Level is recorded by software which is not shown in the sheet)

9.2 Conducted Peak Output Power & EIRP

Test Method

1. The RF output of EUT was connected to the test receiver by RF cable. The path loss was compensated to the results for each measurement.
2. Set to the maximum power setting and enable the EUT transmit continuously
3. Use the following test receiver settings:
Span = approximately 5 times the 20dB bandwidth, centered on a hopping channel
RBW > the 20dB bandwidth of the emission being measured, VBW ≥ RBW,
Sweep = auto, Detector function = peak, Trace = max hold
4. Allow the trace to stabilize. Use the marker-to-peak function to set the marker to the peak of the emission. The indicated level is the peak output power and record the results in the test report.
5. Repeat above procedures until all frequencies measured were complete.

Limits

According to §15.247 (b) (1) & RSS-247 5.4(b), conducted peak output power limit as below:

Frequency Range MHz	Limit W	Limit dBm
2400-2483.5	≤1	≤30

According to & RSS-247 5.4(b), EIRP limit as below:

Frequency Range MHz	Limit W	Limit dBm
2400-2483.5	≤4	≤36

Conducted Peak Output Power & EIRP

Bluetooth Mode GFSK modulation Test Result

Frequency MHz	Conducted Peak Output Power dBm	Antenna Gain dBi	EIRP dBm	Result
Low channel 2402MHz	7.19	-2.99	4.20	Pass
Middle channel 2441MHz	5.90	-2.99	2.91	Pass
High channel 2480MHz	5.28	-2.99	2.29	Pass

Bluetooth Mode $\pi/4$ -DQPSK modulation Test Result

Frequency MHz	Conducted Peak Output Power dBm	Antenna Gain dBi	EIRP dBm	Result
Low channel 2402MHz	2.50	-2.99	-0.49	Pass
Middle channel 2441MHz	3.16	-2.99	0.17	Pass
High channel 2480MHz	2.59	-2.99	-0.40	Pass

Bluetooth Mode 8DPSK modulation Test Result

Frequency MHz	Conducted Peak Output Power dBm	Antenna Gain dBi	EIRP dBm	Result
Low channel 2402MHz	2.96	-2.99	-0.03	Pass
Middle channel 2441MHz	3.66	-2.99	0.67	Pass
High channel 2480MHz	3.15	-2.99	0.16	Pass

DH5_Ant1_2402

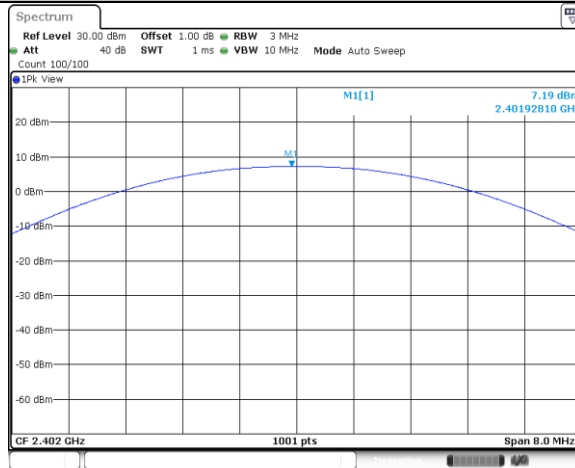

Date: 15.FEB.2023 18:57:41

DH5_Ant1_2441

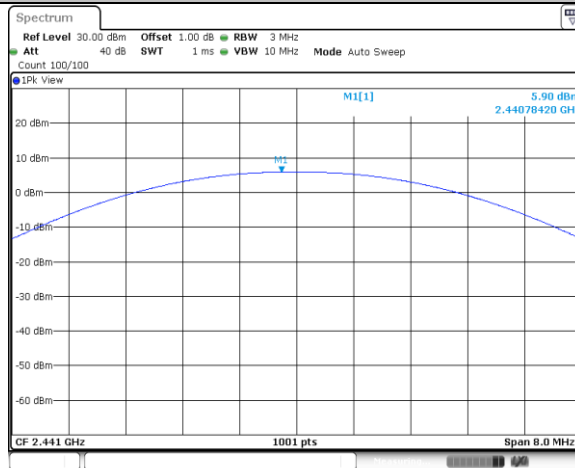

Date: 15.FEB.2023 18:58:04

DH5_Ant1_2480

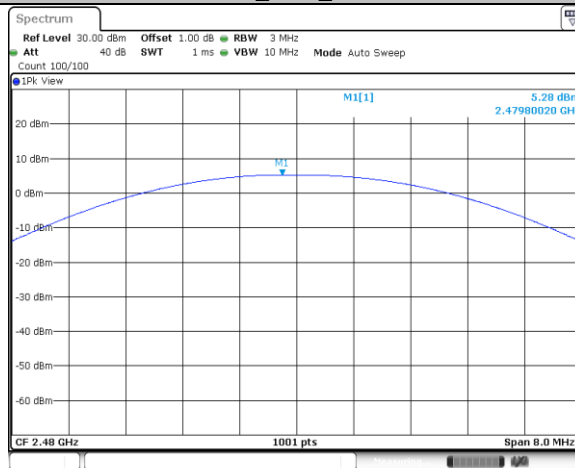

Date: 15.FEB.2023 18:58:19

2DH5_Ant1_2402

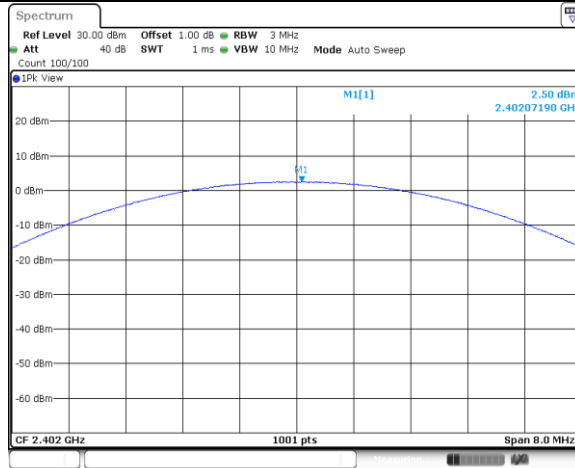

Date: 15 FEB 2023 18:58:43

2DH5_Ant1_2441

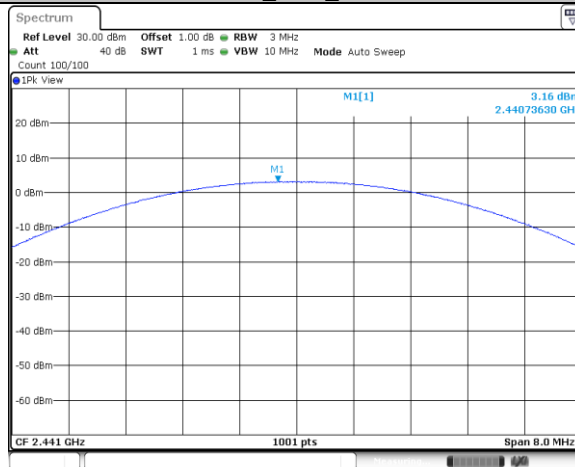

Date: 15 FEB 2023 18:58:59

2DH5_Ant1_2480

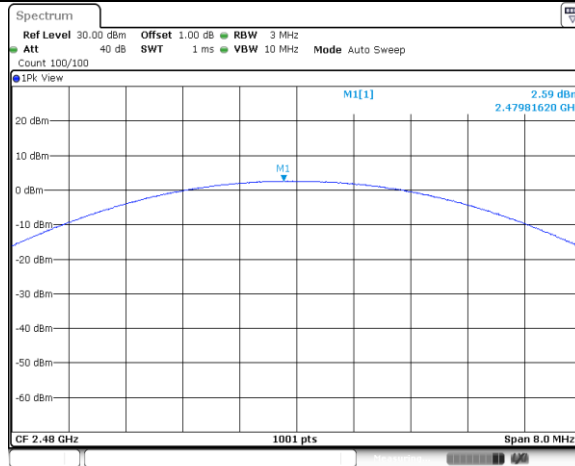

Date: 15 FEB 2023 18:59:36

3DH5_Ant1_2402

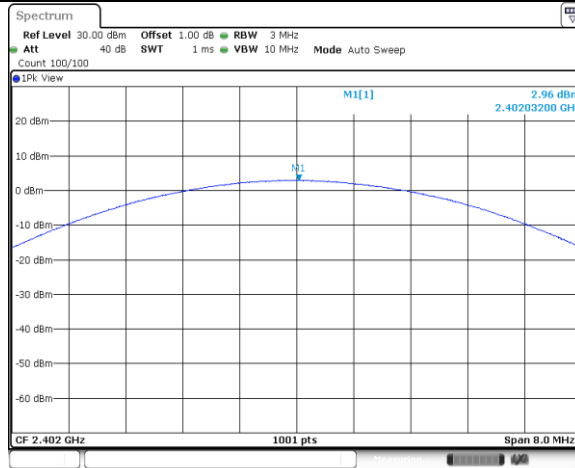

Date: 15 FEB 2023 18:59:50

3DH5_Ant1_2441

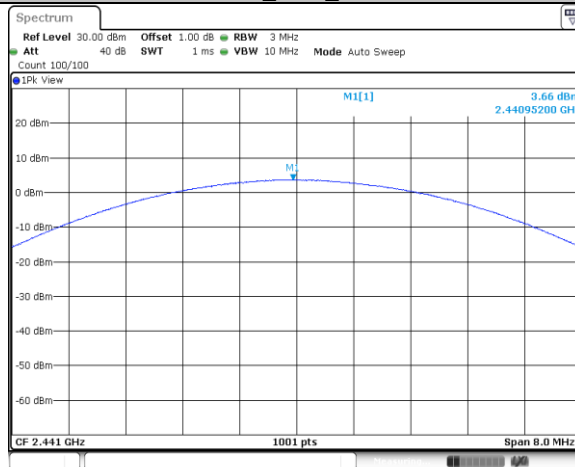

Date: 15 FEB 2023 19:00:17

3DH5_Ant1_2480

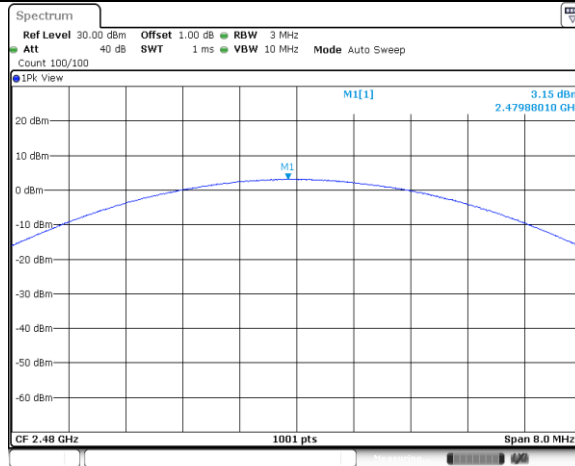

Date: 15 FEB 2023 19:00:33

9.3 20 dB Bandwidth and 99% Occupied Bandwidth

Test Method

1. The RF output of EUT was connected to the test receiver by RF cable. The path loss was compensated to the results for each measurement.
2. Set to the maximum power setting and enable the EUT transmit continuously.
3. Use the following test receiver settings:
 Span = approximately 2 to 3 times the 20 dB bandwidth, centered on a hopping channel
 RBW \geq 1% to 5% of the 20 dB bandwidth/OBW, VBW \geq 3RBW,
 Sweep = auto, Detector function = peak, Trace = max hold
4. Allow the trace to stabilize. Use the marker-to-peak function to set the marker to the peak of the emission. Measure the frequency difference of two frequencies that were attenuated 20 dB from the reference level. Record the frequency difference as the emission bandwidth. Record the results.
5. Repeat above procedures until all frequencies measured were complete.

Limit

Limit [kHz]

N/A

20 dB bandwidth and 99% Occupied Bandwidth

Test result

TestMode	Frequency MHz	20 dB Bandwidth MHz	99% Bandwidth MHz	Limit MHz	Result
GFSK	2402	1.119	0.893	--	Pass
GFSK	2441	1.119	0.893	--	Pass
GFSK	2480	1.119	0.893	--	Pass
$\pi/4$ -DQPSK	2402	1.413	1.196	--	Pass
$\pi/4$ -DQPSK	2441	1.413	1.199	--	Pass
$\pi/4$ -DQPSK	2480	1.413	1.199	--	Pass
8DPSK	2402	1.407	1.202	--	Pass
8DPSK	2441	1.413	1.202	--	Pass
8DPSK	2480	1.410	1.205	--	Pass

20 dB Bandwidth

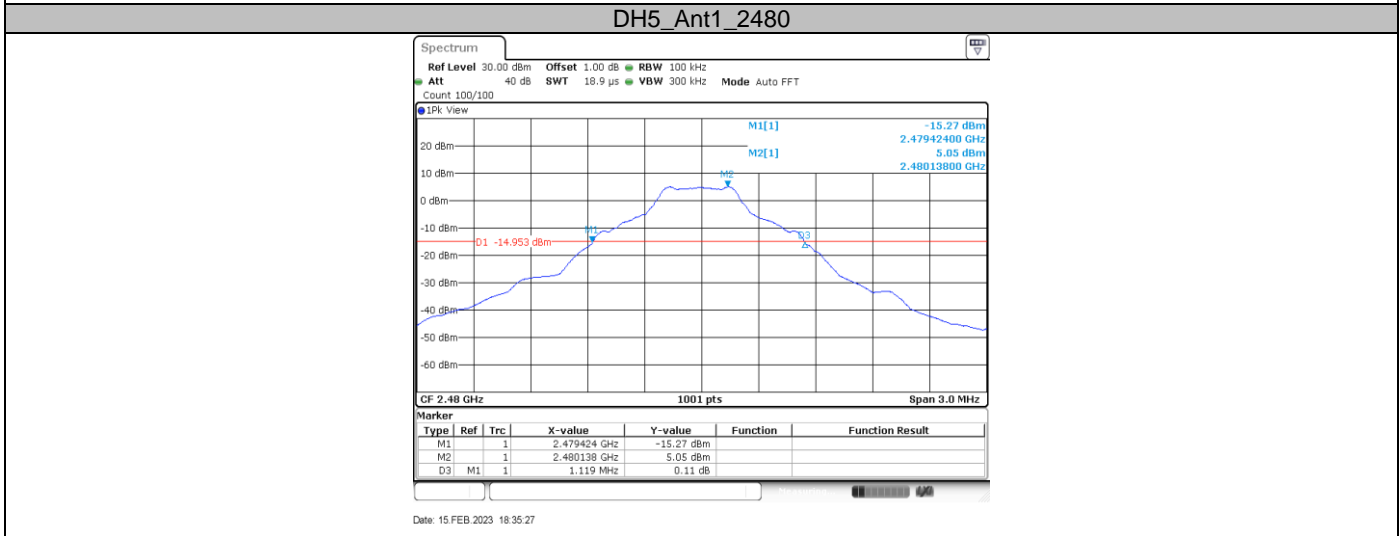
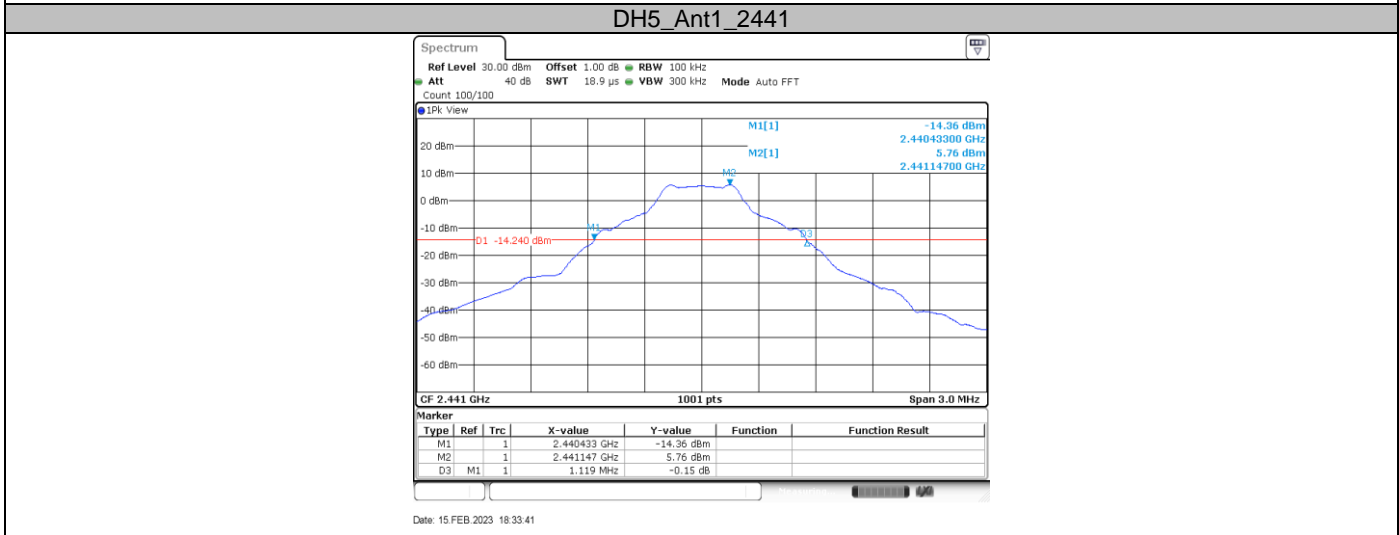
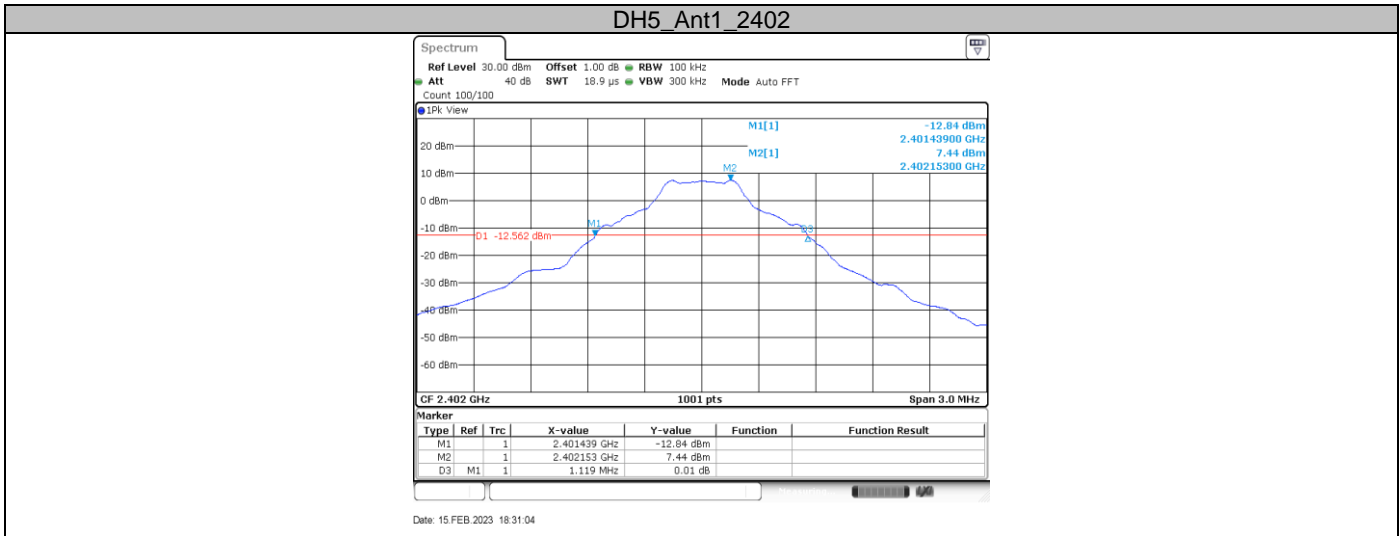

2DH5_Ant1_2402

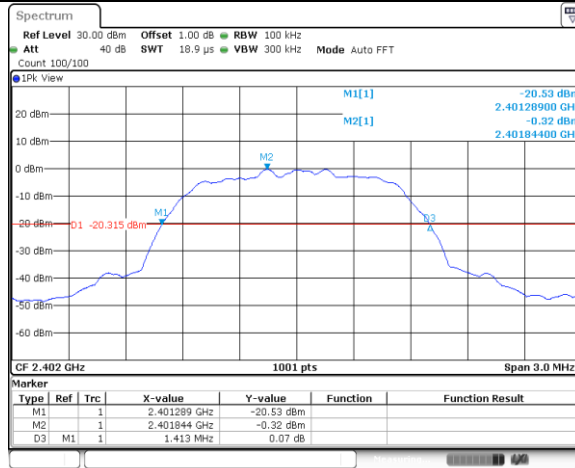

Date: 15 FEB 2023 18:37:23

2DH5_Ant1_2441

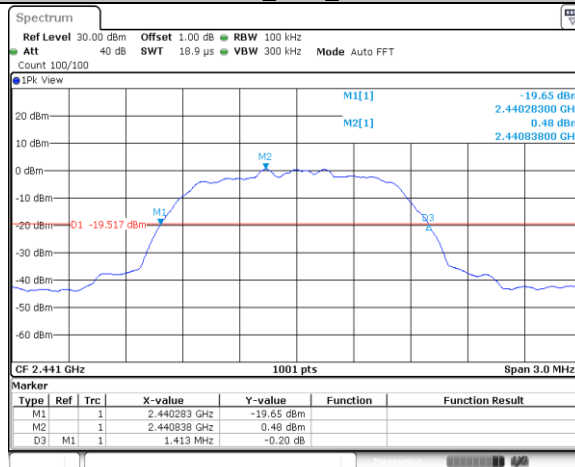

Date: 15 FEB 2023 18:39:28

2DH5_Ant1_2480

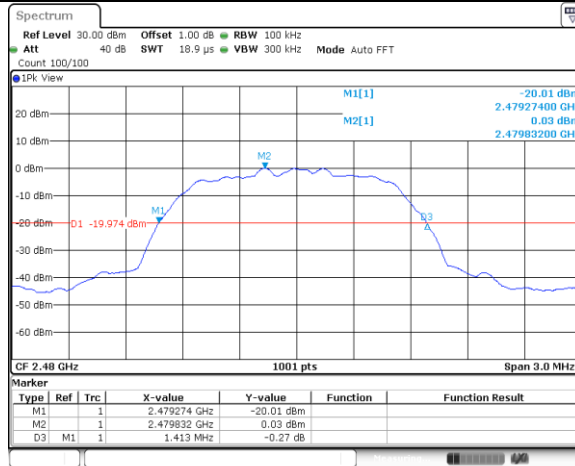

Date: 15 FEB 2023 18:41:09

3DH5_Ant1_2402

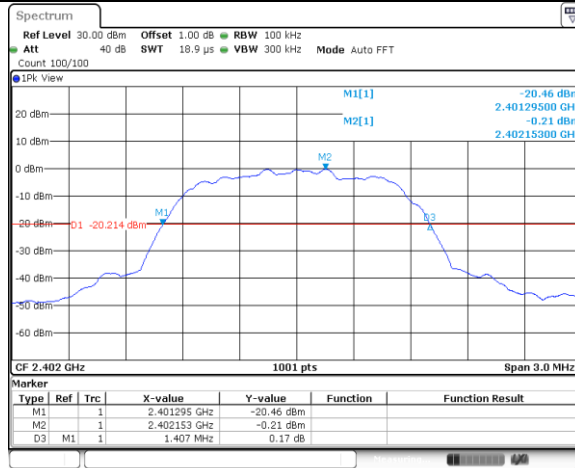

Date: 15 FEB 2023 18:44:28

3DH5_Ant1_2441

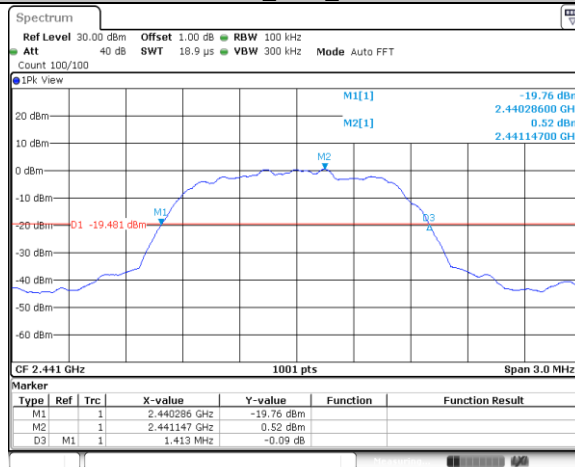

Date: 15 FEB 2023 18:45:57

3DH5_Ant1_2480

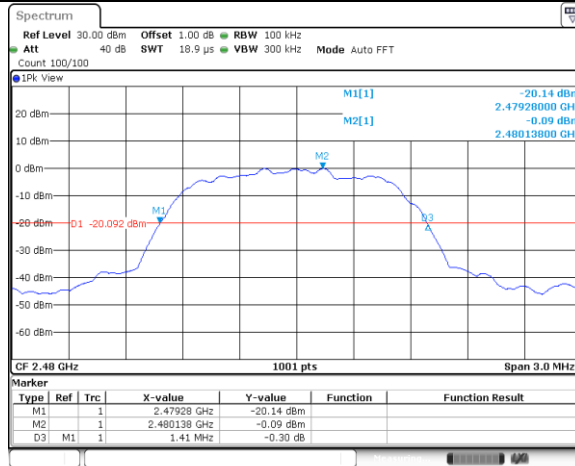

Date: 15 FEB 2023 18:47:23

99% Occupied Bandwidth

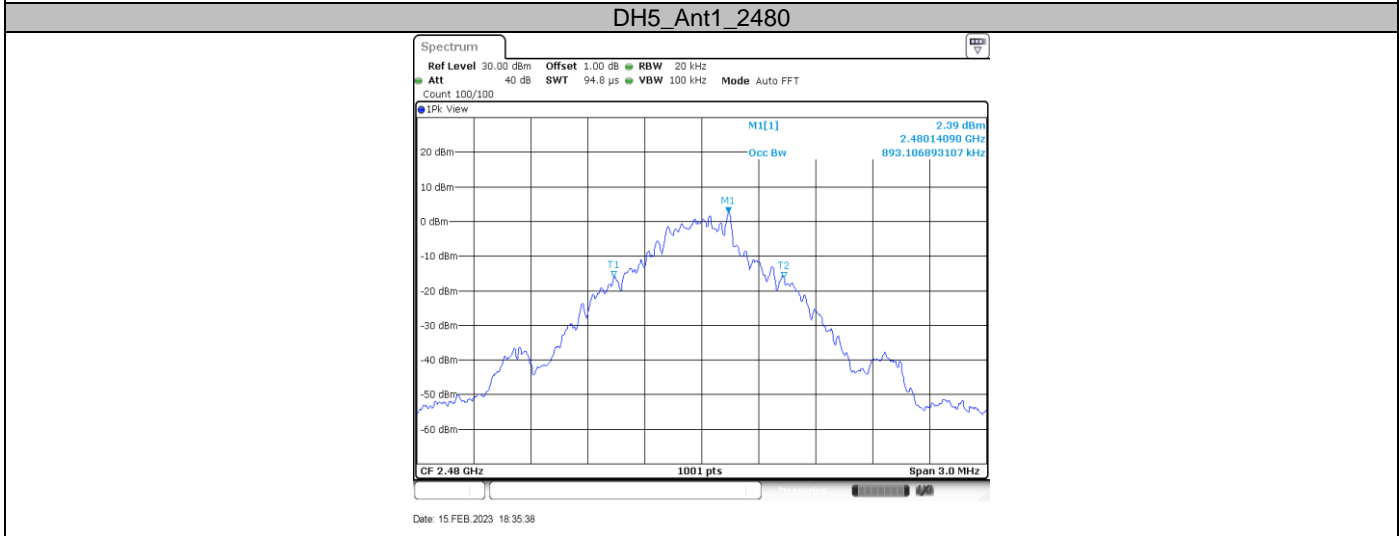
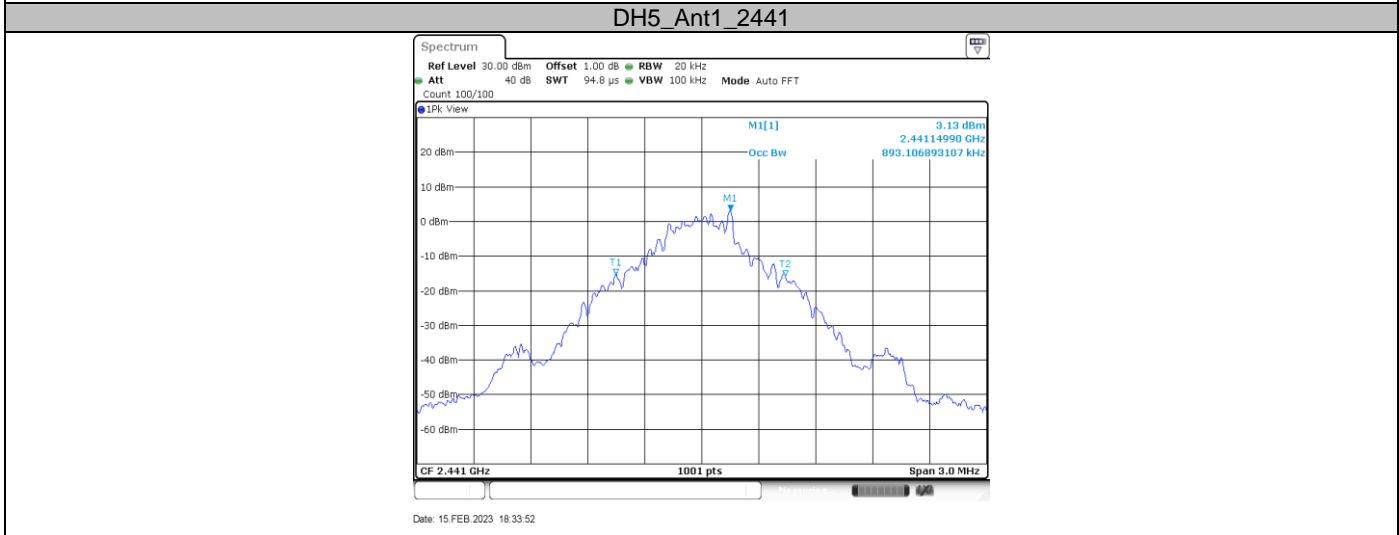
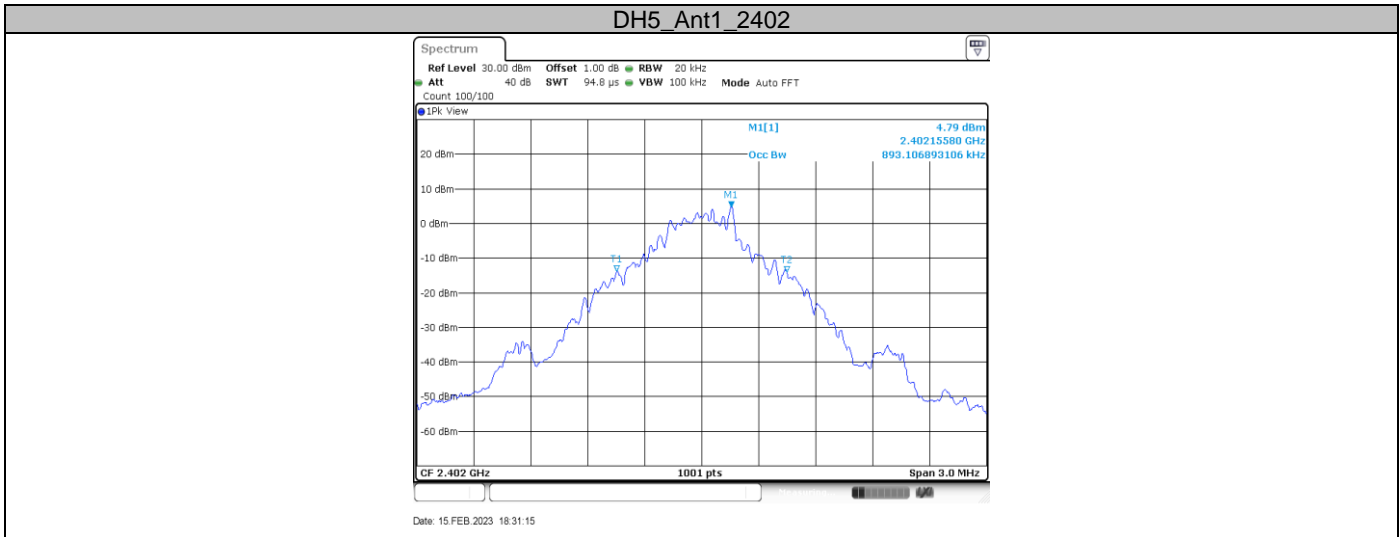

2DH5_Ant1_2402

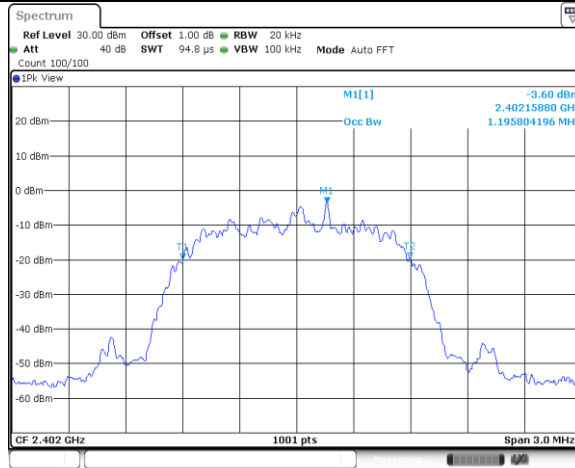

Date: 15 FEB 2023 18:37:34

2DH5_Ant1_2441

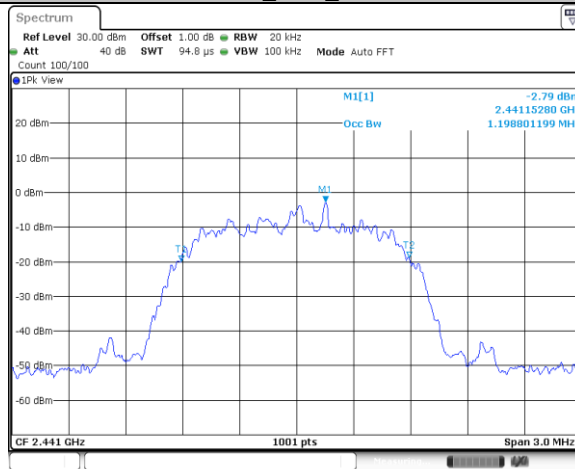

Date: 15 FEB 2023 18:39:39

2DH5_Ant1_2480

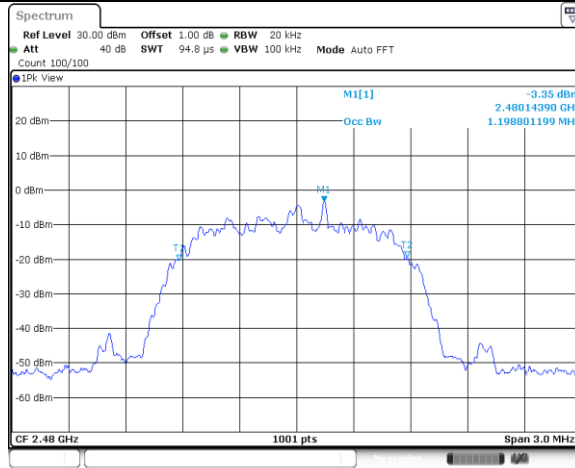

Date: 15 FEB 2023 18:41:20

3DH5_Ant1_2402



Date: 15 FEB 2023 18:44:38

3DH5_Ant1_2441

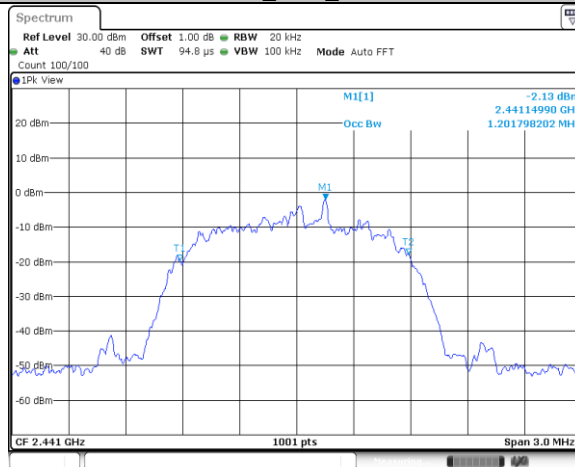

Date: 15 FEB 2023 18:46:08

3DH5_Ant1_2480



Date: 15 FEB 2023 18:47:33

9.4 Carrier Frequency Separation

Test Method

1. The RF output of EUT was connected to the test receiver by RF cable The path loss was compensated to the results for each measurement.
2. Set to the maximum power setting and enable the EUT transmit to hopping mode.
3. Use the following spectrum analyzer settings:
Span = wide enough to capture the peaks of two adjacent channels, RBW \geq 1% of the span, VBW) \geq RBW, Sweep = auto, Detector function = peak
4. By using the Max-Hold function record the separation of two adjacent channels.
5. Measure the frequency difference of these two adjacent channels by spectrum analyzer marker function. Record the results.
6. Repeat above procedures until all frequencies measured were complete.

Limit

Limit kHz
\geq 25KHz or 2/3 of the 20 dB bandwidth which is greater

Limit

Modulation	Frequency MHz	2/3 of 20 dB Bandwidth kHz
GFSK	2441	746
π /4-DQPSK	2441	942
8DPSK	2441	942

Carrier Frequency Separation

Test result: The measurement was performed with the typical configuration (normal hopping status).

Modulation	Frequency MHz	Carrier Frequency Separation MHz	Result
GFSK	2441	1.301	Pass
$\pi/4$ -DQPSK	2441	0.962	Pass
8DPSK	2441	1.304	Pass

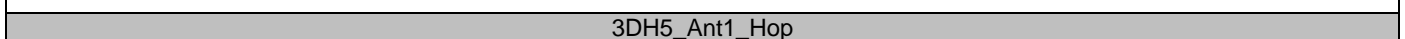
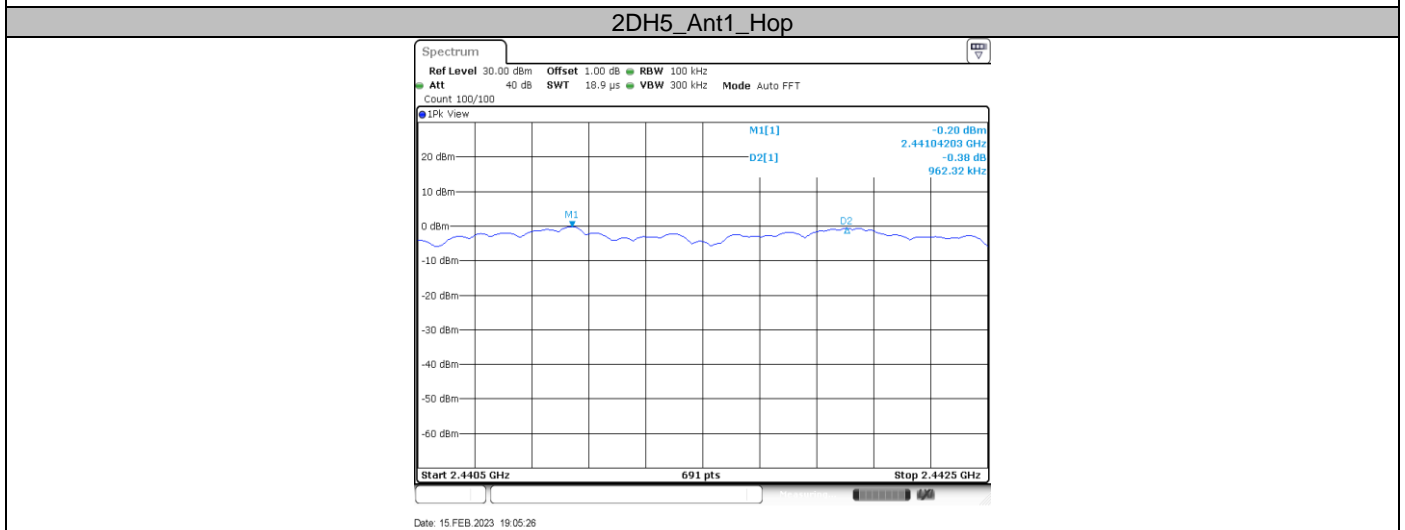
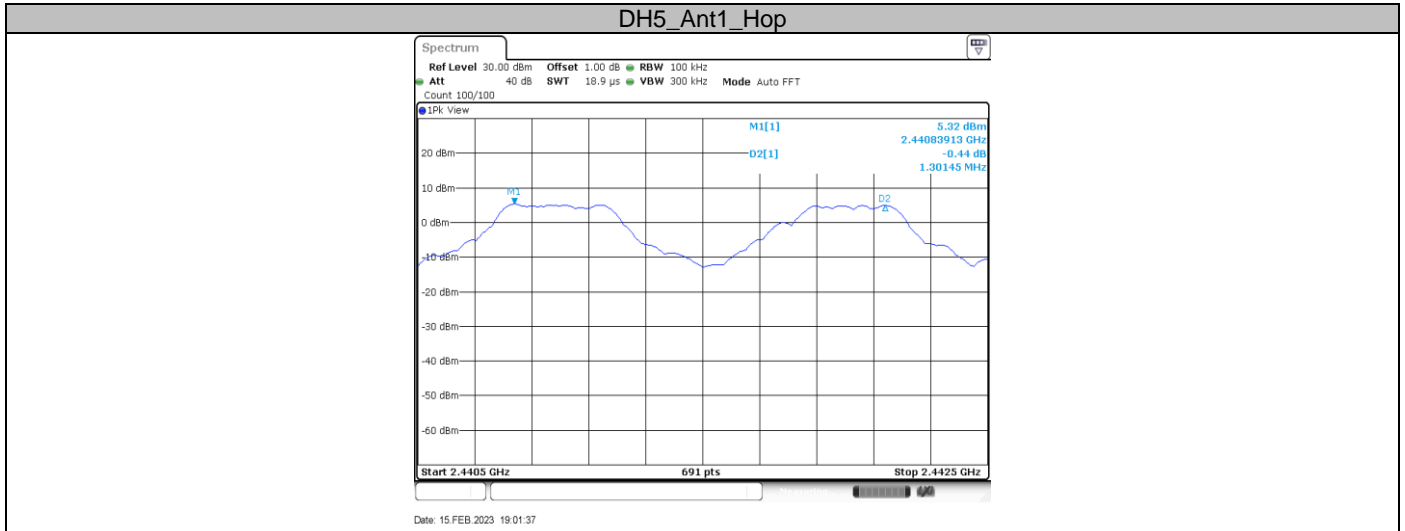

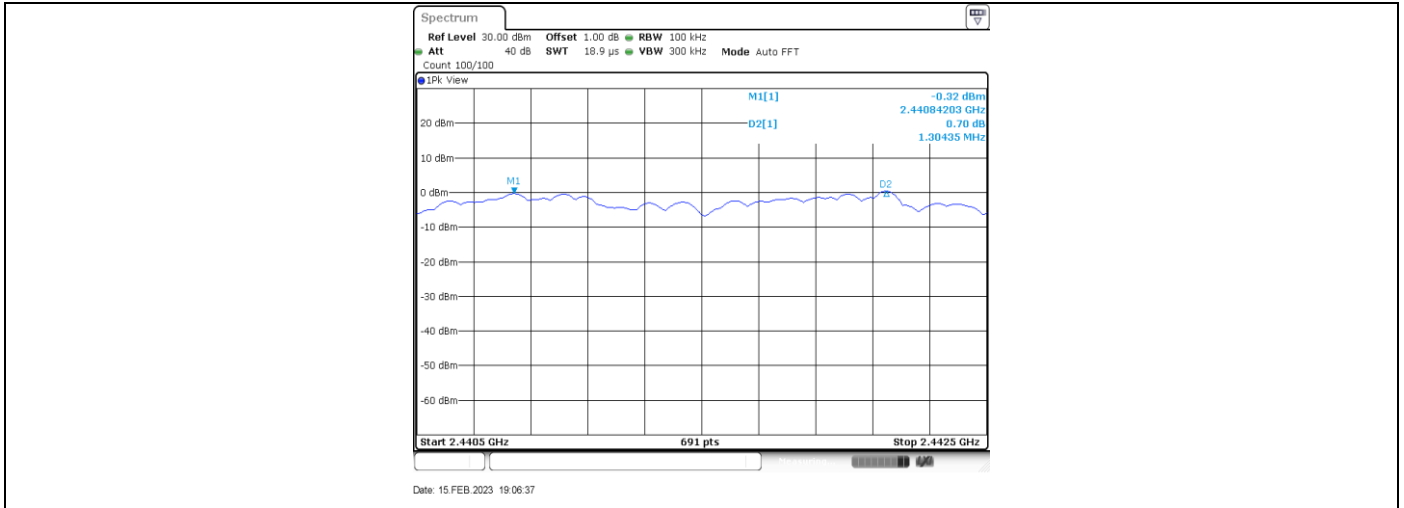

9.5 Number of Hopping Frequencies

Test Method

1. The RF output of EUT was connected to the test receiver by RF cable. The path loss was compensated to the results for each measurement.
2. Set to the maximum power setting and enable the EUT transmit to hopping mode.
3. Use the following spectrum analyzer settings:
Span = the frequency band of operation, RBW \geq 1% of the span, VBW \geq RBW,
Sweep = auto, Detector function = peak
4. Set the spectrum analyzer on Trace = max hold
5. Allow the trace to stabilize. It may prove necessary to break the span up to sections, in order to clearly show all of the hopping frequencies. The limit is specified in one of the subparagraphs of this Section. Submit this plot(s).

Limit

Limit
number
—————
 \geq 15

Number of Hopping Frequencies

Number of hopping frequencies	Result
79	Pass

DH5_Ant1_Hop

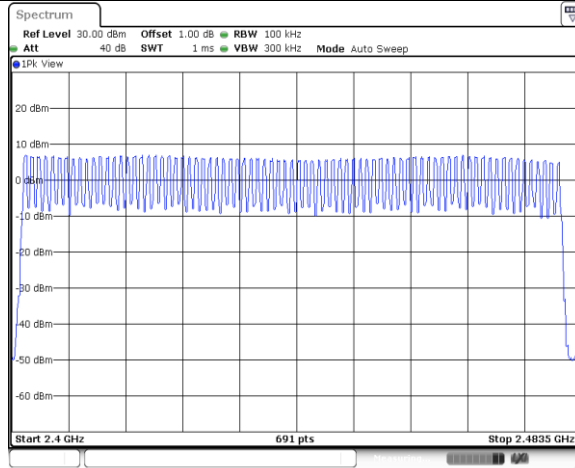

2DH5_Ant1_Hop

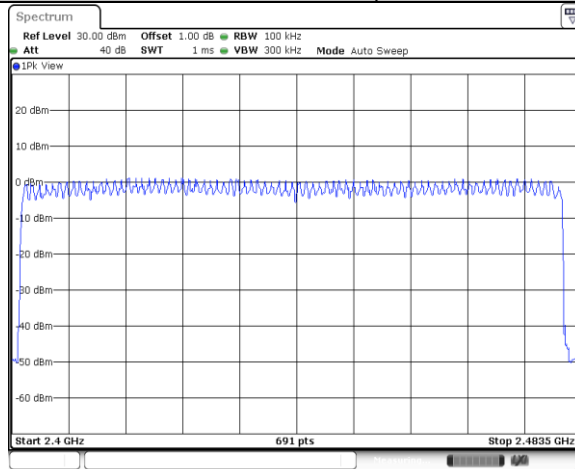

3DH5_Ant1_Hop

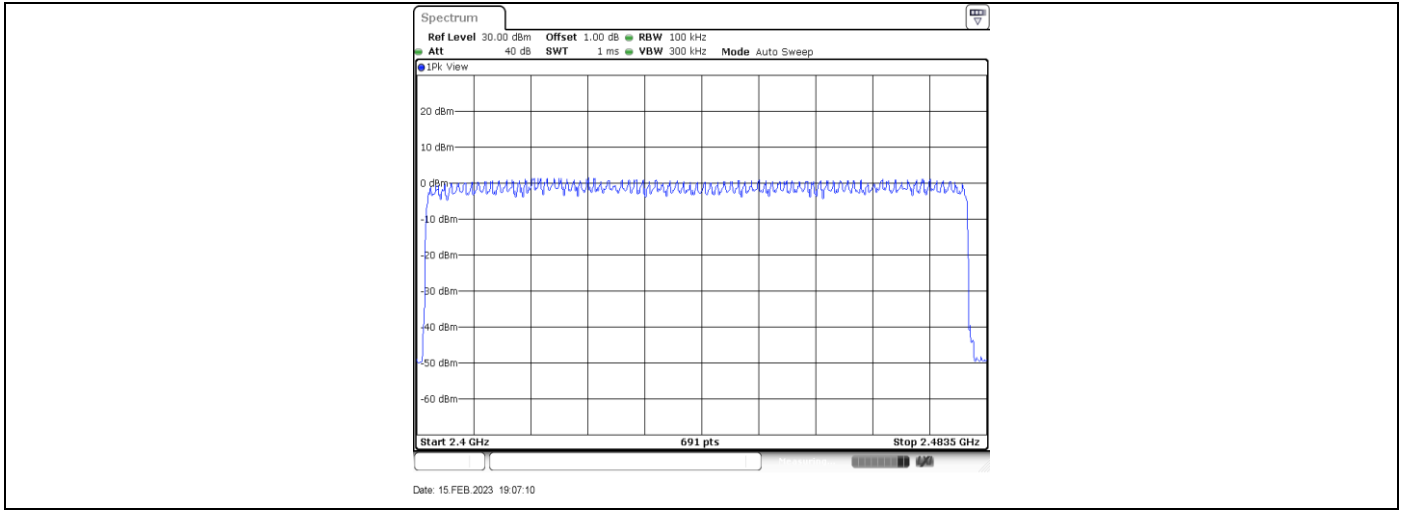

9.6 Dwell Time

Test Method

1. The RF output of EUT was connected to the test receiver by RF cable. The path loss was compensated to the results for each measurement.
2. Set to the maximum power setting and enable the EUT transmit to hopping mode.
3. Span: Zero span, centered on a hopping channel.
4. RBW shall be \ channel spacing and where possible RBW should be set $\gg 1 / T$, where T is the expected dwell time per channel.
5. Sweep: As necessary to capture the entire dwell time per hopping channel; where possible use a video trigger and trigger delay so that the transmitted signal starts a little to the right of the start of the plot. The trigger level might need slight adjustment to prevent triggering when the system hops on an adjacent channel; a second plot might be needed with a longer sweep time to show two successive hops on a channel.
6. Detector function: Peak.
7. Trace: Max hold. Use the marker-delta function to determine the transmit time per hop. If this value varies with different modes of operation (data rate, modulation format, number of hopping channels, etc.), then repeat this test for each variation in transmit time.

Limit

The average time of occupancy on any frequency shall not be greater than 0.4 seconds within a period of 0.4 seconds multiplied by the number of hopping channels employed.

Dwell Time

Dwell time

The maximum dwell time shall be 0.4 s.

According to the Bluetooth Core Specification, the worse result (DH5, 2DH5, 3DH5 mode) was reported to show compliance.

The Dwell Time = Burst Width * Total Hops.

Test Mode	Antenna	Channel	Burst Width (ms)	Total Hops	Result (s)	Limit (s)	Verdict
DH5	Ant0	Hop	2.87	40	0.115	<=0.4	PASS
2DH5	Ant0	Hop	2.87	80	0.23	<=0.4	PASS
3DH5	Ant0	Hop	2.88	90	0.259	<=0.4	PASS

DH5_Ant1_Hop

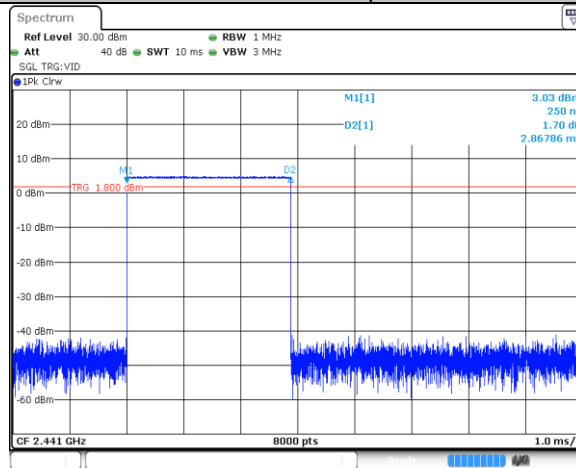

Date: 15 FEB 2023 19:02:15

2DH5_Ant1_Hop

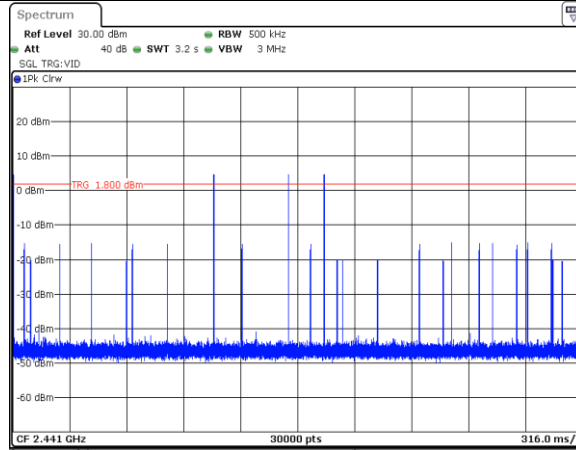

Date: 15 FEB 2023 19:02:20

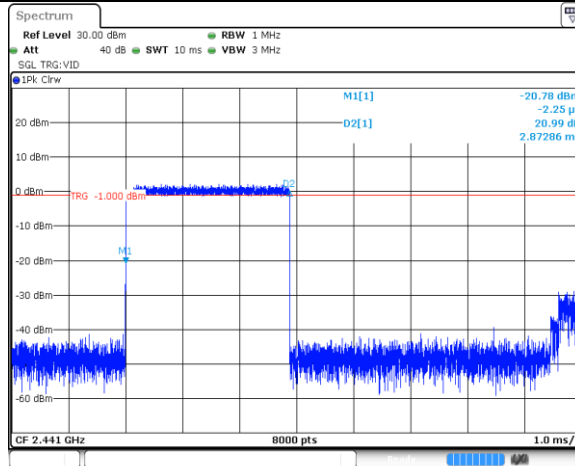

Date: 15 FEB 2023 19:05:47

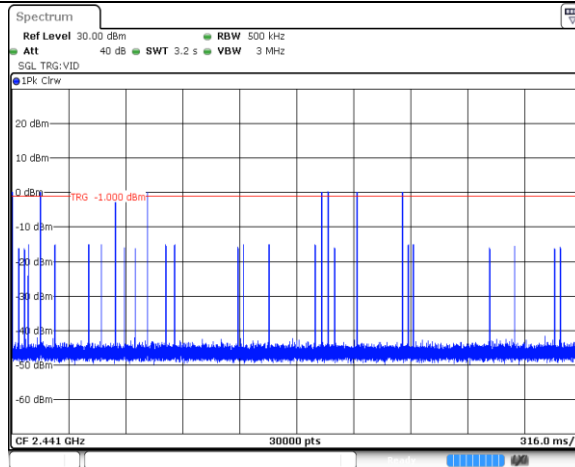

Date: 15 FEB 2023 19:05:52

3DH5_Ant1_Hop

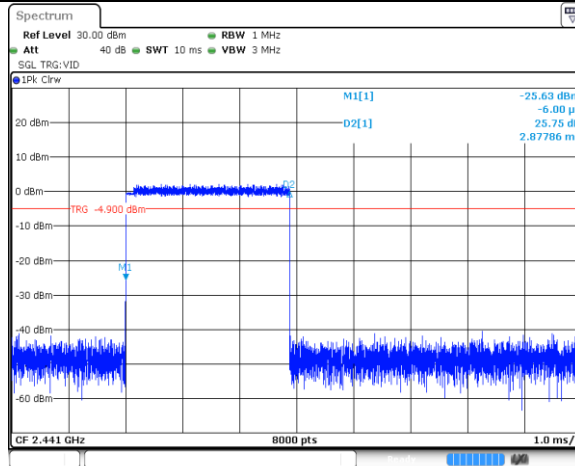

Date: 15 FEB 2023 19:07:56

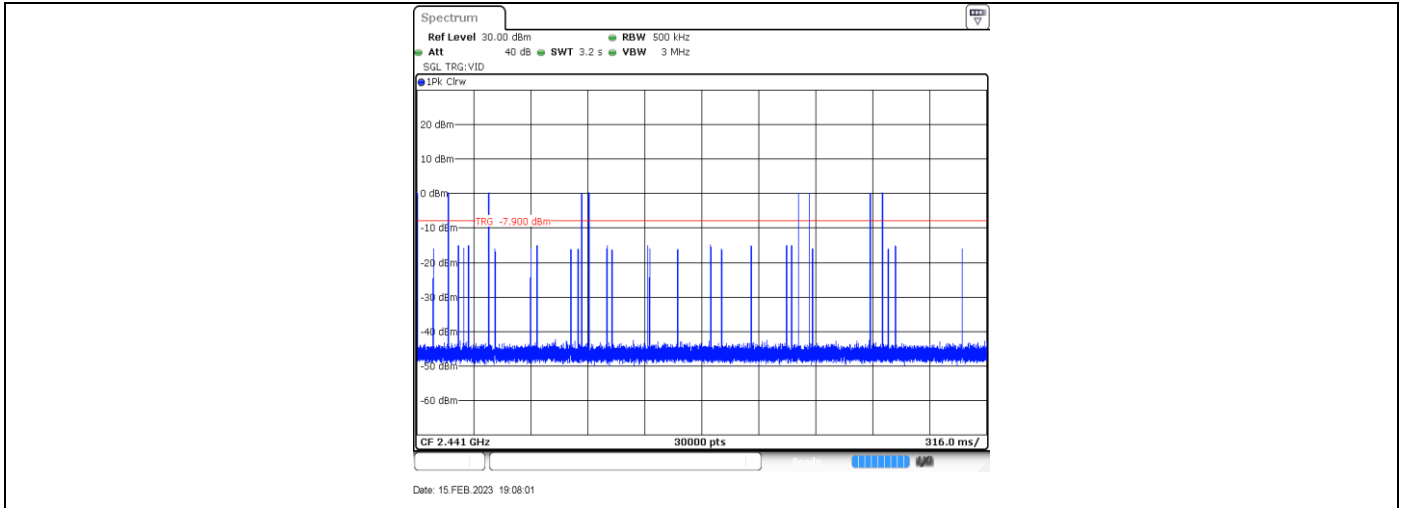

9.7 Spurious RF Conducted Emissions

Test Method

1. The RF output of EUT was connected to the test receiver by RF cable. The path loss was compensated to the results for each measurement.
2. Set to the maximum power setting and enable the EUT transmit continuously.
3. Set RBW = 100 kHz, VBW=300 kHz, Peak Detector. Unwanted Emissions measured in any 100 kHz bandwidth outside of the authorized frequency band shall be attenuated by at least 20 dB relative to the maximum in-band peak PSD level in 100 kHz when maximum peak conducted output power procedure is used. If the transmitter complies with the conducted power limits based on the use of RMS averaging over a time interval, the attenuation required under this paragraph shall be 30 dB instead of 20 dB.
4. Measure and record the results in the test report.
5. The RF fundamental frequency should be excluded against the limit line in the operating frequency

Limit

Frequency Range MHz	Limit (dBc)
30-25000	-20



Spurious RF Conducted Emissions

Test Mode	Antenna	Channel (MHz)	Frequency Range (MHz)	Reference Level	Result (dBm)	Limit (dBm)	Verdict
DH5	Ant0	2402	Reference	7.48 dBm	7.48	---	PASS
			30~1000	30~1000 MHz	-68.09	<=-12.52	PASS
			1000~26500	1000~26500 MHz	-49.55	<=-12.52	PASS
		2441	Reference	5.73 dBm	5.73	---	PASS
			30~1000	30~1000 MHz	-68.47	<=-14.27	PASS
			1000~26500	1000~26500 MHz	-51.78	<=-14.27	PASS
		2480	Reference	5.08 dBm	5.08	---	PASS
			30~1000	30~1000 MHz	-67.13	<=-14.92	PASS
			1000~26500	1000~26500 MHz	-52.04	<=-14.92	PASS
2DH5	Ant0	2402	Reference	-0.36 dBm	-0.36	---	PASS
			30~1000	30~1000 MHz	-66.82	<=-20.36	PASS
			1000~26500	1000~26500 MHz	-52.81	<=-20.36	PASS
		2441	Reference	0.47 dBm	0.47	---	PASS
			30~1000	30~1000 MHz	-67.92	<=-19.53	PASS
			1000~26500	1000~26500 MHz	-51.88	<=-19.53	PASS
		2480	Reference	0.03 dBm	0.03	---	PASS
			30~1000	30~1000 MHz	-67.71	<=-19.97	PASS
			1000~26500	1000~26500 MHz	-52.58	<=-19.97	PASS
3DH5	Ant0	2402	Reference	-0.25 dBm	-0.25	---	PASS
			30~1000	30~1000 MHz	-67.26	<=-20.25	PASS
			1000~26500	1000~26500 MHz	-44.74	<=-20.25	PASS
		2441	Reference	0.51 dBm	0.51	---	PASS
			30~1000	30~1000 MHz	-68.09	<=-19.49	PASS
			1000~26500	1000~26500 MHz	-51.96	<=-19.49	PASS
		2480	Reference	-0.12 dBm	-0.12	---	PASS
			30~1000	30~1000 MHz	-64.56	<=-20.12	PASS
			1000~26500	1000~26500 MHz	-52.66	<=-20.12	PASS

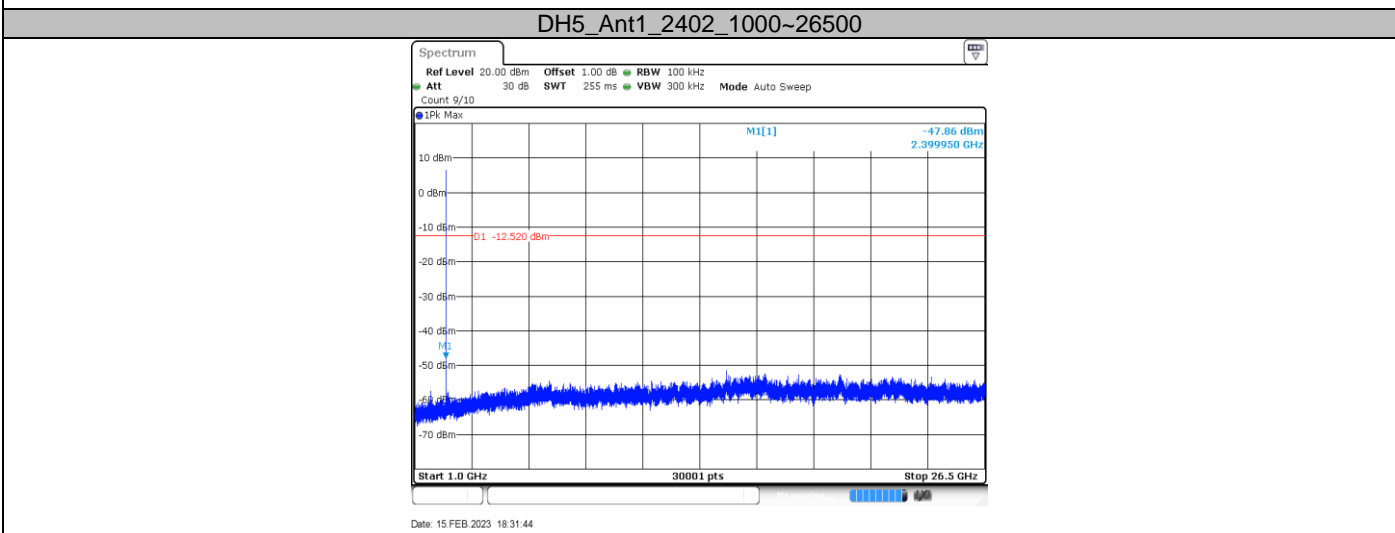
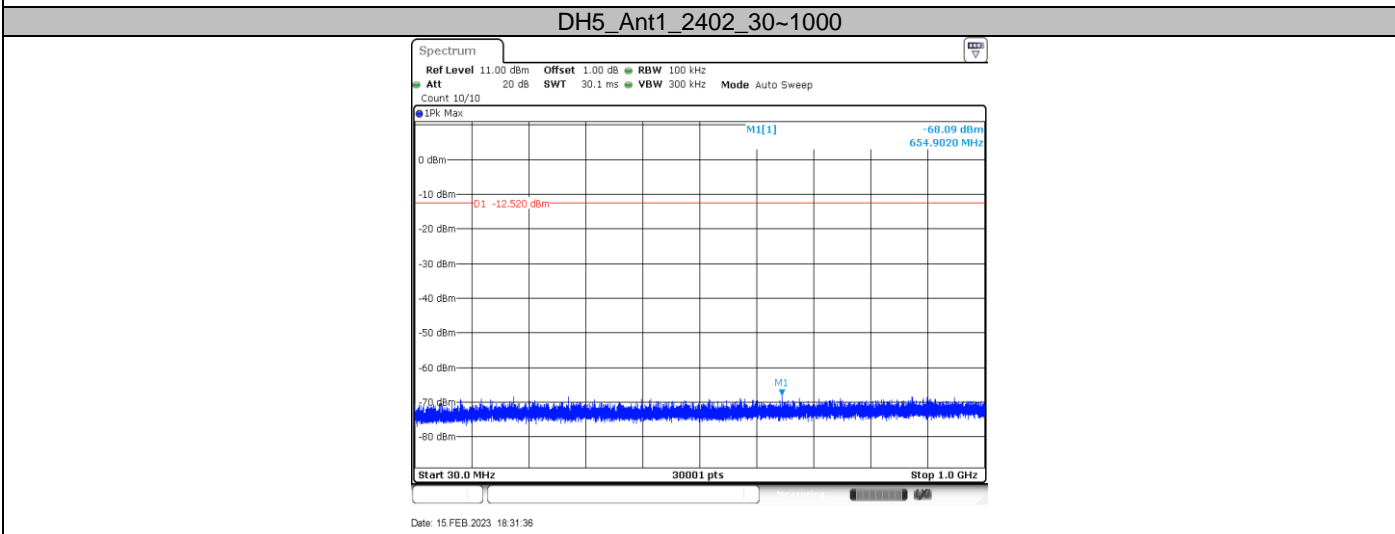
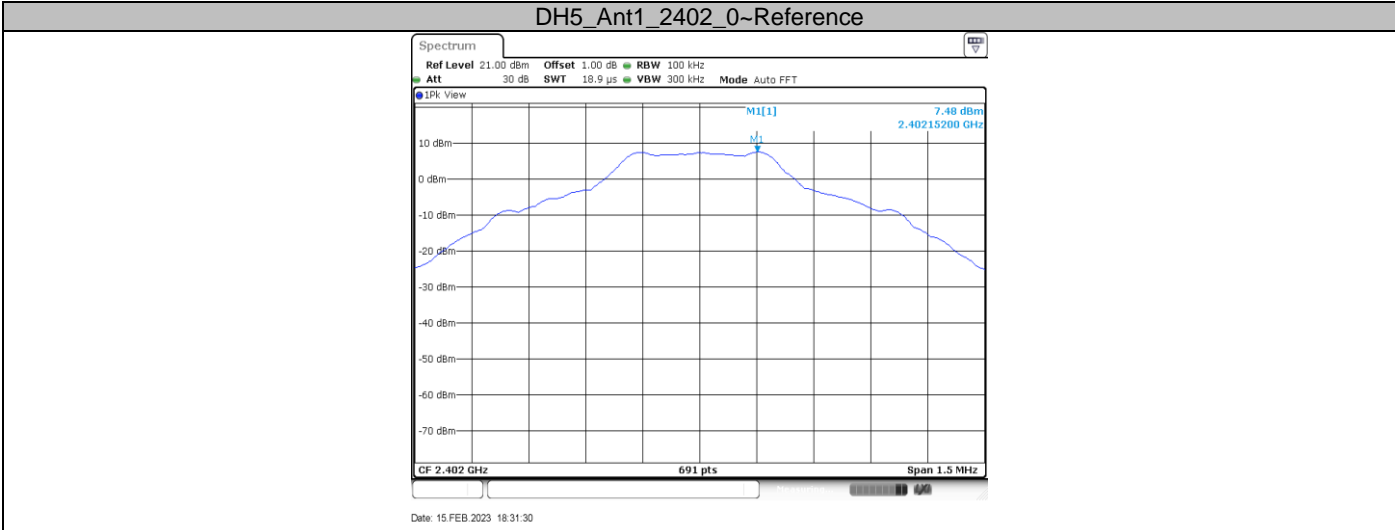

DH5_Ant1_2441_0~Reference

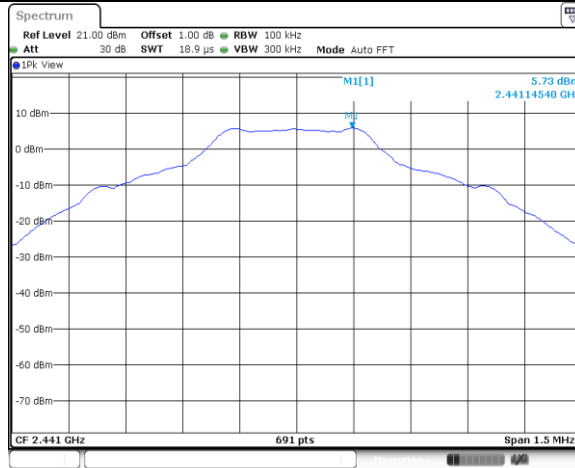

Date: 15 FEB 2023 18:33:57

DH5_Ant1_2441_30~1000

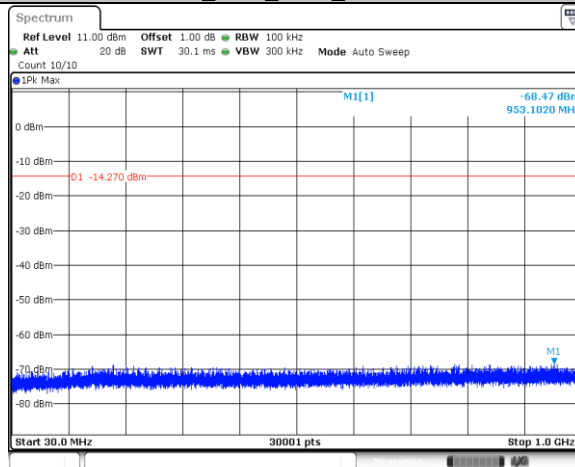

Date: 15 FEB 2023 18:34:04

DH5_Ant1_2441_1000~26500

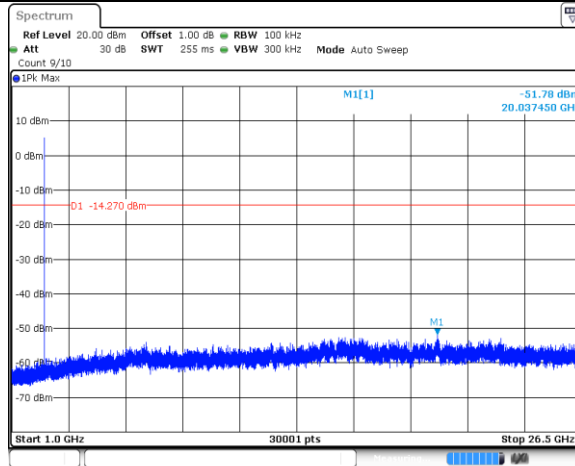

Date: 15 FEB 2023 18:34:11

DH5_Ant1_2480_0~Reference

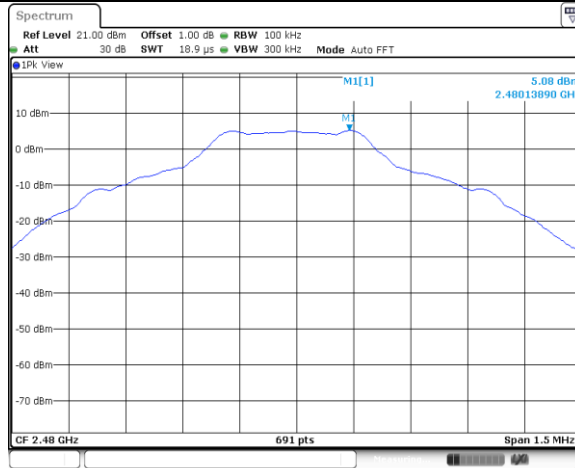

Date: 15 FEB 2023 18:35:52

DH5_Ant1_2480_30~1000

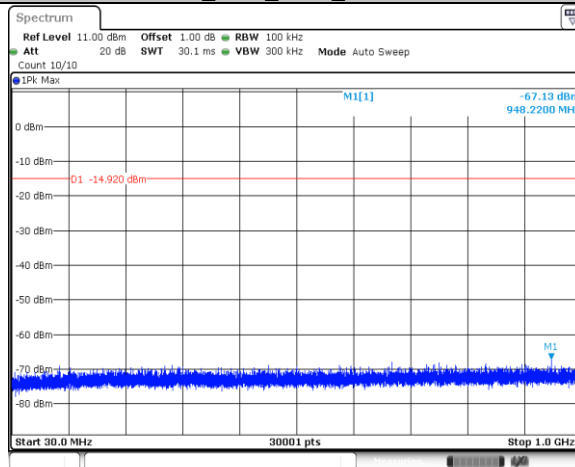

Date: 15 FEB 2023 18:35:58

DH5_Ant1_2480_1000~26500

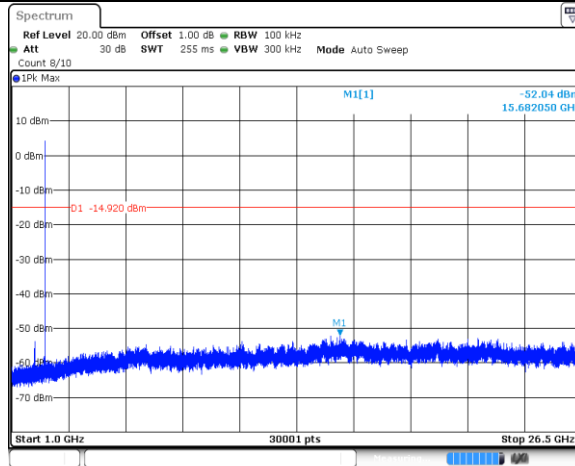

Date: 15 FEB 2023 18:36:06

2DH5_Ant1_2402_0~Reference

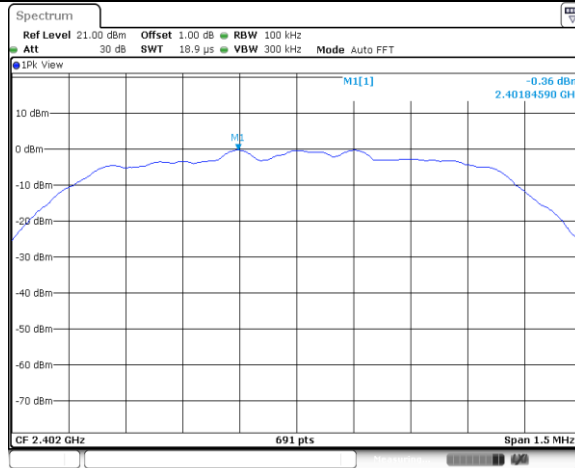

Date: 15 FEB 2023 18:37:49

2DH5_Ant1_2402_30~1000

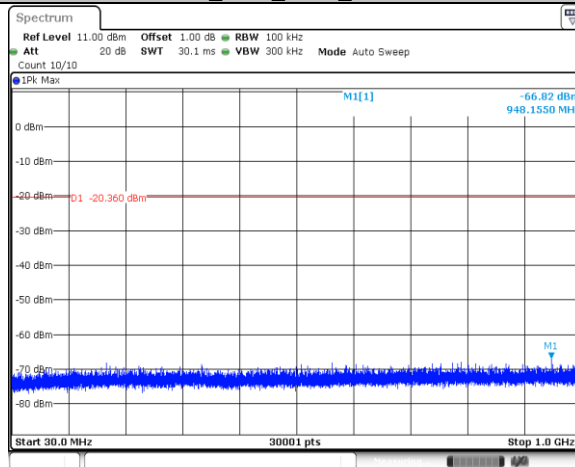

Date: 15 FEB 2023 18:37:55

2DH5_Ant1_2402_1000~26500

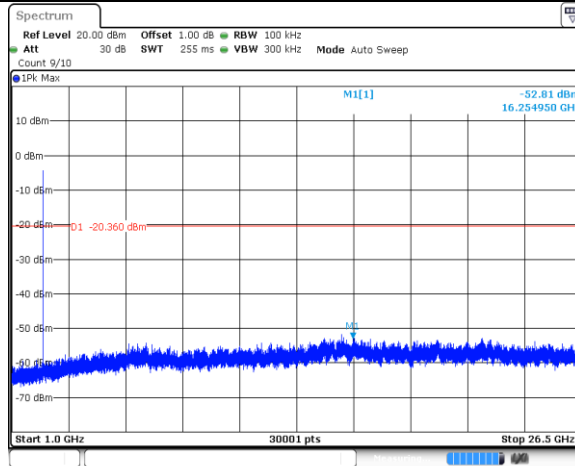

Date: 15 FEB 2023 18:38:03

2DH5_Ant1_2441_0~Reference

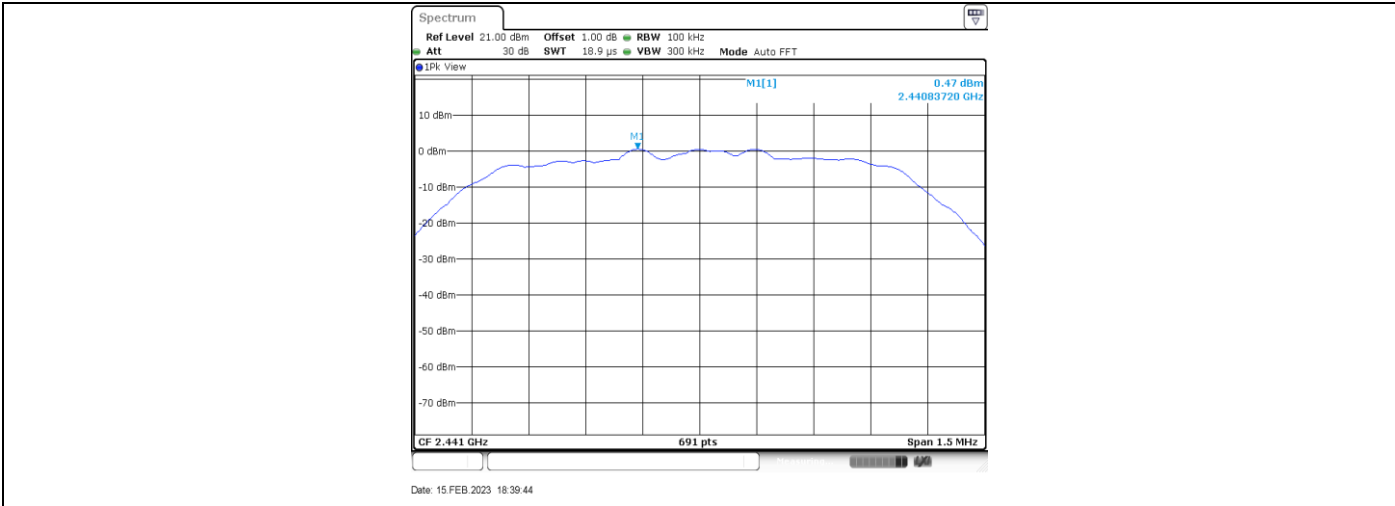

2DH5_Ant1_2441_30~1000

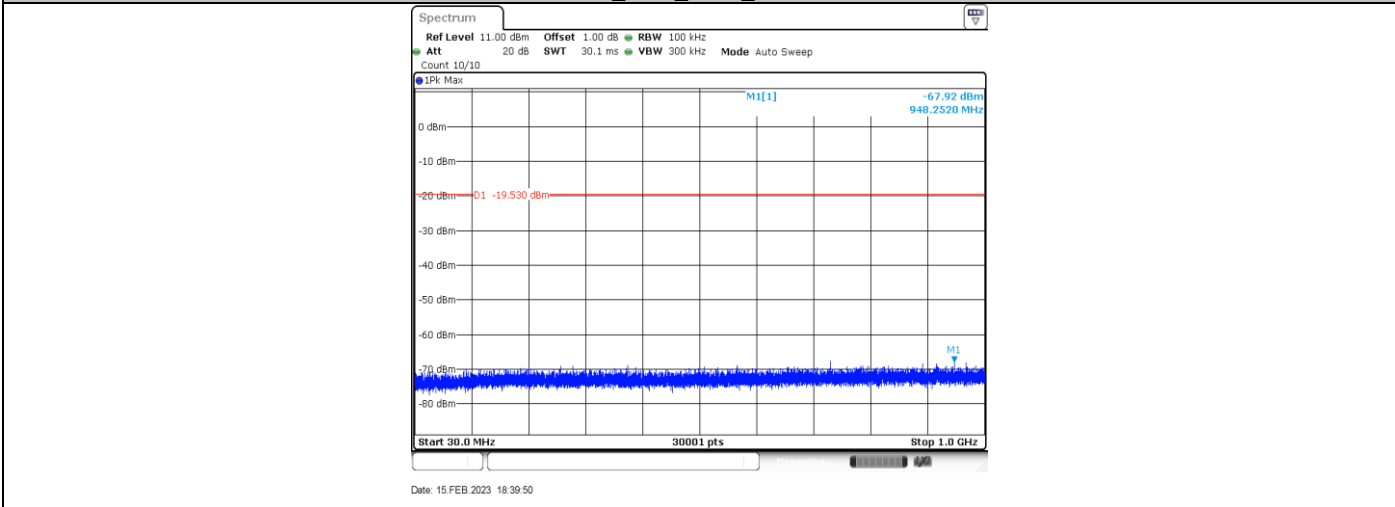

2DH5_Ant1_2441_1000~26500

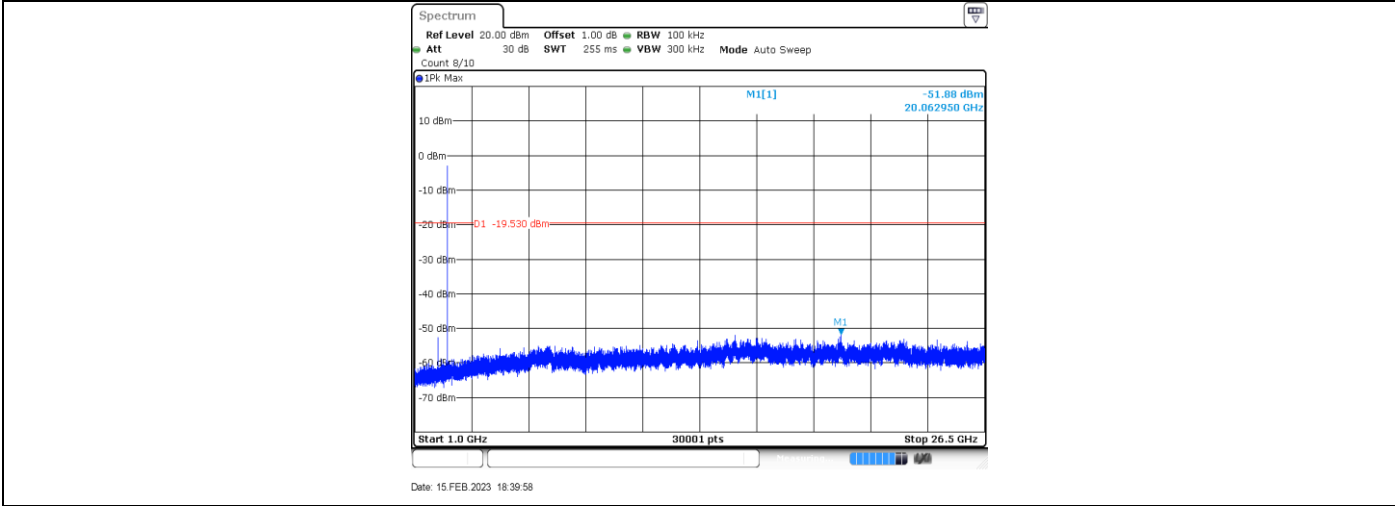

2DH5_Ant1_2480_0~Reference

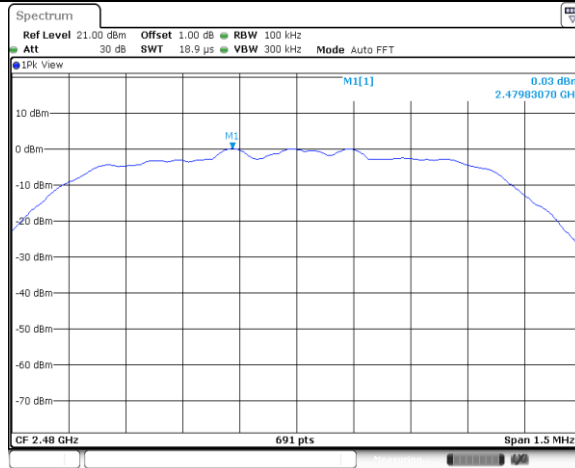

Date: 15 FEB 2023 18:41:35

2DH5_Ant1_2480_30~1000

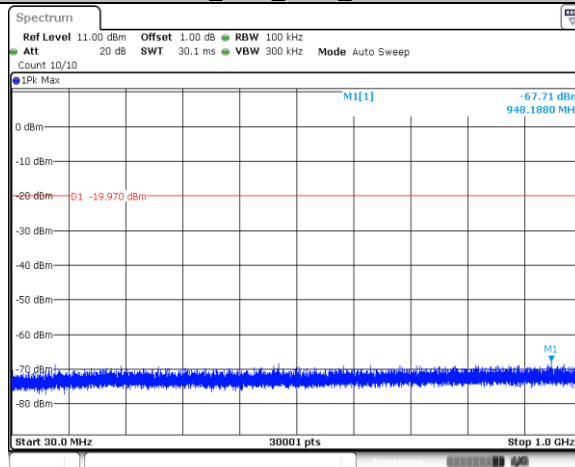

Date: 15 FEB 2023 18:41:41

2DH5_Ant1_2480_1000~26500

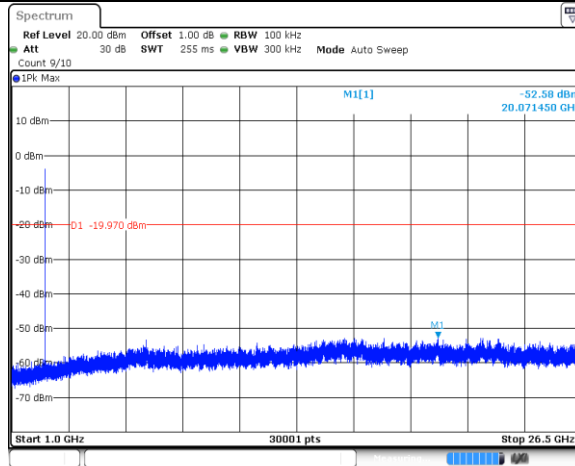

Date: 15 FEB 2023 18:41:48

3DH5_Ant1_2402_0~Reference

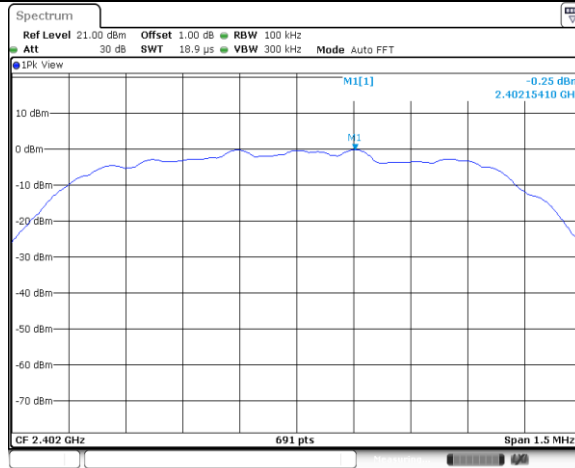

Date: 15 FEB 2023 18:44:53

3DH5_Ant1_2402_30~1000

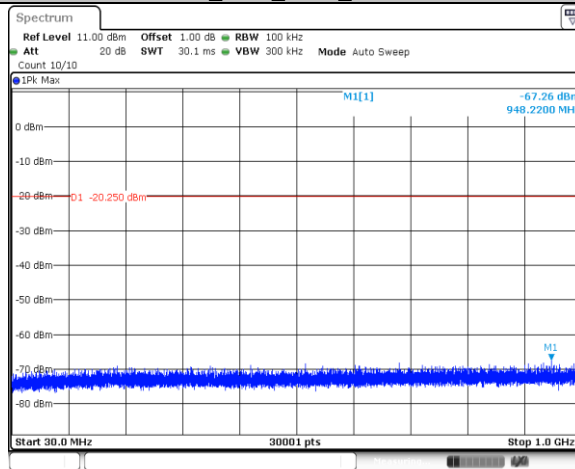

Date: 15 FEB 2023 18:44:59

3DH5_Ant1_2402_1000~26500

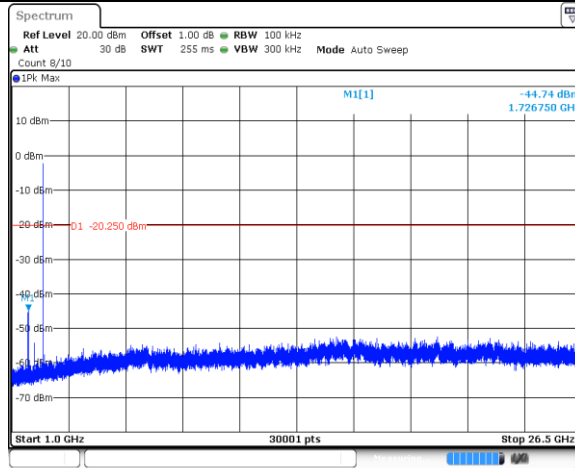

Date: 15 FEB 2023 18:45:07

3DH5_Ant1_2441_0~Reference

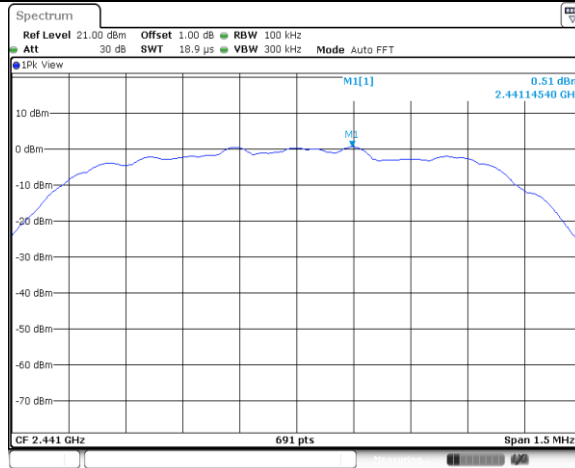

Date: 15 FEB 2023 18:46:13

3DH5_Ant1_2441_30~1000

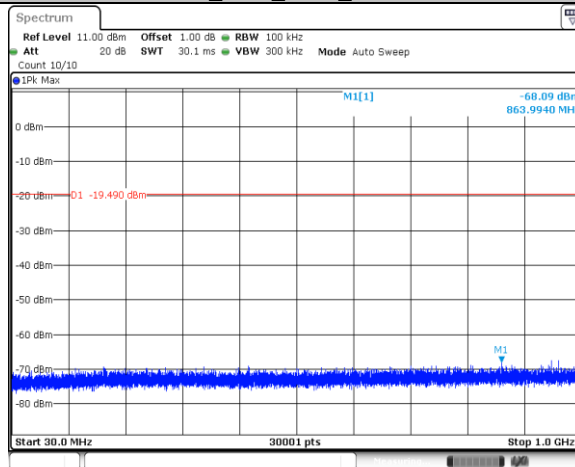

Date: 15 FEB 2023 18:46:19

3DH5_Ant1_2441_1000~26500

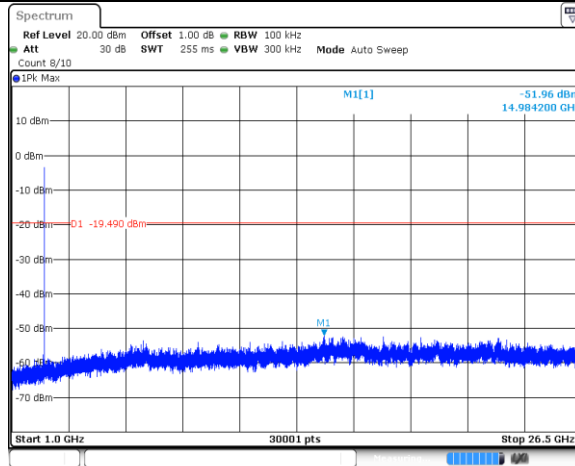

Date: 15 FEB 2023 18:46:27

3DH5_Ant1_2480_0~Reference

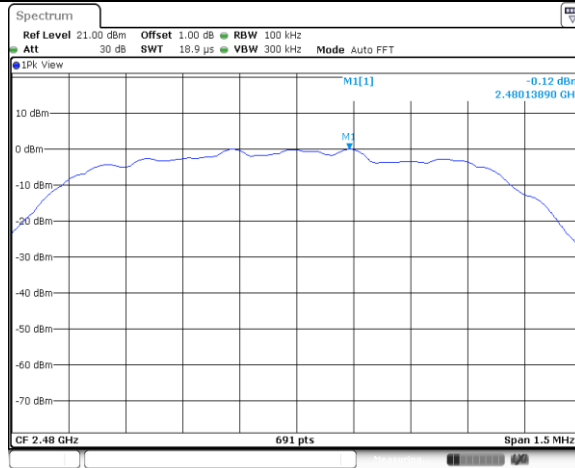

Date: 15 FEB 2023 18:47:48

3DH5_Ant1_2480_30~1000

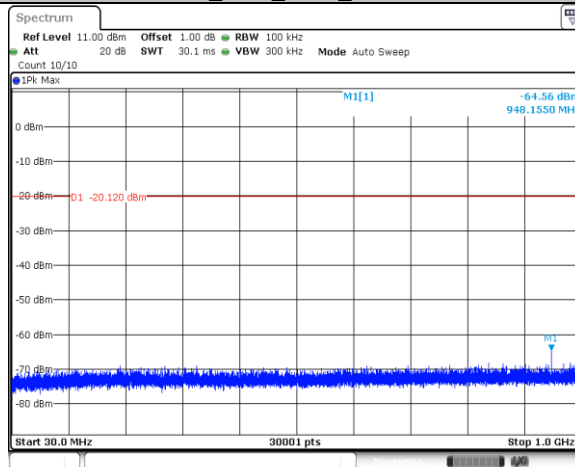

Date: 15 FEB 2023 18:47:54

3DH5_Ant1_2480_1000~26500

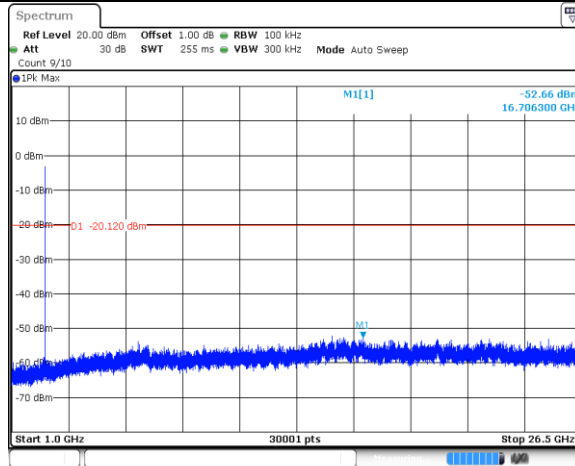

Date: 15 FEB 2023 18:48:02

9.8 Band Edge Testing

Test Method

1. The RF output of EUT was connected to the test receiver by RF cable. The path loss was compensated to the results for each measurement.
2. Set to the maximum power setting and enable the EUT transmit continuously.
3. Set RBW = 100 kHz, VBW=300 kHz, Peak Detector. Unwanted Emissions measured in any 100 kHz bandwidth outside of the authorized frequency band shall be attenuated by at least 20 dB relative to the maximum in-band peak PSD level in 100 kHz when maximum peak conducted output power procedure is used. If the transmitter complies with the conducted power limits based on the use of RMS averaging over a time interval, the attenuation required under this paragraph shall be 30 dB instead of 20 dB.
4. Measure and record the results in the test report.
5. The RF fundamental frequency should be excluded against the limit line in the operating frequency
6. Set to the maximum power setting and enable the EUT hopping mode, repeat the test.

Limit:

In any 100kHz bandwidth outside the frequency band in which the spread spectrum or digitally modulated device is operating, the RF power that is produced shall be at least 20 dB below that in the 100 kHz bandwidth within the band that contains the highest level of the desired power, based on either an RF conducted or a radiated measurement, provided that the transmitter demonstrates compliance with the peak conducted power limits.

Band Edge

Test Mode	Antenna	Channel	Channel (MHz)	Reference Level (dBm)	Result (dBm)	Limit (dBm)	Verdict
DH5	Ant0	Low	2402	7.54	-24.93	<=-12.46	PASS
		High	2480	5.23	-47.31	<=-14.77	PASS
		Low	Hop_2402	7.11	-48	-12.89	PASS
		High	Hop_2480	6.64	-47.53	-13.36	PASS
2DH5	Ant0	Low	2402	2.06	-32.46	<=-17.94	PASS
		High	2480	2.35	-47.82	<=-17.65	PASS
		Low	Hop_2402	1.91	-48.51	-18.09	PASS
		High	Hop_2480	3.27	-47.89	-16.73	PASS
3DH5	Ant0	Low	2402	2.50	-32.47	<=-17.5	PASS
		High	2480	2.54	-47.84	<=-17.46	PASS
		Low	Hop_2402	2.14	-47.76	-17.86	PASS
		High	Hop_2480	3.58	-47.66	-16.42	PASS

DH5_Ant1_Low_2402

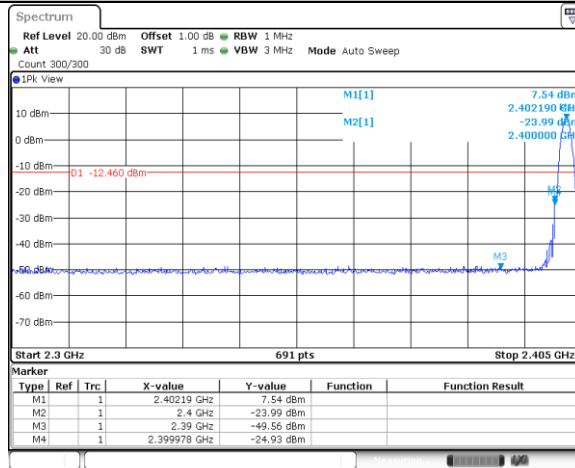

Date: 15.FEB.2023 18:31:24

DH5_Ant1_High_2480

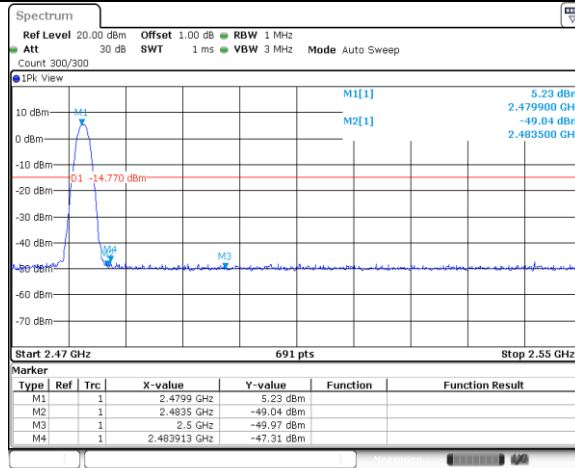

Date: 15.FEB.2023 18:35:47

DH5_Ant1_Low_Hop_2402

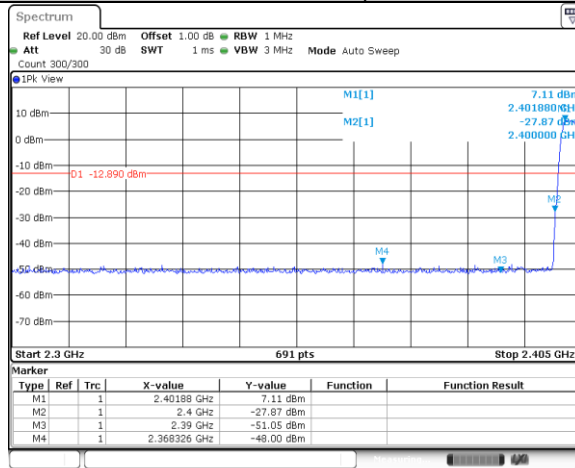

Date: 15.FEB.2023 19:01:25

DH5_Ant1_High_Hop_2480

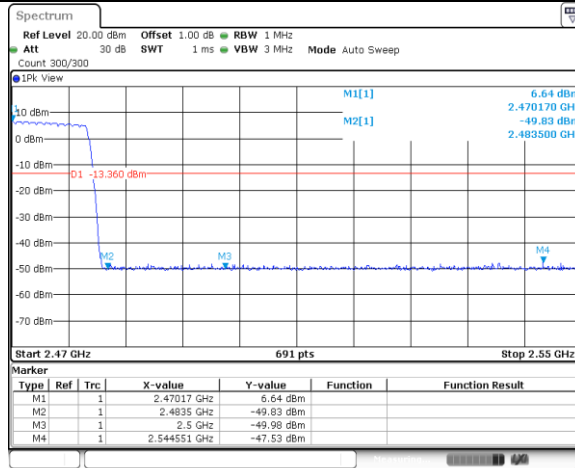

Date: 15 FEB 2023 19:02:36

2DH5_Ant1_Low_2402

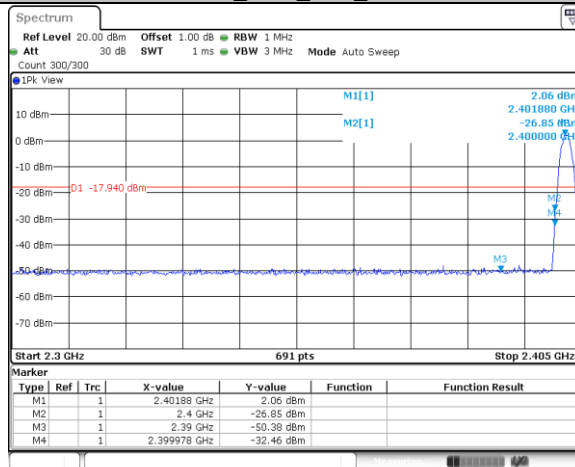

Date: 15 FEB 2023 18:37:43

2DH5_Ant1_High_2480

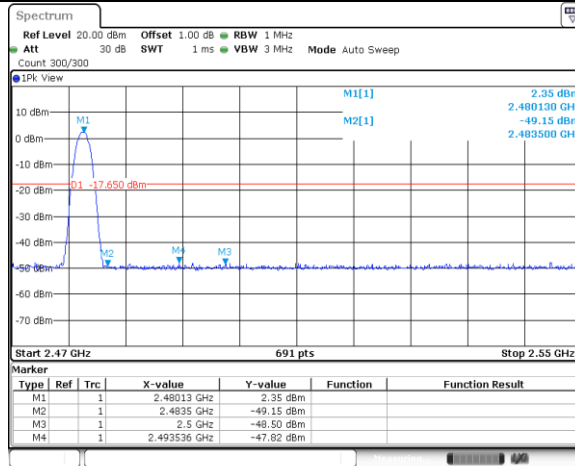

Date: 15 FEB 2023 18:41:29

2DH5_Ant1_Low_Hop_2402

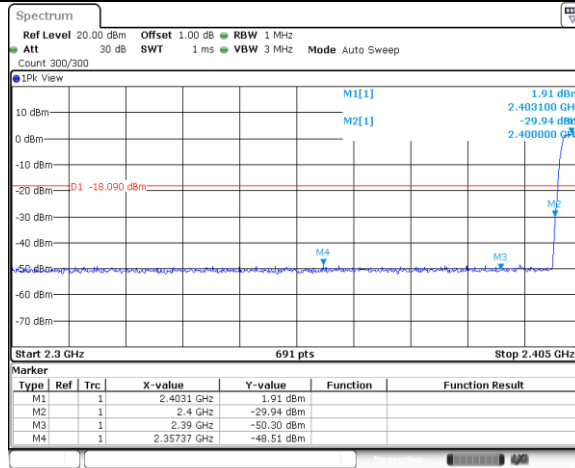

Date: 15 FEB 2023 19:03:28

2DH5_Ant1_High_Hop_2480

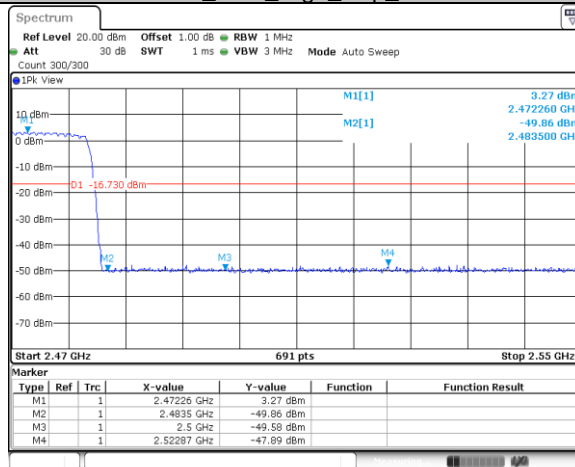

Date: 15 FEB 2023 19:04:54

3DH5_Ant1_Low_2402

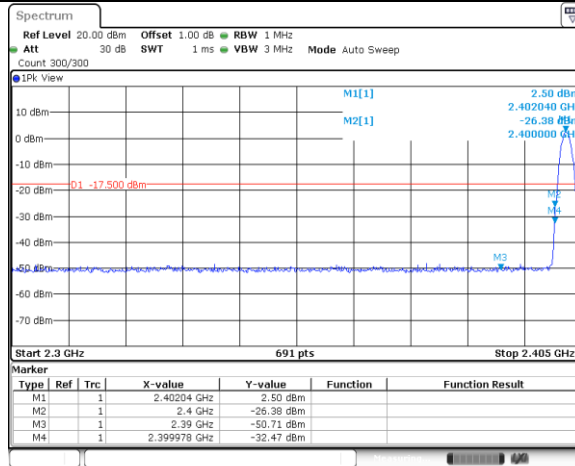

Date: 15 FEB 2023 18:44:47

3DH5_Ant1_High_2480

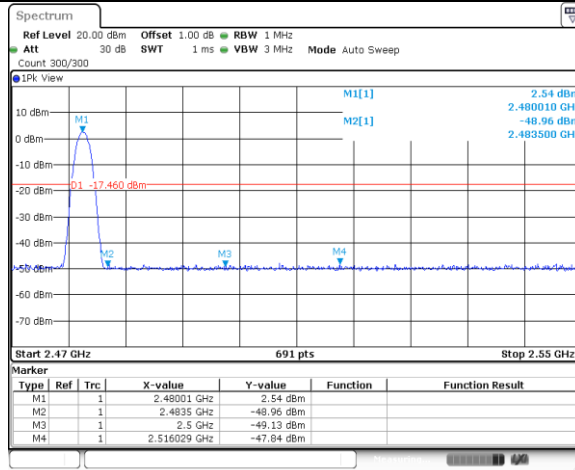

Date: 15 FEB 2023 18:47:42

3DH5_Ant1_Low_Hop_2402

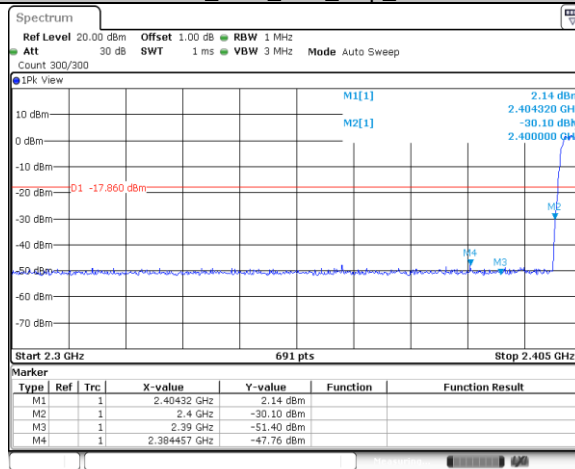

Date: 15 FEB 2023 19:06:21

3DH5_Ant1_High_Hop_2480

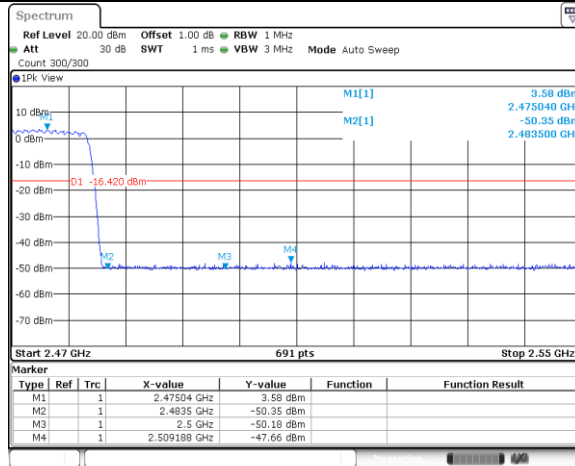

Date: 15 FEB 2023 19:07:40

9.9 Spurious Radiated Emissions for Transmitter

Test Method

1. The EUT was placed on a turn table which is 1.5m above ground plane for above 1GHz and 0.8m above ground for below 1GHz at 3 meters chamber room for test. The table was rotated 360 degrees to determine the position of the highest radiation.
2. Set to the maximum power setting and enable the EUT transmit continuously
3. The EUT was set 3 meters away from the interference – receiving antenna, which was mounted on the top of a variable – height antenna tower.
4. The height of antenna is varied from one meter to four meters above the ground to determine the maximum value of the field strength. Both horizontal and vertical polarizations of the antenna are set to make the measurement.
5. For each suspected emission, the EUT was arranged to its worst case and then the antenna was tuned to heights from 1 meter to 4 meters and the rotatable table was turned from 0 degrees to 360 degrees to find the maximum reading.
6. Use the following test receiver settings According to C63.10:
 - (1) Span shall wide enough to fully capture the emission being measured;
 - (2) Set RBW=100 kHz to 120KHz for $f < 1$ GHz; VBW RBW; Sweep = auto; Detector function = QP; Trace = max hold;
 - (3) Set RBW = 1 MHz, VBW= 3MHz for $f \geq 1$ GHz for peak measurement.

For average measurement:

The resolution bandwidth of test receiver/spectrum analyzer is 1MHz and the video bandwidth is 3MHz for RMS Average ((duty cycle < 98%) for Average detection (AV) at frequency above 1GHz, then the measurement results was added to a correction factor ($20\log(1/\text{duty cycle})$).

The resolution bandwidth of test receiver/spectrum analyzer is 1MHz and the video bandwidth is 10Hz (duty cycle > 98%) for Average detection (AV) at frequency above 1GHz.

7. Repeat above procedures until all frequencies measured were complete.

Spurious Radiated Emissions for Transmitter

Limit

The radio emission outside the operating frequency band shall be at least 20 dB below that in the 100 kHz bandwidth within the band that contains the highest level of the desired power. Radiated emissions which fall in the restricted bands, as defined in section 15.205 & RSS-GEN 8.10, must comply with the radiated emission limits specified in section 15.209 & RSS-Gen 6.13.

Frequency MHz	Field Strength $\mu\text{V/m}$	Field Strength $\text{dB}\mu\text{V/m}$	Detector	Measurement distance meters
0.009-0.490	2400/F(kHz)	48.5-13.8	AV	300
0.490-1.705	24000/F(kHz)	33.8-23.0	QP	30
1.705-30	30	29.5	QP	30
30-88	100	40	QP	3
88-216	150	43.5	QP	3
216-960	200	46	QP	3
960-1000	500	54	QP	3
Above 1000	500	54	AV	3
Above 1000	5000	74	PK	3

Note 1: $\text{Limit } 3\text{m}(\text{dB}\mu\text{V/m}) = \text{Limit } 300\text{m}(\text{dB}\mu\text{V/m}) + 40\text{Log}(300\text{m}/3\text{m})$ (Below 30MHz)

Note 2: $\text{Limit } 3\text{m}(\text{dB}\mu\text{V/m}) = \text{Limit } 30\text{m}(\text{dB}\mu\text{V/m}) + 40\text{Log}(30\text{m}/3\text{m})$ (Below 30MHz)

Spurious radiated emissions for transmitter

According to C63.10, if the peak (or quasi-peak) measured value complies with the average limit, it is unnecessary to perform an average measurement, so AV emission value did not show in below table if the peak value complies with average limit.

Transmitting spurious emission test result as below:

Test data_30MHz to 1000MHz

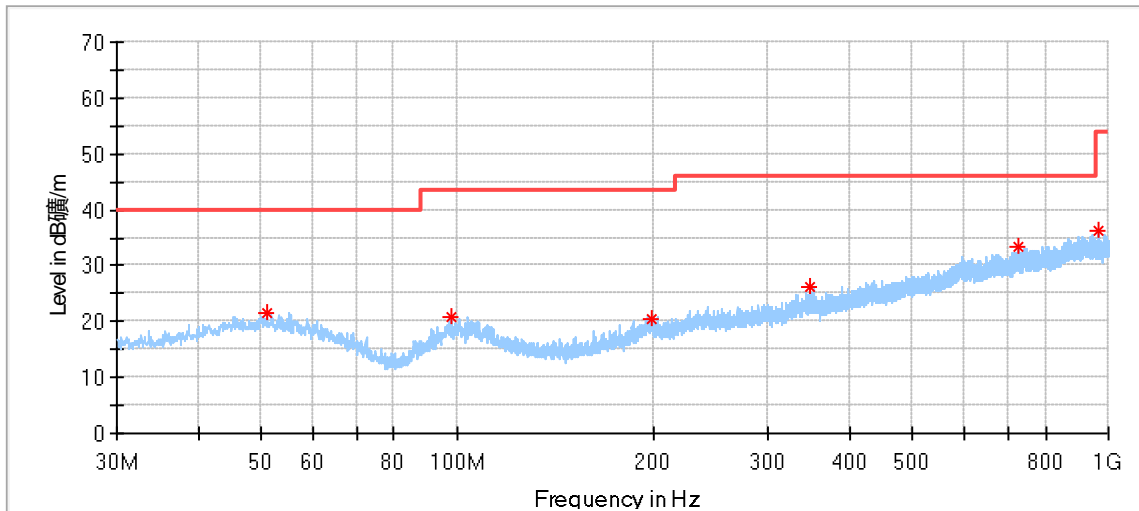

Frequency (MHz)	MaxPeak (dBμV/m)	Limit (dBμV/m)	Margin (dB)	Height (cm)	Pol	Azimuth (deg)	Corr. (dB/m)
51.070556	21.57	40.00	18.43	100.0	H	157.0	20.62
97.900000	20.86	43.50	22.64	200.0	H	0.0	18.48
198.887778	20.58	43.50	22.92	200.0	H	175.0	19.05
347.944444	26.10	46.00	19.91	100.0	H	138.0	22.97
725.490000	33.54	46.00	12.46	200.0	H	267.0	28.95
965.241667	36.13	54.00	17.87	200.0	H	258.0	31.68

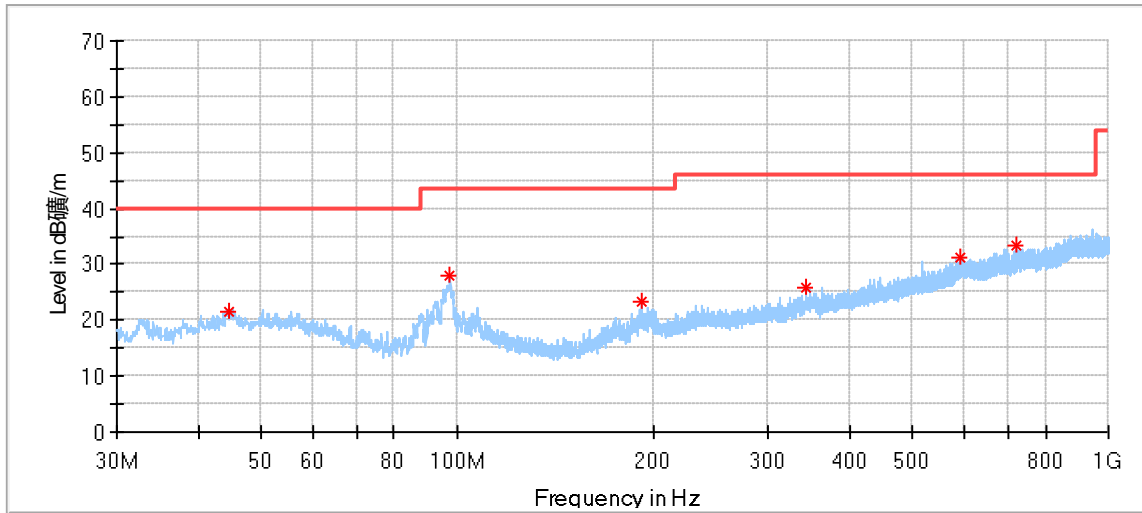

Frequency (MHz)	MaxPeak (dBµV/m)	Limit (dBµV/m)	Margin (dB)	Height (cm)	Pol	Azimuth (deg)	Corr. (dB/m)
44.496111	21.38	40.00	18.62	100.0	V	260.0	20.06
97.522778	27.91	43.50	15.59	100.0	V	356.0	18.40
191.936111	23.30	43.50	20.20	100.0	V	145.0	18.21
343.471667	25.85	46.00	20.15	100.0	V	102.0	22.68
591.145000	31.25	46.00	14.75	100.0	V	352.0	27.65

Test data 1GHz to 18GHz:
DH5_Low Channel:

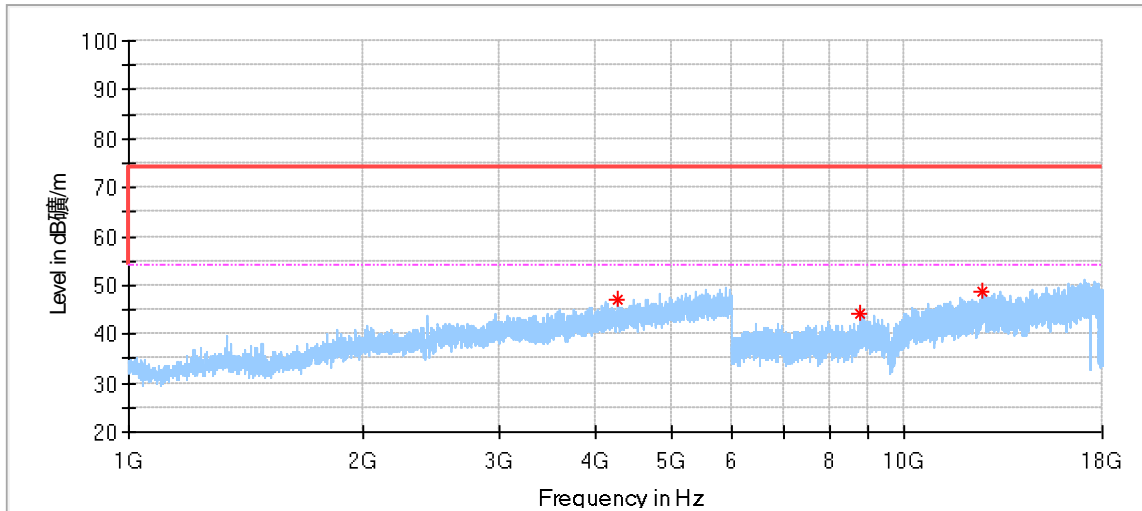

Frequency (MHz)	MaxPeak (dBµV/m)	Limit (dBµV/m)	Margin (dB)	Height (cm)	Pol	Azimuth (deg)	Corr. (dB/m)
4269.500000	47.18	74.00	26.82	150.0	H	25.0	2.28
8781.500000	44.08	74.00	29.92	150.0	H	144.0	12.76
12601.500000*	48.59	74.00	25.41	150.0	H	198.0	18.22

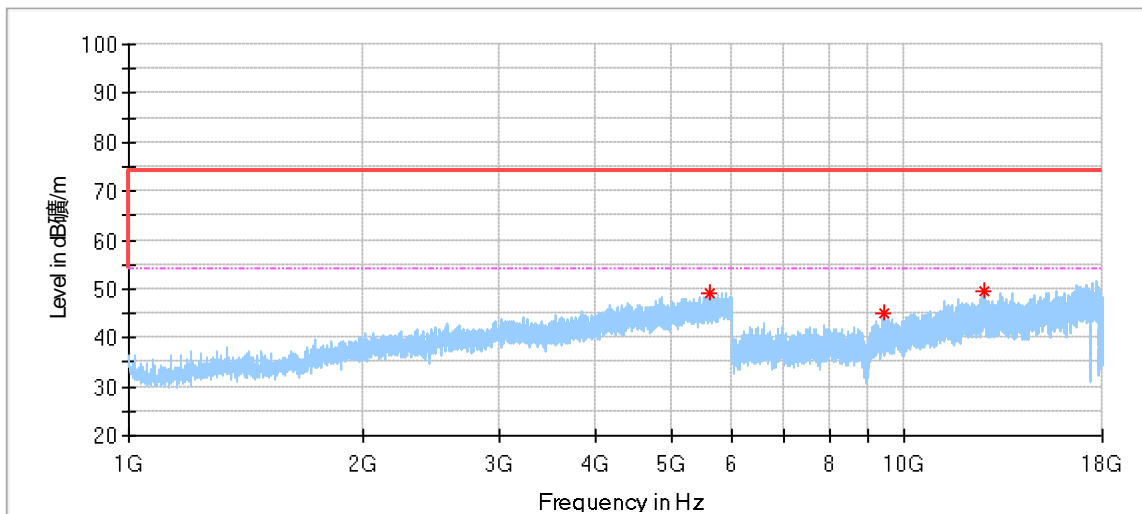

Frequency (MHz)	MaxPeak (dBµV/m)	Limit (dBµV/m)	Margin (dB)	Height (cm)	Pol	Azimuth (deg)	Corr. (dB/m)
5602.500000	49.08	74.00	24.92	150.0	V	221.0	5.68
9437.500000*	45.10	74.00	28.90	150.0	V	88.0	13.76
12649.000000*	49.42	74.00	24.58	150.0	V	353.0	18.63

DH5_Middle Channel:

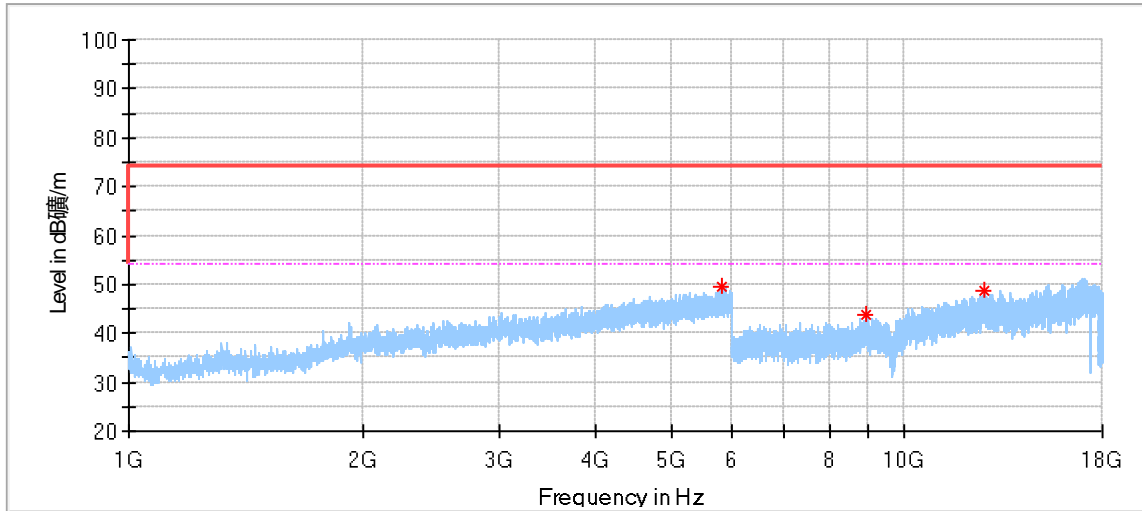

Frequency (MHz)	MaxPeak (dBµV/m)	Limit (dBµV/m)	Margin (dB)	Height (cm)	Pol	Azimuth (deg)	Corr. (dB/m)
5825.000000	49.52	74.00	24.48	150.0	H	319.0	6.10
8942.000000	43.92	74.00	30.08	150.0	H	277.0	13.08
12689.500000*	48.88	74.00	25.12	150.0	H	60.0	18.08

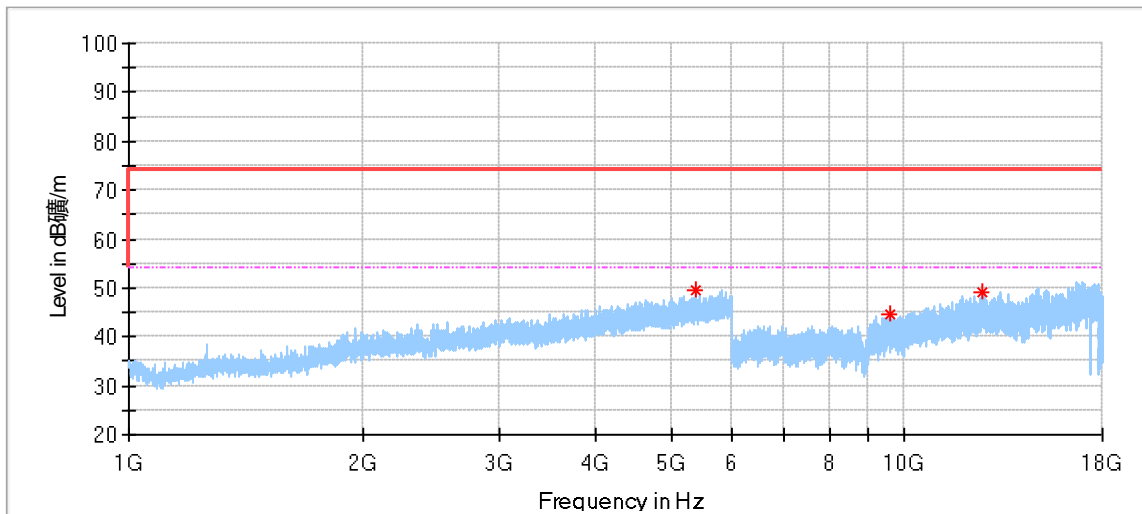

Frequency (MHz)	MaxPeak (dBµV/m)	Limit (dBµV/m)	Margin (dB)	Height (cm)	Pol	Azimuth (deg)	Corr. (dB/m)
5374.000000*	49.73	74.00	24.27	150.0	V	159.0	5.32
9555.000000	44.59	74.00	29.41	150.0	V	172.0	13.25
12593.000000*	49.05	74.00	24.95	150.0	V	305.0	18.13

DH5_Hight Channel:

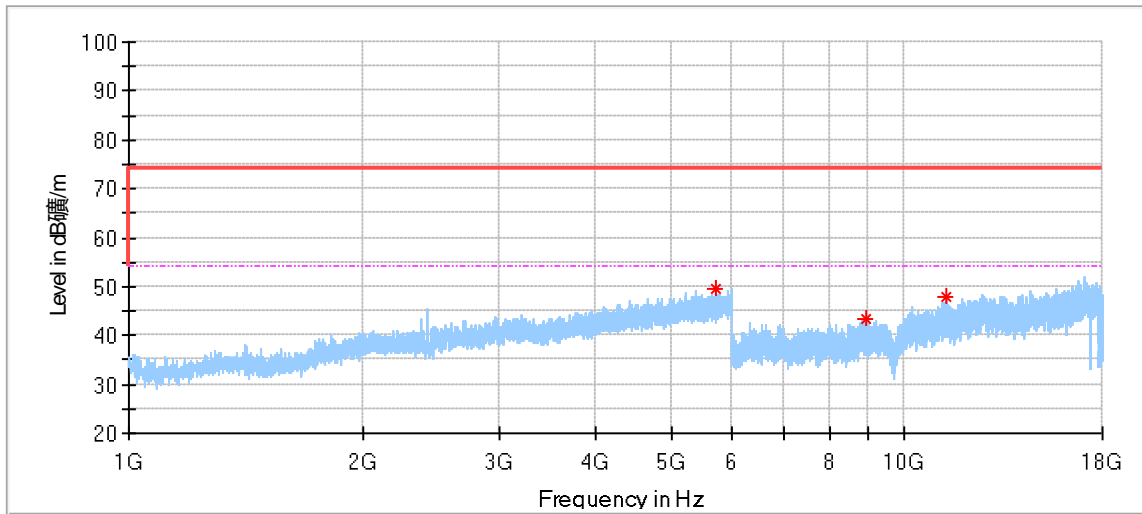

Frequency (MHz)	MaxPeak (dBµV/m)	Limit (dBµV/m)	Margin (dB)	Height (cm)	Pol	Azimuth (deg)	Corr. (dB/m)
5711.500000	49.38	74.00	24.62	150.0	H	0.0	5.74
8898.000000	43.31	74.00	30.69	150.0	H	282.0	13.18
11330.500000*	48.09	74.00	25.91	150.0	H	255.0	15.83

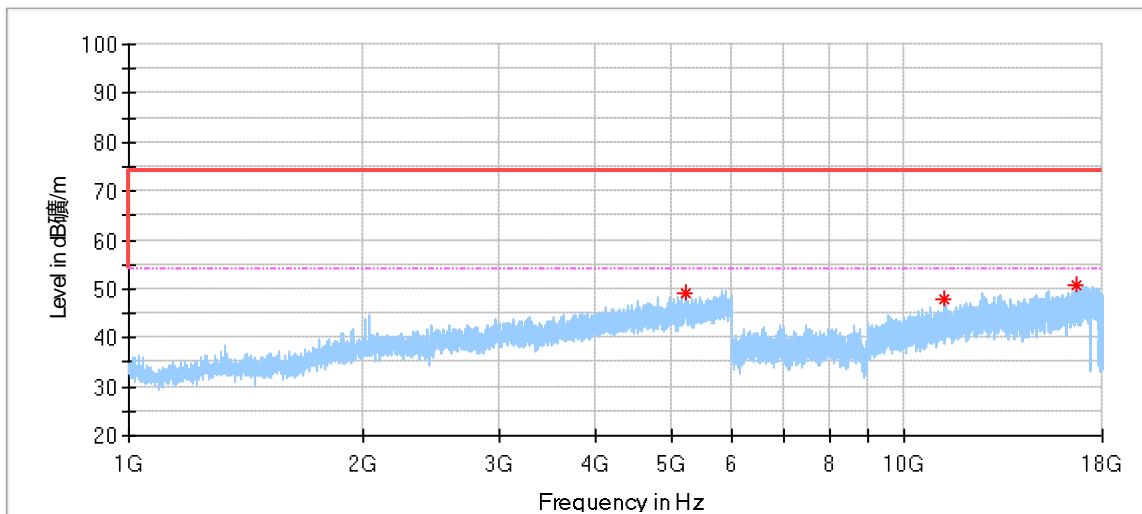

Frequency (MHz)	MaxPeak (dBµV/m)	Limit (dBµV/m)	Margin (dB)	Height (cm)	Pol	Azimuth (deg)	Corr. (dB/m)
5237.000000	49.01	74.00	24.99	150.0	V	57.0	5.42
11262.500000*	47.79	74.00	26.21	150.0	V	116.0	15.64
16625.000000	50.60	74.00	23.40	150.0	V	251.0	22.95

2DH5_Low Channel:

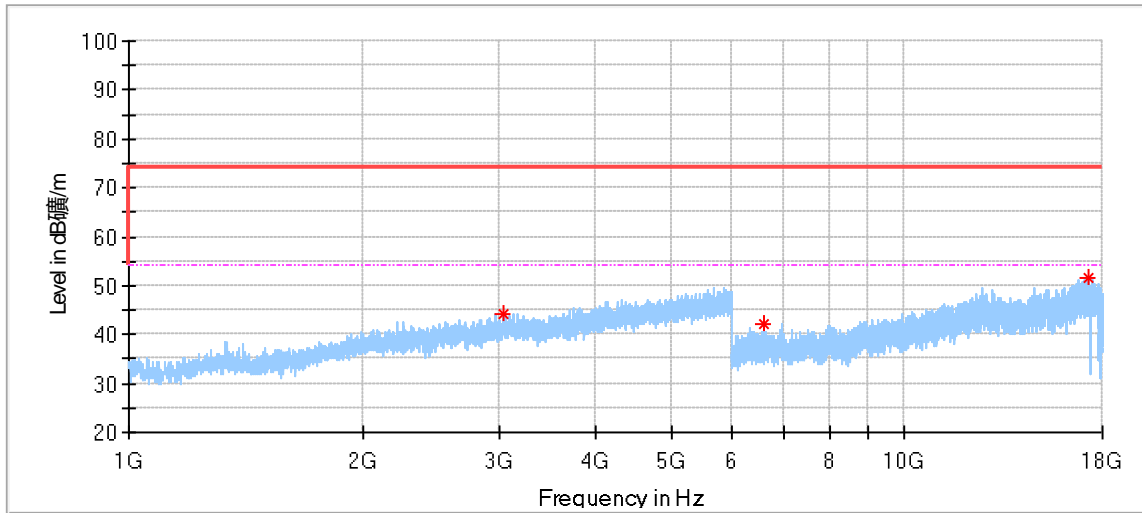

Frequency (MHz)	MaxPeak (dBµV/m)	Limit (dBµV/m)	Margin (dB)	Height (cm)	Pol	Azimuth (deg)	Corr. (dB/m)
3033.000000	44.06	74.00	29.94	150.0	H	11.0	-0.52
6596.500000	42.04	74.00	31.96	150.0	H	4.0	9.70
17276.000000	51.45	74.00	22.55	150.0	H	225.0	23.99

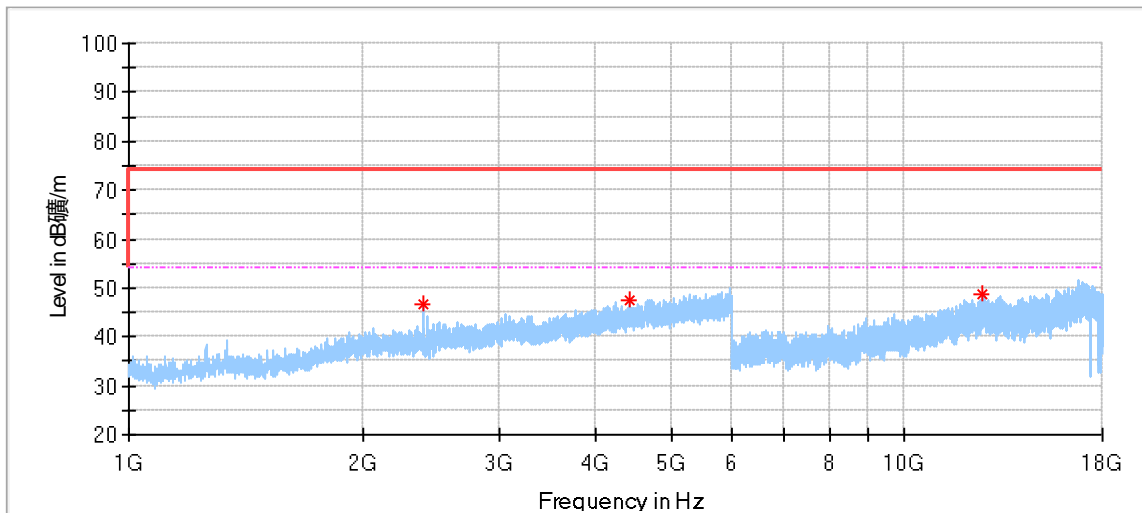

Frequency (MHz)	MaxPeak (dBµV/m)	Limit (dBµV/m)	Margin (dB)	Height (cm)	Pol	Azimuth (deg)	Corr. (dB/m)
2402.000000	46.63	74.00	27.37	150.0	V	337.0	-2.73
4418.500000	47.30	74.00	26.70	150.0	V	351.0	2.96
12634.500000*	48.90	74.00	25.10	150.0	V	341.0	18.55

2DH5_Middle Channel:

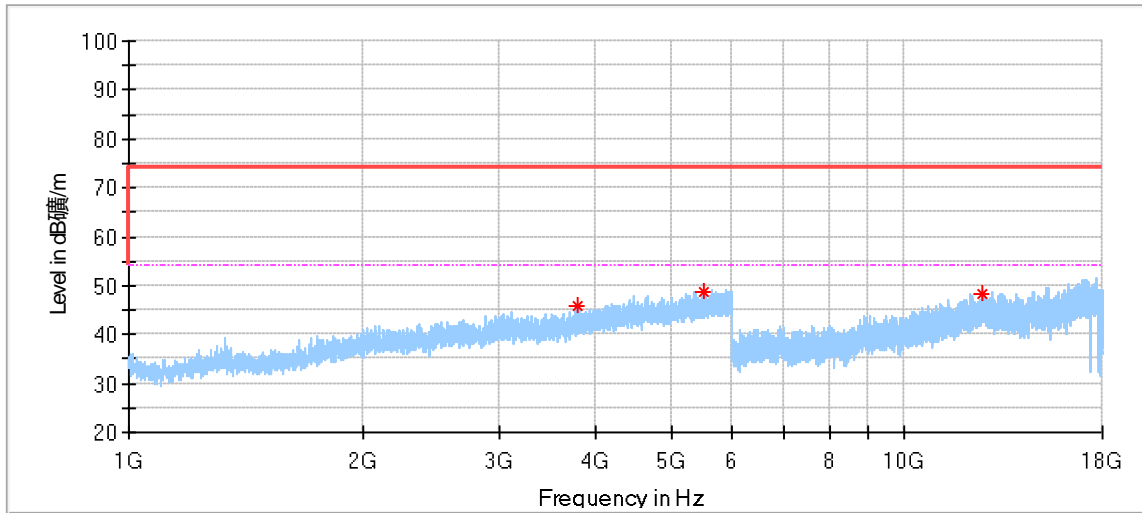

Frequency (MHz)	MaxPeak (dBµV/m)	Limit (dBµV/m)	Margin (dB)	Height (cm)	Pol	Azimuth (deg)	Corr. (dB/m)
3787.500000*	45.83	74.00	28.17	150.0	H	291.0	0.85
5517.000000	48.61	74.00	25.39	150.0	H	337.0	5.67
12635.000000*	48.42	74.00	25.58	150.0	H	4.0	18.56

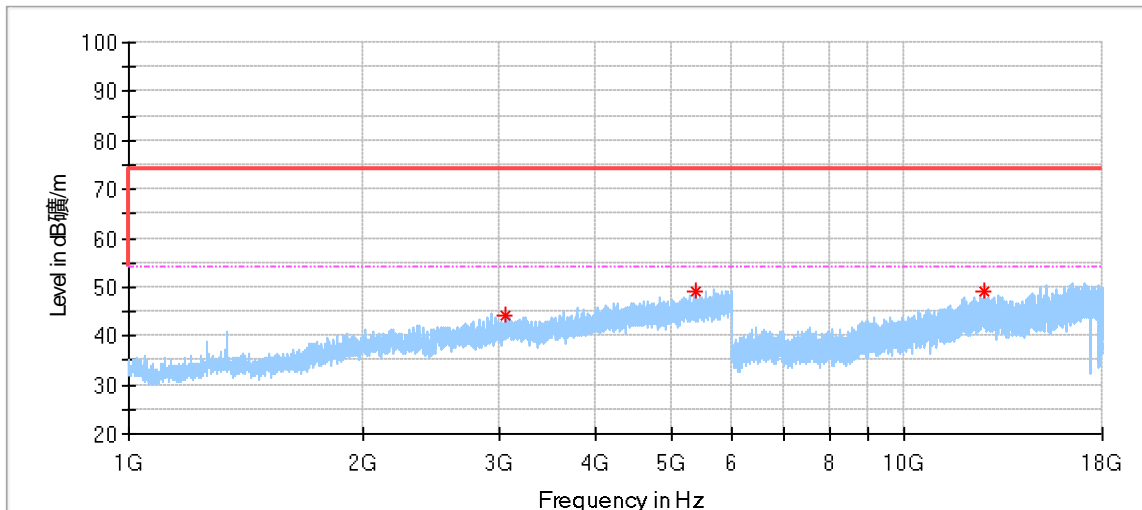

Frequency (MHz)	MaxPeak (dBµV/m)	Limit (dBµV/m)	Margin (dB)	Height (cm)	Pol	Azimuth (deg)	Corr. (dB/m)
3054.500000	44.18	74.00	29.82	150.0	V	291.0	-0.41
5367.500000*	49.00	74.00	25.00	150.0	V	236.0	5.29
12674.500000*	49.00	74.00	25.00	150.0	V	131.0	18.28

2DH5_Hight Channel:

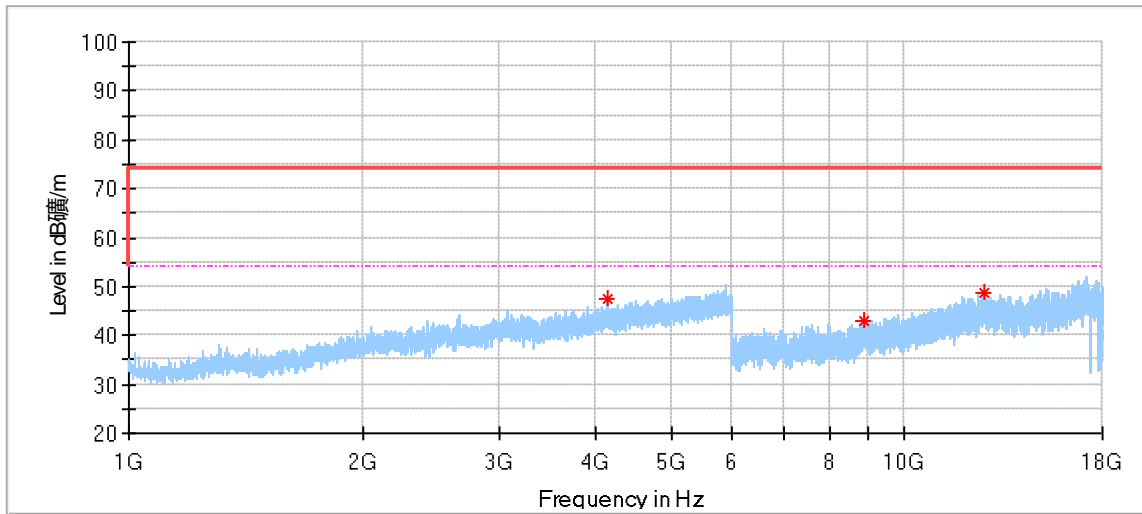

Frequency (MHz)	MaxPeak (dBµV/m)	Limit (dBµV/m)	Margin (dB)	Height (cm)	Pol	Azimuth (deg)	Corr. (dB/m)
4149.500000	47.49	74.00	26.51	150.0	H	220.0	2.10
8862.500000	42.93	74.00	31.07	150.0	H	357.0	13.20
12644.000000*	48.82	74.00	25.18	150.0	H	249.0	18.65

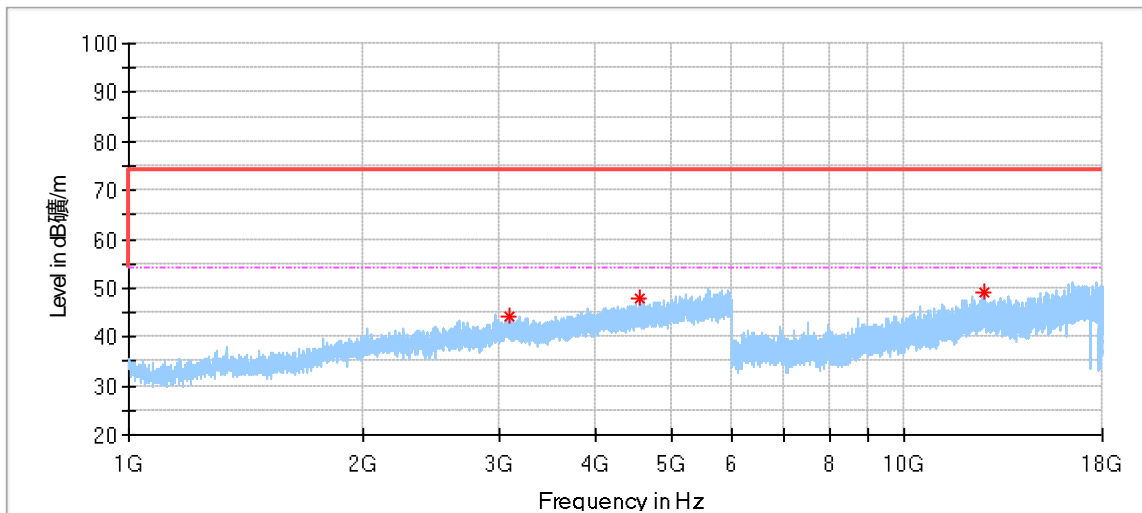

Frequency (MHz)	MaxPeak (dBµV/m)	Limit (dBµV/m)	Margin (dB)	Height (cm)	Pol	Azimuth (deg)	Corr. (dB/m)
3101.500000	44.38	74.00	29.62	150.0	V	211.0	-0.67
4551.500000*	47.94	74.00	26.06	150.0	V	141.0	3.00
12691.000000*	49.30	74.00	24.70	150.0	V	338.0	18.06

3DH5_Low Channel:

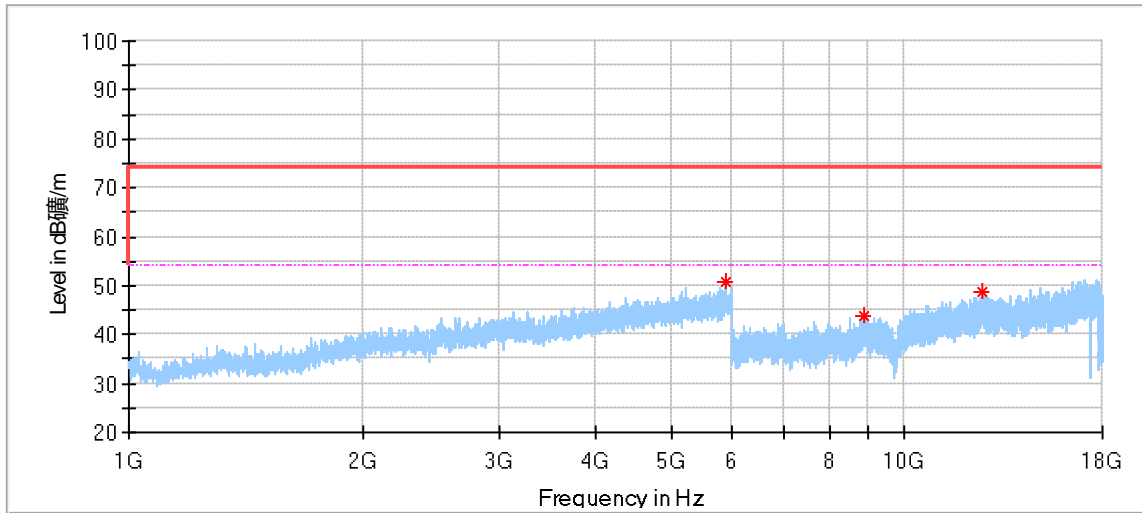

Frequency (MHz)	MaxPeak (dBµV/m)	Limit (dBµV/m)	Margin (dB)	Height (cm)	Pol	Azimuth (deg)	Corr. (dB/m)
5869.500000	50.60	74.00	23.40	150.0	H	43.0	6.29
8862.000000	43.78	74.00	30.22	150.0	H	175.0	13.20
12632.000000*	48.57	74.00	25.43	150.0	H	203.0	18.53

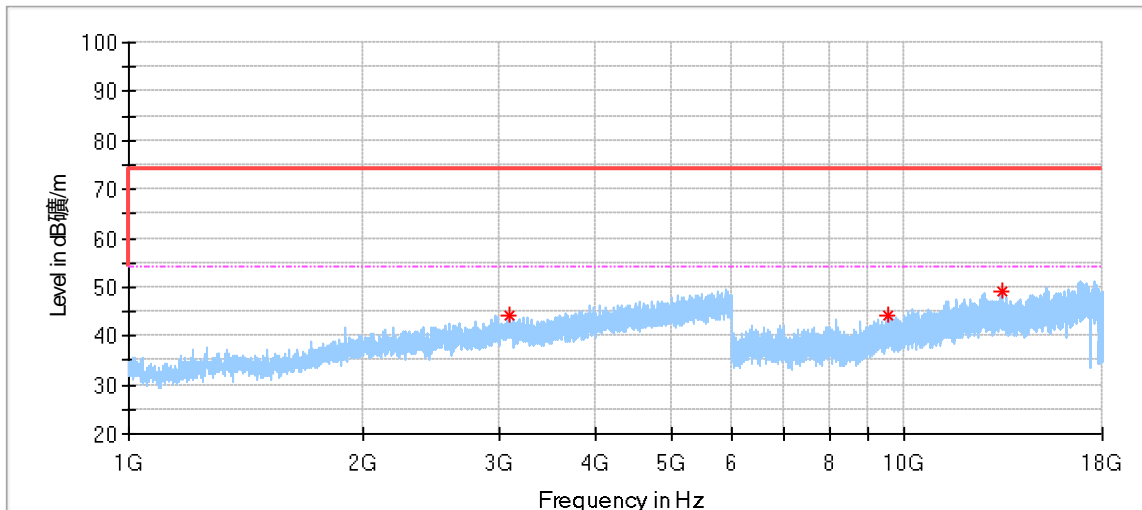

Frequency (MHz)	MaxPeak (dBµV/m)	Limit (dBµV/m)	Margin (dB)	Height (cm)	Pol	Azimuth (deg)	Corr. (dB/m)
3100.500000	44.15	74.00	29.85	150.0	V	105.0	-0.67
9527.000000	44.05	74.00	29.95	150.0	V	255.0	13.54
13365.500000*	48.97	74.00	25.03	150.0	V	255.0	17.61

3DH5_Middle Channel:

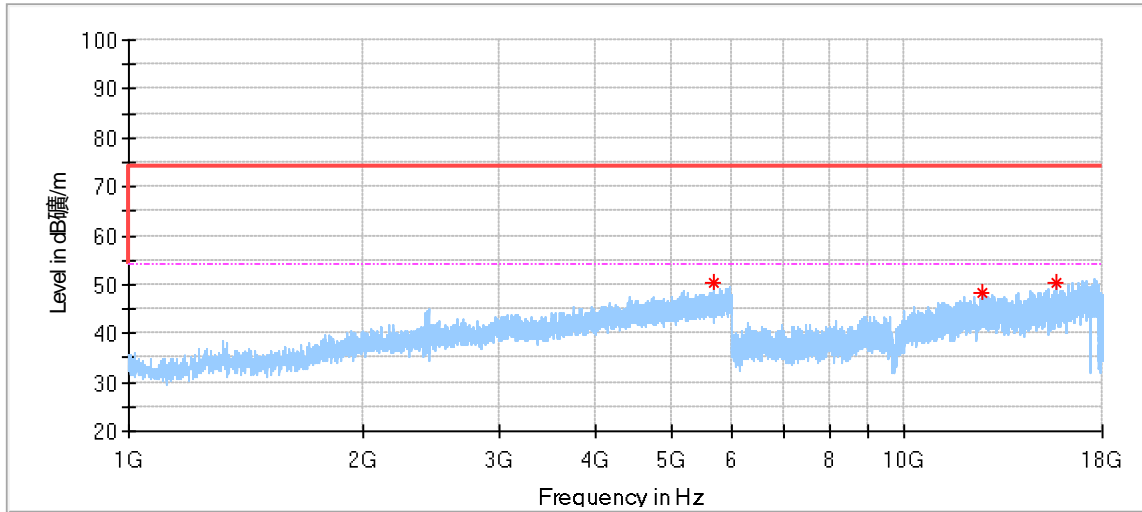

Frequency (MHz)	MaxPeak (dBµV/m)	Limit (dBµV/m)	Margin (dB)	Height (cm)	Pol	Azimuth (deg)	Corr. (dB/m)
5667.000000	50.39	74.00	23.61	150.0	H	351.0	5.48
12612.500000*	48.44	74.00	25.56	150.0	H	355.0	18.33
15654.000000*	50.24	74.00	23.76	150.0	H	119.0	19.57

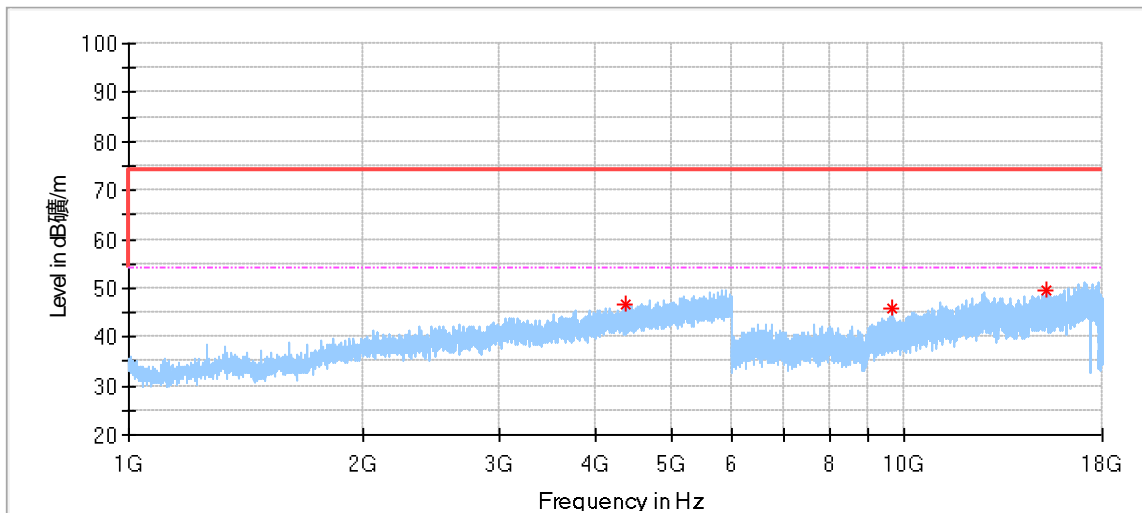

Frequency (MHz)	MaxPeak (dBµV/m)	Limit (dBµV/m)	Margin (dB)	Height (cm)	Pol	Azimuth (deg)	Corr. (dB/m)
4383.500000*	46.78	74.00	27.22	150.0	V	356.0	2.70
9668.500000	45.80	74.00	28.20	150.0	V	334.0	13.39
15272.000000	49.48	74.00	24.52	150.0	V	203.0	20.57

3DH5_Hight Channel:

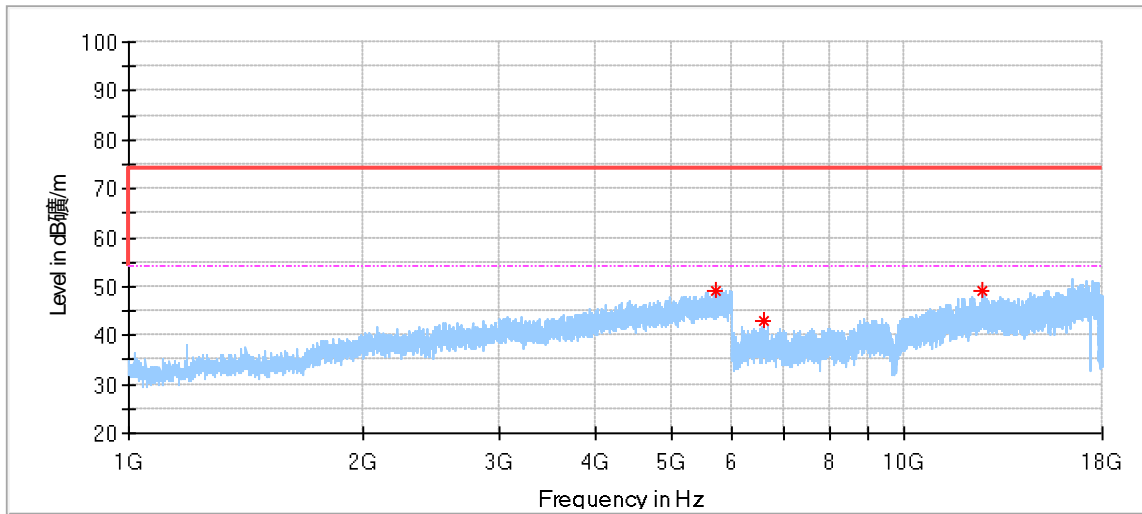

Frequency (MHz)	MaxPeak (dBµV/m)	Limit (dBµV/m)	Margin (dB)	Height (cm)	Pol	Azimuth (deg)	Corr. (dB/m)
5716.000000	49.08	74.00	24.92	150.0	H	48.0	5.75
6583.000000	43.14	74.00	30.86	150.0	H	144.0	9.59
12563.500000*	49.07	74.00	24.93	150.0	H	278.0	17.82

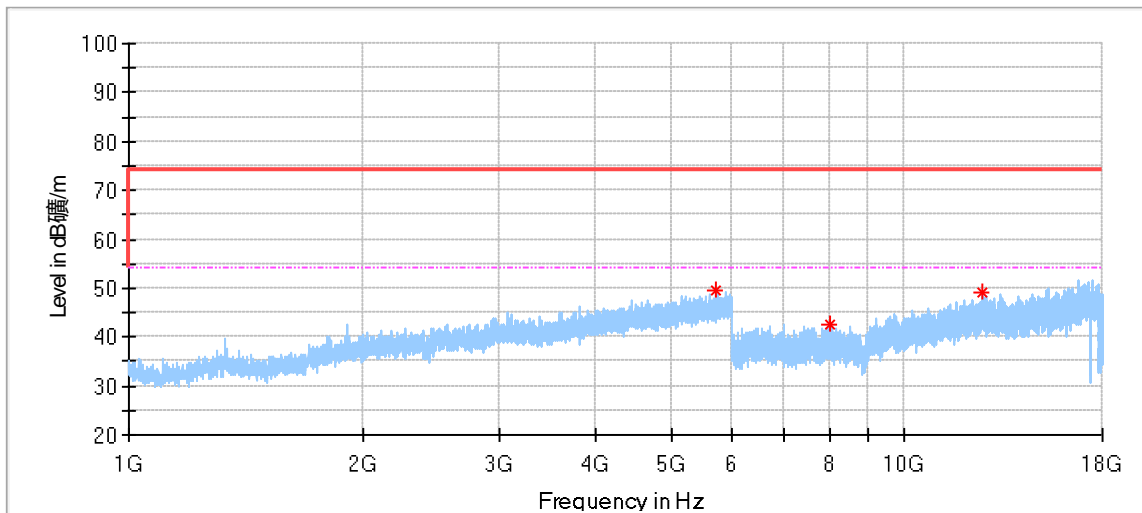

Frequency (MHz)	MaxPeak (dBµV/m)	Limit (dBµV/m)	Margin (dB)	Height (cm)	Pol	Azimuth (deg)	Corr. (dB/m)
5696.000000	49.44	74.00	24.56	150.0	V	10.0	5.69
8017.000000	42.71	74.00	31.29	150.0	V	6.0	11.07
12627.500000*	48.94	74.00	25.06	150.0	V	147.0	18.48

Test data 18GHz to 40GHz:
DH5_Low Channel:

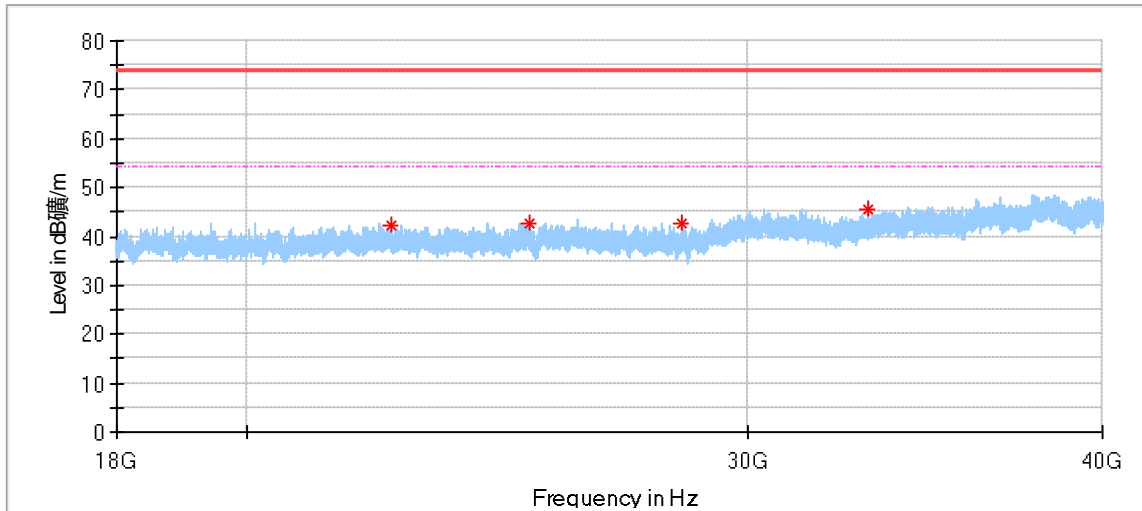

Frequency (MHz)	MaxPeak (dBµV/m)	Limit (dBµV/m)	Margin (dB)	Height (cm)	Pol	Azimuth (deg)	Corr. (dB/m)
22480.437500*	42.42	74.00	31.58	150.0	V	31.0	0.43
25134.875000	42.76	74.00	31.24	150.0	V	312.0	1.25
28466.500000	42.50	74.00	31.50	150.0	V	0.0	0.96
33080.312500	45.50	74.00	28.50	150.0	V	126.0	2.41

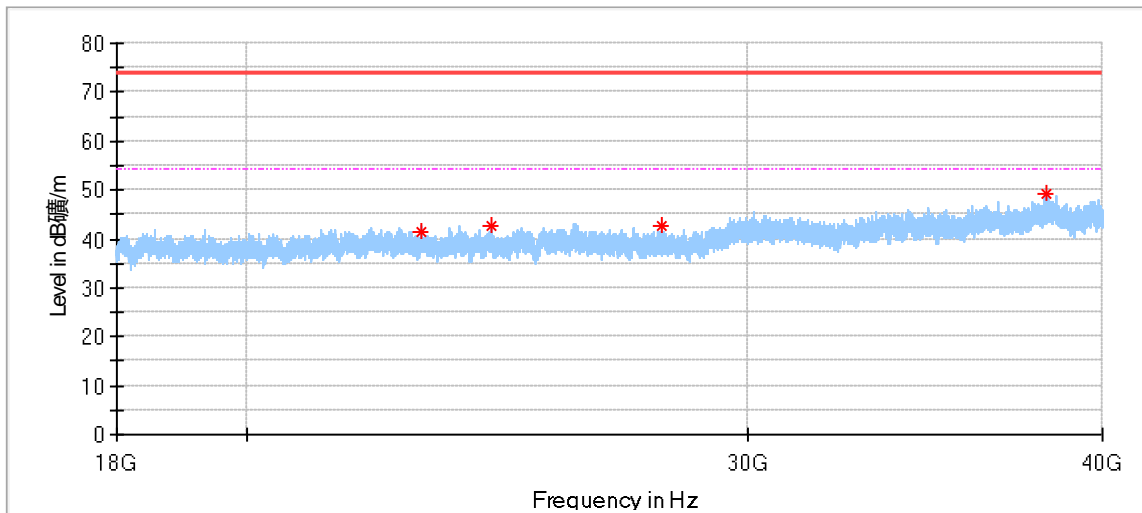

Frequency (MHz)	MaxPeak (dBµV/m)	Limit (dBµV/m)	Margin (dB)	Height (cm)	Pol	Azimuth (deg)	Corr. (dB/m)
23050.375000*	41.43	74.00	32.57	150.0	H	0.0	0.52
24399.937500	42.82	74.00	31.18	150.0	H	264.0	0.59
27979.750000	42.74	74.00	31.26	150.0	H	66.0	1.24
38211.125000	49.39	74.00	24.61	150.0	H	188.0	6.03

DH5_Middle Channel:

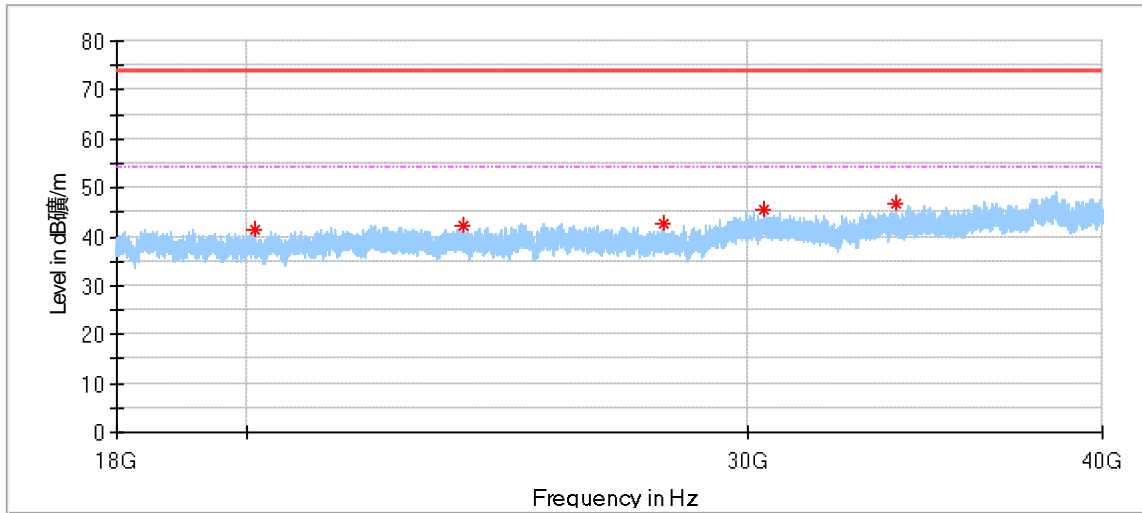

Frequency (MHz)	MaxPeak (dBµV/m)	Limit (dBµV/m)	Margin (dB)	Height (cm)	Pol	Azimuth (deg)	Corr. (dB/m)
20142.937500	41.63	74.00	32.37	150.0	V	265.0	-2.28
23820.375000*	42.05	74.00	31.95	150.0	V	4.0	0.60
28023.750000	42.58	74.00	31.42	150.0	V	0.0	1.23
30400.437500	45.34	74.00	28.66	150.0	V	295.0	2.06
33817.312500	46.63	74.00	27.37	150.0	V	326.0	3.10

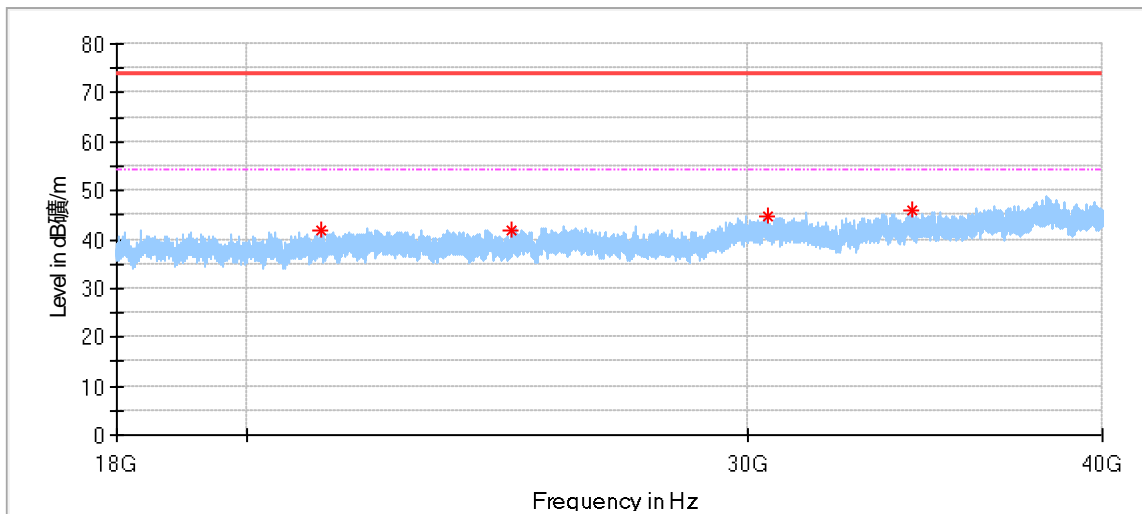

Frequency (MHz)	MaxPeak (dBµV/m)	Limit (dBµV/m)	Margin (dB)	Height (cm)	Pol	Azimuth (deg)	Corr. (dB/m)
21223.687500	41.72	74.00	32.28	150.0	H	0.0	-0.55
24784.250000	42.03	74.00	31.97	150.0	H	111.0	0.75
30492.562500	44.79	74.00	29.21	150.0	H	233.0	2.00
34262.812500	45.93	74.00	28.07	150.0	H	80.0	3.56

DH5_Hight Channel:

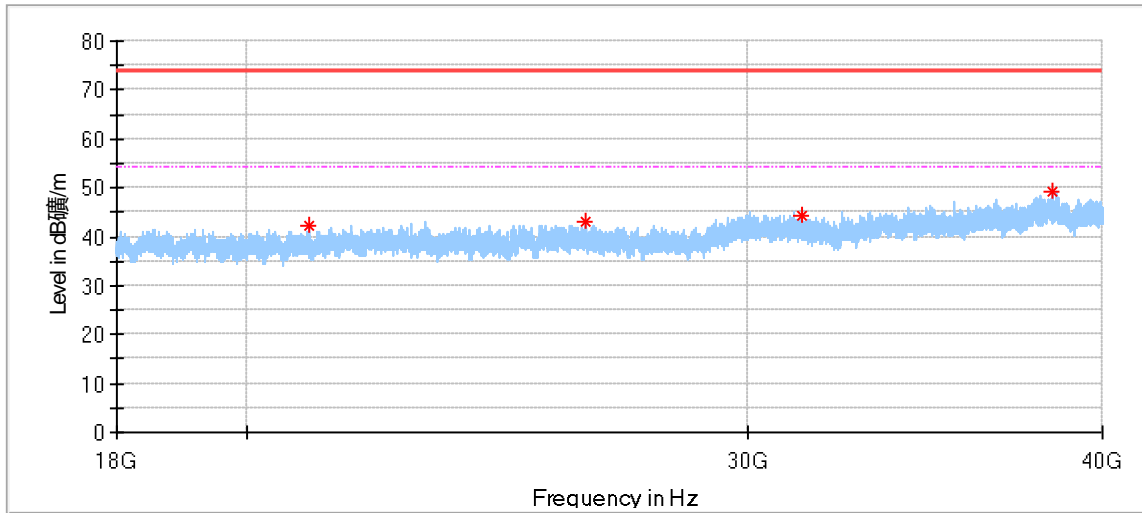

Frequency (MHz)	MaxPeak (dBµV/m)	Limit (dBµV/m)	Margin (dB)	Height (cm)	Pol	Azimuth (deg)	Corr. (dB/m)
21040.812500	42.31	74.00	31.69	150.0	V	0.0	-0.62
26336.625000	43.20	74.00	30.80	150.0	V	199.0	1.46
31364.312500	44.42	74.00	29.58	150.0	V	153.0	1.72
38398.812500	49.19	74.00	24.81	150.0	V	16.0	6.57

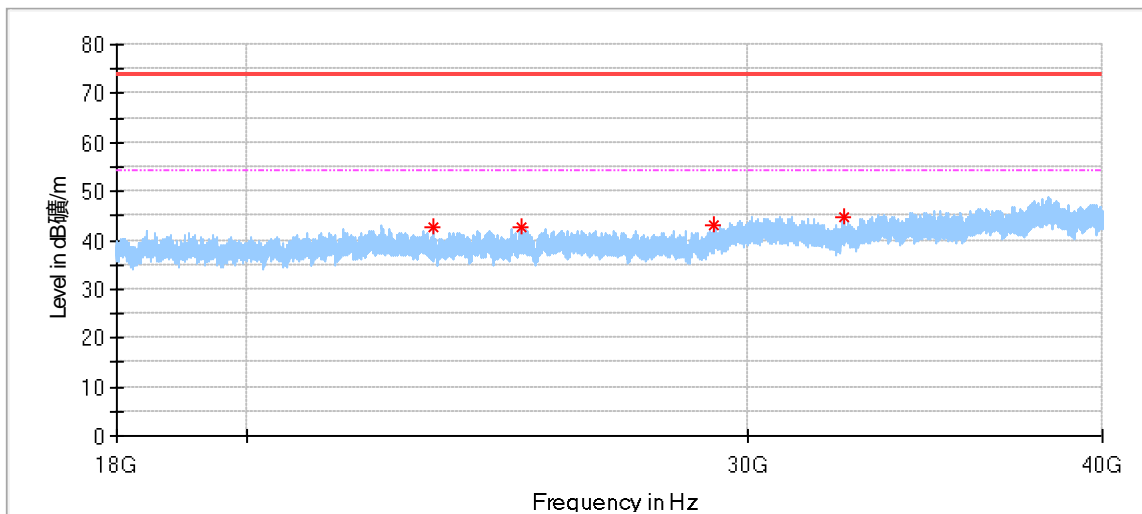

Frequency (MHz)	MaxPeak (dBµV/m)	Limit (dBµV/m)	Margin (dB)	Height (cm)	Pol	Azimuth (deg)	Corr. (dB/m)
23262.125000	42.65	74.00	31.35	150.0	H	0.0	0.12
24976.062500	42.52	74.00	31.48	150.0	H	4.0	1.21
29192.500000	43.25	74.00	30.75	150.0	H	177.0	1.24
32443.687500	44.72	74.00	29.28	150.0	H	207.0	1.95

Remark:

- (1) "*" means the emission(s) appear within the restrict bands shall follow the requirement of section 15.205 & RSS-GEN 8.10.
- (2) Data of measurement within frequency range 9kHz-30MHz are the noise floor or attenuated more than 20dB below the permissible limits or the field strength is too small to be measured, so test data does not present in this report.
- (3) Corrected Amplitude = Read level + Corrector factor
 Above 1GHz: Corrector factor = Antenna Factor + Cable Loss- Amplifier Gain
 Below 1GHz: Corrector factor = Antenna Factor + Cable Loss

10 Test Equipment List

List of Test Instruments

Radiated Emission Test

DESCRIPTION	MANUFACTURER	MODEL NO.	EQUIPMENT ID	SERIAL NO.	CAL INTERVAL (YEAR)	CAL. DUE DATE
EMI Test Receiver	Rohde & Schwarz	ESR 26	68-4-74-14-002	101269	1	2023-5-28
Trilog Super Broadband Test Antenna	Schwarzbeck	VULB 9162	68-4-80-19-003	284	1	2023-7-12
Loop Antenna	Rohde & Schwarz	HFH2-Z2	68-4-80-14-006	100398	1	2023-8-17
Wave Guide Antenna	ETS	3117	68-4-80-19-001	00218954	1	2023-5-9
Pre-amplifier	Rohde & Schwarz	SCU 18F	68-4-29-19-001	100745	1	2023-5-28
Pre-amplifier	Rohde & Schwarz	SCU 18F	68-4-29-19-002	100746	1	2023-5-28
Sideband Horn Antenna	Q-PAR	QWH-SL-18-40-K-SG	68-4-80-14-008	12827	1	2023-7-12
Pre-amplifier	Rohde & Schwarz	SCU 40A	68-4-29-14-002	100432	1	2023-7-27
Attenuator	Mini-circuits	UNAT-6+	68-4-81-21-002	15542	1	2023-5-27
3m Semi-anechoic chamber	TDK	SAC-3 #2	68-4-90-19-006	----	2	2023-5-28
Test software	Rohde & Schwarz	EMC32	68-4-90-19-006-A01	Version10.3 5.02	N/A	N/A

Conducted Emission Test

DESCRIPTION	MANUFACTURER	MODEL NO.	EQUIPMENT ID	SERIAL NO.	CAL INTERVAL (YEAR)	CAL. DUE DATE
EMI Test Receiver	Rohde & Schwarz	ESR 3	68-4-74-19-002	102590	1	2023-5-27
LISN	Rohde & Schwarz	ENV216	68-4-87-19-001	102472	1	2023-5-27
Attenuator	Shanghai Huaxiang	TS2-26-3	68-4-81-16-003	080928189	1	2023-5-27
Test software	Rohde & Schwarz	EMC32	68-4-90-19-005-A01	Version10.35. 02	N/A	N/A
Shielding Room	TDK	CSR #2	68-4-90-19-005	----	3	2025-10-15

Conducted RF Test System

DESCRIPTION	MANUFACTURER	MODEL NO.	EQUIPMENT ID	SERIAL NO.	CAL INTERVAL (YEAR)	CAL. DUE DATE
Signal Analyzer	Rohde & Schwarz	FSV40	68-4-74-14-004	101030	1	2023-5-27
RF Switch Module	Rohde & Schwarz	OSP120/OS P-B157	68-4-93-14-003	101226/10085 1	1	2023-5-27
Power Splitter	Weinschel	1580	68-4-85-14-001	SC319	1	2023-5-28
10dB Attenuator	Weinschel	4M-10	68-4-81-14-003	43152	1	2023-5-28
10dB Attenuator	R&S	DNF	68-4-81-14-004	DNF-001	1	2023-5-27
10dB Attenuator	R&S	DNF	68-4-81-14-005	DNF-002	1	2023-5-27
10dB Attenuator	R&S	DNF	68-4-81-14-006	DNF-003	1	2023-5-27
10dB Attenuator	R&S	DNF	68-4-81-14-007	DNF-004	1	2023-5-27
Test software	Tonscend	System for BT/WIFI	68-4-74-14-006-A13	Version 2.6.77.0518	N/A	N/A
Shielding Room	TDK	TS8997	68-4-90-19-003	----	3	2025-10-15

11 System Measurement Uncertainty

For a 95% confidence level, the measurement expanded uncertainties for defined systems, in accordance with the recommendations of ISO 17025 were:

System Measurement Uncertainty	
Test Items	Extended Uncertainty
Uncertainty for Conducted Emission 150kHz-30MHz (for test using AMN ENV432 or ENV4200)	3.57dB
Uncertainty for Radiated Emission in 3m chamber 9kHz-30MHz	4.70dB
Uncertainty for Radiated Emission in new 3m chamber 30MHz-1000MHz	Horizontal: 4.59dB; Vertical: 4.75dB
Uncertainty for Radiated Emission in new 3m chamber (1000MHz-18000MHz)	Horizontal: 5.08dB; Vertical: 5.09dB;
Uncertainty for Radiated Emission 18000MHz-40000MHz	Horizontal: 4.52dB; Vertical: 4.51dB
Uncertainty for Conducted RF test	RF Power Conducted: 1.31dB Frequency test involved: 0.6×10 ⁻⁸ or 1%

Measurement Uncertainty Decision Rule:

Determination of conformity with the specification limits is based on the decision rule according to IEC Guide 115: 2007, clause 4.4.3 and 4.5.1.

THE END