

FCC/ISED - TEST REPORT

Report Number : **68.950.23.0605.01** Date of Issue: **2023-07-14**

Model/HVIN : **A2287**

Product Type : Smart watch

Applicant : Anhui Huami Information Technology Co., Ltd.

Address : 7/F, Building B2, Huami Global Innovation Center, No. 900,
Wangjiang West Road, High-tech Zone, Hefei City, Anhui
Pilot Free Trade Zone China

Manufacturer : Anhui Huami Information Technology Co., Ltd.

Address : 7/F, Building B2, Huami Global Innovation Center, No. 900,
Wangjiang West Road, High-tech Zone, Hefei City, Anhui
Pilot Free Trade Zone China

Test Result : **Positive** **Negative**

Total pages including
Appendices : **53**

Any use for advertising purposes must be granted in writing. This technical report may only be quoted in full. This report is the result of a single examination of the object in question and is not generally applicable evaluation of the quality of other products in regular production. For further details, please see testing and certification regulation, chapter A-3.4.



1 Table of Contents

1	Table of Contents	2
2	Details about the Test Laboratory.....	3
3	Description of the Equipment Under Test.....	4
4	Summary of Test Standards.....	5
5	Summary of Test Results.....	6
6	General Remarks	7
7	Test Setups	8
8	Systems Test Configuration.....	10
9	Technical Requirement	11
9.1	Conducted Emission.....	11
9.2	Conducted Peak Output Power & EIRP	14
9.3	Power Spectral Density	18
9.4	6 dB Bandwidth and 99% Occupied Bandwidth	21
9.5	Spurious RF Conducted Emissions	26
9.6	Band Edge.....	34
9.7	Spurious Radiated Emissions for Transmitter.....	37
10	Test Equipment List.....	51
11	System Measurement Uncertainty	53

2 Details about the Test Laboratory

Details about the Test Laboratory

Test Site 1

Company name: TÜV SÜD Certification and Testing (China) Co., Ltd. Shenzhen Branch
Building 12 & 13, Zhiheng Wisdomland Business Park, Guankou Erlu,
Nantou, Nanshan District,
Shenzhen, Guangdong, China

Telephone: 86 755 8828 6998

Fax: 86 755 8828 5299

FCC Registration No.: 514049

FCC Designation Number: CN5009

IC Registration No.: 10320A

3 Description of the Equipment Under Test

Product:	Smart watch
Model no.:	A2287
Hardware Version Identification No. (HVIN)	A2287
Product Marketing Name (PMN)	A2287
Brand name:	AMAZFIT
FCC ID:	2AC8UA2287
IC:	21806-A2287
Options and accessories:	N/A
Rating:	5VDC 800mA
Battery information:	Rechargeable Li-ion Battery Model:PL412631FPC Rated:3.87VDC 475mAh/1.84Wh
RF Transmission Frequency:	2402MHz-2480MHz
No. of Operated Channel:	40
Modulation:	GFSK
Antenna Type:	Metal Case
Antenna 1	Gain: -8.09dBi
Description of the EUT:	The Equipment Under Test (EUT) is a Smart watch which support Bluetooth function and Wi-Fi operated at 2.4GHz. Only Bluetooth Low Energy included in this report.

NOTE 1: The above EUT's information is declared by manufacturer. Please refer to the specifications or user's manual for more detailed description.

4 Summary of Test Standards

Test Standards	
FCC Part 15 Subpart C 10-1-2021 Edition	PART 15 - RADIO FREQUENCY DEVICES Subpart C - Intentional Radiators
RSS-Gen Issue 5, April 2018 Amendment 1, March 2019 + Amendment 2, February 2021	General Requirements for Compliance of Radio Apparatus
RSS-247 Issue 2 February 2017	Digital Transmission Systems (DTSS), Frequency Hopping Systems (FHSS) and License-Exempt Local Area Network (LE-LAN) Devices

All the test methods were according to KDB 558074 D01 15.247 Meas Guidance v05r02 Measurement Guidance and ANSI C63.10 (2013).

5 Summary of Test Results

Technical Requirements			
FCC Part 15 Subpart C/ RSS-247 Issue 2/RSS-Gen Issue 5			
Test Condition		Test Site	Test Result
§15.207& RSS-Gen 8.8	Conducted emission AC power port	Site 1	Pass
§15.247(b)(3) & RSS-247 5.4(d)	Conducted peak output power	Site 1	Pass
RSS-247 5.4(b)	Equivalent Isotropic Radiated Power	Site 1	Pass
§15.247(e) & RSS-247 5.2(b)	Power spectral density	Site 1	Pass
§15.247(a)(2) & RSS-247 5.2(a) & RSS-Gen 6.7	6dB bandwidth and 99% Occupied Bandwidth	Site 1	Pass
§15.247(d) & RSS-247 5.5	Spurious RF conducted emissions	Site 1	Pass
§15.247(d) & RSS-247 5.5	Band edge	Site 1	Pass
§15.247(d) & §15.209 & RSS-247 5.5 & RSS-Gen 6.13	Spurious radiated emissions for transmitter	Site 1	Pass
§15.203 & RSS-Gen 6.8	Antenna requirement	See note 2	Pass

Note 1: N/A=Not Applicable.

Note 2: The EUT uses a metal case antenna, which gain is -8.09dBi. In accordance to §15.203 & RSS-Gen 6.8, it is considered sufficiently to comply with the provisions of this section.

6 General Remarks

Remarks

This submittal(s) (test report) is intended for FCC ID: 2AC8UA2287, IC: 21806-A2287, complies with Section 15.207, 15.209, 15.247 of the FCC Part 15, Subpart C rules and RSS-247, RSS-GEN.

SUMMARY:

All tests according to the regulations cited on page 5 were

■ - Performed

□ - **Not** Performed

The Equipment under Test

■ - **Fulfills** the general approval requirements.

□ - **Does not** fulfill the general approval requirements.

Sample Received Date: 2023-06-21

Testing Start Date: 2023-06-21

Testing End Date: 2023-07-06

- TÜV SÜD Certification and Testing (China) Co., Ltd. Shenzhen Branch -

Reviewed by:

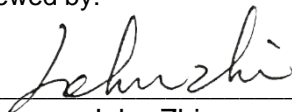

John Zhi
Section Manager

Prepared by:

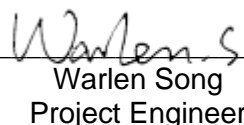

Warlen Song
Project Engineer

Tested by:

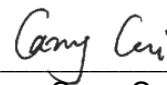

Carry Cai
Test Engineer



7 Test Setups

7.1 Radiated test setups

9KHz - 30MHz

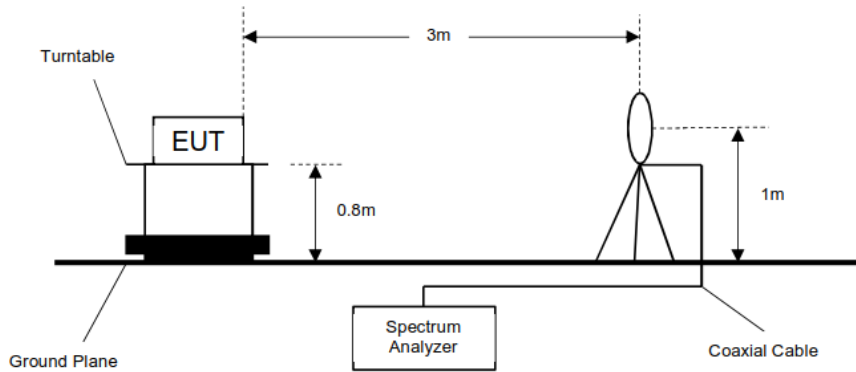

30MHz - 1GHz

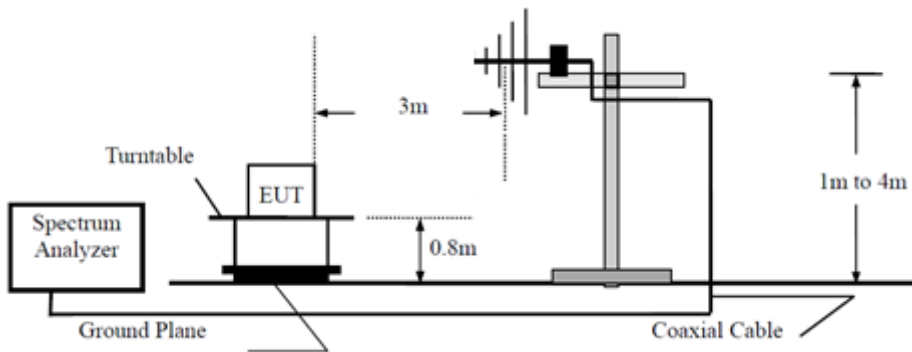

Above 1GHz

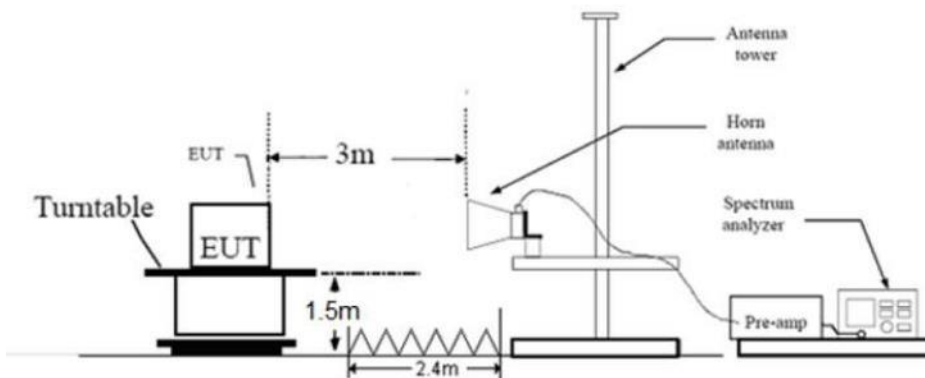

7.2 Conducted RF test setups

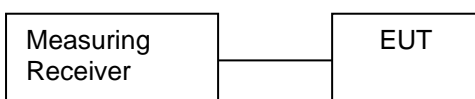

7.3 AC Power Line Conducted Emission test setups

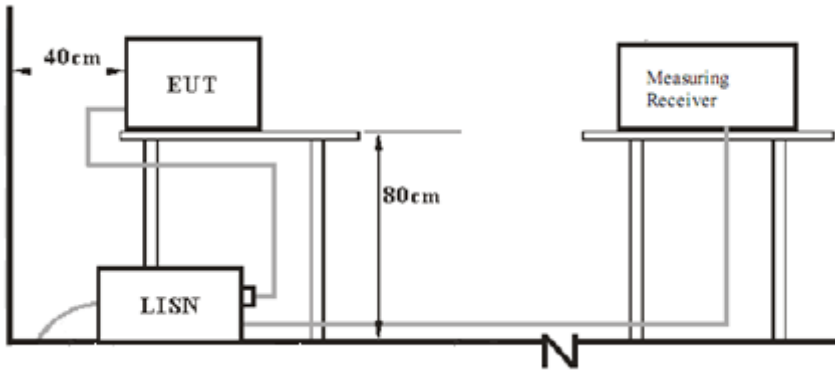

8 Systems Test Configuration

Auxiliary Equipment Used during Test:

Description	Manufacturer	Model NO.	S/N
Adapter	Apple	A1443	---
Notebook	LENOVO	X220	---

Cables Used During Test:

Cable	Length	Shielded/unshielded	With / without ferrite
---	---	---	---

Test software information:

Test Software Version	Broadcom BlueTool		
Modulation	Setting TX Power	Packet Type	
GFSK	Default	PRBS9	

The system was configured to non-hopping mode, testing channel 0, 19, 39.

9 Technical Requirement

9.1 Conducted Emission

Test Method

1. The EUT was placed 0.4 meter from the conducting wall of the shielding room was kept at least 80 centimeters from any other grounded conducting surface.
2. Connect EUT to the power mains through a line impedance stabilization network (LISN).
3. All the support units are connecting to the other LISN.
4. The LISN provides 50 ohm coupling impedance for the measuring instrument.
5. Both sides of AC line were checked for maximum conducted interference.
6. The frequency range from 150 kHz to 30 MHz was searched.
7. Set the test-receiver system to Peak Detect Function and specified bandwidth (IF Bandwidth = 9kHz) with Maximum Hold Mode. Then measurement is also conducted by Average Detector and Quasi-Peak Detector Function respectively.

Limit

Frequency MHz	QP Limit dB μ V	AV Limit dB μ V
0.150-0.500	66-56*	56-46*
0.500-5	56	46
5-30	60	50

*Decreases with the logarithm of the frequency.

Conducted Emission

Product Type : Smart watch
 M/N : A2287
 Operating Condition : Transmit
 Test Specification : Line
 Comment : AC 120V/60Hz

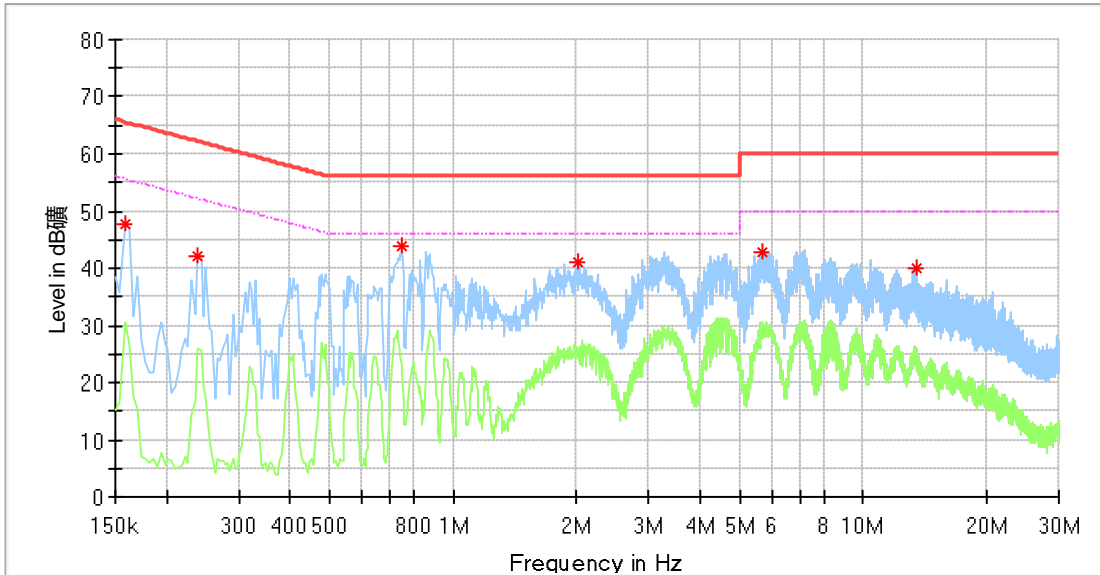

Frequency (MHz)	MaxPeak* (dBµV)	Average* (dBµV)	Limit (dBµ)	Margin (dB)	Line	Corr. ** (dB)
0.158000	47.57	---	65.57	18.00	L1	10.33
0.238000	41.98	---	62.17	20.19	L1	10.34
0.750000	43.97	---	56.00	12.03	L1	10.36
2.026000	41.16	---	56.00	14.84	L1	10.41
5.690000	42.79	---	60.00	17.21	L1	10.61
13.458000	39.92	---	60.00	20.08	L1	10.93

Remark:

*Level=Reading Level + Correction Factor

**Correction Factor=Cable Loss + LISN Factor

(The Reading Level is recorded by software which is not shown in the sheet)

Conducted Emission

Product Type : Smart watch
 M/N : A2287
 Operating Condition : Transmit
 Test Specification : Neutral
 Comment : AC 120V/60Hz

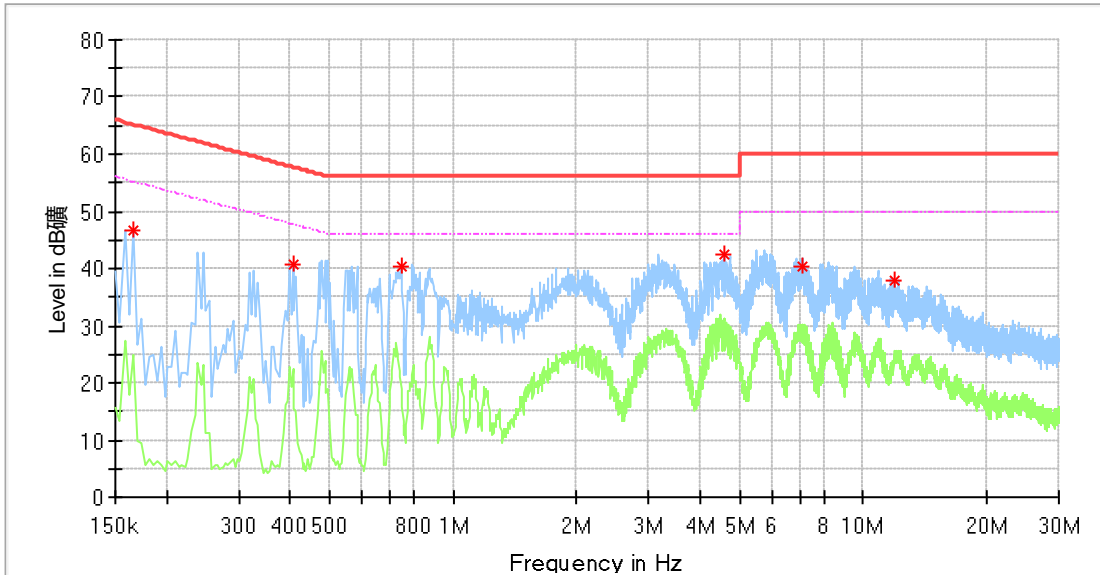

Frequency (MHz)	MaxPeak* (dBµV)	Average* (dBµV)	Limit (dBµ)	Margin (dB)	Line	Corr. ** (dB)
0.166000	46.80	---	65.16	18.36	N	10.37
0.406000	40.68	---	57.73	17.05	N	10.45
0.746000	40.48	---	56.00	15.52	N	10.49
4.574000	42.61	---	56.00	13.39	N	10.71
7.078000	40.27	---	60.00	19.73	N	10.81
11.926000	38.00	---	60.00	22.00	N	11.06

Remark:

*Level=Reading Level + Correction Factor

**Correction Factor=Cable Loss + LISN Factor

(The Reading Level is recorded by software which is not shown in the sheet)

9.2 Conducted Peak Output Power & EIRP

Test Method

1. The RF output of EUT was connected to the test spectrum analyzer by RF cable. The path loss was compensated to the results for each measurement.
2. Set to the maximum power setting and enable the EUT transmit continuously
3. Use the following test receiver settings:
Span = approximately 5 times the 6dB bandwidth, centered on a hopping channel
RBW > the 6dB bandwidth of the emission being measured, VBW ≥ 3RBW,
Sweep = auto, Detector function = peak, Trace = max hold
4. Allow the trace to stabilize. Use the marker-to-peak function to set the marker to the peak of the emission. The indicated level is the peak output power and record the results in the test report.
5. Repeat above procedures until all frequencies measured were complete.

Limits

According to §15.247 (b) (3) & RSS-247 5.4(d), conducted peak output power limit as below:

Frequency Range MHz	Limit W	Limit dBm
2400-2483.5	≤1	≤30

According to & RSS-247 5.4(d), EIRP limit as below:

Frequency Range MHz	Limit W	Limit dBm
2400-2483.5	≤4	≤36

Conducted Peak Output Power & EIRP

Frequency MHz	Mode	Conducted Peak Output Power dBm	Antenna Gain dBi	EIRP dBm	Result
Bottom channel 2402MHz	LE 1Mbps	2.21	-8.09	-5.88	Pass
Middle channel 2440MHz	LE 1Mbps	2.68	-8.09	-5.41	Pass
Top channel 2480MHz	LE 1Mbps	2.83	-8.09	-5.26	Pass
Bottom channel 2402MHz	LE 2Mbps	2.09	-8.09	-6.00	Pass
Middle channel 2440MHz	LE 2Mbps	2.48	-8.09	-5.61	Pass
Top channel 2480MHz	LE 2Mbps	2.62	-8.09	-5.47	Pass

BLE_1M_BT4.0_Ant1_2402

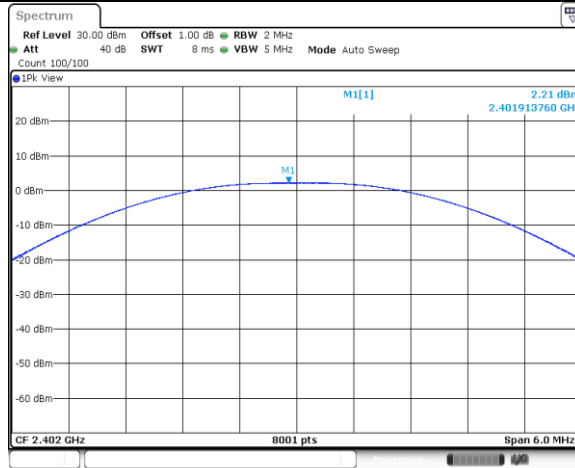

Date: 27 JUN 2023 17:29:04

BLE_1M_BT4.0_Ant1_2440

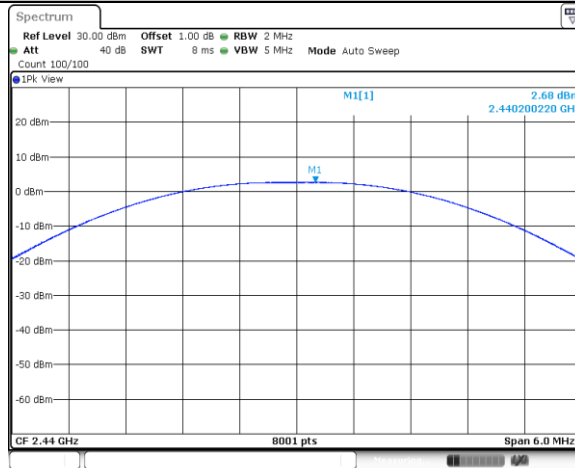

Date: 27 JUN 2023 17:31:41

BLE_1M_BT4.0_Ant1_2480

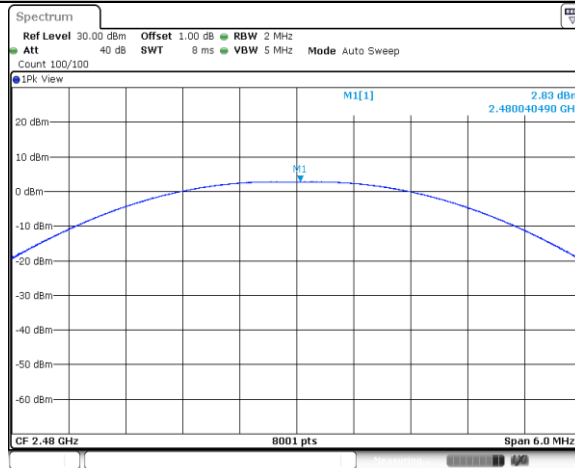

Date: 27 JUN 2023 17:33:25

BLE_2M_BT5.0_Ant1_2402

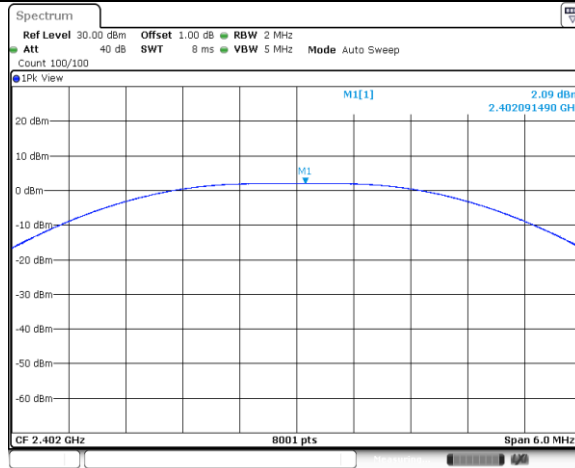

Date: 27 JUN 2023 17:40:02

BLE_2M_BT5.0_Ant1_2440

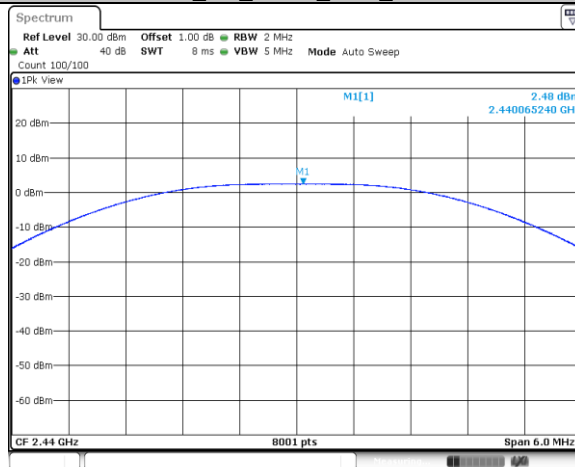

Date: 27 JUN 2023 17:42:03

BLE_2M_BT5.0_Ant1_2480

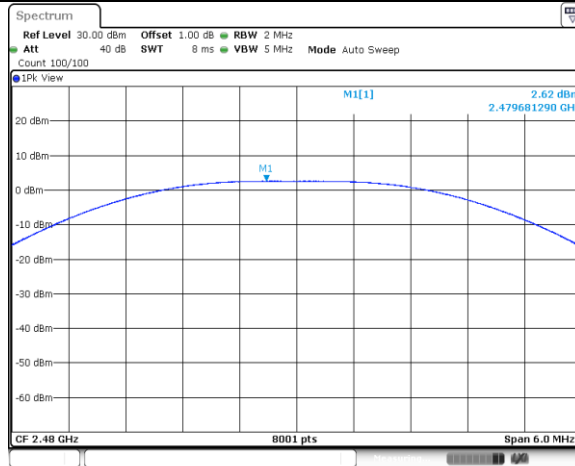

Date: 27 JUN 2023 17:44:13

9.3 Power Spectral Density

Test Method

This procedure shall be used if maximum peak conducted output power was used to demonstrate compliance:

1. The RF output of EUT was connected to the spectrum analyzer. The path loss was compensated to the results for each measurement.
2. Set to the maximum power setting, the instrument center frequency is set to the nominal EUT channel center frequency enable the EUT transmit continuously.
3. Use the following spectrum analyzer settings:
4. Set analyzer center frequency to DTS channel center frequency. RBW=3kHz, VBW \geq 3RBW, Span=1.5 times DTS bandwidth, Detector=Peak, Sweep=auto, Trace= max hold.
5. Allow trace to fully stabilize, use the peak marker function to determine the maximum amplitude level within the RBW.
6. Repeat above procedures until other frequencies measured were completed.

Limit

Limit [dBm/3KHz]

≤8

Test result

Frequency MHz	Mode	Power spectral density dBm/3KHz	Result
Bottom channel 2402MHz	LE 1Mbps	-13.61	Pass
Middle channel 2440MHz	LE 1Mbps	-13.19	Pass
Top channel 2480MHz	LE 1Mbps	-12.97	Pass
Bottom channel 2402MHz	LE 2Mbps	-15.95	Pass
Middle channel 2440MHz	LE 2Mbps	-15.64	Pass
Top channel 2480MHz	LE 2Mbps	-15.46	Pass

BLE_1M_BT4.0_Ant1_2402

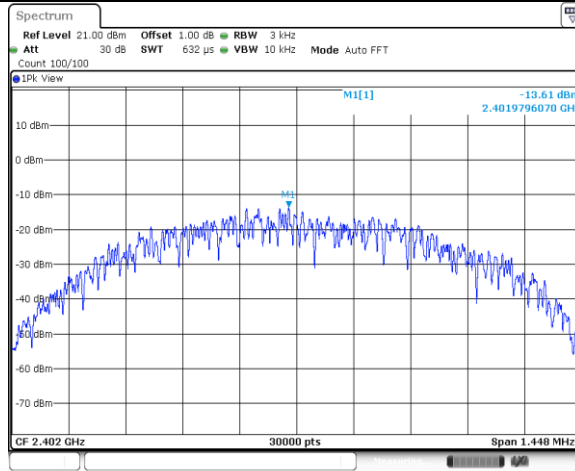

Date: 27 JUN 2023 17:29:10

BLE_1M_BT4.0_Ant1_2440

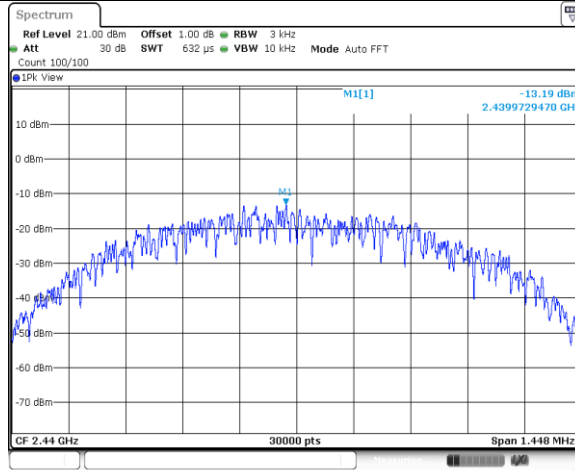

Date: 27 JUN 2023 17:31:47

BLE_1M_BT4.0_Ant1_2480

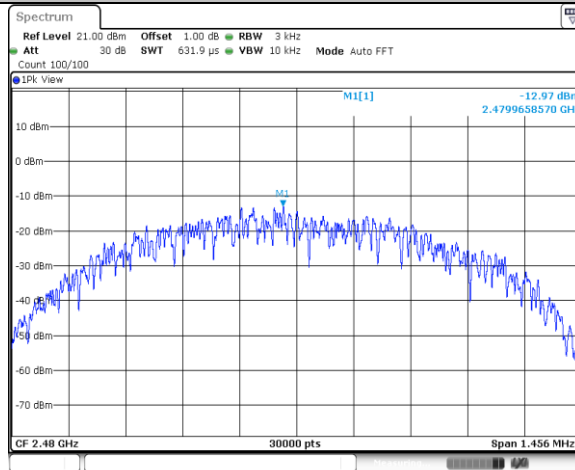

Date: 27 JUN 2023 17:33:31

BLE_2M_BT5.0_Ant1_2402

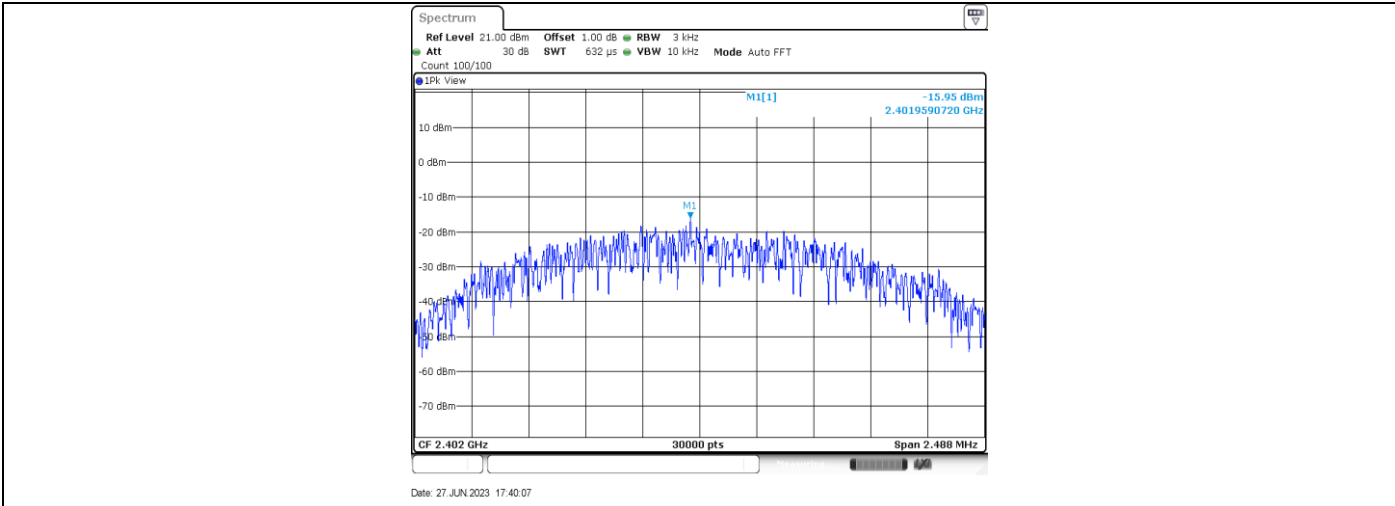

BLE_2M_BT5.0_Ant1_2440

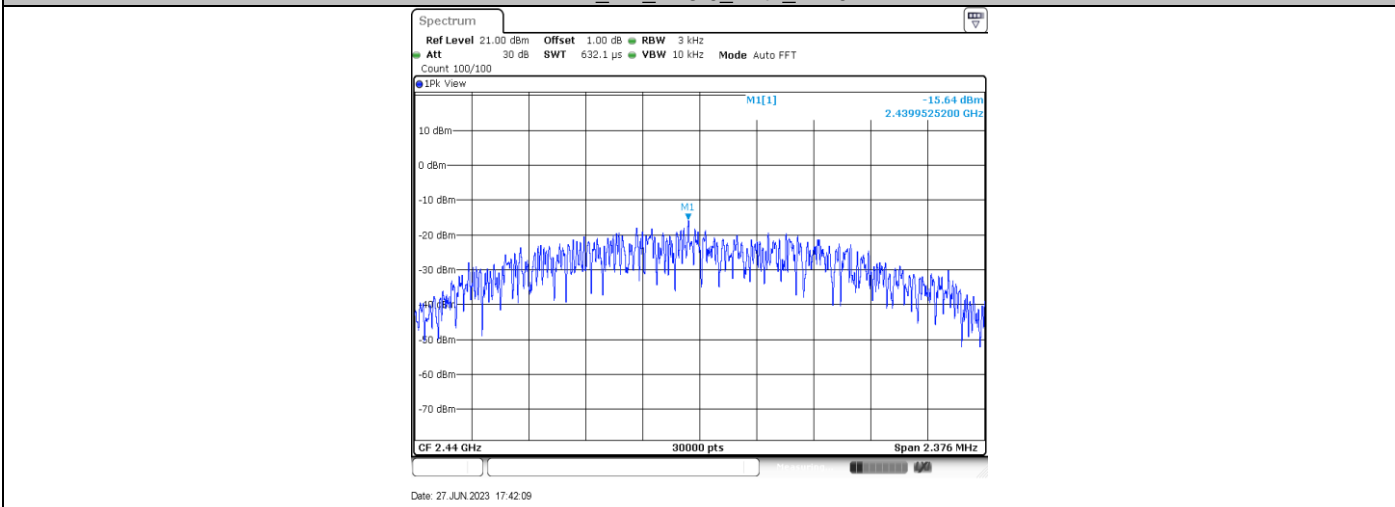

BLE_2M_BT5.0_Ant1_2480

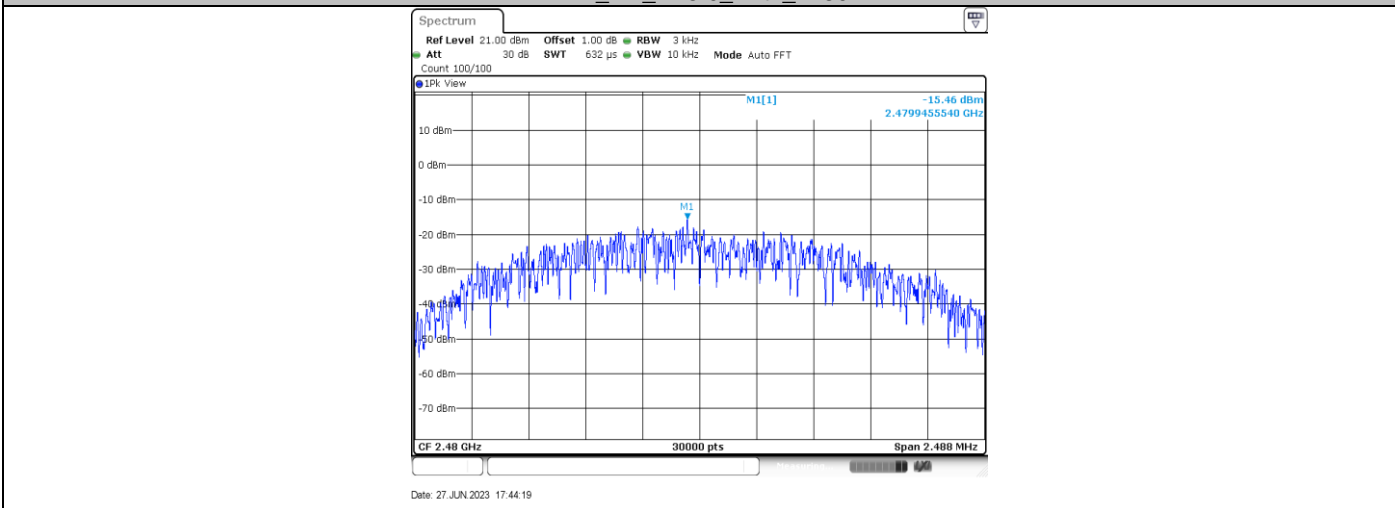

9.4 6 dB Bandwidth and 99% Occupied Bandwidth

Test Method for 6 dB Bandwidth

1. The RF output of EUT was connected to the spectrum analyzer. The path loss was compensated to the results for each measurement.
2. Set to the maximum power setting, the instrument center frequency is set to the nominal EUT channel center frequency enable the EUT transmit continuously.
3. Use the following spectrum analyzer settings:
RBW=100KHz, VBW≥3RBW, Sweep = auto, Detector function = peak, Trace = max hold
4. Use the automatic bandwidth measurement capability of an instrument, use the X dB bandwidth mode with X set to 6 dB.
5. Allow the trace to stabilize, record the 6 dB Bandwidth value.

Test Method for 99 % Bandwidth

1. Connect EUT test port to spectrum analyzer.
Use the following spectrum analyzer settings:
RBW=1% to 5% of the actual occupied, VBW≥3RBW, Sweep = auto,
Detector function = peak, Trace = max hold
2. Use the occupied bandwidth measurement capability of test receiver.
3. Allow the trace to stabilize, record the occupied bandwidth value.

Limit

6dB bandwidth Limit [kHz]	99% bandwidth Limit [kHz]
≥500	--

Test result

Frequency MHz	Mode	6dB bandwidth MHz	99% bandwidth MHz	Result
Bottom channel 2402MHz	LE 1M	0.724	1.244	Pass
Middle channel 2440MHz	LE 1M	0.724	1.188	Pass
Top channel 2480MHz	LE 1M	0.728	1.244	Pass
Bottom channel 2402MHz	LE 2M	1.047	2.022	Pass
Middle channel 2440MHz	LE 2M	1.051	2.022	Pass
Top channel 2480MHz	LE 2M	1.047	2.022	Pass

6 dB Bandwidth

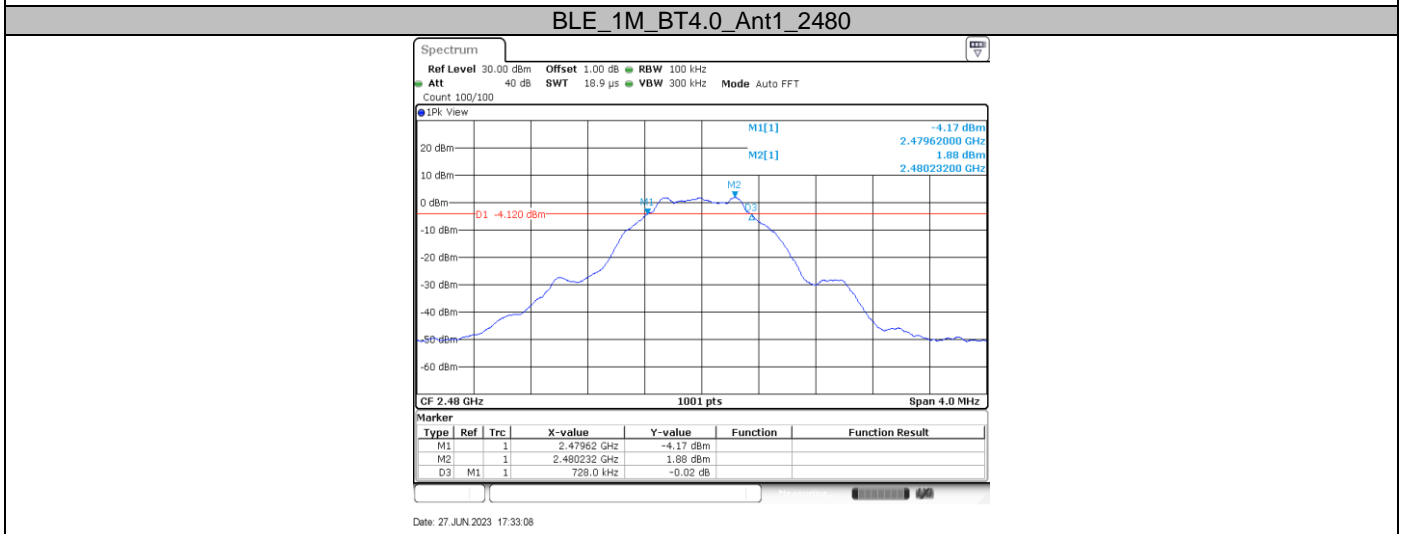
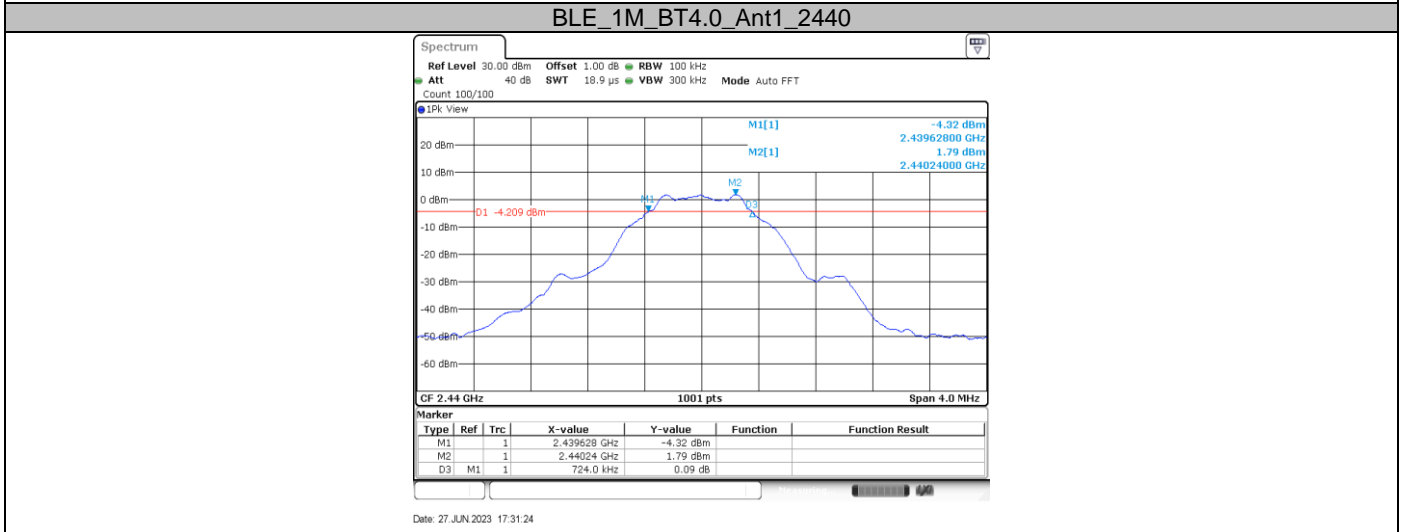
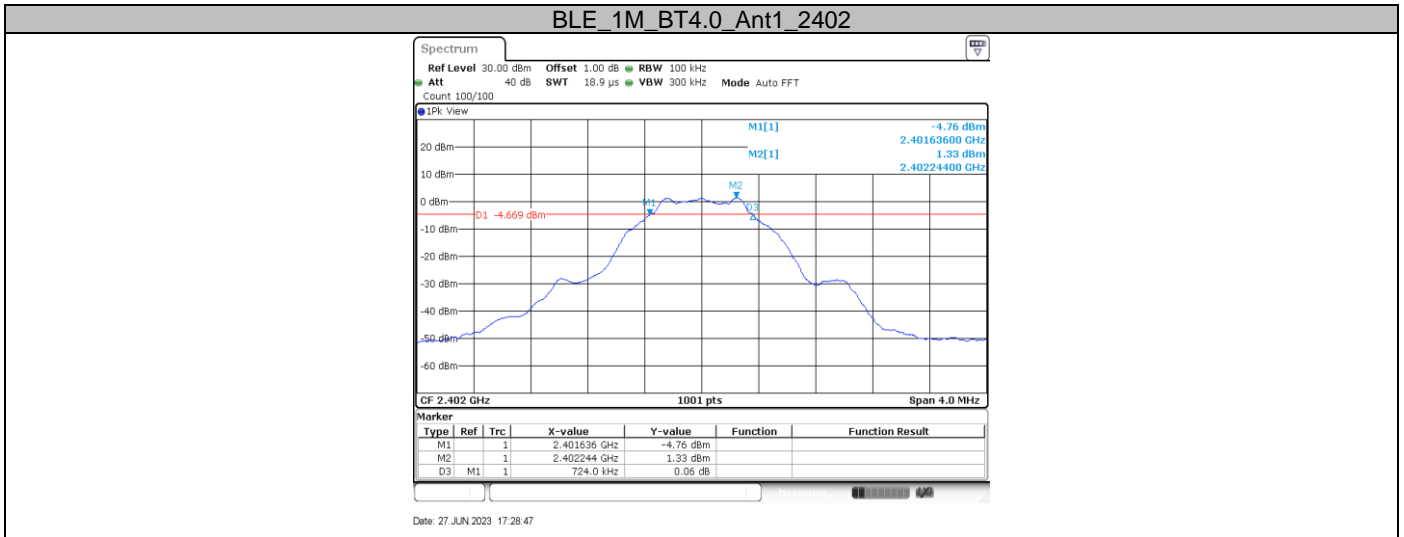

BLE_2M_BT5.0_Ant1_2402

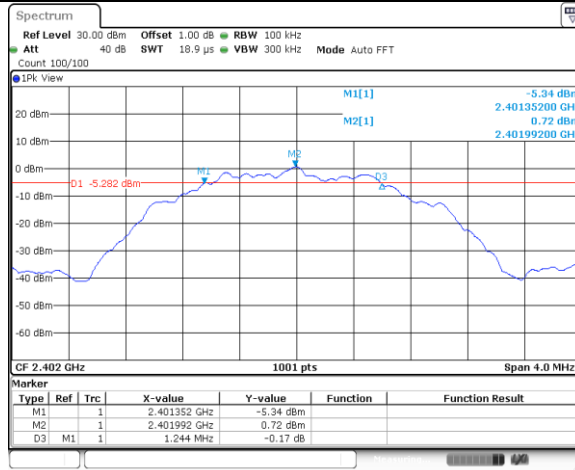

Date: 27 JUN 2023 17:39:44

BLE_2M_BT5.0_Ant1_2440

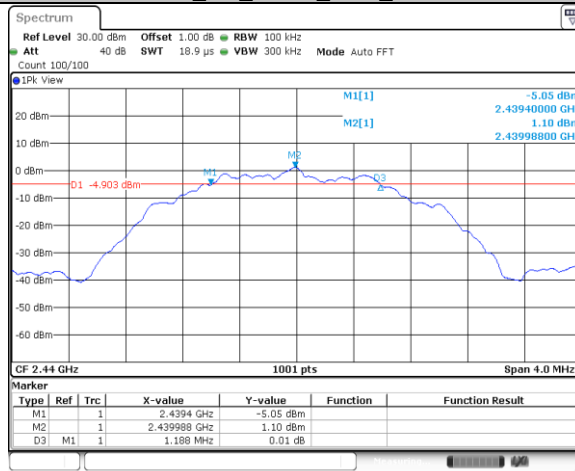

Date: 27 JUN 2023 17:41:46

BLE_2M_BT5.0_Ant1_2480

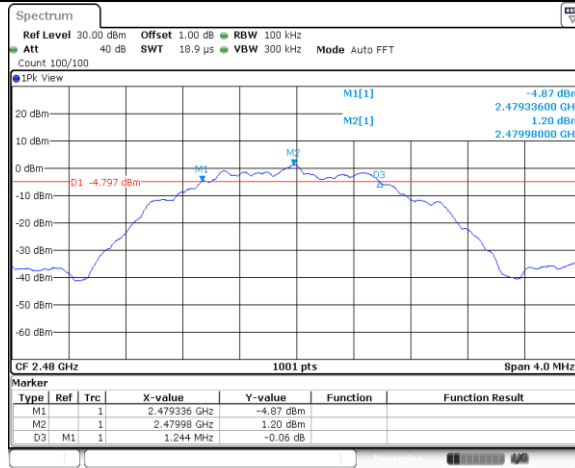

Date: 27 JUN 2023 17:43:56

99% Bandwidth

BLE_1M_BT4.0_Ant1_2402

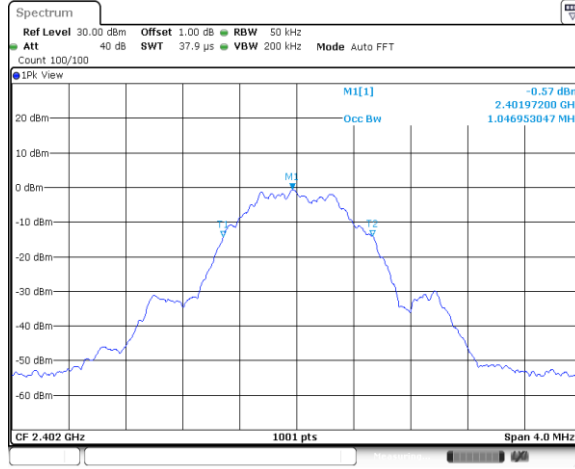

Date: 27 JUN 2023 17:28:58

BLE_1M_BT4.0_Ant1_2440

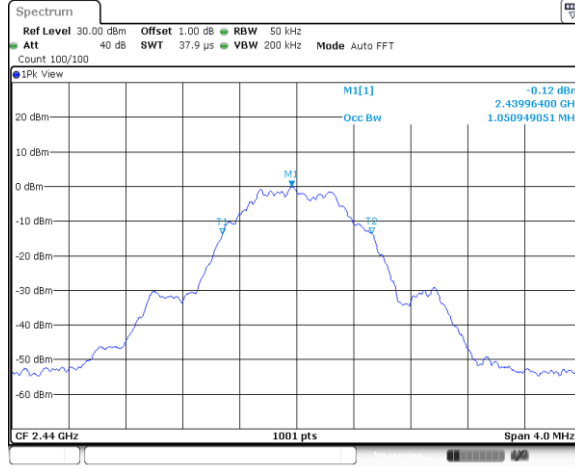

Date: 27 JUN 2023 17:31:35

BLE_1M_BT4.0_Ant1_2480

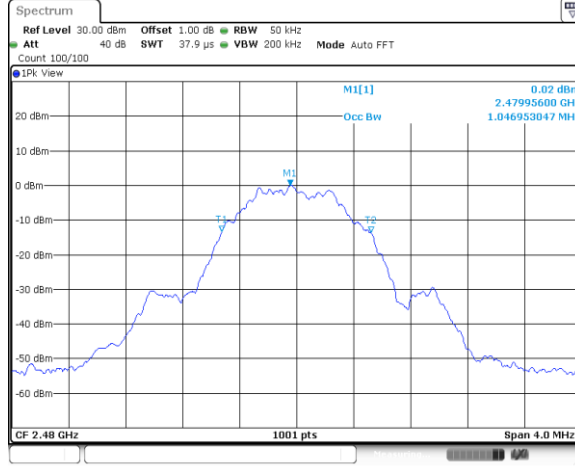

Date: 27 JUN 2023 17:33:19

BLE_2M_BT5.0_Ant1_2402



BLE_2M_BT5.0_Ant1_2440

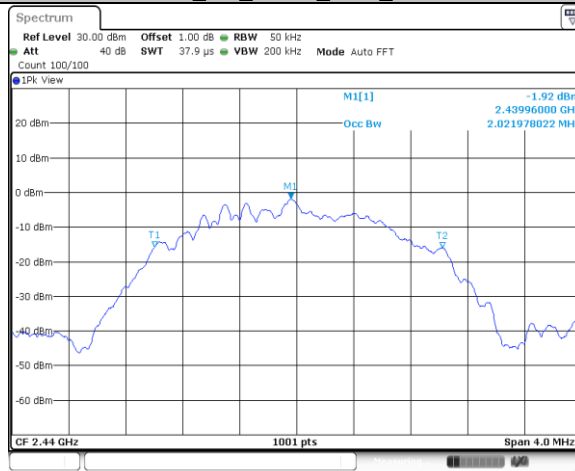

BLE_2M_BT5.0_Ant1_2480



9.5 Spurious RF Conducted Emissions

Test Method

1. The RF output of EUT was connected to the spectrum analyzer by RF cable. The path loss was compensated to the results for each measurement.
2. Set to the maximum power setting, the instrument center frequency is set to the nominal EUT channel center frequency enable the EUT transmit continuously.
3. Use the following spectrum analyzer settings:
Span = wide enough to capture the peak level of the in-band emission and all spurious emissions (e.g., harmonics) from the lowest frequency generated in the EUT up through the 10th harmonic. Typically, several plots are required to cover this entire span.
RBW = 100 kHz, VBW \geq 3RBW, Sweep = auto, Detector function = peak, Trace = max hold
4. Allow the trace to stabilize. Set the marker on the peak of any spurious emission recorded.
5. The level displayed must comply with the limit specified in this Section. Submit these plots.
6. Repeat above procedures until all frequencies measured were complete.

Limit

Frequency Range MHz	Limit (dBc)
30-25000	-20

Spurious RF conducted emissions

Test Mode	Channel (MHz)	Frequency Range (MHz)	Result (dBm)	Limit (dBm)	Verdict
BLE_1Mbps	2402	Reference	1.32	---	PASS
		30~1000	-67.93	<=-18.68	PASS
		1000~26500	-52.11	<=-18.68	PASS
	2440	Reference	1.74	---	PASS
		30~1000	-67.7	<=-18.26	PASS
		1000~26500	-52.38	<=-18.26	PASS
	2480	Reference	1.91	---	PASS
		30~1000	-68.01	<=-18.09	PASS
		1000~26500	-52.29	<=-18.09	PASS
BLE_2Mbps	2402	Reference	0.72	---	PASS
		30~1000	-68.08	<=-19.28	PASS
		1000~26500	-44.25	<=-19.28	PASS
	2440	Reference	1.06	---	PASS
		30~1000	-67.9	<=-18.94	PASS
		1000~26500	-52.46	<=-18.94	PASS
	2480	Reference	1.19	---	PASS
		30~1000	-68.1	<=-18.81	PASS
		1000~26500	-52.6	<=-18.81	PASS

BLE_1M_BT4.0_Ant1_2402_0~Reference



Date: 27 JUN 2023 17:29:25

BLE_1M_BT4.0_Ant1_2402_30~1000

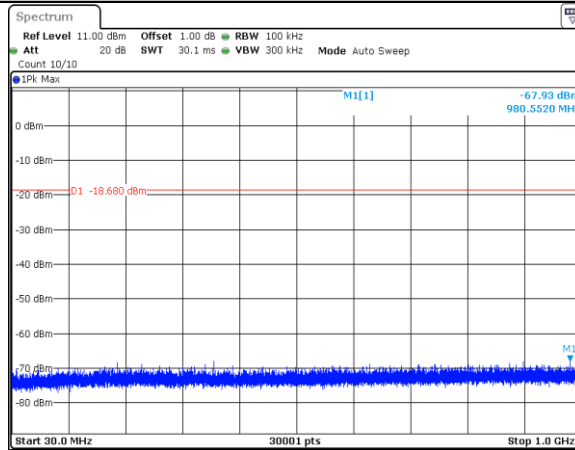

Date: 27 JUN 2023 17:29:31

BLE_1M_BT4.0_Ant1_2402_1000~26500

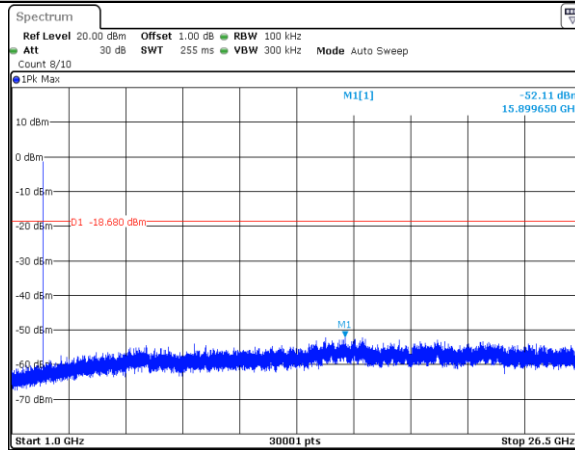

Date: 27 JUN 2023 17:29:39

BLE_1M_BT4.0_Ant1_2440_0~Reference



Date: 27 JUN 2023 17:31:52

BLE_1M_BT4.0_Ant1_2440_30~1000

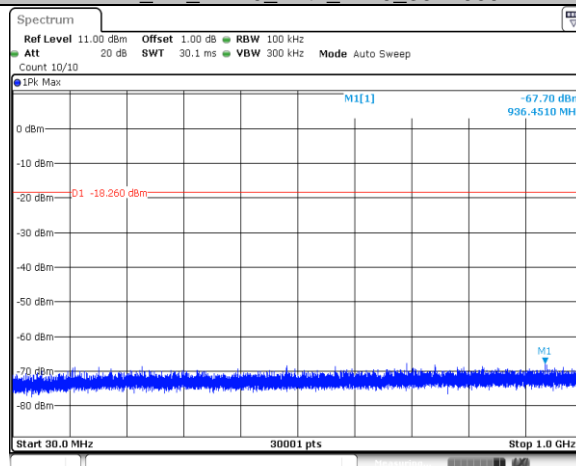

Date: 27 JUN 2023 17:31:59

BLE_1M_BT4.0_Ant1_2440_1000~26500

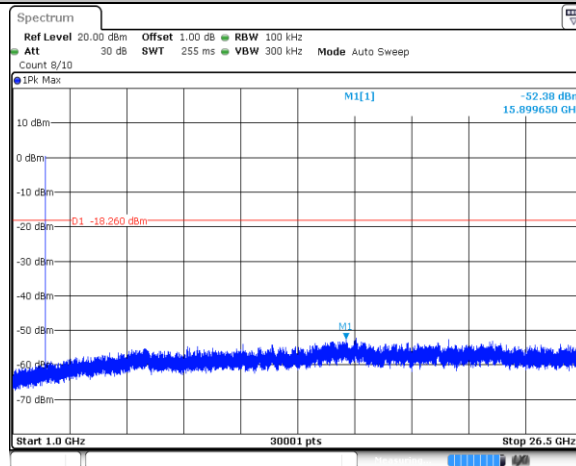

Date: 27 JUN 2023 17:32:06

BLE_1M_BT4.0_Ant1_2480_0~Reference



Date: 27 JUN 2023 17:33:46

BLE_1M_BT4.0_Ant1_2480_30~1000

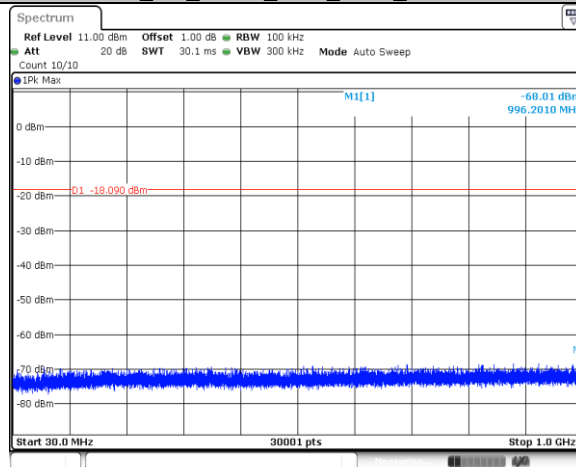

Date: 27 JUN 2023 17:33:52

BLE_1M_BT4.0_Ant1_2480_1000~26500

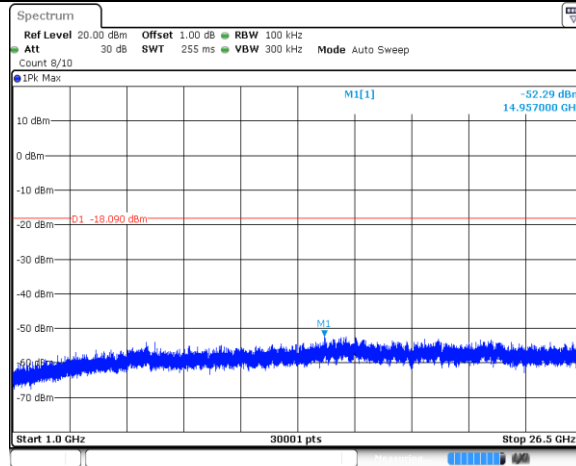

Date: 27 JUN 2023 17:34:00

BLE_2M_BT5.0_Ant1_2402_0~Reference

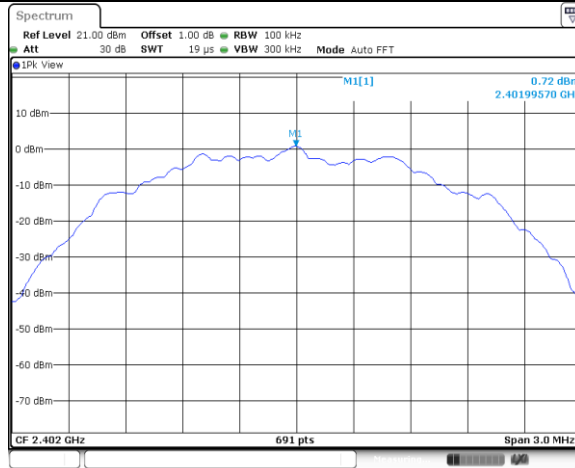

Date: 27 JUN 2023 17:40:22

BLE_2M_BT5.0_Ant1_2402_30~1000

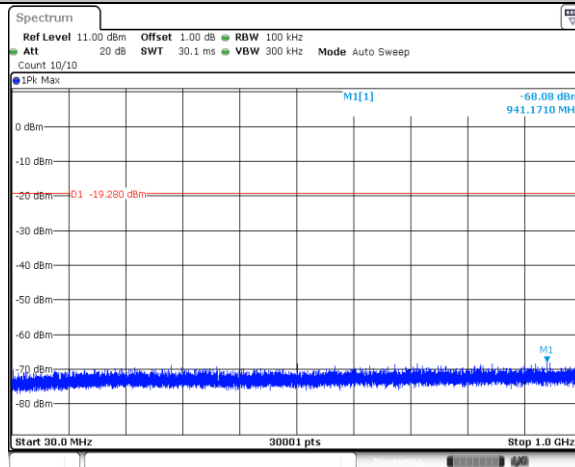

Date: 27 JUN 2023 17:40:28

BLE_2M_BT5.0_Ant1_2402_1000~26500

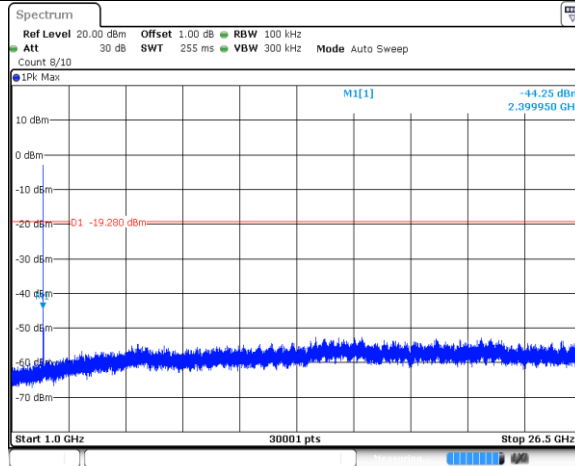

Date: 27 JUN 2023 17:40:36

BLE_2M_BT5.0_Ant1_2440_0~Reference



Date: 27 JUN 2023 17:42:14

BLE_2M_BT5.0_Ant1_2440_30~1000

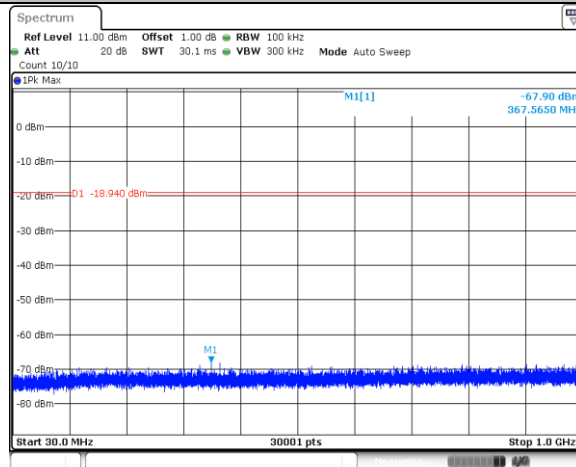

Date: 27 JUN 2023 17:42:20

BLE_2M_BT5.0_Ant1_2440_1000~26500

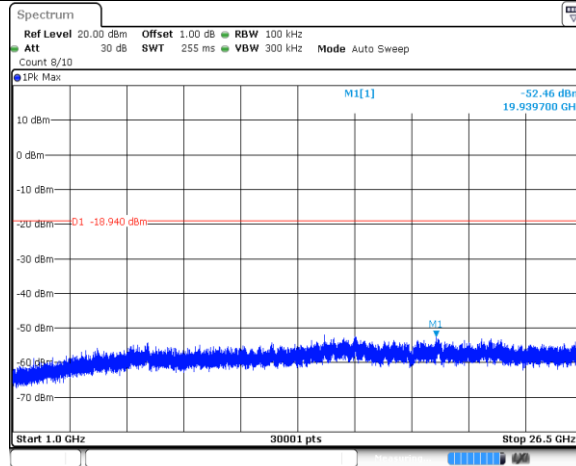

Date: 27 JUN 2023 17:42:28

BLE_2M_BT5.0_Ant1_2480_0~Reference



Date: 27 JUN 2023 17:44:33

BLE_2M_BT5.0_Ant1_2480_30~1000

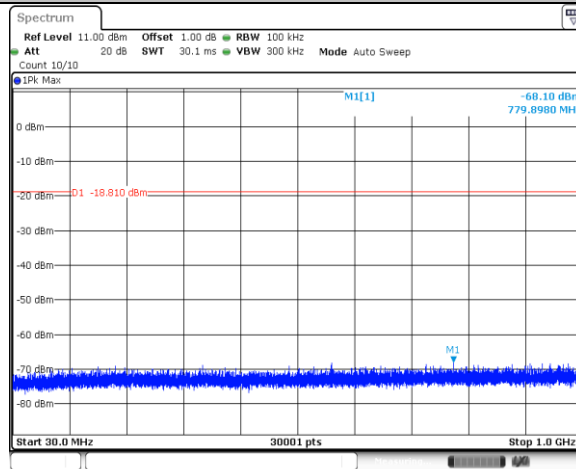

Date: 27 JUN 2023 17:44:40

BLE_2M_BT5.0_Ant1_2480_1000~26500

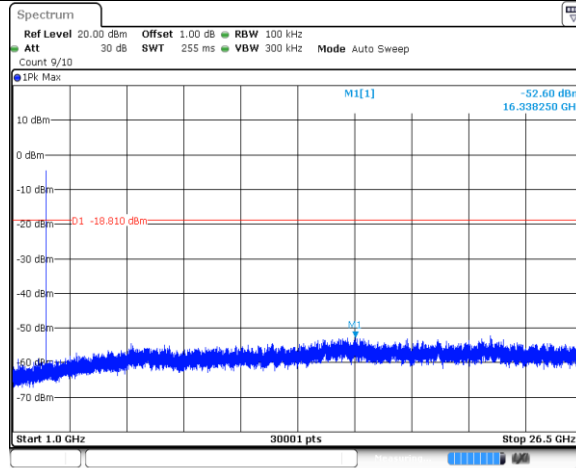

Date: 27 JUN 2023 17:44:47

9.6 Band Edge

Test Method

1. The RF output of EUT was connected to the spectrum analyzer by RF cable. The path loss was compensated to the results for each measurement.
2. Set to the maximum power setting, the instrument center frequency is set to the nominal EUT channel center frequency enable the EUT transmit continuously.
3. Use the following spectrum analyzer settings:
 Span = wide enough to capture the peak level of the in-band emission and all spurious emissions (e.g., harmonics) from the lowest frequency generated in the EUT up through the 10th harmonic. Typically, several plots are required to cover this entire span.
 RBW = 100 kHz, VBW≥3RBW, Sweep = auto, Detector function = peak, Trace = max hold
4. Allow the trace to stabilize. Set the marker on the peak of any spurious emission recorded.
5. The level displayed must comply with the limit specified in this Section. Submit these plots.
6. Repeat above procedures until all frequencies measured were complete.

Limit

Frequency Range MHz	Limit (dBc)
30-25000	-20

Band edge testing

Test Mode	Channel	Channel (MHz)	Reference Level (dBm)	Result (dBm)	Limit (dBm)	Verdict
BLE_1Mbps	Low	2402	1.24	-59.17	<=-18.76	PASS
	High	2480	1.90	-57.12	<=-18.10	PASS
BLE_2Mbps	Low	2402	0.69	-37.6	<=-19.31	PASS
	High	2480	1.43	-57.82	<=-18.57	PASS

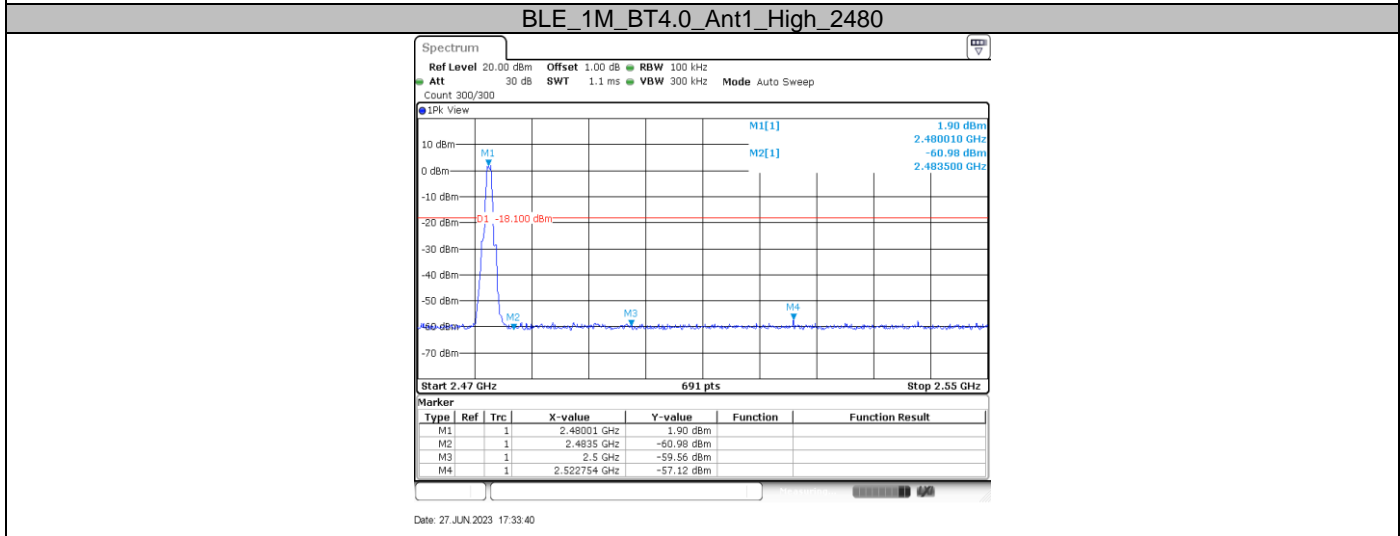
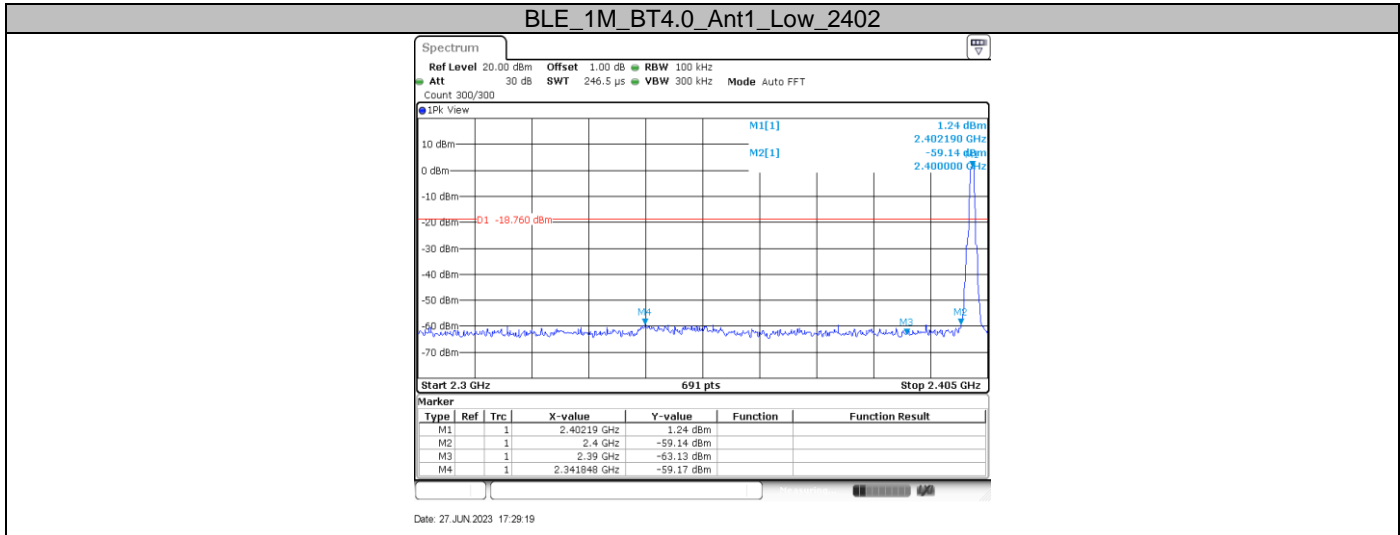

BLE_2M_BT5.0_Ant1_Low_2402

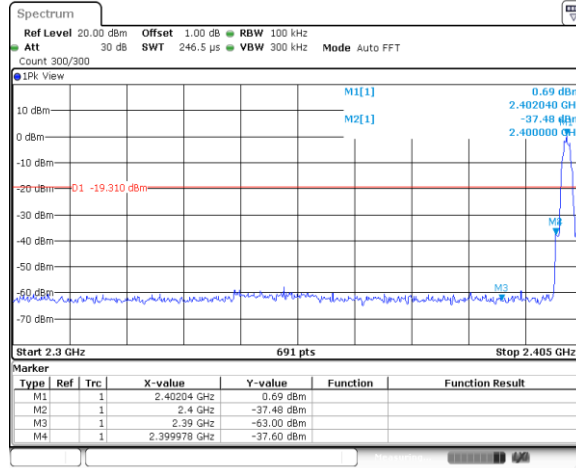

BLE 2M BT5.0 Ant1 High 2480

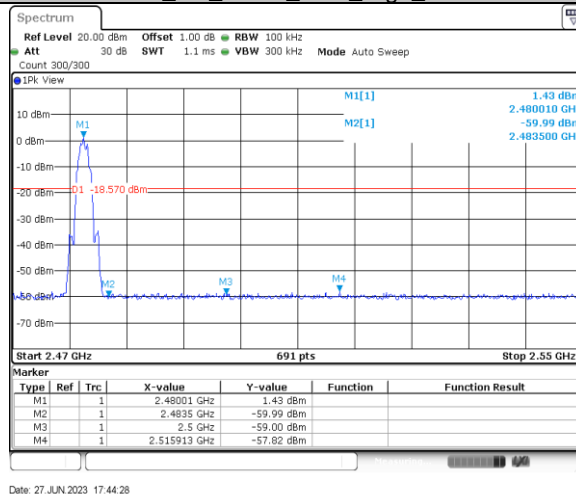

9.7 Spurious Radiated Emissions for Transmitter

Test Method

1. The EUT was placed on a turn table which is 1.5m above ground plane for above 1GHz and 0.8m above ground for below 1GHz at 3 meter chamber room for test. The table was rotated 360 degrees to determine the position of the highest radiation.
2. The EUT was set 3 meters away from the interference – receiving antenna, which was mounted on the top of a variable – height antenna tower.
3. The height of antenna is varied from one meter to four meters above the ground to determine the maximum value of the field strength. Both horizontal and vertical polarizations of the antenna are set to make the measurement.
4. For each suspected emission, the EUT was arranged to its worst case and then the antenna was tuned to heights from 1 meter to 4 meters and the rotatable table was turned from 0 degrees to 360 degrees to find the maximum reading.
5. Use the following spectrum analyzer settings According to C63.10:

For Below 1GHz

Use the following test receiver settings:

Span = wide enough to capture the peak level of the in-band emission and all spurious
 RBW = 100 KHz to 120KHz, VBW ≥ RBW for peak measurement, Sweep = auto, Detector function = peak, Trace = max hold.

For Peak unwanted emissions Above 1GHz:

Span = wide enough to capture the peak level of the in-band emission and all spurious
 RBW = 1MHz, VBW ≥ RBW for peak measurement, Sweep = auto, Detector function = peak, Trace = max hold.

Procedures for average unwanted emissions measurements above 1000 MHz

a) RBW = 1MHz.

b) VBW \ [3 × RBW].

c) Detector = RMS (power averaging), if [span / (# of points in sweep)] \ RBW / 2.

Satisfying this condition can require increasing the number of points in the sweep or reducing the span. If the condition is not satisfied, then the detector mode shall be set to peak.

d) Averaging type = power (i.e., rms) (As an alternative, the detector and averaging type may be set for linear voltage averaging. Some instruments require linear display mode to use linear voltage averaging. Log or dB averaging shall not be used.)

e) Sweep time = auto.

f) Perform a trace average of at least 100 traces if the transmission is continuous. If the transmission is not continuous, then the number of traces shall be increased by a factor of 1 / D, where D is the duty cycle. For example, with 50% duty cycle, at least 200 traces shall be averaged. (If a specific emission is demonstrated to be continuous—i.e., 100% duty cycle—then rather than turning ON and OFF with the transmit cycle, at least 100 traces shall be averaged.)

g) If tests are performed with the EUT transmitting at a duty cycle less than 98%, then a correction factor shall be added to the measurement results prior to comparing with the emission limit, to compute the emission level that would have been measured had the test been performed at 100% duty cycle. The correction factor is computed as follows:

1) If power averaging (rms) mode was used in the preceding step e), then the correction factor is [10 log (1 / D)], where D is the duty cycle. For example, if the transmit duty

cycle was 50%, then 3 dB shall be added to the measured emission levels.

2) If linear voltage averaging mode was used in the preceding step e), then the correction factor is $[20 \log (1 / D)]$, where D is the duty cycle. For example, if the transmit duty cycle was 50%, then 6 dB shall be added to the measured emission levels.

3) If a specific emission is demonstrated to be continuous (100% duty cycle) rather than turning ON and OFF with the transmit cycle, then no duty cycle correction is required for that emission (AV) at frequency above 1GHz.

Limit

The radio emission outside the operating frequency band shall be at least 20 dB below that in the 100 kHz bandwidth within the band that contains the highest level of the desired power. Radiated emissions which fall in the restricted bands, as defined in section 15.205 & RSS-GEN 8.10, must comply with the radiated emission limits specified in section 15.209 & RSS-Gen 6.13.

Frequency MHz	Field Strength $\mu\text{V/m}$	Field Strength $\text{dB}\mu\text{V/m}$	Detector	Measurement distance meters
0.009-0.490	2400/F(kHz)	48.5-13.8	AV	300
0.490-1.705	24000/F(kHz)	33.8-23.0	QP	30
1.705-30	30	29.5	QP	30
30-88	100	40	QP	3
88-216	150	43.5	QP	3
216-960	200	46	QP	3
960-1000	500	54	QP	3
Above 1000	500	54	AV	3
Above 1000	5000	74	PK	3

Note 1: Limit $3\text{m}(\text{dB}\mu\text{V/m}) = \text{Limit } 300\text{m}(\text{dB}\mu\text{V/m}) + 40\text{Log}(300\text{m}/3\text{m})$ (Below 30MHz)

Note 2: Limit $3\text{m}(\text{dB}\mu\text{V/m}) = \text{Limit } 30\text{m}(\text{dB}\mu\text{V/m}) + 40\text{Log}(30\text{m}/3\text{m})$ (Below 30MHz)

Spurious radiated emissions for transmitter

According to C63.10, if the peak (or quasi-peak) measured value complies with the average limit, it is unnecessary to perform an average measurement, so AV emission value did not show in below table if the peak value complies with average limit.

Transmitting spurious emission test result as below:

Test data_30MHz to 1000MHz

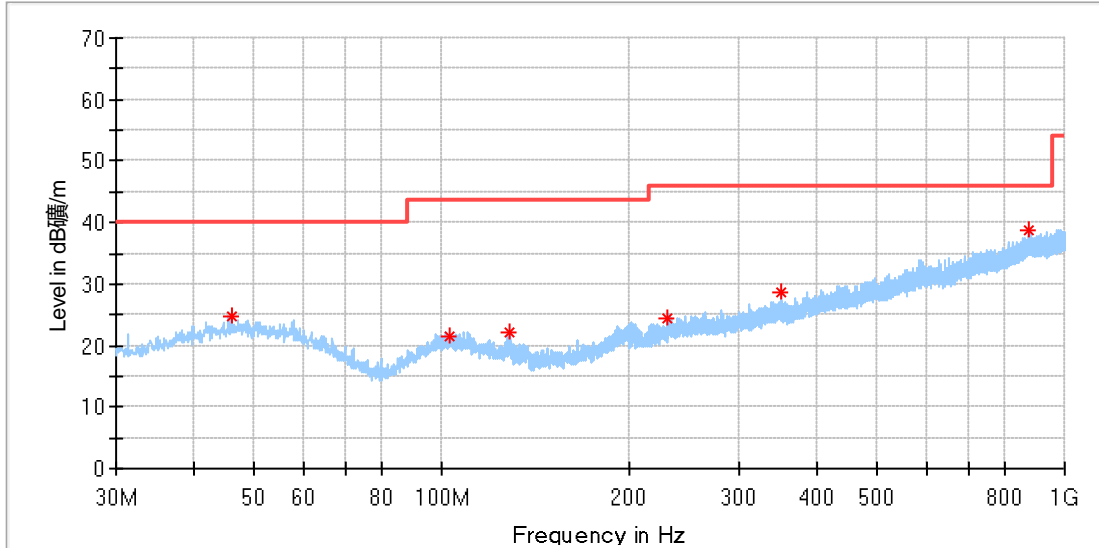

Frequency (MHz)	MaxPeak (dBµV/m)	Limit (dBµV/m)	Margin (dB)	Height (cm)	Pol	Azimuth (deg)	Corr. (dB/m)
45.883750	24.89	40.00	15.11	200.0	H	98.0	21.02
102.750000	21.64	43.50	21.86	200.0	H	39.0	18.71
128.818750	22.16	43.50	21.34	200.0	H	0.0	16.15
229.577500	24.55	46.00	21.45	100.0	H	43.0	19.30
350.342500	28.56	46.00	17.44	200.0	H	0.0	23.03
878.568125	38.75	46.00	7.25	100.0	H	131.0	32.05

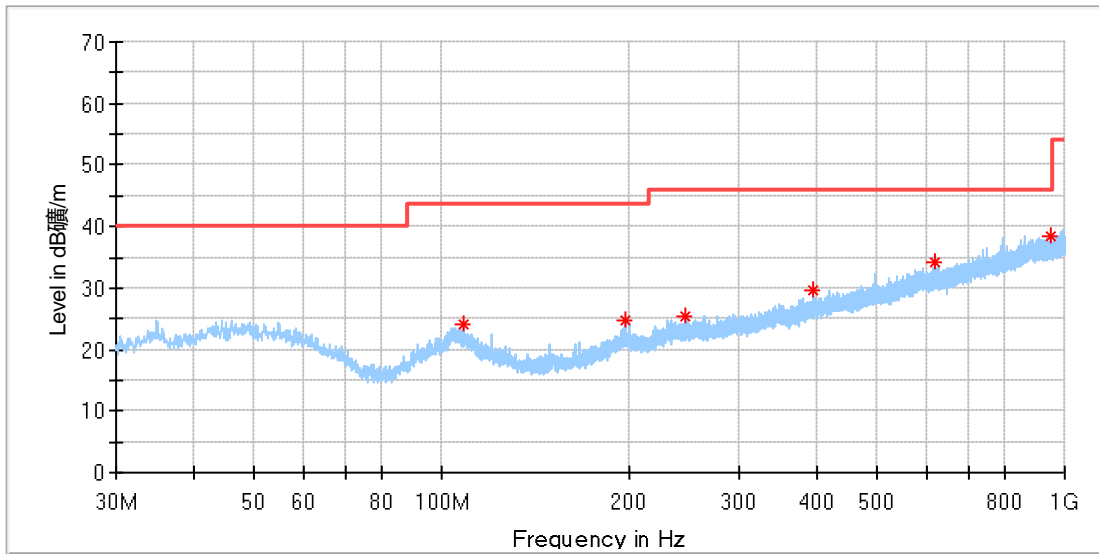

Frequency (MHz)	MaxPeak (dBµV/m)	Limit (dBµV/m)	Margin (dB)	Height (cm)	Pol	Azimuth (deg)	Corr. (dB/m)
108.206250	24.15	43.50	19.35	100.0	V	0.0	18.41
196.961250	24.70	43.50	18.80	200.0	V	0.0	19.10
246.795000	25.26	46.00	20.74	100.0	V	351.0	20.25
395.447500	29.49	46.00	16.51	200.0	V	245.0	23.90
617.698750	34.22	46.00	11.78	200.0	V	0.0	28.05
949.802500	38.31	46.00	7.69	200.0	V	215.0	32.38

Test data 1GHz to 18GHz:
BLE_1Mbps_Low Channel:

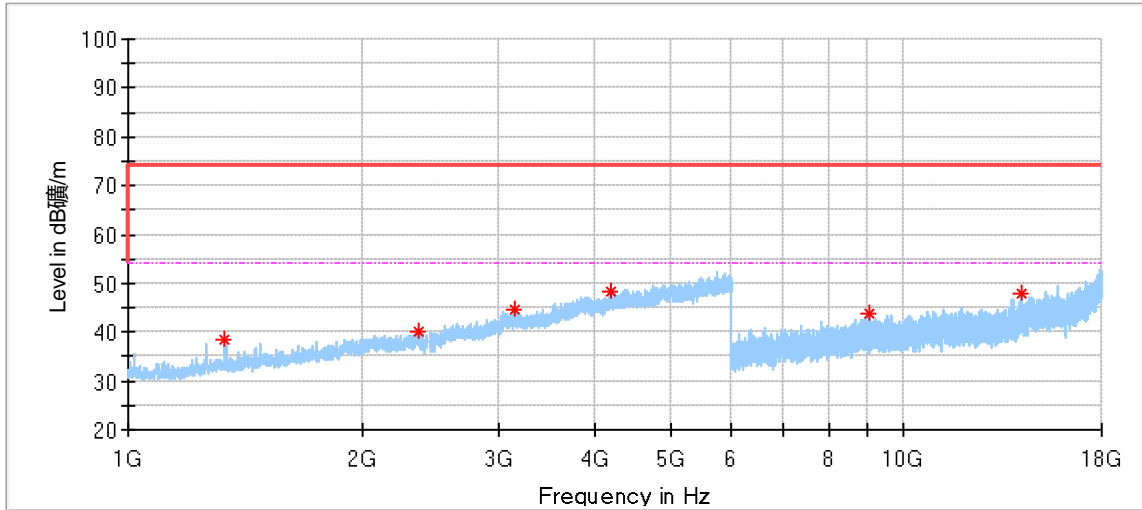

Frequency (MHz)	MaxPeak (dBµV/m)	Limit (dBµV/m)	Margin (dB)	Height (cm)	Pol	Azimuth (deg)	Corr. (dB/m)
1333.000000*	38.61	74.00	35.39	150.0	H	0.0	-10.88
2372.000000*	40.25	74.00	33.75	150.0	H	77.0	-4.95
3147.000000	44.61	74.00	29.39	150.0	H	206.0	-0.34
4194.000000*	48.45	74.00	25.55	150.0	H	118.0	3.77
9016.000000*	43.90	74.00	30.10	150.0	H	111.0	12.44
14155.500000	47.72	74.00	26.28	150.0	H	332.0	17.23

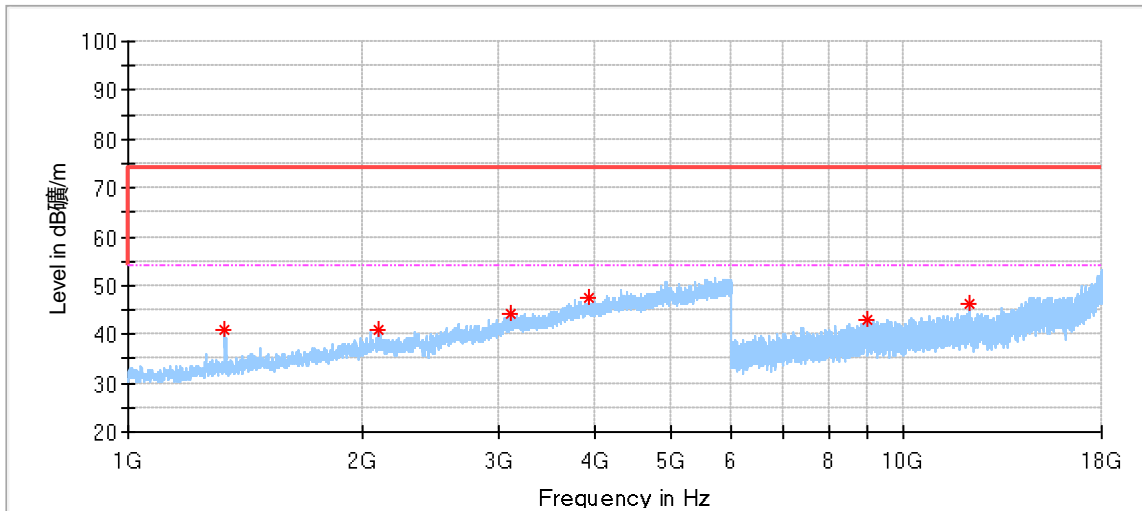

Frequency (MHz)	MaxPeak (dBµV/m)	Limit (dBµV/m)	Margin (dB)	Height (cm)	Pol	Azimuth (deg)	Corr. (dB/m)
1332.000000*	41.08	74.00	32.92	150.0	V	300.0	-10.88
2106.000000	40.95	74.00	33.05	150.0	V	177.0	-5.75
3109.000000	44.13	74.00	29.87	150.0	V	126.0	-0.58
3928.000000*	47.39	74.00	26.61	150.0	V	280.0	2.79
8997.500000	42.91	74.00	31.09	150.0	V	45.0	12.47
12174.000000*	46.40	74.00	27.60	150.0	V	287.0	15.21

BLE_1Mbps _Middle Channel:

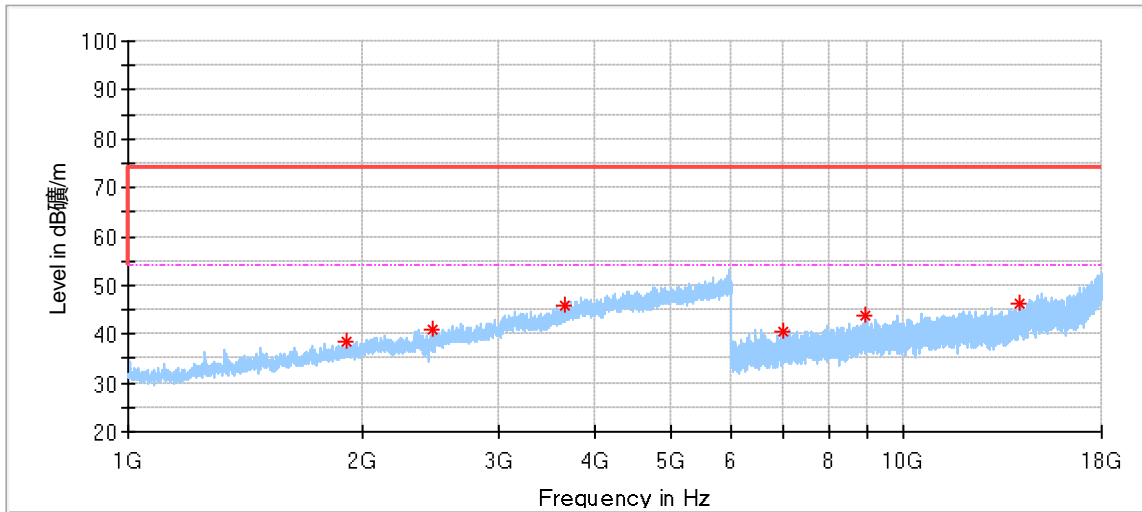

Frequency (MHz)	MaxPeak (dBµV/m)	Limit (dBµV/m)	Margin (dB)	Height (cm)	Pol	Azimuth (deg)	Corr. (dB/m)
1911.500000	38.64	74.00	35.36	150.0	H	67.0	-6.81
2475.000000	40.76	74.00	33.24	150.0	H	358.0	-4.47
3656.000000*	45.92	74.00	28.08	150.0	H	149.0	1.63
6991.500000	40.43	74.00	33.57	150.0	H	333.0	8.29
8935.500000	43.64	74.00	30.36	150.0	H	65.0	12.47
14142.500000	46.36	74.00	27.64	150.0	H	311.0	17.19

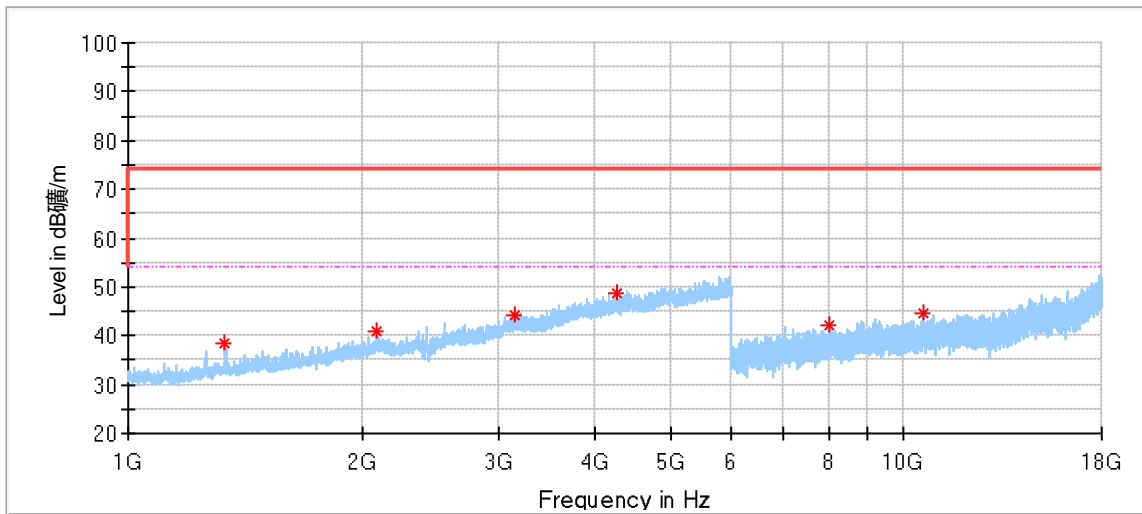

Frequency (MHz)	MaxPeak (dBµV/m)	Limit (dBµV/m)	Margin (dB)	Height (cm)	Pol	Azimuth (deg)	Corr. (dB/m)
1332.000000*	38.44	74.00	35.56	150.0	V	310.0	-10.88
2095.500000	40.79	74.00	33.21	150.0	V	341.0	-5.76
3158.000000	44.33	74.00	29.67	150.0	V	259.0	-0.32
4255.500000*	48.56	74.00	25.44	150.0	V	135.0	3.99
8025.500000*	42.05	74.00	31.95	150.0	V	356.0	10.20
10581.000000	44.62	74.00	29.38	150.0	V	26.0	13.34

BLE_1Mbps_High Channel:

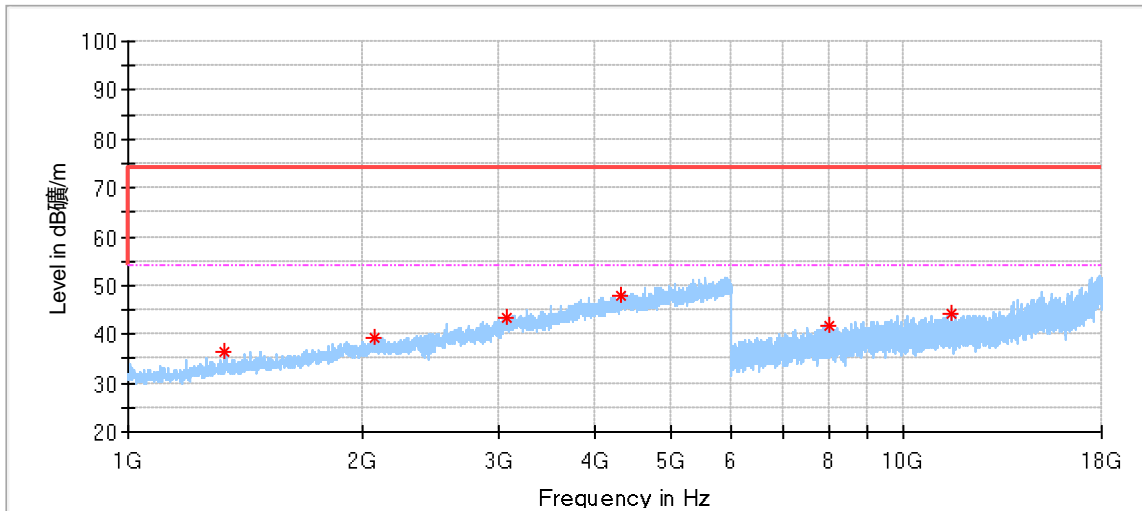

Frequency (MHz)	MaxPeak (dBµV/m)	Limit (dBµV/m)	Margin (dB)	Height (cm)	Pol	Azimuth (deg)	Corr. (dB/m)
1334.000000*	36.56	74.00	37.44	150.0	H	358.0	-10.89
2081.500000	39.14	74.00	34.86	150.0	H	189.0	-5.83
3074.500000	43.57	74.00	30.43	150.0	H	291.0	-1.01
4322.500000*	48.04	74.00	25.96	150.0	H	312.0	4.20
8008.500000	41.73	74.00	32.27	150.0	H	65.0	10.14
11536.000000*	44.30	74.00	29.70	150.0	H	7.0	14.24

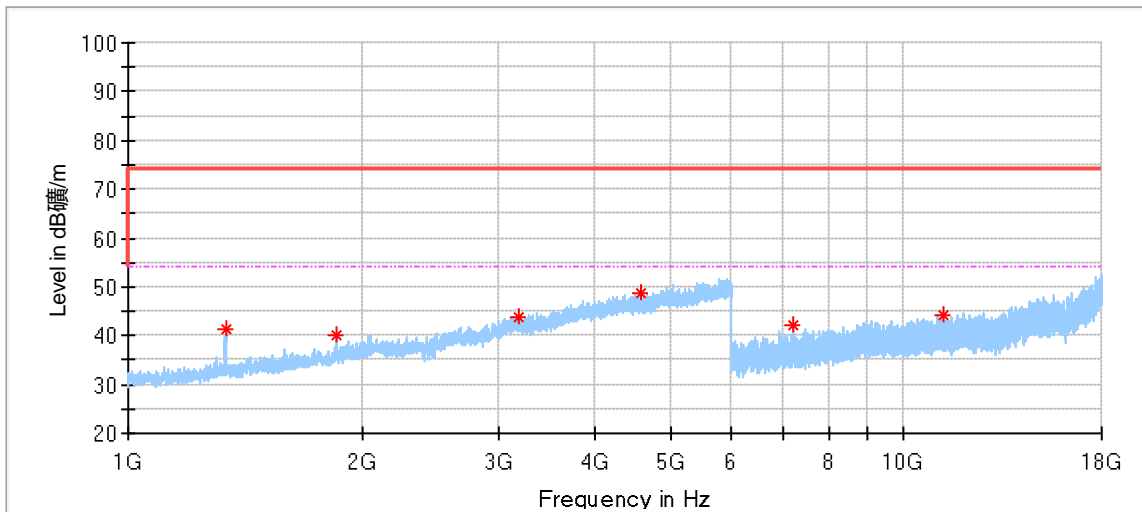

Frequency (MHz)	MaxPeak (dBµV/m)	Limit (dBµV/m)	Margin (dB)	Height (cm)	Pol	Azimuth (deg)	Corr. (dB/m)
1335.500000*	41.38	74.00	32.62	150.0	V	21.0	-10.89
1853.000000	39.94	74.00	34.06	150.0	V	321.0	-7.52
3183.000000	43.84	74.00	30.16	150.0	V	89.0	-0.34
4575.000000*	48.79	74.00	25.21	150.0	V	0.0	4.53
7202.000000	42.24	74.00	31.76	150.0	V	175.0	8.90
11235.000000*	44.39	74.00	29.61	150.0	V	334.0	14.37

BLE_2Mbps_Low Channel:

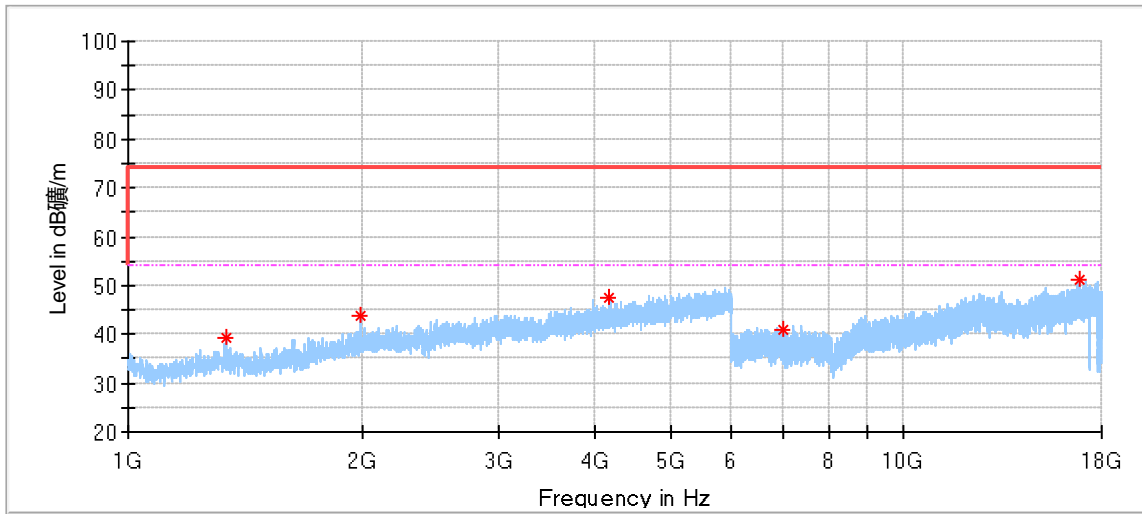

Frequency (MHz)	MaxPeak (dBµV/m)	Limit (dBµV/m)	Margin (dB)	Height (cm)	Pol	Azimuth (deg)	Corr. (dB/m)
1334.500000*	38.99	74.00	35.01	150.0	H	0.0	-10.89
2122.000000	40.05	74.00	33.95	150.0	H	218.0	-5.71
3195.500000	44.31	74.00	29.69	150.0	H	228.0	-0.36
7550.000000*	40.65	74.00	33.35	150.0	H	163.0	9.56
10611.000000*	44.81	74.00	29.19	150.0	H	104.0	13.37
14163.500000	46.79	74.00	27.21	150.0	H	354.0	17.25

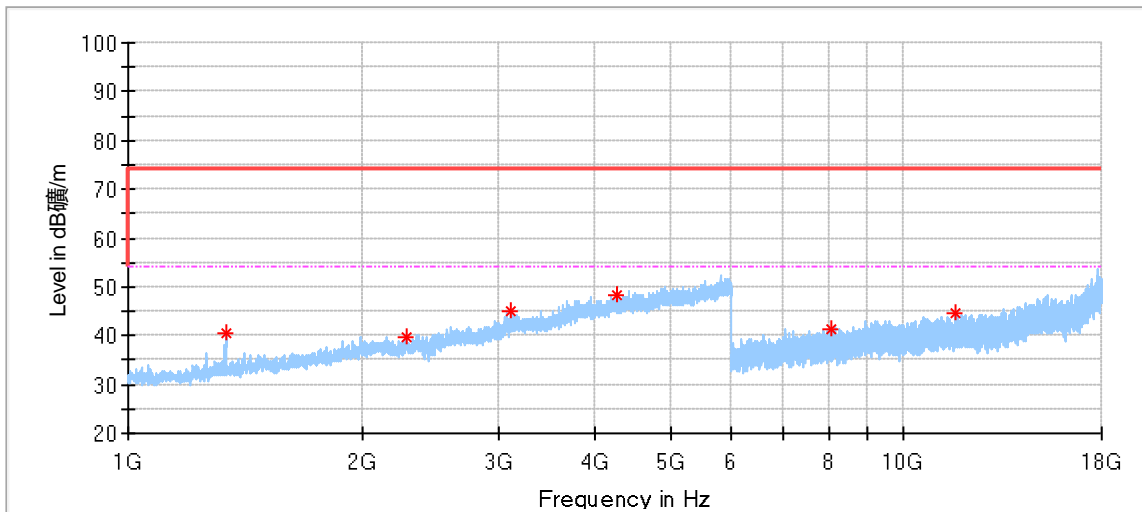

Frequency (MHz)	MaxPeak (dBµV/m)	Limit (dBµV/m)	Margin (dB)	Height (cm)	Pol	Azimuth (deg)	Corr. (dB/m)
1336.000000*	40.70	74.00	33.30	150.0	V	301.0	-10.88
2280.500000*	39.78	74.00	34.22	150.0	V	301.0	-5.63
3120.000000	44.84	74.00	29.16	150.0	V	168.0	-0.50
4273.000000*	48.39	74.00	25.61	150.0	V	230.0	3.91
8063.500000*	41.14	74.00	32.86	150.0	V	333.0	10.30
11682.500000*	44.73	74.00	29.27	150.0	V	356.0	14.96

BLE_2Mbps_Middle Channel:

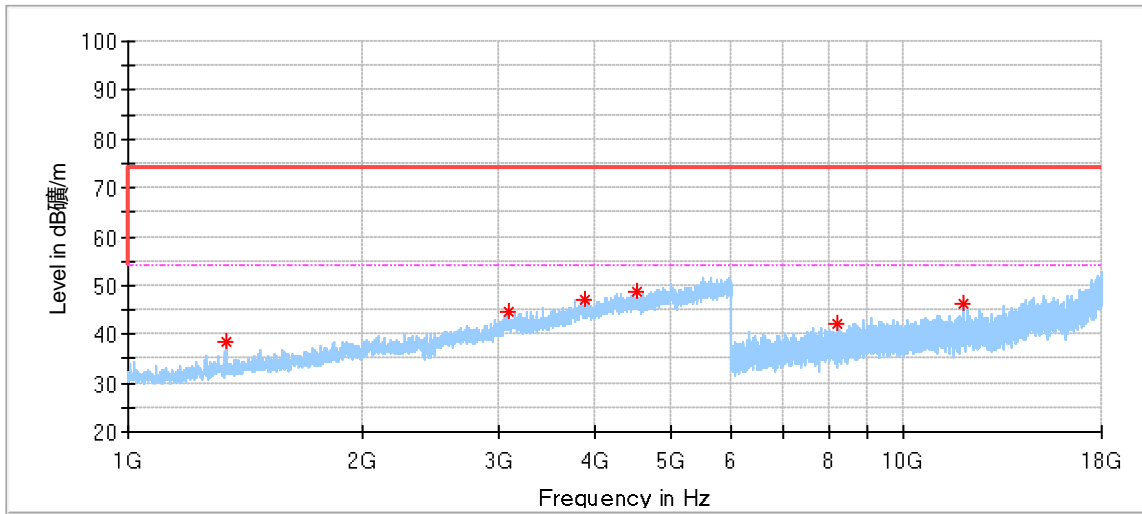

Frequency (MHz)	MaxPeak (dBµV/m)	Limit (dBµV/m)	Margin (dB)	Height (cm)	Pol	Azimuth (deg)	Corr. (dB/m)
1336.000000*	38.51	74.00	35.49	150.0	H	0.0	-10.88
3091.500000	44.68	74.00	29.32	150.0	H	52.0	-0.85
3885.000000*	47.09	74.00	26.91	150.0	H	203.0	2.87
4522.000000*	48.68	74.00	25.32	150.0	H	93.0	4.44
8186.500000*	42.12	74.00	31.88	150.0	H	241.0	10.51
11946.000000*	46.23	74.00	27.77	150.0	H	131.0	15.12

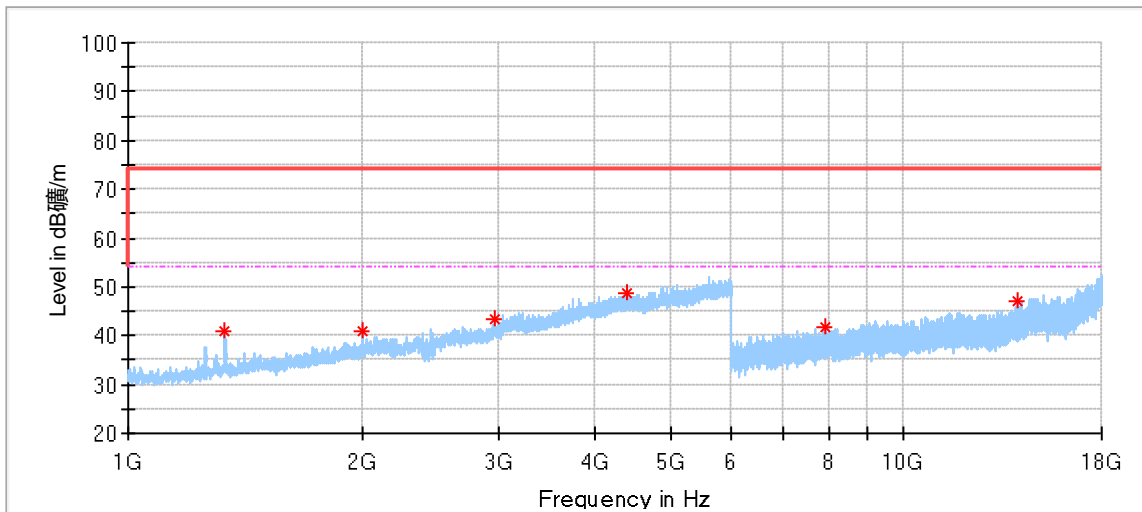

Frequency (MHz)	MaxPeak (dBµV/m)	Limit (dBµV/m)	Margin (dB)	Height (cm)	Pol	Azimuth (deg)	Corr. (dB/m)
1331.500000*	40.87	74.00	33.13	150.0	V	303.0	-10.88
2006.500000	40.89	74.00	33.11	150.0	V	272.0	-6.18
2967.500000	43.39	74.00	30.61	150.0	V	208.0	-2.18
4395.500000*	48.66	74.00	25.34	150.0	V	323.0	4.49
7926.000000	41.80	74.00	32.20	150.0	V	126.0	9.80
14037.000000	46.91	74.00	27.09	150.0	V	165.0	16.76

BLE_2Mbps_High Channel:

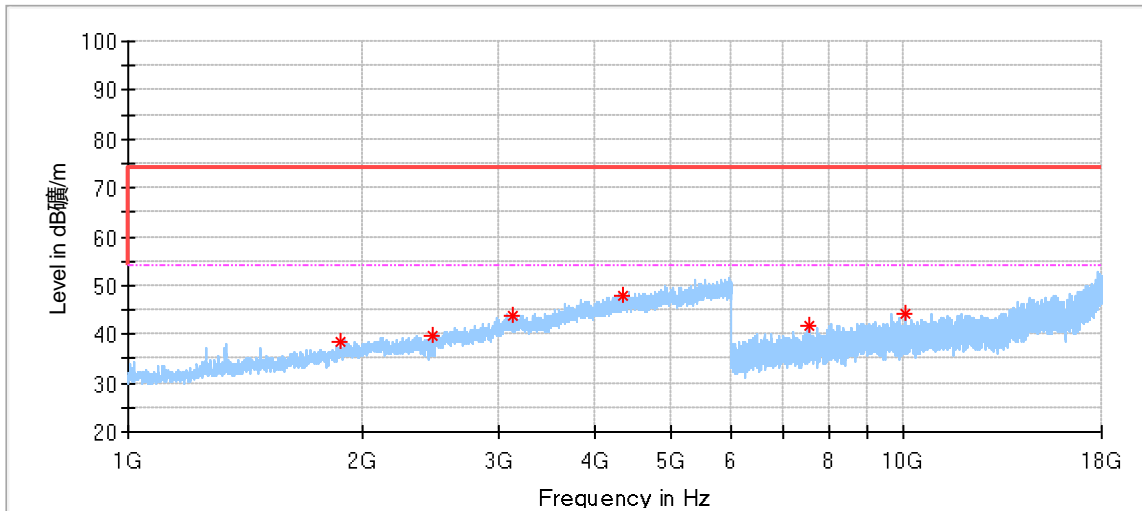

Frequency (MHz)	MaxPeak (dBµV/m)	Limit (dBµV/m)	Margin (dB)	Height (cm)	Pol	Azimuth (deg)	Corr. (dB/m)
1881.500000	38.58	74.00	35.42	150.0	H	356.0	-7.28
2473.500000	39.74	74.00	34.26	150.0	H	64.0	-4.47
3123.500000	43.73	74.00	30.27	150.0	H	270.0	-0.48
4341.000000*	47.99	74.00	26.01	150.0	H	187.0	4.30
7572.500000*	41.79	74.00	32.21	150.0	H	129.0	9.56
10048.000000	44.38	74.00	29.62	150.0	H	272.0	12.81

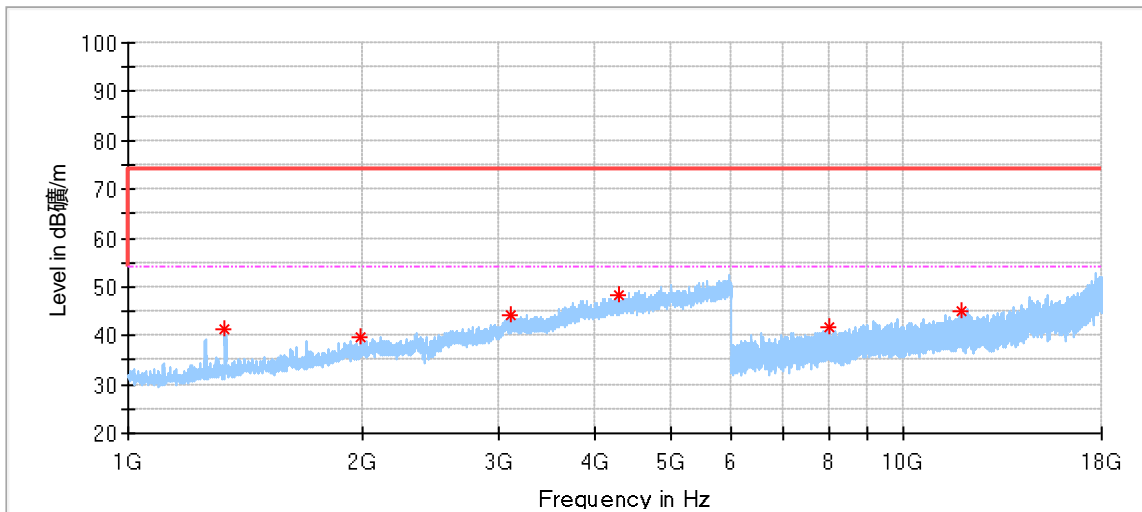

Frequency (MHz)	MaxPeak (dBµV/m)	Limit (dBµV/m)	Margin (dB)	Height (cm)	Pol	Azimuth (deg)	Corr. (dB/m)
1332.000000*	41.36	74.00	32.64	150.0	V	302.0	-10.88
1995.000000	39.77	74.00	34.23	150.0	V	329.0	-6.41
3114.500000	44.09	74.00	29.91	150.0	V	107.0	-0.54
4299.500000*	48.30	74.00	25.70	150.0	V	233.0	4.00
8009.500000	41.57	74.00	32.43	150.0	V	80.0	10.14
11862.000000*	44.97	74.00	29.03	150.0	V	356.0	14.93

Test data 18GHz to 40GHz:
BLE_1Mbps_Low Channel:

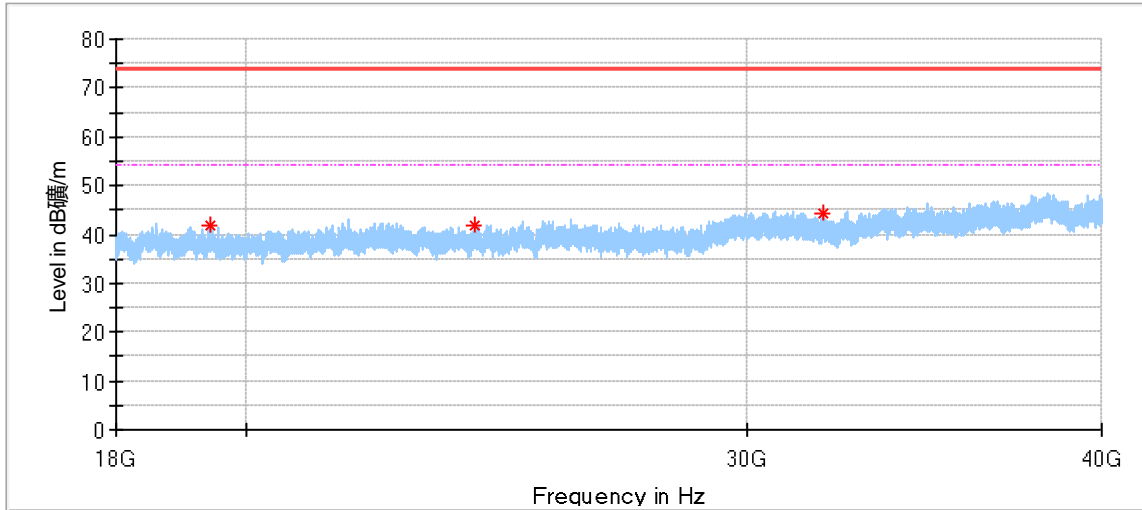

Frequency (MHz)	MaxPeak (dBµV/m)	Limit (dBµV/m)	Margin (dB)	Height (cm)	Pol	Azimuth (deg)	Corr. (dB/m)
19434.812500*	41.77	74.00	32.23	150.0	H	232.0	-2.47
24081.625000	41.81	74.00	32.19	150.0	H	263.0	0.59
31923.937500	44.28	74.00	29.72	150.0	H	16.0	1.67

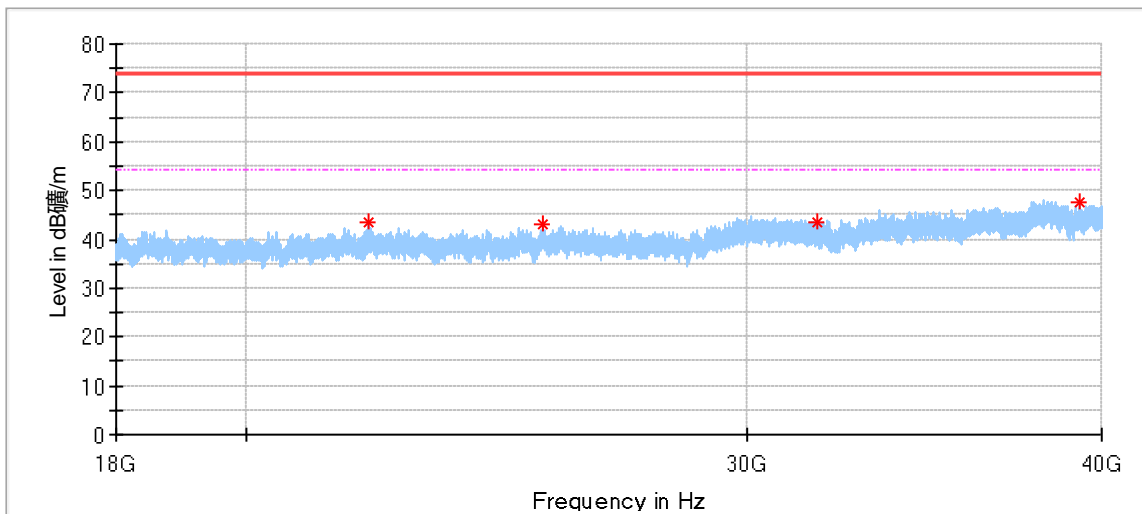

Frequency (MHz)	MaxPeak (dBµV/m)	Limit (dBµV/m)	Margin (dB)	Height (cm)	Pol	Azimuth (deg)	Corr. (dB/m)
22081.000000*	43.40	74.00	30.60	150.0	V	351.0	0.09
25414.687500	42.90	74.00	31.10	150.0	V	4.0	1.37
31781.625000*	43.68	74.00	30.32	150.0	V	111.0	1.71
39291.187500	47.44	74.00	26.56	150.0	V	351.0	6.09

BLE_1Mbps_ Middle Channel:

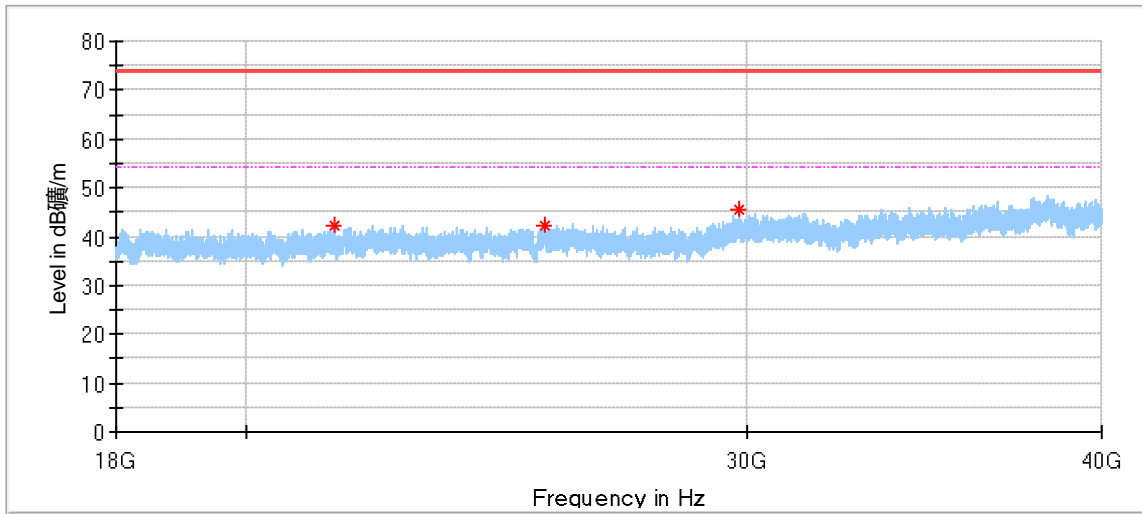

Frequency (MHz)	MaxPeak (dBµV/m)	Limit (dBµV/m)	Margin (dB)	Height (cm)	Pol	Azimuth (deg)	Corr. (dB/m)
21489.062500	42.14	74.00	31.86	150.0	H	359.0	-0.44
25462.812500	42.15	74.00	31.85	150.0	H	207.0	1.44
29832.562500	45.39	74.00	28.61	150.0	H	161.0	2.00

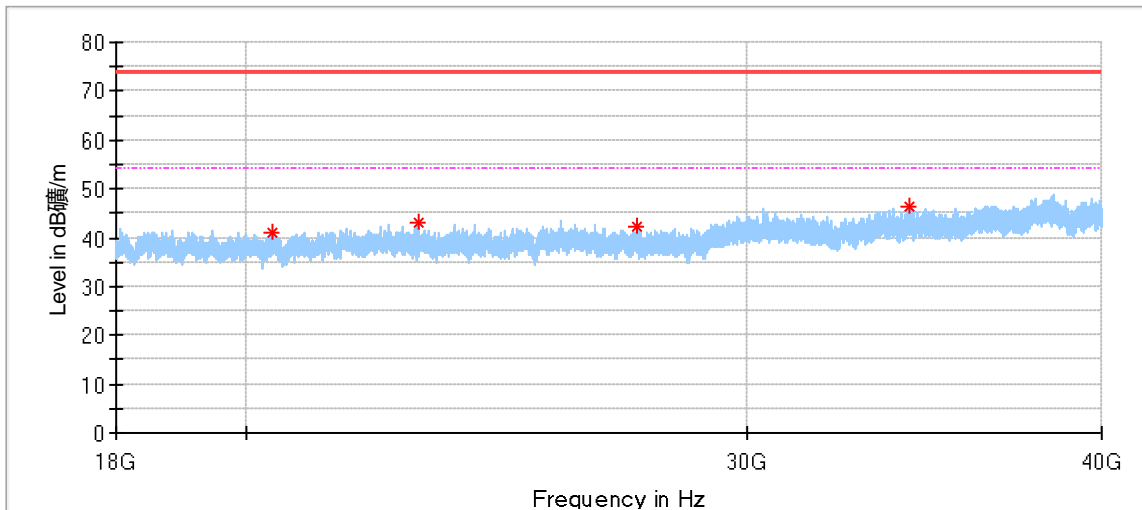

Frequency (MHz)	MaxPeak (dBµV/m)	Limit (dBµV/m)	Margin (dB)	Height (cm)	Pol	Azimuth (deg)	Corr. (dB/m)
20424.812500*	40.98	74.00	33.02	150.0	V	0.0	-1.54
22989.187500*	42.97	74.00	31.03	150.0	V	0.0	0.45
27453.812500	42.12	74.00	31.88	150.0	V	156.0	1.65
34222.250000	46.25	74.00	27.75	150.0	V	232.0	3.48

BLE_1Mbps_High Channel:

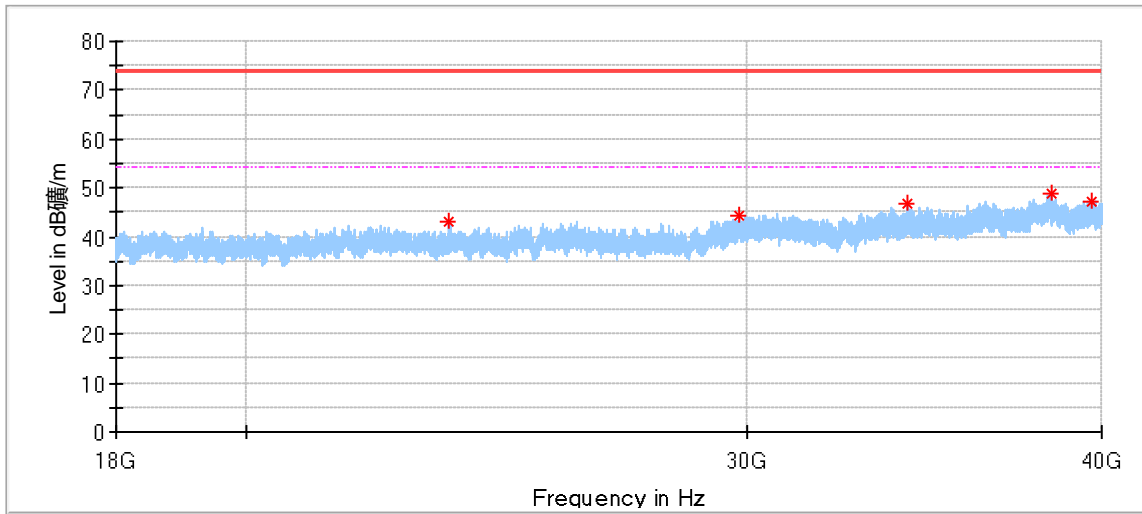

Frequency (MHz)	MaxPeak (dBµV/m)	Limit (dBµV/m)	Margin (dB)	Height (cm)	Pol	Azimuth (deg)	Corr. (dB/m)
23579.750000	43.06	74.00	30.94	150.0	H	0.0	0.30
29804.375000	44.17	74.00	29.83	150.0	H	90.0	2.00
34199.562500	46.78	74.00	27.22	150.0	H	278.0	3.43
38394.000000	48.63	74.00	25.37	150.0	H	212.0	6.57
39705.062500	47.29	74.00	26.71	150.0	H	197.0	7.58

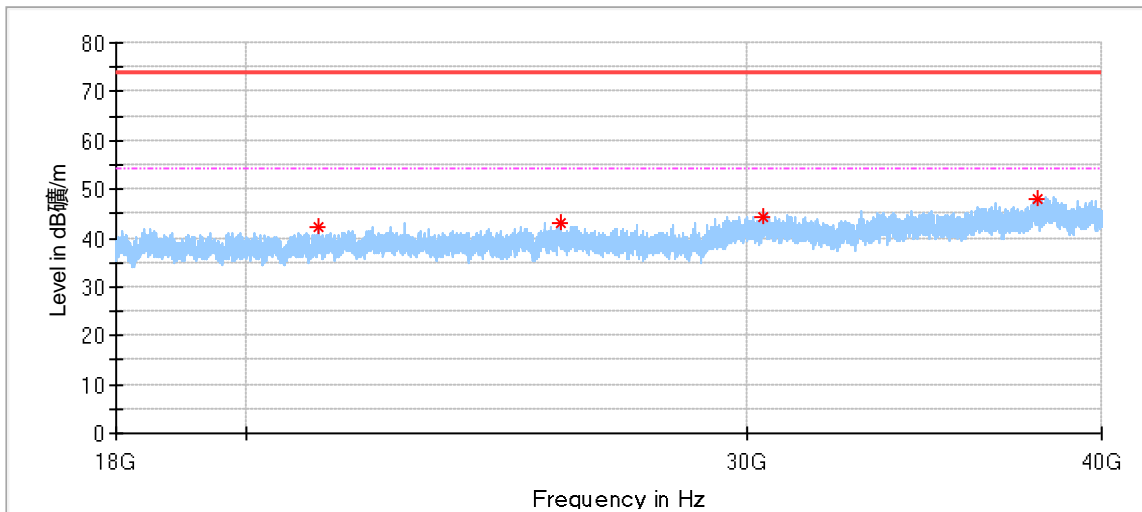

Frequency (MHz)	MaxPeak (dBµV/m)	Limit (dBµV/m)	Margin (dB)	Height (cm)	Pol	Azimuth (deg)	Corr. (dB/m)
21198.250000	42.39	74.00	31.61	150.0	V	0.0	-0.55
25810.000000	42.97	74.00	31.03	150.0	V	312.0	1.70
30418.312500	44.24	74.00	29.76	150.0	V	251.0	2.05
37966.375000	47.88	74.00	26.12	150.0	V	0.0	5.24

Remark:

- (1) “*” means the emission(s) appear within the restrict bands shall follow the requirement of section 15.205 & RSS-GEN 8.10.
- (2) Only the worst case data of mode 1Mbps within frequency range 9kHz-30MHz and 18GHz-40GHz was put in this report.
- (3) We test both rates for Low channel, Middle channel and High channel separately, only the worse case recorded in this report.
- (4) Corrected Amplitude = Read level + Corrector factor
Above 1GHz: Corrector factor = Antenna Factor + Cable Loss- Amplifier Gain
Below 1GHz: Corrector factor = Antenna Factor + Cable Loss
(The Reading Level is recorded by software which is not shown in the sheet)

10 Test Equipment List

List of Test Instruments

Radiated Emission Test(9K – 1GHz)

DESCRIPTION	MANUFACTURER	MODEL NO.	EQUIPMENT ID	SERIAL NO.	CAL INTERVAL (YEAR)	CAL. DUE DATE
EMI Test Receiver	Rohde & Schwarz	ESR 26	68-4-74-14-002	101269	1	2024-5-19
Trilog Super Broadband Test Antenna	Schwarzbeck	VULB 9163	68-4-80-14-002	707	1	2023-7-12
Loop Antenna	Rohde & Schwarz	HFH2-Z2	68-4-80-14-006	100398	1	2023-8-17
Pre-amplifier	Rohde & Schwarz	SCU 18	68-4-29-14-001	102230	1	2024-5-19
Attenuator	Mini-circuits	UNAT-6+	68-4-81-21-002	15542	1	2024-5-19
3m Semi-anechoic chamber	TDK	SAC-3 #2	68-4-90-19-006	----	2	2024-5-28
Test software	Rohde & Schwarz	EMC32	68-4-90-19-006-A01	Version10.3 5.02	N/A	N/A

Radiated Emission 2# Test(1GHz – 40GHz)

DESCRIPTION	MANUFACTURER	MODEL NO.	EQUIPMENT ID	SERIAL NO.	CAL INTERVAL (YEAR)	CAL. DUE DATE
EMI Test Receiver	Rohde & Schwarz	ESR 26	68-4-74-14-002	101269	1	2024-5-20
Wave Guide Antenna	ETS	3117	68-4-80-19-001	00218954	1	2024-4-26
Pre-amplifier	Rohde & Schwarz	SCU 18F	68-4-29-19-001	100745	1	2024-5-19
Pre-amplifier	Rohde & Schwarz	SCU 18F	68-4-29-19-002	100746	1	2024-5-19
Sideband Horn Antenna	Q-PAR	QWH-SL-18-40-K-SG	68-4-80-14-008	12827	1	2023-7-12
Pre-amplifier	Rohde & Schwarz	SCU 40A	68-4-29-14-002	100432	1	2023-7-27
Attenuator	Mini-circuits	UNAT-6+	68-4-81-21-002	15542	1	2024-5-19
3m Semi-anechoic chamber	TDK	SAC-3 #2	68-4-90-19-006	----	2	2024-5-28
Test software	Rohde & Schwarz	EMC32	68-4-90-19-006-A01	Version10.3 5.02	N/A	N/A

Conducted Emission 2# Test

DESCRIPTION	MANUFACTURER	MODEL NO.	EQUIPMENT ID	SERIAL NO.	CAL INTERVAL (YEAR)	CAL. DUE DATE
EMI Test Receiver	Rohde & Schwarz	ESR 3	68-4-74-19-002	102590	1	2024-5-19
LISN	Rohde & Schwarz	ENV216	68-4-87-19-001	102472	1	2024-5-20
Attenuator	Shanghai Huaxiang	TS2-26-3	68-4-81-16-003	080928189	1	2024-5-19
Test software	Rohde & Schwarz	EMC32	68-4-90-19-005-A01	Version10.35. 02	N/A	N/A
Shielding Room	TDK	CSR #2	68-4-90-19-005	----	3	2025-10-15

Conducted RF Test System

DESCRIPTION	MANUFACTURER	MODEL NO.	EQUIPMENT ID	SERIAL NO.	CAL INTERVAL (YEAR)	CAL. DUE DATE
Signal Analyzer	Rohde & Schwarz	FSV40	68-4-74-14-004	101030	1	2024-5-19
RF Switch Module	Rohde & Schwarz	OSP120/OS P-B157	68-4-93-14-003	101226/10085 1	1	2024-5-20
Power Splitter	Weinschel	1580	68-4-85-14-001	SC319	1	2024-5-19
10dB Attenuator	Weinschel	4M-10	68-4-81-14-003	43152	1	2024-5-19
10dB Attenuator	R&S	DNF	68-4-81-14-004	DNF-001	1	2024-5-19
10dB Attenuator	R&S	DNF	68-4-81-14-005	DNF-002	1	2024-5-19
10dB Attenuator	R&S	DNF	68-4-81-14-006	DNF-003	1	2024-5-19
10dB Attenuator	R&S	DNF	68-4-81-14-007	DNF-004	1	2024-5-19
Test software	Tonscend	System for BT/WIFI	68-4-74-14-006-A13	Version 2.6.77.0518	N/A	N/A
Shielding Room	TDK	TS8997	68-4-90-19-003	----	3	2025-10-15

11 System Measurement Uncertainty

For a 95% confidence level, the measurement expanded uncertainties for defined systems, in accordance with the recommendations of ISO 17025 were:

System Measurement Uncertainty	
Test Items	Extended Uncertainty
Uncertainty for Conducted Emission 150kHz-30MHz (for test using AMN ENV432 or ENV4200)	3.57dB
Uncertainty for Radiated Emission in 3m chamber 9kHz-30MHz	4.70dB
Uncertainty for Radiated Emission in new 3m chamber 30MHz-1000MHz	Horizontal: 4.59dB; Vertical: 4.75dB
Uncertainty for Radiated Emission in new 3m 1000MHz-18000MHz	Horizontal: 5.08dB; Vertical: 5.09dB;
Uncertainty for Radiated Emission 18000MHz-40000MHz	Horizontal: 4.52dB; Vertical: 4.51dB
Uncertainty for Conducted RF test	RF Power Conducted: 1.31dB Frequency test involved: 0.6×10^{-8} or 1%

Measurement Uncertainty Decision Rule:

Determination of conformity with the specification limits is based on the decision rule according to IEC Guide 115: 2021, clause 4.4.3 and 4.5.1.

THE END