

FCC/ISED - TEST REPORT

Report Number : **68.950.23.0606.01** Date of Issue: **2023-07-14**

Model/HVIN : **A2287**

Product Type : **Smart watch**

Applicant : **Anhui Huami Information Technology Co., Ltd.**

Address : **7/F, Building B2, Huami Global Innovation Center, No. 900,
Wangjiang West Road, High-tech Zone, Hefei City, Anhui
Pilot Free Trade Zone China**

Manufacturer : **Anhui Huami Information Technology Co., Ltd.**

Address : **7/F, Building B2, Huami Global Innovation Center, No. 900,
Wangjiang West Road, High-tech Zone, Hefei City, Anhui
Pilot Free Trade Zone China**

Test Result : **Positive** **Negative**

Total pages including Appendices : **60**

Any use for advertising purposes must be granted in writing. This technical report may only be quoted in full. This report is the result of a single examination of the object in question and is not generally applicable evaluation of the quality of other products in regular production. For further details, please see testing and certification regulation, chapter A-3.4.



1 Table of Contents

1	Table of Contents	2
2	Details about the Test Laboratory	3
3	Description of the Equipment Under Test	4
4	Summary of Test Standards	5
5	Summary of Test Results	6
6	General Remarks	7
7	Test Setups	8
8	Systems Test Configuration	10
9	Technical Requirement	11
9.1	Conducted Emission	11
9.2	Conducted Peak Output Power & EIRP	14
9.3	6dB Bandwidth and 99% Occupied Bandwidth.....	16
9.4	Power Spectral Density	23
9.5	Spurious RF Conducted Emissions	27
9.6	Band Edge Testing.....	38
9.7	Spurious Radiated Emissions for Transmitter.....	42
10	Test Equipment List.....	58
11	System Measurement Uncertainty	60

2 Details about the Test Laboratory

Details about the Test Laboratory

Test Site 1

Company name: TÜV SÜD Certification and Testing (China) Co., Ltd. Shenzhen Branch
Building 12 & 13, Zhiheng Wisdomland Business Park, Guankou Erlu,
Nantou, Nanshan District,
Shenzhen, Guangdong, China

Telephone: 86 755 8828 6998

Fax: 86 755 8828 5299

FCC Registration No.: 514049

FCC Designation Number: CN5009

IC Registration No.: 10320A

3 Description of the Equipment Under Test

Product:	Smart watch
Model no.:	A2287
Hardware Version Identification No. (HVIN)	A2287
Product Marketing Name (PMN)	A2287
Brand name:	AMAZFIT
FCC ID:	2AC8UA2287
IC:	21806-A2287
Options and accessories:	N/A
Rating:	5VDC 800mA
Battery information:	Rechargeable Li-ion Battery Model:PL412631FPC Rated:3.87VDC 475mAh/1.84Wh
RF Transmission Frequency:	2412MHz-2462MHz for 802.11b/g/n20 (Wi-Fi)
No. of Operated Channel:	11 for 802.11b/g/n20 (Wi-Fi)
Modulation:	DSSS, OFDM
Antenna Type:	Metal Case
Antenna 1	-8.09dBi
Description of the EUT:	The Equipment Under Test (EUT) is a Smart watch which support Bluetooth function and Wi-Fi operated at 2.4GHz. Only 2.4GWiFi included in this report.

NOTE 1: The above EUT's information is declared by manufacturer. Please refer to the specifications or user's manual for more detailed description.

4 Summary of Test Standards

Test Standards	
FCC Part 15 Subpart C 10-1-2021 Edition	PART 15 - RADIO FREQUENCY DEVICES Subpart C - Intentional Radiators
RSS-Gen Issue 5, April 2018 Amendment 1, March 2019 + Amendment 2, February 2021	General Requirements for Compliance of Radio Apparatus
RSS-247 Issue 2 February 2017	Digital Transmission Systems (DTSS), Frequency Hopping Systems (FHSS) and License-Exempt Local Area Network (LE-LAN) Devices

All the test methods were according to KDB 558074 D01 15.247 Meas Guidance v05r02 Measurement Guidance and ANSI C63.10 (2013).

5 Summary of Test Results

Technical Requirements					
FCC Part 15 Subpart C/ RSS-247 Issue 2/RSS-Gen Issue 5					
Test Condition		Test Site	Test Result		
			Pass	Fail	N/A
§15.207 & RSS-GEN 8.8	Conducted emission AC power port	Site 1	<input checked="" type="checkbox"/>	<input type="checkbox"/>	<input type="checkbox"/>
§15.247 (b) (3) & RSS-247 5.4(d)	Conducted peak output power	Site 1	<input checked="" type="checkbox"/>	<input type="checkbox"/>	<input type="checkbox"/>
RSS-247 5.4(d)	Equivalent Isotropic Radiated Power	Site 1	<input checked="" type="checkbox"/>	<input type="checkbox"/>	<input type="checkbox"/>
§15.247(a)(2) & RSS-247 5.2(a) & RSS-GEN 6.7	6dB bandwidth and 99% Occupied Bandwidth	Site 1	<input checked="" type="checkbox"/>	<input type="checkbox"/>	<input type="checkbox"/>
§15.247(e) & RSS-247 5.2(b)	Power spectral density	Site 1	<input checked="" type="checkbox"/>	<input type="checkbox"/>	<input type="checkbox"/>
§15.247(d) & RSS-247 5.5	Spurious RF conducted emissions	Site 1	<input checked="" type="checkbox"/>	<input type="checkbox"/>	<input type="checkbox"/>
§15.247(d) & RSS-247 5.5	Band edge	Site 1	<input checked="" type="checkbox"/>	<input type="checkbox"/>	<input type="checkbox"/>
§15.247(d) & §15.209 & §15.205 & RSS-247 5.5 & RSS-Gen 6.13	Spurious radiated emissions for transmitter	Site 1	<input checked="" type="checkbox"/>	<input type="checkbox"/>	<input type="checkbox"/>
§15.203 & RSS-Gen 6.8	Antenna requirement	See note 2	<input checked="" type="checkbox"/>	<input type="checkbox"/>	<input type="checkbox"/>

Note 1: N/A=Not Applicable.

Note 2: The EUT uses a metal case antenna, which gain are -8.09dBi. In accordance to §15.203 & RSS-Gen 6.8, it is considered sufficiently to comply with the provisions of this section.

6 General Remarks

Remarks

This submittal(s) (test report) is intended for FCC ID: 2AC8UA2287, IC: 21806-A2287, complies with Section 15.207, 15.209, 15.247 of the FCC Part 15, Subpart C rules and RSS-247, RSS-GEN.

SUMMARY:

All tests according to the regulations cited on page 5 were

■ - Performed

□ - **Not** Performed

The Equipment Under Test

■ - **Fulfills** the general approval requirements.

□ - **Does not** fulfill the general approval requirements.

Sample Received Date: 2023-06-21

Testing Start Date: 2023-06-21

Testing End Date: 2023-07-06

TÜV SÜD Certification and Testing (China) Co., Ltd. Shenzhen Branch

Reviewed by:

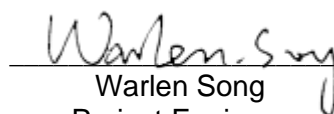

John Zhi
Section Manager

Prepared by:

Warlen Song
Project Engineer

Tested by:

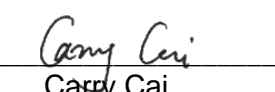

Carry Cai
Test Engineer

7 Test Setups

7.1 AC Power Line Conducted Emission test setups

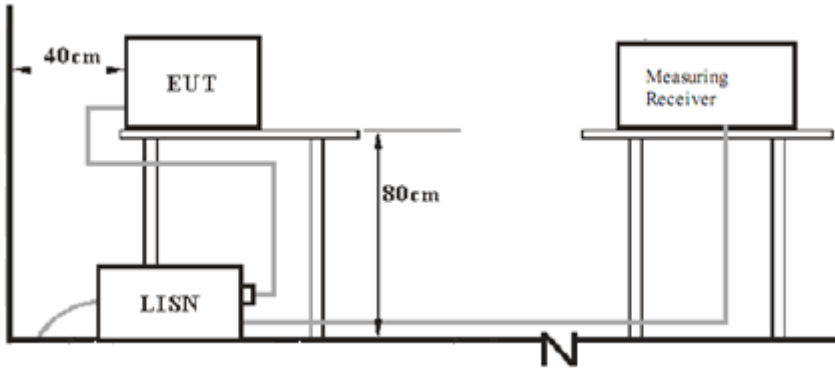

7.2 Radiated test setups

9KHz - 30MHz

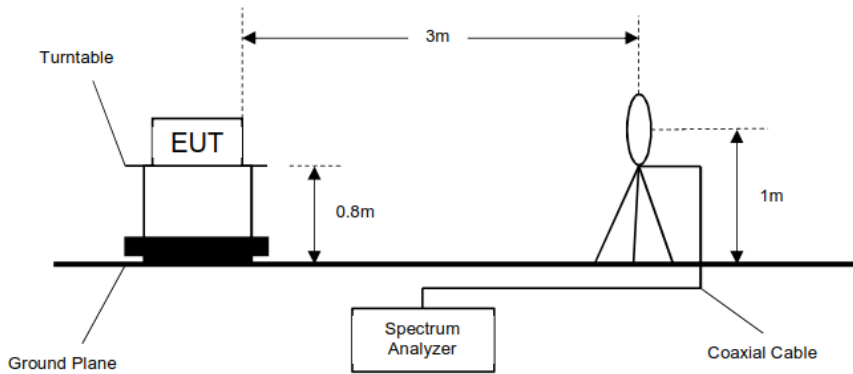

30MHz - 1GHz

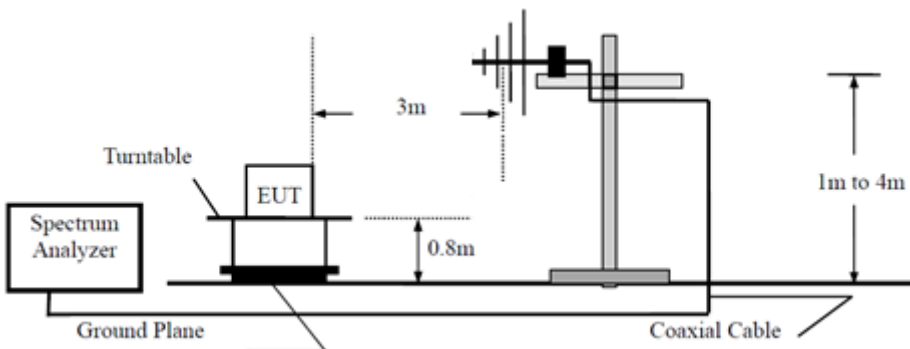

Above 1GHz

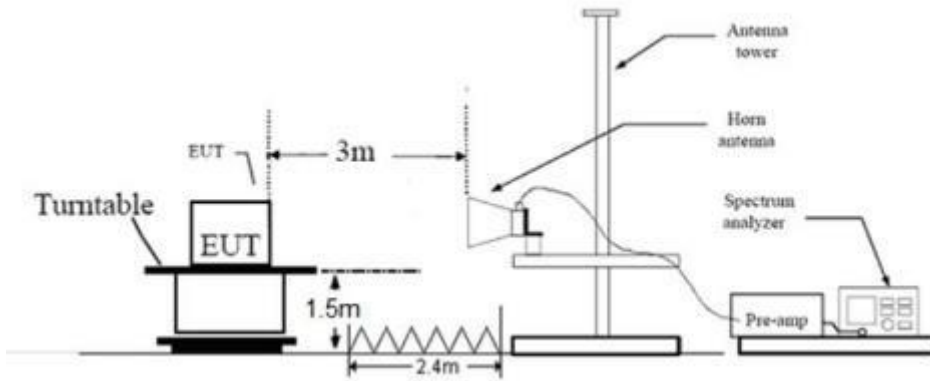

7.3 Conducted RF test setups

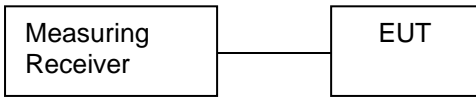

8 Systems Test Configuration

Auxiliary Equipment Used during Test:

Description	Manufacturer	Model NO.	S/N
Adapter	Apple	A1443	---
Notebook	LENOVO	X220	---

Cables Used During Test:

Cable	Length	Shielded/unshielded	With / without ferrite
---	---	---	---

Test software information:

Test Software Version	sscom5.13.1		
Mode	Setting TX Power	Packet Type	
802.11b	18	DSSS	
802.11g	17	OFDM	
802.11n20	14	OFDM	

The system was configured to non-hopping mode.

Non-hopping mode: The system was configured to operate at a signal channel transmitting. The test software allows the configuration and operation at the worst-case duty and the highest transmit power.

Through pre-scan all kind of modulation and all kind of rates, find the 1Mbps of rate is the worst case of 802.11b; the 6Mbps of rate is the worst case of 802.11g; the 6.5Mbps of rate is the worst case of 802.11n20, only the worst case transmitter rate data mode in recorded in the report.

9 Technical Requirement

9.1 Conducted Emission

Test Method

1. The EUT was placed 0.4 meter from the conducting wall of the shielding room was kept at least 80 centimeters from any other grounded conducting surface.
2. Connect EUT to the power mains through a line impedance stabilization network (LISN).
3. All the support units are connecting to the other LISN.
4. The LISN provides 50 ohm coupling impedance for the measuring instrument.
5. Both sides of AC line were checked for maximum conducted interference.
6. The frequency range from 150 kHz to 30 MHz was searched.
7. Set the test-receiver system to Peak Detect Function and specified bandwidth (IF Bandwidth = 9kHz) with Maximum Hold Mode. Then measurement is also conducted by Average Detector and Quasi-Peak Detector Function respectively.

Limit

According to §15.207 & RSS-GEN 8.8, Conducted emissions limit as below:

Frequency MHz	QP Limit dB μ V	AV Limit dB μ V
0.150-0.500	66-56*	56-46*
0.500-5	56	46
5-30	60	50

Decreasing linearly with logarithm of the frequency

Conducted Emission

Product Type : Smart watch
 M/N : A2287
 Operating Condition : Transmit
 Test Specification : Line
 Comment : AC 120V/60Hz

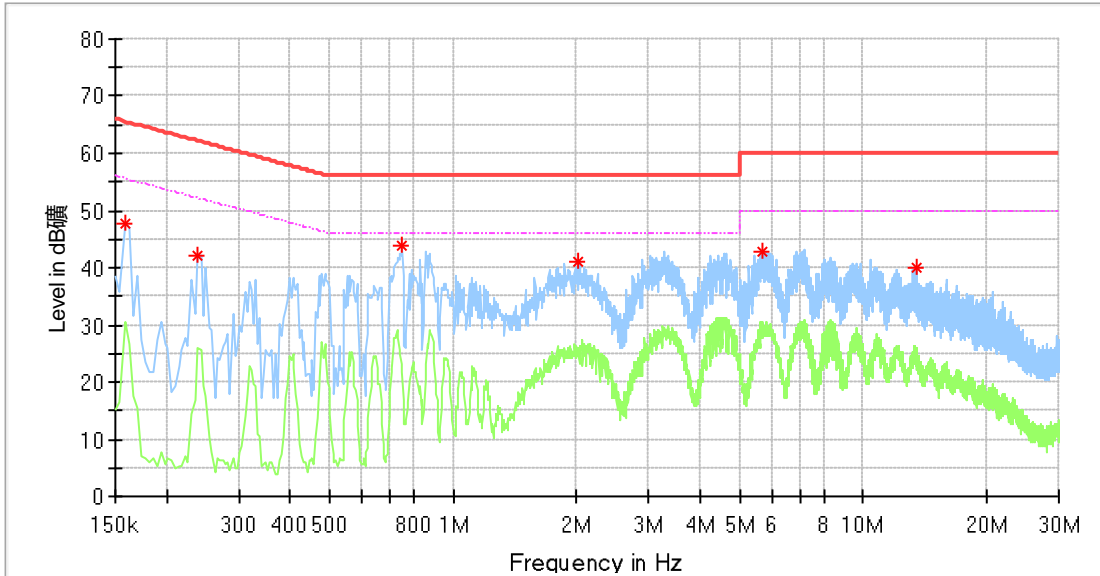

Frequency (MHz)	MaxPea* (dBµV)	Average* (dBµV)	Limit (dBµV)	Margin (dB)	Line	Corr. ** (dB)
0.158000	47.57	---	65.57	18.00	L1	10.33
0.238000	41.98	---	62.17	20.19	L1	10.34
0.750000	43.97	---	56.00	12.03	L1	10.36
2.026000	41.16	---	56.00	14.84	L1	10.41
5.690000	42.79	---	60.00	17.21	L1	10.61
13.458000	39.92	---	60.00	20.08	L1	10.93

Remark:

*Level=Reading Level + Correction Factor

**Correction Factor=Cable Loss + LISN Factor

(The Reading Level is recorded by software which is not shown in the sheet)

Conducted Emission

Product Type : Smart watch
 M/N : A2287
 Operating Condition : Transmit
 Test Specification : Neutral
 Comment : AC 120V/60Hz

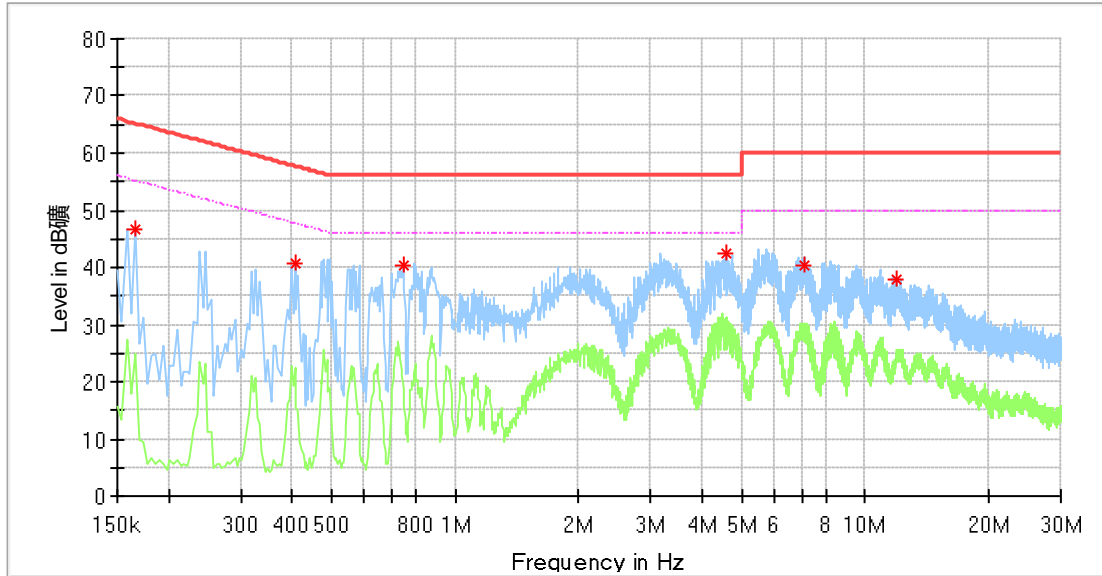

Frequency (MHz)	MaxPeak* (dBµV)	Averag* (dBµV)	Limit (dBµV)	Margin (dB)	Line	Corr. ** (dB)
0.166000	46.80	---	65.16	18.36	N	10.37
0.406000	40.68	---	57.73	17.05	N	10.45
0.746000	40.48	---	56.00	15.52	N	10.49
4.574000	42.61	---	56.00	13.39	N	10.71
7.078000	40.27	---	60.00	19.73	N	10.81
11.926000	38.00	---	60.00	22.00	N	11.06

Remark:

*Level=Reading Level + Correction Factor

**Correction Factor=Cable Loss + LISN Factor

(The Reading Level is recorded by software which is not shown in the sheet)

9.2 Conducted Output Power & EIRP

Test Method

- 1) The EUT is configured to transmit continuously, or to transmit with a constant duty cycle.
- 2) At all times when the EUT is transmitting, it shall be transmitting at its maximum power control level.
- 3) The integration period of the power meter exceeds the repetition period of the transmitted signal by at least a factor of five.
- 4) Measure the peak power of the transmitter. This measurement is a peak over both the ON and OFF periods of the transmitter.

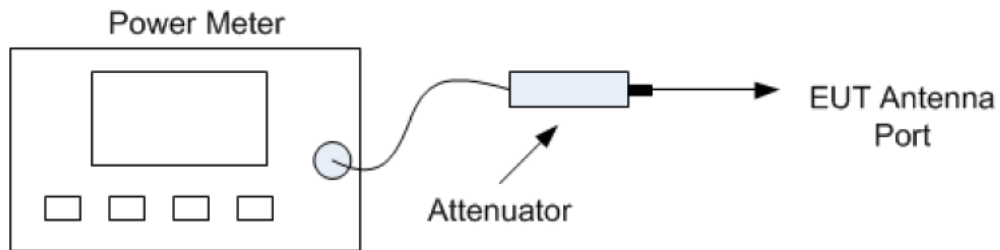

Power meter conducted test setup

Limits

According to §15.247 (b) (3) & RSS-247 5.4(d), conducted peak output power limit as below:

Frequency Range MHz	Limit W	Limit dBm
2400-2483.5	≤1	≤30

According to & RSS-247 5.4(d), EIRP limit as below:

Frequency Range MHz	Limit W	Limit dBm
2400-2483.5	≤4	≤36

Test result as below table

802.11b modulation Test Result

Frequency (MHz)	Conducted Peak Output Power (dBm)	Antenna Gain (dBi)	EIRP (dBm)	Result
Low channel 2412MHz	15.7	-8.09	7.61	Pass
Middle channel 2437MHz	15.5	-8.09	7.41	Pass
High channel 2462MHz	15.8	-8.09	7.71	Pass

802.11g modulation Test Result

Frequency (MHz)	Conducted Peak Output Power (dBm)	Antenna Gain (dBi)	EIRP (dBm)	Result
Low channel 2412MHz	14.8	-8.09	6.71	Pass
Middle channel 2437MHz	14.7	-8.09	6.61	Pass
High channel 2462MHz	14.9	-8.09	6.81	Pass

802.11n20 modulation Test Result

Frequency (MHz)	Conducted Peak Output Power (dBm)	Antenna Gain (dBi)	EIRP (dBm)	Result
Low channel 2412MHz	14.6	-8.09	6.51	Pass
Middle channel 2437MHz	14.5	-8.09	6.41	Pass
High channel 2462MHz	14.6	-8.09	6.51	Pass

9.3 6dB Bandwidth and 99% Occupied Bandwidth

Test Method for 6 dB Bandwidth

1. The RF output of EUT was connected to the spectrum analyzer. The path loss was compensated to the results for each measurement.
2. Set to the maximum power setting, the instrument center frequency is set to the nominal EUT channel center frequency enable the EUT transmit continuously.
3. Use the following spectrum analyzer settings:
RBW=100KHz, VBW≥3RBW, Sweep = auto, Detector function = peak, Trace = max hold
4. Use the automatic bandwidth measurement capability of an instrument, use the X dB bandwidth mode with X set to 6 dB.
5. Allow the trace to stabilize, record the 6 dB Bandwidth value.

Test Method for 99 % Bandwidth

1. Connect EUT test port to spectrum analyzer.
Use the following spectrum analyzer settings:
RBW=1% to 5% of the actual occupied, VBW≥3RBW, Sweep = auto, Detector function = peak, Trace = max hold
2. Use the occupied bandwidth measurement capability of test receiver.
3. Allow the trace to stabilize, record the occupied bandwidth value.

Limit

6dB bandwidth Limit [kHz]	99% bandwidth Limit [kHz]
≥500	--

802.11b modulation Test Result

Frequency (MHz)	6dB bandwidth (MHz)	99% bandwidth (MHz)	Limit (MHz)	Result
Low channel 2412MHz	9.080	11.868	0.5	Pass
Middle channel 2437MHz	8.600	11.908	0.5	Pass
High channel 2462MHz	8.160	11.868	0.5	Pass

802.11g modulation Test Result

Frequency (MHz)	6dB bandwidth (MHz)	99% bandwidth (MHz)	Limit (MHz)	Result
Low channel 2412MHz	15.200	17.223	0.5	Pass
Middle channel 2437MHz	15.520	17.383	0.5	Pass
High channel 2462MHz	15.800	17.223	0.5	Pass

802.11n-HT20 modulation Test Result

Frequency (MHz)	6dB bandwidth (MHz)	99% bandwidth (MHz)	Limit (MHz)	Result
Low channel 2412MHz	15.200	18.222	0.5	Pass
Middle channel 2437MHz	15.760	18.382	0.5	Pass
High channel 2462MHz	16.040	18.182	0.5	Pass

6 dB Bandwidth

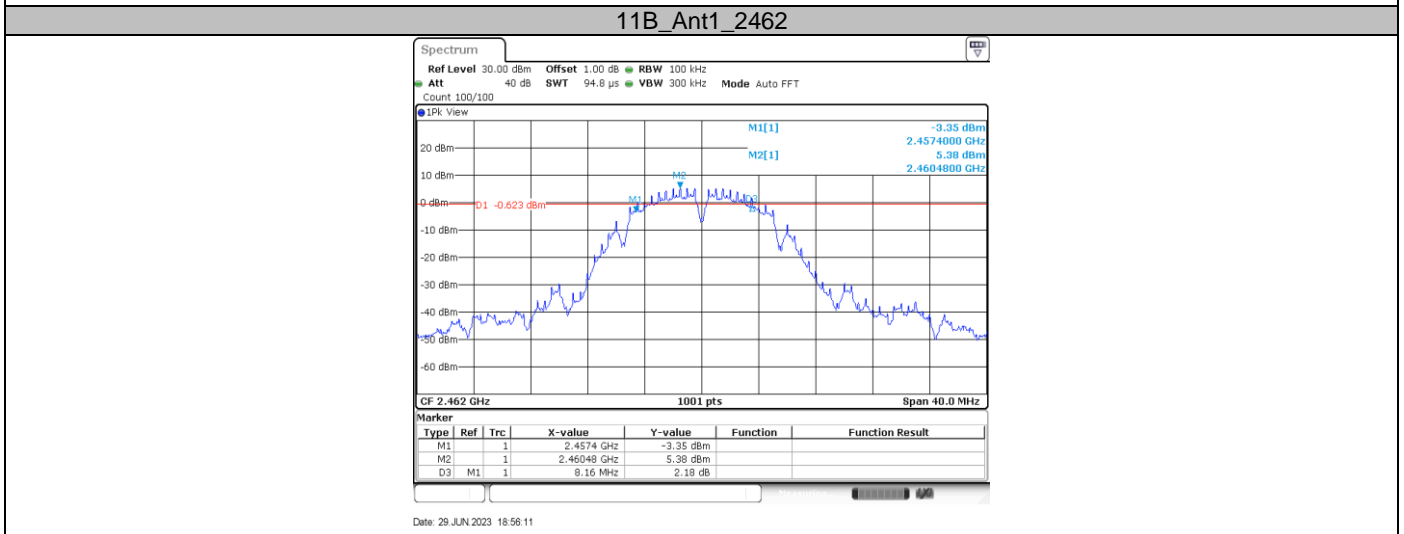
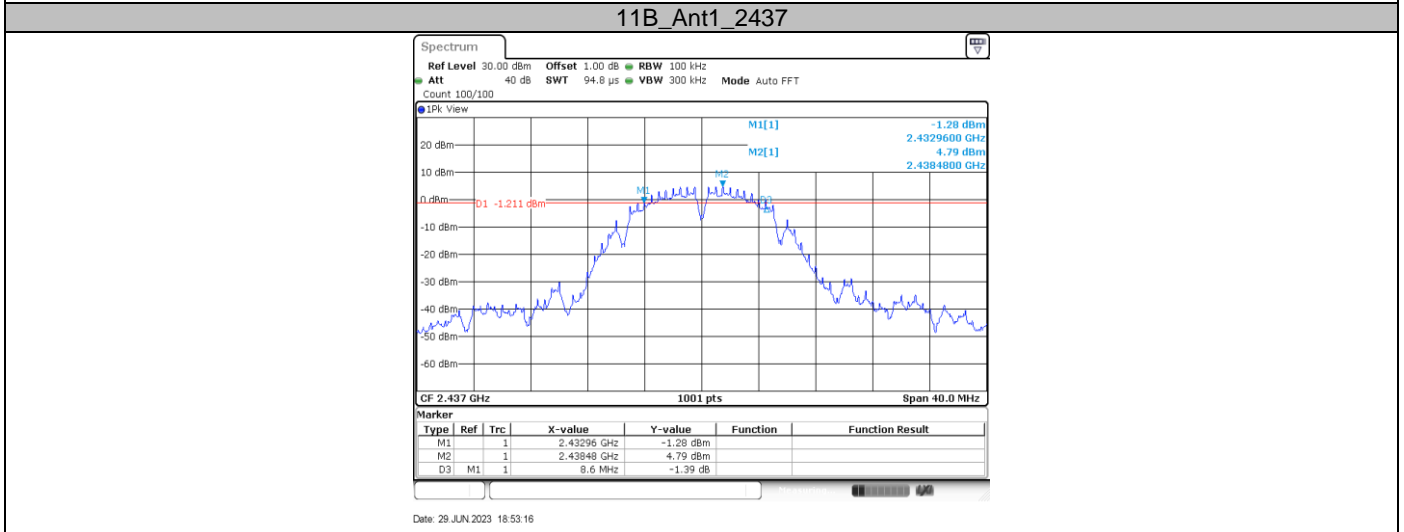
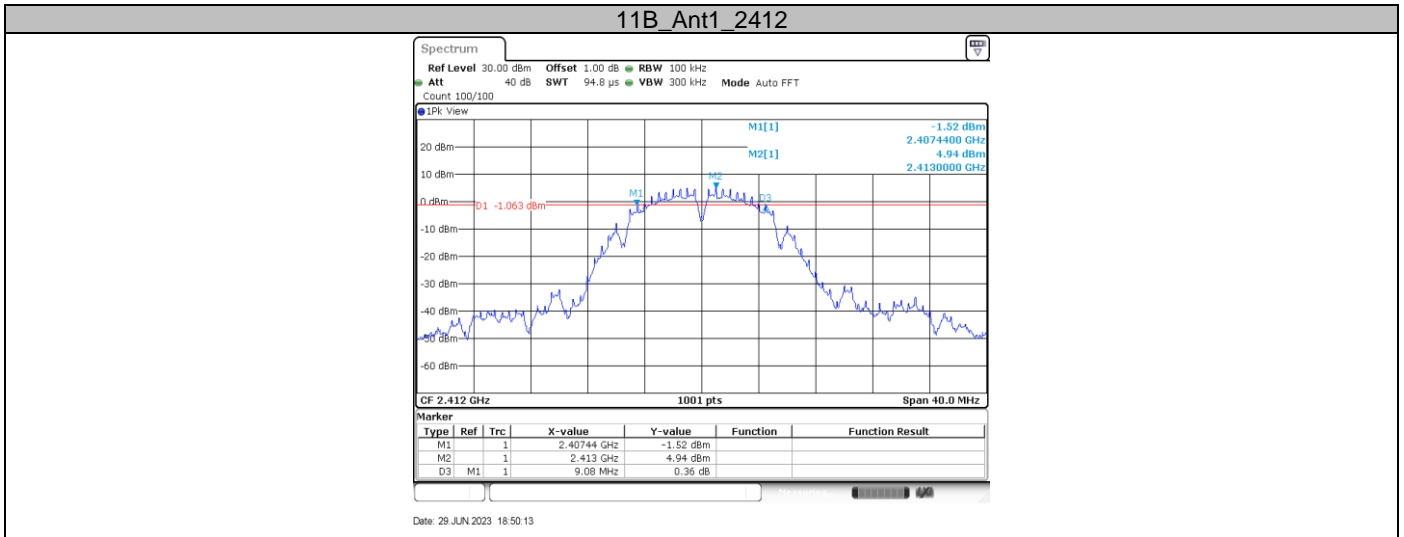

11G_Ant1_2412

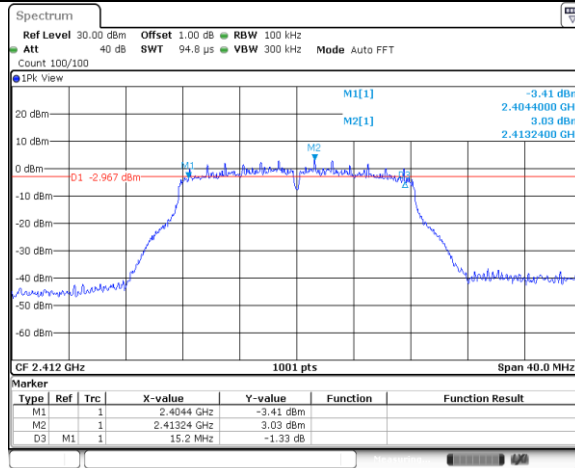

Date: 29 JUN 2023 18:59:18

11G_Ant1_2437

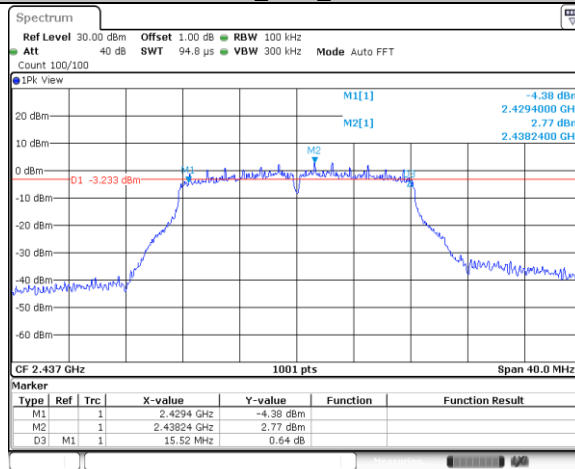

Date: 29 JUN 2023 19:02:36

11G_Ant1_2462

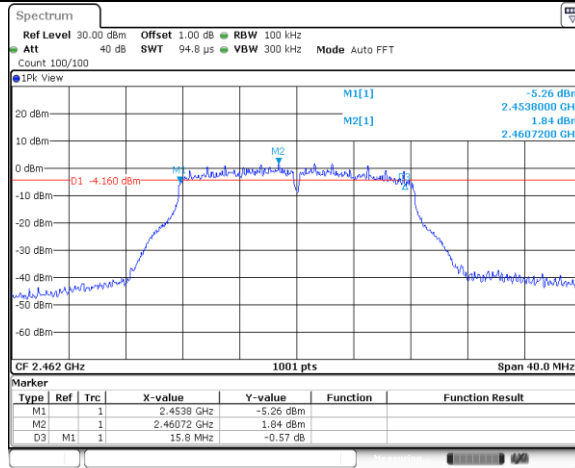

Date: 29 JUN 2023 19:12:55

11N20SISO_Ant1_2412

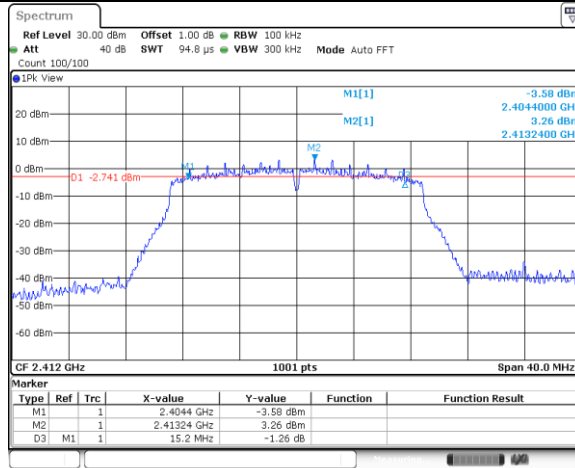

Date: 29 JUN 2023 19:16:22

11N20SISO_Ant1_2437

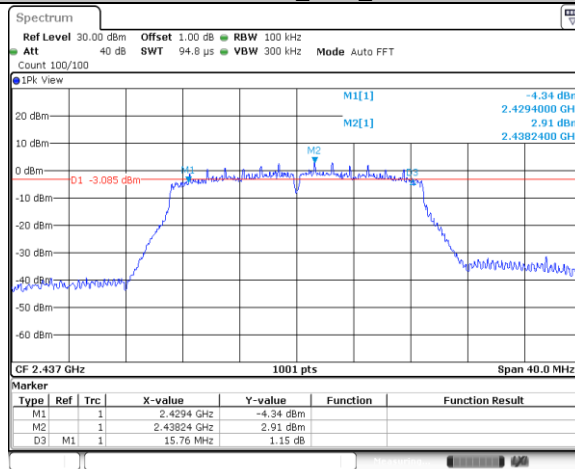

Date: 29 JUN 2023 19:19:31

11N20SISO_Ant1_2462

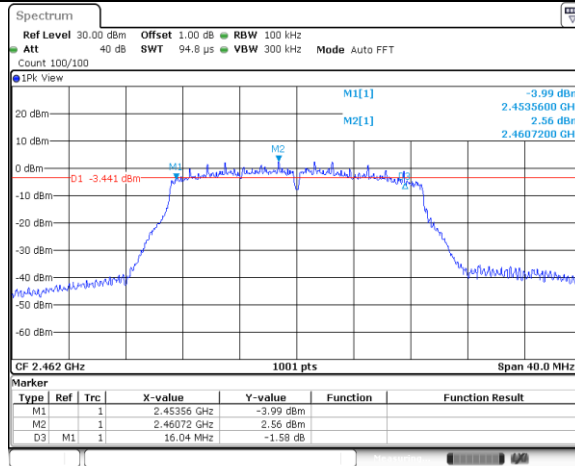

Date: 29 JUN 2023 19:21:18

99% Bandwidth

11B_Ant1_2412

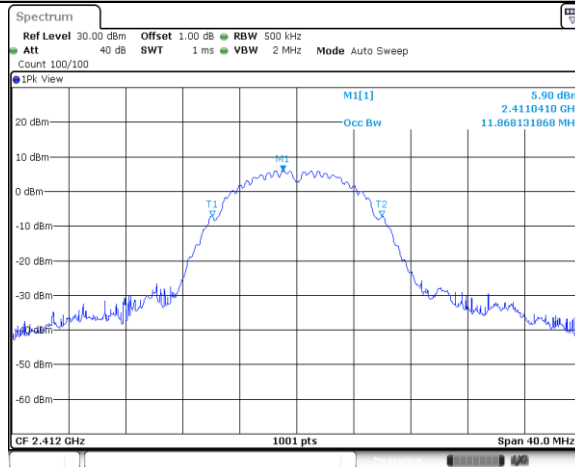

Date: 29 JUN 2023 18:50:24

11B_Ant1_2437

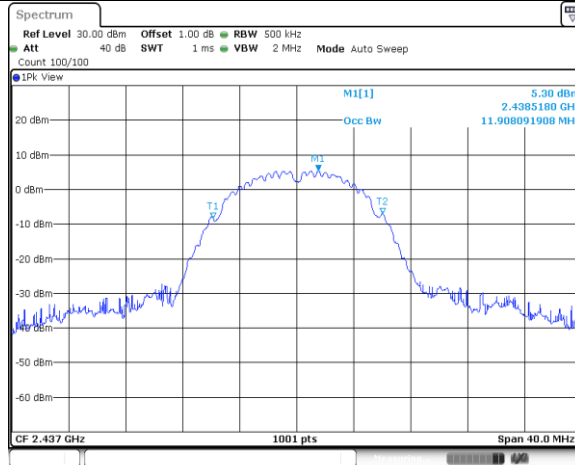

Date: 29 JUN 2023 18:53:27

11B_Ant1_2462

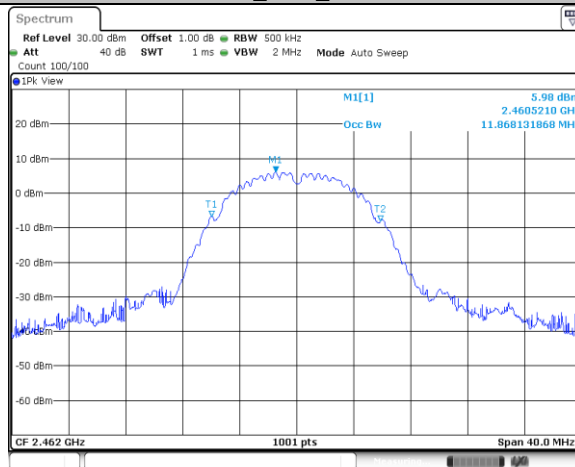

Date: 29 JUN 2023 18:58:22

11G_Ant1_2412

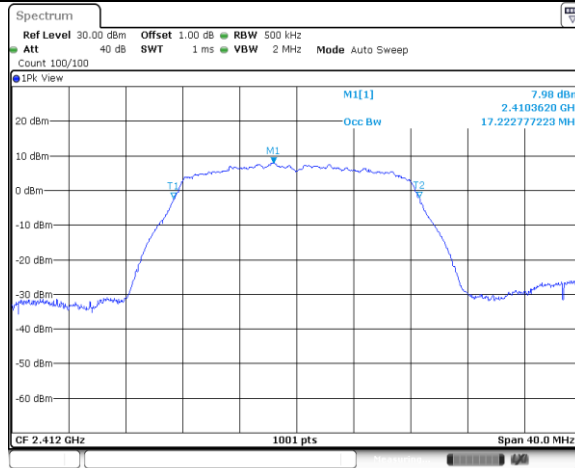

Date: 29 JUN 2023 18:59:29

11G_Ant1_2437

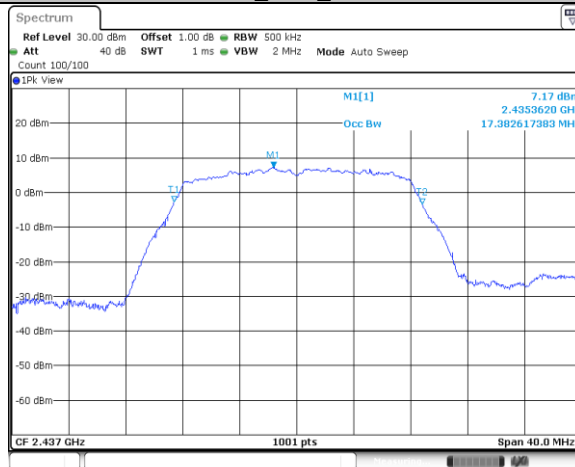

Date: 29 JUN 2023 19:02:47

11G_Ant1_2462

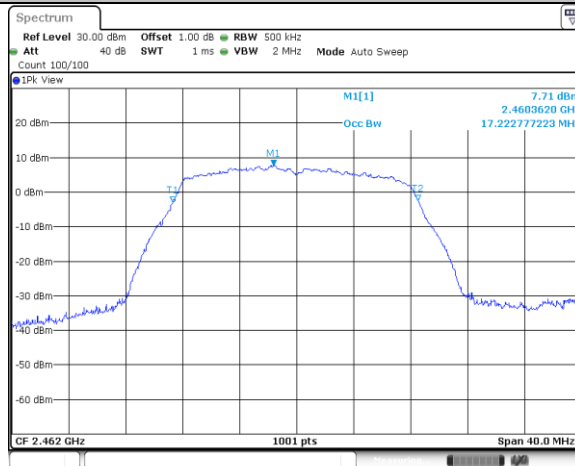

Date: 29 JUN 2023 19:13:06

11N20SISO_Ant1_2412

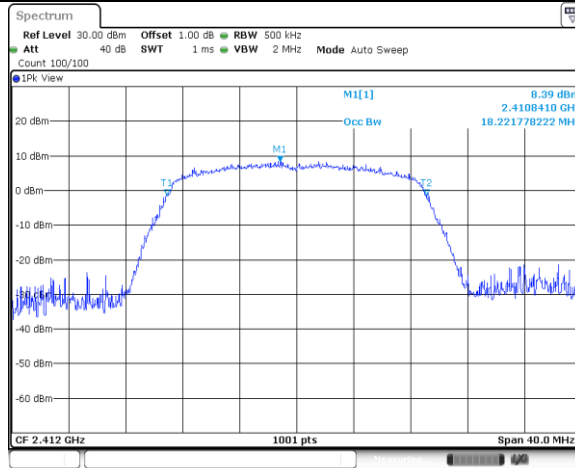

Date: 29 JUN 2023 19:16:33

11N20SISO_Ant1_2437

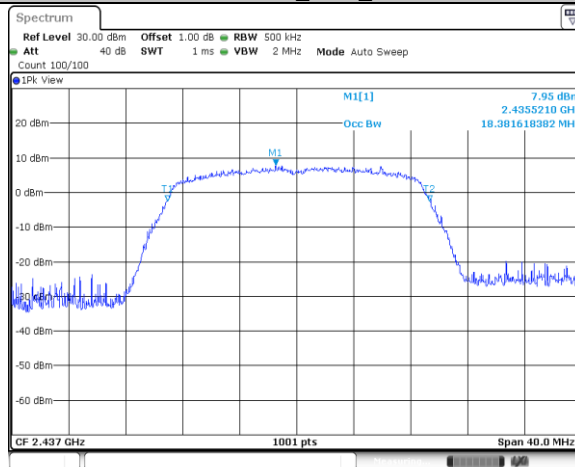

Date: 29 JUN 2023 19:19:42

11N20SISO_Ant1_2462

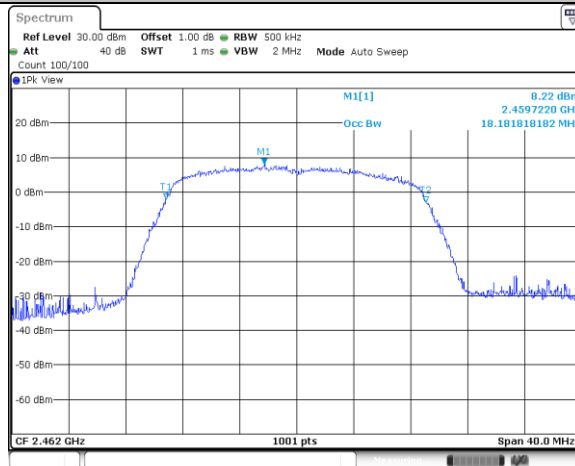

Date: 29 JUN 2023 19:21:29

9.4 Power Spectral Density

Test Method

This procedure shall be used if maximum peak conducted output power was used to demonstrate compliance:

1. The RF output of EUT was connected to the spectrum analyzer. The path loss was compensated to the results for each measurement.
2. Set to the maximum power setting, the instrument center frequency is set to the nominal EUT channel center frequency enable the EUT transmit continuously.
3. Use the following spectrum analyzer settings:
4. Set analyzer center frequency to DTS channel center frequency. RBW=3kHz, VBW≥3RBW, Span=1.5 times DTS bandwidth, Detector=Peak, Sweep=auto, Trace= max hold.
5. Allow trace to fully stabilize, use the peak marker function to determine the maximum amplitude level within the RBW.
6. Repeat above procedures until other frequencies measured were completed.

Limit

Limit [dBm/3KHz]
≤8

802.11b modulation Test Result

Frequency (MHz)	Power spectral density (dBm/3KHz)	Limit (dBm/3kHz)	Result
Low channel 2412MHz	-7.50	8	Pass
Middle channel 2437MHz	-7.21	8	Pass
High channel 2462MHz	-8.81	8	Pass

802.11g modulation Test Result

Frequency (MHz)	Power spectral density (dBm/3KHz)	Limit (dBm/3kHz)	Result
Low channel 2412MHz	-11.54	8	Pass
Middle channel 2437MHz	-11.91	8	Pass
High channel 2462MHz	-10.67	8	Pass

802.11n-HT20 modulation Test Result

Frequency (MHz)	Power spectral density (dBm/3KHz)	Limit (dBm/3kHz)	Result
Low channel 2412MHz	-11.50	8	Pass
Middle channel 2437MHz	-11.15	8	Pass
High channel 2462MHz	-10.31	8	Pass

11B_Ant1_2412

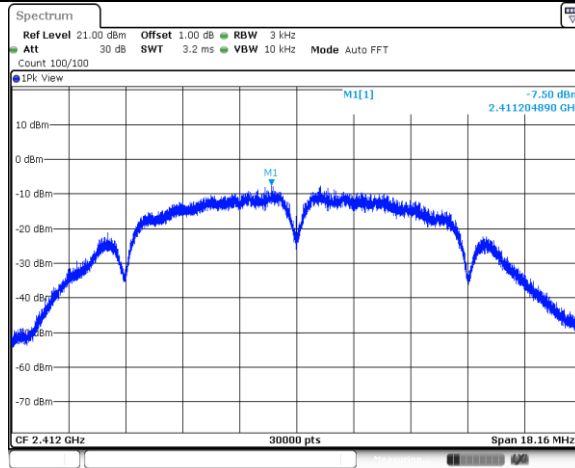

Date: 29 JUN 2023 18:50:36

11B_Ant1_2437

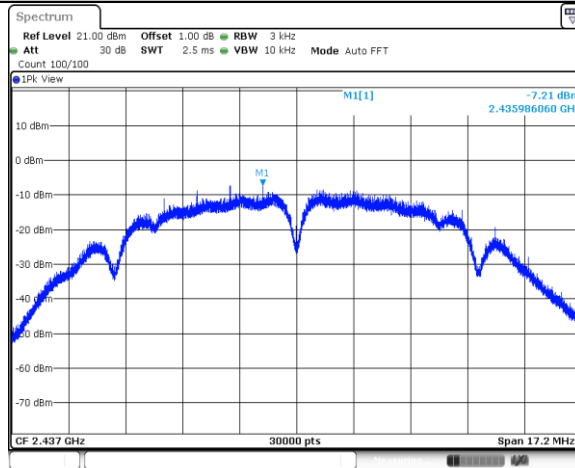

Date: 29 JUN 2023 18:53:38

11B_Ant1_2462

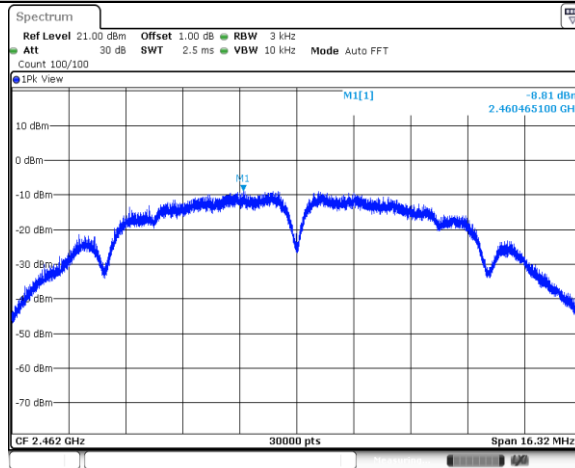

Date: 29 JUN 2023 18:56:34

11G_Ant1_2412

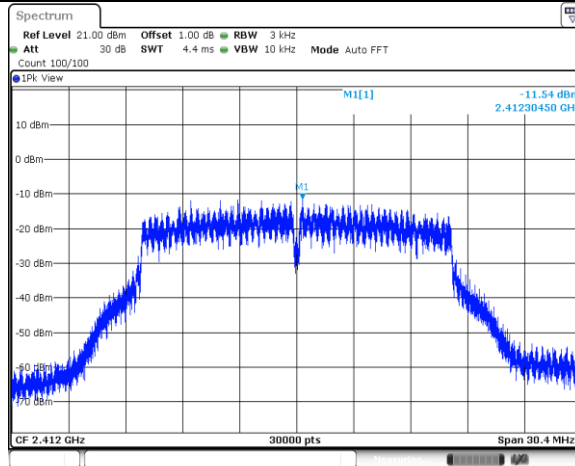

Date: 29 JUN 2023 18:59:40

11G_Ant1_2437

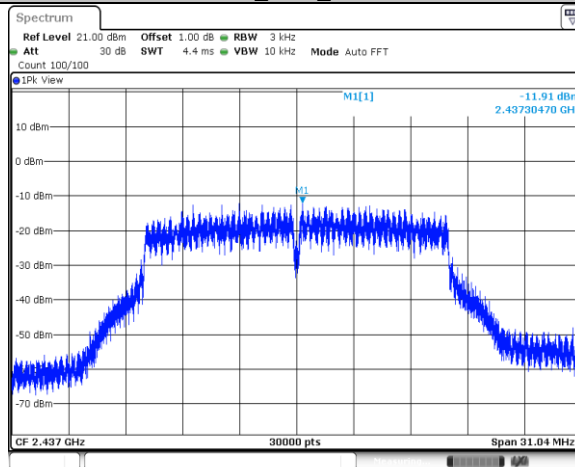

Date: 29 JUN 2023 19:02:58

11G_Ant1_2462

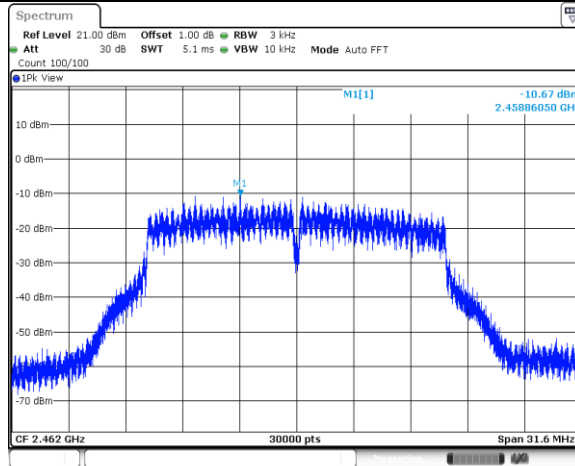

Date: 29 JUN 2023 19:13:18

11N20SISO_Ant1_2412

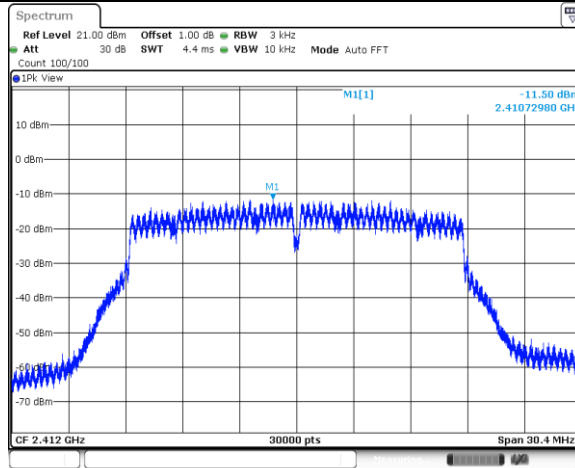

Date: 29 JUN 2023 19:16:45

11N20SISO_Ant1_2437

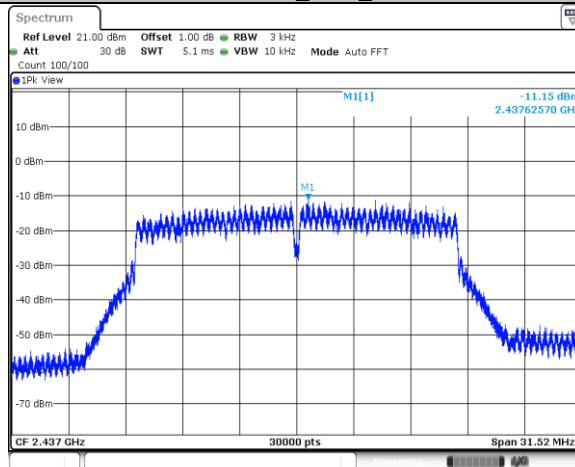

Date: 29 JUN 2023 19:19:53

11N20SISO_Ant1_2462

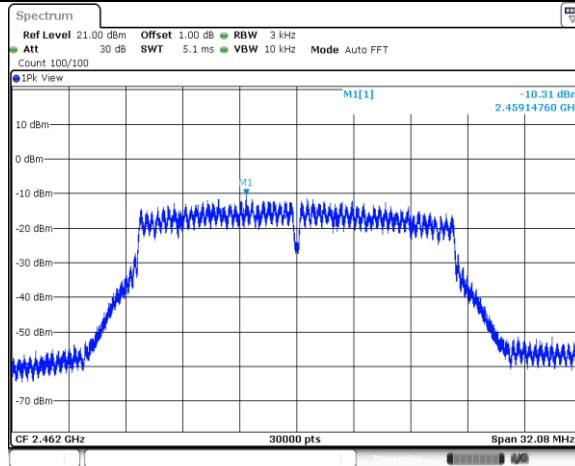

Date: 29 JUN 2023 19:21:40

9.5 Spurious RF Conducted Emissions

Test Method

1. The RF output of EUT was connected to the spectrum analyzer by RF cable. The path loss was compensated to the results for each measurement.
2. Set to the maximum power setting, the instrument center frequency is set to the nominal EUT channel center frequency enable the EUT transmit continuously.
3. Use the following spectrum analyzer settings:
Span = wide enough to capture the peak level of the in-band emission and all spurious emissions (e.g., harmonics) from the lowest frequency generated in the EUT up through the 10th harmonic. Typically, several plots are required to cover this entire span.
RBW = 100 kHz, VBW \geq 3RBW, Sweep = auto, Detector function = peak, Trace = max hold
4. Allow the trace to stabilize. Set the marker on the peak of any spurious emission recorded.
5. The level displayed must comply with the limit specified in this Section. Submit these plots.
6. Repeat above procedures until all frequencies measured were complete.

Limit

Frequency Range MHz	Limit (dBc)
30-25000	-20

Spurious RF conducted emissions

Test Mode	Channel (MHz)	Frequency Range (MHz)	Result (dBm)	Limit (dBm)	Verdict
11B	2412	Reference	5.23	---	PASS
		30~1000	-68.59	<=-14.77	PASS
		1000~26500	-41.36	<=-14.77	PASS
	2437	Reference	5.26	---	PASS
		30~1000	-66.98	<=-14.74	PASS
		1000~26500	-51.24	<=-14.74	PASS
	2462	Reference	5.73	---	PASS
		30~1000	-68.51	<=-14.27	PASS
		1000~26500	-51.36	<=-14.27	PASS
11G	2412	Reference	2.53	---	PASS
		30~1000	-67.52	<=-17.47	PASS
		1000~26500	-39.6	<=-17.47	PASS
	2437	Reference	2.41	---	PASS
		30~1000	-67.84	<=-17.59	PASS
		1000~26500	-52.37	<=-17.59	PASS
	2462	Reference	2.82	---	PASS
		30~1000	-67.99	<=-17.18	PASS
		1000~26500	-49.31	<=-17.18	PASS
11N20	2412	Reference	2.78	---	PASS
		30~1000	-67.6	<=-17.22	PASS
		1000~26500	-42.48	<=-17.22	PASS
	2437	Reference	2.48	---	PASS
		30~1000	-67.32	<=-17.52	PASS
		1000~26500	-52.15	<=-17.52	PASS
	2462	Reference	3.05	---	PASS
		30~1000	-68.2	<=-16.95	PASS
		1000~26500	-45.62	<=-16.95	PASS

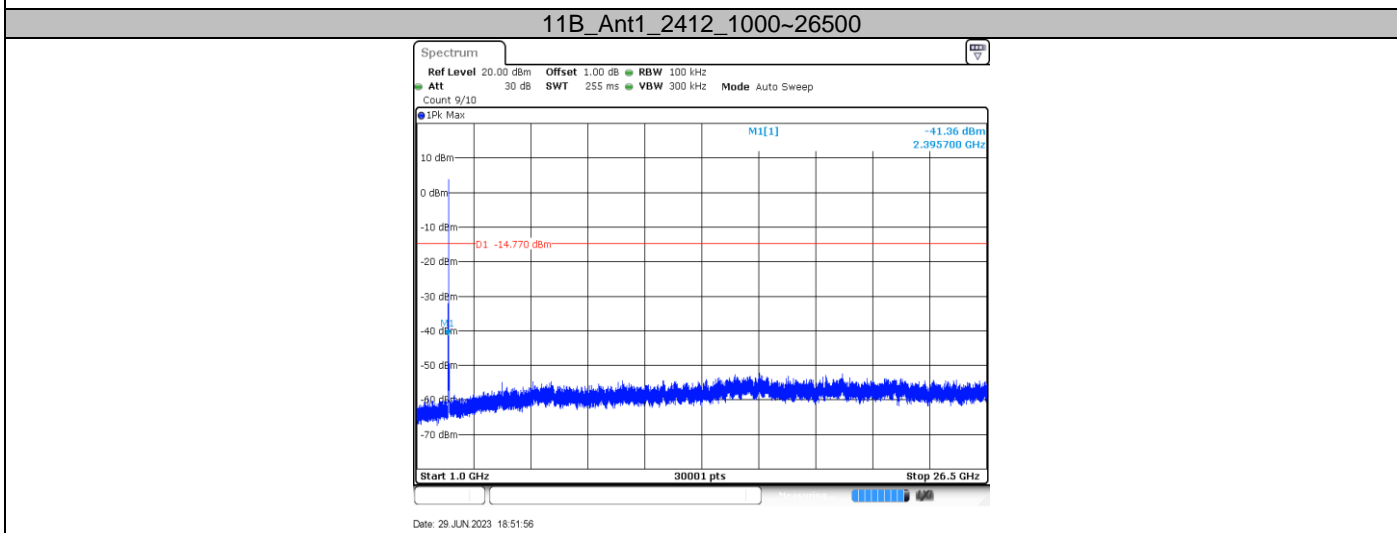
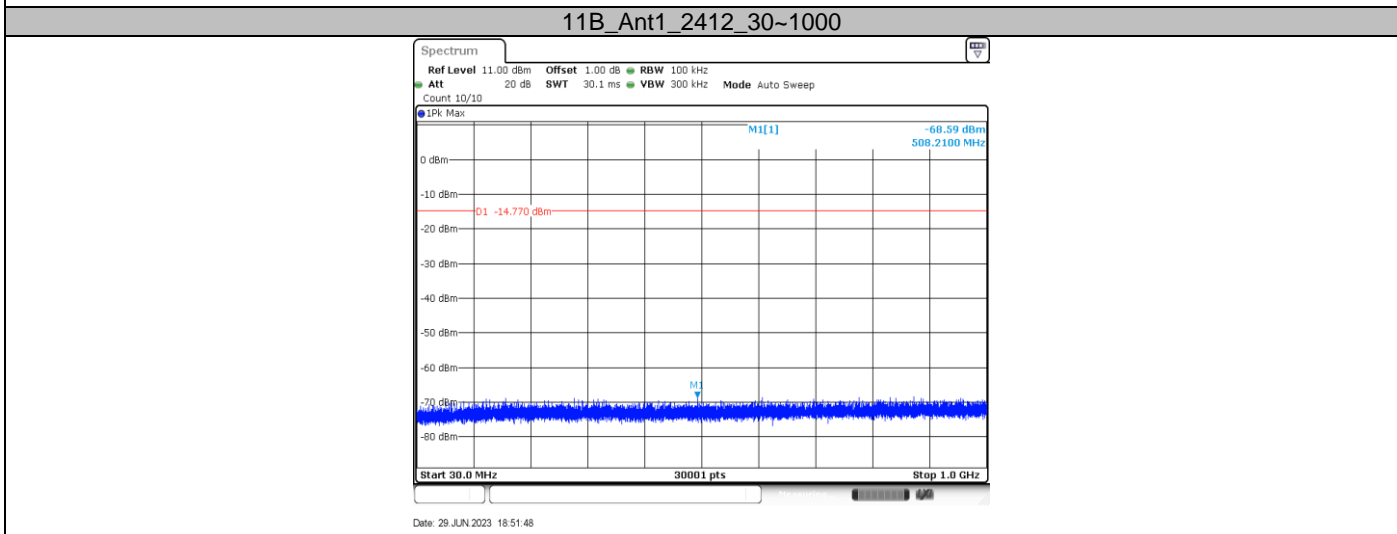
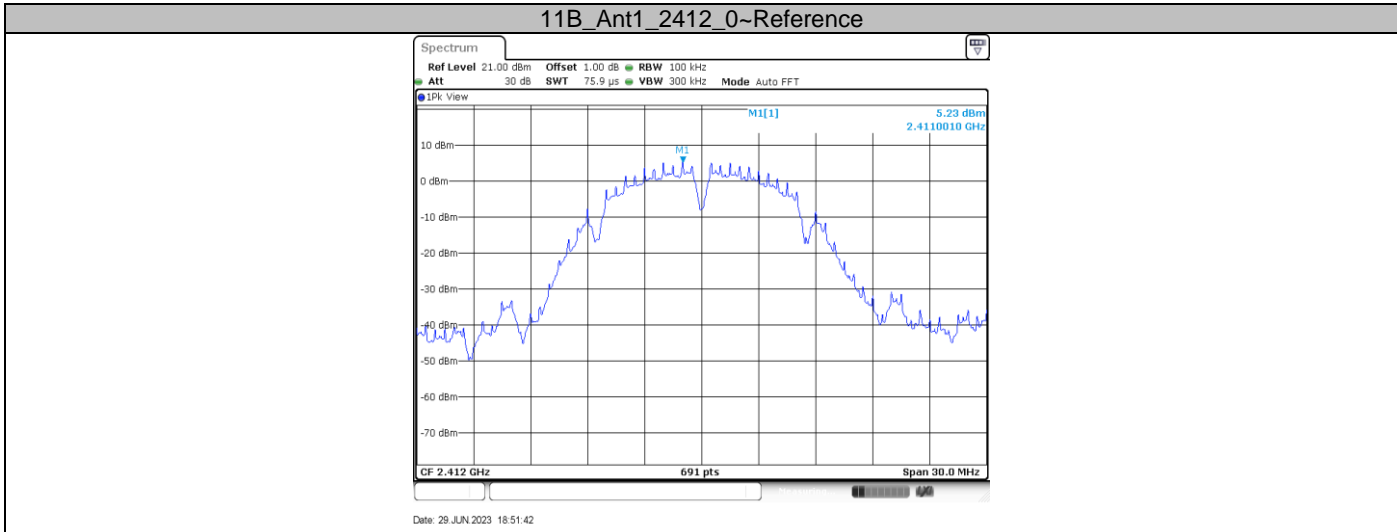

11B_Ant1_2437_0~Reference

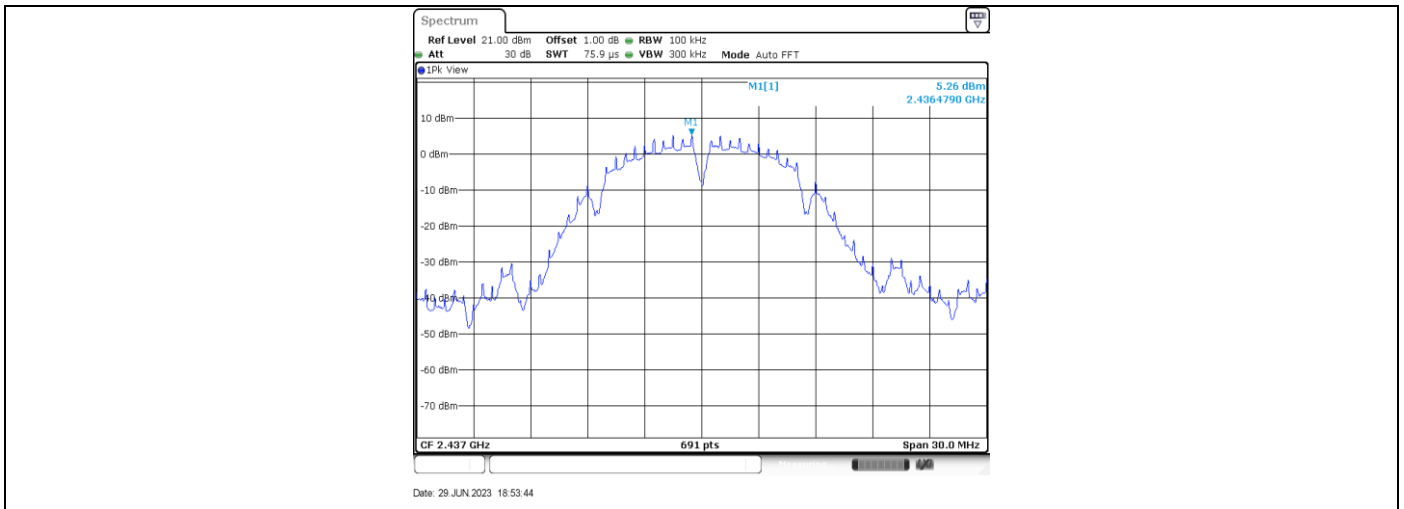

11B_Ant1_2437_30~1000

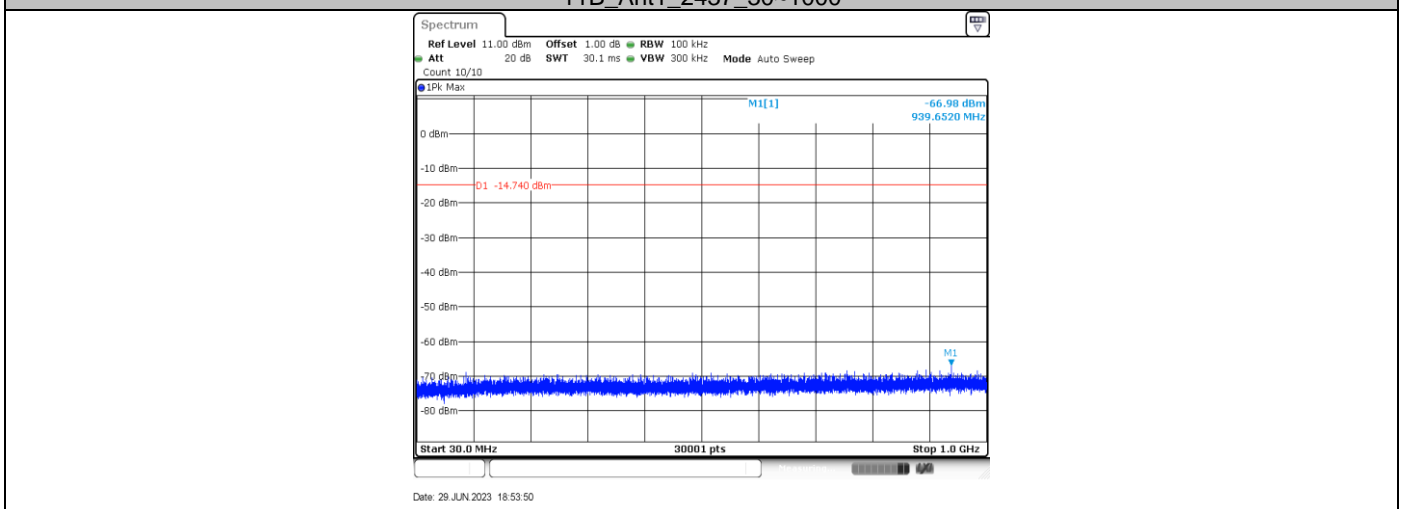

11B_Ant1_2437_1000~26500

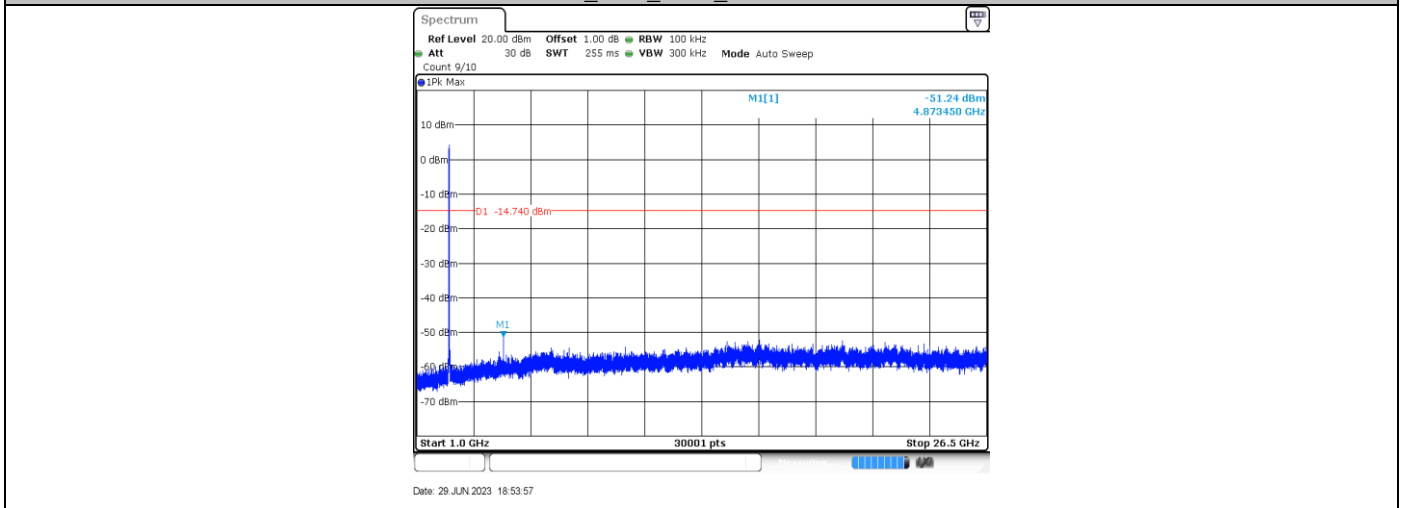

11B_Ant1_2462_0~Reference

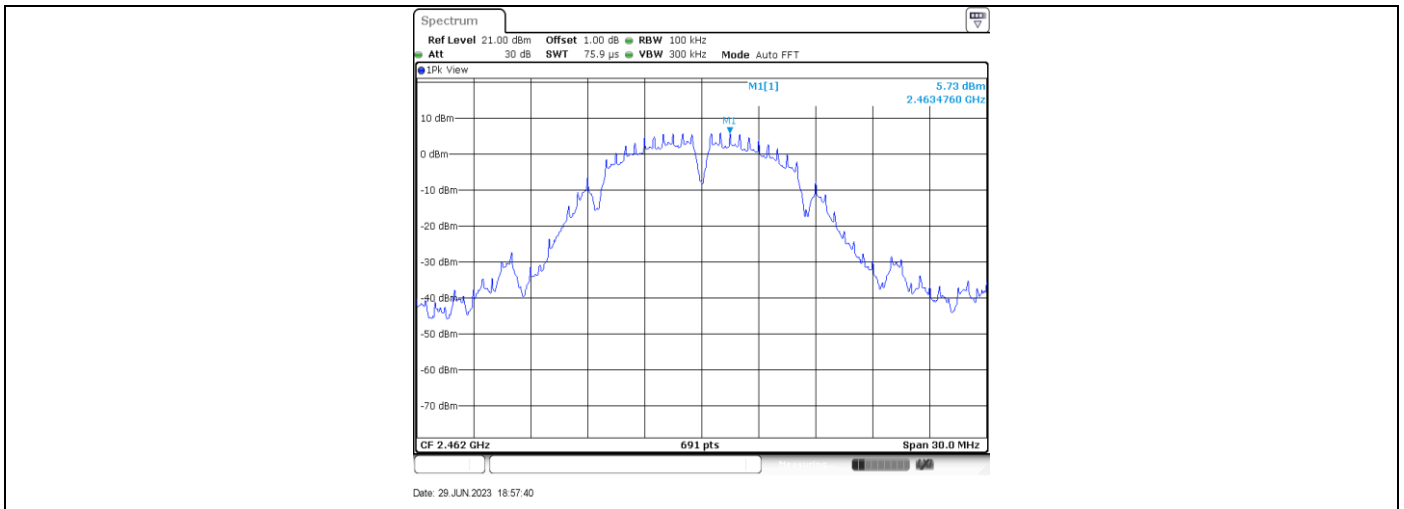

11B_Ant1_2462_30~1000

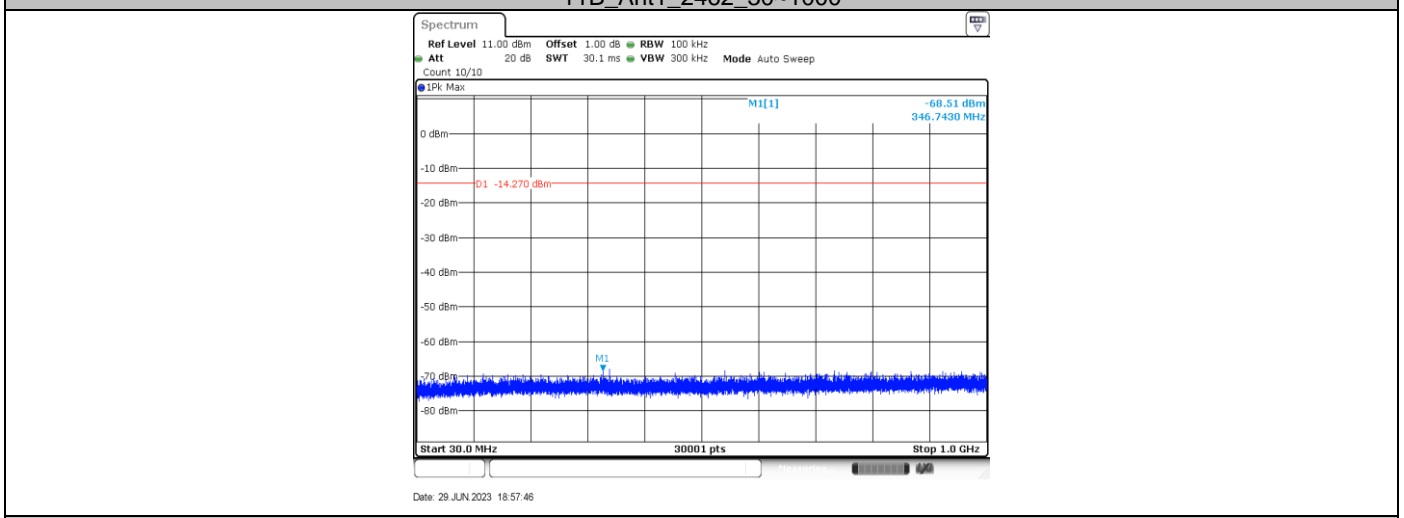

11B_Ant1_2462_1000~26500

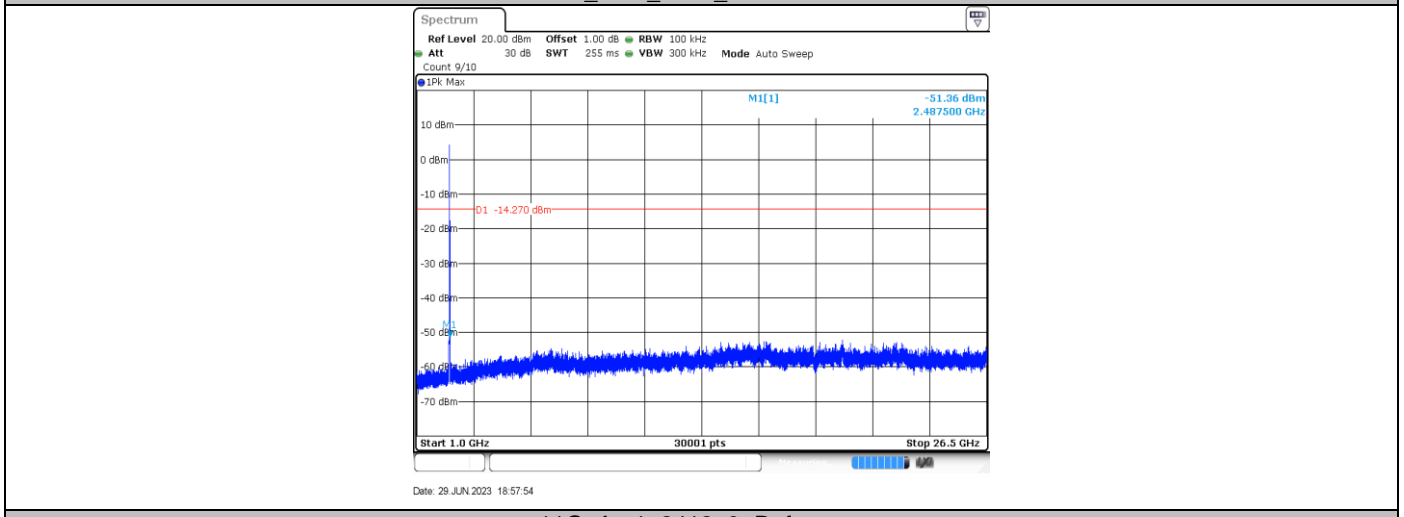

11G_Ant1_2412_0~Reference

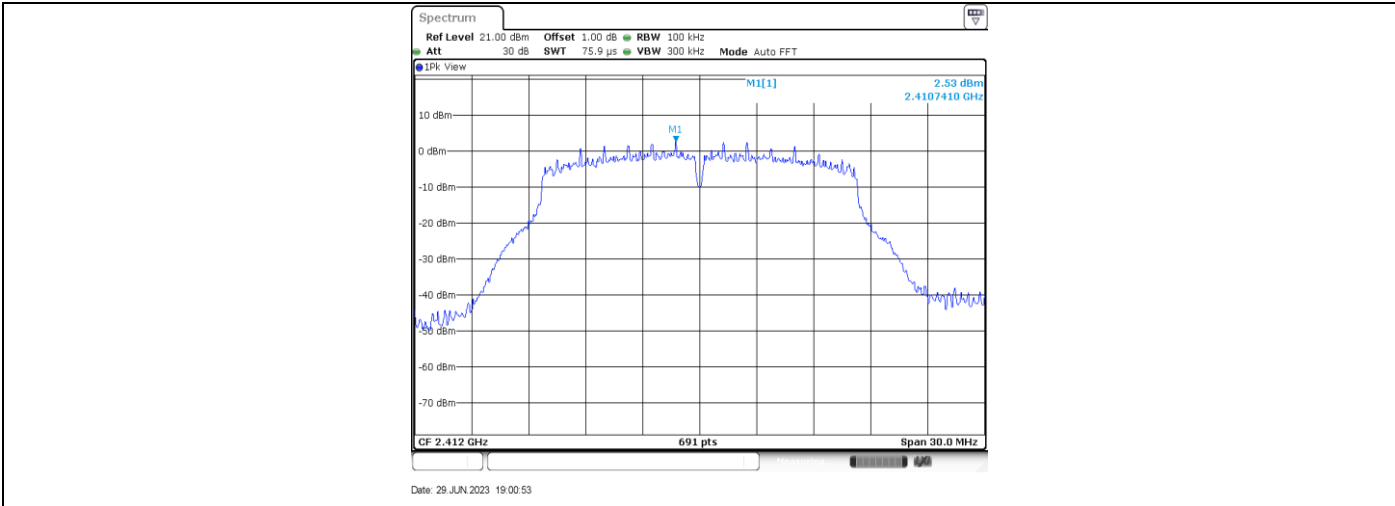

11G_Ant1_2412_30~1000

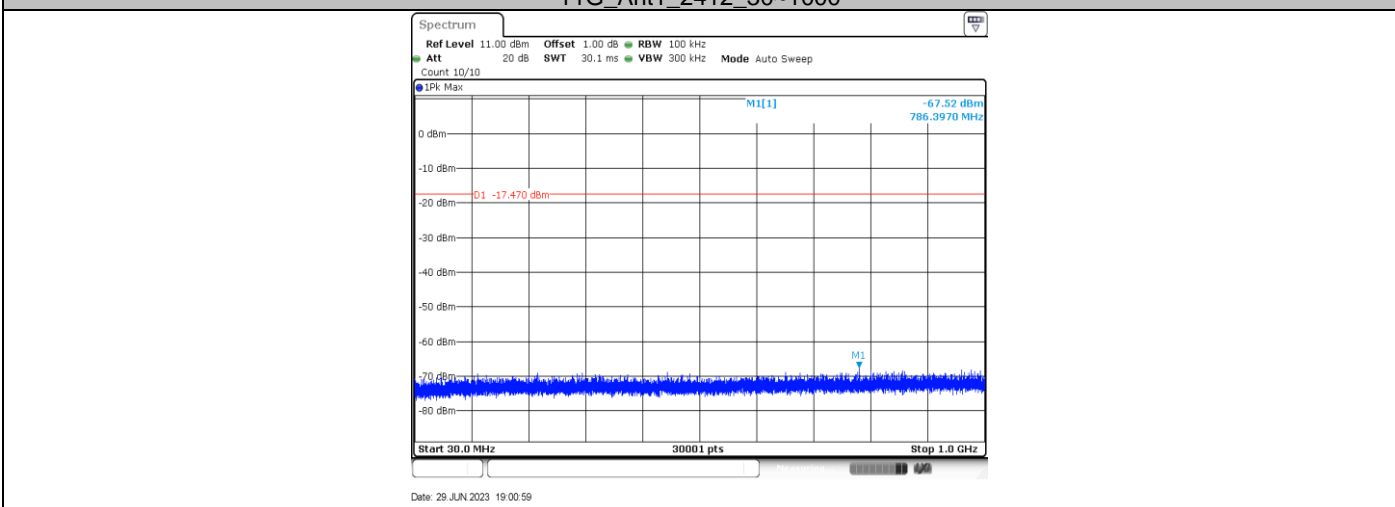

11G_Ant1_2412_1000~26500

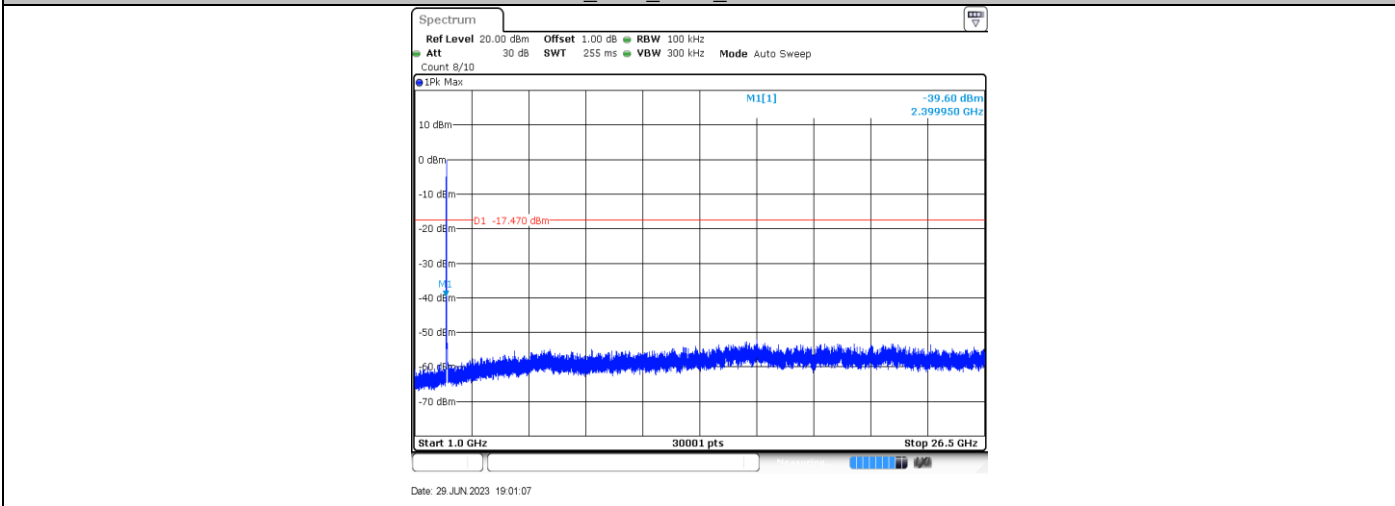

11G_Ant1_2437_0~Reference

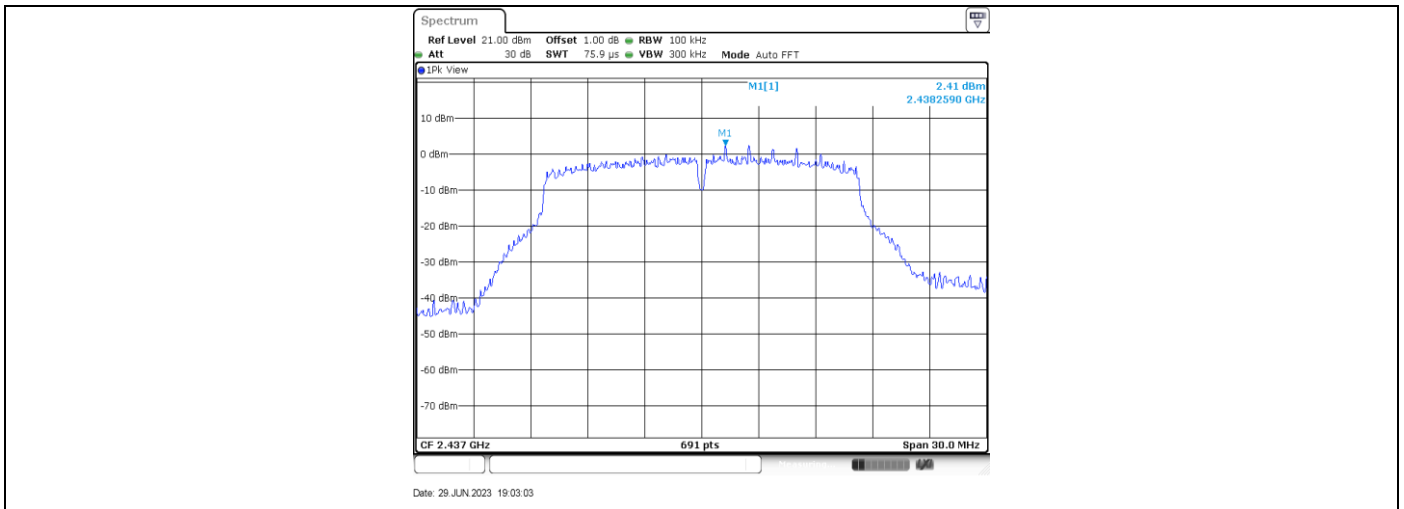

11G_Ant1_2437_30~1000

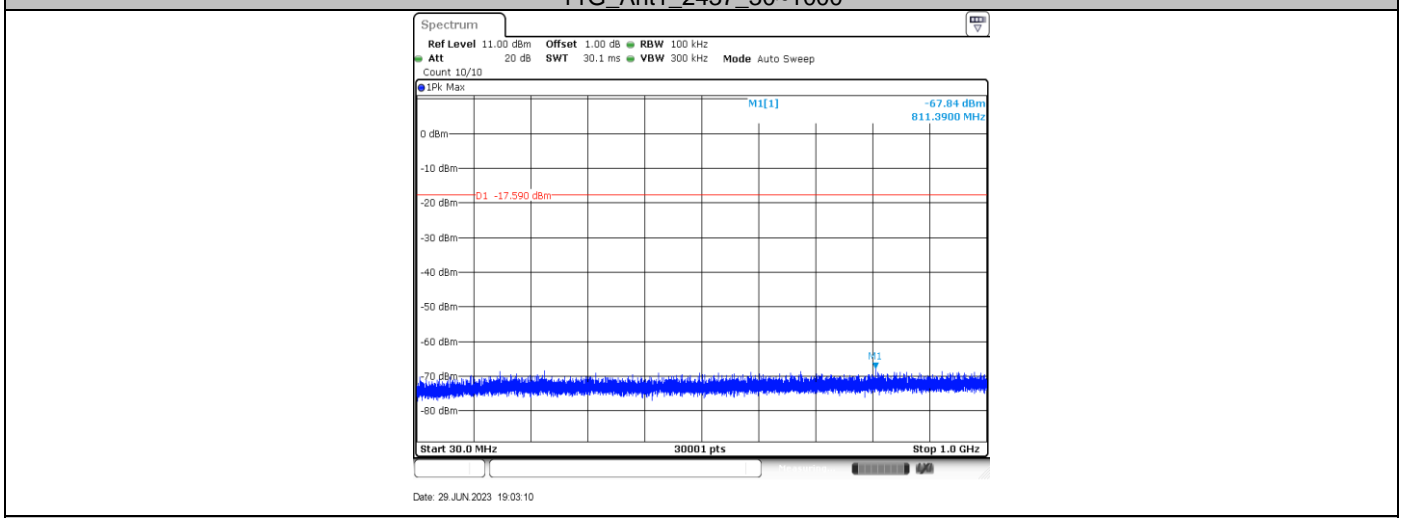

11G_Ant1_2437_1000~26500

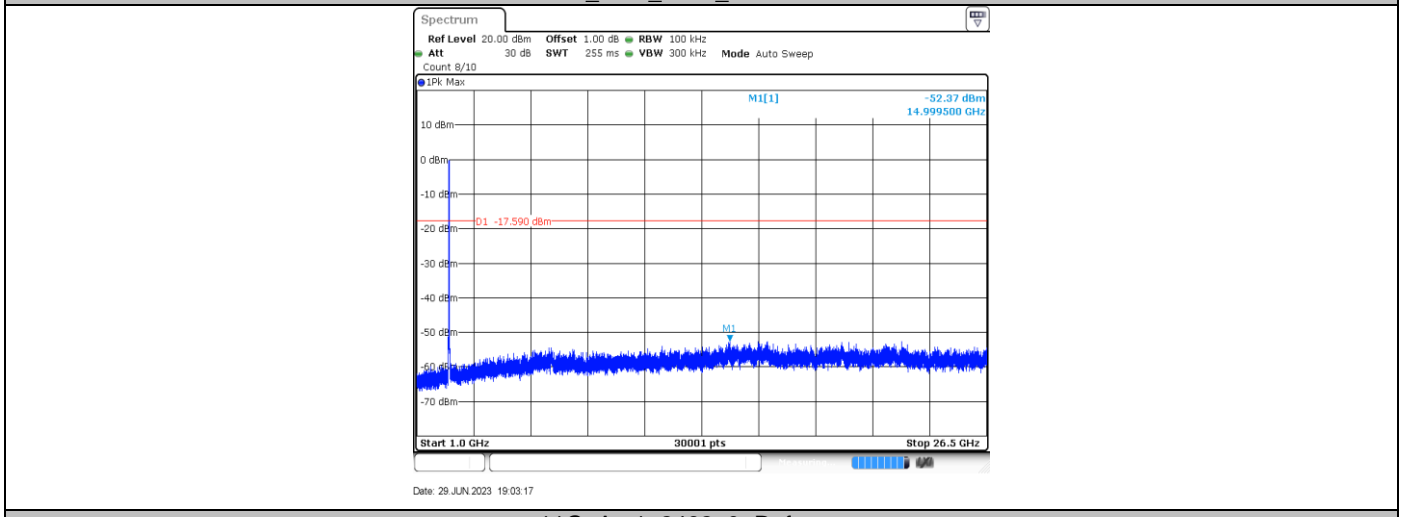

11G_Ant1_2462_0~Reference

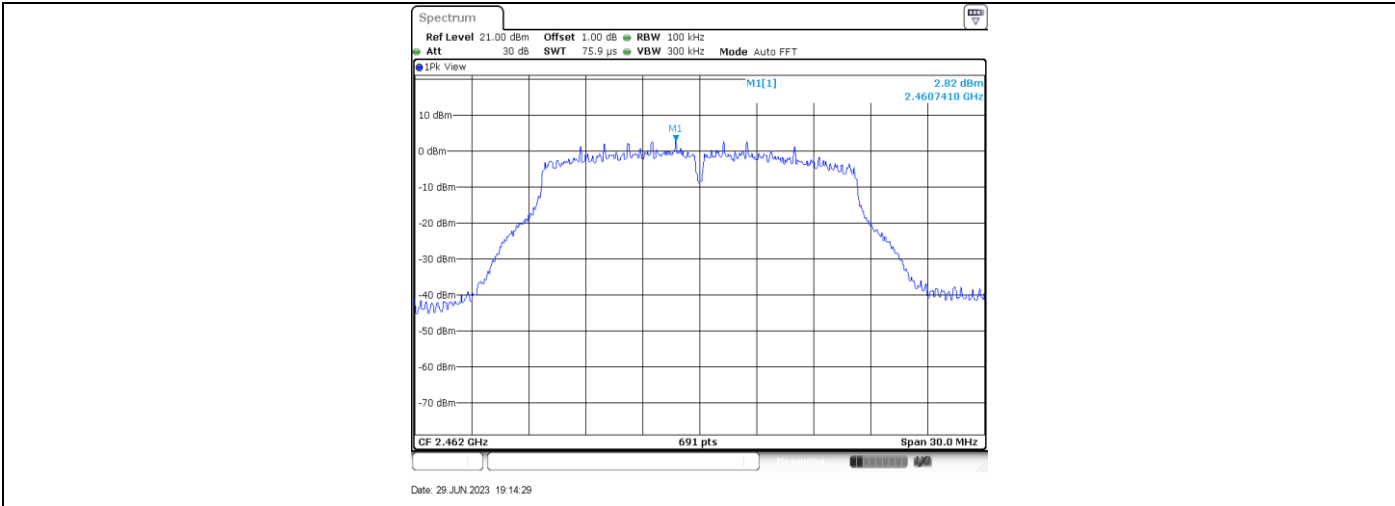

11G_Ant1_2462_30~1000

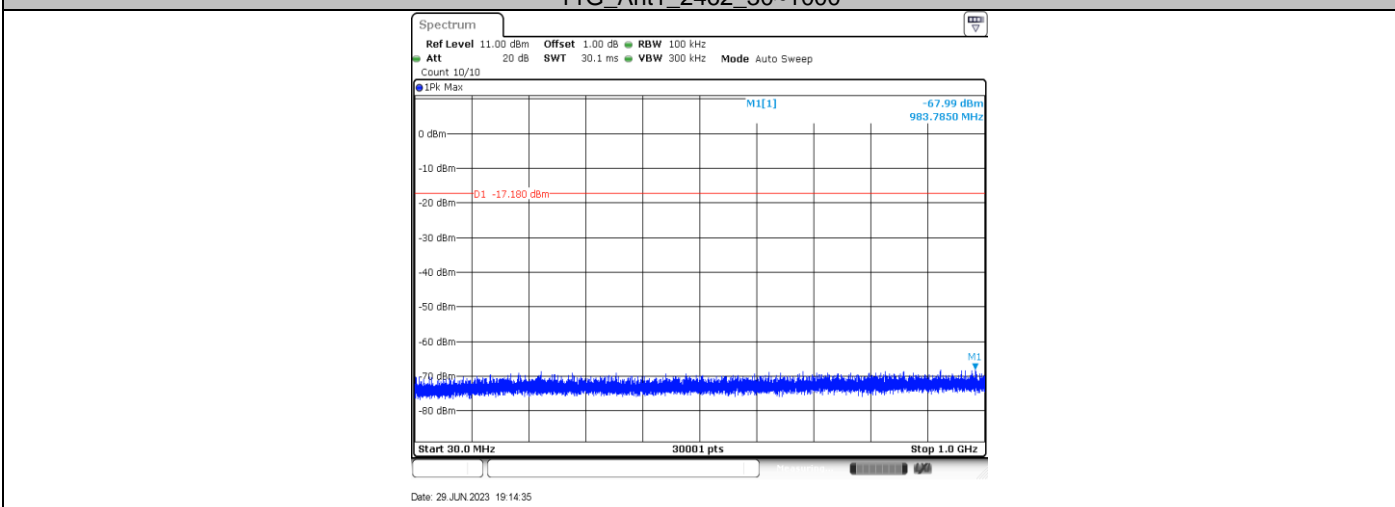

11G_Ant1_2462_1000~26500

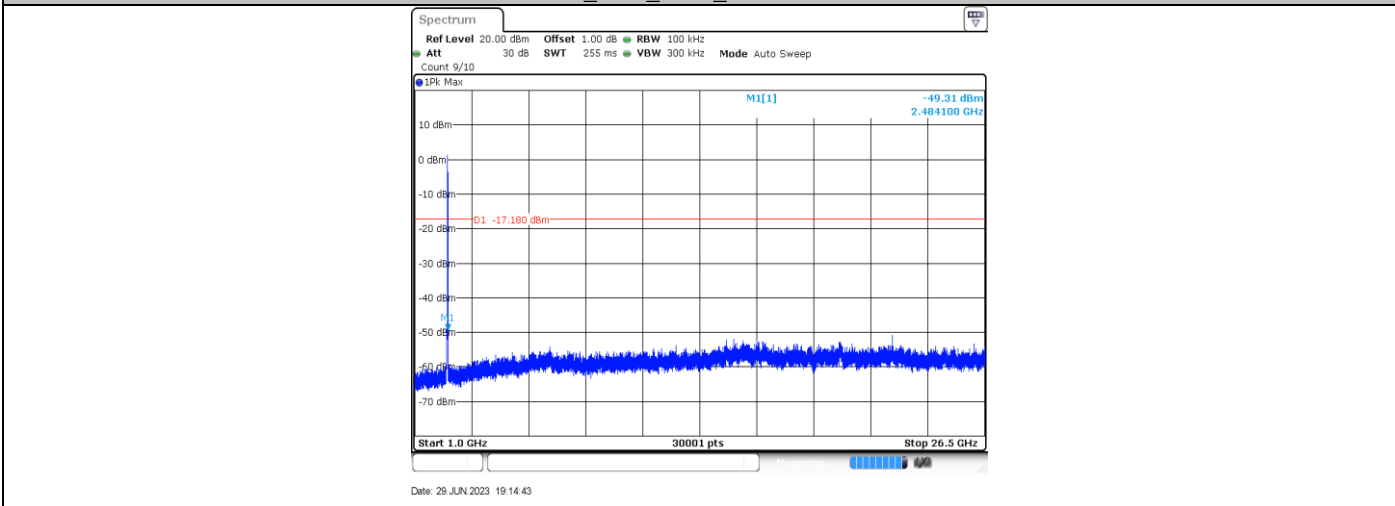

11N20SISO_Ant1_2412_0~Reference

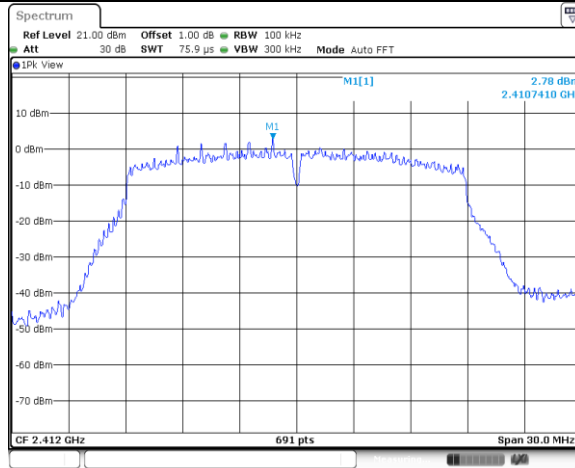

Date: 29 JUN 2023 19:17:58

11N20SISO_Ant1_2412_30~1000

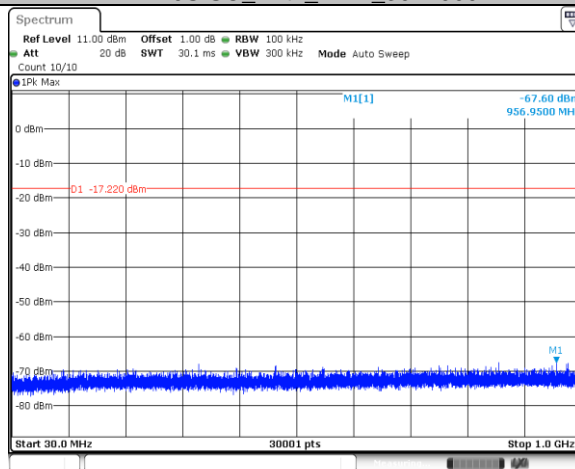

Date: 29 JUN 2023 19:18:04

11N20SISO_Ant1_2412_1000~26500

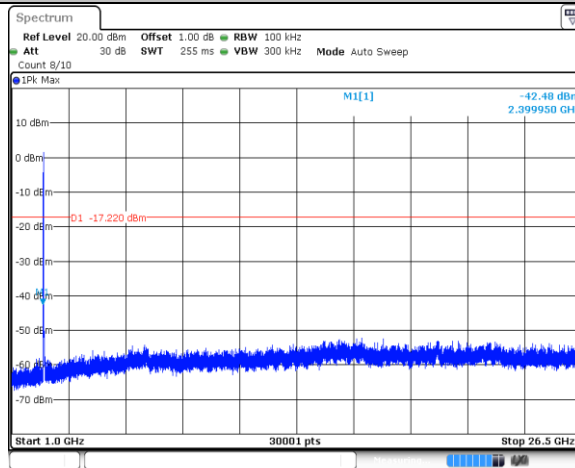

Date: 29 JUN 2023 19:18:12

11N20SISO_Ant1_2437_0~Reference

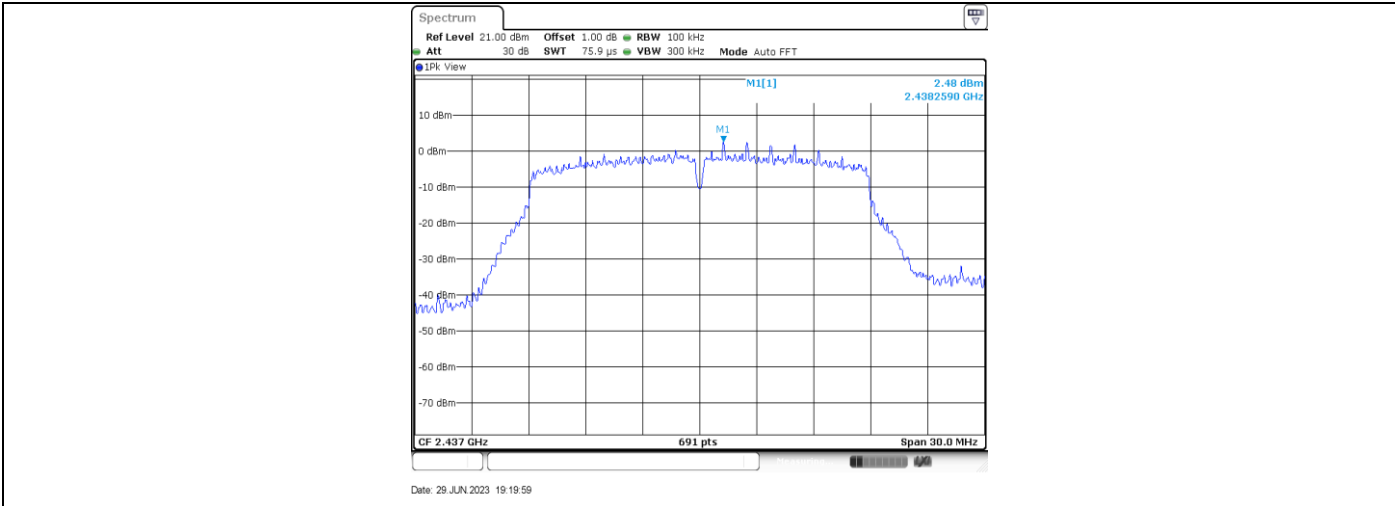

11N20SISO_Ant1_2437_30~1000

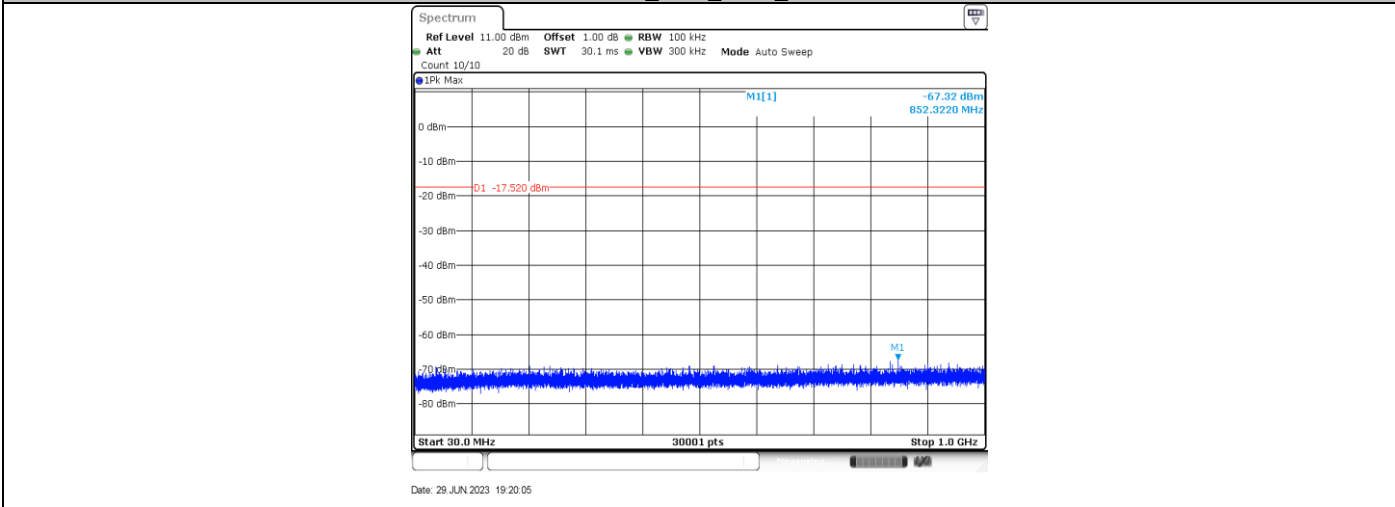

11N20SISO_Ant1_2437_1000~26500

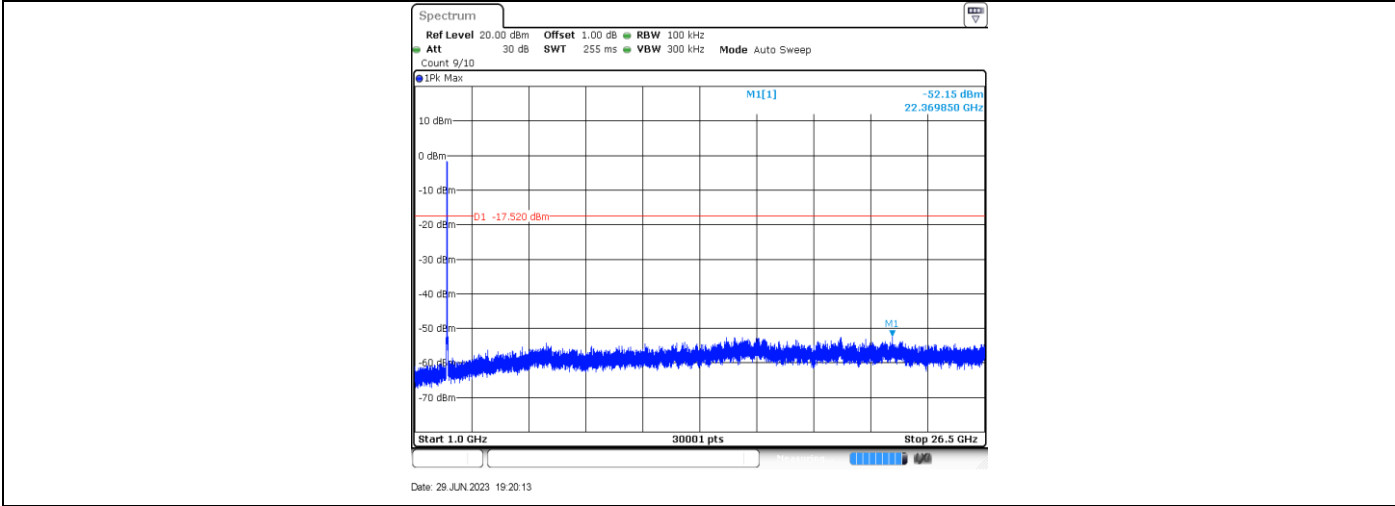

11N20SISO_Ant1_2462_0~Reference

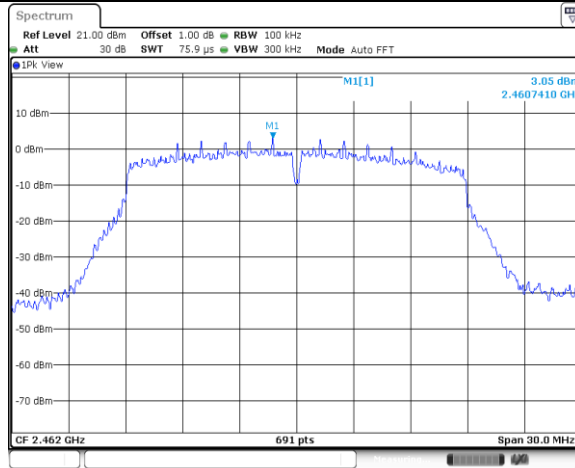

Date: 29 JUN 2023 19:22:52

11N20SISO_Ant1_2462_30~1000

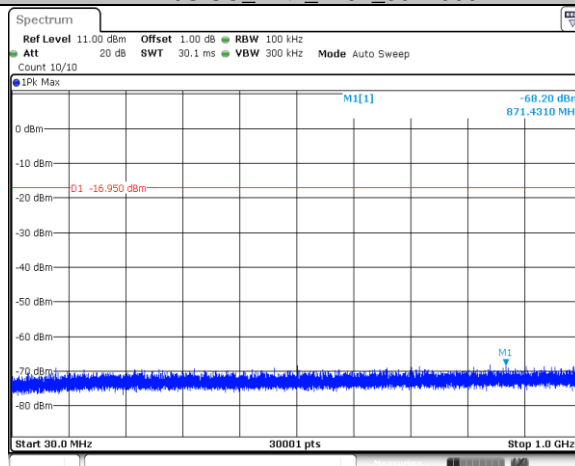

Date: 29 JUN 2023 19:22:58

11N20SISO_Ant1_2462_1000~26500

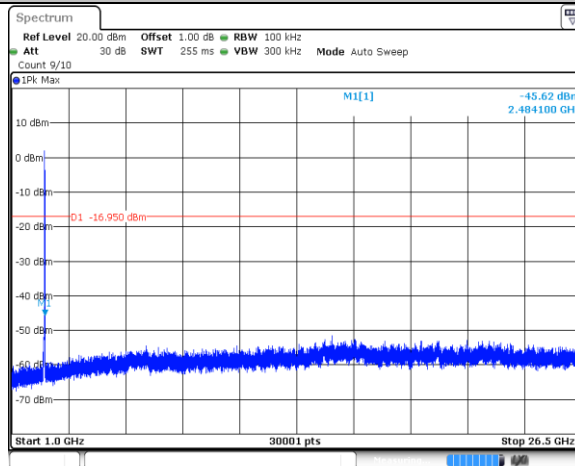

Date: 29 JUN 2023 19:23:06

9.6 Band Edge Testing

Test Method

1. The RF output of EUT was connected to the spectrum analyzer by RF cable. The path loss was compensated to the results for each measurement.
2. Set to the maximum power setting, the instrument center frequency is set to the nominal EUT channel center frequency enable the EUT transmit continuously.
3. Use the following spectrum analyzer settings:
Span = wide enough to capture the peak level of the in-band emission and all spurious
RBW = 100 kHz, VBW \geq 3RBW, Sweep = auto, Detector function = peak, Trace = max hold
4. Allow the trace to stabilize, use the peak and delta measurement to record the result.
5. The level displayed must comply with the limit specified in this Section.
6. Repeat above procedures until all frequencies measured were complete and submit all the plots.

Limit:

In any 100 kHz bandwidth outside the frequency band in which the spread spectrum or digitally modulated device is operating, the RF power that is produced shall be at least 20 dB below that in the 100 kHz bandwidth within the band that contains the highest level of the desired power, based on either an RF conducted or a radiated measurement, provided that the transmitter demonstrates compliance with the peak conducted power limits. If the transmitter complies with the conducted power limits based on the use of RMS averaging over a time interval, as permitted under § 15.247(b)(3) and RSS-247 section 5.4(d), the attenuation required shall be 30 dB instead of 20 dB.

Frequency Range MHz	Limit (dBc)
30-25000	-20

Band edge testing

Test Mode	Channel Name	Channel (MHz)	Reference Level (dBm)	Result (dBm)	Limit (dBm)	Verdict
11B	Low	2412	5.07	-41.1	<=-14.93	PASS
	High	2462	5.49	-46.12	<=-14.51	PASS
11G	Low	2412	1.51	-42.4	<=-18.49	PASS
	High	2462	2.35	-44.79	<=-17.65	PASS
11N20	Low	2412	-0.32	-41.35	<=-20.32	PASS
	High	2462	2.40	-43.2	<=-17.6	PASS

11B_Ant1_Low_2412

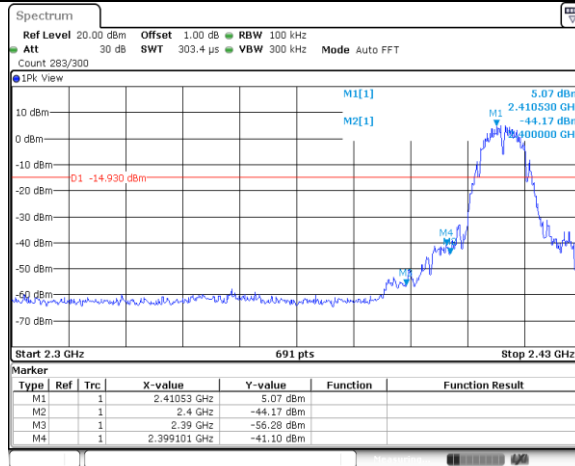

Date: 29 JUN 2023 18:50:45

11B_Ant1_High_2462

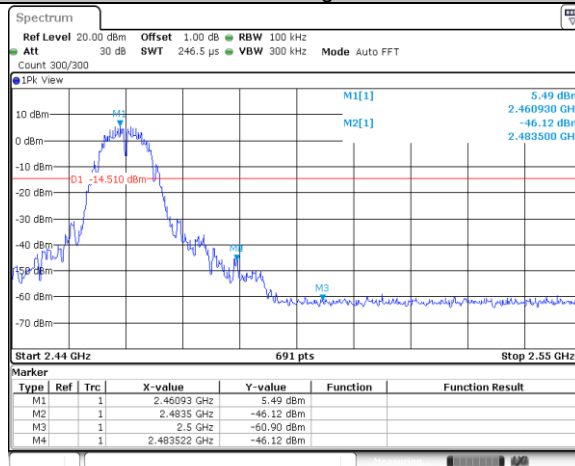

Date: 29 JUN 2023 18:58:43

11G_Ant1_Low_2412

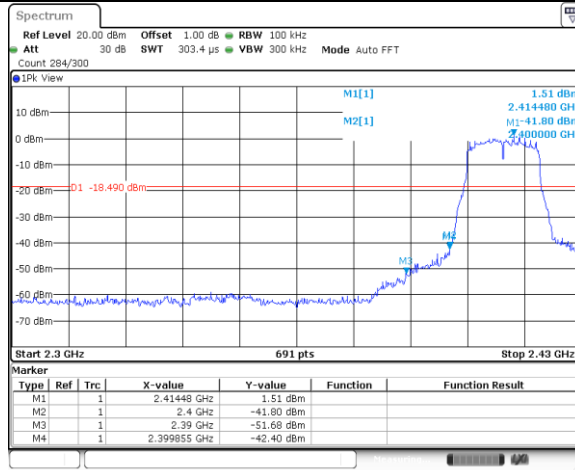

Date: 29 JUN 2023 18:59:49

11G_Ant1_High_2462

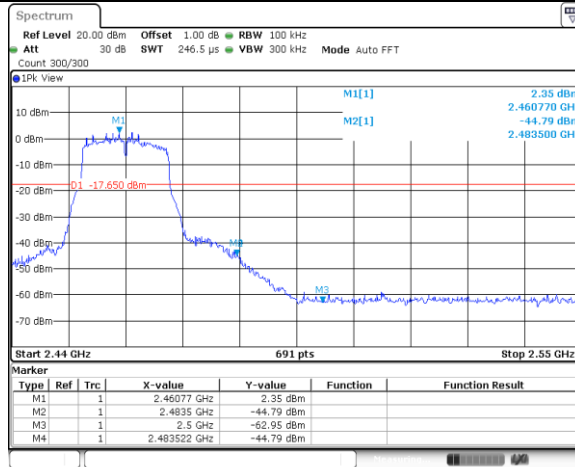

Date: 29 JUN 2023 19:13:27

11N20SISO_Ant1_Low_2412

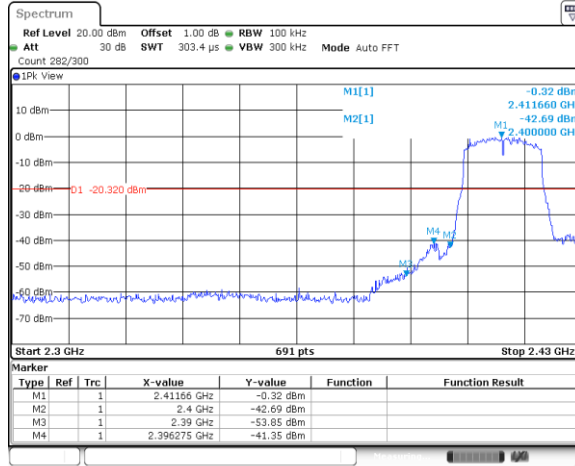

Date: 29 JUN 2023 19:16:54

11N20SISO_Ant1_High_2462

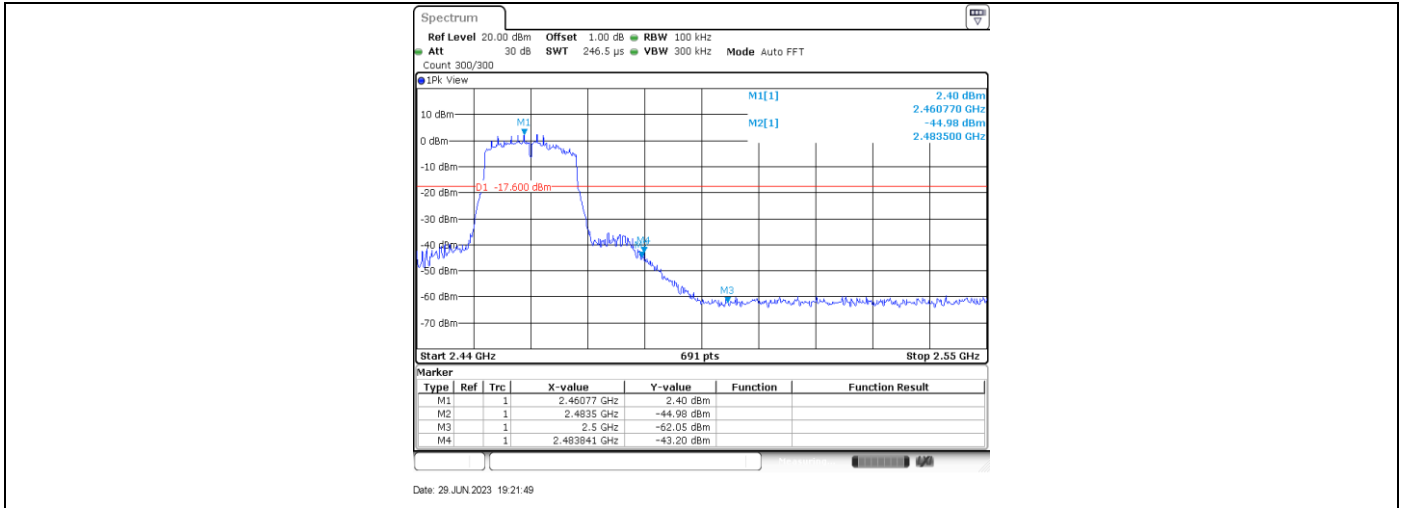

9.7 Spurious Radiated Emissions for Transmitter

Test Method

1. The EUT was placed on a turn table which is 1.5m above ground plane for above 1GHz and 0.8m above ground for below 1GHz at 3 meter chamber room for test. The table was rotated 360 degrees to determine the position of the highest radiation.
2. The EUT was set 3 meters away from the interference – receiving antenna, which was mounted on the top of a variable – height antenna tower.
3. The height of antenna is varied from one meter to four meters above the ground to determine the maximum value of the field strength. Both horizontal and vertical polarizations of the antenna are set to make the measurement.
4. For each suspected emission, the EUT was arranged to its worst case and then the antenna was tuned to heights from 1 meter to 4 meters and the rotatable table was turned from 0 degrees to 360 degrees to find the maximum reading.
5. Use the following spectrum analyzer settings According to C63.10:

For Below 1GHz

Use the following test receiver settings:

Span = wide enough to capture the peak level of the in-band emission and all spurious
 RBW = 100 KHz to 120KHz, VBW ≥ RBW for peak measurement, Sweep = auto, Detector function = peak, Trace = max hold.

For Peak unwanted emissions Above 1GHz:

Span = wide enough to capture the peak level of the in-band emission and all spurious
 RBW = 1MHz, VBW ≥ RBW for peak measurement, Sweep = auto, Detector function = peak, Trace = max hold.

Procedures for average unwanted emissions measurements above 1000 MHz

a) RBW = 1MHz.

b) VBW \ [3 × RBW].

c) Detector = RMS (power averaging), if [span / (# of points in sweep)] \ RBW / 2.

Satisfying this condition can require increasing the number of points in the sweep or reducing the span. If the condition is not satisfied, then the detector mode shall be set to peak.

d) Averaging type = power (i.e., rms) (As an alternative, the detector and averaging type may be set for linear voltage averaging. Some instruments require linear display mode to use linear voltage averaging. Log or dB averaging shall not be used.)

e) Sweep time = auto.

f) Perform a trace average of at least 100 traces if the transmission is continuous. If the transmission is not continuous, then the number of traces shall be increased by a factor of 1 / D, where D is the duty cycle. For example, with 50% duty cycle, at least 200 traces shall be averaged. (If a specific emission is demonstrated to be continuous—i.e., 100% duty cycle—then rather than turning ON and OFF with the transmit cycle, at least 100 traces shall be averaged.)

g) If tests are performed with the EUT transmitting at a duty cycle less than 98%, then a correction factor shall be added to the measurement results prior to comparing with the emission limit, to compute the emission level that would have been measured had the test been performed at 100% duty cycle. The correction factor is computed as follows:

1) If power averaging (rms) mode was used in the preceding step e), then the correction factor is [10 log (1 / D)], where D is the duty cycle. For example, if the transmit duty cycle was 50%, then 3 dB shall be added to the measured emission levels.

2) If linear voltage averaging mode was used in the preceding step e), then the correction factor is $[20 \log (1 / D)]$, where D is the duty cycle. For example, if the transmit duty cycle was 50%, then 6 dB shall be added to the measured emission levels.

3) If a specific emission is demonstrated to be continuous (100% duty cycle) rather than turning ON and OFF with the transmit cycle, then no duty cycle correction is required for that emission (AV) at frequency above 1GHz.

Limit

In any 100 kHz bandwidth outside the frequency band in which the spread spectrum or digitally modulated device is operating, the RF power that is produced shall be at least 20 dB below that in the 100 kHz bandwidth within the band that contains the highest level of the desired power, based on either an RF conducted or a radiated measurement, provided that the transmitter demonstrates compliance with the peak conducted power limits. If the transmitter complies with the conducted power limits based on the use of RMS averaging over a time interval, as permitted under § 15.247(b)(3) and RSS 247 section 5.4(d), the attenuation required shall be 30 dB instead of 20 dB. Attenuation below the general field strength limits specified in § 15.209(a) and RSS-Gen is not required. In addition, radiated emissions which fall in the restricted bands, as defined in § 15.205(a) and RSS-Gen section 8.9, must also comply with the radiated emission limits specified in § 15.209(a) and RSS-Gen section 8.10.

Frequency MHz	Field Strength $\mu\text{V}/\text{m}$	Field Strength $\text{dB}\mu\text{V}/\text{m}$	Detector	Measurement distance meters
0.009-0.490	2400/F(kHz)	48.5-13.8	AV	300
0.490-1.705	24000/F(kHz)	33.8-23.0	QP	30
1.705-30	30	29.5	QP	30
30-88	100	40	QP	3
88-216	150	43.5	QP	3
216-960	200	46	QP	3
960-1000	500	54	QP	3
Above 1000	500	54	AV	3
Above 1000	5000	74	PK	3

Note 1: Limit $3\text{m}(\text{dB}\mu\text{V}/\text{m}) = \text{Limit } 300\text{m}(\text{dB}\mu\text{V}/\text{m}) + 40\text{Log}(300\text{m}/3\text{m})$ (Below 30MHz)

Note 2: Limit $3\text{m}(\text{dB}\mu\text{V}/\text{m}) = \text{Limit } 30\text{m}(\text{dB}\mu\text{V}/\text{m}) + 40\text{Log}(30\text{m}/3\text{m})$ (Below 30MHz)

Spurious Radiated Emissions for Transmitter

According to C63.10, if the peak (or quasi-peak) measured value complies with the average limit, it is unnecessary to perform an average measurement, so AV emission value did not show in below table if the peak value complies with average limit.

Transmitting spurious emission test result as below:
30MHz – 1000MHz:

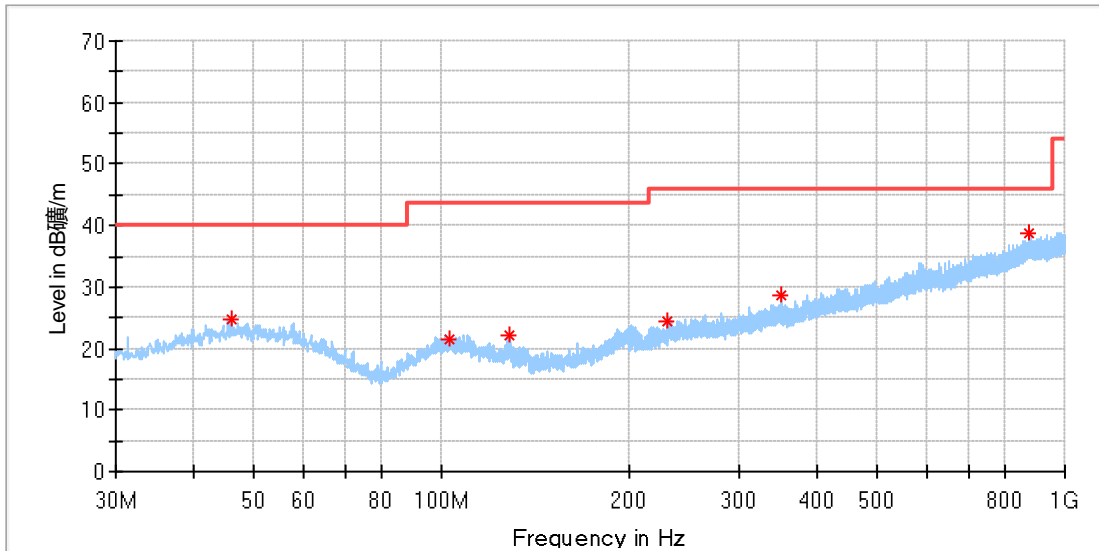

Frequency (MHz)	MaxPeak (dBµV/m)	Limit (dBµV/m)	Margin (dB)	Height (cm)	Pol	Azimuth (deg)	Corr. (dB/m)
45.883750	24.89	40.00	15.11	200.0	H	98.0	21.02
102.750000	21.64	43.50	21.86	200.0	H	39.0	18.71
128.818750	22.16	43.50	21.34	200.0	H	0.0	16.15
229.577500	24.55	46.00	21.45	100.0	H	43.0	19.30
350.342500	28.56	46.00	17.44	200.0	H	0.0	23.03
878.568125	38.75	46.00	7.25	100.0	H	131.0	32.05

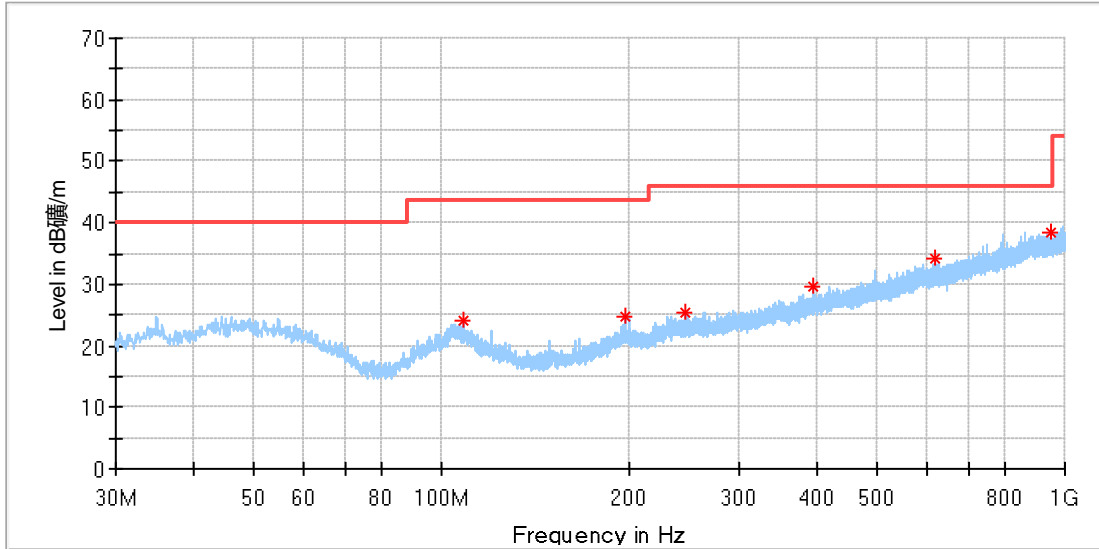

Frequency (MHz)	MaxPeak (dBµV/m)	Limit (dBµV/m)	Margin (dB)	Height (cm)	Pol	Azimuth (deg)	Corr. (dB/m)
108.206250	24.15	43.50	19.35	100.0	V	0.0	18.41
196.961250	24.70	43.50	18.80	200.0	V	0.0	19.10
246.795000	25.26	46.00	20.74	100.0	V	351.0	20.25
395.447500	29.49	46.00	16.51	200.0	V	245.0	23.90
617.698750	34.22	46.00	11.78	200.0	V	0.0	28.05
949.802500	38.31	46.00	7.69	200.0	V	215.0	32.38

1GHz -18GHz:
11b_2412MHz_Ant1:

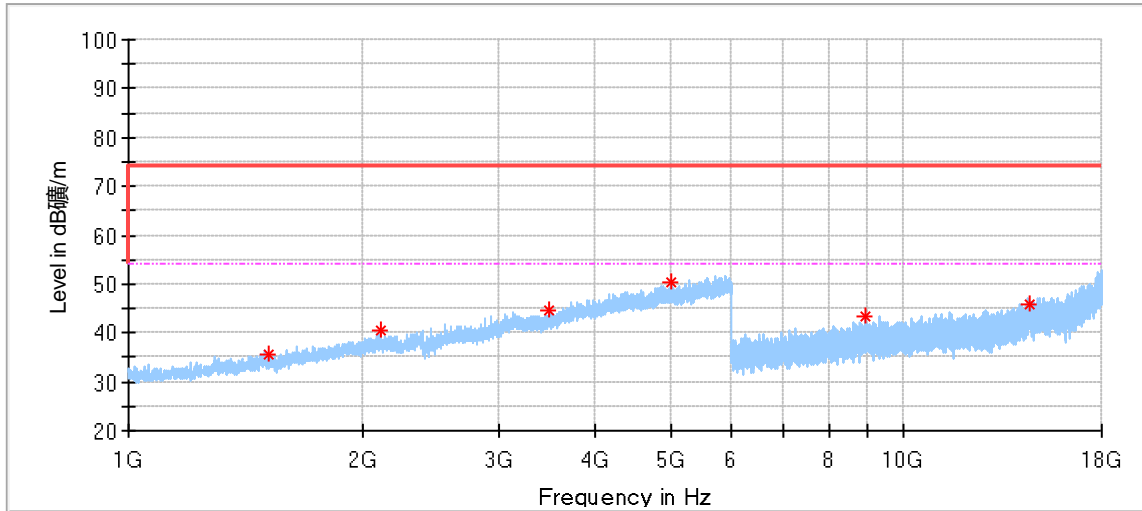

Frequency (MHz)	MaxPeak (dBµV/m)	Limit (dBµV/m)	Margin (dB)	Height (cm)	Pol	Azimuth (deg)	Corr. (dB/m)
1512.500000*	35.79	74.00	38.21	150.0	H	294.0	-9.67
2114.000000	40.57	74.00	33.43	150.0	H	356.0	-5.74
3484.500000	44.58	74.00	29.42	150.0	H	45.0	0.43
5008.000000*	50.18	74.00	23.82	150.0	H	280.0	6.57
8947.500000	43.19	74.00	30.81	150.0	H	89.0	12.49

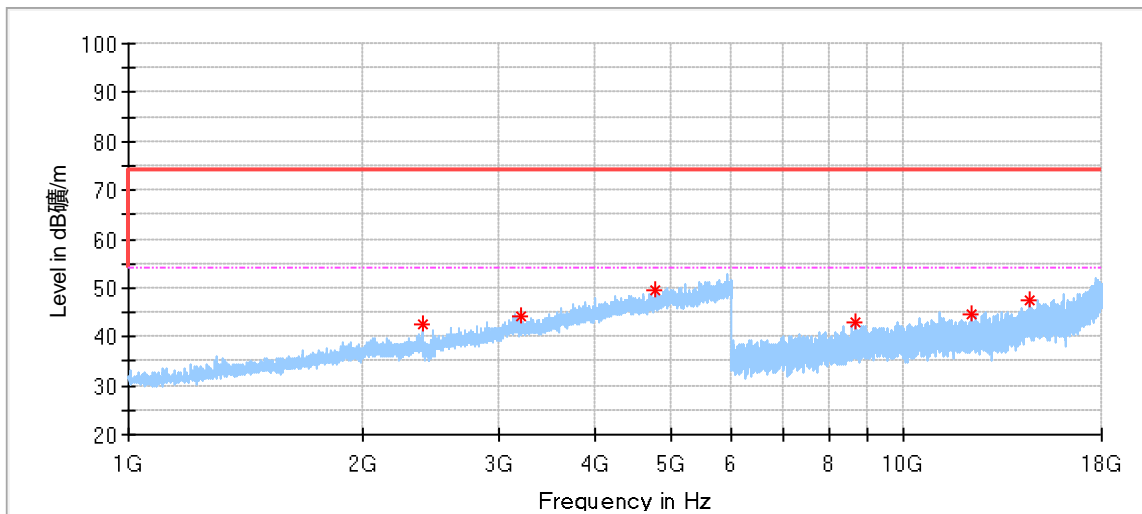

Frequency (MHz)	MaxPeak (dBµV/m)	Limit (dBµV/m)	Margin (dB)	Height (cm)	Pol	Azimuth (deg)	Corr. (dB/m)
2390.500000	42.46	74.00	31.54	150.0	V	226.0	-4.91
3212.500000	44.35	74.00	29.65	150.0	V	34.0	-0.42
4774.500000*	49.70	74.00	24.30	150.0	V	144.0	5.25
8648.000000	43.01	74.00	30.99	150.0	V	204.0	11.72
12195.500000*	44.76	74.00	29.24	150.0	V	204.0	15.22
14514.500000	47.60	74.00	26.40	150.0	V	355.0	18.43

11b_2437MHz_Ant1:

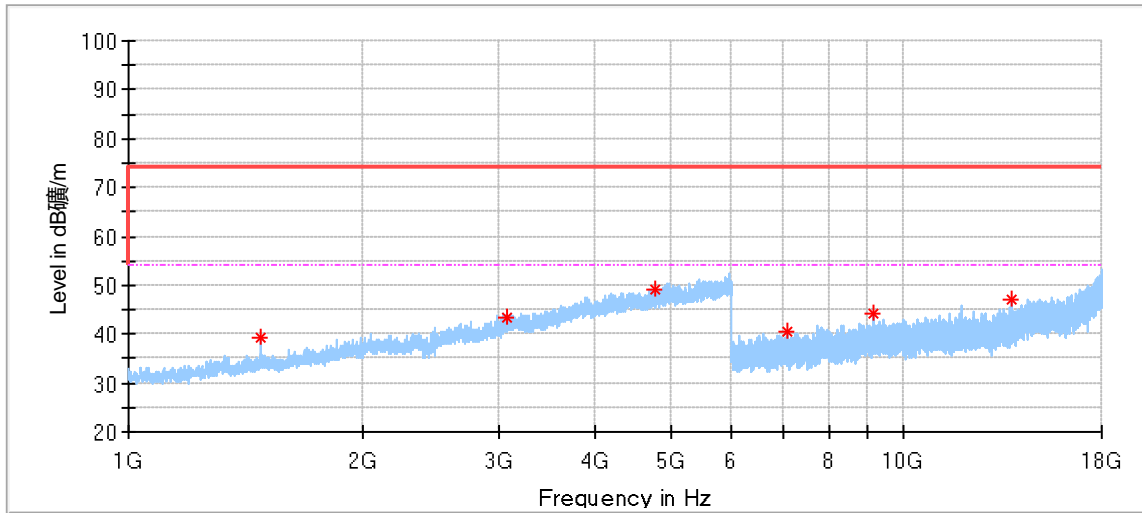

Frequency (MHz)	MaxPeak (dBµV/m)	Limit (dBµV/m)	Margin (dB)	Height (cm)	Pol	Azimuth (deg)	Corr. (dB/m)
1480.500000*	39.17	74.00	34.83	150.0	H	31.0	-9.86
3073.000000	43.52	74.00	30.48	150.0	H	181.0	-0.99
4771.000000*	49.26	74.00	24.74	150.0	H	250.0	5.23
7061.500000	40.45	74.00	33.55	150.0	H	32.0	8.56
9148.500000*	44.01	74.00	29.99	150.0	H	283.0	12.40
13812.500000	46.88	74.00	27.12	150.0	H	229.0	16.49

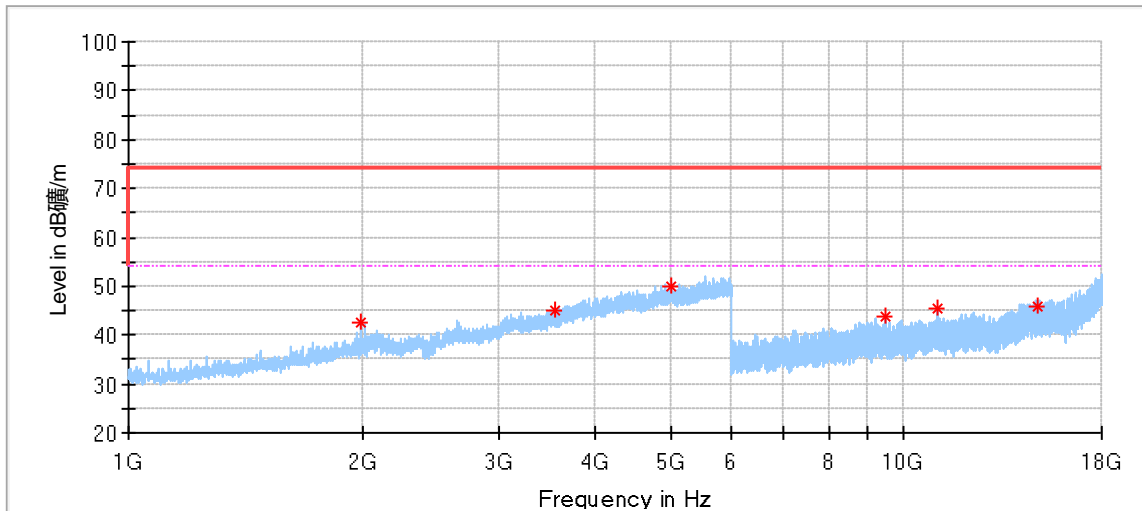

Frequency (MHz)	MaxPeak (dBµV/m)	Limit (dBµV/m)	Margin (dB)	Height (cm)	Pol	Azimuth (deg)	Corr. (dB/m)
1993.000000	42.77	74.00	31.23	150.0	V	294.0	-6.45
3556.000000	44.84	74.00	29.16	150.0	V	86.0	1.00
5006.500000*	50.15	74.00	23.85	150.0	V	335.0	6.57
9450.000000*	43.60	74.00	30.40	150.0	V	201.0	12.81
11047.500000*	45.24	74.00	28.76	150.0	V	333.0	14.02
14908.000000	45.90	74.00	28.10	150.0	V	201.0	19.26

11b_2462MHz_Ant1:

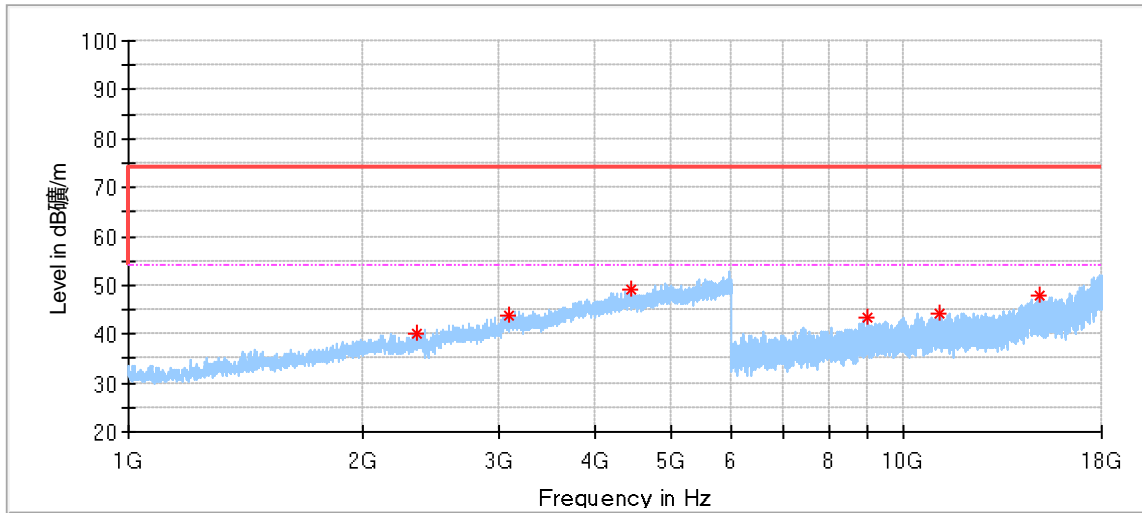

Frequency (MHz)	MaxPeak (dBµV/m)	Limit (dBµV/m)	Margin (dB)	Height (cm)	Pol	Azimuth (deg)	Corr. (dB/m)
2360.500000*	40.11	74.00	33.89	150.0	H	118.0	-4.90
3104.000000	43.82	74.00	30.18	150.0	H	356.0	-0.66
4443.000000	49.06	74.00	24.94	150.0	H	46.0	4.48
8977.000000	43.52	74.00	30.48	150.0	H	229.0	12.48
11091.500000*	44.31	74.00	29.69	150.0	H	334.0	14.10
14987.500000	47.80	74.00	26.20	150.0	H	308.0	19.32

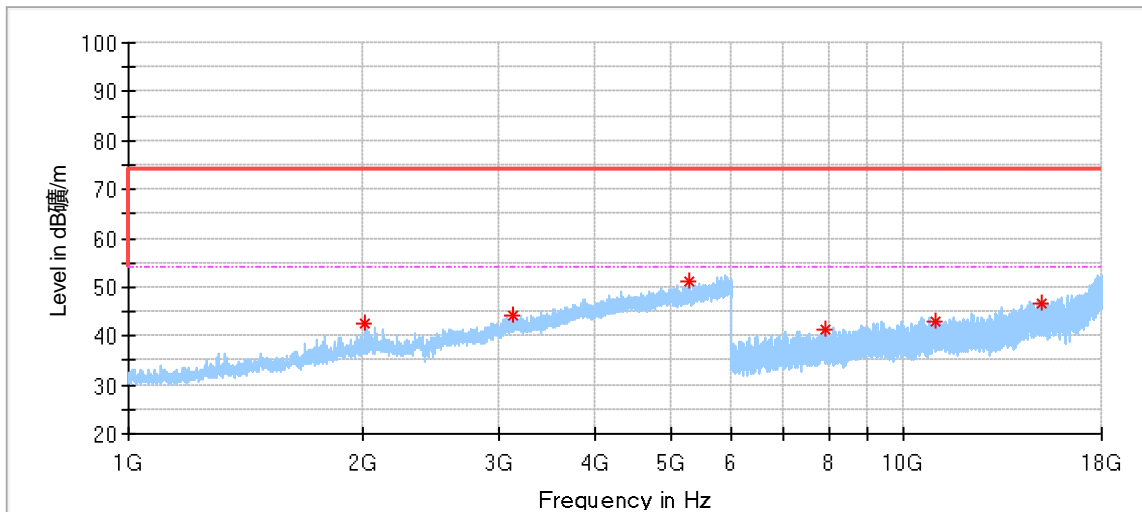

Frequency (MHz)	MaxPeak (dBµV/m)	Limit (dBµV/m)	Margin (dB)	Height (cm)	Pol	Azimuth (deg)	Corr. (dB/m)
2022.500000	42.45	74.00	31.55	150.0	V	292.0	-6.17
3123.500000	44.25	74.00	29.75	150.0	V	0.0	-0.48
5296.000000	51.07	74.00	22.93	150.0	V	19.0	6.70
7918.500000	41.32	74.00	32.68	150.0	V	255.0	9.80
11001.500000*	42.92	74.00	31.08	150.0	V	201.0	13.93
15033.000000	46.86	74.00	27.14	150.0	V	201.0	19.35

11g_2412MHz_Ant1:

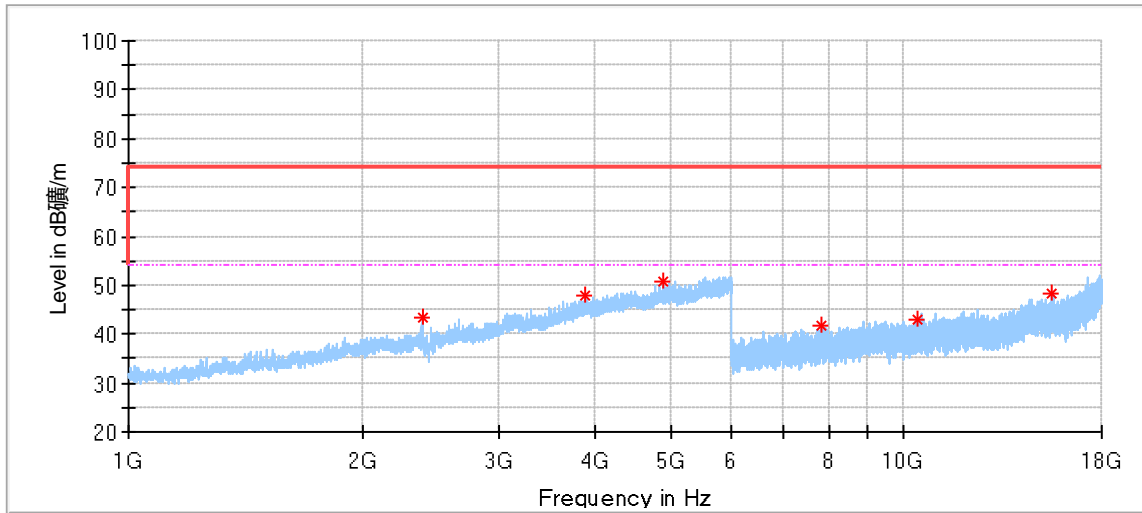

Frequency (MHz)	MaxPeak (dBµV/m)	Limit (dBµV/m)	Margin (dB)	Height (cm)	Pol	Azimuth (deg)	Corr. (dB/m)
2393.000000	43.49	74.00	30.51	150.0	H	298.0	-4.90
3883.500000*	47.95	74.00	26.05	150.0	H	216.0	2.87
4897.000000*	50.64	74.00	23.36	150.0	H	134.0	6.16
7832.500000	41.65	74.00	32.35	150.0	H	271.0	9.86
10440.000000	43.07	74.00	30.93	150.0	H	6.0	13.20
15539.500000*	48.20	74.00	25.80	150.0	H	6.0	20.29

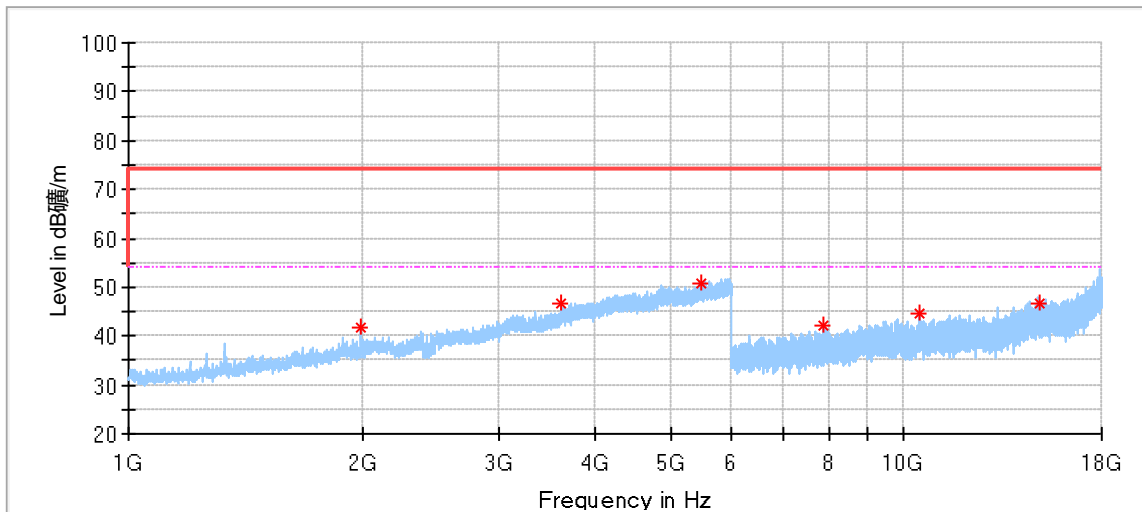

Frequency (MHz)	MaxPeak (dBµV/m)	Limit (dBµV/m)	Margin (dB)	Height (cm)	Pol	Azimuth (deg)	Corr. (dB/m)
1993.500000	41.61	74.00	32.39	150.0	V	39.0	-6.44
3623.000000*	46.75	74.00	27.25	150.0	V	288.0	1.39
5468.500000	50.84	74.00	23.16	150.0	V	13.0	7.45
7884.000000	42.28	74.00	31.72	150.0	V	215.0	9.82
10447.500000	44.81	74.00	29.19	150.0	V	187.0	13.23
14959.000000	46.80	74.00	27.20	150.0	V	78.0	19.30

11g_2437MHz_Ant1:

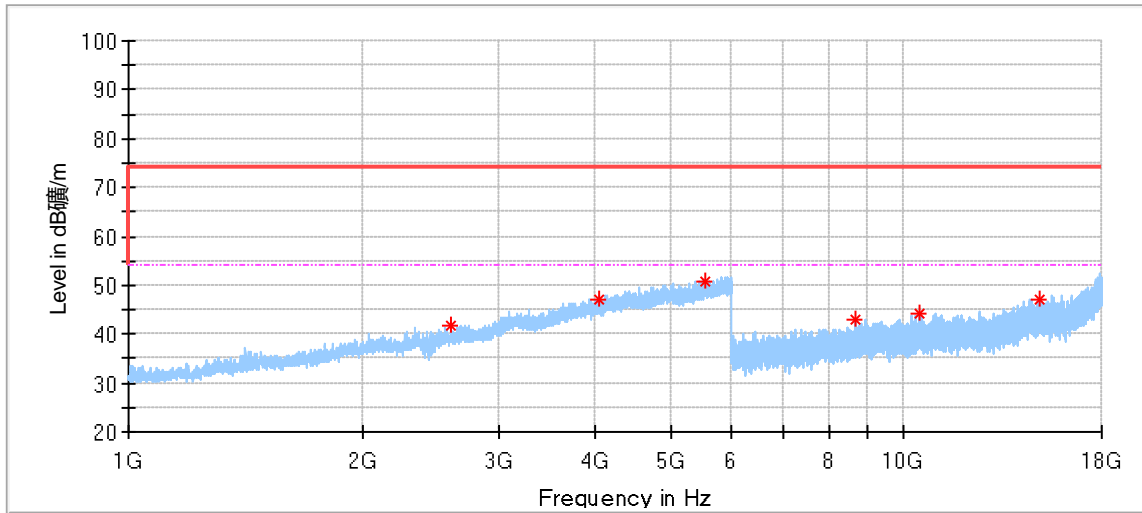

Frequency (MHz)	MaxPeak (dBµV/m)	Limit (dBµV/m)	Margin (dB)	Height (cm)	Pol	Azimuth (deg)	Corr. (dB/m)
2608.000000	41.90	74.00	32.10	150.0	H	0.0	-3.48
4047.500000*	46.96	74.00	27.04	150.0	H	52.0	2.92
5528.500000	50.63	74.00	23.37	150.0	H	312.0	7.59
8651.500000	43.12	74.00	30.88	150.0	H	23.0	11.74
10487.000000	44.12	74.00	29.88	150.0	H	77.0	13.29
14979.000000	47.16	74.00	26.84	150.0	H	103.0	19.31

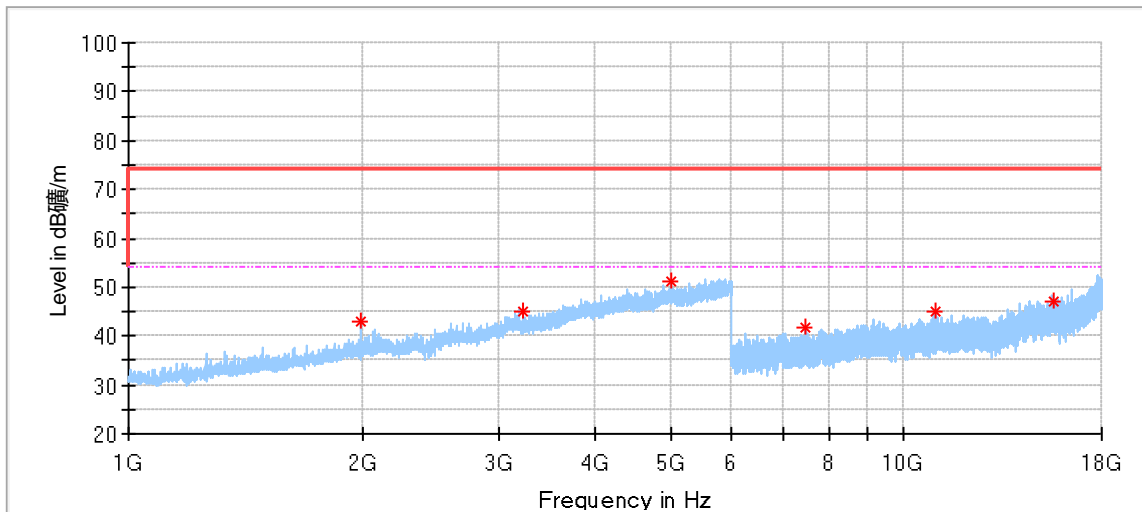

Frequency (MHz)	MaxPeak (dBµV/m)	Limit (dBµV/m)	Margin (dB)	Height (cm)	Pol	Azimuth (deg)	Corr. (dB/m)
1993.000000	42.97	74.00	31.03	150.0	V	271.0	-6.45
3221.500000	45.20	74.00	28.80	150.0	V	121.0	-0.43
5009.500000*	51.16	74.00	22.84	150.0	V	298.0	6.57
7486.500000*	41.73	74.00	32.27	150.0	V	100.0	9.19
10959.500000*	45.07	74.00	28.93	150.0	V	356.0	13.88
15606.500000*	47.08	74.00	26.92	150.0	V	328.0	20.34

11g_2462MHz_Ant1:

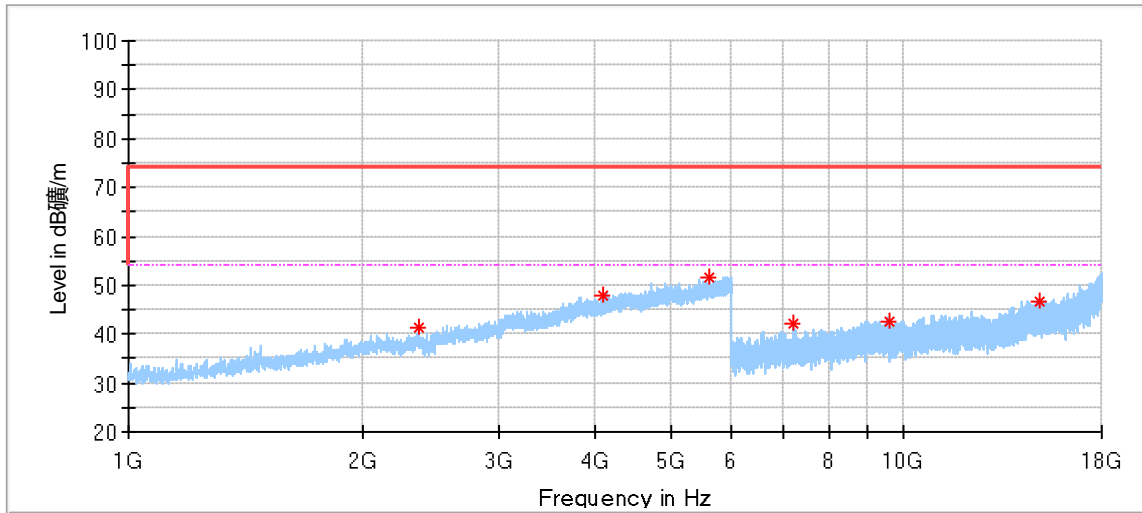

Frequency (MHz)	MaxPeak (dBµV/m)	Limit (dBµV/m)	Margin (dB)	Height (cm)	Pol	Azimuth (deg)	Corr. (dB/m)
2364.500000*	41.13	74.00	32.87	150.0	H	298.0	-4.92
4095.500000*	47.99	74.00	26.01	150.0	H	339.0	3.14
5607.500000	51.46	74.00	22.54	150.0	H	285.0	7.59
7216.500000	42.00	74.00	32.00	150.0	H	243.0	8.96
9558.000000	42.73	74.00	31.27	150.0	H	328.0	12.66
14948.500000	46.62	74.00	27.38	150.0	H	271.0	19.29

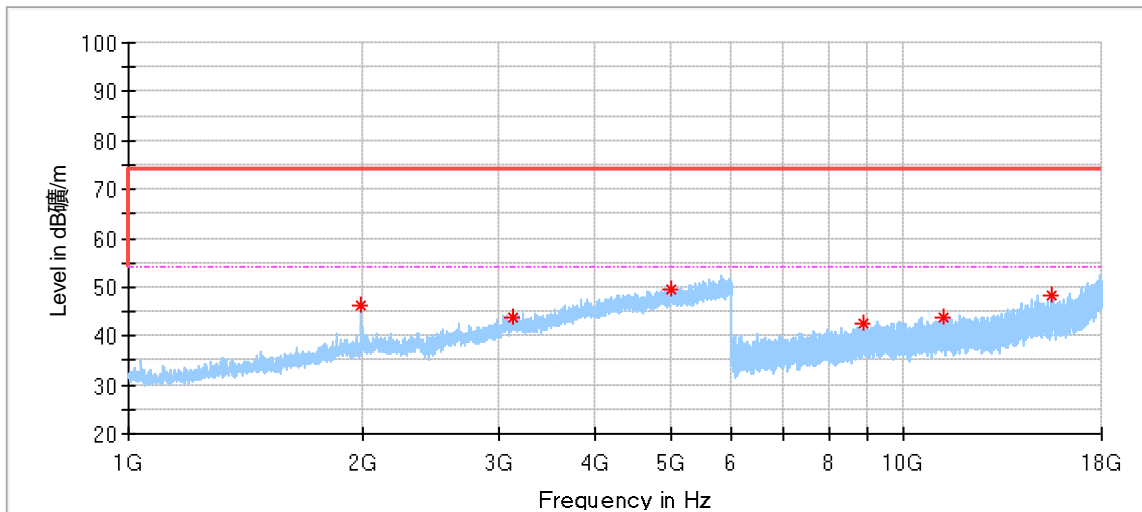

Frequency (MHz)	MaxPeak (dBµV/m)	Limit (dBµV/m)	Margin (dB)	Height (cm)	Pol	Azimuth (deg)	Corr. (dB/m)
1995.500000	46.19	74.00	27.81	150.0	V	302.0	-6.41
3131.500000	43.97	74.00	30.03	150.0	V	13.0	-0.42
5016.500000*	49.66	74.00	24.34	150.0	V	4.0	6.53
8887.500000	42.49	74.00	31.51	150.0	V	356.0	12.45
11278.500000*	43.75	74.00	30.25	150.0	V	215.0	14.37
15548.000000*	48.16	74.00	25.84	150.0	V	299.0	20.29

11n20_2412MHz_Ant1:

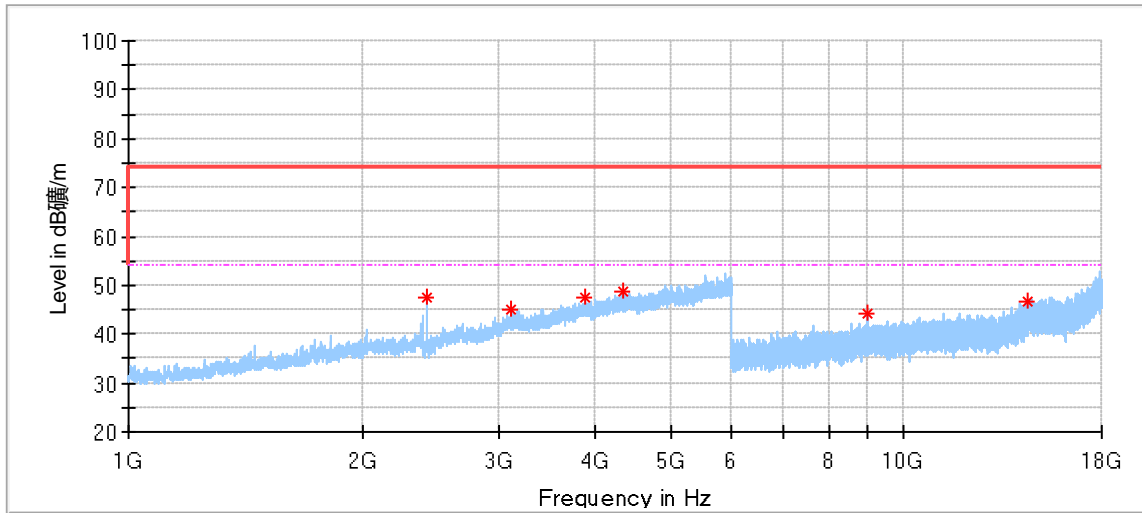

Frequency (MHz)	MaxPeak (dBµV/m)	Limit (dBµV/m)	Margin (dB)	Height (cm)	Pol	Azimuth (deg)	Corr. (dB/m)
2425.500000	47.36	74.00	26.64	150.0	H	326.0	-4.55
3113.500000	45.20	74.00	28.80	150.0	H	134.0	-0.55
3890.000000*	47.68	74.00	26.32	150.0	H	244.0	2.89
4340.000000*	48.66	74.00	25.34	150.0	H	0.0	4.29
8982.000000	44.22	74.00	29.78	150.0	H	243.0	12.48
14416.000000	46.60	74.00	27.40	150.0	H	5.0	17.97

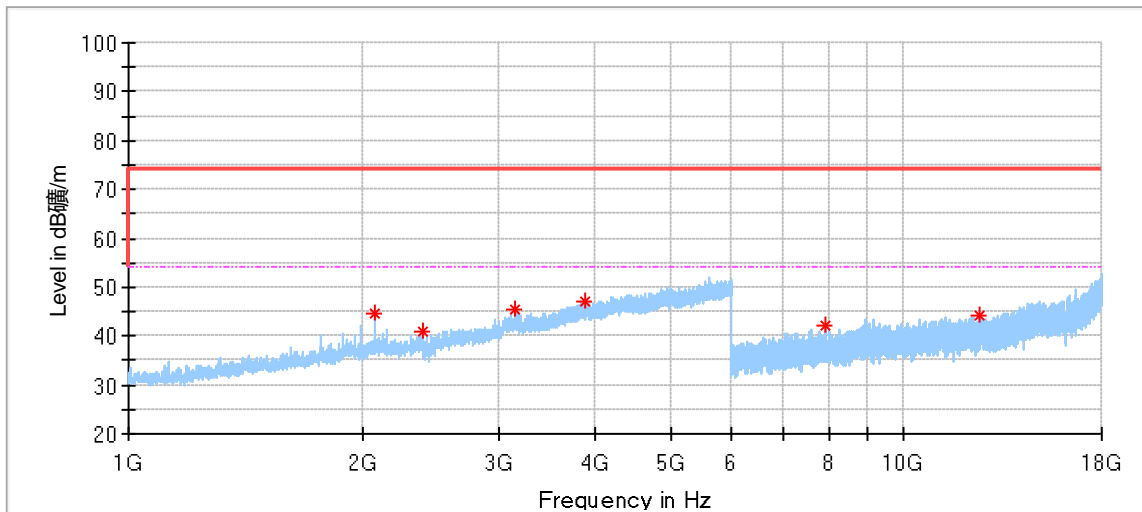

Frequency (MHz)	MaxPeak (dBµV/m)	Limit (dBµV/m)	Margin (dB)	Height (cm)	Pol	Azimuth (deg)	Corr. (dB/m)
2075.000000	44.50	74.00	29.50	150.0	V	298.0	-5.88
2392.500000	41.08	74.00	32.92	150.0	V	230.0	-4.90
3155.000000	45.45	74.00	28.55	150.0	V	13.0	-0.32
3890.000000*	47.25	74.00	26.75	150.0	V	257.0	2.89
7927.000000	42.26	74.00	31.74	150.0	V	295.0	9.80
12511.500000*	44.30	74.00	29.70	150.0	V	128.0	14.84

11n20_2437MHz_Ant1:

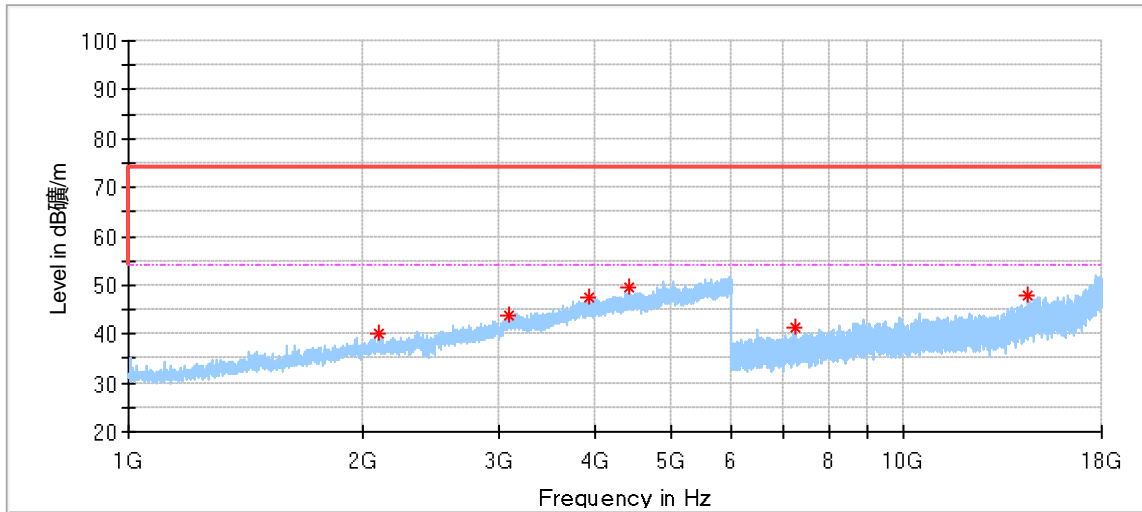

Frequency (MHz)	MaxPeak (dBµV/m)	Limit (dBµV/m)	Margin (dB)	Height (cm)	Pol	Azimuth (deg)	Corr. (dB/m)
2104.500000	40.00	74.00	34.00	150.0	H	253.0	-5.75
3101.000000	43.86	74.00	30.14	150.0	H	86.0	-0.70
3933.000000*	47.30	74.00	26.70	150.0	H	226.0	2.76
4435.500000	49.39	74.00	24.61	150.0	H	2.0	4.49
7257.000000*	41.39	74.00	32.61	150.0	H	60.0	9.03
14485.500000*	47.73	74.00	26.27	150.0	H	353.0	18.29

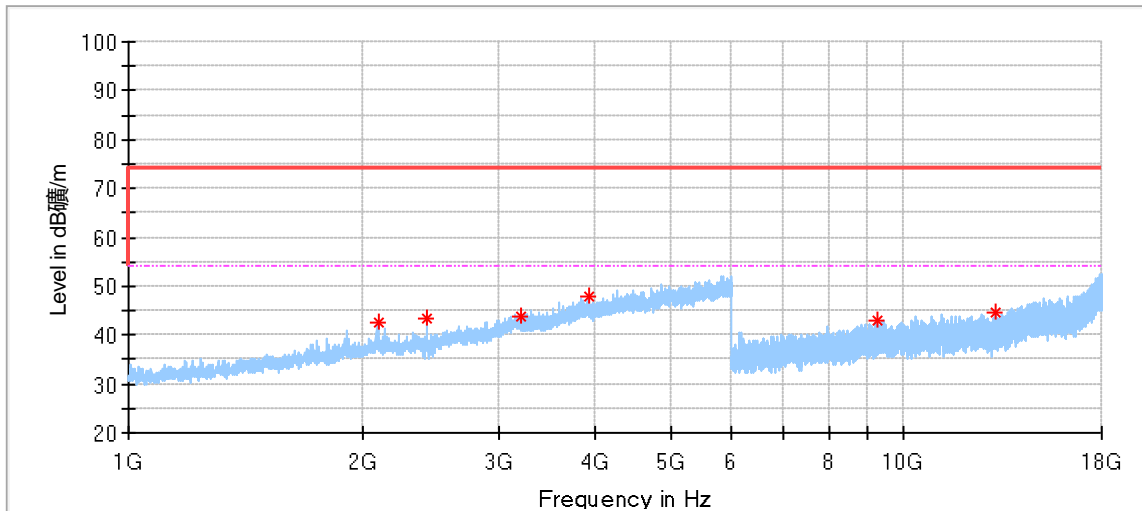

Frequency (MHz)	MaxPeak (dBµV/m)	Limit (dBµV/m)	Margin (dB)	Height (cm)	Pol	Azimuth (deg)	Corr. (dB/m)
2097.000000	42.61	74.00	31.39	150.0	V	216.0	-5.76
2425.500000	43.27	74.00	30.73	150.0	V	357.0	-4.55
3199.000000	43.70	74.00	30.30	150.0	V	107.0	-0.36
3915.500000*	47.99	74.00	26.01	150.0	V	312.0	2.88
9224.500000	43.13	74.00	30.87	150.0	V	156.0	12.64
13170.500000	44.67	74.00	29.33	150.0	V	354.0	14.97

11n20_2462MHz_Ant1:

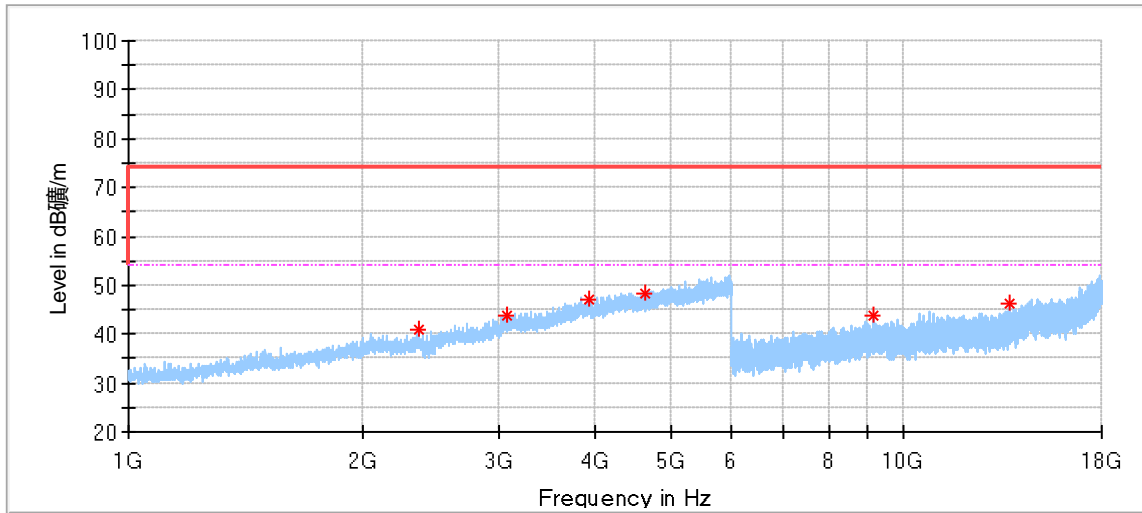

Frequency (MHz)	MaxPeak (dBµV/m)	Limit (dBµV/m)	Margin (dB)	Height (cm)	Pol	Azimuth (deg)	Corr. (dB/m)
2367.500000*	41.11	74.00	32.89	150.0	H	121.0	-4.93
3071.000000	43.85	74.00	30.15	150.0	H	66.0	-0.97
3917.000000*	47.20	74.00	26.80	150.0	H	25.0	2.87
4631.000000*	48.27	74.00	25.73	150.0	H	271.0	4.53
9159.500000*	43.89	74.00	30.11	150.0	H	80.0	12.43
13681.500000	46.07	74.00	27.93	150.0	H	54.0	15.99

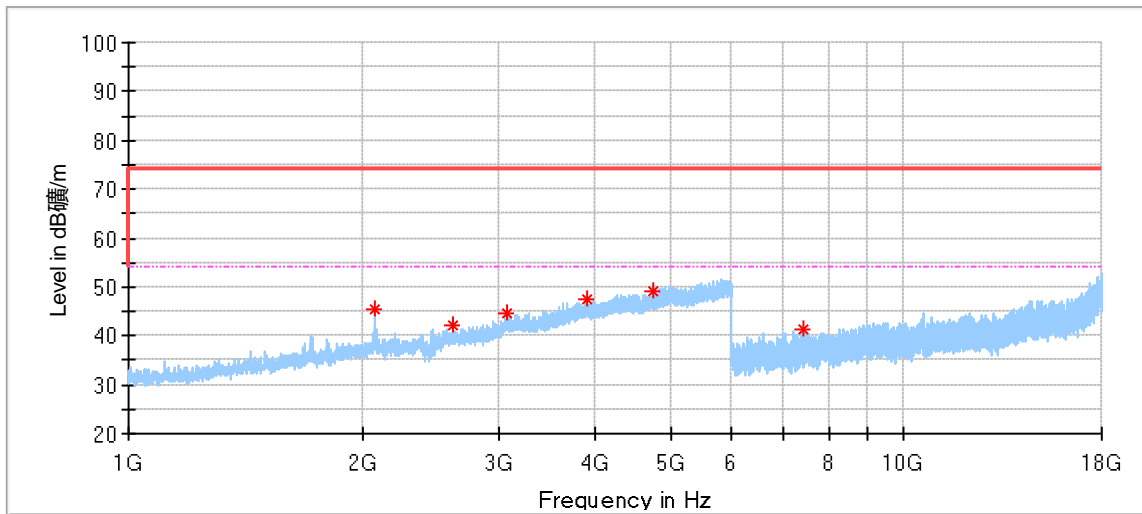

Frequency (MHz)	MaxPeak (dBµV/m)	Limit (dBµV/m)	Margin (dB)	Height (cm)	Pol	Azimuth (deg)	Corr. (dB/m)
2074.500000	45.49	74.00	28.51	150.0	V	302.0	-5.88
2623.500000	42.07	74.00	31.93	150.0	V	25.0	-3.44
3068.500000	44.61	74.00	29.39	150.0	V	93.0	-0.95
3894.000000*	47.32	74.00	26.68	150.0	V	4.0	2.90
4741.500000*	49.26	74.00	24.74	150.0	V	107.0	5.20
7406.500000*	41.21	74.00	32.79	150.0	V	356.0	8.91

18GHz -40GHz:
11b_2412MHz:

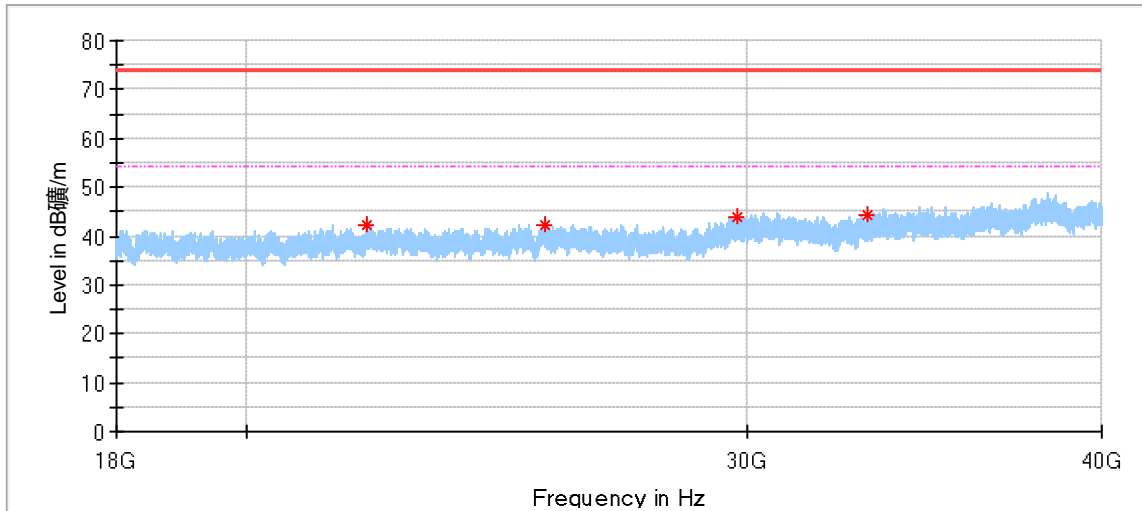

Frequency (MHz)	MaxPeak (dBμV/m)	Limit (dBμV/m)	Margin (dB)	Height (cm)	Pol	Azimuth (deg)	Corr. (dB/m)
22049.375000*	42.29	74.00	31.71	150.0	H	15.0	0.05
25475.875000	42.31	74.00	31.69	150.0	H	339.0	1.46
29746.625000	43.80	74.00	30.20	150.0	H	48.0	1.96
33074.812500	44.50	74.00	29.50	150.0	H	65.0	2.41

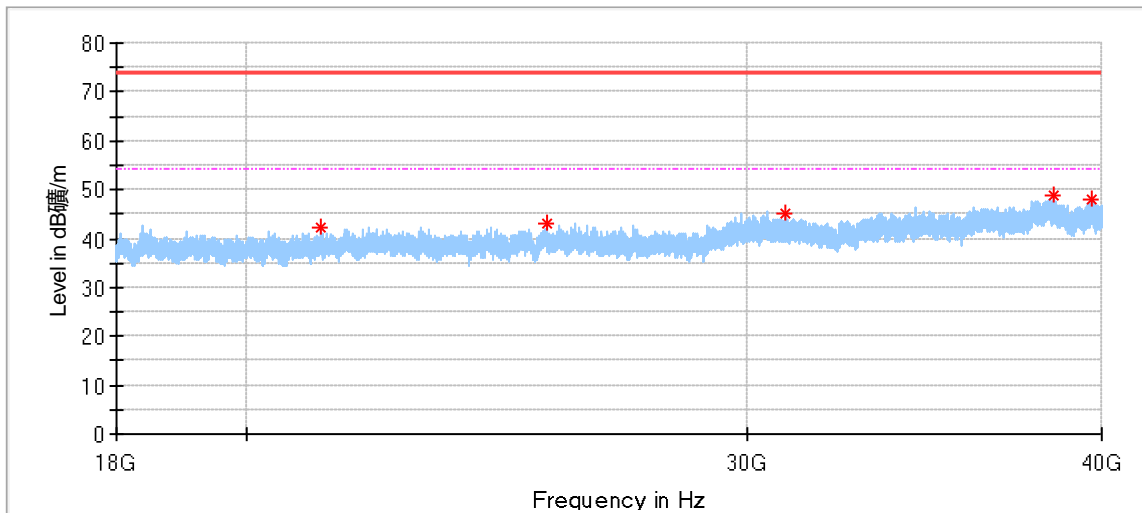

Frequency (MHz)	MaxPeak (dBμV/m)	Limit (dBμV/m)	Margin (dB)	Height (cm)	Pol	Azimuth (deg)	Corr. (dB/m)
21237.437500*	42.20	74.00	31.80	150.0	V	345.0	-0.55
25497.875000	42.88	74.00	31.12	150.0	V	187.0	1.49
30938.750000	45.10	74.00	28.90	150.0	V	263.0	1.66
38496.437500	48.95	74.00	25.05	150.0	V	295.0	6.57
39687.187500	47.80	74.00	26.20	150.0	V	356.0	7.54

11b_2437MHz

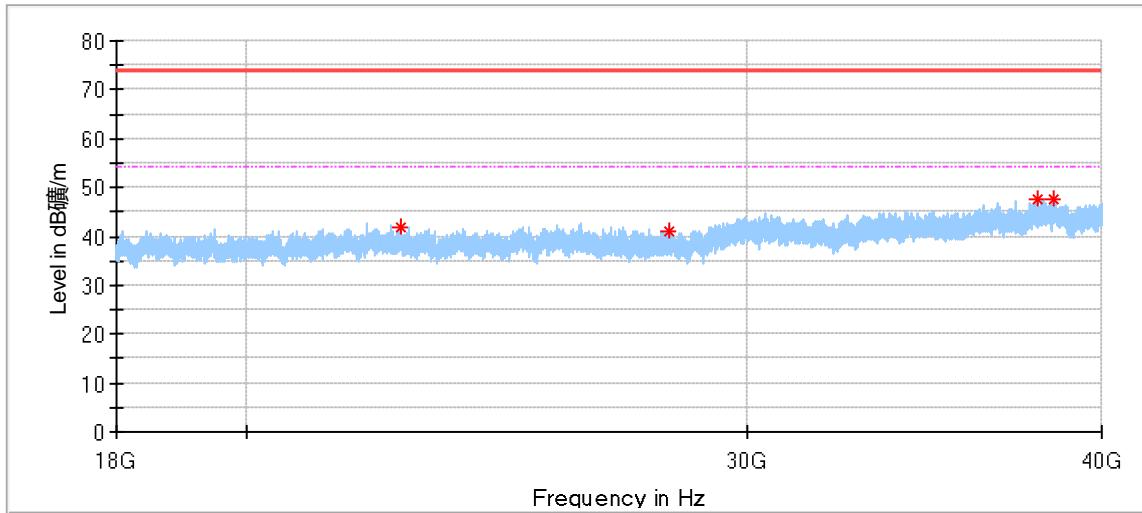

Frequency (MHz)	MaxPeak (dBμV/m)	Limit (dBμV/m)	Margin (dB)	Height (cm)	Pol	Azimuth (deg)	Corr. (dB/m)
22670.875000*	41.78	74.00	32.22	150.0	H	6.0	0.35
28168.812500	40.84	74.00	33.16	150.0	H	95.0	1.17
37998.000000	47.70	74.00	26.30	150.0	H	0.0	5.33
38502.625000	47.50	74.00	26.50	150.0	H	248.0	6.56

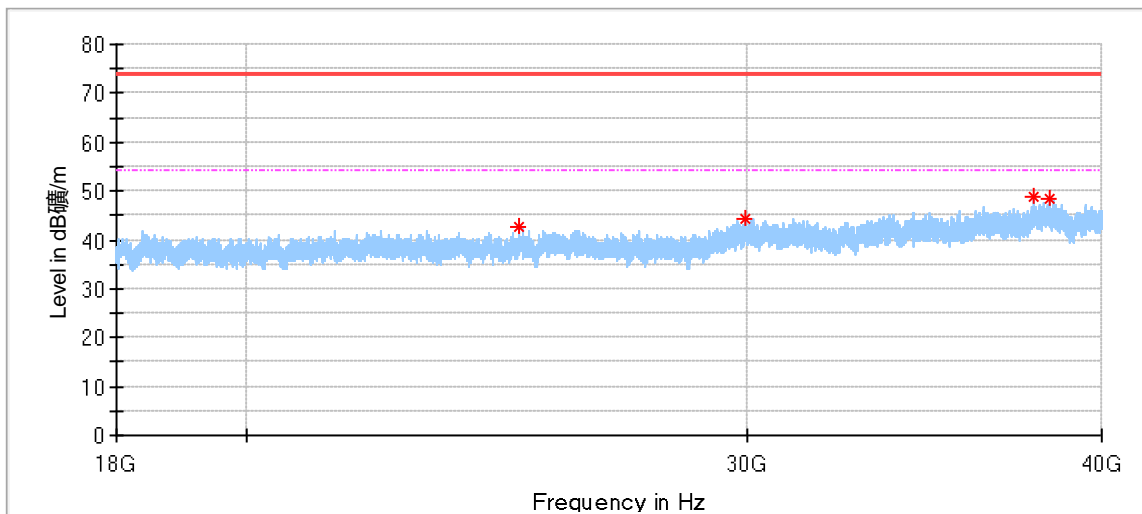

Frequency (MHz)	MaxPeak (dBμV/m)	Limit (dBμV/m)	Margin (dB)	Height (cm)	Pol	Azimuth (deg)	Corr. (dB/m)
24960.250000	42.71	74.00	31.29	150.0	V	193.0	1.17
29972.812500	44.24	74.00	29.76	150.0	V	0.0	2.01
37833.000000	48.75	74.00	25.25	150.0	V	117.0	4.74
38326.625000	48.24	74.00	25.76	150.0	V	178.0	6.49

11b_2462MHz

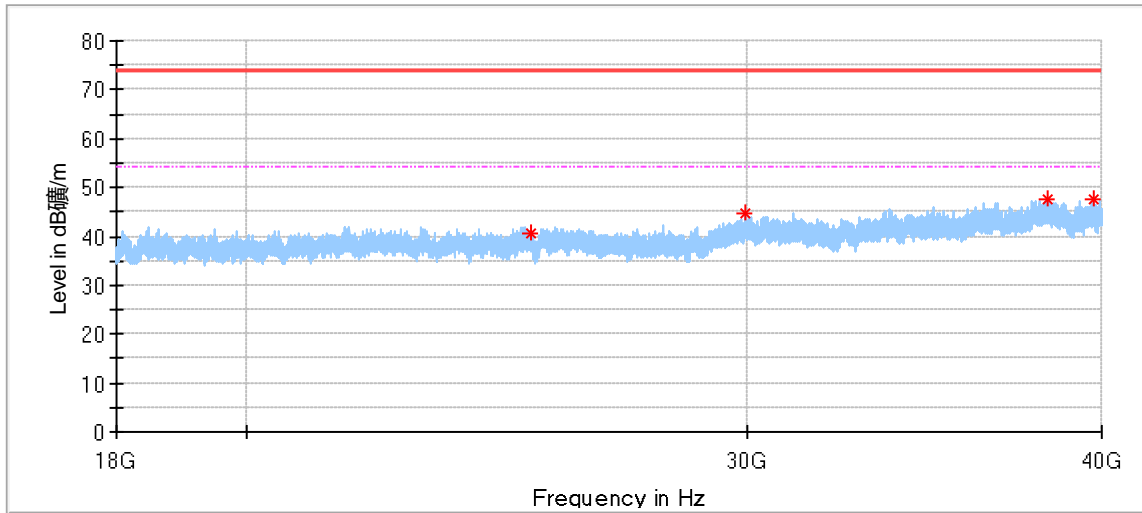

Frequency (MHz)	MaxPeak (dBµV/m)	Limit (dBµV/m)	Margin (dB)	Height (cm)	Pol	Azimuth (deg)	Corr. (dB/m)
25190.562500	40.67	74.00	33.33	150.0	H	356.0	1.28
29986.562500	44.72	74.00	29.28	150.0	H	6.0	2.01
38293.625000	47.60	74.00	26.40	150.0	H	329.0	6.41
39741.500000	47.44	74.00	26.56	150.0	H	46.0	7.71

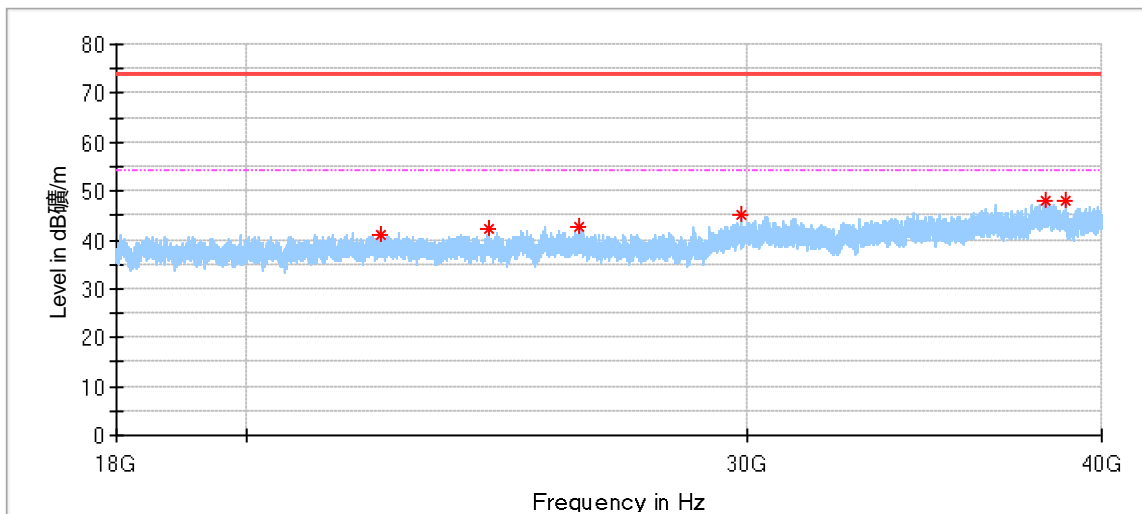

Frequency (MHz)	MaxPeak (dBµV/m)	Limit (dBµV/m)	Margin (dB)	Height (cm)	Pol	Azimuth (deg)	Corr. (dB/m)
22293.437500*	40.95	74.00	33.05	150.0	V	358.0	0.32
24347.000000	42.20	74.00	31.80	150.0	V	234.0	0.56
26202.562500	42.75	74.00	31.25	150.0	V	158.0	1.46
29869.687500	45.32	74.00	28.68	150.0	V	352.0	2.00
38251.687500	48.14	74.00	25.86	150.0	V	295.0	6.22
38842.250000	48.02	74.00	25.98	150.0	V	219.0	5.62

Remark:

- (1) "*" means the emission(s) appear within the restrict bands shall follow the requirement of section 15.205 & RSS-GEN 8.10.
- (2) Only the worst case data of mode 802.11b within frequency range 9kHz-30MHz and 18GHz-40GHz was put in this report.
- (3) Corrected Amplitude = Read level + Corrector factor
 Above 1GHz: Corrector factor = Antenna Factor + Cable Loss- Amplifier Gain
 Below 1GHz: Corrector factor = Antenna Factor + Cable Loss

10 Test Equipment List

Radiated Emission Test(9K – 1GHz)

DESCRIPTION	MANUFACTURER	MODEL NO.	EQUIPMENT ID	SERIAL NO.	CAL INTERVAL (YEAR)	CAL. DUE DATE
EMI Test Receiver	Rohde & Schwarz	ESR 26	68-4-74-14-002	101269	1	2024-5-19
Trilog Super Broadband Test Antenna	Schwarzbeck	VULB 9163	68-4-80-14-002	707	1	2023-7-12
Loop Antenna	Rohde & Schwarz	HFH2-Z2	68-4-80-14-006	100398	1	2023-8-17
Pre-amplifier	Rohde & Schwarz	SCU 18	68-4-29-14-001	102230	1	2024-5-19
Attenuator	Mini-circuits	UNAT-6+	68-4-81-21-002	15542	1	2024-5-19
3m Semi-anechoic chamber	TDK	SAC-3 #2	68-4-90-19-006	----	2	2024-5-28
Test software	Rohde & Schwarz	EMC32	68-4-90-19-006-A01	Version10.3 5.02	N/A	N/A

Radiated Emission 2# Test(1GHz – 40GHz)

DESCRIPTION	MANUFACTURER	MODEL NO.	EQUIPMENT ID	SERIAL NO.	CAL INTERVAL (YEAR)	CAL. DUE DATE
EMI Test Receiver	Rohde & Schwarz	ESR 26	68-4-74-14-002	101269	1	2024-5-20
Wave Guide Antenna	ETS	3117	68-4-80-19-001	00218954	1	2024-4-26
Pre-amplifier	Rohde & Schwarz	SCU 18F	68-4-29-19-001	100745	1	2024-5-19
Pre-amplifier	Rohde & Schwarz	SCU 18F	68-4-29-19-002	100746	1	2024-5-19
Sideband Horn Antenna	Q-PAR	QWH-SL-18-40-K-SG	68-4-80-14-008	12827	1	2023-7-12
Pre-amplifier	Rohde & Schwarz	SCU 40A	68-4-29-14-002	100432	1	2023-7-27
Attenuator	Mini-circuits	UNAT-6+	68-4-81-21-002	15542	1	2024-5-19
3m Semi-anechoic chamber	TDK	SAC-3 #2	68-4-90-19-006	----	2	2024-5-28
Test software	Rohde & Schwarz	EMC32	68-4-90-19-006-A01	Version10.3 5.02	N/A	N/A

Conducted Emission 2# Test

DESCRIPTION	MANUFACTURER	MODEL NO.	EQUIPMENT ID	SERIAL NO.	CAL INTERVAL (YEAR)	CAL. DUE DATE
EMI Test Receiver	Rohde & Schwarz	ESR 3	68-4-74-19-002	102590	1	2024-5-19
LISN	Rohde & Schwarz	ENV216	68-4-87-19-001	102472	1	2024-5-20
Attenuator	Shanghai Huaxiang	TS2-26-3	68-4-81-16-003	080928189	1	2024-5-19
Test software	Rohde & Schwarz	EMC32	68-4-90-19-005-A01	Version10.35. 02	N/A	N/A
Shielding Room	TDK	CSR #2	68-4-90-19-005	----	3	2025-10-15

Conducted RF Test System

DESCRIPTION	MANUFACTURER	MODEL NO.	EQUIPMENT ID	SERIAL NO.	CAL INTERVAL (YEAR)	CAL. DUE DATE
Signal Analyzer	Rohde & Schwarz	FSV40	68-4-74-14-004	101030	1	2024-5-19
RF Switch Module	Rohde & Schwarz	OSP120/OS P-B157	68-4-93-14-003	101226/10085 1	1	2024-5-20
Power Splitter	Weinschel	1580	68-4-85-14-001	SC319	1	2024-5-19
10dB Attenuator	Weinschel	4M-10	68-4-81-14-003	43152	1	2024-5-19
10dB Attenuator	R&S	DNF	68-4-81-14-004	DNF-001	1	2024-5-19
10dB Attenuator	R&S	DNF	68-4-81-14-005	DNF-002	1	2024-5-19
10dB Attenuator	R&S	DNF	68-4-81-14-006	DNF-003	1	2024-5-19
10dB Attenuator	R&S	DNF	68-4-81-14-007	DNF-004	1	2024-5-19
Test software	Tonscend	System for BT/WIFI	68-4-74-14-006-A13	Version 2.6.77.0518	N/A	N/A
Shielding Room	TDK	TS8997	68-4-90-19-003	----	3	2025-10-15

11 System Measurement Uncertainty

For a 95% confidence level, the measurement expanded uncertainties for defined systems, in accordance with the recommendations of ISO 17025 were:

System Measurement Uncertainty	
Test Items	Extended Uncertainty
Uncertainty for Conducted Emission 150kHz-30MHz (for test using AMN ENV432 or ENV4200)	3.57dB
Uncertainty for Radiated Emission in 3m chamber 9kHz-30MHz	4.70dB
Uncertainty for Radiated Emission in new 3m chamber (68-4-90-19-006) 30MHz-1000MHz	Horizontal: 4.59dB; Vertical: 4.75dB
Uncertainty for Radiated Emission in new 3m chamber (68-4-90-19-006) 1000MHz-18000MHz	Horizontal: 5.08dB; Vertical: 5.09dB;
Uncertainty for Radiated Emission 18000MHz-40000MHz	Horizontal: 4.52dB; Vertical: 4.51dB
Uncertainty for Conducted RF test	RF Power Conducted: 1.31dB Frequency test involved: 0.6×10 ⁻⁸ or 1%

Measurement Uncertainty Decision Rule:

Determination of conformity with the specification limits is based on the decision rule according to IEC Guide 115: 2021, clause 4.4.3 and 4.5.1.

---THE END OF REPORT---