

# TEST REPORT

Applicant Name : Anhui Huami Information Technology Co., Ltd.  
 Address : 7/F, Building B2, Huami Global Innovation Center, No. 900, Wang jiang West Road, High-tech Zone, Hefei City Anhui Pilot Free Trade Zone, China  
 Factory1 Name Cosonic Electroacoustic Technology Co., Ltd.  
 Factory1 Address: No.151, Shipai Section, Dongyuan Avenue, Shipai Town Dongguan, Guangdong, China  
 Factory2 Name COSONIC VIETNAM COMPANY LIMITED  
 Factory2 Address: Lot C5-1, Ba Thien II Industrial Park, Thien Ke Ward, Binh Xuyen District, Vinh Phuc Province, Vietnam  
 Report Number : SZNS2230529-30064E-20A  
 FCC ID: 2AC8UA2211

## Test Standard (s)

FCC Part 2.1093

## Sample Description

Product Type: Smart watch  
 Model No.: A2211  
 Multiple Models: N/A  
 Trade Mark: AMAZFIT  
 Date Received: 2023/05/29  
 Date of Test: 2023/06/06  
 Report Date: 2023/06/12

Test Result:	Pass*
--------------	-------

\* In the configuration tested, the EUT complied with the standards above.

## Prepared and Checked By:



Lance Li  
 EMC Engineer

## Approved By:



Candy Li  
 EMC Engineer

Note: This report may contain data that are not covered by the A2LA accreditation and are marked with an asterisk "★". Shenzhen Accurate Technology Co., Ltd. is not responsible for the authenticity of any test data provided by the applicant. Data included from the applicant that may affect test results are marked with an asterisk "\*\*". Customer model name, addresses, names, trademarks etc. are not considered data.

This report cannot be reproduced except in full, without prior written approval of the Company. Unless otherwise stated the results shown in this test report refer only to the sample(s) tested. This report is valid only with a valid digital signature. The digital signature may be available only under the Adobe software above version 7.0.

## Shenzhen Accurate Technology Co., Ltd.

1/F., Building A, Changyuan New Material Port, Science & Industry Park, Nanshan District, Shenzhen, Guangdong, P.R. China  
 Tel: +86 755-26503290 Fax: +86 755-26503290 Web: www.atc-lab.com

<b>Attestation of Test Results</b>			
<b>MODE</b>		<b>Max. SAR Level(s) Reported(W/kg)</b>	<b>Limit (W/kg)</b>
<b>Bluetooth</b>	1g Head SAR	0.01	1.6
	10g Limbs SAR	0.01	4.0
<b>Applicable Standards</b>	<b>FCC 47 CFR part 2.1093</b> Radiofrequency radiation exposure evaluation: portable devices		
	<b>RF Exposure Procedures: TCB Workshop October 2016(Bluetooth Duty Factor)</b>		
	<b>IEEE1528:2013</b> IEEE Recommended Practice for Determining the Peak Spatial-Average Specific Absorption Rate (SAR) in the Human Head from Wireless Communications Devices: Measurement Techniques		
	<b>KDB procedures</b> KDB 447498 D01 General RF Exposure Guidance v06 KDB 865664 D01 SAR Measurement 100 MHz to 6 GHz v01r04 KDB 865664 D02 RF Exposure Reporting v01r02		
<p><b>Note:</b> This wireless device has been shown to be capable of compliance for localized specific absorption rate (SAR) for General Population/Uncontrolled Exposure limits specified in <b>FCC 47 CFR part 2.1093</b> and has been tested in Accordance with the measurement procedures specified in IEEE 1528-2013 and RF exposure KDB procedures.</p> <p><b>The results and statements contained in this report pertain only to the device(s) evaluated.</b></p>			

## TABLE OF CONTENTS

<b>DOCUMENT REVISION HISTORY</b> .....	<b>4</b>
<b>EUT DESCRIPTION</b> .....	<b>5</b>
TECHNICAL SPECIFICATION .....	5
<b>REFERENCE, STANDARDS, AND GUIDELINES</b> .....	<b>6</b>
SAR LIMITS.....	7
<b>FACILITIES</b> .....	<b>8</b>
<b>DESCRIPTION OF TEST SYSTEM</b> .....	<b>9</b>
<b>EQUIPMENT LIST AND CALIBRATION</b> .....	<b>15</b>
EQUIPMENTS LIST & CALIBRATION INFORMATION.....	15
<b>SAR MEASUREMENT SYSTEM VERIFICATION</b> .....	<b>16</b>
LIQUID VERIFICATION .....	16
SYSTEM ACCURACY VERIFICATION.....	17
SAR SYSTEM VALIDATION DATA.....	18
<b>EUT TEST STRATEGY AND METHODOLOGY</b> .....	<b>19</b>
FRONT-OF-FACE DEVICE .....	19
LIMB-WORN DEVICE .....	19
TEST DISTANCE FOR SAR EVALUATION.....	19
SAR EVALUATION PROCEDURE .....	20
<b>CONDUCTED OUTPUT POWER MEASUREMENT</b> .....	<b>21</b>
TEST PROCEDURE .....	21
MAXIMUM TARGET OUTPUT POWER .....	21
<b>STANDALONE SAR TEST EXCLUSION CONSIDERATIONS</b> .....	<b>23</b>
ANTENNA DISTANCE TO EDGE:.....	23
STANDALONE SAR TEST EXCLUSION CONSIDERATIONS .....	24
<b>SAR MEASUREMENT RESULTS</b> .....	<b>25</b>
SAR TEST DATA .....	25
<b>SAR MEASUREMENT VARIABILITY</b> .....	<b>26</b>
<b>SAR SIMULTANEOUS TRANSMISSION DESCRIPTION</b> .....	<b>27</b>
<b>SAR PLOTS</b> .....	<b>28</b>
<b>APPENDIX A MEASUREMENT UNCERTAINTY</b> .....	<b>29</b>
<b>APPENDIX B EUT TEST POSITION PHOTOS</b> .....	<b>30</b>
<b>APPENDIX C PROBE CALIBRATION CERTIFICATES</b> .....	<b>31</b>
<b>APPENDIX D DIPOLE CALIBRATION CERTIFICATES</b> .....	<b>32</b>

## DOCUMENT REVISION HISTORY

Revision Number	Report Number	Description of Revision	Date of Revision
0	SZNS2230529-30064E-20A	Original Report	2023/06/12

## EUT DESCRIPTION

---

This report has been prepared on behalf of *Anhui Huami Information Technology Co., Ltd.* and their product *Smart watch*, Model: **A2211**, SN: **26CG-1**, FCC: **2AC8UA2211** or the EUT (Equipment under Test) as referred to in the rest of this report.

### Technical Specification

<b>Device Type:</b>	Portable
<b>Exposure Category:</b>	Population / Uncontrolled
<b>Antenna Type(s):</b>	Internal Antenna
<b>Operation Mode :</b>	Bluetooth: GFSK, $\pi/4$ -DQPSK, 8DPSK BLE: GFSK
<b>Frequency Band:</b>	Bluetooth: 2402 -2480 MHz(TX&RX) BLE: 2402 -2480 MHz(TX&RX)
<b>Power Source:</b>	Rechargeable Battery
<b>Normal Operation:</b>	Face up and Limbs-worn

## REFERENCE, STANDARDS, AND GUIDELINES

---

### FCC:

The Report and Order requires routine SAR evaluation prior to equipment authorization of portable transmitter devices, including portable telephones. For consumer products, the applicable limit is 1.6 mW/g as recommended by the ANSI/IEEE standard C95.1-1992 [6] for an uncontrolled environment (Paragraph 65). According to the Supplement C of OET Bulletin 65 "Evaluating Compliance with FCC Guide-lines for Human Exposure to Radio frequency Electromagnetic Fields", released on Jun 29, 2001 by the FCC, the device should be evaluated at maximum output power (radiated from the antenna) under "worst-case" conditions for normal or intended use, incorporating normal antenna operating positions, device peak performance frequencies and positions for maximum RF energy coupling.

This report describes the methodology and results of experiments performed on wireless data terminal. The objective was to determine if there is RF radiation and if radiation is found, what is the extent of radiation with respect to safety limits. SAR (Specific Absorption Rate) is the measure of RF exposure determined by the amount of RF energy absorbed by human body (or its parts) – to determine how the RF energy couples to the body or head which is a primary health concern for body worn devices. The limit below which the exposure to RF is considered safe by regulatory bodies in North America is 1.6 mW/g average over 1 gram of tissue mass.

### IC:

The Report and Order requires routine SAR evaluation prior to equipment authorization of portable transmitter devices, including portable telephones. For consumer products, the applicable limit is 1.6 mW/g as recommended by the ISS-102 for an uncontrolled environment. According to the Safety Code 6 Health Canada's Radiofrequency Exposure Guidelines, the device should be evaluated at maximum output power (radiated from the antenna) under "worst-case" conditions for normal or intended use, incorporating normal antenna operating positions, device peak performance frequencies and positions for maximum RF energy coupling.

This report describes the methodology and results of experiments performed on wireless data terminal. The objective was to determine if there is RF radiation and if radiation is found, what is the extent of radiation with respect to safety limits. SAR (Specific Absorption Rate) is the measure of RF exposure determined by the amount of RF energy absorbed by human body (or its parts) – to determine how the RF energy couples to the body or head which is a primary health concern for body worn devices. The limit below which the exposure to RF is considered safe by regulatory bodies in North America is 1.6 mW/g average over 1 gram of tissue mass.

**SAR Limits****FCC Limit(1g Tissue)**

EXPOSURE LIMITS	SAR (W/kg)	
	(General Population / Uncontrolled Exposure Environment)	(Occupational / Controlled Exposure Environment)
Spatial Average (averaged over the whole body)	0.08	0.4
Spatial Peak (averaged over any 1 g of tissue)	<b>1.60</b>	8.0
Spatial Peak (hands/wrists/feet/ankles averaged over 10 g)	4.0	20.0

**IC Limit(1g Tissue)**

EXPOSURE LIMITS	SAR (W/kg)	
	(General Population / Uncontrolled Exposure Environment)	(Occupational / Controlled Exposure Environment)
Spatial Average (averaged over the whole body)	0.08	0.4
Spatial Peak (averaged over any 1 g of tissue)	<b>1.60</b>	8.0
Spatial Peak (hands/wrists/feet/ankles averaged over 10 g)	4.0	20.0

Population/Uncontrolled Environments are defined as locations where there is the exposure of individual who have no knowledge or control of their exposure.

Occupational/Controlled Environments are defined as locations where there is exposure that may be incurred by people who are aware of the potential for exposure (i.e. as a result of employment or occupation).

General Population/Uncontrolled environments Spatial Peak limit(averaged over any 1 g of tissue) 1.6W/kg and Spatial Peak limit(hands/wrists/feet/ankles averaged over 10 g) 4.0W/kg applied to the EUT.

## **FACILITIES**

---

The test site used by Shenzhen Accurate Technology Co., Ltd. to collect test data is located on the Floor 1, KuMaKe Building, Dongzhou Community, Guangming Street, Guangming District, Shenzhen, Guangdong, China.

The test site has been approved by the FCC under the KDB 974614 D01 and is listed in the FCC Public Access Link (PAL) database, FCC Registration No.: 708358, the FCC Designation No.: CN1189.

Accredited by American Association for Laboratory Accreditation (A2LA) The Certificate Number is 4297.01.

Listed by Innovation, Science and Economic Development Canada (ISED), the Registration Number is 30241.



## DESCRIPTION OF TEST SYSTEM

These measurements were performed with the automated near-field scanning system DASY5 from Schmid & Partner Engineering AG (SPEAG) which is the Fifth generation of the system shown in the figure hereinafter:



### DASY5 System Description

The DASY5 system for performing compliance tests consists of the following items:

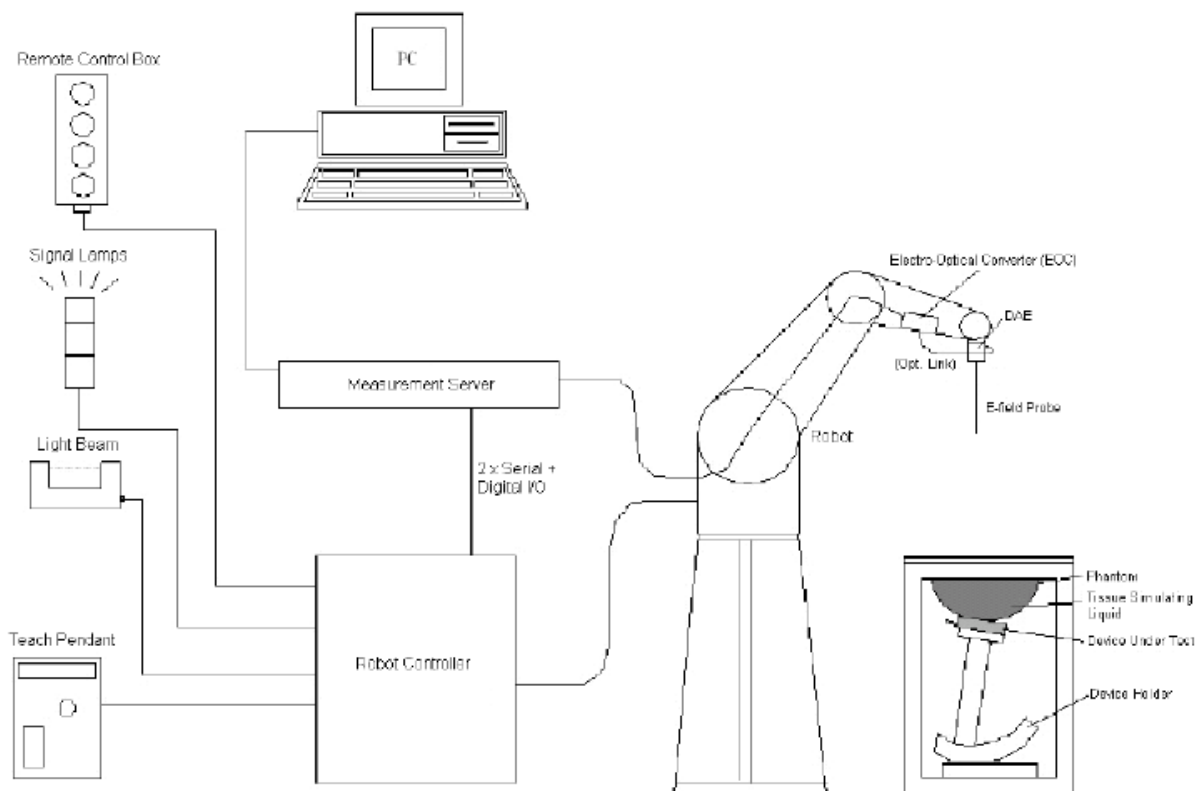

- A standard high precision 6-axis robot (Staubli TX=RX family) with controller, teach pendant and software. An arm extension for accommodating the data acquisition electronics (DAE).
- An isotropic field probe optimized and calibrated for the targeted measurement.
- A data acquisition electronics (DAE) which performs the signal application, signal multiplexing, AD-conversion, offset measurements, mechanical surface detection, collision detection, etc. The unit is battery powered with standard or rechargeable batteries. The signal is optically transmitted to the EOC.
- The Electro-optical converter (EOC) performs the conversion from optical to electrical signals for the digital communication to the DAE. To use optical surface detection, a special version of the EOC is required. The EOC signal is transmitted to the measurement server.
- The function of the measurement server is to perform the time critical tasks such as signal filtering, control of the robot operation and fast movement interrupts.
- The Light Beam used is for probe alignment. This improves the (absolute) accuracy of the probe positioning.
- A computer running Win7 professional operating system and the DASY52 software.
- Remote control and teach pendant as well as additional circuitry for robot safety such as warning lamps, etc.
- The phantom, the device holder and other accessories according to the targeted measurement.

### **DASY5 Measurement Server**

The DASY5 measurement server is based on a PC/104 CPU board with a 400 MHz Intel ULV Celeron, 128 MB chip-disk and 128 MB RAM. The necessary circuits for communication with the DAE4 (or DAE3) electronics box, as well as the 16-bit AD converter system for optical detection and digital I/O interface are contained on the DASY6 I/O board, which is directly connected to the PC/104 bus of the CPU board.

The measurement server performs all real-time data evaluations of field measurements and surface detection, controls robot movements, and handles safety operations. The PC operating system cannot interfere with these time-critical processes. All connections are supervised by a watchdog, and disconnection of any of the cables to the measurement server will automatically disarm the robot and disable all program-controlled robot movements. Furthermore, the measurement server is equipped with an expansion port, which is reserved for future applications. Please note that this expansion port does not have a standardized pinout, and therefore only devices provided by SPEAG can be connected. Connection of devices from any other supplier could seriously damage the measurement server.

### **Data Acquisition Electronics**

The data acquisition electronics (DAE4) consist of a highly sensitive electrometer-grade preamplifier with auto-zeroing, a channel and gain-switching multiplexer, a fast 16 bit AD-converter and a command decoder with a control logic unit. Transmission to the measurement server is accomplished through an optical downlink for data and status information, as well as an optical uplink for commands and the clock.

The mechanical probe mounting device includes two different sensor systems for frontal and sideways probe contacts. They are used for mechanical surface detection and probe collision detection.

The input impedance of both the DAE4 as well as of the DAE3 box is 200M $\Omega$ ; the inputs are symmetrical and floating. Common mode rejection is above 80 dB.

**EX3DV4 E-Field Probes**

<b>Frequency</b>	10 MHz to > 6 GHz Linearity: $\pm 0.2$ dB (30 MHz to 6 GHz)
<b>Directivity</b>	$\pm 0.3$ dB in TSL (rotation around probe axis) $\pm 0.5$ dB in TSL (rotation normal to probe axis)
<b>Dynamic Range</b>	10 $\mu$ W/g to > 100 mW/g Linearity: $\pm 0.2$ dB (noise: typically < 1 $\mu$ W/g)
<b>Dimensions</b>	Overall length: 337 mm (Tip: 20 mm) Tip diameter: 2.5 mm (Body: 12 mm) Typical distance from probe tip to dipole centers: 1 mm
<b>Application</b>	High precision dosimetric measurements in any exposure scenario (e.g., very strong gradient fields); the only probe that enables compliance testing for frequencies up to 6 GHz with precision of better 30%.
<b>Compatibility</b>	DASY3, DASY4, DASY52 SAR and higher, EASY4/MRI

**SAM Twin Phantom**

The SAM Twin Phantom (shown in front of DASY5) is a fiberglass shell phantom with shell thickness 2 mm, except in the ear region where the thickness is increased to 6 mm..

When the phantom is mounted inside allocated slot of the DASY5 platform, phantom reference points can be taught directly in the DASY5 V5.2 software. When the DASY5 platform is used to mount the

Phantom, some of the phantom teaching points cannot be reached by the robot in DASY5 V5.2. A special tool called P1a-P2aX-Former is provided to transform two of the three points, P1 and P2, to reachable locations. To use these new teaching points, a revised phantom configuration file is required.

In addition to our standard broadband liquids, the phantom can be used with the following tissue simulating liquids:

Sugar-water-based liquids can be left permanently in the phantom. Always cover the liquid when the system is not in use to prevent changes in liquid parameters due to water evaporation.

DGBE-based liquids should be used with care. As DGBE is a softener for most plastics, the liquid should be taken out of the phantom, and the phantom should be dried when the system is not in use (desirable at least once a week).

Do not use other organic solvents without previously testing the solvent resistivity of the phantom. Approximately 25 liters of liquid is required to fill the SAM Twin phantom.

**Calibration Frequency Points for EX3DV4 E-Field Probes SN: 3701 Calibrated: 2023/03/15**

Calibration Frequency Point(MHz)	Frequency Range(MHz)		Conversion Factor		
	From	To	X	Y	Z
750 Head	650	850	9.71	9.71	9.71
900 Head	850	1000	9.25	9.25	9.25
1750 Head	1650	1850	7.97	7.97	7.97
1900 Head	1850	2000	7.65	7.65	7.65
2300 Head	2200	2400	7.50	7.50	7.50
2450 Head	2400	2550	7.25	7.25	7.25
2600 Head	2550	2700	7.03	7.03	7.03
5250 Head	5140	5360	5.30	5.30	5.30
5600 Head	5390	5700	4.80	4.80	4.80
5750 Head	5640	5860	4.82	4.82	4.82

**Area scan parameters**

	$\leq 3$ GHz	$> 3$ GHz
Maximum distance from closest measurement point (geometric center of probe sensors) to phantom surface	$5 \text{ mm} \pm 1 \text{ mm}$	$\frac{1}{2} \cdot \delta \cdot \ln(2) \text{ mm} \pm 0.5 \text{ mm}$
Maximum probe angle from probe axis to phantom surface normal at the measurement location	$30^\circ \pm 1^\circ$	$20^\circ \pm 1^\circ$
Maximum area scan spatial resolution: $\Delta x_{\text{Area}}, \Delta y_{\text{Area}}$	$\leq 2$ GHz: $\leq 15 \text{ mm}$ 2 – 3 GHz: $\leq 12 \text{ mm}$	3 – 4 GHz: $\leq 12 \text{ mm}$ 4 – 6 GHz: $\leq 10 \text{ mm}$
	When the x or y dimension of the test device, in the measurement plane orientation, is smaller than the above, the measurement resolution must be $\leq$ the corresponding x or y dimension of the test device with at least one measurement point on the test device.	

**Zoom scan parameters**

Maximum zoom scan spatial resolution, normal to phantom surface	uniform grid: $\Delta z_{\text{Zoom}}(n)$		$\leq 5 \text{ mm}$	3 – 4 GHz: $\leq 4 \text{ mm}$ 4 – 5 GHz: $\leq 3 \text{ mm}$ 5 – 6 GHz: $\leq 2 \text{ mm}$
	graded grid	$\Delta z_{\text{Zoom}}(1)$ : between 1 <sup>st</sup> two points closest to phantom surface	$\leq 4 \text{ mm}$	3 – 4 GHz: $\leq 3 \text{ mm}$ 4 – 5 GHz: $\leq 2.5 \text{ mm}$ 5 – 6 GHz: $\leq 2 \text{ mm}$
		$\Delta z_{\text{Zoom}}(n>1)$ : between subsequent points	$\leq 1.5 \cdot \Delta z_{\text{Zoom}}(n-1) \text{ mm}$	
Minimum zoom scan volume	x, y, z	$\geq 30 \text{ mm}$	3 – 4 GHz: $\geq 28 \text{ mm}$ 4 – 5 GHz: $\geq 25 \text{ mm}$ 5 – 6 GHz: $\geq 22 \text{ mm}$	
Note: $\delta$ is the penetration depth of a plane-wave at normal incidence to the tissue medium; see IEEE Std 1528-2013 for details.				
* When zoom scan is required and the <i>reported</i> SAR from the <i>area scan based 1-g SAR estimation</i> procedures of KDB Publication 447498 is $\leq 1.4 \text{ W/kg}$ , $\leq 8 \text{ mm}$ , $\leq 7 \text{ mm}$ and $\leq 5 \text{ mm}$ zoom scan resolution may be applied, respectively, for 2 GHz to 3 GHz, 3 GHz to 4 GHz and 4 GHz to 6 GHz.				

## Tissue Dielectric Parameters for Head

The head tissue dielectric parameters recommended by the IEC 62209-1:2016

### Recommended Tissue Dielectric Parameters for Head

**Table A.3 – Dielectric properties of the head tissue-equivalent liquid**

Frequency MHz	Relative permittivity $\epsilon_r$	Conductivity ( $\sigma$ ) S/m
300	45,3	0,87
450	43,5	0,87
<i>750</i>	<i>41,9</i>	<i>0,89</i>
835	41,5	0,90
900	41,5	0,97
1 450	40,5	1,20
<i>1 500</i>	<i>40,4</i>	<i>1,23</i>
<i>1 640</i>	<i>40,2</i>	<i>1,31</i>
<i>1 750</i>	<i>40,1</i>	<i>1,37</i>
1 800	40,0	1,40
1 900	40,0	1,40
2 000	40,0	1,40
<i>2 100</i>	<i>39,8</i>	<i>1,49</i>
<i>2 300</i>	<i>39,5</i>	<i>1,67</i>
<i>2 450</i>	<i>39,2</i>	<i>1,80</i>
<i>2 600</i>	<i>39,0</i>	<i>1,96</i>
3 000	38,5	2,40
<i>3 500</i>	<i>37,9</i>	<i>2,91</i>
<i>4 000</i>	<i>37,4</i>	<i>3,43</i>
<i>4 500</i>	<i>36,8</i>	<i>3,94</i>
<i>5 000</i>	<i>36,2</i>	<i>4,45</i>
<i>5 200</i>	<i>36,0</i>	<i>4,66</i>
<i>5 400</i>	<i>35,8</i>	<i>4,86</i>
<i>5 600</i>	<i>35,5</i>	<i>5,07</i>
<i>5 800</i>	<i>35,3</i>	<i>5,27</i>
<i>6 000</i>	<i>35,1</i>	<i>5,48</i>

NOTE For convenience, permittivity and conductivity values at those frequencies which are not part of the original data provided by Drossos et al. [33] or the extension to 5 800 MHz are provided (i.e. the values shown *in italics*). These values were linearly interpolated between the values in this table that are immediately above and below these values, except the values at 6 000 MHz that were linearly extrapolated from the values at 3 000 MHz and 5 800 MHz.

## EQUIPMENT LIST AND CALIBRATION

### Equipments List & Calibration Information

Equipment	Model	S/N	Calibration Date	Calibration Due Date
DASY5 Test Software	DASY52 52.10.4	N/A	NCR	NCR
DASY5 Measurement Server	DASY5 6.0.31	N/A	NCR	NCR
Data Acquisition Electronics	DAE4	1325	2022/08/29	2023/08/28
E-Field Probe	EX3DV4	3701	2023/03/15	2024/03/14
Mounting Device	MD4HHTV5	SD 000 H01 KA	NCR	NCR
SAM Twin Phantom	SAM-Twin V5.0	1744	NCR	NCR
Dipole,2450MHz	D2450V2	751	2020/10/13	2023/10/12
Simulated Tissue Liquid Head	HBBL600-10000V6	SL AAH U16 BC	Each Time	
Network Analyzer	E5071B	MY42403851	2022/12/13	2023/12/12
Dielectric Assessment Kit	DAK-3.5	1320	NCR	NCR
Signal Generator	SMB100A	108362	2022/12/13	2023/12/12
USB wideband power sensor	U2021XA	MY52350001	2022/12/13	2023/12/12
Power Amplifier	CBA 1G-070	T44328	2022/12/13	2023/12/12
Linear Power Amplifier	AS0860-40/45	1060913	2022/12/13	2023/12/12
Directional Coupler	4223-20	3.113.277	2022/12/13	2023/12/12
6dB Attenuator	8493B 6dB Attenuator	2708A 04769	2022/12/13	2023/12/12
Spectrum Analyzer	FSV40	101949	2022/11/25	2023/11/24

# SAR MEASUREMENT SYSTEM VERIFICATION

## Liquid Verification

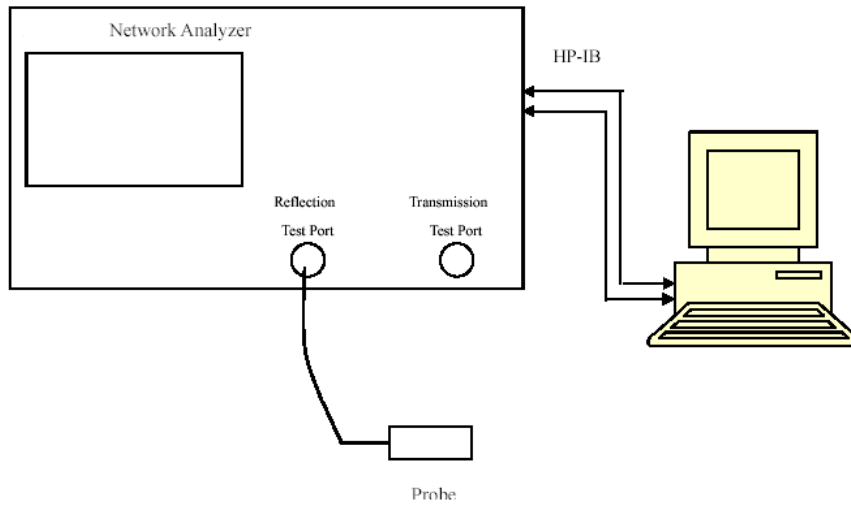

Liquid Verification Setup Block Diagram

## Liquid Verification Results

Frequency (MHz)	Liquid Type	Liquid Parameter		Target Value		Delta (%)		Tolerance (%)
		$\epsilon_r$	$\sigma$ (S/m)	$\epsilon_r$	$\sigma$ (S/m)	$\Delta\epsilon_r$	$\Delta\sigma$	
2402	Simulated Tissue Liquid Head	37.868	1.832	39.28	1.77	-3.59	3.5	$\pm 5$
2441	Simulated Tissue Liquid Head	38.154	1.862	39.22	1.79	-2.72	4.02	$\pm 5$
2450	Simulated Tissue Liquid Head	38.262	1.842	39.20	1.80	-2.39	2.33	$\pm 5$
2480	Simulated Tissue Liquid Head	38.477	1.859	39.17	1.82	-1.77	2.14	$\pm 5$

\*Liquid Verification above was performed on 2023/06/06.



### System Accuracy Verification

Prior to the assessment, the system validation kit was used to test whether the system was operating within its specifications of  $\pm 10\%$ . The validation results are tabulated below. And also the corresponding SAR plot is attached as well in the SAR plots files.

The spacing distances in the **System Verification Setup Block Diagram** is given by the following:

- a)  $s = 15 \text{ mm} \pm 0,2 \text{ mm}$  for  $300 \text{ MHz} \leq f \leq 1 \text{ 000 MHz}$ ;
- b)  $s = 10 \text{ mm} \pm 0,2 \text{ mm}$  for  $1 \text{ 000 MHz} < f \leq 6 \text{ 000 MHz}$ ;

### System Verification Setup Block Diagram

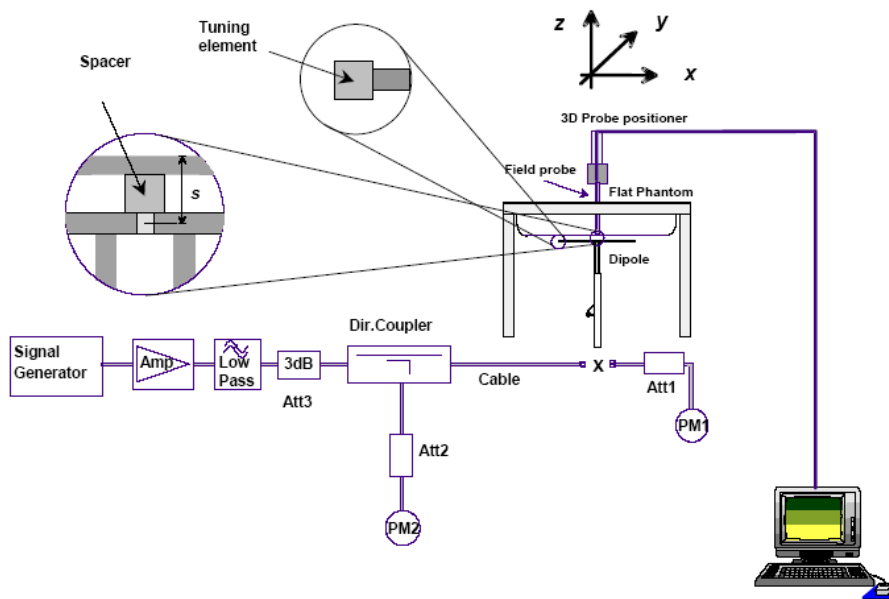

### System Accuracy Check Results

Date	Frequency Band	Liquid Type	Input Power (mW)	Measured SAR (W/kg)		Normalized to 1W (W/kg)	Target Value (W/kg)	Delta (%)	Tolerance (%)
				1g	10g				
2023/06/06	2450 MHz	Head	100	1g	5.19	51.9	53.0	-2.075	$\pm 10$
				10g	2.26	22.6	24.4	-7.377	$\pm 10$

\*The SAR values above are normalized to 1 Watt forward power.

## SAR SYSTEM VALIDATION DATA

### System Performance 2450MHz

**DUT: D2450V2; Type: 2450 MHz; Serial: 751**

Communication System: UID 0, CW (0); Frequency: 2450 MHz; Duty Cycle: 1:1

Medium parameters used:  $f = 2450$  MHz;  $\sigma = 1.842$  S/m;  $\epsilon_r = 38.262$ ;  $\rho = 1000$  kg/m<sup>3</sup>

Phantom section: Flat Section

DASY5 Configuration:

- Probe: EX3DV4- SN3701; ConvF(7.25, 7.25, 7.25); @2450 MHz; Calibrated: 2023/03/15
- Sensor-Surface: 1.4mm (Mechanical Surface Detection)
- Electronics: DAE4 Sn1325; Calibrated: 2022/08/29
- Phantom: Twin SAM; Type: QD000P40CD; Serial: TP:1744
- Measurement SW: DASY52, Version 52.10.2; SEMCAD X Version 14.6.14 (7501)

**System Performance Check at 2450MHz/d=10mm, Pin=100mw/Area Scan (10x11x1):** Measurement grid: dx=10 mm, dy=10 mm

Maximum value of SAR (measured) = 5.27 W/kg

**System Performance Check at 2450MHz/d=10mm, Pin=100mw/Zoom Scan (7x7x7)/Cube 0:** Measurement grid: dx=5mm, dy=5mm, dz=5mm

Reference Value = 63.96 V/m; Power Drift = -0.18 dB

Peak SAR (extrapolated) = 10.2 W/kg

**SAR(1 g) = 5.19 W/kg; SAR(10 g) = 2.26 W/kg**

Maximum value of SAR (measured) = 5.49 W/kg

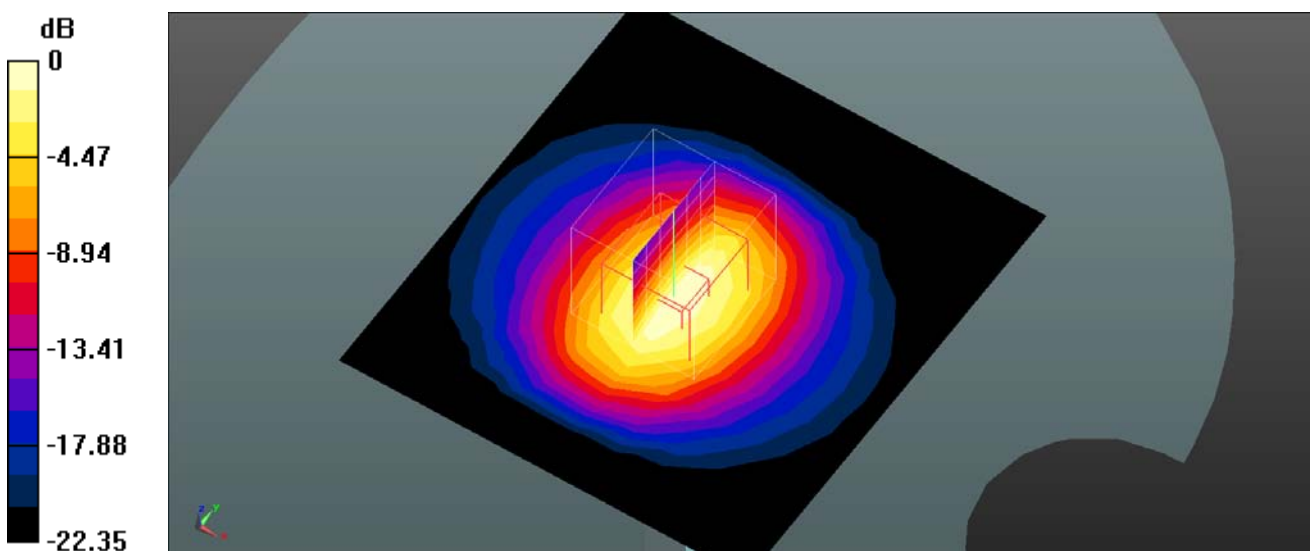

0 dB = 5.49 W/kg = 7.40 dBW/kg

## EUT TEST STRATEGY AND METHODOLOGY

---

### Front-of-face device

A typical example of a front-of-face device is a two-way radio that is held at a close distance from the face of the user while transmitting. Other devices that fall into this category include wireless-enabled still cameras and video cameras capable of sending data to a network or other device and the test separation distance does not exceed 2.5cm.

### Limb-worn device

Limb-worn devices are strapped to the arm or leg of the user while transmitting. These are similar to a body-worn device and the test separation distance is 0mm.

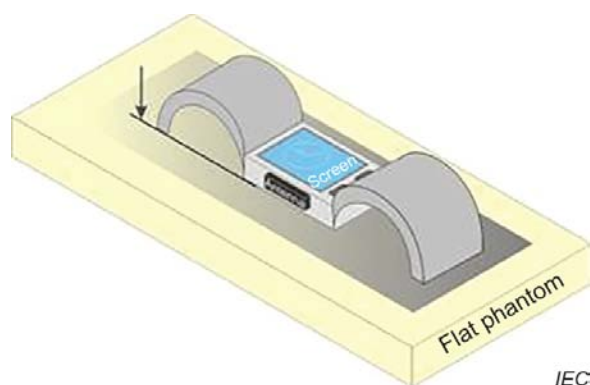

### Test Distance for SAR Evaluation

For this case the EUT(Equipment Under Test) is set 2.5cm away from the phantom for front of face test, and the test distance is 0mm for Limbs-worn test.

## SAR Evaluation Procedure

The evaluation was performed with the following procedure:

Step 1: Measurement of the SAR value at a fixed location above the ear point or central position was used as a reference value for assessing the power drop. The SAR at this point is measured at the start of the test and then again at the end of the testing.

Step 2: The SAR distribution at the exposed side of the head was measured at a distance of 4 mm from the inner surface of the shell. The area covered the entire dimension of the head or radiating structures of the EUT, the horizontal grid spacing was 15 mm x 15 mm, and the SAR distribution was determined by integrated grid of 1.5mm x 1.5mm. Based on these data, the area of the maximum absorption was determined by spline interpolation. The first Area Scan covers the entire dimension of the EUT to ensure that the hotspot was correctly identified.

Step 3: Around this point, a volume of 30 mm x 30 mm x 30 mm was assessed by measuring 7x 7 x 7 points. On the basis of this data set, the spatial peak SAR value was evaluated under the following procedure:

- 1) The data at the surface were extrapolated, since the center of the dipoles is 1.2 mm away from the tip of the probe and the distance between the surface and the lowest measuring point is 1.3 mm. The extrapolation was based on a least square algorithm. A polynomial of the fourth order was calculated through the points in z-axes. This polynomial was then used to evaluate the points between the surface and the probe tip.
- 2) The maximum interpolated value was searched with a straightforward algorithm. Around this maximum the SAR values averaged over the spatial volumes (1 g or 10 g) were computed by the 3D-Spline interpolation algorithm. The 3D-Spline is composed of three one dimensional splines with the "Not a knot"-condition (in x, y and z-directions). The volume was integrated with the trapezoidal-algorithm. One thousand points (10 x 10 x 10) were interpolated to calculate the averages.

All neighboring volumes were evaluated until no neighboring volume with a higher average value was found.

Step 4: Re-measurement of the SAR value at the same location as in Step 1. If the value changed by more than 5%, the evaluation was repeated.

## CONDUCTED OUTPUT POWER MEASUREMENT

### Test Procedure

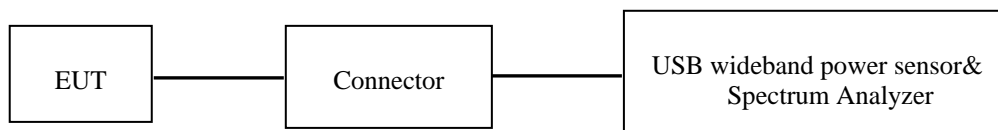

### Bluetooth

### Maximum Target Output Power

Max Target Power(dBm)			
Mode/Band	Channel		
	Low	Middle	High
Bluetooth	10.0	10.0	10.0
BLE	-1.0	-1.0	-1.0

**Test Results:****Bluetooth:**

Mode	Channel frequency (MHz)	RF Output Power (dBm)
BDR(GFSK)	2402	9.16
	2441	9.55
	2480	8.89
EDR( $\pi/4$ -DQPSK)	2402	9.07
	2441	9.49
	2480	8.67
EDR(8DPSK)	2402	7.66
	2441	7.97
	2480	7.26
BLE(1M)	2402	-1.93
	2440	-1.77
	2480	-2.78
BLE(2M)	2402	-2.26
	2440	-1.95
	2480	-2.54

**Duty Cycle:**

Test Mode	Channel	Duty Cycle [%]
BLE_1M	2402	62.90
	2440	62.90
	2480	62.90
BLE_2M	2402	33.87
	2440	33.87
	2480	33.87

Note: Duty cycle data is derived from radio reports.

## Standalone SAR test exclusion considerations

### Antennas Location:

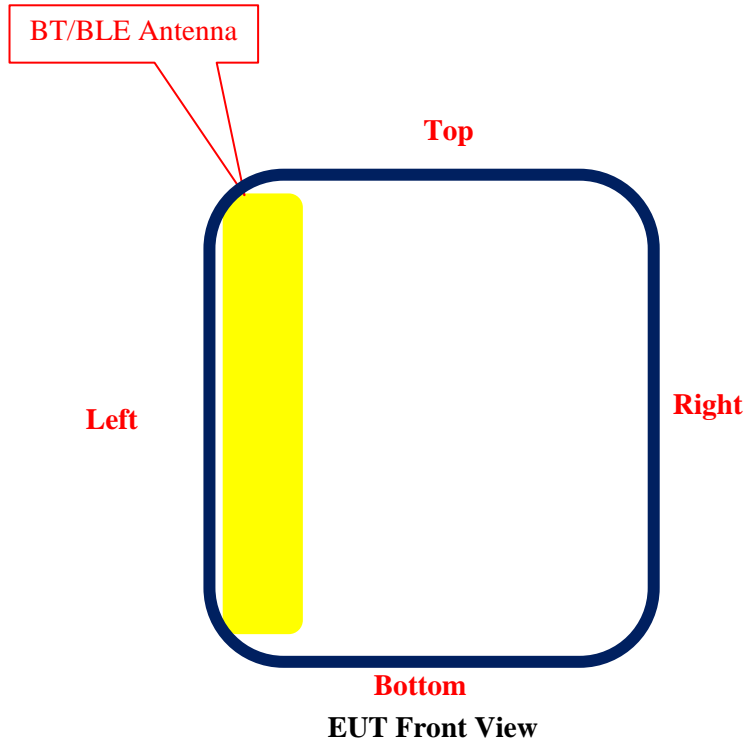

### Antenna Distance To Edge:

Antenna Distance To Edge(mm)						
Antenna	Front	Back	Left	Right	Top	Bottom
BT/BLE Antenna	< 5	< 5	< 5	26	< 5	< 5

*Note: This EUT is form of face and limbs-worn device, for fornt of face test, the maximum distance is not more than 25 mm, limbs-worn is 0 mm test.*

**Standalone SAR test exclusion considerations**

Mode	EUT Position	Frequency (MHz)	Output Power (dBm)	Output Power (mW)	Distance (mm)	Calculated value	Threshold (1-g)	SAR Test Exclusion
Bluetooth	Face up	2480	10.0	10.0	25	0.6	3	Yes*
Bluetooth	Limbs-worn	2480	10.0	10.0	0	3.1	7.5	Yes*

**NOTE:**

The 1-g and 10-g SAR test exclusion thresholds for 100 MHz to 6 GHz at test separation distances  $\leq 50$  mm are determined by:

$[(\text{max. power of channel, including tune-up tolerance, mW}) / (\text{min. test separation distance, mm})] \cdot$

$[\sqrt{f(\text{GHz})}] \leq 3.0$  for 1-g SAR and  $\leq 7.5$  for 10-g extremity SAR, where

1.  $f(\text{GHz})$  is the RF channel transmit frequency in GHz.
2. Power and distance are rounded to the nearest mW and mm before calculation.
3. The result is rounded to one decimal place for comparison.
4. When the minimum test separation distance is  $< 5$  mm, a distance of 5 mm is applied to determine SAR test Exclusion.
5. Yes\* indicates that in order to better reflect the RF exposure, we will conduct SAR tests.



## SAR MEASUREMENT RESULTS

This page summarizes the results of the performed dosimetric evaluation.

### SAR Test Data

#### Environmental Conditions

<b>Temperature:</b>	23.1-23.9 °C
<b>Relative Humidity:</b>	45-59 %
<b>ATM Pressure:</b>	101 kPa
<b>Test Date:</b>	2023/06/06

Testing was performed by Ryse Chai.

#### Bluetooth:

EUT Position	Frequency (MHz)	Test Mode	Max. Meas. Power (dBm)	Max. Rated Power (dBm)	Scaled Factor	Duty Cycle (%)	1g SAR (W/kg)		
							Meas. SAR	Scaled SAR	Plot
Face up (25mm)	2402	GFSK	/	/	/	/	/	/	/
	2441	GFSK	9.55	10.0	1.109	76.74	0.00153	0.01	1#
	2480	GFSK	/	/	/	/	/	/	/

EUT Position	Frequency (MHz)	Test Mode	Max. Meas. Power (dBm)	Max. Rated Power (dBm)	Scaled Factor	Duty Cycle (%)	10g SAR (W/kg)		
							Meas. SAR	Scaled SAR	Plot
Limbs-worn (0mm)	2402	GFSK	/	/	/	/	/	/	/
	2441	GFSK	9.55	10.0	1.109	76.74	0.00285	0.01	2#
	2480	GFSK	/	/	/	/	/	/	/

#### Note:

1. When the 1-g SAR is  $\leq 0.8\text{W/Kg}$ , testing for other channels are optional.
2. When SAR or MPE is not measured at the maximum power level allowed for production units, the results must be scaled to the maximum tune-up tolerance limit according to the power applied to the individual channels tested to determine compliance.
3. According to 2016 Oct. TCB, for SAR testing of GFSK signal with non-100% duty cycle, the measured SAR is scaled-up by the duty cycle scaling factor which is equal to "1/(duty cycle)".

## SAR Measurement Variability

In accordance with published RF Exposure KDB procedure 865664 D01 SAR measurement 100 MHz to 6 GHz v01. These additional measurements are repeated after the completion of all measurements requiring the same head or body tissue-equivalent medium in a frequency band. The test device should be returned to ambient conditions (normal room temperature) with the battery fully charged before it is re-mounted on the device holder for the repeated measurement(s) to minimize any unexpected variations in the repeated results

- 1) Repeated measurement is not required when the original highest measured SAR is < 0.80 W/kg; steps 2) through 4) do not apply.
- 2) When the original highest measured SAR is  $\geq 0.80$  W/kg, repeat that measurement once.
- 3) Perform a second repeated measurement only if the ratio of largest to smallest SAR for the original and first repeated measurements is > 1.20 or when the original or repeated measurement is  $\geq 1.45$  W/kg (~ 10% from the 1-g SAR limit).
- 4) Perform a third repeated measurement only if the original, first or second repeated measurement is  $\geq 1.5$  W/kg and the ratio of largest to smallest SAR for the original, first and second repeated measurements is > 1.20.

### The Highest Measured SAR Configuration in Each Frequency Band

#### Head

SAR probe calibration point	Frequency Band	Freq.(MHz)	EUT Position	Meas. SAR (W/kg)		Largest to Smallest SAR Ratio
				Original	Repeated	
/	/	/	/	/	/	/

#### Body

SAR probe calibration point	Frequency Band	Freq.(MHz)	EUT Position	Meas. SAR (W/kg)		Largest to Smallest SAR Ratio
				Original	Repeated	
/	/	/	/	/	/	/

#### Note:

1. Second Repeated Measurement is not required since the ratio of the largest to smallest SAR for the original and first repeated measurement is not > 1.20.
2. The measured SAR results **do not** have to be scaled to the maximum tune-up tolerance to determine if repeated measurements are required.
3. SAR measurement variability must be assessed for each frequency band, which is determined by the **SAR probe calibration point and tissue-equivalent medium** used for the device measurements..

---

## **SAR SIMULTANEOUS TRANSMISSION DESCRIPTION**

---

### **Simultaneous Transmission:**

Note:

This portable device has no Simultaneous Transmission.

## **SAR Plots**

---

**Please Refer to the Attachment.**

## APPENDIX A MEASUREMENT UNCERTAINTY

The uncertainty budget has been determined for the measurement system and is given in the following Table.  
**Measurement uncertainty evaluation for IEEE1528-2013 SAR test**

Source of uncertainty	Tolerance/uncertainty ± %	Probability distribution	Divisor	ci (1 g)	ci (10 g)	Standard uncertainty ± %, (1 g)	Standard uncertainty ± %, (10 g)
<b>Measurement system</b>							
Probe calibration	6.55	N	1	1	1	6.6	6.6
Axial Isotropy	4.7	R	$\sqrt{3}$	1	1	2.7	2.7
Hemispherical Isotropy	9.6	R	$\sqrt{3}$	0	0	0.0	0.0
Boundary effect	1.0	R	$\sqrt{3}$	1	1	0.6	0.6
Linearity	4.7	R	$\sqrt{3}$	1	1	2.7	2.7
Detection limits	1.0	R	$\sqrt{3}$	1	1	0.6	0.6
Readout electronics	0.3	N	1	1	1	0.3	0.3
Response time	0.0	R	$\sqrt{3}$	1	1	0.0	0.0
Integration time	0.0	R	$\sqrt{3}$	1	1	0.0	0.0
RF ambient conditions – noise	1.0	R	$\sqrt{3}$	1	1	0.6	0.6
RF ambient conditions–reflections	1.0	R	$\sqrt{3}$	1	1	0.6	0.6
Probe positioner mech. Restrictions	0.8	R	$\sqrt{3}$	1	1	0.5	0.5
Probe positioning with respect to phantom shell	6.7	R	$\sqrt{3}$	1	1	3.9	3.9
Post-processing	2.0	R	$\sqrt{3}$	1	1	1.2	1.2
<b>Test sample related</b>							
Test sample positioning	2.8	N	1	1	1	2.8	2.8
Device holder uncertainty	6.3	N	1	1	1	6.3	6.3
Drift of output power	5.0	R	$\sqrt{3}$	1	1	2.9	2.9
<b>Phantom and set-up</b>							
Phantom uncertainty (shape and thickness tolerances)	4.0	R	$\sqrt{3}$	1	1	2.3	2.3
Liquid conductivity target)	5.0	R	$\sqrt{3}$	0.64	0.43	1.8	1.2
Liquid conductivity meas.)	2.5	N	1	0.64	0.43	1.6	1.1
Liquid permittivity target)	5.0	R	$\sqrt{3}$	0.6	0.49	1.7	1.4
Liquid permittivity meas.)	2.5	N	1	0.6	0.49	1.5	1.2
Combined standard uncertainty		RSS				12.2	12.0
Expanded uncertainty 95 % confidence interval)						24.3	23.9

---

## **APPENDIX B EUT TEST POSITION PHOTOS**

---

**Please Refer to the Attachment.**

---

## **APPENDIX C PROBE CALIBRATION CERTIFICATES**

---

**Please Refer to the Attachment.**

---

## **APPENDIX D DIPOLE CALIBRATION CERTIFICATES**

---

**Please Refer to the Attachment.**

**\*\*\*\*\* END OF REPORT \*\*\*\*\***