

<b>Prüfbericht-Nr.:</b> <i>Test Report No.:</i>	<b>50270952 001</b>	<b>Auftrags-Nr.:</b> <i>Order No.:</i>	238106588	Seite 1 von 45 <i>Page 1 of 45</i>	
<b>Kunden-Referenz-Nr.:</b> <i>Client Reference No.:</i>	N/A	<b>Auftragsdatum:</b> <i>Order date:</i>	20-Jun-2019		
<b>Auftraggeber:</b> <i>Client:</i>	Anhui Huami Information Technology Co.,Ltd. Room 1201, Building A4, National Animation Industry Base, No. 800 Wangjiang West Road, Gaoxin District, Hefei, Anhui, China				
<b>Prüfgegenstand:</b> <i>Test item:</i>	Amazfit Strators 3				
<b>Bezeichnung / Typ-Nr.:</b> <i>Identification / Type No.:</i>	A1929				
<b>Auftrags-Inhalt:</b> <i>Order content:</i>	FCC Part 15C, IC RSS-247 Issue 2 (BR/EDR)				
<b>Prüfgrundlage:</b> <i>Test specification:</i>	FCC 47CFR Part 15: Subpart C Section 15.247(FHSS) FCC 47CFR Part 2: Subpart J Section 2.1093 RSS-247 Issue 2 Feb 2017 RSS-102 Issue 5 Mar 2015				
<b>Wareneingangsdatum:</b> <i>Date of receipt:</i>	21-Jun-2019				
<b>Prüfmuster-Nr.:</b> <i>Test sample No.:</i>	A000944312-001, 002				
<b>Prüfzeitraum:</b> <i>Testing period:</i>	27-Jun-2019 ~ 22-Jul-2019				
<b>Ort der Prüfung:</b> <i>Place of testing:</i>	EMC/RF Laboratory Taipei				
<b>Prüflaboratorium:</b> <i>Testing laboratory:</i>	TUV Rheinland Taiwan Ltd.				
<b>Prüfergebnis*:</b> <i>Test result*:</i>	Pass				
<b>geprüft von / tested by:</b>		<b>kontrolliert von / reviewed by:</b>			
2019-08-06 Mars Y.J. Lin/Project Engineer		2019-08-06 Brenda S. H. Chen/ Senior Project Manager			
<b>Datum</b> <i>Date</i>	<b>Name / Stellung</b> <i>Name / Position</i>	<b>Unterschrift</b> <i>Signature</i>	<b>Datum</b> <i>Date</i>	<b>Name / Stellung</b> <i>Name / Position</i>	<b>Unterschrift</b> <i>Signature</i>
<b>Sonstiges / Other:</b>					
<b>Zustand des Prüfgegenstandes bei Anlieferung:</b> <i>Condition of the test item at delivery:</i>		Prüfmuster vollständig und unbeschädigt <i>Test item complete and undamaged</i>			
* Legende: 1 = sehr gut      2 = gut      3 = befriedigend      4 = ausreichend      5 = mangelhaft P(ass) = entspricht o.g. Prüfgrundlage(n)      F(ail) = entspricht nicht o.g. Prüfgrundlage(n)      N/A = nicht anwendbar      N/T = nicht getestet					
Legend: 1 = very good      2 = good      3 = satisfactory      4 = sufficient      5 = poor P(ass) = passed a.m. test specification(s)      F(ail) = failed a.m. test specification(s)      N/A = not applicable      N/T = not tested					
<b>Dieser Prüfbericht bezieht sich nur auf das o.g. Prüfmuster und darf ohne Genehmigung der Prüfstelle nicht auszugsweise vervielfältigt werden. Dieser Bericht berechtigt nicht zur Verwendung eines Prüfzeichens.</b> <i>This test report only relates to the a. m. test sample. Without permission of the test center this test report is not permitted to be duplicated in extracts. This test report does not entitle to carry any test mark.</i>					

## TEST SUMMARY

### 5.1.1 ANTENNA REQUIREMENT

RESULT: *Passed*

### 5.1.2 PEAK OUTPUT POWER

RESULT: *Passed*

### 5.1.3 20dB BANDWIDTH

RESULT: *Passed*

### 5.1.4 99% BANDWIDTH

RESULT: *Passed*

### 5.1.5 CONDUCTED SPURIOUS EMISSIONS AND FREQUENCY BAND EDGE MEASURED IN 100KHZ BANDWIDTH

RESULT: *Passed*

### 5.1.6 SPURIOUS EMISSION

RESULT: *Passed*

### 5.1.7 FREQUENCY SEPARATION

RESULT: *Passed*

### 5.1.8 NUMBER OF HOPPING FREQUENCY

RESULT: *Passed*

### 5.1.9 TIME OF OCCUPANCY

RESULT: *Passed*

### 5.2.1 MAINS CONDUCTED EMISSIONS

RESULT: *Passed*

### 6.1.1 ELECTROMAGNETIC FIELDS

RESULT: *Passed*

## Contents

<b>1.</b>	<b>GENERAL REMARKS .....</b>	<b>5</b>
<b>1.1</b>	<b>COMPLEMENTARY MATERIALS.....</b>	<b>5</b>
<b>2.</b>	<b>TEST SITES .....</b>	<b>6</b>
<b>2.1</b>	<b>TEST LABORATORY .....</b>	<b>6</b>
<b>2.2</b>	<b>TEST FACILITY.....</b>	<b>6</b>
<b>2.3</b>	<b>LIST OF TEST AND MEASUREMENT INSTRUMENTS.....</b>	<b>7</b>
<b>2.4</b>	<b>TRACEABILITY .....</b>	<b>8</b>
<b>2.5</b>	<b>CALIBRATION .....</b>	<b>8</b>
<b>2.6</b>	<b>MEASUREMENT UNCERTAINTY .....</b>	<b>8</b>
<b>3.</b>	<b>GENERAL PRODUCT INFORMATION.....</b>	<b>9</b>
<b>3.1</b>	<b>PRODUCT FUNCTION AND INTENDED USE .....</b>	<b>9</b>
<b>3.2</b>	<b>SYSTEM DETAILS AND RATINGS.....</b>	<b>9</b>
<b>3.3</b>	<b>INDEPENDENT OPERATION MODES.....</b>	<b>11</b>
<b>3.4</b>	<b>NOISE GENERATING AND NOISE SUPPRESSING PARTS .....</b>	<b>11</b>
<b>3.5</b>	<b>SUBMITTED DOCUMENTS.....</b>	<b>11</b>
<b>4.</b>	<b>TEST SET-UP AND OPERATION MODES.....</b>	<b>12</b>
<b>4.1</b>	<b>PRINCIPLE OF CONFIGURATION SELECTION .....</b>	<b>12</b>
<b>4.2</b>	<b>TEST OPERATION AND TEST SOFTWARE.....</b>	<b>12</b>
<b>4.3</b>	<b>SPECIAL ACCESSORIES AND AUXILIARY EQUIPMENT .....</b>	<b>12</b>
<b>4.4</b>	<b>COUNTERMEASURES TO ACHIEVE EMC COMPLIANCE.....</b>	<b>13</b>
<b>4.5</b>	<b>TEST SETUP DIAGRAM .....</b>	<b>13</b>
<b>5.</b>	<b>TEST RESULTS .....</b>	<b>15</b>
<b>5.1</b>	<b>TRANSMITTER REQUIREMENT &amp; TEST SUITES.....</b>	<b>15</b>
<b>5.1.1</b>	<i>Antenna Requirement .....</i>	<i>15</i>
<b>5.1.2</b>	<i>Peak Output Power .....</i>	<i>16</i>
<b>5.1.3</b>	<i>20dB Bandwidth .....</i>	<i>18</i>
<b>5.1.4</b>	<i>99% Bandwidth .....</i>	<i>22</i>
<b>5.1.5</b>	<i>Conducted spurious emissions and Frequency Band Edge measured in 100kHz Bandwidth.....</i>	<i>26</i>
<b>5.1.6</b>	<i>Spurious Emission .....</i>	<i>34</i>
<b>5.1.7</b>	<i>Frequency Separation.....</i>	<i>35</i>
<b>5.1.8</b>	<i>Number of hopping frequency.....</i>	<i>37</i>
<b>5.1.9</b>	<i>Time of Occupancy .....</i>	<i>39</i>
<b>5.2</b>	<b>MAINS EMISSIONS.....</b>	<b>42</b>
<b>5.2.1</b>	<i>Mains Conducted Emissions.....</i>	<i>42</i>

**Prüfbericht - Nr.: 50270952 001**  
*Test Report No.***Seite 4 von 45**  
*Page 4 of 45*

<b>6.</b>	<b>SAFETY HUMAN EXPOSURE .....</b>	<b>43</b>
<b>6.1</b>	<b>RADIO FREQUENCY EXPOSURE COMPLIANCE .....</b>	<b>43</b>
6.1.1	<i>Electromagnetic Fields.....</i>	<i>43</i>
<b>7.</b>	<b>LIST OF TABLES .....</b>	<b>45</b>

## 1. General Remarks

### 1.1 Complementary Materials

The following attachments are integral parts of this test report:

**Appendix P: Photo Documentation**

(File Name: 50270952 50270953 50270954 001 Appendix P)

**Appendix D: Test Result of Radiated Emissions**

(File Name: 50270952 001 Appendix D)

**Appendix E: Photographs of the Test Set-Up**

(File Name: 50270952 50270953 50270954 001 Appendix E)

Test Specifications

The following standards were applied

**Table 1: Applied Standard and Test Levels**

<b>Radio</b>
FCC CFR47 Part 15: Subpart C Section 15.247
FCC 47CFR Part 2: Subpart J Section 2.1093
ANSI C63.10:2013
KDB558074 D01 DTS Meas Guidance v05
RSS-247 Issue 2 Feb 2017
RSS-102 Issue 5 Mar 2015
RSS-Gen Issue 5 Apr 2018

The decision rule of conformity of this test report is following the requirements of the requested standard in the quotation, and agreed among testing laboratory and manufacturer (applicant) to exclude the consideration of Measurement Uncertainty, unless it is required by the specific standard.

## 2. Test Sites

### 2.1 Test Laboratory

TUV Rheinland Taiwan Ltd.  
Taipei Testing Laboratories

11F. No.758, Sec. 4, Bade Rd., Songshan Dist.  
Taipei City 105  
Taiwan (R.O.C.)

### 2.2 Test Facility

TUV Rheinland Taiwan Ltd.

11F. No.758, Sec. 4, Bade Rd., Songshan Dist.  
Taipei City 105  
Taiwan (R.O.C.)

FCC Registration No.: 180491  
IC Canada Registration No.: 9465A  
TAF Accredited NCC Test Lab. No.:3567  
TAF ISO17025 Certification effective period: 6<sup>th</sup>-May-2019 to 05<sup>th</sup>-May-2022



**Testing Laboratory**  
**3567**

## 2.3 List of Test and Measurement Instruments

**Table 2: List of Test and Measurement Equipment**

<b>Equipment</b>	<b>Manufacturer</b>	<b>Model No.</b>	<b>Serial No.</b>	<b>Cal. Date</b>	<b>Cal. Due Date</b>
EMI Test Receiver	Rohde & Schwarz	ESCI 7	100797	2019/01/16	2020/01/16
Two-Line V-Network	Rohde & Schwarz	ENV216	101243	2019/06/23	2020/06/23
Telecom ISN 2 Line	Fischer Custom Communications	FCC-TLISN-T2-02-09	101169	2018/08/24	2019/08/24
Telecom ISN 4 Line	Fischer Custom Communications	FFCC-TLISN-T4-02-09	101168	2019/01/02	2020/01/02
Impedance Stabilization Network	TESEQ	ISN T800	51949	2019/02/20	2020/02/20
Test Software	Audix	e3	Ver. 9	N/A	N/A
EMI Test Receiver	Rohde & Schwarz	ESR 7	101062	2018/10/01	2019/10/01
Spectrum Analyzer	Rohde & Schwarz	FSV-40	101514	2019/02/07	2020/02/07
Pre-Amplifier	Hewlett Packard	8447F	2805A03335	2018/08/22	2019/08/22
Pre-Amplifier	EM Electronics	EM01G18G	060558	2018/11/30	2019/11/30
Pre-Amplifier	EMC Instruments	EMC184045SE	980652	2019/02/25	2020/02/25
Bilog Antenna	TESEQ	CBL 6111D	29802	2018/08/22	2019/08/22
Horn Antenna	ETS-Lindgren	3117	00218931	2018/12/27	2019/12/27
Horn Antenna	Com-Power	AH-840	101029	2018/12/22	2019/12/22
Loop Antenna	Schwarzbeck	FMZB 1513	1513-076	2019/07/11	2020/07/11
Spectrum Analyzer	Agilent	N9010A	MY53470241	2019/06/17	2020/06/17
Power Meter	Anritu	ML2495A	1901008	2019/04/29	2020/04/29

## 2.4 Traceability

All measurement equipment calibrations are traceable to NML(Taiwan)/NIST(USA) or where calibration is performed outside Taiwan, to equivalent nationally recognized standards organizations.

## 2.5 Calibration

requiring calibration is calibrated periodically in a suitably accredited Calibration Lab. Additionally all equipment is verified for proper performance on a regular basis using in house standards or comparisons.

## 2.6 Measurement Uncertainty

The estimated combined standard uncertainty for radiated emissions and conducted emissions measurements:

**Table 3: Emission Measurement Uncertainty**

Parameter	Uncertainty
Radio Frequency	± 0.1 ppm
RF power, conducted	± 1.5 dB
Adjacent channel power	± 3 dB
Radiated emission of transmitter, valid up to 26 GHz	± 6 dB
Radiated emission of receiver, valid up to 26 GHz	± 6 dB
Temperature	± 2 °C
Humidity	± 10 %



### 3. General Product Information

#### 3.1 Product Function and Intended Use

The EUT is a smart watch. It contains a Bluetooth compatible module enabling the user to communicate data through a Wireless interface.  
For details refer to the User Guide, Data Sheet and Block Diagram.

#### 3.2 System Details and Ratings

**Table 4: Basic Information of EUT**

Item	EUT information
Kind of Equipment/Test Item	Amazfit Strators 3
Type Identification	A1929
FCC ID	2AC8UA1929
IC ID	21806-A1929
HVIN	A1929

**Table 5: Technical Specification of EUT**

Technical Specification	Value
Operating Frequency	2402 MHz ~ 2480 MHz
Channel Spacing	1 MHz
Channel number	79
Operation Voltage	5Vdc
Modulation	GFSK, $\pi/4$ DQPSK, 8 DPSK
Antenna gain	-5.4 dBi

**Table 6: Frequency hopping information**

Technical Specification	Description
Hopping Range	<p>Hereby we declare that the maximum frequency of this device is: 2402-2480MHz. This is according the Bluetooth Core Specification V2.1+EDR for devices which will be operated in the USA. This was checked during the Bluetooth Qualification tests (Test Case: TRM/CA/04).</p>
Hopping Sequence	<p>Example of a 79 hopping sequence in data mode:</p> <p>33,04,21,44,23,42,53,46,55,48,40,59,72,29,76,31,08,73,07,75,09,45,60,39,58,13,47,11,77,52,35,50,65,54,67,56,69,62,71,64, 7,25,27,66,57,70,74,61,78,63,10,41,05,43,15,44,64,68,02,70,06,01,51,03,55,05,03,66,53,49,36,47,</p>
Receiver input bandwidth	<p>The input bandwidth of the receiver is 1MHz. In every connection one Bluetooth device is the master and the other one is the slave. The master determines the hopping sequence. The slave follows this sequence. Both devices shift between RX and TX time slot according to the clock of the master.</p> <p>Additionally the type of connection is set up at the beginning of the connection. The master adapts its hopping frequency and its TX/RX timing according to the packet type of the connection. Also the slave of the connection will use these settings.</p> <p>Repeating of a packer has no influence on the hopping sequence. The hopping sequence generated by the master of the connection will be followed in any case.</p> <p>That means a repeated packet will not be send on the same frequency, it is send on the next frequency of the hopping sequence.</p>

### 3.3 Independent Operation Modes

The basic operation modes are:

- A. Transmitting
  - 1. Low channel
  - 2. Middle channel
  - 3. High channel
  
- B. Receiving
  - 1. Low channel
  - 2. Middle channel
  - 3. High channel
  
- C. Hopping
- D. Normal

### 3.4 Noise Generating and Noise Suppressing Parts

Refer to the Block Diagram.

### 3.5 Submitted Documents

- Block Diagram
- Instruction Manual
- Rating Label
- Technical Description

## 4. Test Set-up and Operation Modes

### 4.1 Principle of Configuration Selection

The equipment under test (EUT) was configured to measure its maximum power level. The test modes were adapted accordingly in reference to the instructions for use.

### 4.2 Test Operation and Test Software

Setup for testing: Test samples are provided with a USB interface which makes it possible to control them through a test software installed on a notebook computer.

This software adb.exe was running on the laptop computer connected to the EUT. It was used to enable the operation modes listed in section 3.3 as appropriate.

The samples were used as follows:  
A000944312-001 for Conducted test  
A000944312-002 for Radiated test

Full test was applied on all test modes, but only worst case was shown.

### 4.3 Special Accessories and Auxiliary Equipment

The product has been tested together with the following additional accessories:

Kind of Equipment	Manufacturer	Model Name	S/N
Notebook(EMC-05)	Lenovo	TP00048A	PB-0F8B2

## 4.4 Countermeasures to achieve EMC Compliance

The test sample which has been tested containing the noise suppression parts as in the Photo Appendix and the Test Setup Photos. No additional measures were employed to achieve compliance.

## 4.5 Test Setup Diagram

### Diagram of Measurement Configuration for Radiation Test

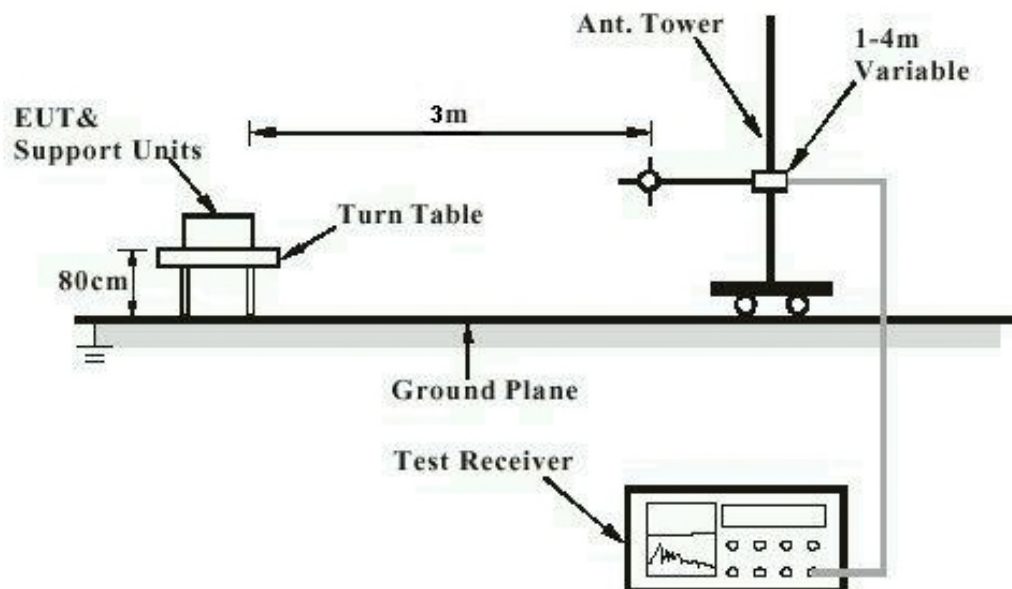

Note: Measurements above 1 GHz are done with a table height of 1.5m

**Diagram of Measurement Equipment Configuration for Mains Conduction Measurement**

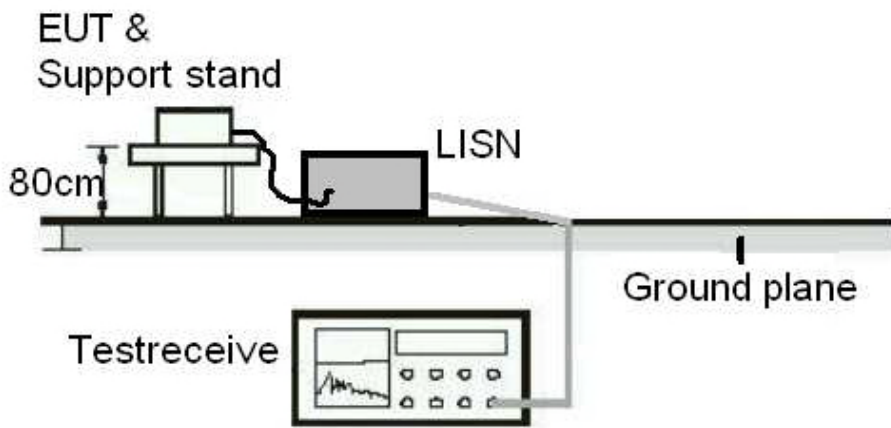

**Diagram of Measurement Equipment Configuration for Conducted Transmitter Measurement**

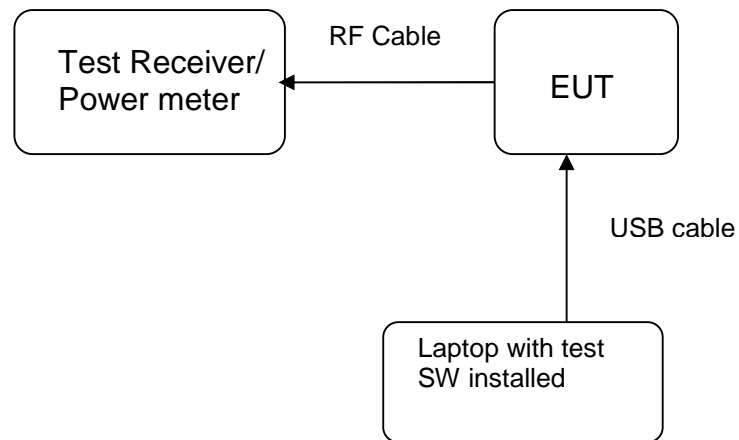

## 5. Test Results

### 5.1 Transmitter Requirement & Test Suites

#### 5.1.1 Antenna Requirement

**RESULT:** **Passed**

Test standard : FCC Part 15.247(b)(4), Part 15.203 and RSS-Gen 6.8

Requirement : use of approved antennas only with directional gains that do not exceed 6 dBi

According to the manufacturer declaration, the EUT has an antenna with a directional gain of -5.4 dBi . The antenna is a metal frame antenna with no possibility of replacement with a non-approved antenna by the end-user. Therefore, the EUT is considered to comply with this provision.

Refer to EUT photo for details.

### 5.1.2 Peak Output Power

**RESULT:**
**Passed**

Test standard : FCC Part 15.247(b)(1),  
 RSS-247 5.4(b)  
 Basic standard : ANSI C63.10 (2013)  
 Kind of test site : Shielded room

**Test setup**

Test Channel : Low/ Middle/ High  
 Operation Mode : A  
 Ambient temperature : 22-26 °C  
 Relative humidity : 50-65 %  
 Atmospheric pressure : 100-103 kPa

**Table 7: Test result of Peak Output Power, GFSK modulation**

Channel	Channel Frequency	Peak Output Power		Limit
	(MHz)	(dBm)	(W)	(W)
Low Channel	2402	9.94	0.00986	0.125
Middle Channel	2441	9.98	0.00995	0.125
High Channel	2480	9.96	0.00991	0.125

**Table 8: Test result of Peak Output Power, 8DPSK modulation**

Channel	Channel Frequency	Peak Output Power		Limit
	(MHz)	(dBm)	(W)	(W)
Low Channel	2402	8.81	0.00760	0.125
Middle Channel	2441	9.44	0.00879	0.125
High Channel	2480	9.43	0.00877	0.125

Maximum Peak Power : 9.9541mW



**Table 9: Test result of Maximum Average Power, GFSK modulation**

Channel	Channel Frequency	Peak Output Power		Limit
	(MHz)	(dBm)	(W)	(W)
Middle Channel	2441	9.79	0.00953	0.125

### 5.1.3 20dB Bandwidth

**RESULT:**
**Passed**

Test standard : FCC Part 15.247(a)(1),  
 RSS-247 5.1(a)  
 Basic standard : ANSI C63.10 (2013)  
 Kind of test site : Shielded room

**Test setup**

Test Channel : Low/ Middle/ High  
 Operation Mode : A  
 Ambient temperature : 22-26°C  
 Relative humidity : 50-65%  
 Atmospheric pressure : 100-103kPa

**Table 10: Test result of 20dB Bandwidth, GFSK modulation**

Channel	Channel Frequency (MHz)	20dB Bandwidth (kHz)	Limit (MHz)	Result
Low Channel	2402	1.013	1.5	Pass
Mid Channel	2441	1.009	1.5	Pass
High Channel	2480	1.018	1.5	Pass

Note: Limit is for Channel Separation of 1 MHz and a power limit of 125 mW.

**Table 11: Test result of 20dB Bandwidth, 8DPSK modulation**

Channel	Channel Frequency (MHz)	20dB Bandwidth (MHz)	Limit (MHz)	Result
Low Channel	2402	1.315	1.5	Pass
Mid Channel	2441	1.315	1.5	Pass
High Channel	2480	1.314	1.5	Pass

Note: Limit is for Channel Separation of 1 MHz and a power limit of 125 mW.

If the carrier separation frequency of a Bluetooth Device is set at 1 MHz due to the firmware setting and the Bluetooth Standard, then for power <125 mW the limit for the 20 dB Bandwidth, becomes  $1 \text{ MHz} / 0.66666 = 1.5 \text{ MHz}$ .

## Test Plot of 20dB Bandwidth, GFSK modulation

### Low Channel

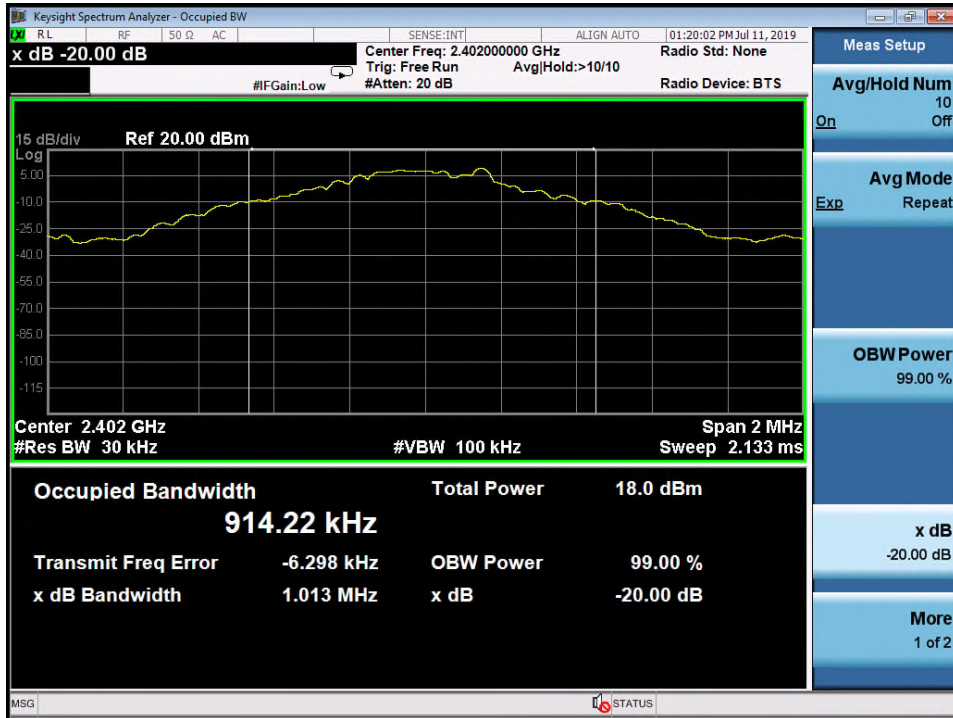

### Middle Channel

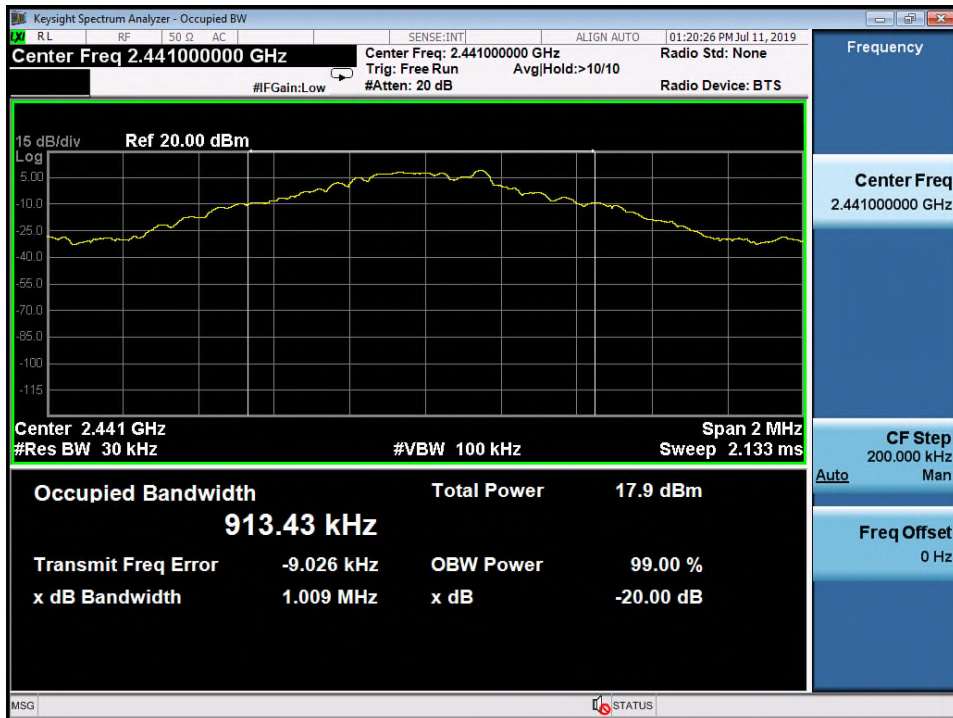

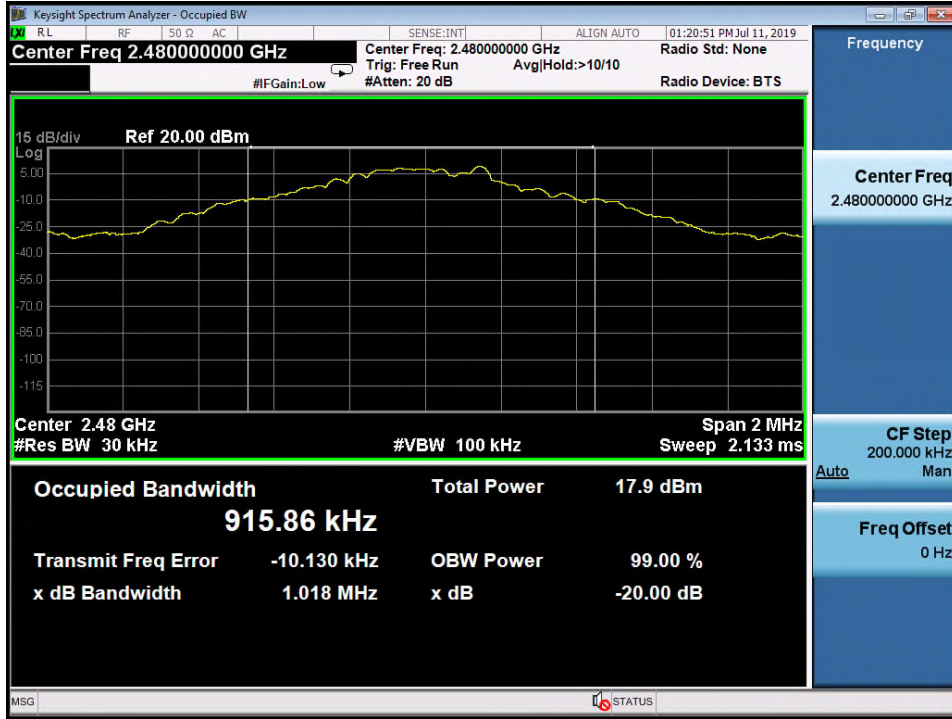
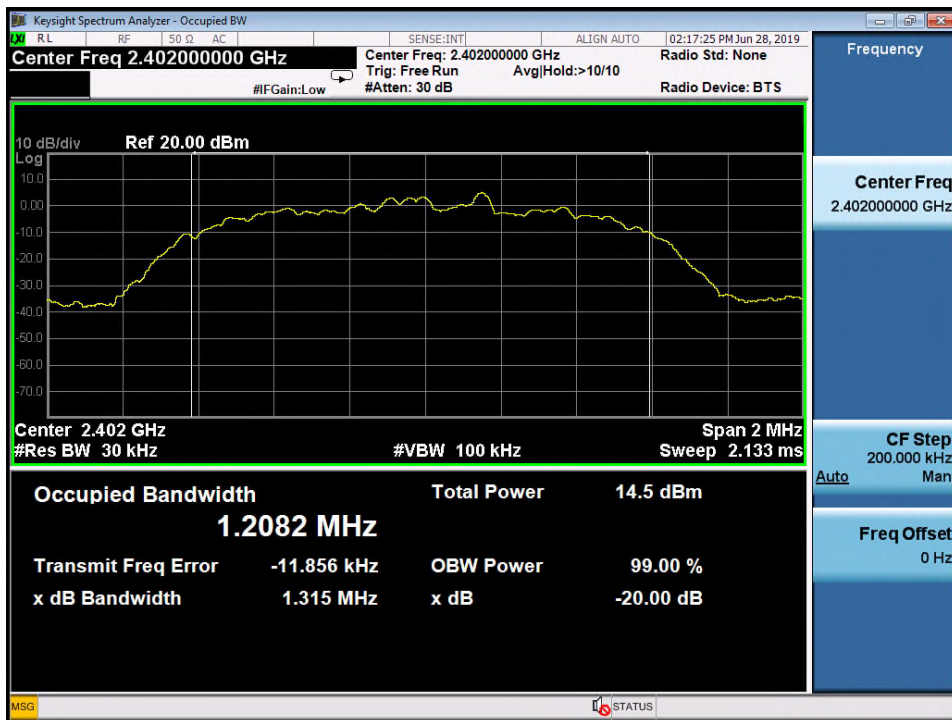
**High Channel**

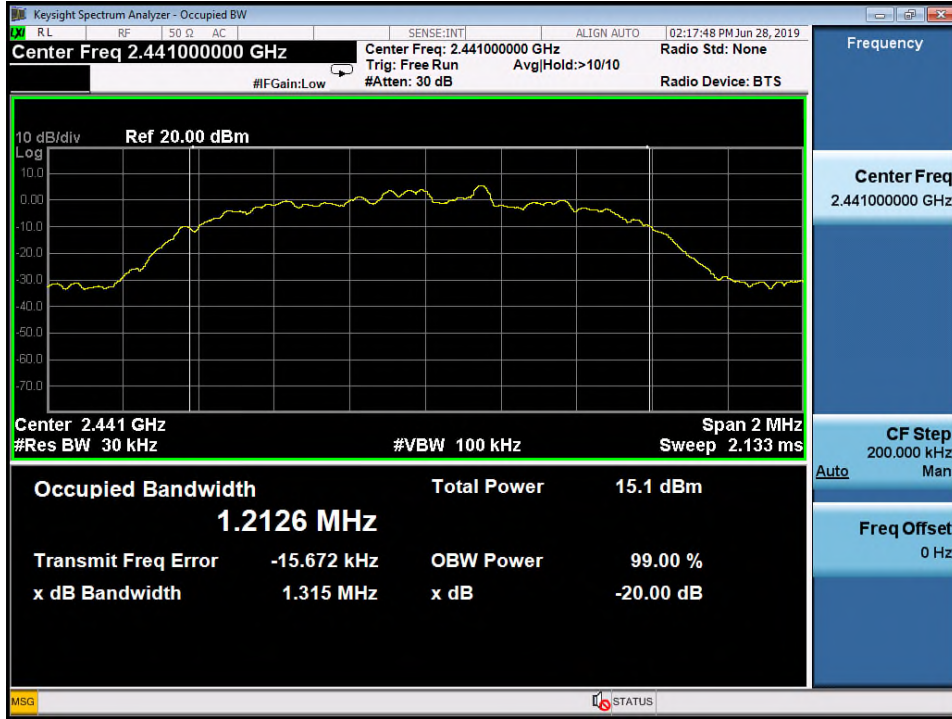
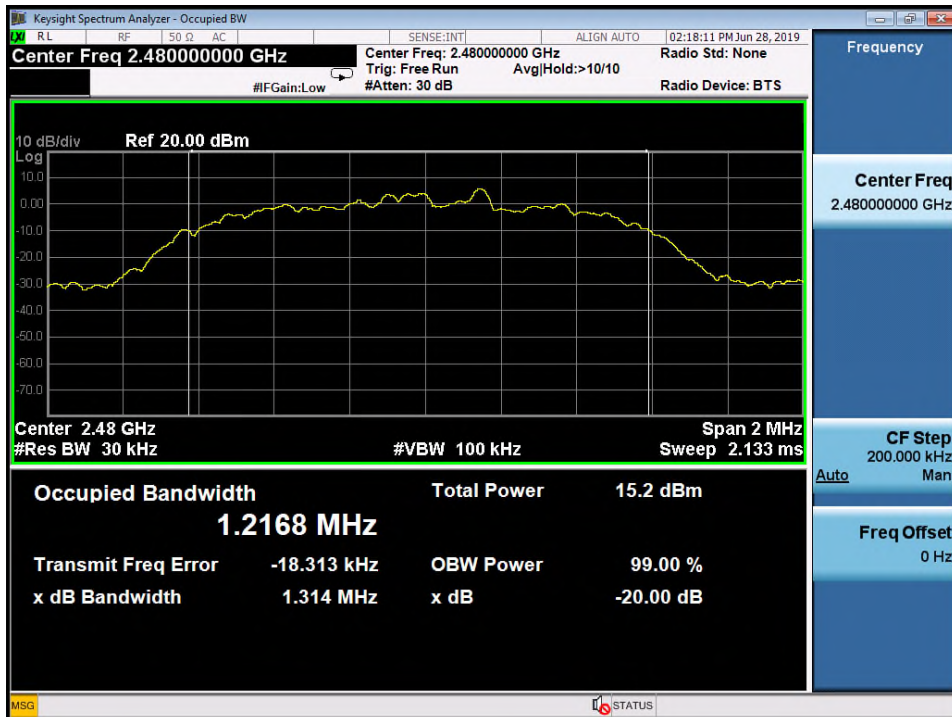
**Test Plot of 20dB Bandwidth, 8DPSK modulation**
**Low Channel**

**Middle Channel**

**High Channel**

### 5.1.4 99% Bandwidth

**RESULT:**
**Passed**

Test standard : RSS-Gen  
 Basic standard : RSS-Gen  
 Kind of test site : Shielded room

**Test setup**

Test Channel : Middle  
 Operation Mode : A  
  
 Ambient temperature : 22-26°C  
 Relative humidity : 50-65%  
 Atmospheric pressure : 100-103kPa

**Table 12: Test result of 99% Bandwidth, GFSK modulation**

Channel	Channel Frequency (MHz)	99% Bandwidth (kHz)
Low Channel	2402	916.31
Mid Channel	2441	914.14
High Channel	2480	917.41

**Table 13: Test result of 99% Bandwidth, 8DPSK modulation**

Channel	Channel Frequency (MHz)	99% Bandwidth (MHz)
Low Channel	2402	1.2115
Mid Channel	2441	1.2237
High Channel	2480	1.2285

## Test Plot of 99% Bandwidth, GFSK modulation

### Low Channel

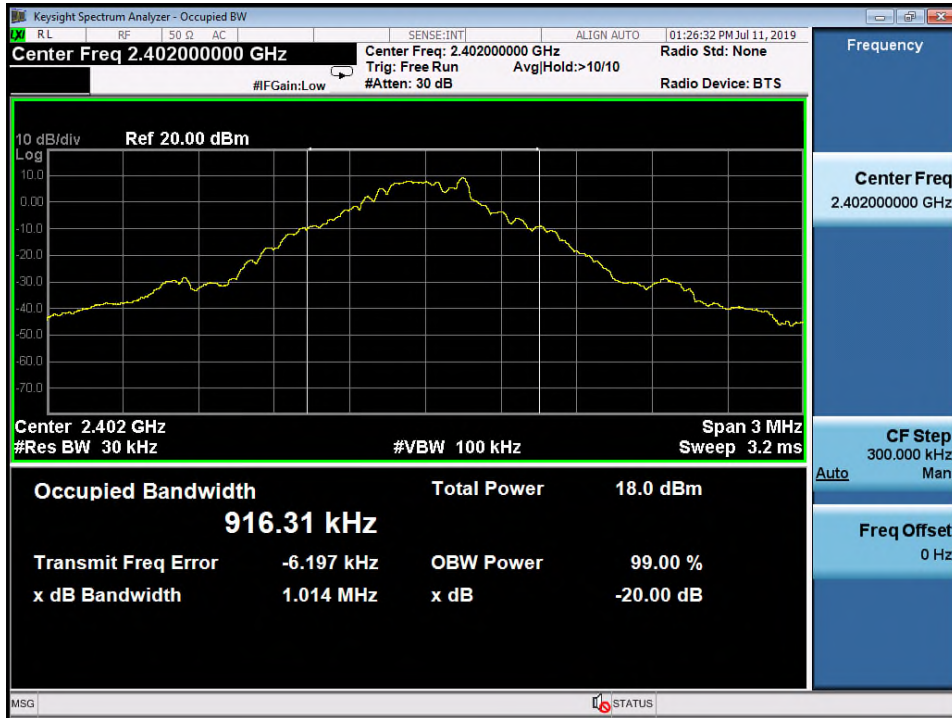

### Middle Channel

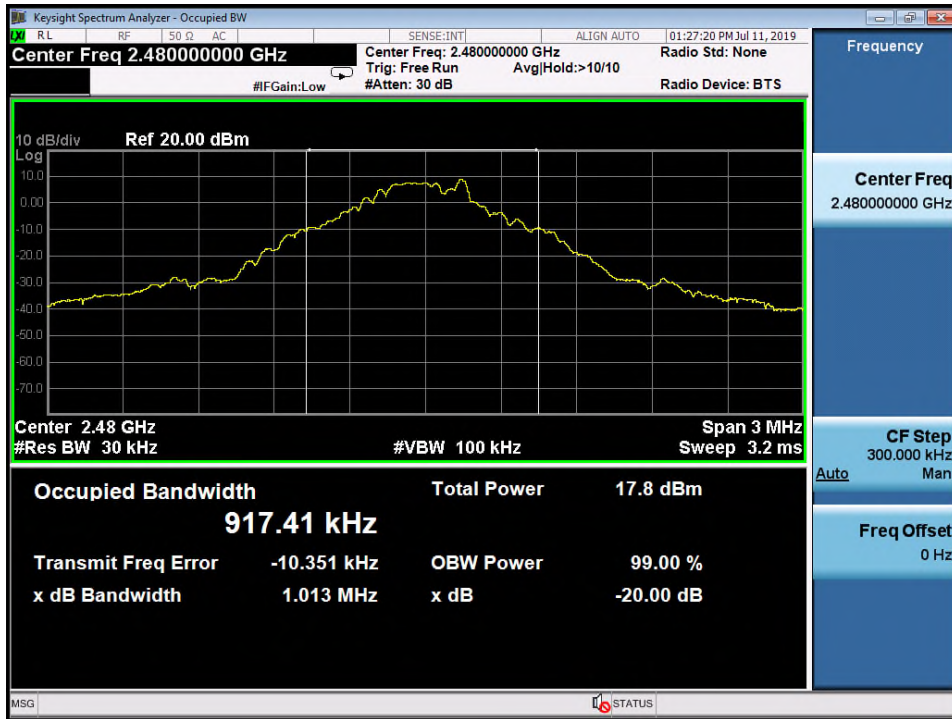
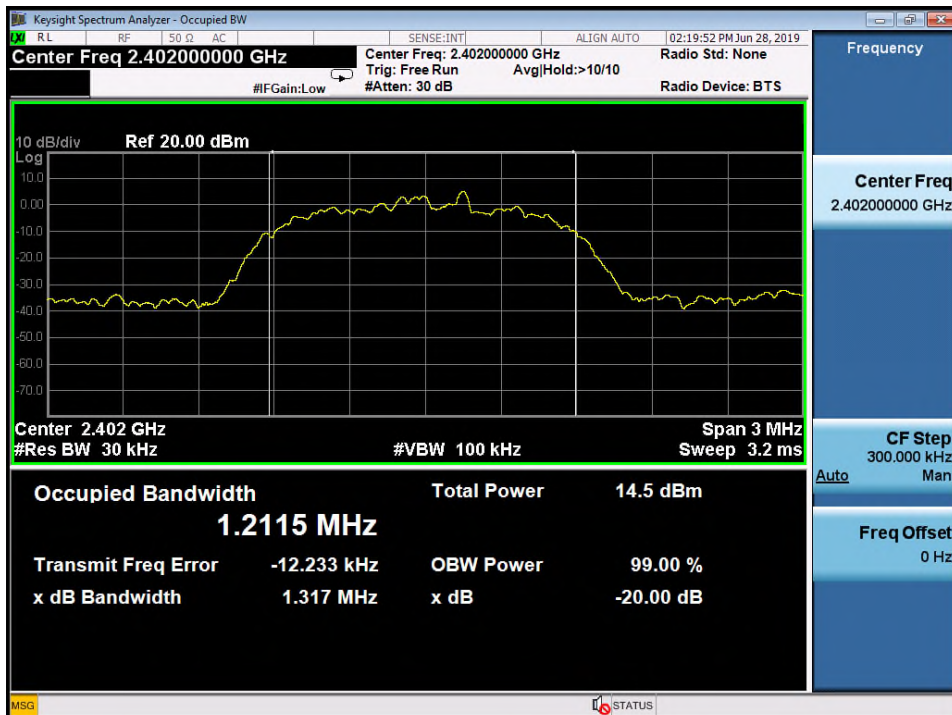

**High Channel**

**Test Plot of 99% Bandwidth, 8DPSK modulation**
**Low Channel**

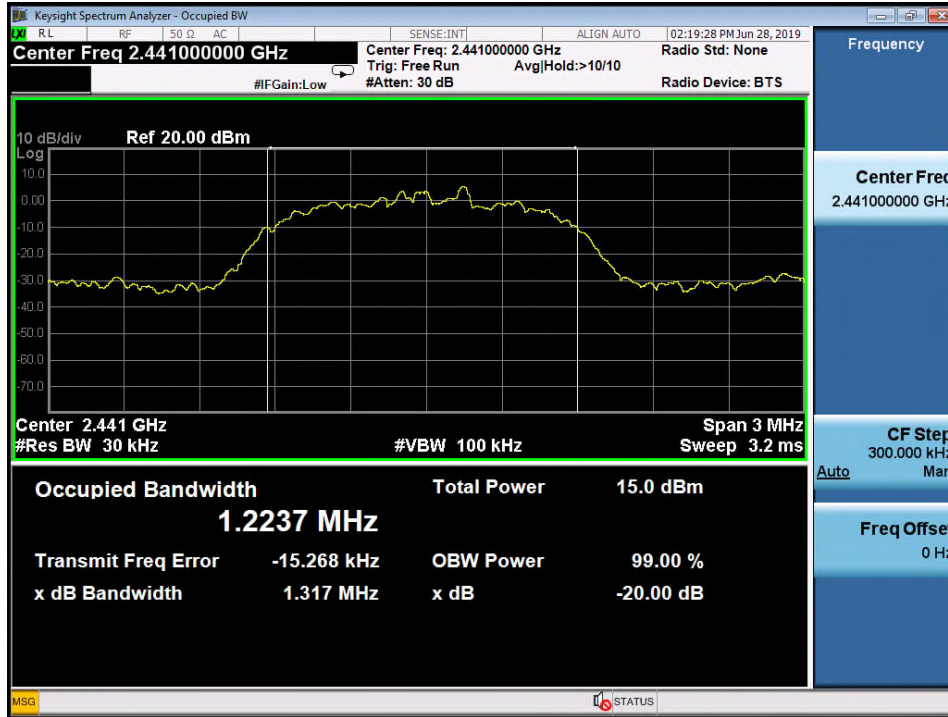
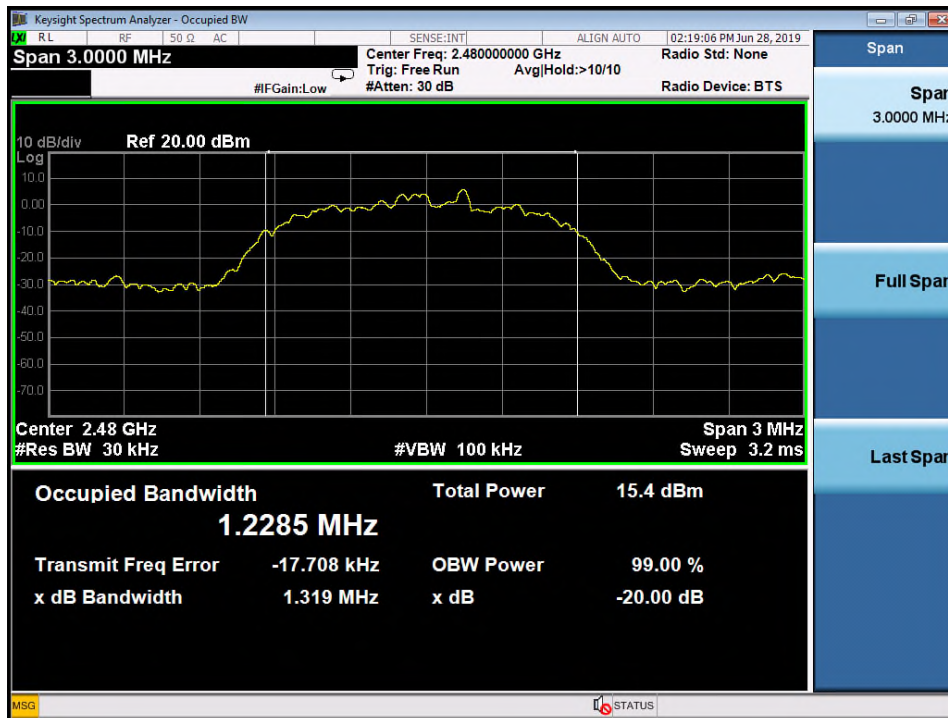

**Middle Channel**

**High Channel**

### 5.1.5 Conducted spurious emissions and Frequency Band Edge measured in 100kHz Bandwidth

**RESULT:****Passed**

Test standard	:	FCC part 15.247(d), RSS-247 5.5
Basic standard	:	ANSI C63.10:2013, KDB558074
Limit	:	20dB (below that in the 100kHz bandwidth within the band that contains the highest level of the desired power)
Kind of test site	:	Shielded room

**Test setup**

Test Channel	:	Low/ Middle/ High for Conducted Spurious Emissions Low/ High/ Hopping on for Frequency Band Edge
Operation Mode	:	A
Ambient temperature	:	22-26°C
Relative humidity	:	50-65%
Atmospheric pressure	:	100-103 kPa

All emissions are more than 20dB below fundamental, details refer to following test plot, and compliance is achieved as well.

Due to the small size of the product and that there are no inductive components of significant size, 9kHz to 30MHz frequency range is not tested based on technical judgment.











# Test Plot of 100kHz Bandwidth of Frequency Band Edge, 8DPSK modulation

## Low Channel

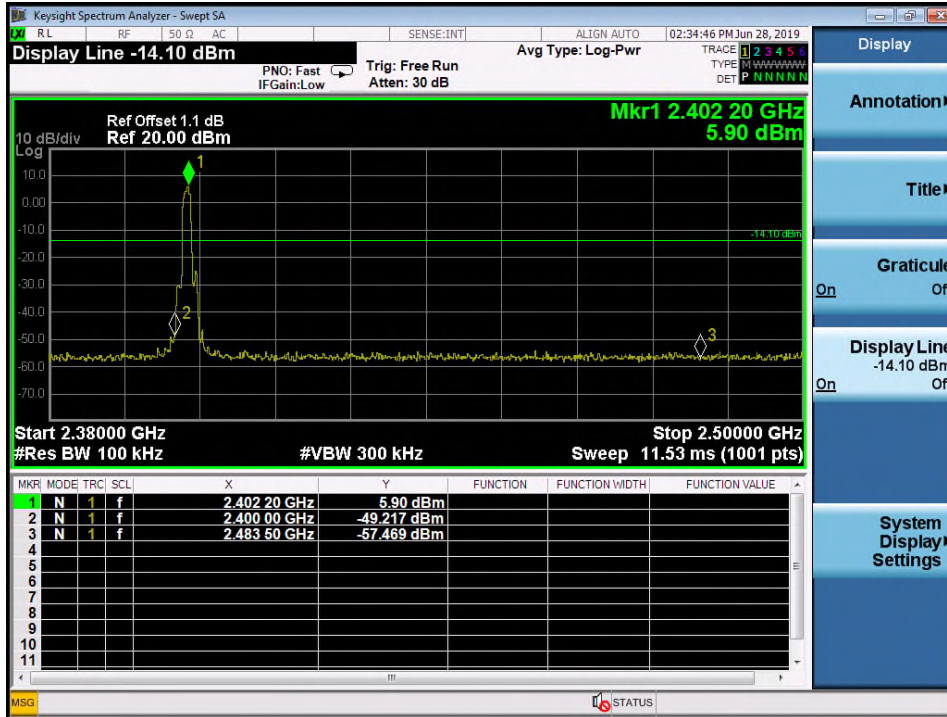

## High Channel

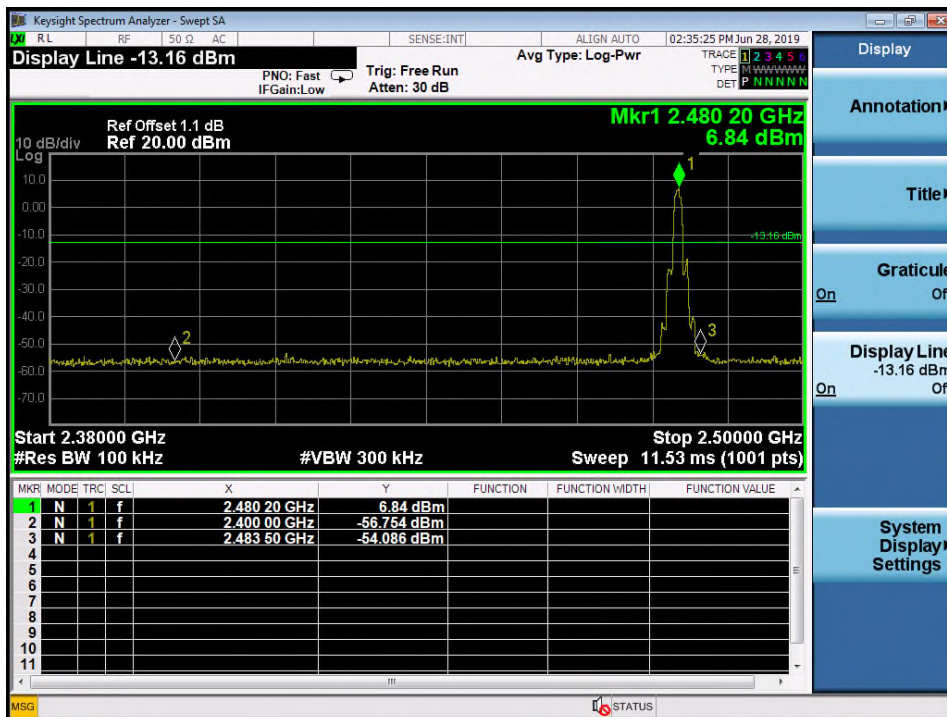





## 5.1.6 Spurious Emission

**RESULT:****Passed**

Test standard : FCC part 15.247(d), FCC 15.205, FCC 15.209, RSS-Gen 8.9 and RSS-Gen 8.10

Basic standard : ANSI C63.10: 2013  
Limits : Radiated emissions which fall in the restricted bands, as defined in FCC 15.205(a) and RSS-Gen i5, 8.10 (Table 7), must comply with the radiated emission limits specified in FCC 15.209(a) and RSS-Gen 5, 8.9 (Table 5 and 6).

Emission radiated outside the restricted and authorized frequency bands must either comply with the radiated emission limits specified for the restricted bands or in FCC15.247(d) and RSS-247 i2, 5.5

Kind of test site : 3m Semi-Anechoic Chamber

**Test setup**

Test Channel : Low/ Middle/ High  
Operation Mode : A

Ambient temperature : 22-26°C  
Relative humidity : 50-65%  
Atmospheric pressure : 100-103 kPa

Factor (dB/m)=Antenna Factor(dB/m)+Cable loss (dB)

Level(dBuV/m)=Reading(dBuV)+ Factor(dB/m)

Remark: Testing was carried out within frequency range 9kHz to the tenth harmonic. For details refer to Appendix D. The Radiated Emissions testing was performed in the X, Y and Z axis orientation. The worst-case Axis orientation is recorded in this test report.

### 5.1.7 Frequency Separation

**RESULT:**
**Passed**

Test standard : FCC part 15.247(a)(1)  
 RSS-247 5.1(b)  
 Basic standard : ANSI C63.10 (2013)  
 Limit :  $\geq 25\text{kHz}$  or  $2/3$  of 20dB bandwidth, whichever is greater  
 Kind of test site : Shielded room

**Test setup**

Test Channel : Hopping On  
 Operation Mode : C  
 Ambient temperature : 22-26°C  
 Relative humidity : 50-65%  
 Atmospheric pressure : 100-103 kPa

**Table 14: Test result of Frequency Separation**

Channel	Channel Frequency (MHz)	Measured Channel Separation (MHz)	Limit (kHz)	Result
Record Channel	2441	1	$\geq 25\text{kHz}$ or $2/3$ of 20dB bandwidth	Pass
Record Channel adj 1	2440			
Record Channel adj 2	2442			



### 5.1.8 Number of hopping frequency

**RESULT:****Passed**

Test standard : FCC part 15.247(a)(1)(iii)  
RSS-247 5.1(e)

Basic standard : ANSI C63.10 (2013)

Kind of test site : Shielded room

**Test setup**

Test Channel : Hopping On  
Operation Mode : C

Ambient temperature : 22-26°C  
Relative humidity : 50-65%  
Atmospheric pressure : 100-103 kPa

**Table 15: Test result of Number of hopping frequency**

Frequency Range	Measured Quantity of Hopping Channel	Limit	Result
<u>2400</u> to <u>2483.5</u> MHz	79	≥15	Pass

### Test Plot of Number of hopping frequencies



### 5.1.9 Time of Occupancy

**RESULT:**
**Passed**

Test standard : FCC part 15.247(a)(1)(iii)  
 RSS-247 5.1(e)  
 Basic standard : ANSI C63.10 (2013)  
 LP0002(2018) Appendix II  
 Limits : 0.4s  
 Kind of test site : Shield room

**Test setup**

Test Channel : Low  
 Operation Mode : A  
 Ambient temperature : 22-26°C  
 Relative humidity : 50-65%  
 Atmospheric pressure : 100-103 kPa

**Table 16: Test result of Time of Occupancy**

Data Mode	Captured Burst (s)	Dwell time (s)	On+Off time (s)	Limit (s)	Result
DH5	0.00295	0.3138	0.00376	0.4	Pass
3DH5	0.00294	0.3128	0.00376	0.4	Pass

**Note:**

Dwell time = Pulse width x (Hopping rate / Number of channels) x Period

Period = 0.4 (seconds/ channel) x 79 (channel) = 31.6 seconds.

Hopping rate = 1 / (On+Off time) = 266 Hz

### Test Plot of Time of Occupancy, GFSK modulation

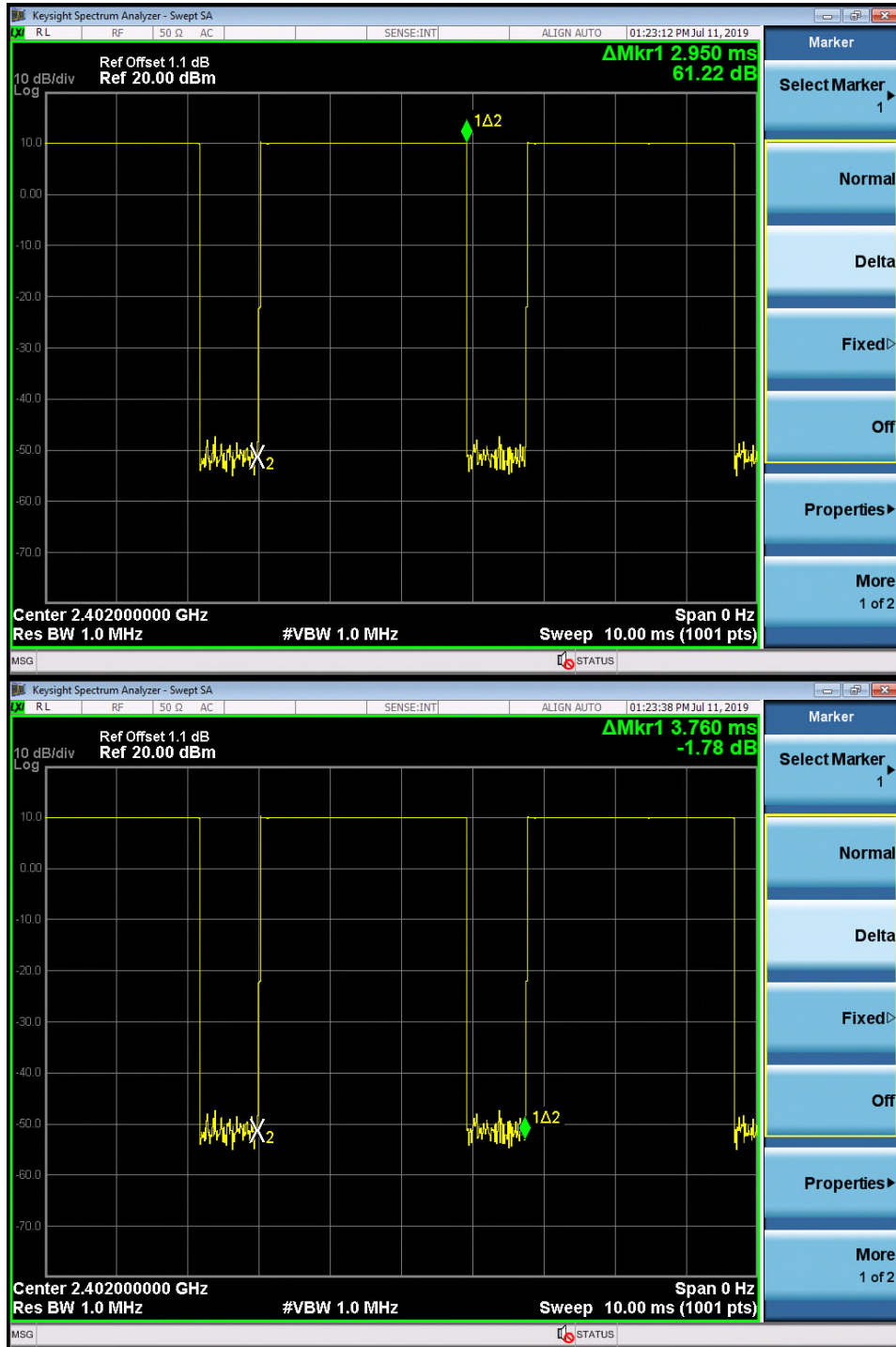



**Test Plot of Time of Occupancy, 8DPSK modulation**

**Prüfbericht - Nr.: 50270952 001**

Test Report No.

**Seite 42 von 45**

Page 42 of 45

## 5.2 Mains Emissions

### 5.2.1 Mains Conducted Emissions

**RESULT:****Passed**

Test standard : FCC Part 15.207  
FCC Part 15.107  
RSS-Gen 8.8

Limits : Mains Conducted emissions as defined in  
above test standards must comply with the  
mains conducted emission limits specified

Kind of test site : Shielded Room

**Test setup**

Operation mode : D

Ambient temperature : 22-26°C

Relative humidity : 50-65%

Atmospheric pressure : 100-103 kPa

Factor (dB/m)=Antenna Factor(dB/m)+Cable loss (dB)

Level(dBuV/m)=Reading(dBuV)+ Factor(dB/m)

Remark: For details refer to Appendix D.

## 6. Safety Human exposure

### 6.1 Radio Frequency Exposure Compliance

#### 6.1.1 Electromagnetic Fields

**RESULT:****Passed**

Test standard : FCC CFR 47 Part 2 Subpart J Section 2.1093  
KDB 447498 D01 v06  
RSS-102 Issue 5, Table 4

The test product is a watch and belongs to the wearing device. Use distance less than 5mm.

**FCC SAR Exposure:****Limit :**

For 100 MHz to 6 GHz and *test separation distances*  $\leq 50$  mm, the 1-g and 10-g SAR test exclusion thresholds are determined by the following:

$[(\text{max. power of channel, including tune-up tolerance, mW}) / (\text{min. test separation distance, mm})] \cdot [\sqrt{f(\text{GHz})}] \leq 3.0$  for 1-g SAR, and  $\leq 7.5$  for 10-g extremity SAR, where

f(GHz) is the RF channel transmit frequency in GHz

Power and distance are rounded to the nearest mW and mm before calculation<sup>31</sup>

The result is rounded to one decimal place for comparison

The test exclusions are applicable only when the minimum *test separation distance* is  $\leq 50$  mm, and for transmission frequencies between 100 MHz and 6 GHz. When the minimum *test separation distance* is  $< 5$  mm, a distance of 5 mm according to 4.1 f) is applied to determine SAR test exclusion.

**Result:**

BT , F(GHz) is 2.441

Maximum Average Power is 9.53mW for BT

$(9.53 / 5) \cdot \sqrt{2.441} = 2.978$

BLE , F(GHz) is 2.480

Maximum Average Power is 0.43mW for BLE

$(0.43 / 5) \cdot \sqrt{2.480} = 0.135$

Co-location SAR exposure is  $3.06 + 0.135 = 3.113$

$3.113 < 7.5$  for 10-g extremity SAR. Therefore, the test of SAR can be excluded.

**IC SAR Exposure:**
**Limit Canada:**

Exemption Limits for Routine Evaluation - SAR Evaluation

SAR evaluation is required if the separation distance between the user and/or bystander and the antenna and/or radiating element of the device is less than or equal to 20 cm, except when the device operates at or below the applicable output power level (adjusted for tune-up tolerance) for the specified separation distance defined in Table 1.

**Table 1: SAR evaluation – Exemption limits for routine evaluation based on frequency and separation distance<sup>4,5</sup>**

Frequency (MHz)	Exemption Limits (mW)				
	At separation distance of ≤5 mm	At separation distance of 10 mm	At separation distance of 15 mm	At separation distance of 20 mm	At separation distance of 25 mm
≤300	71 mW	101 mW	132 mW	162 mW	193 mW
450	52 mW	70 mW	88 mW	106 mW	123 mW
835	17 mW	30 mW	42 mW	55 mW	67 mW
1900	7 mW	10 mW	18 mW	34 mW	60 mW
2450	4 mW	7 mW	15 mW	30 mW	52 mW
3500	2 mW	6 mW	16 mW	32 mW	55 mW
5800	1 mW	6 mW	15 mW	27 mW	41 mW

Output power level shall be the higher of the maximum conducted or equivalent isotropically radiated power (e.i.r.p.) source-based, time-averaged output power. For controlled use devices where the 8 W/kg for 1 gram of tissue applies, the exemption limits for routine evaluation in Table 1 are multiplied by a factor of 5. For Limb-worn devices where the 10 gram value applies, the exemption limits for routine evaluation in Table 1 are multiplied by a factor of 2.5. If the operating frequency of the device is between two frequencies located in Table 1, linear interpolation shall be applied for the applicable separation distance. For test separation distance less than 5 mm, the exemption limits for a separation distance of 5 mm can be applied to determine if a routine evaluation is required.

**Result:**

For Limb-worn devices, the exemption SAR limit is  $4\text{mW} * 2.5 = 10\text{mW}$   
The product BT maximum average conducted output power is 9.53mW.  
The product BLE maximum average conducted output power is 0.43mW.  
Co-loaction SAR exposure is  $9.53\text{mW} + 0.43\text{mW} = 9.96\text{mW}$   
Therefore, the test of SAR can be excluded.

## 7. List of Tables

Table 1: Applied Standard and Test Levels .....	5
Table 2: List of Test and Measurement Equipment .....	7
Table 3: Emission Measurement Uncertainty.....	8
Table 4: Basic Information of EUT .....	9
Table 5: Technical Specification of EUT .....	9
Table 6: Frequency hopping information.....	10
Table 7: Test result of Peak Output Power, GFSK modulation.....	16
Table 8: Test result of Peak Output Power, 8DPSK modulation.....	16
Table 9: Test result of Maximum Average Power, GFSK modulation.....	17
Table 10: Test result of 20dB Bandwidth, GFSK modulation.....	18
Table 11: Test result of 20dB Bandwidth, 8DPSK modulation.....	18
Table 12: Test result of 99% Bandwidth, GFSK modulation.....	22
Table 13: Test result of 99% Bandwidth, PSK modulation.....	22
Table 14: Test result of Frequency Separation .....	35
Table 15: Test result of Number of hopping frequency .....	37
Table 16: Test result of Time of Occupancy.....	39