



SGS-CSTC Standards Technical Services (Shanghai) Co., Ltd.

588 West Jindu Road, Xinqiao, Songjiang, 201612 Shanghai, China
Telephone: +86 (0) 21 6191 5666
Fax: +86 (0) 21 6191 5678
ee.shanghai@sgs.com

Report No.: SHEM161100734104
Page: 1 of 37

1 Cover Page

RF TEST REPORT

Application No.:	SHEM1611007341CR
Applicant:	Anhui Huami Information Technology Co.,Ltd.
FCC ID:	2AC8UA1612
IC:	21806-A1612
Equipment Under Test (EUT): NOTE: The following sample(s) was/were submitted and identified by the client as	
Product Name:	AMAZFIT PACE
Model No.(EUT):	A1612
Standards:	FCC PART 15 Subpart C: 2015 RSS-247 Issue 1 (May 2015) RSS-Gen Issue 4 (November 2014)
Date of Receipt:	2016-11-16
Date of Test:	2016-11-16 to 2016-11-30
Date of Issue:	2016-12-23
Test Result:	Pass*

*In the configuration tested, the EUT detailed in this report complied with the standards specified above.



Parlam Zhan
E&E Section Manager
SGS-CSTC (Shanghai) Co., Ltd.



The manufacturer should ensure that all products in series production are in conformity with the product sample detailed in this report. If the product in this report is used in any configuration other than that detailed in the report, the manufacturer must ensure the new system complies with all relevant standards.

The report must not be used by the client to claim product certification, approval, or endorsement by NVLAP, NIST, or any agency of the federal government. All test results in this report can be traceable to National or International Standards.

This document is issued by the Company subject to its General Conditions of Service printed overleaf, available on request or accessible at www.sgs.com/terms_and_conditions.htm and, for electronic format documents, subject to Terms and Conditions for Electronic Documents at www.sgs.com/terms_e-document.htm. Attention is drawn to the limitation of liability, indemnification and jurisdiction issues defined therein. Any holder of this document is advised that information contained hereon reflects the Company's findings at the time of its intervention only and within the limits of Client's instructions, if any. The Company's sole responsibility is to its Client and this document does not exonerate parties to a transaction from exercising all their rights and obligations under the transaction documents. This document cannot be reproduced except in full, without prior written approval of the Company. Any unauthorized alteration, forgery or falsification of the content or appearance of this document is unlawful and offenders may be prosecuted to the fullest extent of the law. Unless otherwise stated the results shown in this test report refer only to the sample(s) tested and such sample(s) are retained for 90 days only

2 Version

Revision Record				
Version	Chapter	Date	Modifier	Remark
00	/	2016-12-23	/	Original

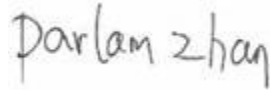
Authorized for issue by:			
Engineer		Eddy Zong _____ Print Name	 _____
Clerk		Vincent Zhu _____ Print Name	 _____
Reviewer		Parlam Zhan _____ Print Name	 _____

3 Test Summary

Test Item	FCC Requirement	IC Requirement	Test method	Result
Antenna Requirement	FCC Part 15, Subpart C Section 15.203/15.247 (c)	RSS-Gen Section 8.1.3	---	PASS
AC Power Line Conducted Emission	FCC Part 15, Subpart C Section 15.207	RSS-Gen Clause 8.8	ANSI C63.10 (2013) Section 6.2	N/A
Minimum 6dB Bandwidth	FCC Part 15, Subpart C Section 15.247 (a)(2)	RSS-247 Clause 5.2(1)	ANSI C63.10 (2013) Section 11.8.1	PASS
Conducted Peak Output Power	FCC Part 15, Subpart C Section 15.247 (b)(3)	RSS-247 Clause 5.4(4)	ANSI C63.10 (2013) Section 11.9.1.2	PASS
Power Spectrum Density	FCC Part 15, Subpart C Section 15.247 (e)	RSS-247 Clause 5.2(2)	ANSI C63.10 (2013) Section 11.10.2	PASS
RF Conducted Spurious Emissions and Band-edge	FCC Part 15, Subpart C Section 15.247(d)	RSS-247 Clause 5.5	ANSI C63.10 (2013) Section 11.11&11.13.3.2	PASS
Radiated Spurious Emissions and Band-edge	FCC Part 15, Subpart C Section 15.209&15.205	RSS-247 Clause 5.5	ANSI C63.10 (2013) Section 6.4&6.5&6.6&6.10	PASS
99% Occupied bandwidth	---	RSS-Gen Clause 6.6	RSS-Gen Issue 4 section 6.6	PASS



4 Contents

	Page
1 COVER PAGE	1
2 VERSION	2
3 TEST SUMMARY	3
4 CONTENTS.....	4
5 GENERAL INFORMATION	5
5.1 CLIENT INFORMATION.....	5
5.2 GENERAL DESCRIPTION OF E.U.T.....	5
5.3 TECHNICAL SPECIFICATIONS.....	5
5.4 DESCRIPTION OF SUPPORT UNITS.....	5
5.5 DETAILS OF TEST MODE	6
5.6 TEST LOCATION	6
5.7 TEST FACILITY	6
5.8 MEASUREMENT UNCERTAINTY	7
6 EQUIPMENTS LIST.....	8
7 ANTENNA REQUIREMENT	9
7.1 E.U.T. TEST CONDITIONS	9
7.2 ANTENNA REQUIREMENT.....	10
7.3 CONDUCTED EMISSIONS ON MAINS TERMINALS	11
7.4 6dB OCCUPIED BANDWIDTH.....	12
7.5 CONDUCTED PEAK OUTPUT POWER	14
7.6 PEAK POWER SPECTRAL DENSITY.....	17
7.7 CONDUCTED SPURIOUS EMISSIONS AND BAND EDGE.....	20
7.7.1 <i>Conducted Spurious Emissions</i>	21
7.7.2 <i>Conducted Band-edge</i>	24
7.8 RADIATED SPURIOUS EMISSIONS AND BAND-EDGE.....	25
7.8.1 <i>Radiated Spurious Emissions</i>	28
7.8.2 <i>Radiated Band-edge</i>	31
7.1 99% OCCUPIED BANDWIDTH	35
8 TEST SETUP PHOTOGRAPHS.....	37
9 EUT CONSTRUCTIONAL DETAILS.....	37

5 General Information

5.1 Client Information

Applicant:	Anhui Huami Information Technology Co.,Ltd.
Address of Applicant:	Building A4, 12 th Floor, No.800 Wangjiang Road, Hefei, China(230088)
Manufacturer:	Anhui Huami Information Technology Co.,Ltd.
Address of Manufacturer:	Building A4, 12 th Floor, No.800 Wangjiang Road, Hefei, China(230088)
Factory:	Anhui Huami Information Technology Co.,Ltd.
Address of Factory:	Building A4, 12 th Floor, No.800 Wangjiang Road, Hefei, China(230088)

5.2 General Description of E.U.T.

Brand Name:	Amazfit
Product Description:	Portable product with BT function
Rechargeable Batteries:	DC 3.8V by Built-in lithium-ion polymer battery (280mAH) Supply the EUT with fully charged battery during the testing.
Rated Input:	DC 5V via USB port

5.3 Technical Specifications

Operation Frequency:	2402-2480MHz
Bluetooth Version:	BT 4.0 (BLE)
Modulation Type:	GFSK
Number of Channel:	40
Antenna Type	Integral Chip Antenna
Antenna Gain	-3.5 dBi

5.4 Description of Support Units

The EUT has been tested with associated equipment below.

Description	Manufacturer	Model No.	Supplied by
Laptop	Lenovo	ThinkPad X100e	SGS

Software name	Manufacturer	Version	Supplied By
Adb tool	/	/	Client

5.5 Details of Test Mode

Test Mode	Description of Test Mode
Engineering Mode	Using test software to control EUT working in continuous transmitting and receiving, and select channel and modulation type

5.6 Test Location

All tests were performed at:

SGS-CSTC Standards Technical Services (Shanghai) Co., Ltd. E&E Lab

588 West Jindu Road, Xinqiao, Songjiang, 201612 Shanghai, China.

Tel: +86 21 6191 5666

Fax: +86 21 6191 5678

No tests were sub-contracted.

5.7 Test Facility

The test facility is recognized, certified, or accredited by the following organizations:

- **CNAS (No. CNAS L0599)**

CNAS has accredited SGS-CSTC Standards Technical Services (Shanghai) Co., Ltd. to ISO/IEC 17025:2005 General Requirements for the Competence of Testing and Calibration Laboratories (CNAS-CL01 Accreditation Criteria for the Competence of Testing and Calibration Laboratories) for the competence in the field of testing.

- **FCC – Registration No.: 402683**

SGS-CSTC Standards Technical Services (Shanghai) Co., Ltd. has been registered and fully described in a report filed with the Federal Communications Commission (FCC). The acceptance letter from the FCC is maintained in our files. Registration No.: 402683.

- **Industry Canada (IC) – IC Assigned Code: 8617A**

The 3m Semi-anechoic chamber of SGS-CSTC Standards Technical Services (Shanghai) Co., Ltd. has been registered by Certification and Engineering Bureau of Industry Canada for radio equipment testing with Registration No.: 8617A-1.

- **VCCI (Member No.: 3061)**

The 3m Semi-anechoic chamber and Shielded Room of SGS-CSTC Standards Technical Services (Shanghai) Co., Ltd. has been registered in accordance with the Regulations for Voluntary Control Measures with Registration No.: R-3868, C-4336, T-2221, G-830 respectively.

5.8 Measurement Uncertainty

No.	Parameter	Measurement Uncertainty
1	Radio Frequency	$< \pm 1 \times 10^{-5}$
2	Total RF power, conducted	$< \pm 1.5$ dB
3	RF power density, conducted	$< \pm 3$ dB
4	Spurious emissions, conducted	$< \pm 3$ dB
5	All emissions, radiated	$< \pm 6$ dB (Below 1GHz) $< \pm 6$ dB (Above 1GHz)
6	Temperature	$< \pm 1^{\circ}\text{C}$
7	Humidity	$< \pm 5$ %
8	DC and low frequency voltages	$< \pm 3$ %

6 Equipments List

No.	Equipment	Manufacturer	Model No.	Inventory No.	Cal. Date	Cal. Due date
1	Power Meter	R&S	NRP	SHEM057-1	2016-01-14	2017-01-13
2	Power Meter Sensor	R&S	NRP-Z22	SHEM136-1	2016-08-12	2017-08-11
3	Spectrum Analyzer	R&S	FSP-30	SHEM002-1	2016-01-14	2017-01-13
4	EMI Receiver	R&S	ESU40	SHEM051-1	2016-01-16	2017-01-15
5	EMI Receiver	R&S	ESR7	SHEM162-1	2016-01-14	2017-01-13
6	LISN	SCHWARZBECK	NSLK8127	SHEM061-1	2016-01-14	2017-01-13
7	LISN	EMCO	3816/2	SHEM019-1	2016-01-14	2017-01-13
8	Loop Antenna (9kHz to 30MHz)	R&S	FMZB1519	SHEM135-1	2016-01-18	2017-01-17
9	Broadband Antenna (25MHz to 2GHz)	SCHWARZBECK	VULB9168	SHEM048-1	2016-01-16	2017-01-15
10	Broadband Antenna (25MHz to 3GHz)	R&S	HL562	SHEM010-1	2016-01-16	2017-01-15
11	Horn Antenna (1GHz to 18GHz)	R&S	HF906	SHEM009-1	2016-01-16	2017-01-15
12	Horn Antenna (1GHz to 18GHz)	SCHWARZBECK	BBHA9120D	SHEM050-1	2016-01-16	2017-01-15
13	Horn Antenna (14GHz to 40GHz)	SCHWARZBECK	BBHA 9170	SHEM049-1	2016-01-16	2017-01-15
14	Pre-amplifier (9kHz – 2GHz)	TESEQ	LNA6900	SHEM074-1	2016-01-14	2017-01-13
15	Pre-amplifier (1GHz – 26.5GHz)	SCHWARZBECK	F0118-G40-BZ4	SHEM049-2	2016-01-14	2017-01-13
16	Pre-amplifier (14GHz – 40GHz)	SCHWARZBECK	F1840-G35-BZ3	SHEM050-2	2016-01-14	2017-01-13
17	Low Pass Filter	Mini-Circuits	VLF-2500	SHEM114-1		
18	High Pass Filter	LORCH	5BRX-2400	SHEM155-1	/	/
19	High-low Temperature Cabinet	Suzhou Zhihe	TL-40	SHEM087-1	2016-08-15	2017-08-14
20	AC Power Stabilizer	WOCEN	6100	SHEM045-1	2016-01-14	2017-01-13
21	DC Power Supply	QJE	QJ30003SII	SHEM046-1	2016-01-14	2017-01-13
22	Signal Generator (Interferer)	R&S	SMR40	SHEM058-1	2016-08-12	2017-08-11
23	Signal Generator (Blocker)	R&S	SMJ100A	SHEM141-1	2016-01-14	2017-01-13
24	Splitter	ANRITSU CORP	MA1612A	SHEM159-1	/	/
25	Coupler	Mini-Circuits	803-S-1	SHEM113-1	/	/

7 Antenna Requirement

7.1 E.U.T. test conditions

Requirements: 15.31(e) For intentional radiators, measurements of the variation of the input power or the radiated signal level of the fundamental frequency component of the emission, as appropriate, shall be performed with the supply voltage varied between 85% and 115% of the nominal rated supply voltage. For battery operated equipment, the equipment tests shall be performed using a new battery.

Operating Environment:	Temperature:	20.0 -25.0 °C
	Humidity:	35-75 % RH
	Atmospheric Pressure:	99.2 -102 kPa

Test frequencies: According to the 15.31(m) Measurements on intentional radiators or receivers, other than TV broadcast receivers, shall be performed and, if required, reported for each band in which the device can be operated with the device operating at the number of frequencies in each band specified in the following table:

Frequency range over which device operates	Number of frequencies	Location in the range of operation
1 MHz or less	1	Middle
1 to 10 MHz	2	1 near top and 1 near bottom
More than 10 MHz	3	1 near top, 1 near middle and 1 near bottom

Pursuant to Part 15.31(c) For swept frequency equipment, measurements shall be made with the frequency sweep stopped at those frequencies chosen for the measurements to be reported.

Test frequency is the lowest channel: 0 channel (2402MHz), middle channel: 19 channel (2440MHz) and highest channel: 40 channel (2480MHz) with fixed at channel.

7.2 Antenna Requirement

Standard requirement:

15.203 requirement:

An intentional radiator shall be designed to ensure that no antenna other than that furnished by the responsible party shall be used with the device. The use of a permanently attached antenna or of an antenna that uses a unique coupling to the intentional radiator, the manufacturer may design the unit so that a broken antenna can be replaced by the user, but the use of a standard antenna jack or electrical connector is prohibited.

15.247(b) (4) requirement:

The conducted output power limit specified in paragraph (b) of this section is based on the use of antennas with directional gains that do not exceed 6 dBi. Except as shown in paragraph (c) of this section, if transmitting antennas of directional gain greater than 6 dBi are used, the conducted output power from the intentional radiator shall be reduced below the stated values in paragraphs (b)(1), (b)(2), and (b)(3) of this section, as appropriate, by the amount in dB that the directional gain of the antenna exceeds 6 dBi.

EUT Antenna:

The antenna is Integral antenna and no consideration of replacement. The gain of the antenna is less than -3.5 dBi

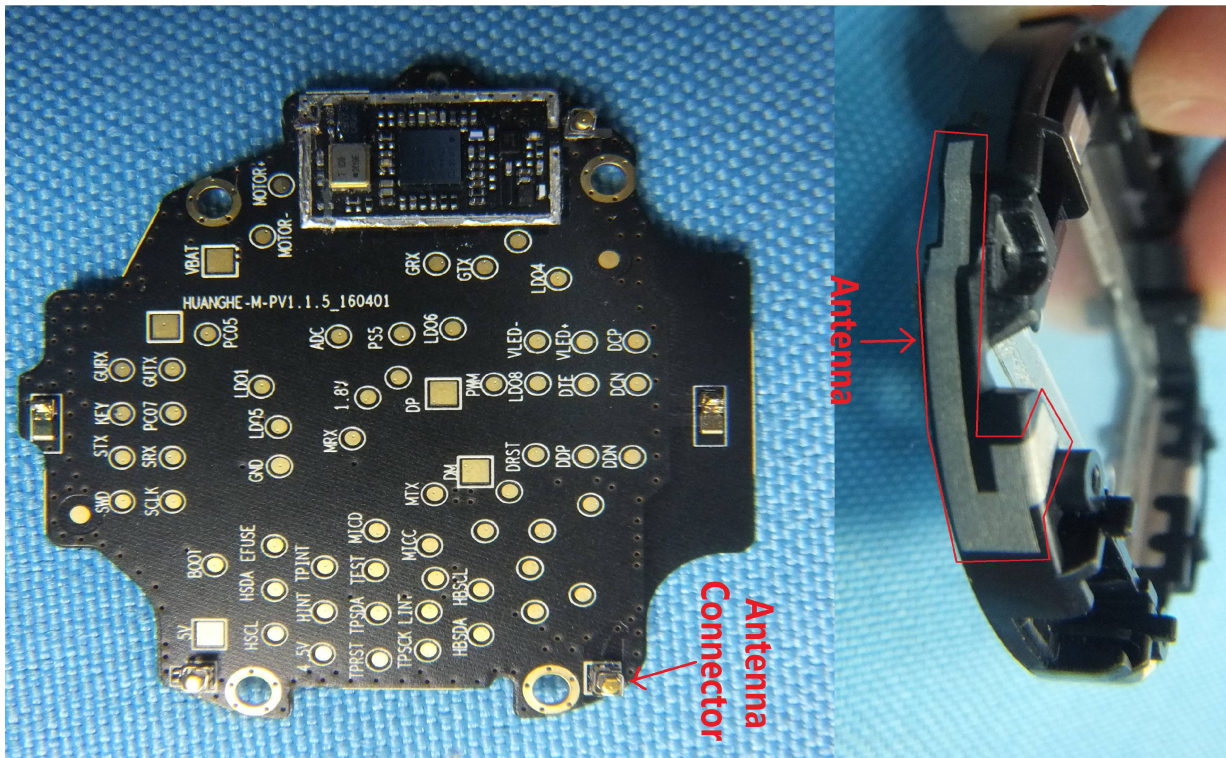

7.3 Conducted Emissions on Mains Terminals

Frequency Range: 150 KHz to 30 MHz

Limit:

Frequency range MHz	Class B Limits: dB (µV)	
	Quasi-peak	Average
0.15 to 0.50	66 to 56	56 to 46
0.50 to 5	56	46
5 to 30	60	50

Note1: The limit decreases linearly with the logarithm of the frequency in the range 0.15 MHz to 0.50MHz.

Note2: The lower limit is applicable at the transition frequency.

Test Setup:

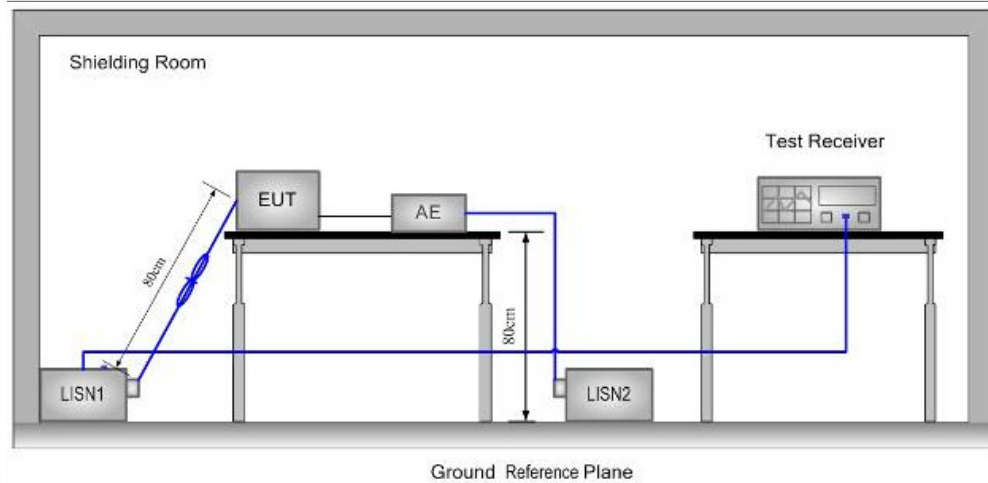

Test Procedure:

- 1) The mains terminal disturbance voltage was measured with the EUT in a shielded room.
- 2) The EUT was connected to AC power source through a LISN 1 (Line Impedance Stabilization Network) which provides $50\Omega/50\mu\text{H} + 5\Omega$ linear impedance. The power cables of all other units of the EUT were connected to a second LISN, which was bonded to the ground reference plane in the same way as the LISN for the unit being measured. A multiple socket outlet strip was used to connect multiple power cables to a single LISN provided the rating of the LISN was not exceeded.
- 3) The tabletop EUT was placed upon a non-metallic table 0.8m above the ground reference plane. And for floor-standing arrangement, the EUT was placed on the horizontal ground reference plane, but separated from metallic contact with the ground reference plane by 0.1m of insulation.
- 4) The test was performed with a vertical ground reference plane. The rear of the EUT shall be 0.4 m from the vertical ground reference plane. The vertical ground reference plane was bonded to the horizontal ground reference plane. The LISN was placed 0.8 m from the boundary of the unit under test and bonded to a ground reference plane for LISN mounted on top of the ground reference plane. This distance was between the closest points of the LISN and the EUT. The mains lead of EUT excess 0.8m was folded back and forth parallel to the lead so as to form a horizontal bundle with a length between 0.3m and 0.4m. All other units of the EUT and associated equipment were at least 0.8 m from the LISN.

Test Result: N/A

The BT function of EUT no working in charging mode; therefore the AC Conducted Emission test is not applicable.

7.4 6dB Occupied Bandwidth

Test Configuration:

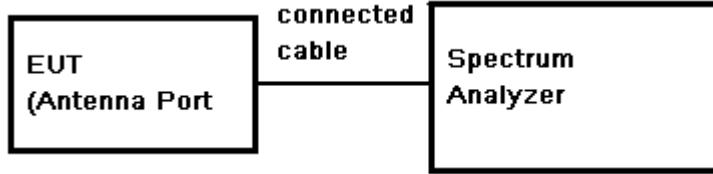

Test Procedure:

- 1). Place the EUT on the table and set it in transmitting mode.
- 2). Remove the antenna from the EUT and then connect a low loss RF cable from the antenna port to the spectrum analyzer.
- 3). Set the spectrum analyzer as RBW=100KHz, VBW≥3* RBW, Span=3MHz, Sweep=auto
- 4). Mark the peak frequency and -6dB (upper and lower) frequency.
- 5). Repeat above procedures until all frequency measured was complete.

Limit:

≥ 500 kHz

Test date:

Test Channel	Test Frequency (MHz)	6dB Bandwidth (MHz)	Limit (KHz)	Test Result
Lowest	2402	0.688	500	Pass
Middle	2440	0.683	500	Pass
Highest	2480	0.682	500	Pass

Test plot as follows:

Test channel: Lowest

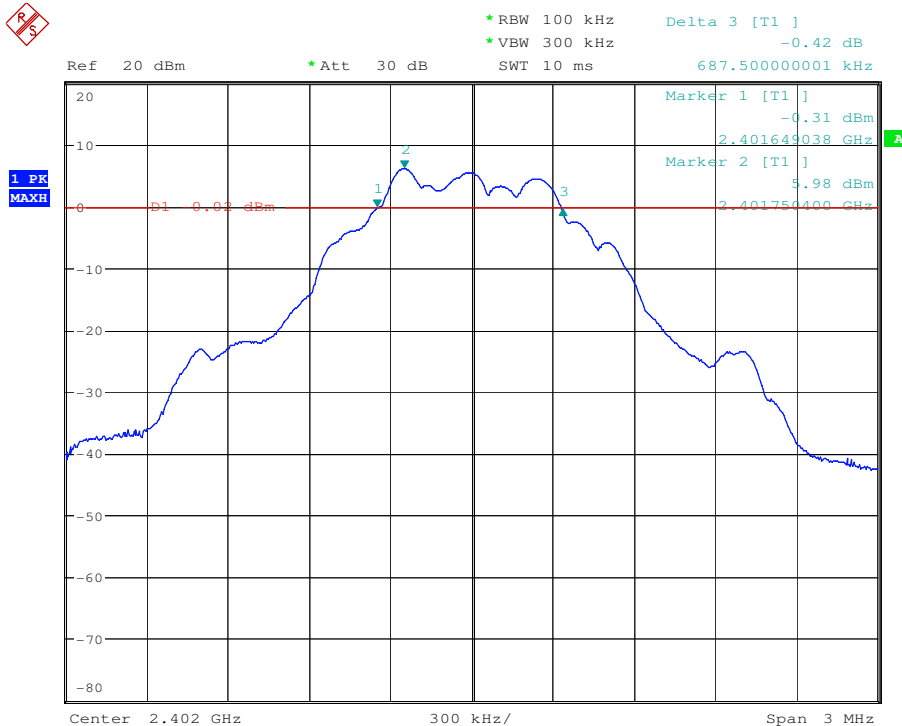

Test channel: Middle

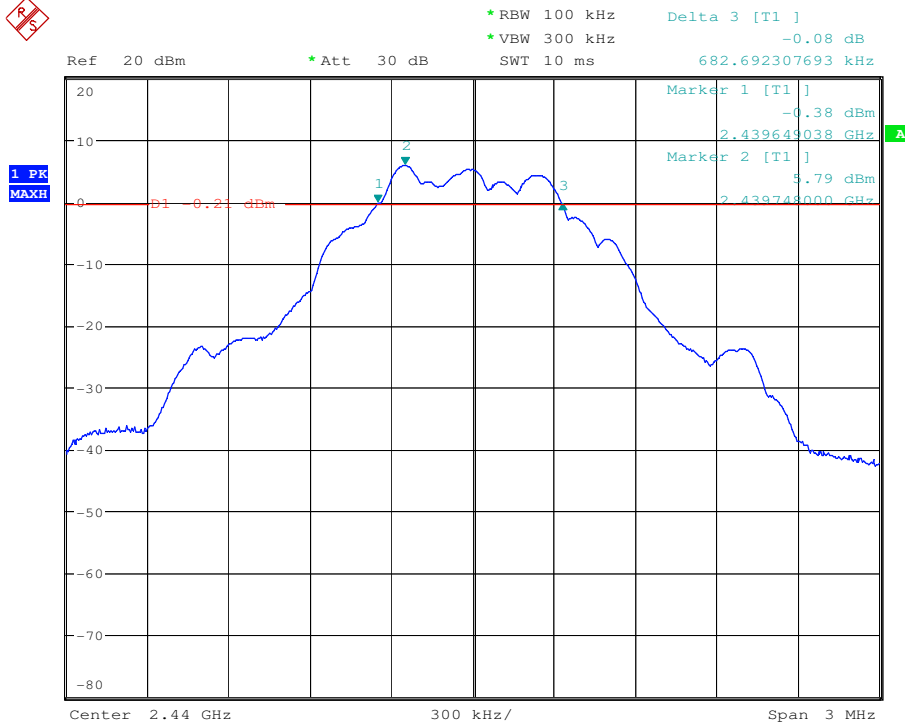

Test channel: Highest

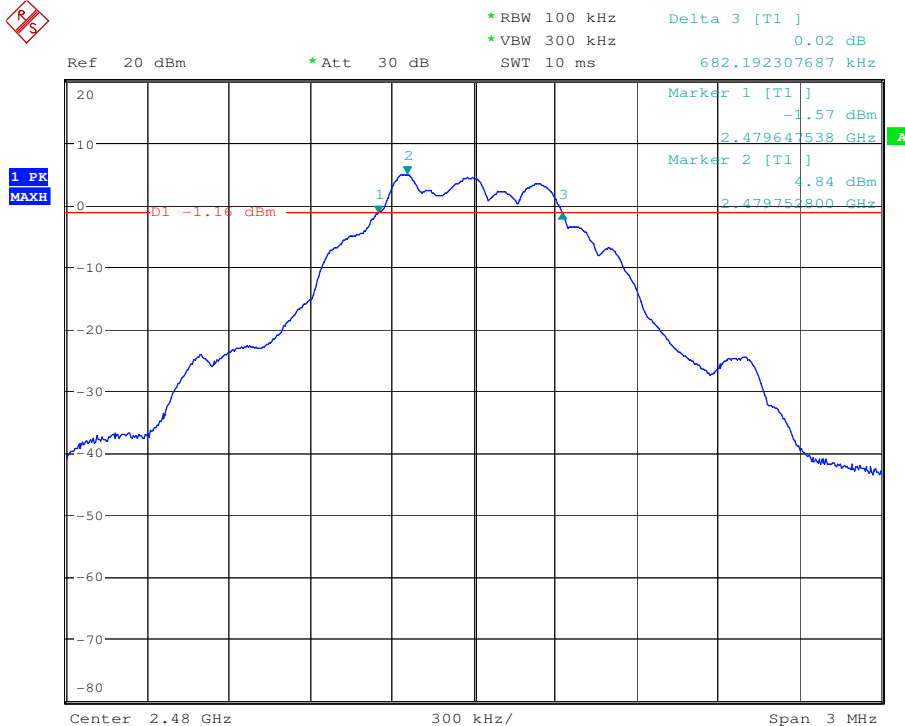

7.5 Conducted Peak Output Power

Test Configuration:

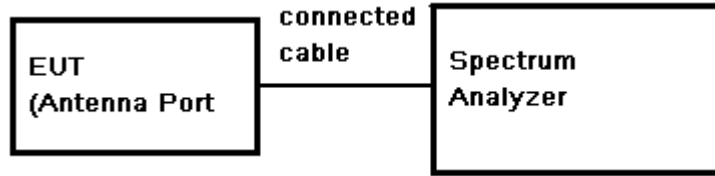

Test Procedure:

- 1) Place the EUT on the table and set it in transmitting mode.
- 2) Remove the antenna from the EUT and then connect a low loss RF cable from the antenna port to the spectrum.
- 3) Set the spectrum analyzer: RBW = 3 MHz, VBW = 10 MHz, Span= fully encompass the bandwidth, Sweep = auto; Detector Function = Peak Trace mode=max hold
- 4) Use the peak marker function to determine the maximum amplitude level within the RBW.
- 5) Record the max. Power reading.
- 6) Repeat above procedures until all the frequency measured were complete.

Test Limit: 30dBm

Test data:

Test Channel	Test Frequency (MHz)	Reading Power (dBm)	Cable Loss (dB)	Output Power (dBm)	Limit (dBm)	Test Result
Lowest	2402	6.40	0.5	6.90	30	Pass
Middle	2440	6.23	0.5	6.73	30	Pass
Highest	2480	5.31	0.5	5.81	30	Pass

$$\text{Output Power} = \text{Reading Power} + \text{Cable Loss}$$

Test plot as follows:

Test channel: Lowest

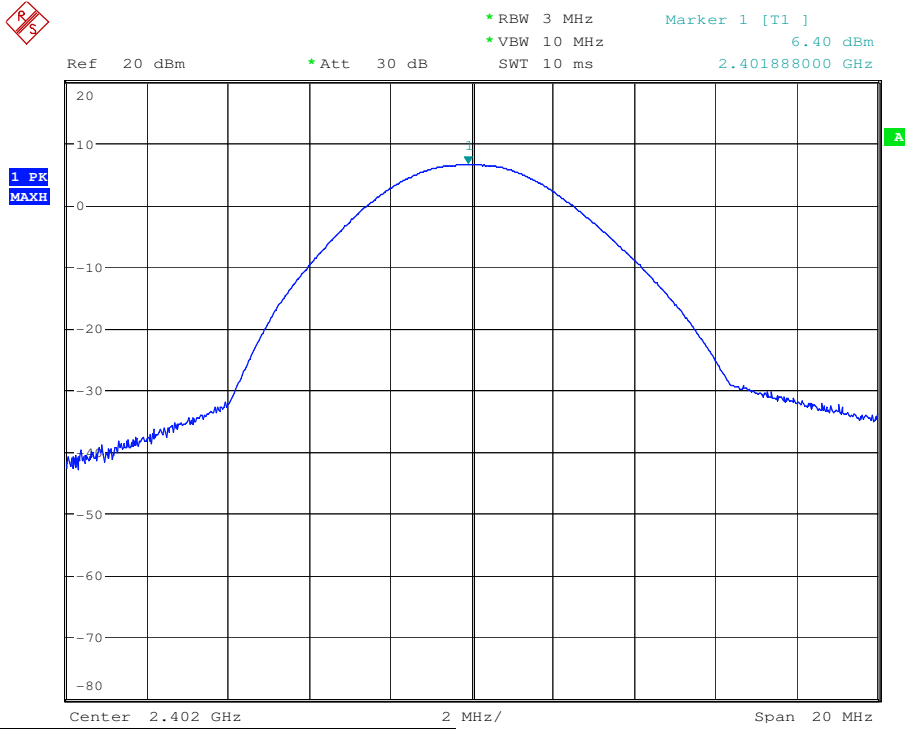

Test channel: Middle

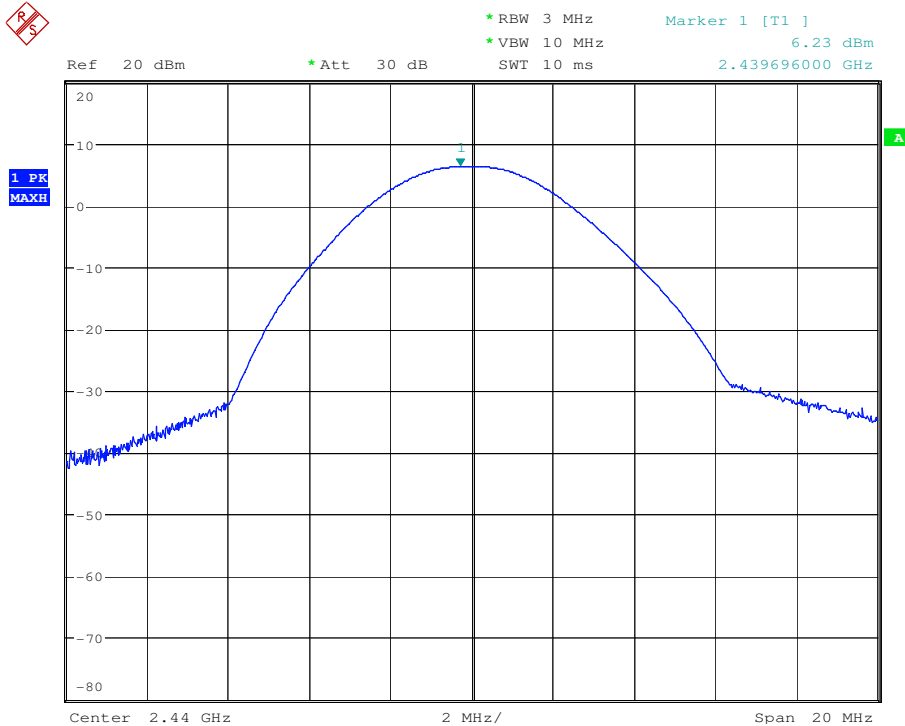

Test channel: Highest

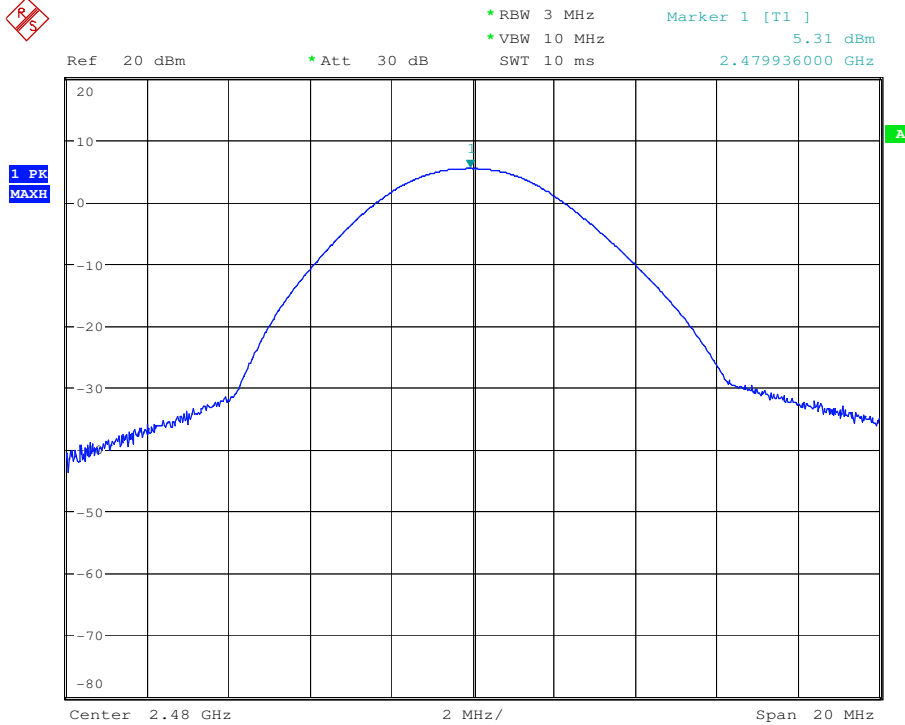

7.6 Peak Power Spectral Density

Test Configuration:

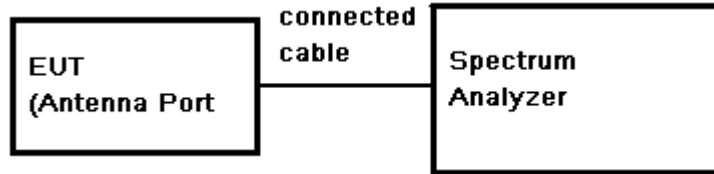

Test Procedure:

- 1) Remove the antenna from the EUT and then connect a low RF cable from the antenna port to the spectrum.
- 2) Set the spectrum analyzer: Center Frequency= Channel Frequency, RBW = 3 kHz VBW = 10 kHz. Span= 1.5 times the DTS bandwidth, Sweep = auto; Detector = Peak; Trace mode=max hold, Trace=Max hold.
- 3) Use the peak marker function to determine the maximum amplitude level within the RBW.
- 4) Record the marker level for the particular mode.
- 5) Repeat these steps for other channel and modes.

Test Limit:

8dBm/3kHz

Test data:

Test Channel	Test Frequency (MHz)	Reading (dBm/3KHz)	Cable Loss (dB)	PSD (dBm/3KHz)	Limit (dBm/3KHz)	Test Result
Lowest	2402	-10.86	0.5	-10.36	8	Pass
Middle	2440	-10.74	0.5	-10.24	8	Pass
Highest	2480	-11.61	0.5	-11.11	8	Pass

RF Power Density = Reading Power + Cable Loss

Test plot as follows:

Test channel: Lowest

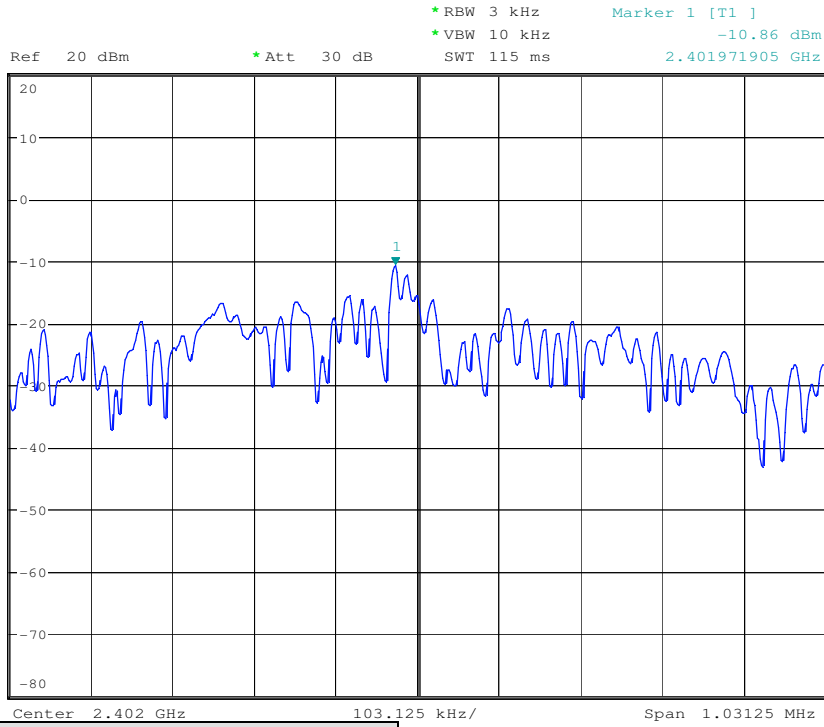

Test channel: Middle

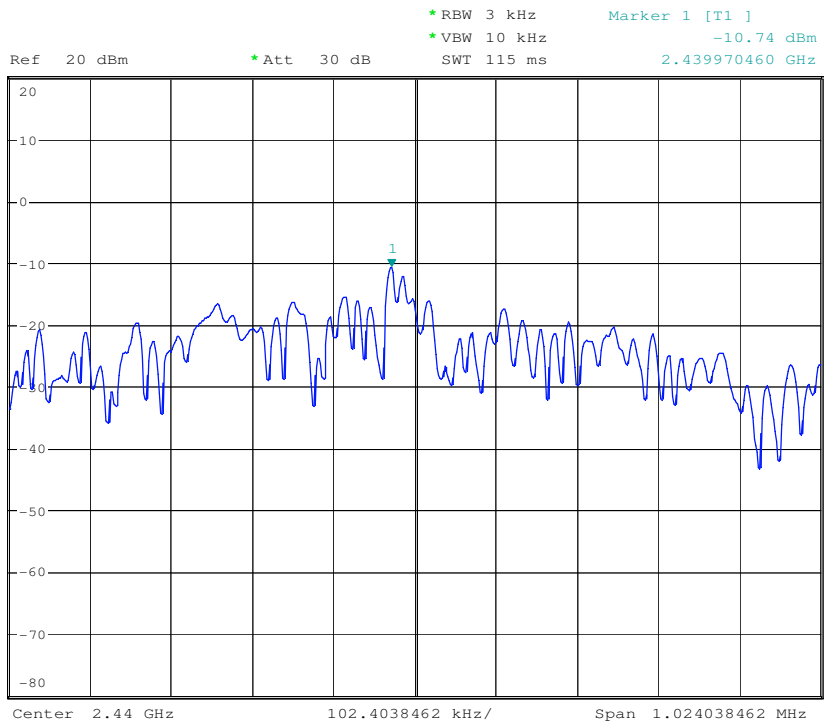

Test channel: Highest



*RBW 3 kHz Marker 1 [T1]
 *VBW 10 kHz -11.61 dBm
 SWT 115 ms 2.479968842 GHz

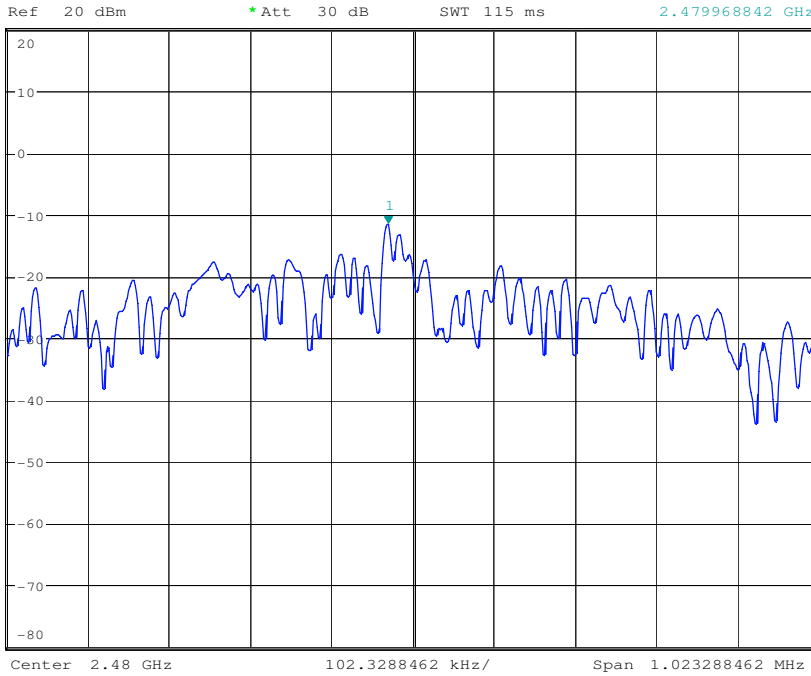

7.7 Conducted Spurious Emissions and Band edge

Test Configuration:

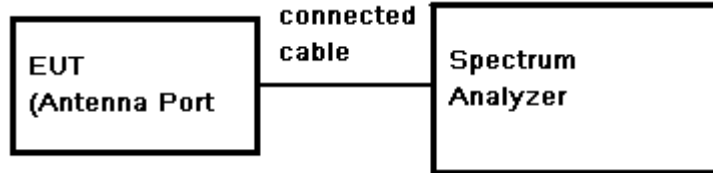

Test Procedure:

- 1) Remove the antenna from the EUT and then connect a low RF cable from the antenna port to the spectrum.
- 2) Set the spectrum analyzer: RBW = 100 KHz. VBW = 300 KHz. Sweep = auto; Detector Function = Peak (Max. hold).
- 3) Measurement were investigated while operating in MIMO mode, however, it was determined that single antenna operation produced the worst emissions. Since the data of MIMO mode are not report.

Limit:

(d) In any 100 kHz bandwidth outside the frequency band in which the spread spectrum or digitally modulated intentional radiator is operating, the radio frequency power that is produced by the intentional radiator shall be at least 20 dB below that in the 100 kHz bandwidth within the band that contains the Highest level of the desired power, based on either an RF conducted or a radiated measurement, provided the transmitter demonstrates compliance with the peak conducted power limits.

7.7.1 Conducted Spurious Emissions

Test plot as follows:

Test channel: Lowest

30MHz-3GHz:

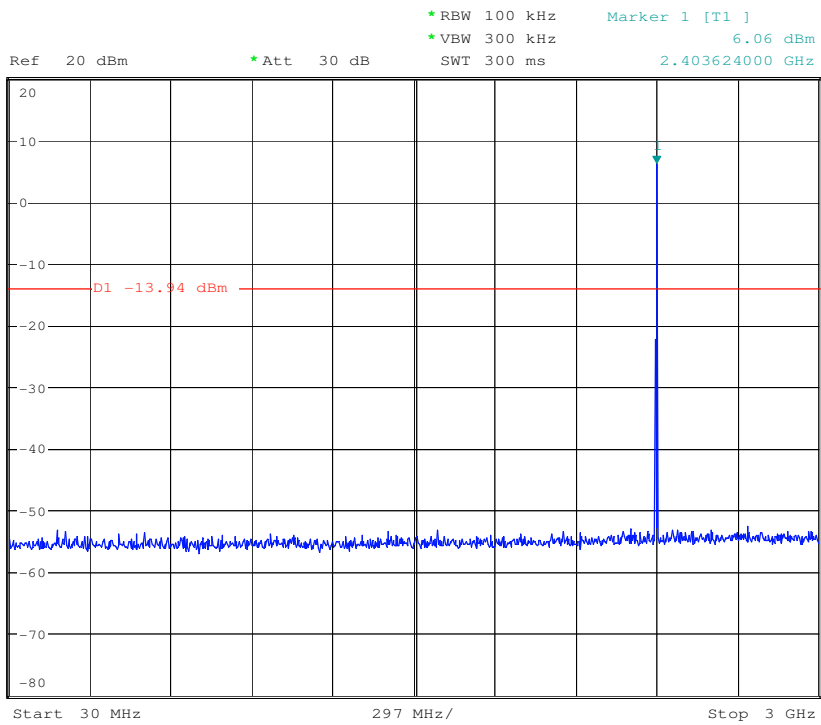

3GHz-25GHz:

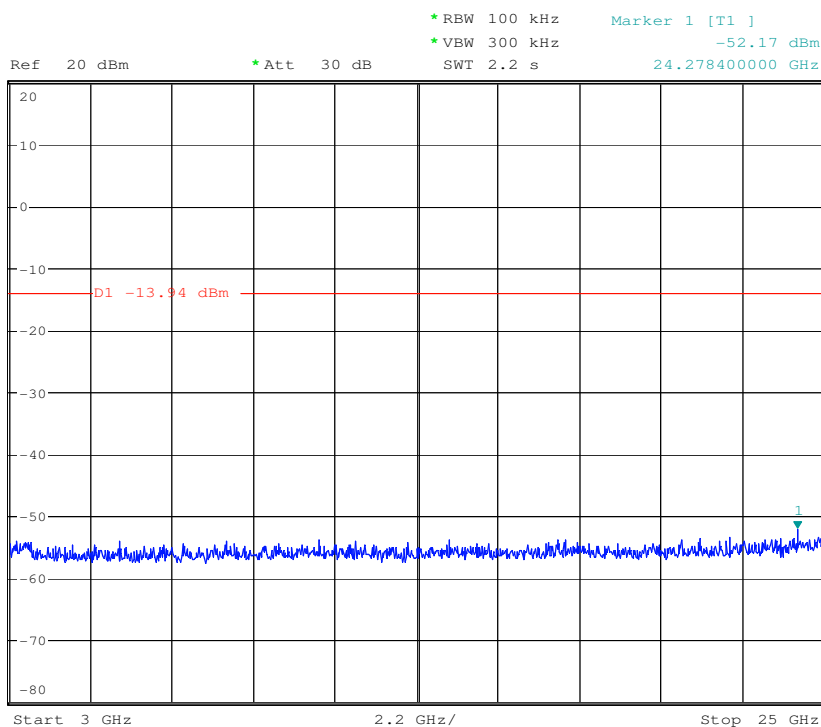

Test channel: Middle

30MHz-3GHz:

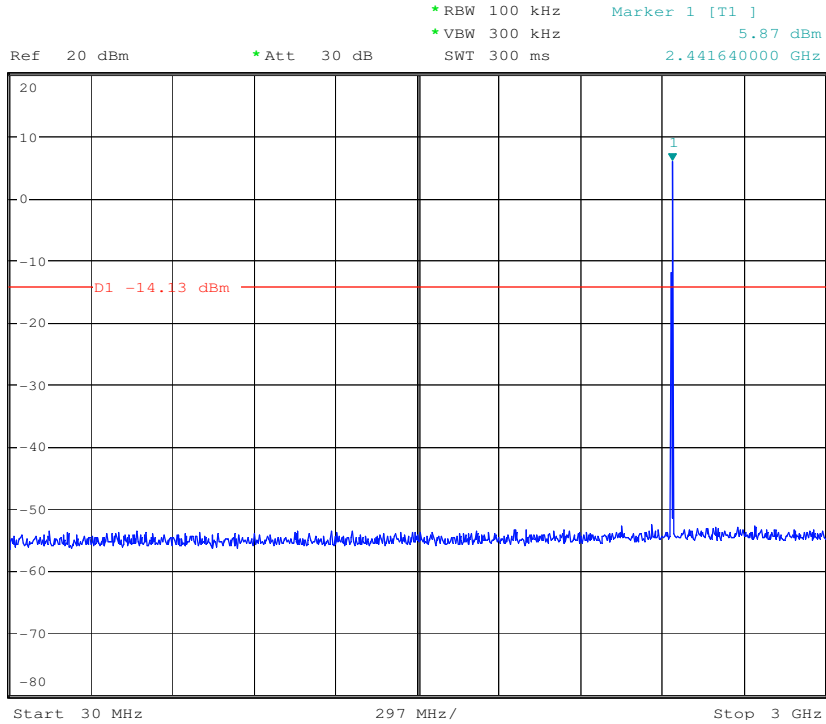

3GHz-25GHz:

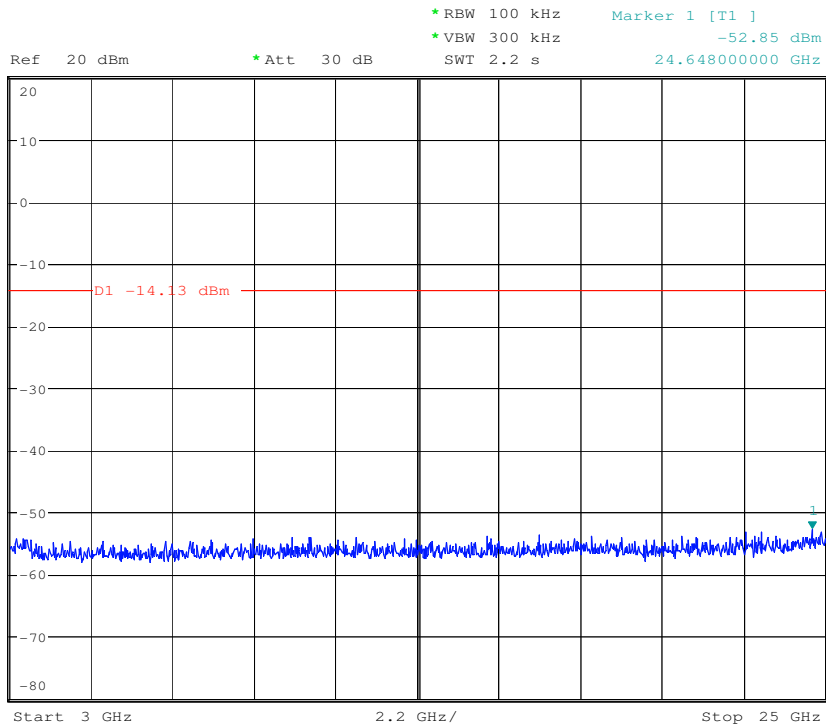

Test channel: Highest

30MHz-3GHz:

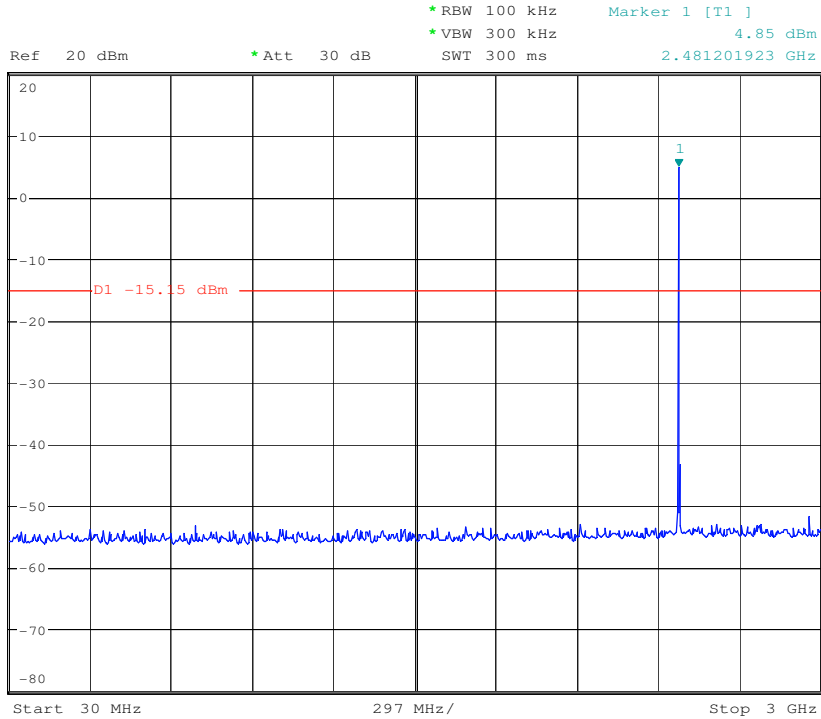

3GHz-25GHz:

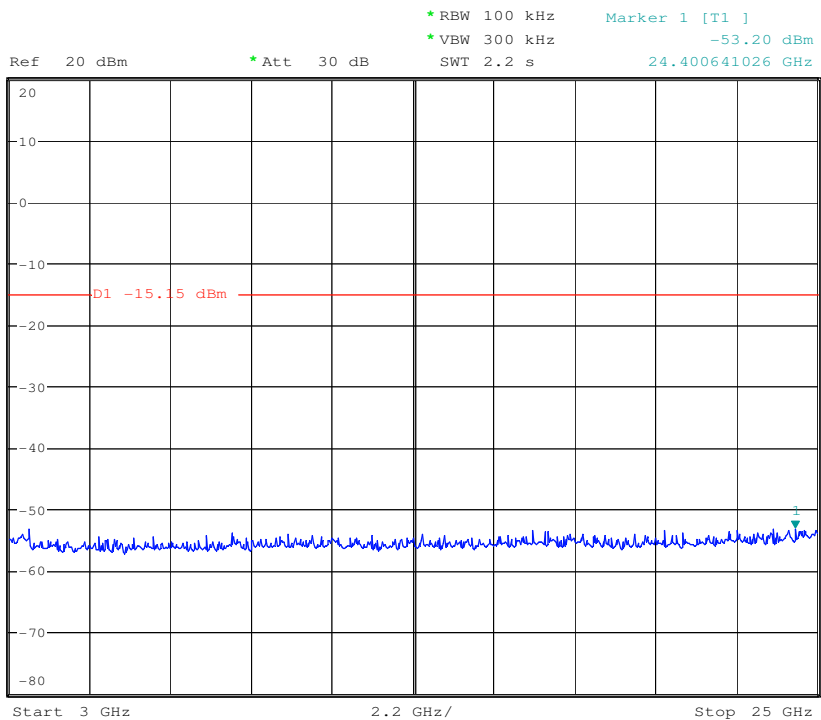

7.7.2 Conducted Band-edge Test plot as follows:

Test channel: Lowest

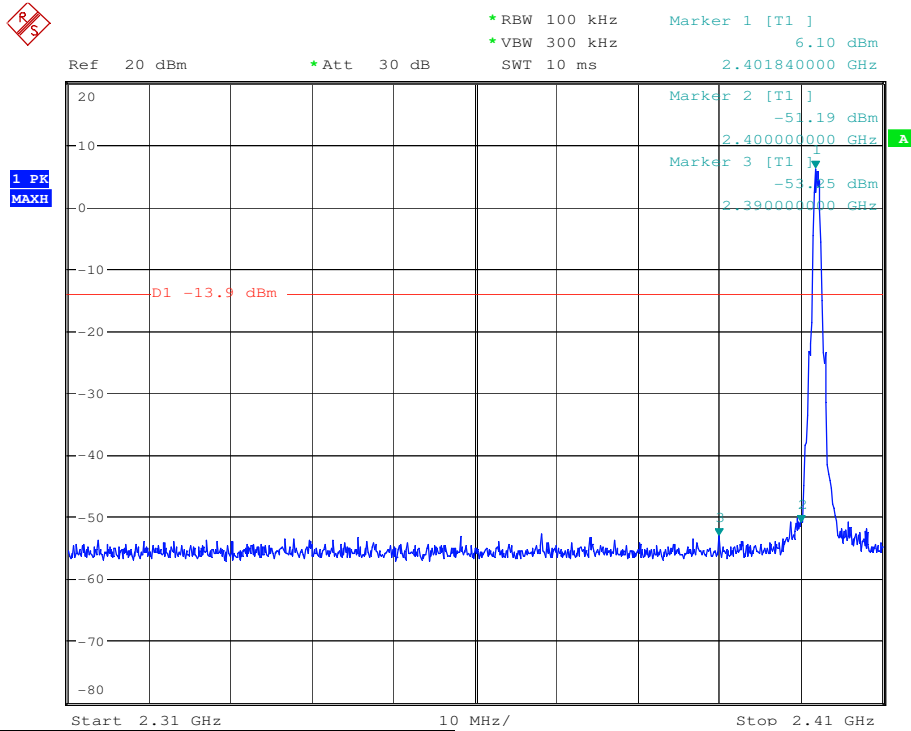

Test channel: Highest

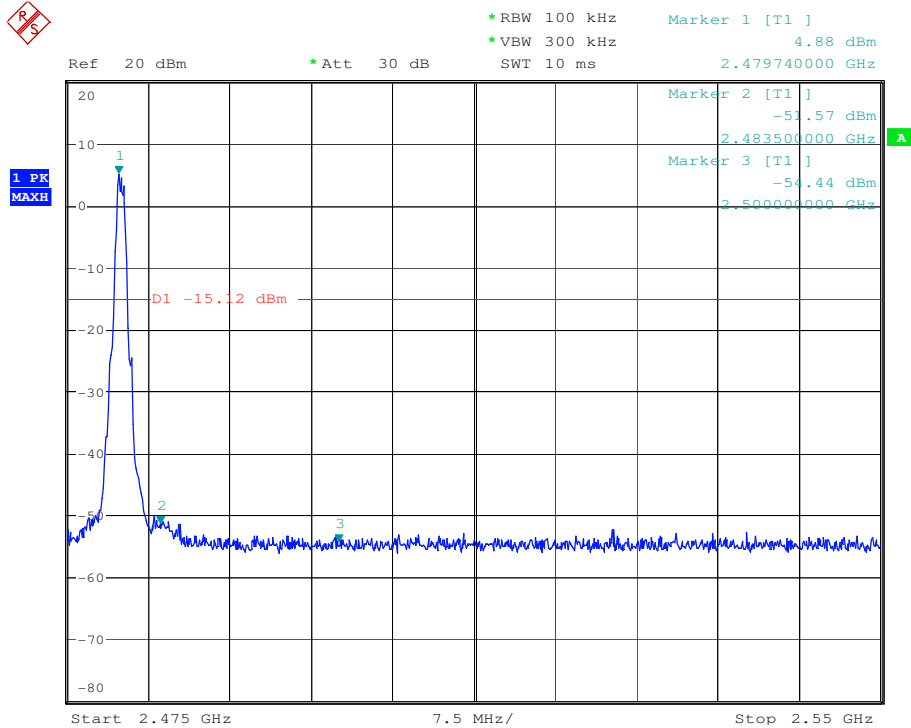

7.8 Radiated Spurious Emissions and Band-edge

Frequency Range: 9KHz to 25GHz

Test site/setup: Measurement Distance: 3m
Test instrumentation set-up:

Frequency Range	Detector	RBW	VBW
0.009MHz-0.090MHz	Peak	10kHz	30kHz
0.009MHz-0.090MHz	Average	10kHz	30kHz
0.090MHz-0.110MHz	Quasi-peak	10kHz	30kHz
0.110MHz-0.490MHz	Peak	10kHz	30kHz
0.110MHz-0.490MHz	Average	10kHz	30kHz
0.490MHz -30MHz	Quasi-peak	10kHz	30kHz
30MHz-1GHz	Quasi-peak	100kHz	300kHz
Above 1GHz	Peak	RBW=1MHz	VBW≥RBW
	Average		VBW=10Hz

Sweep=Auto

15.209 Limit:

Frequency	Limit (dBuV/m)
0.009MHz-0.490MHz	128.5 ~ 93.8
0.490MHz-1.705MHz	73.8 ~63.0
1.705MHz-30MHz	69.5
30MHz-88MHz	40.0
88MHz-216MHz	43.5
216MHz-960MHz	46.0
960MHz-1GHz	54.0
Above 1GHz	54.0

Note: 15.35(b), Unless otherwise specified, the limit on peak radio frequency emissions is 20dB above the maximum permitted average emission limit applicable to the equipment under test. This peak limit applies to the total peak emission level radiated by the device.

Test Configuration: Receive antenna scan height 1 m - 4 m. polarization Vertical / Horizontal

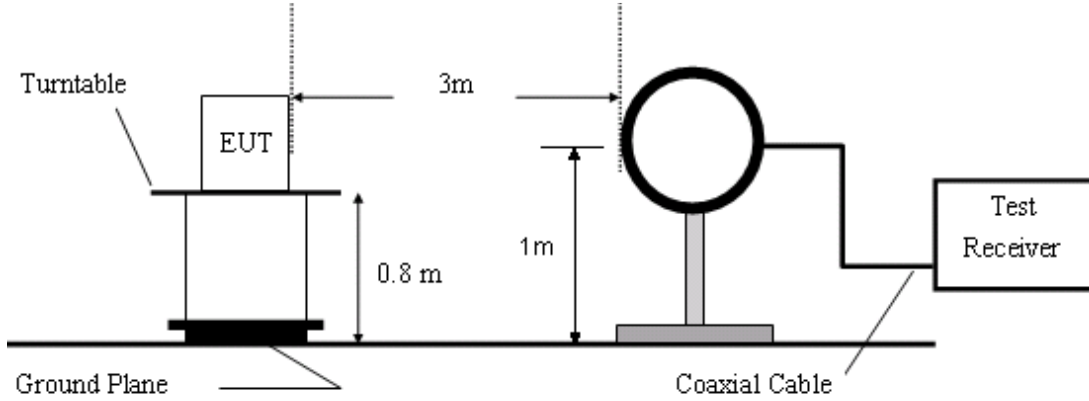

Figure1. Below 30MHz radiated emissions test configuration

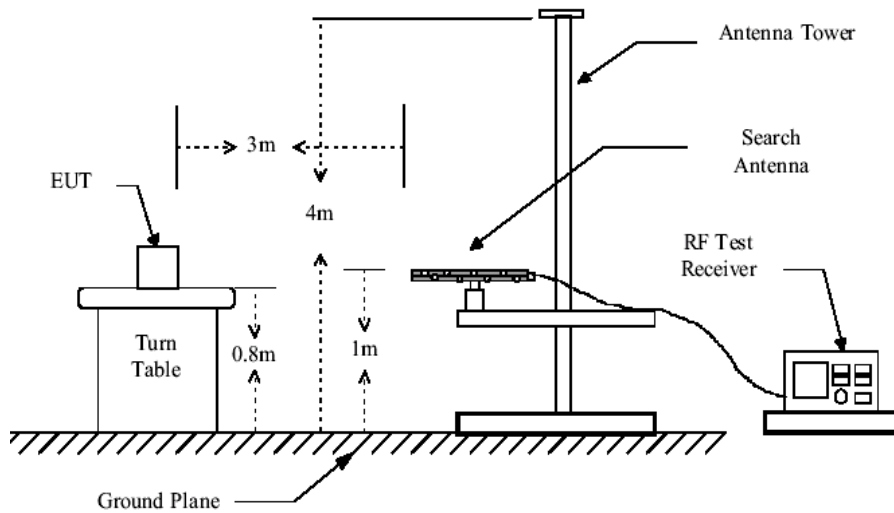

Figure 2. 30MHz to 1GHz radiated emissions test configuration

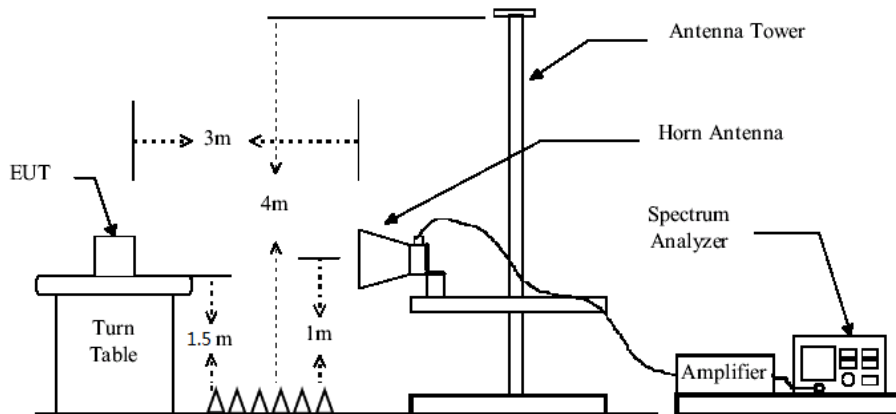

Figure 3. Above 1GHz radiated emissions test configuration

- Test Procedure:**
- 1) The procedure used was ANSI Standard C63.10. The receiver was scanned from 9 KHz to 25GHz. When an emission was found, the table was rotated to produce the maximum signal strength. An initial pre-scan was performed for in peak detection mode using the receiver. The EUT was measured for both the Horizontal and Vertical polarities and performed a pre-test three orthogonal planes. For intentional radiators, measurements of the variation of the input power or the radiated signal level of the fundamental frequency component of the emission, as appropriate, shall be performed with the supply voltage varied between 85% and 115% of the nominal rated supply voltage. The worst case emissions were reported.
 - 2) Low noise amplifier was used below 1GHz, High pass Filter was used above 3GHz. We did not use any amplifier or filter between 1G and 3GHz.
 - 3) Test were performed for their spatial orthogonal(X, Y, Z), the worst test data (X orthogonal) was submitted.
 - a) For this intentional radiator operates below 25 GHz. the spectrum shall be investigated to the tenth harmonic of the highest fundamental frequency. And above the third harmonic of this intentional radiator, the disturbance is very low. So the test result only displays to 5rd harmonic.
 - b) As shown in Section, for frequencies above 1000MHz. the above field strength limits are based on average limits. However, the peak field strength of any emission shall not exceed the maximum permitted average limits specified above by more than 20 dB under any condition of modulation.
 - 4) No spurious emissions were detected within 20dB of limit below 30MHz.

Test Result: Pass

7.8.1 Radiated Spurious Emissions

Highest Channel

Item	Freq.	Read Level	Antenna Factor	Preamp Factor	Cable Loss	Result Level	Limit Line	Over Limit	Detector	Polarization
(Mark)	(MHz)	(dBμV)	(dB/m)	(dB)	(dB)	(dBμV/m)	(dBμV/m)	(dB)		
1	48.84	26.18	13.86	28.80	1.13	12.37	40.00	-27.63	QP	Horizontal
2	61.35	26.42	12.26	28.80	1.20	11.08	40.00	-28.92	QP	Horizontal
3	151.07	26.39	12.72	28.40	1.49	12.20	43.50	-31.30	QP	Horizontal
4	319.94	26.53	13.30	28.06	2.28	14.05	46.00	-31.95	QP	Horizontal
5	550.95	27.54	19.20	29.23	3.15	20.66	46.00	-25.34	QP	Horizontal
6	827.49	26.55	23.77	29.06	3.90	25.16	46.00	-20.84	QP	Horizontal
1	42.90	26.88	13.62	28.80	0.96	12.66	40.00	-27.34	QP	Vertical
2	52.39	26.68	13.52	28.80	1.15	12.55	40.00	-27.45	QP	Vertical
3	131.30	27.00	11.96	28.50	1.38	11.84	43.50	-31.66	QP	Vertical
4	300.37	25.25	13.50	27.90	2.25	13.10	46.00	-32.90	QP	Vertical
5	584.79	26.58	20.27	29.24	3.19	20.80	46.00	-25.20	QP	Vertical
6	818.83	26.37	23.69	29.07	3.87	24.86	46.00	-21.14	QP	Vertical

Result Level = Read Level + Antenna Factor + Cable loss - Preamp Factor

Below is the plot of worst case on highest channel:
Vertical:

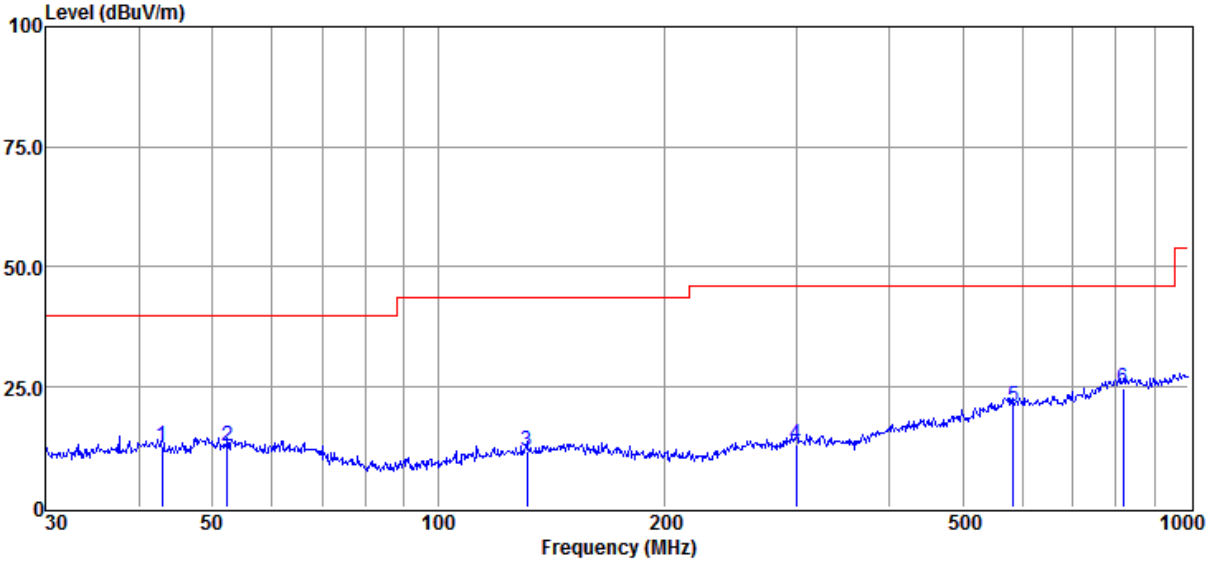

Horizontal:

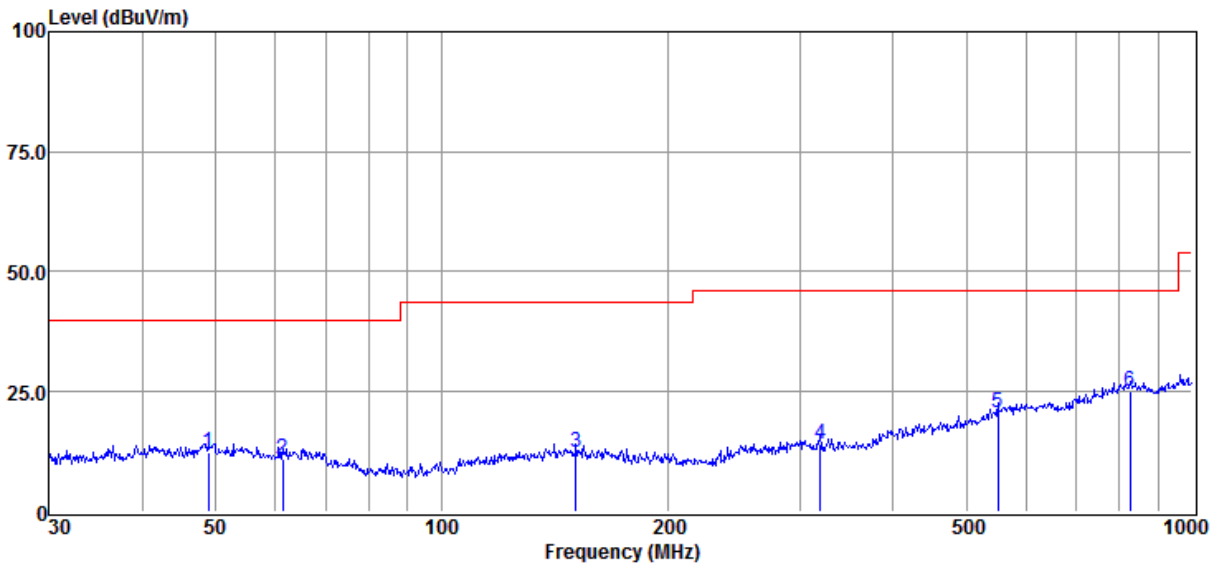

Above 1GHz:

Lowest Channel(2402MHz)

Mark	Frequency (MHz)	Reading (dBuV)	Factor (dB)	Emission (dBuV/m)	Limit (dBuV/m)	Over Limit (dB)	Detector	polarization
1	4804	37.36	6.18	43.54	54	-10.46	peak	Horizontal
2	7206	35.26	10.63	45.89	54	-8.11	peak	Horizontal
3	9608	34.58	14.38	48.96	54	-5.04	peak	Horizontal
4	4804	37.27	6.18	43.45	54	-10.55	peak	Vertical
5	7206	35.81	10.63	46.44	54	-7.56	peak	Vertical
6	9608	35.43	14.38	49.81	54	-4.19	peak	Vertical

Middle Channel(2440MHz)

Mark	Frequency (MHz)	Reading (dBuV)	Factor (dB)	Emission (dBuV/m)	Limit (dBuV/m)	Over Limit (dB)	Detector	polarization
1	4880	36.23	6.97	43.2	54	-10.8	peak	Horizontal
2	7320	35.64	11.12	46.76	54	-7.24	peak	Horizontal
3	9760	32.98	14.35	47.33	54	-6.67	peak	Horizontal
4	4880	36.28	6.97	43.25	54	-10.75	peak	Vertical
5	7320	36.56	11.12	47.68	54	-6.32	peak	Vertical
6	9760	34.53	14.35	48.88	54	-5.12	peak	Vertical

Highest Channel(2480MHz)

Mark	Frequency (MHz)	Reading (dBuV)	Factor (dB)	Emission (dBuV/m)	Limit (dBuV/m)	Over Limit (dB)	Detector	polarization
1	4960	39.33	7.49	46.82	54	-7.18	peak	Horizontal
2	7440	36.54	11.65	48.19	54	-5.81	peak	Horizontal
3	9920	34.81	14.4	49.21	54	-4.79	peak	Horizontal
4	4960	36.32	7.49	43.81	54	-10.19	peak	Vertical
5	7440	36.87	11.65	48.52	54	-5.48	peak	Vertical
6	9920	34.29	14.4	48.69	54	-5.31	peak	Vertical

- Remark: 1) Emission = Receiver Reading + Factor
 2) Factor = Antenna Factor + Cable Loss + Pre-amplifier Factor.
 3) If the Peak value below the AV Limit, the AV test doesn't perform for this submission.

**7.8.2 Radiated Band-edge
Lowest Channel (2402MHz)**

MK.	Frequency (MHz)	Reading (dBuV/m)	Corrected factor(dB)	Result (dBuV/m)	Limit (dBuV/m)	Over Limit (dB)	Detector	Polarization
1	2383.2	47.27	-3.87	43.4	54	-10.6	Peak	Horizontal
2	2390	45.5	-3.89	41.61	54	-12.39	Peak	Horizontal
3	2402	101.77	-3.91	97.86	54	43.86	Peak	Horizontal
1	2382.7	48.17	-3.86	44.31	54	-9.69	Peak	Vertical
2	2390	44.95	-3.89	41.06	54	-12.94	Peak	Vertical
3	2402.1	95.63	-3.92	91.71	54	37.71	Peak	Vertical

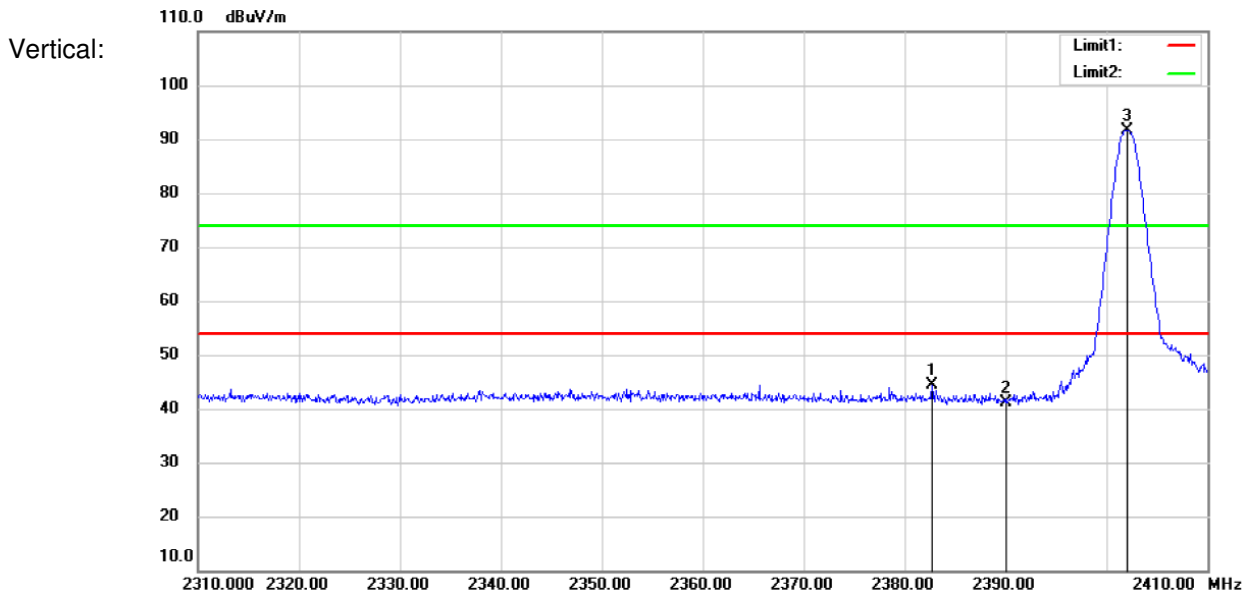
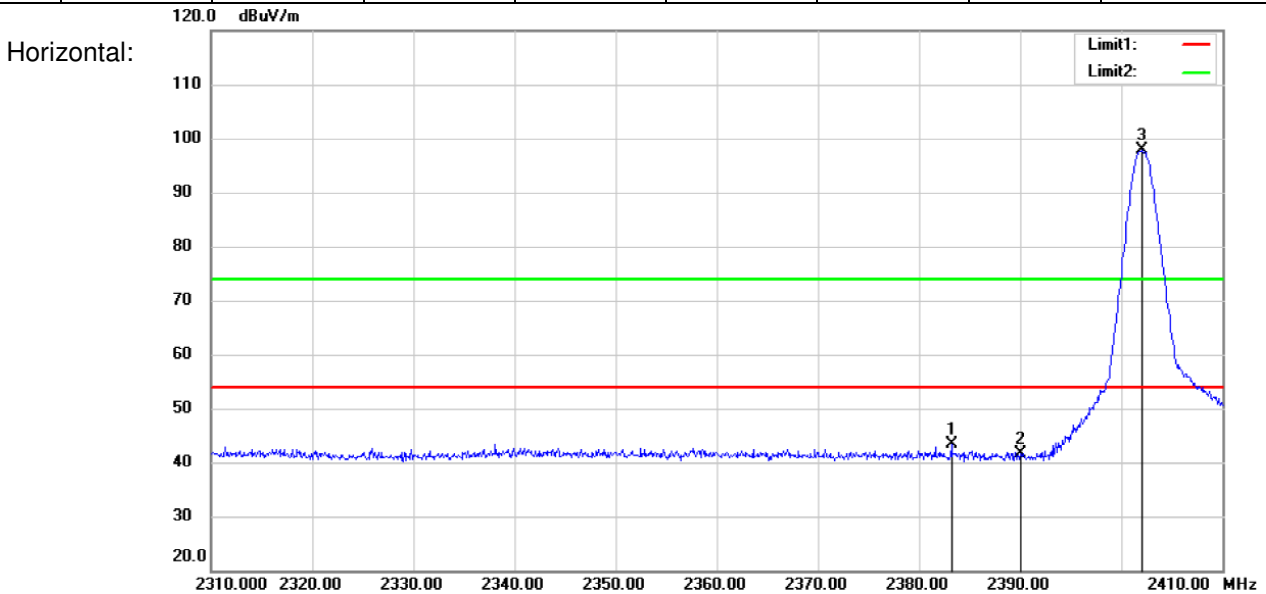

Highest Channel (2480MHz)

MK.	Frequency (MHz)	Reading (dBuV/m)	Corrected factor(dB)	Result (dBuV/m)	Limit (dBuV/m)	Over Limit (dB)	Detector	Polarization
1	2477.975	99.65	-4	95.65	54	41.65	Peak	Horizontal
2	2483.5	56.92	-4.01	52.91	54	-1.09	Peak	Horizontal
3	2483.75	56.78	-4.01	52.77	54	-1.23	Peak	Horizontal
1	2477.975	93.57	-4	89.57	54	35.57	Peak	Vertical
2	2483.5	52.78	-4.01	48.77	54	-5.23	Peak	Vertical
3	2484.375	52.14	-4.02	48.12	54	-5.88	Peak	Vertical

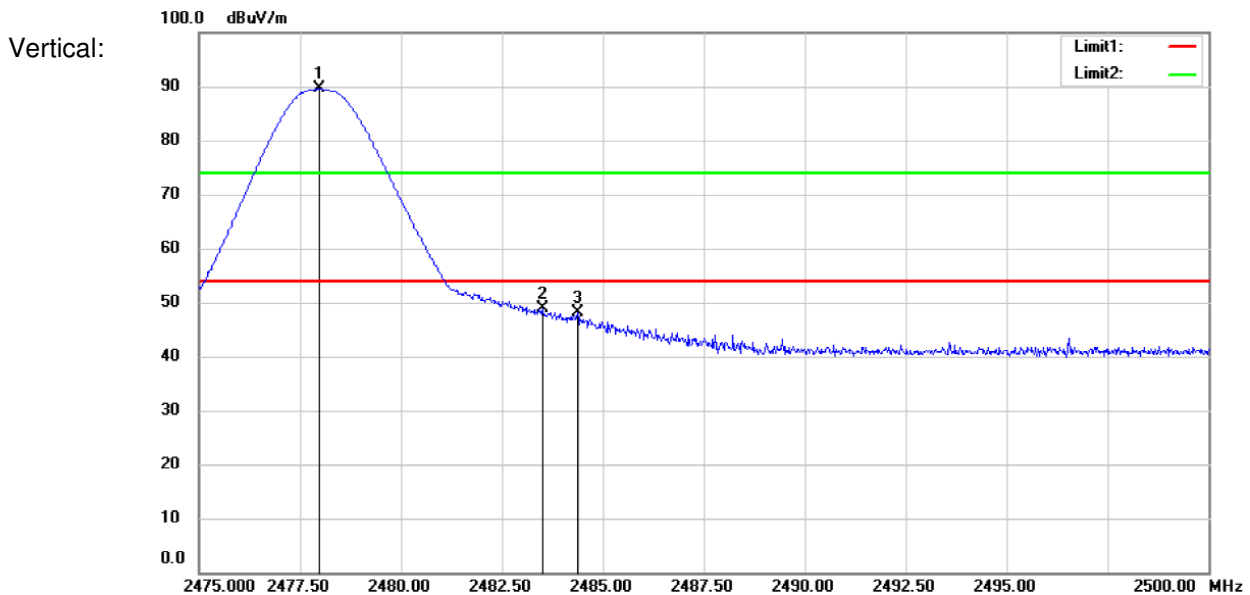
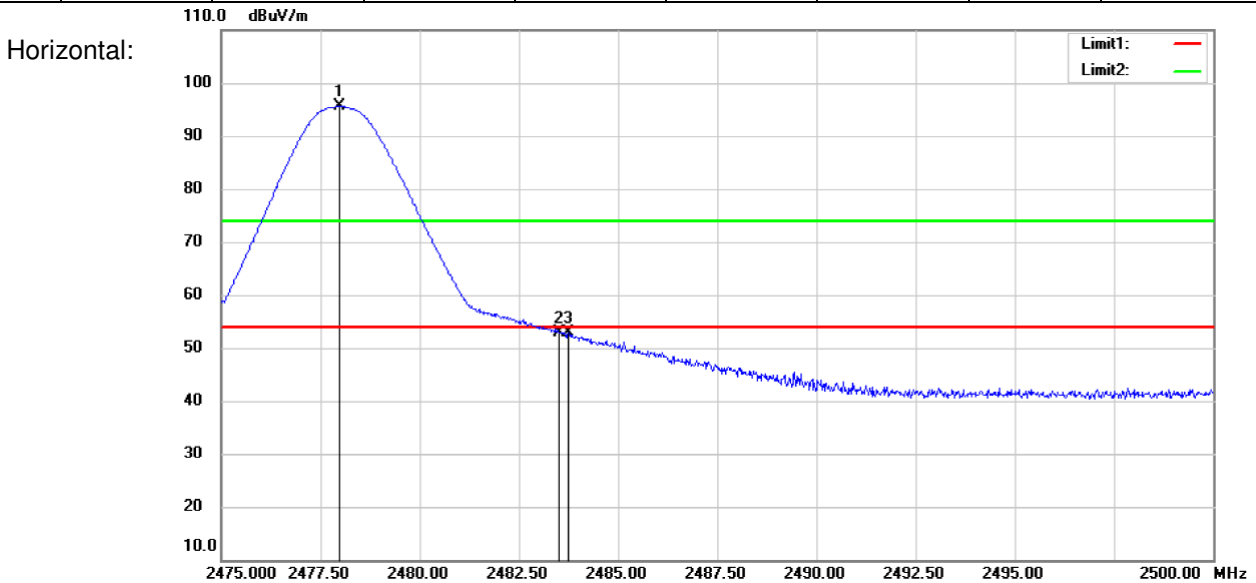



Remark: 1). Test Level = Receiver Reading + Antenna Factor + Cable Loss- Preamplifier Factor
2). If the Peak value below the AV Limit, the AV test doesn't perform for this submission.

All frequencies within the "Restricted bands" have been evaluated to compliance. Except as shown in paragraph of this section, only spurious emissions are permitted in any of the frequency bands listed below:

a. FCC Part 15, Subpart C Section 15.205 Restricted bands of operation.

MHz	MHz	MHz	GHz
0.090 - 0.110	16.42 - 16.423	399.9 - 410	4.5 - 5.15
¹ 0.495 - 0.505	16.69475 - 16.69525	608 - 614	5.35 - 5.46
2.1735 - 2.1905	16.80425 - 16.80475	960 - 1240	7.25 - 7.75
4.125 - 4.128	25.5 - 25.67	1300 - 1427	8.025 - 8.5
4.17725 - 4.17775	37.5 - 38.25	1435 - 1626.5	9.0 - 9.2
4.20725 - 4.20775	73 - 74.6	1645.5 - 1646.5	9.3 - 9.5
6.215 - 6.218	74.8 - 75.2	1660 - 1710	10.5 - 12.7
6.26775 - 6.26825	108 - 121.94	1718.8 - 1722.2	13.25 - 13.4
6.31175 - 6.31225	123 - 138	2200 - 2300	14.47 - 14.5
8.291 - 8.294	149.9 - 150.05	2310 - 2390	15.35 - 16.2
8.362 - 8.366	156.52475 - 156.52525	2483.5 - 2500	17.7 - 21.4
8.37625 - 8.38675	156.7 - 156.9	2655 - 2900	22.01 - 23.12
8.41425 - 8.41475	162.0125 - 167.17	3260 - 3267	23.6 - 24.0
12.29 - 12.293	167.72 - 173.2	3332 - 3339	31.2 - 31.8
12.51975 - 12.52025	240 - 285	3345.8 - 3358	36.43 - 36.5
12.57675 - 12.57725	322 - 335.4	3600 - 4400	
13.36 - 13.41			

b. RSS-Gen section 7.2.2 Restricted bands of operation

MHz	MHz	GHz
0.090-0.110	240-285	9.0-9.2
2.1735-2.1905	322-335.4	9.3-9.5
3.020-3.026	399.9-410	10.6-12.7
4.125-4.128	608-614	13.25-13.4
4.17725-4.17775	960-1427	14.47-14.5
4.20725-4.20775	1435-1626.5	15.35-16.2
5.677-5.683	1645.5-1646.5	17.7-21.4
6.215-6.218	1660-1710	22.01-23.12
6.26775-6.26825	1718.8-1722.2	23.6-24.0
6.31175-6.31225	2200-2300	31.2-31.8
8.291-8.294	2310-2390	36.43-36.5
8.362-8.366	2655-2900	Above 38.6
8.37625-8.38675	3260-3267	
8.41425-8.41475	3332-3339	
12.29-12.293	3345.8-3358	
12.51975-12.52025	3500-4400	
12.57675-12.57725	4500-5150	
13.36-13.41	5350-5460	
16.42-16.423	7250-7750	
16.69475-16.69525	8025-8500	
16.80425-16.80475		
25.5-25.67		
37.5-38.25		
73-74.6		
74.8-75.2		
108-138		
156.52475-156.52525		
156.7-156.9		

7.1 99% Occupied Bandwidth

Test Configuration:

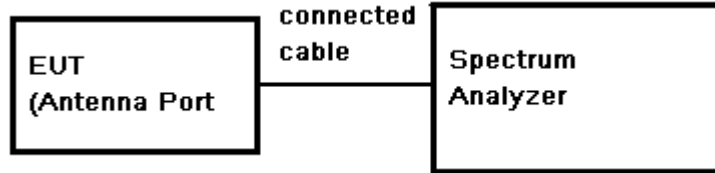

Test Procedure:

- 1) Place the EUT on the table and set it in transmitting mode.
- 2) Remove the antenna from the EUT and then connect a low loss RF cable from the antenna port to the spectrum analyzer.
- 3) Set the spectrum analyzer: Span = approximately 2 to 3 times the 20dB bandwidth, RBW \geq 1% of the 20dB bandwidth (set 30KHz). VBW \geq RBW. Sweep = auto; Detector Function = Peak. Trace = Max Hold.
- 4) Mark the peak frequency and 99% bandwidth points.
- 5) Repeat above procedures until all frequency measured was complete.

Limit:

\geq 500 kHz

Test date:

Test Channel	Test Frequency (MHz)	Bandwidth (MHz)
Lowest	2402	1.054
Middle	2440	1.056
Highest	2480	1.056

Test plot as follows:
Test Mode: **GFSK**

Channel: **lowest**

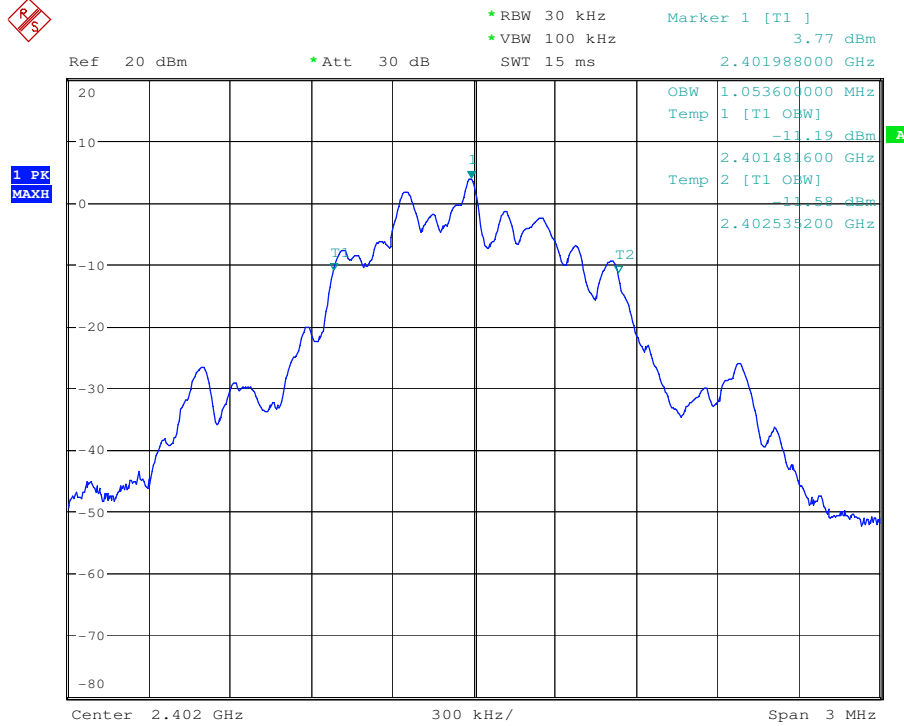

Test Mode: **GFSK**

Channel: **Middle**

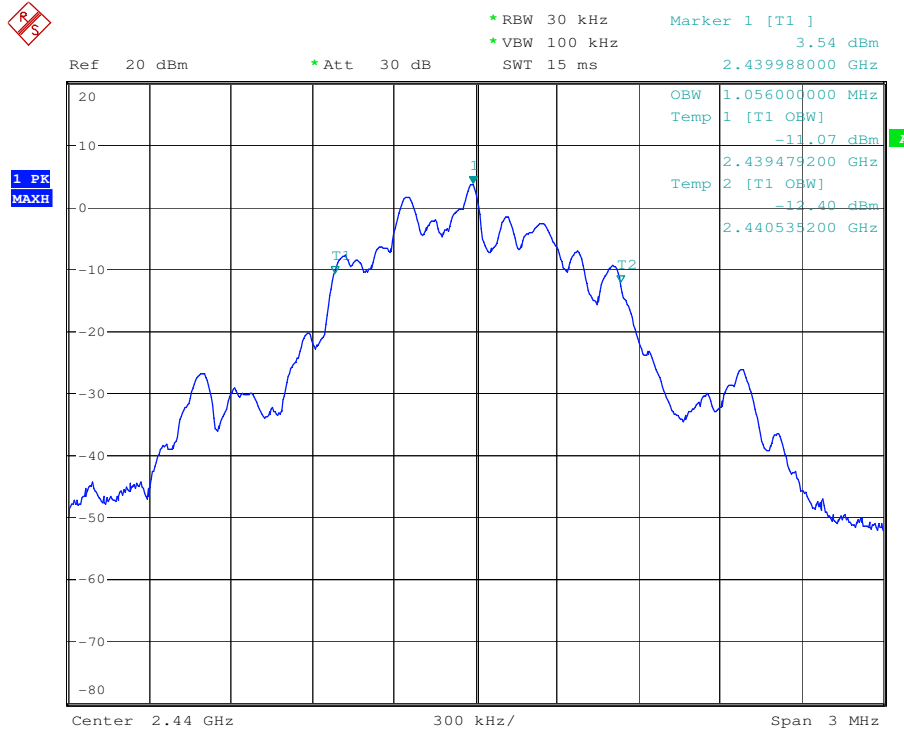

Test Mode: **GFSK**

Channel: **Highest**

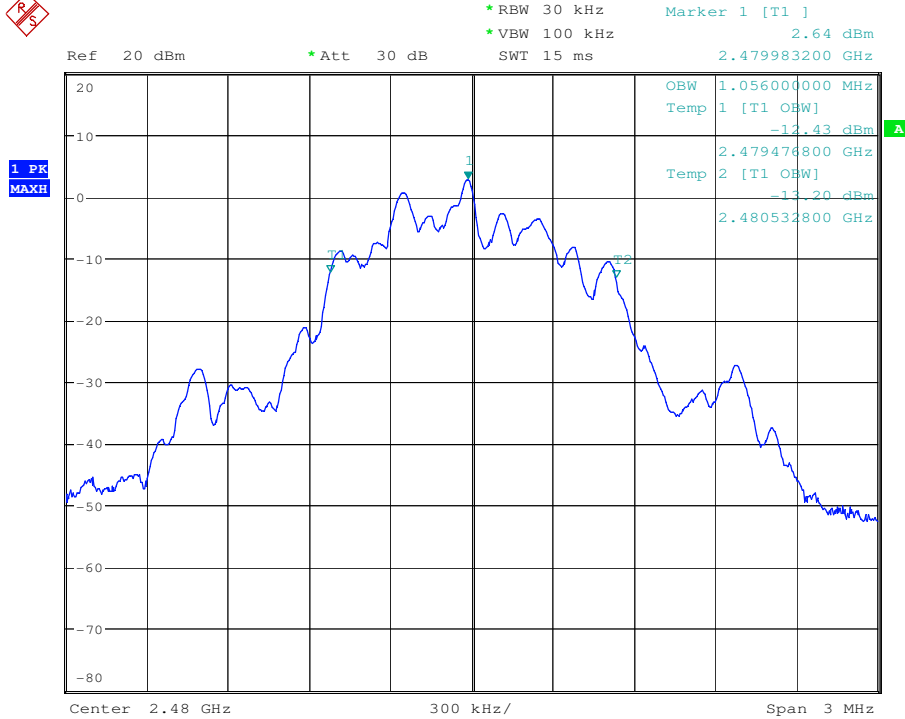

8 Test Setup Photographs

Refer to the < A1612_Test Setup photos-FCC >.

9 EUT Constructional Details

Refer to the < A1612_External Photos > & < A1612_Internal Photos >.

--End of the Report--