

Global EMC Inc. Labs

EMC & RF Test Report

As per

RSS 210 Issue 8:2010

&

FCC Part 15 Subpart C:2010
Unlicensed Intentional Radiators

on the

Elkay EZ Bottle Filler and Fountain (Single Level)



Raymond Lee Au, B.Eng
Project Engineer
Global EMC Inc.
11 Gordon Collins Dr.
Gormley, ON
L0H 1G0, Canada
Ph: (905) 883-8189

Testing produced for

ELKAY
Elkay Manufacturing Co.

See Appendix A for full customer & EUT details.

 **Industry
Canada**
LAB REGISTRATION #6844A-3

CE

FCC REGISTRATION
#377448

ACCREDITED
Testing Laboratory
Certificate #2555.01

Client	Elkay Manufacturing Co.	
Product	EZ Bottle Filler and Fountain (Single Level)	
Standard(s)	RSS 210 Issue 8:2010 / FCC Part 15 Subpart C 15:2014	

Table of Contents

Table of Contents 2

Report Scope 3

Summary 4

Test Results Summary 5

Justifications, Descriptions, Deviations & Notes 6

Applicable Standards, Specifications and Methods 7

Sample calculation(s) 8

Document Revision Status 8

Definitions and Acronyms 9

Testing Facility 10

Calibrations and Accreditations 10

Testing Environmental Conditions and Dates 11

Detailed Test Results Section 12

Radiated Emissions - Spurious 13

Radiated Emissions – Fundamental 22

99% Bandwidth 26

Appendix A – EUT Summary 28

Client	Elkay Manufacturing Co.	
Product	EZ Bottle Filler and Fountain (Single Level)	
Standard(s)	RSS 210 Issue 8:2010 / FCC Part 15 Subpart C 15:2014	

Report Scope

This report addresses the EMC testing and test results of the Elkay NextGen single level filtered drinking fountain. This unit is herein referred to as EUT (Equipment Under Test). Testing is performed at Global EMC Labs.

The EUT was tested for compliance against the following standards:

RSS 210 Issue 8:2010
FCC Part 15 Subpart C:2014

Test procedures, results, justifications, and engineering considerations, if any, follow later in this report.

The results contained in this report relate only to the item(s) tested.

This report does not imply product endorsement by A2LA or any other accreditation agency, any government, or Global EMC Inc.

Opinions/interpretations expressed in this report, if any, are outside the scope of Global EMC Inc accreditation. Any opinions expressed do not necessarily reflect the opinions of Global EMC Inc, unless otherwise stated.

Client	Elkay Manufacturing Co.	
Product	EZ Bottle Filler and Fountain (Single Level)	
Standard(s)	RSS 210 Issue 8:2010 / FCC Part 15 Subpart C 15:2014	

Summary

The results contained in this report relate only to the item(s) tested.

EUT FCC Certification #, FCC ID:	2AC8R-LZWSNA
EUT Industry Canada Certification #, IC:	12430A-LZWSNA
EUT Passed all tests performed.	Yes (see test results summary)
Tests conducted by	Raymond Lee Au

Client	Elkay Manufacturing Co.	
Product	EZ Bottle Filler and Fountain (Single Level)	
Standard(s)	RSS 210 Issue 8:2010 / FCC Part 15 Subpart C 15:2014	

Test Results Summary

Standard/Method	Description	Class/Limit	Result
FCC 15.203	Antenna Requirement	Unique	Pass See Justification
FCC 15.205 RSS 210 (Table 1)	Restricted Bands for intentional operation	QuasiPeak Average	Pass
FCC 15.207	Power line conducted emissions	QuasiPeak Average	Pass
FCC 15.209 RSS-210 (Table 2)	Spurious Radiated emissions	QuasiPeak Average	Pass
Overall Result			PASS

Client	Elkay Manufacturing Co.	
Product	EZ Bottle Filler and Fountain (Single Level)	
Standard(s)	RSS 210 Issue 8:2010 / FCC Part 15 Subpart C 15:2014	

All tests were performed by Raymond Lee Au.

If the product as tested or otherwise complies with the specification, the EUT is deemed to comply with the requirement and is deemed a 'PASS' grade. If not 'FAIL' grade will be issued. Note that 'PASS' / 'FAIL' grade is independent of any measurement uncertainties. A 'PASS' / 'FAIL' grade within measurement uncertainty is marked with a '*'.

Justifications, Descriptions, Deviations & Notes

The following justifications for tests not performed or deviations from the above listed specifications apply:

For the antenna requirement specified in FCC 15.203 (RSS 210 section 5.5), the antennas in this device are all inside the unit's enclosure, and are not meant to be replicable by the user.

The EUT consists of a co-located wireless design with a 15.247 transmitter designed to operate between 902.7 MHz and 927.3 MHz, and a 15.209 transmitter designed to operate at 13.56 MHz. This report (*GEMC-FCC-22089BR1*) pertains to the 15.209 transmitter. See report *GEMC-FCC-22089AR1* for testing on the 15.247 transmitter.

For the Restricted Bands of operation, the 15.209 transmitter is designed to operate at 13.56 MHz.

The EUT was tested in the upright position as it will be installed during use.

There are 4 versions of the EUT. They all have identical RF control boards for the 15.247 and 15.209 transmitters located in the same locations in the lower part of the unit (see photo exhibits). This part is electrically identical for all 4 versions. This part can be coupled with one of two display panels, which connect to the bottom part via a cable harness, and do not have RF components. The display can be a graphic display capable of showing video, or an alpha-numeric display, which can display messages. Each of these are available with a bare stainless steel finish, or be painted. Thus, the four versions are: 1. Graphics display with stainless steel finish, 2. Graphics display with painted metal finish, 3. Alpha-numeric display with stainless steel finish, and 4. Alpha-numeric display with painted metal finish. The system is not offered without a display. See *General EUT Description* table in *Appendix A* for the model numbers of each version.

For results of Power Line Conducted Emissions testing, see report *GEMC-FCC-22089AR1*.

Client	Elkay Manufacturing Co.	
Product	EZ Bottle Filler and Fountain (Single Level)	
Standard(s)	RSS 210 Issue 8:2010 / FCC Part 15 Subpart C 15:2014	

Applicable Standards, Specifications and Methods

ANSI C63.4:2009	- Methods of Measurement of Radio-Noise Emissions from Low-Voltage Electrical and Electronic Equipment in the Range of 9 kHz to 40 GHz
ANSI C63.10:2009	- American national standard for testing unlicensed wireless devices
CFR 47 FCC 15	- Code of Federal Regulations – Radio Frequency Devices
CISPR 22:2008	- Information technology equipment – Radio disturbance characteristics – Limits and methods of measurement
ICES-003:2012	- Digital Apparatus - Spectrum Management and Telecommunications Policy Interference-Causing Equipment Standard
ISO 17025:2005	- General Requirements for the competence of testing and calibration laboratories
RSS-GEN	General Requirements and Information for the Certification of Radio Apparatus
RSS 210:2010	- Issue 8: Spectrum Management and Telecommunications Policy. Radio Standards Specification Low Power Licence-Exempt Radiocommunication Devices

Client	Elkay Manufacturing Co.	
Product	EZ Bottle Filler and Fountain (Single Level)	
Standard(s)	RSS 210 Issue 8:2010 / FCC Part 15 Subpart C 15:2014	

Sample calculation(s)

Margin = limit – (received signal + antenna factor + cable loss – pre-amp gain)

Margin = 50.5dBuV/m – (50dBuV + 10dB + 2.5dB – 20dB)

Margin = 8 dB

Document Revision Status

Release 1 - November 28, 2014
Initial release.

Client	Elkay Manufacturing Co.	
Product	EZ Bottle Filler and Fountain (Single Level)	
Standard(s)	RSS 210 Issue 8:2010 / FCC Part 15 Subpart C 15:2014	

Definitions and Acronyms

The following definitions and acronyms are applicable in this report.
See also ANSI C63.14.

AE – Auxillary Equipment.

BW – Bandwidth. Unless otherwise stated, this is refers to the 6 dB bandwidth.

EMC – Electro-Magnetic Compatibility

EMI – Electro-Magnetic Immunity

EUT – Equipment Under Test

ITE – Information Technology Equipment with a primary function(s) of entry, storage, display, retrieval, transmission, processing, switching, or control, of data.

LISN – Line impedance stabilization network

NCR – No Calibration Required

RF – Radio Frequency

Client	Elkay Manufacturing Co.	
Product	EZ Bottle Filler and Fountain (Single Level)	
Standard(s)	RSS 210 Issue 8:2010 / FCC Part 15 Subpart C 15:2014	

Testing Facility

Testing for EMC on the EUT was carried out at Global EMC labs in Toronto, Ontario, Canada. The testing lab consists of a 3m semi-anechoic chamber calibrated to be able to allow measurements on an EUT with a maximum width or length of up to 2m and height up to 3m. The chamber is equipped with a turn table that is capable of testing devices up to 3300lb in weight. This facility is capable of testing products that are rated for 120 Vac and 240Vac single phase, or 208 Vac 3 phase input. DC capability is also available. The chamber is equipped with an antenna mast that controls polarization and height from the control room adjoining the shielded chamber. Radiated emissions measurements are performed using a Bilog, and Horn antenna where applicable. Conducted emissions, unless otherwise stated, are performed using a LISN.

Calibrations and Accreditations

The measurement site used is registered with Federal Communications Commission (FCC) and Industry Canada (IC). This site is calibrated for Normalized Site Attenuation (NSA) using test procedures outlined in ANSI C63.4 “Methods of Measurement of Radio-Noise Emissions from Low-Voltage Electrical and Electronic Equipment in the Range of 9 kHz to 40 GHz”. The semi-anechoic chamber is lined with ferrite tiles and absorption cones to minimize any undesired reflections. All measuring equipment is calibrated on an annual or bi-annual basis as listed for each respective test.

Client	Elkay Manufacturing Co.	
Product	EZ Bottle Filler and Fountain (Single Level)	
Standard(s)	RSS 210 Issue 8:2010 / FCC Part 15 Subpart C 15:2014	

Testing Environmental Conditions and Dates

Following were the environmental conditions in the facility during time of testing –

Date	Test	Init.	Temperature (°C)	Humidity (%)	Pressure (kPa)
Sept. 2 – 5 , 2014	All	RA	20-25°C	30-45%	100 -103kPa

Client	Elkay Manufacturing Co.	
Product	EZ Bottle Filler and Fountain (Single Level)	
Standard(s)	RSS 210 Issue 8:2010 / FCC Part 15 Subpart C 15:2014	

Detailed Test Results Section

Client	Elkay Manufacturing Co.	
Product	EZ Bottle Filler and Fountain (Single Level)	
Standard(s)	RSS 210 Issue 8:2010 / FCC Part 15 Subpart C 15:2014	

Radiated Emissions - Spurious

Purpose

The purpose of this test is to ensure that the RF energy unintentionally emitted from the EUT does not exceed the limits listed below as defined in the applicable test standard, as measured from a receiving antenna. This helps protect broadcast radio services such as television, FM radio, pagers, cellular telephones, emergency services, and so on, from unwanted interference.

Limit(s) and Method

The method is as defined in ANSI C63.4:2003.

The limits are as defined in FCC Part 15, Section 15.209:

The limits, as defined in 15.247(d) for unintentional radiated emissions apply for those emissions that fall in the restricted bands, as defined in Section 15.205(a). These emissions must comply with the radiated emission limits specified in Section 15.209(a).

0.009 MHz – 0.490 MHz, 2400/F(kHz) uV/m at 300 m¹
0.490 MHz – 1.705 MHz, 24000/F(kHz) uV/m at 30 m¹
1.705 MHz – 30 MHz, 30 uV/m at 30 m¹
30 MHz – 88 MHz, 100 uV/m (40.0 dBuV/m¹) at 3 m
88 MHz – 216 MHz, 150 uV/m (43.5 dBuV/m¹) at 3 m
216 MHz – 960 MHz, 200 uV/m (46.0 dBuV/m¹) at 3 m
Above 960 MHz, 500 uV/m (54.0 dBuV/m¹) at 3 m
Above 1000 MHz, 500 uV/m (54 dBuV/m²) at 3m
Above 1000 MHz, 500 uV/m (74 dBuV/m³) at 3m

¹Limit is with Quasi Peak detector with bandwidths as defined in CISPR-16-1-1.

²Limit is with 1 MHz measurement bandwidth and using an Average detector.

³Limit is with 1 MHz measurement bandwidth and using a Peak detector.

Client	Elkay Manufacturing Co.	
Product	EZ Bottle Filler and Fountain (Single Level)	
Standard(s)	RSS 210 Issue 8:2010 / FCC Part 15 Subpart C 15:2014	

Typical Radiated Emissions Setup

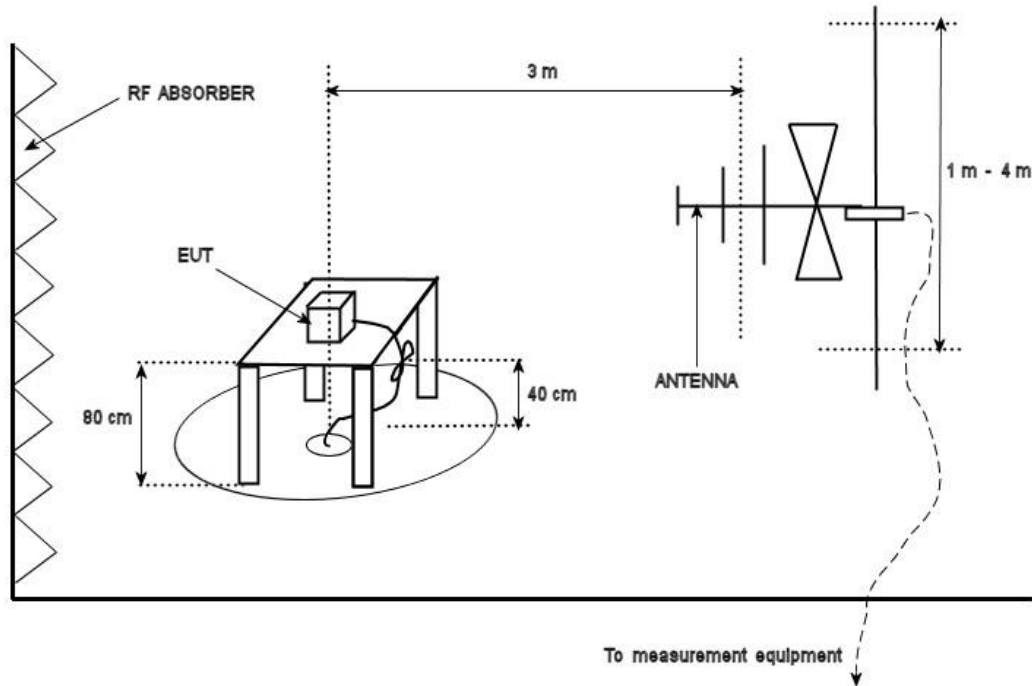

Measurement Uncertainty

The expanded measurement uncertainty is calculated in accordance with CISPR 16-4-2 and is +/-4.4 dB with a 'k=2' coverage factor and a 95% confidence level.

Preliminary Graphs

Note the graphs shown below are for graphical illustration only. For final measurements with the appropriate detector, please refer to the final measurement table where applicable. The graphs shown below are maximized peak measurement graphs, measured with a resolution bandwidth greater than or equal to, the final required detector and over a full 0-360° rotation. This peaking process is done as a worst case measurement. This process enables the detection of frequencies of concern for final measurement, and provides considerable time savings.

In accordance with FCC Part 15, Subpart A, Section 15.33, the device was scanned to the 10th harmonic.

Client	Elkay Manufacturing Co.	
Product	EZ Bottle Filler and Fountain (Single Level)	
Standard(s)	RSS 210 Issue 8:2010 / FCC Part 15 Subpart C 15:2014	

Devices scanned may be scanned at alternate test distances, and in accordance with FCC Part 15, Subpart A, Section 15.31, an extrapolation factor of 20 dB/decade was used above 30 MHz and 40 dB/decade below 30 MHz. For example for 1 meter measurements, an extrapolation factor 9.5 dB from 20 Log (1m/3m) is applied.

See final measurement section for all measurements.

The EUT was scanned with both the 15.247 and 15.209 transmitters on and transmitting continuous modulated data at maximum power

Plots and measurements are made at a 3 meter distance.

Client	Elkay Manufacturing Co.	
Product	EZ Bottle Filler and Fountain (Single Level)	
Standard(s)	RSS 210 Issue 8:2010 / FCC Part 15 Subpart C 15:2014	

Peak Emissions Graph
9 kHz to 150 kHz
3 meter test distance

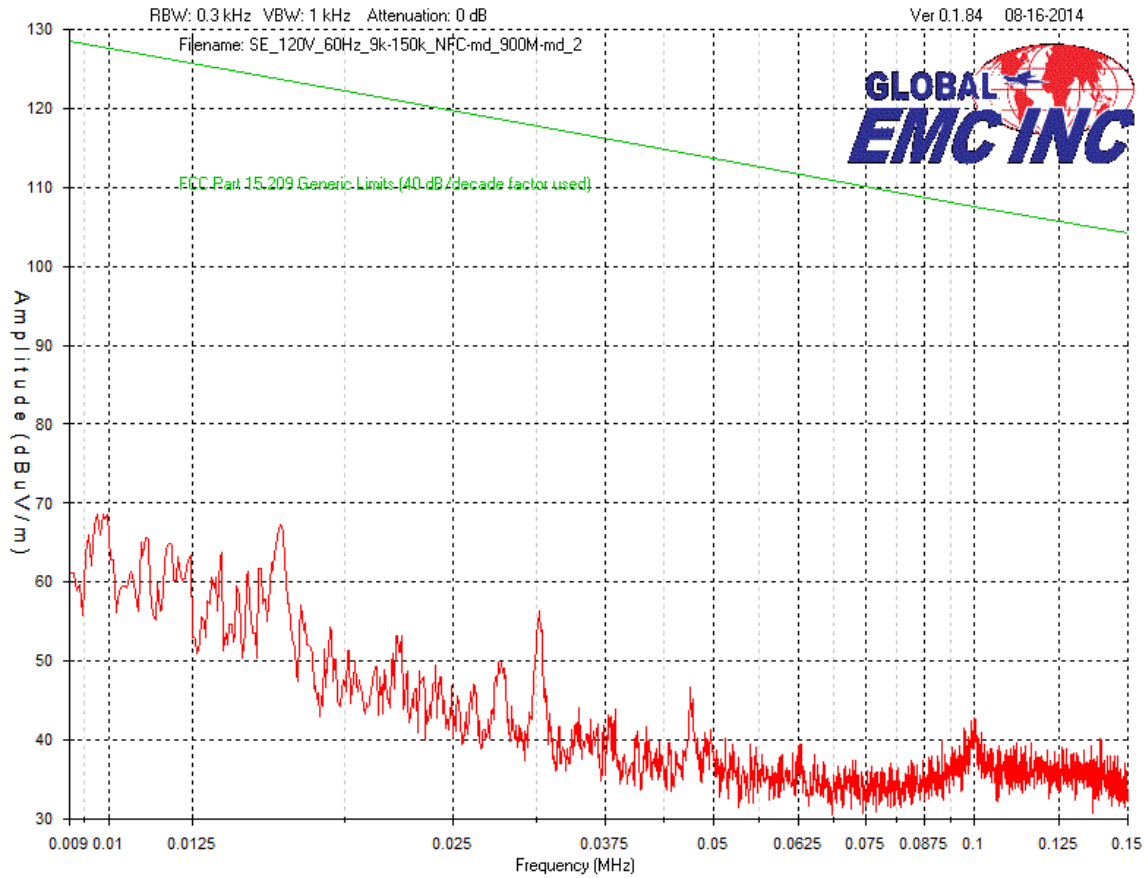

Client	Elkay Manufacturing Co.	
Product	EZ Bottle Filler and Fountain (Single Level)	
Standard(s)	RSS 210 Issue 8:2010 / FCC Part 15 Subpart C 15:2014	

Peak Emissions Graph
150 kHz to 30 MHz
3 meter test distance

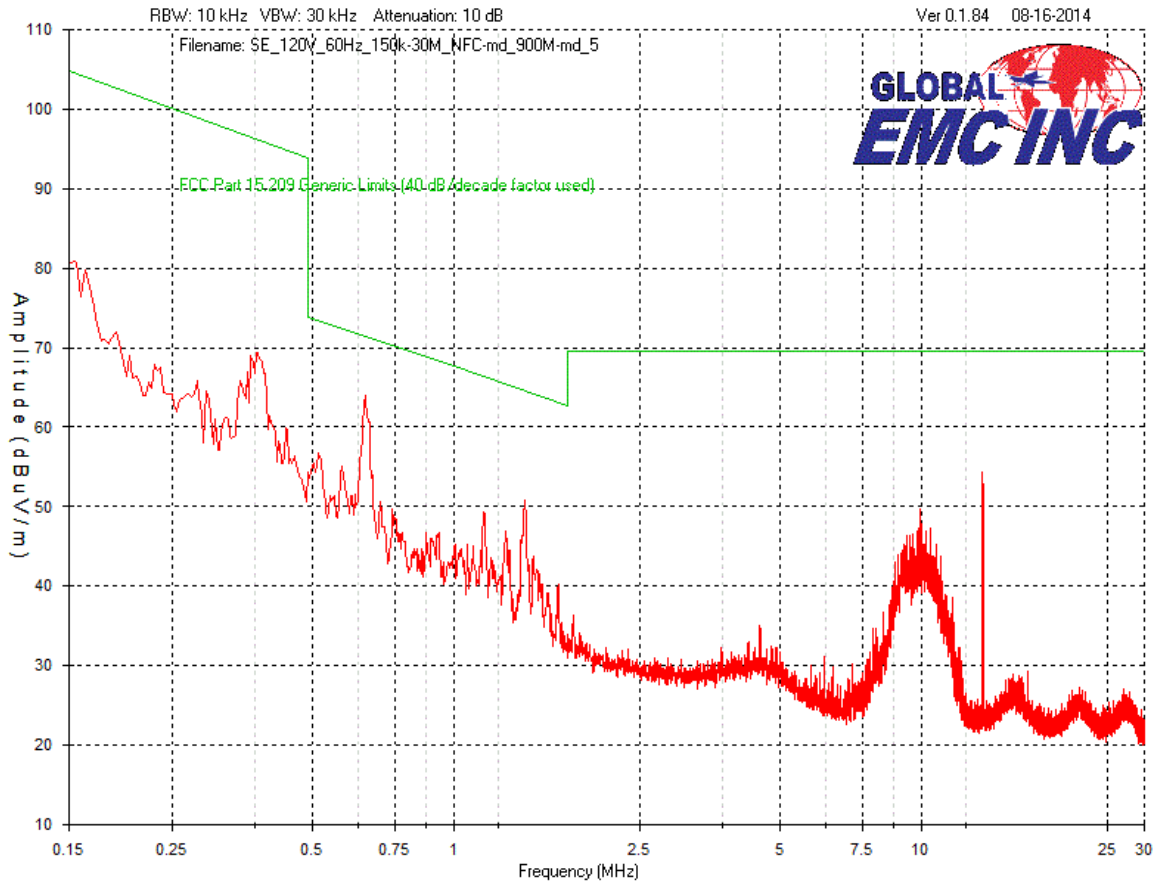

Client	Elkay Manufacturing Co.	
Product	EZ Bottle Filler and Fountain (Single Level)	
Standard(s)	RSS 210 Issue 8:2010 / FCC Part 15 Subpart C 15:2014	

Peak Emissions Graph
Vertical Antenna Polarity
30 MHz to 1 GHz
3 meter test distance

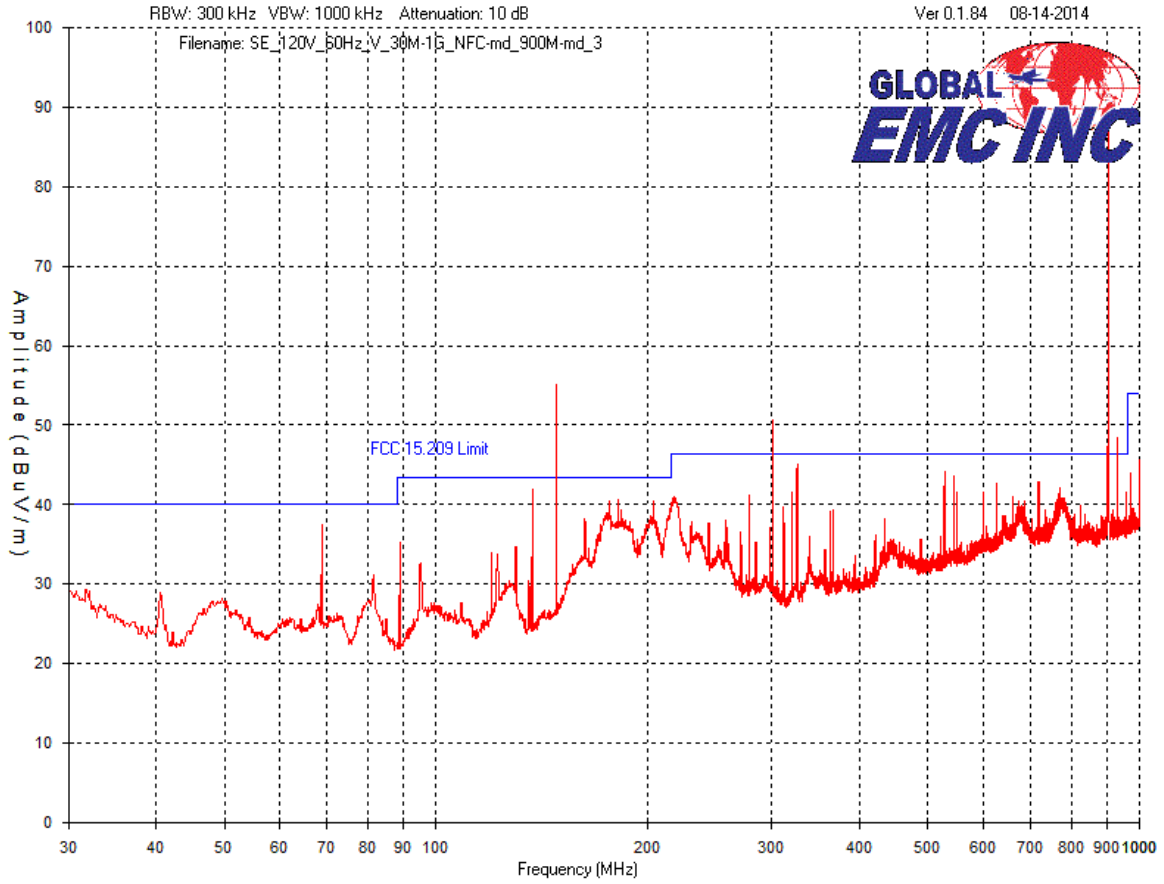

Client	Elkay Manufacturing Co.	
Product	EZ Bottle Filler and Fountain (Single Level)	
Standard(s)	RSS 210 Issue 8:2010 / FCC Part 15 Subpart C 15:2014	

Peak Emissions Graph
Horizontal Antenna Polarity
30 MHz to 1 GHz
3 meter test distance

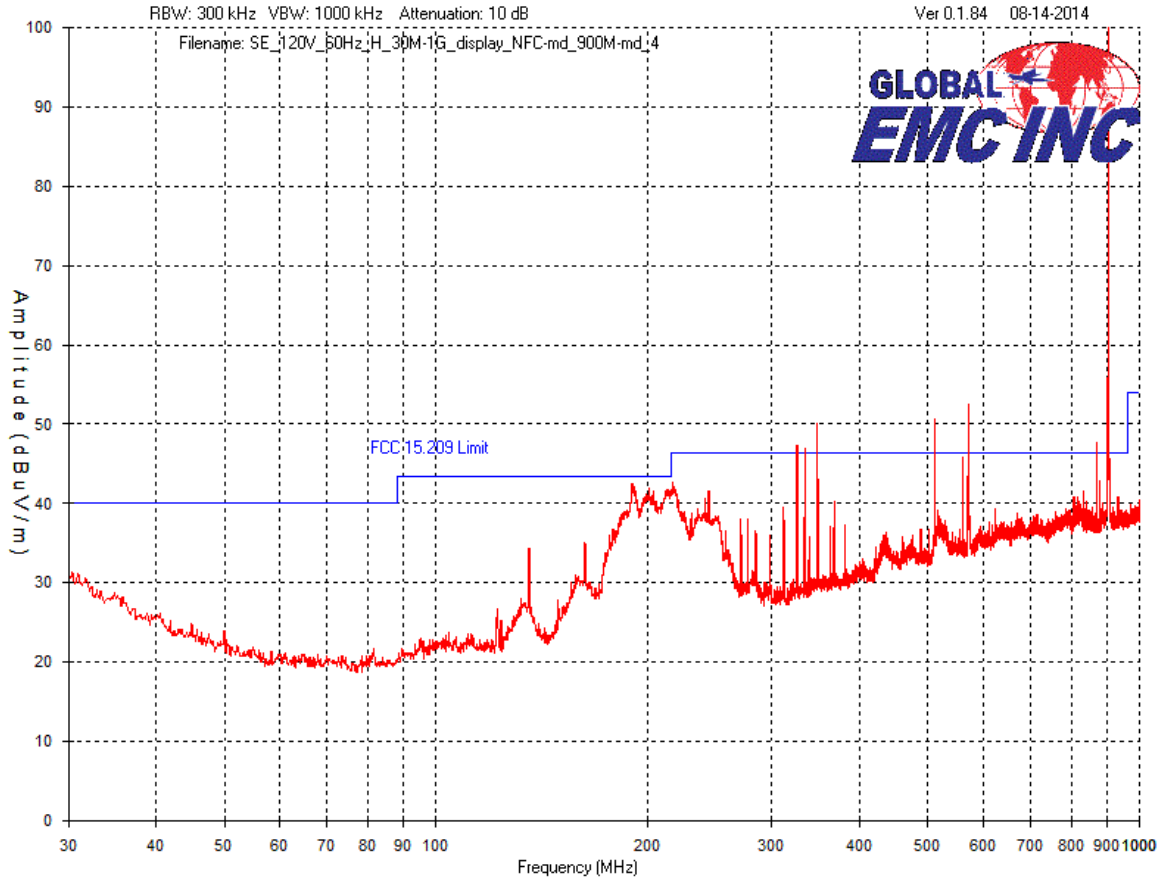

Client	Elkay Manufacturing Co.	
Product	EZ Bottle Filler and Fountain (Single Level)	
Standard(s)	RSS 210 Issue 8:2010 / FCC Part 15 Subpart C 15:2014	

Final Measurements

Radiated Emissions
Spurious measurements
3m test distance

Test Frequency (MHz)	Detection mode	Raw signal dB(μV)	Antenna factor (dB)	Attenuator factor (dB)	Cable loss dB + Pre-selector	Pre-Amp Gain dB	Received signal dB(μV/m)	Emission limit dB(μV/m)	Margin dB(μV)	Result
Vertical Antenna Polarity										
148.4	QP	43.9	9	6	0.9	-30.1	29.7	43.5	13.8	Pass
300.9	QP	44.9	13.8	6	1.3	-30.2	35.8	46.4	10.6	Pass
930.3	QP	35.1	22.5	6	2.3	-29.9	36	46.4	10.4	Pass
326.1	QP	36.2	14.2	6	1.4	-30.3	27.5	46.4	18.9	Pass
136.9	Peak	57.5	7.6	6	0.9	-30	42	43.5	1.5	Pass
528.7	Peak	48.2	18.1	6	1.8	-29.9	44.2	46.4	2.2	Pass
Horizontal Antenna Polarity										
570.0	QP	34.1	19.4	6	1.8	-29.9	31.4	46.4	15	Pass
511.4	QP	30.4	18.5	6	1.7	-29.9	26.7	46.4	19.7	Pass
348.5	QP	28.4	15.4	6	1.4	-30.3	20.9	46.4	25.5	Pass
869.8	QP	31.4	22.9	6	2.2	-29.9	32.6	46.4	13.8	Pass
325.9	QP	44.9	14.6	6	1.4	-30.2	36.7	46.4	9.7	Pass
333.9	QP	29.2	14.8	6	1.4	-30.3	21.1	46.4	25.3	Pass
217.3	QP	47.8	11.1	6	1.1	-30.2	35.8	46.4	10.6	Pass

Client	Elkay Manufacturing Co.	
Product	EZ Bottle Filler and Fountain (Single Level)	
Standard(s)	RSS 210 Issue 8:2010 / FCC Part 15 Subpart C 15:2014	

Test Equipment List

Equipment	Model No.	Manufacturer	Last calibration date	Next calibration due date	Asset #
Spectrum Analyzer	85650A	HP	Jan. 23, 2013	Jan. 23, 2015	GEMC 170
Quasi-Peak Detector	8566B	HP	Jan. 22, 2013	Jan. 22, 2015	GEMC 169
Loop Antenna 30Hz – 1MHz	EM 6871	Electro-Metrics	Feb. 5, 2013	Feb. 5, 2015	GEMC 70
Loop Antenna 100kHz – 30MHz	EM 6872	Electro-Metrics	Feb. 5, 2013	Feb. 5, 2015	GEMC 71
BiLog Antenna	3142-C	ETS	Feb 4, 2013	Feb 4, 2015	GEMC 137
Chase Preamp 9kHz - 2 GHz	CPA9231A	Chase	Sept. 9, 2014	Sept. 9, 2016	GEMC 6403
RF Cable 7m	LMR-400-7M-50OHM-MN-MN	LexTec	NCR	NCR	GEMC 28
RF Cable 1m	LMR-400-1M-50OHM-MN-MN	LexTec	NCR	NCR	GEMC 29
RF Cable 0.5M	LMR-400-0.5M-50OHM-MN-MN	LexTec	NCR	NCR	GEMC 31

This report module is based on GEMC template "FCC - 15.209 - Radiated Emissions_Rev1.doc"

Client	Elkay Manufacturing Co.	
Product	EZ Bottle Filler and Fountain (Single Level)	
Standard(s)	RSS 210 Issue 8:2010 / FCC Part 15 Subpart C 15:2014	

Radiated Emissions – Fundamental

Purpose

The purpose of these tests is to ensure that the RF energy emitted from the EUT does not exceed the limits listed below as defined in the applicable test standard, as measured from a receiving antenna. This helps protect broadcast radio services such as television, FM radio, pagers, cellular telephones, emergency services, and so on, from unwanted interference. RF energy unintentionally emitted from the EUT, and the intentionally emitted fundamental and its harmonics, have limits as shown below.

Limit(s) and Method

The method is as defined in ANSI C63.4:2003 and as per applicable standards.

For the fundamental and harmonics, the limits are as defined in FCC Part 15, Section 15.209 (at 3m):

Fundamental frequency	Field strength limits	Field strength limit of fundamental
1.705-30.0 MHz ⁴	30 $\mu\text{V/m}$ at 30m	At 13.56 MHz 69.54 dB $\mu\text{V/m}$ at 3m

For other spurious emissions, the limits are as defined in FCC Part 15, Section 15.209:

0.009 MHz – 0.490 MHz, 2400/F(kHz) $\mu\text{V/m}^{3,4}$ at 300m
0.490 MHz – 1.705 MHz, 24000/F(kHz) uV/m^4 at 30 m
30 MHz – 88 MHz, 100 uV/m (40.0 dB uV/m^1) at 3 m
88 MHz – 216 MHz, 150 uV/m (43.5 dB uV/m^1) at 3 m
216 MHz – 960 MHz, 200 uV/m (46.4 dB uV/m^1) at 3 m
Above 960 MHz, 500 uV/m (54.0 dB uV/m^1) at 3 m
Above 1000 MHz, 500 uV/m (54 dB uV/m^2) at 3m

Peak field strengths are limited to be at most 20 dB above the average limits as defined above at the corresponding frequencies.

¹Limit is with 120 kHz measurement bandwidth and a using a Quasi Peak detector.

²Limit is with 1 MHz measurement bandwidth and using an Average detector. A peak limit of 20 dB higher additionally applies.

Client	Elkay Manufacturing Co.	
Product	EZ Bottle Filler and Fountain (Single Level)	
Standard(s)	RSS 210 Issue 8:2010 / FCC Part 15 Subpart C 15:2014	

³In the frequency bands 9 – 90 kHz, and 110 – 490 kHz, limit is defined using an Average detector. A peak limit of 20 dB higher additionally applies. Otherwise it is using a Quasi Peak detector.

⁴In the frequency bands 9 – 150 kHz, and 150 kHz – 30 MHz, limit is defined with a 200 Hz and 9 kHz measurement bandwidths respectively.

To obtain the maximum emission, the loop antenna is positioned with its plane vertical and rotated about its vertical axis at the maximum azimuth position. This is then repeated with its plane horizontal, and rotated about the horizontal axis. The maximum obtained emission is presented.

Typical Radiated Emissions Setup

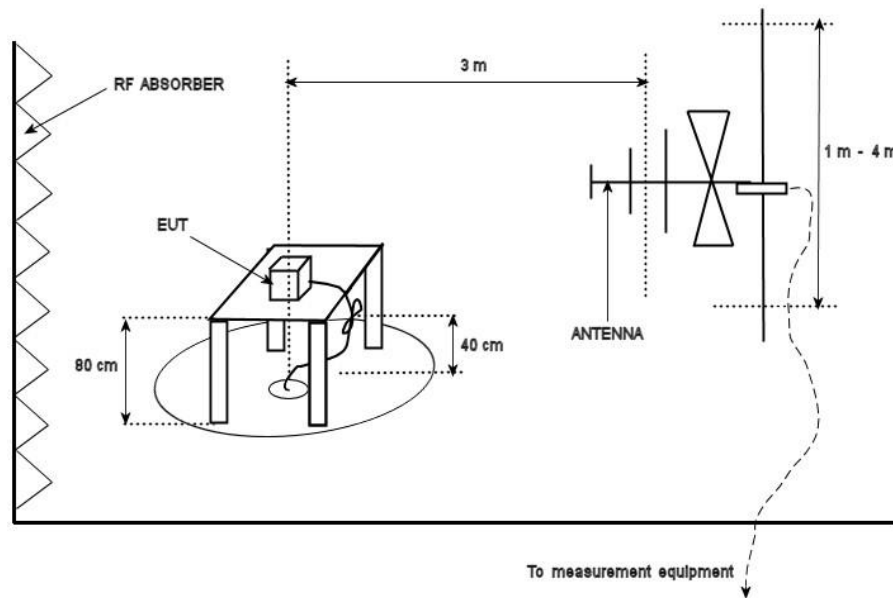

Measurement Uncertainty

The expanded measurement uncertainty is calculated in accordance with CISPR 16-4-2 and is +/-4.4 dB with a 'k=2' coverage factor and a 95% confidence level.

Preliminary Graphs

The graphs shown below are peak scans for graphical illustration only. For final measurements with the appropriate detector, please refer to the final measurement table where applicable. The graph shown below is a maximized peak measurement graph,

Client	Elkay Manufacturing Co.	
Product	EZ Bottle Filler and Fountain (Single Level)	
Standard(s)	RSS 210 Issue 8:2010 / FCC Part 15 Subpart C 15:2014	

measured with a resolution bandwidth greater than or equal to, the final required detector and over a full 0-360° rotation. This peaking process is done as a worst case measurement. This process enables the detection of frequencies of concern for final measurement, and provides considerable time savings.

In accordance with FCC Part 15, Subpart A, Section 15.33, the device was scanned to at least the 10th harmonic.

Peak Emissions Plot
13.56 MHz

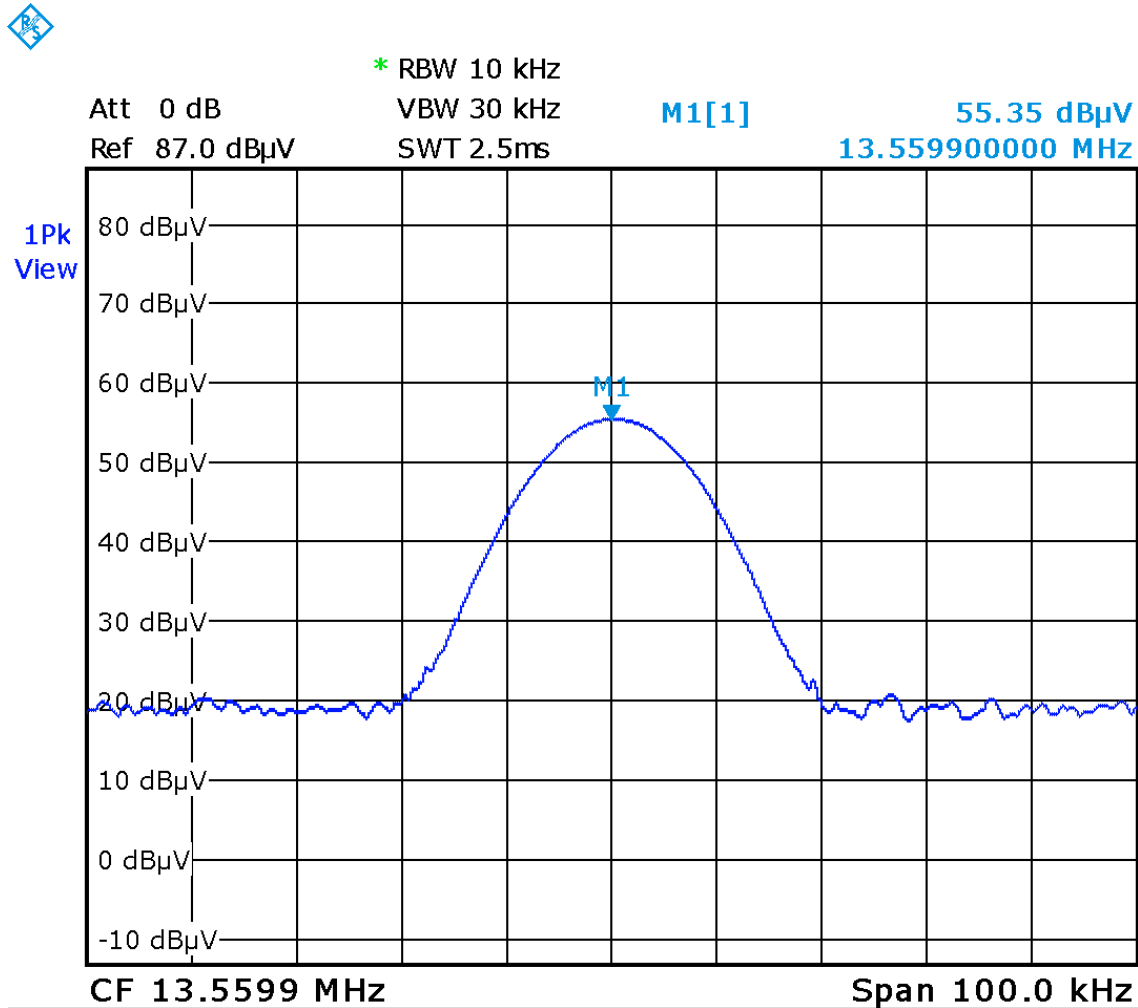

Client	Elkay Manufacturing Co.	
Product	EZ Bottle Filler and Fountain (Single Level)	
Standard(s)	RSS 210 Issue 8:2010 / FCC Part 15 Subpart C 15:2014	

Final Measurements

Radiated Emissions - 15.209 - Table 4

Test Frequency (MHz)	Detection mode	Raw signal dB(μ A)	dBuA to dBuV conversion factor	Antenna factor dB	Cable loss dB + Preselector	Chase Pre-Amp Gain dB	Received signal dB(μ V/m)	Emission limit dB(μ V/m)	Margin dB(μ V)	Result
13.56	Peak	55.4	51.5	-17.2	0.3	30.0	60.0	69.5	9.5	Pass

See *Radiated Emissions – Spurious* section in this report for spurious emissions test results.

Peak emissions meet the general emission limit requirements.

Test Equipment List

Equipment	Model No.	Manufacturer	Last calibration date	Next calibration due date	Asset #
Spectrum Analyzer	ESL6	Rohde & Schwarz	Nov. 15, 2013	Nov. 15, 2015	GMEC 160
Loop Antenna 100kHz – 30MHz	EM 6872	Electro-Metrics	Feb. 5, 2013	Feb. 5, 2015	GEMC 71
Chase Preamp 9kHz - 2 GHz	CPA9231A	Chase	Sept. 9, 2014	Sept. 9, 2016	GEMC 6403
RF Cable 7m	LMR-400-7M-50OHM-MN-MN	LexTec	NCR	NCR	GEMC 28
RF Cable 1m	LMR-400-1M-50OHM-MN-MN	LexTec	NCR	NCR	GEMC 29
RF Cable 0.5M	LMR-400-0.5M-50OHM-MN-MN	LexTec	NCR	NCR	GEMC 31

Client	Elkay Manufacturing Co.	
Product	EZ Bottle Filler and Fountain (Single Level)	
Standard(s)	RSS 210 Issue 8:2010 / FCC Part 15 Subpart C 15:2014	

99% Bandwidth

Purpose

The purpose of this test is to find the 99% occupied bandwidth of the emission. This bandwidth contains 99% of the power of the transmitted spectrum.

Limit(s) and Method

The method is as defined in RSS-Gen.

There are no applicable limits for this test. Its results are for informational purposes only.

Preliminary Graphs

99% Bandwidth for 13.56 MHz Transmission

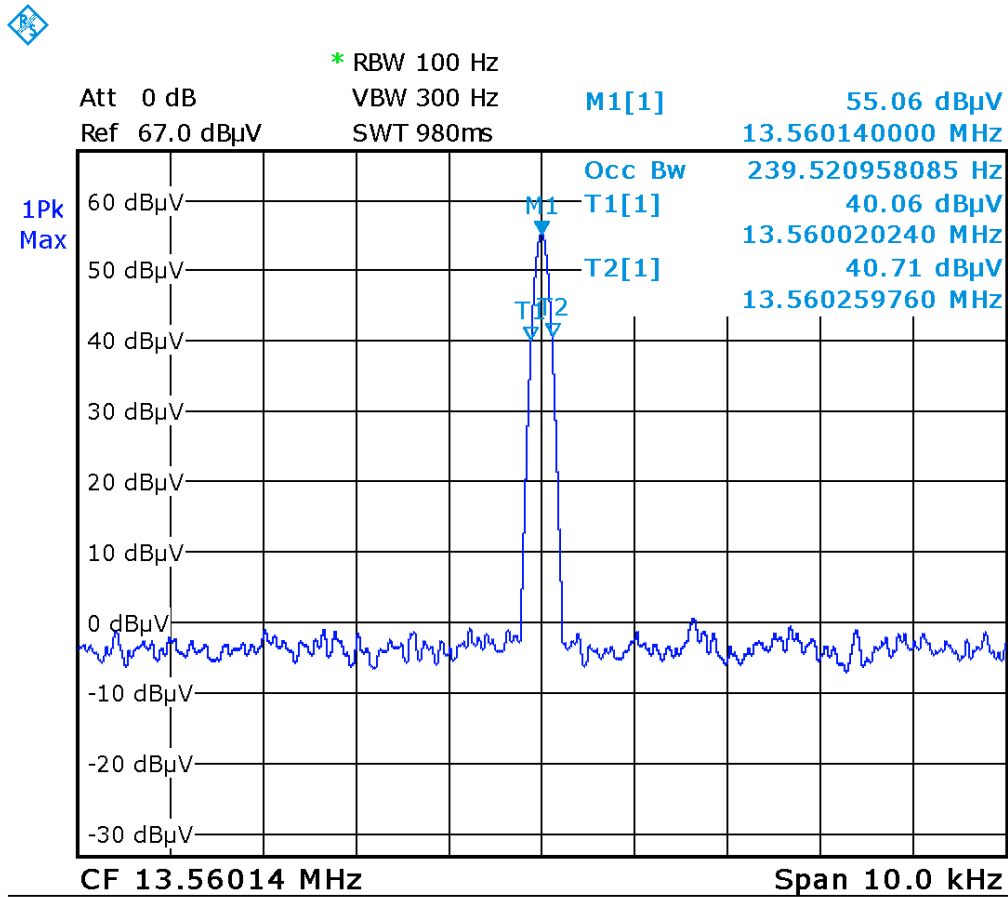

Client	Elkay Manufacturing Co.	
Product	EZ Bottle Filler and Fountain (Single Level)	
Standard(s)	RSS 210 Issue 8:2010 / FCC Part 15 Subpart C 15:2014	

Results

The 99% occupied bandwidth for the 13.56 MHz transmission is 240 Hz.

Test Equipment List

Equipment	Model No.	Manufacturer	Last calibration date	Next calibration due date	Asset #
Spectrum Analyzer	ESL6	Rohde & Schwarz	Nov. 15, 2013	Nov. 15, 2015	GMEC 160
Loop Antenna 100kHz – 30MHz	EM 6872	Electro-Metrics	Feb. 5, 2013	Feb. 5, 2015	GEMC 71
Chase Preamp 9kHz - 2 GHz	CPA9231A	Chase	Sept. 9, 2014	Sept. 9, 2016	GEMC 6403

Client	Elkay Manufacturing Co.	
Product	EZ Bottle Filler and Fountain (Single Level)	
Standard(s)	RSS 210 Issue 8:2010 / FCC Part 15 Subpart C 15:2014	

Appendix A – EUT Summary

For further details for filing purposes, refer to filing package.

General EUT Description

Client Details	
Organization / Address	Elkay Manufacturing Co. 2222 Camden Ct. Oakbrook, Illinois United States of America 60523
Contact	Rene Laude
Phone	708-786-5067
Email	rene.laude@elkay.com
EUT (Equipment Under Test) Details	
EUT Name / Model	LZS8WSLP (Alpha-numeric display, painted metal enclosure) LZS8WSSP (Alpha-numeric display, stainless steel enclosure) LZS8WSLVP (Graphics display, painted metal enclosure) LZS8WSSVP (Graphics display, stainless steel enclosure)
Mains input voltage range(s)	115V, 60Hz
Rated input current	4.2 A
Transmit Frequencies	902.7 – 927.3 MHz 13.56 MHz
Basic EUT functionality description	The EUT is a drinking fountain and bottle filling station with display capabilities. It can wirelessly communicate with a base station at the 900 MHz range, and uses a replaceable filter which will be detected and identified as valid using 13.56 MHz RFID. The part with the wireless capabilities can be coupled with either a video display, or alpha-numeric display, and each of these are available in a stainless steel, or painted metal exterior. The display which is to be coupled with the wireless portion does not have wireless capabilities itself.
Modes of operation	On mode. Unit is typically always on after installation.
Available connectors on EUT	None
Dimensions of product (approx.)	L: 48cm, W: 47cm, H: 100cm (including display)
Separation distance from operator	20cm

Note the EUT is considered to have been received the date of the commencement of the first test, unless otherwise stated. For a close-up picture of the EUT, see ‘Appendix B – EUT & Test Setup Photographs’.