

FCC RADIO TEST REPORT

FCC ID:2AC8IFTSTPC

Product : With Wifi Touch Screen PC

Trade Name :  faytech

Model Name : FT15PC

Serial Model : FT07PC, FT08PC, FT10PC, FT104PC,
FT116PC, FT121PC, FT133PC, FT156PC,
FT17PC, FT185PC, FT19PC, FT215PC,
FT22PC

Prepared for

faytech Tech. Co., Ltd.

Fl. 4, Hongmen Tech Zone, Jihua Road, Longgang District, Shenzhen, China

Prepared by

Shenzhen Asia Test Technology Co.,Ltd.

1/6, Bldg.8, Zhonghua Industrial City, Chuangye Rd., Nanshan District,
Shenzhen, Guangdong, China

Tel: (86)- 0755-23590251 Fax: (86)-0755- 23590255

Http: www.att-lab.net



TEST RESULT CERTIFICATION

Applicant's name faytech Tech. Co., Ltd.
Address Fl. 4, Hongmen Tech Zone, Jihua Road, Longgang District, Shenzhen, China

Manufacture's Name... faytech Tech. Co., Ltd.
Address Fl. 4, Hongmen Tech Zone, Jihua Road, Longgang District, Shenzhen, China

Product description

Product name With Wifi Touch Screen PC
Model and/or type reference FT15PC
Serial Model FT07PC, FT08PC, FT10PC, FT104PC, FT116PC, FT121PC, FT133PC, FT156PC, FT17PC, FT185PC, FT19PC, FT215PC, FT22PC

Standards FCC Part15.247

Test procedure ANSI C63.4-2003

This device described above has been tested by ATT, and the test results show that the equipment under test (EUT) is in compliance with the FCC requirements. And it is applicable only to the tested sample identified in the report.

This report shall not be reproduced except in full, without the written approval of ATT, this document may be altered or revised by ATT, personal only, and shall be noted in the revision of the document.

Date of Test

Date (s) of performance of tests 26 Aug. 2014 ~12 Sep. 2014

Date of Issue..... 12 Sep. 2014

Test Result..... **Pass**

Testing Engineer : *Eric Wang*
(Eric Wang)

Technical Manager : *Jerry You*
(Jerry You)

Authorized Signatory : *Jack Yu*
(Jack Yu)

**Table of Contents**

	Page
1 . SUMMARY OF TEST RESULTS	5
1.1 TEST FACILITY	6
1.2 MEASUREMENT UNCERTAINTY	6
2 . GENERAL INFORMATION	7
2.1 GENERAL DESCRIPTION OF EUT	7
2.2 DESCRIPTION OF TEST MODES	9
2.3 BLOCK DIGRAM SHOWING THE CONFIGURATION OF SYSTEM TESTED	10
2.4 DESCRIPTION OF SUPPORT UNITS(CONDUCTED MODE)	11
2.5 EQUIPMENTS LIST FOR ALL TEST ITEMS	12
3 . EMC EMISSION TEST	13
3.1 CONDUCTED EMISSION MEASUREMENT	13
3.1.1 POWER LINE CONDUCTED EMISSION LIMITS	13
3.1.2 TEST PROCEDURE	14
3.1.3 DEVIATION FROM TEST STANDARD	14
3.1.4 TEST SETUP	14
3.1.5 EUT OPERATING CONDITIONS	14
3.1.6 TEST RESULTS	15
3.2 RADIATED EMISSION MEASUREMENT	17
3.2.1 RADIATED EMISSION LIMITS	17
3.2.2 TEST PROCEDURE	18
3.2.3 DEVIATION FROM TEST STANDARD	18
3.2.4 TEST SETUP	19
3.2.5 EUT OPERATING CONDITIONS	20
3.2.6 TEST RESULTS (BETWEEN 9KHZ – 30 MHZ)	21
3.2.7 TEST RESULTS (BETWEEN 30MHZ – 1GHZ)	22
3.2.8 TEST RESULTS (ABOVE 1000 MHZ)	23
4 . POWER SPECTRAL DENSITY TEST	33
4.1 APPLIED PROCEDURES / LIMIT	33
4.1.1 TEST PROCEDURE	33
4.1.2 DEVIATION FROM STANDARD	33
4.1.3 TEST SETUP	33
4.1.4 EUT OPERATION CONDITIONS	33
4.1.5 TEST RESULTS	34
5 . BANDWIDTH TEST	40
5.1 APPLIED PROCEDURES / LIMIT	40
5.1.1 TEST PROCEDURE	40



Table of Contents

	Page
5.1.2 EUT OPERATION CONDITIONS	40
5.1.3 TEST RESULTS	41
6 . PEAK OUTPUT POWER TEST	47
6.1 APPLIED PROCEDURES / LIMIT	47
6.1.1 TEST PROCEDURE	47
6.1.2 DEVIATION FROM STANDARD	47
6.1.3 TEST SETUP	47
6.1.4 EUT OPERATION CONDITIONS	47
6.1.5 TEST RESULTS	48
7 . 100 KHZ BANDWIDTH OF FREQUENCY BAND EDGE	49
7.1 DEVIATION FROM STANDARD	49
7.2 TEST SETUP	49
7.3 EUT OPERATION CONDITIONS	49
7.4 TEST RESULTS	50
8 . ANTENNA REQUIREMENT	55
8.1 STANDARD REQUIREMENT	55
8.2 EUT ANTENNA	55
9 . EUT TEST PHOTO	56
APPENDIX-PHOTOGRAPHS OF EUT CONSTRUCTIONAL DETAILS	



1. SUMMARY OF TEST RESULTS

Test procedures according to the technical standards:

FCC Part15 (15.247) , Subpart C			
Standard Section	Test Item	Judgment	Remark
15.207	Conducted Emission	PASS	
15.247 (a)(2)	6dB Bandwidth	PASS	
15.247 (b)	Peak Output Power	PASS	
15.247 (c)	Radiated Spurious Emission	PASS	
15.247 (d)	Power Spectral Density	PASS	
15.205	Band Edge Emission	PASS	
15.203	Antenna Requirement	PASS	

NOTE:

(1) "N/A" denotes test is not applicable in this Test Report



1.1 TEST FACILITY

Shenzhen STONE Testing Technology Co.,Ltd.

Add.: F/6, Bldg.12, Zhongxing Industrial City, Chuangye Rd., Nanshan District Shenzhen P.R. China

FCC Registration No.: 323508; IC Registration No.: 11043A

1.2 MEASUREMENT UNCERTAINTY

The reported uncertainty of measurement $y \pm U$, where expanded uncertainty U is based on a standard uncertainty multiplied by a coverage factor of $k=2$, providing a level of confidence of approximately 95 %.

No.	Item	Uncertainty
1	Conducted Emission Test	$\pm 1.38\text{dB}$
2	RF power,conducted	$\pm 0.16\text{dB}$
3	Spurious emissions,conducted	$\pm 0.21\text{dB}$
4	All emissions,radiated(<1G)	$\pm 4.68\text{dB}$
5	All emissions,radiated(>1G)	$\pm 4.89\text{dB}$
6	Temperature	$\pm 0.5^{\circ}\text{C}$
7	Humidity	$\pm 2\%$



2. GENERAL INFORMATION

2.1 GENERAL DESCRIPTION OF EUT

Equipment	With Wifi Touch Screen PC	
Model Name	FT15PC	
Serial Model	FT07PC, FT08PC, FT10PC, FT104PC, FT116PC, FT121PC, FT133PC, FT156PC, FT17PC, FT185PC, FT19PC, FT215PC, FT22PC	
Model Difference	All the models are the same circuit and RF module, except model name.	
Product Description	The EUT is a With Wifi Touch Screen PC	
	Operation Frequency:	802.11b/g/n(20MHz): 2412~2462MHz
	Modulation Type:	CCK/OFDM/DBPSK/DAPSK
	Bit Rate of Transmitter	802.11b:11/5.5/2/1 Mbps 802.11g:54/48/36/24/18/12/9/6Mbps 802.11n(20MHz): 78/52/6.5Mbps
	Number Of Channel	802.11b/g/n20MHz:11CH
	Antenna Designation:	Please see Note 3.
	Output Power(Conducted):	802.11b: 12.97 dBm (Max.AV) 802.11g: 11.86 dBm (Max.AV) 802.11n(20M): 10.85 dBm (Max.AV)
	Based on the application, features, or specification exhibited in User's Manual, the EUT is considered as an ITE/Computing Device. More details of EUT technical specification, please refer to the User's Manual.	
Channel List	Please refer to the Note 2.	
Ratings	Adapter: M/N:FJ-SW1203000 Input:100-240V~, 50/60H, 1.5A Max. Output:12V---, 3000mA	
Battery	N/A	

Note:

1. For a more detailed features description, please refer to the manufacturer's specifications or the User's Manual.

2.

Channel List for 802.11b/g/n(20 MHz)							
Channel	Frequency (MHz)	Channel	Frequency (MHz)	Channel	Frequency (MHz)	Channel	Frequency (MHz)
01	2412	04	2427	07	2442	10	2457
02	2417	05	2432	08	2447	11	2462
03	2422	06	2437	09	2452		



3.

Table for Filed Antenna

Ant	Brand	Model Name	Antenna Type	Connector	Gain (dBi)	NOTE
A	N/A	N/A	PIFA	N/A	2.1	Wifi Antenna



2.2 DESCRIPTION OF TEST MODES

To investigate the maximum EMI emission characteristics generates from EUT, the test system was pre-scanning tested base on the consideration of following EUT operation mode or test configuration mode which possible have effect on EMI emission level. Each of these EUT operation mode(s) or test configuration mode(s) mentioned above was evaluated respectively.

Pretest Mode	Description
Mode 1	802.11b CH1/ CH6/ CH11
Mode 2	802.11g CH1/ CH6/ CH11
Mode 3	802.11n/20MHz CH1/ CH6/ CH11
Mode 4	Link Mode

For Conducted Emission	
Final Test Mode	Description
Mode 4	Link Mode

For Radiated Emission	
Final Test Mode	Description
Mode 1	802.11b CH1/ CH6/ CH11
Mode 2	802.11g CH1/ CH6/ CH11
Mode 3	802.11n/20MHz CH1/ CH6/ CH11

Note:

- (1) The measurements are performed at the highest, middle, lowest available channels.
- (2) The measurements are performed at all Bit Rate of Transmitter, the worst data was reported

2.3 BLOCK DIGRAM SHOWING THE CONFIGURATION OF SYSTEM TESTED

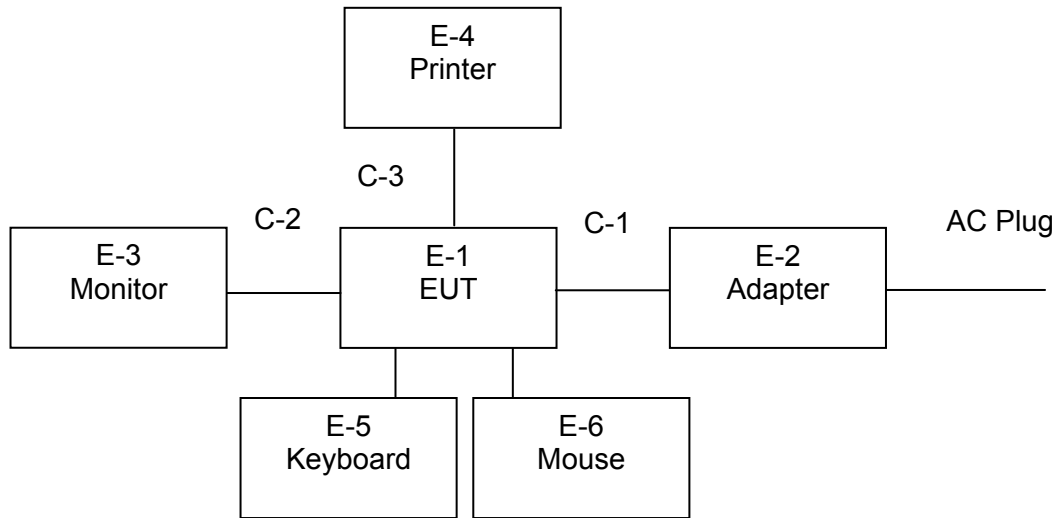



2.4 DESCRIPTION OF SUPPORT UNITS(CONDUCTED MODE)

The EUT has been tested as an independent unit together with other necessary accessories or support units. The following support units or accessories were used to form a representative test configuration during the tests.

Item	Equipment	Brand	Model/Type No.	Series No.	Note
E-1	With Wifi Touch Screen PC		FT15PC	N/A	EUT
E-2	Adapter	N/A	FJ-SW1203000	N/A	
E-3	Monitor	DELL	IN2020MB	cn-0y6mhx-74261-11f-67es	
E-4	Printer	Canon	L11121E	LBP2900	
E-5	Keyboard	DELL	SK-8185	OY526KUS	
E-6	Mouse	DELL	MS111-P	cn-011d3v-71581-11e-1th7	

Item	Shielded Type	Ferrite Core	Length	Note
C-1	NO	YES	120cm	
C-2	YES	YES	120cm	
C-3	NO	NO	100cm	

Note:

- (1) The support equipment was authorized by Declaration of Confirmation.
- (2) For detachable type I/O cable should be specified the length in cm in 『Length』 column.



2.5 EQUIPMENTS LIST FOR ALL TEST ITEMS

Radiation Test equipment

Item	Kind of Equipment	Manufacturer	Type No.	Serial No.	Last calibration	Calibrated until	Calibration period
1	Spectrum Analyzer	Agilent	E4407B	MY45108040	2014.07.06	2015.07.05	1 year
2	Test Receiver	R&S	ESPI	101318	2014.06.07	2015.06.06	1 year
3	Bilog Antenna	TESEQ	CBL6111D	31216	2014.07.06	2015.07.05	1 year
4	50Ω Coaxial Switch	Anritsu	MP59B	6200264416	2014.06.07	2015.06.06	1 year
5	Spectrum Analyzer	ADVANTEST	R3132	150900201	2014.06.07	2015.06.06	1 year
6	Horn Antenna	EM	EM-AH-10180	2011071402	2014.07.06	2015.07.05	1 year
7	Horn Ant	Schwarzbeck	BBHA 9170	9170-181	2014.07.06	2015.07.05	1 year
8	Amplifier	EM	EM-30180	060538	2013.12.22	2014.12.21	1 year
9	Loop Antenna	ARA	PLA-1030/B	1029	2014.06.08	2015.06.07	1 year
10	Power Meter	R&S	NRVS	100696	2014.07.06	2015.07.05	1 year
11	Power Sensor	R&S	URV5-Z4	0395.1619.05	2014.07.06	2015.07.05	1 year

Conduction Test equipment

Item	Kind of Equipment	Manufacturer	Type No.	Serial No.	Last calibration	Calibrated until	Calibration period
1	Test Receiver	R&S	ESCI	101160	2014.06.06	2015.06.05	1 year
2	LISN	R&S	ENV216	101313	2014.08.24	2015.08.23	1 year
3	LISN	EMCO	3816/2	00042990	2014.08.24	2015.08.23	1 year
4	50Ω Coaxial Switch	Anritsu	MP59B	6200264417	2014.06.07	2015.06.06	1 year
5	Passive Voltage Probe	R&S	ESH2-Z3	100196	2014.06.07	2015.06.06	1 year
6	Absorbing clamp	R&S	MOS-21	100423	2014.06.08	2015.06.07	1 year



3. EMC EMISSION TEST

3.1 CONDUCTED EMISSION MEASUREMENT

3.1.1 POWER LINE CONDUCTED EMISSION Limits (Frequency Range 150KHz-30MHz)

FREQUENCY (MHz)	Class A (dBuV)		Class B (dBuV)		Standard
	Quasi-peak	Average	Quasi-peak	Average	
0.15 -0.5	79.00	66.00	66 - 56 *	56 - 46 *	CISPR
0.50 -5.0	73.00	60.00	56.00	46.00	CISPR
5.0 -30.0	73.00	60.00	60.00	50.00	CISPR

0.15 -0.5	79.00	66.00	66 - 56 *	56 - 46 *	FCC
0.50 -5.0	73.00	60.00	56.00	46.00	FCC
5.0 -30.0	73.00	60.00	60.00	50.00	FCC

Note:

- (1) The tighter limit applies at the band edges.
- (2) The limit of " * " marked band means the limitation decreases linearly with the logarithm of the frequency in the range.

The following table is the setting of the receiver

Receiver Parameters	Setting
Attenuation	10 dB
Start Frequency	0.15 MHz
Stop Frequency	30 MHz
IF Bandwidth	9 kHz

3.1.2 TEST PROCEDURE

- The EUT was placed 0.8 meters from the horizontal ground plane with EUT being connected to the power mains through a line impedance stabilization network (LISN). All other support equipments powered from additional LISN(s). The LISN provide 50 Ohm/ 50uH of coupling impedance for the measuring instrument.
- Interconnecting cables that hang closer than 40 cm to the ground plane shall be folded back and forth in the center forming a bundle 30 to 40 cm long.
- I/O cables that are not connected to a peripheral shall be bundled in the center. The end of the cable may be terminated, if required, using the correct terminating impedance. The overall length shall not exceed 1 m.
- LISN at least 80 cm from nearest part of EUT chassis.
- For the actual test configuration, please refer to the related Item –EUT Test Photos.

3.1.3 DEVIATION FROM TEST STANDARD

No deviation

3.1.4 TEST SETUP

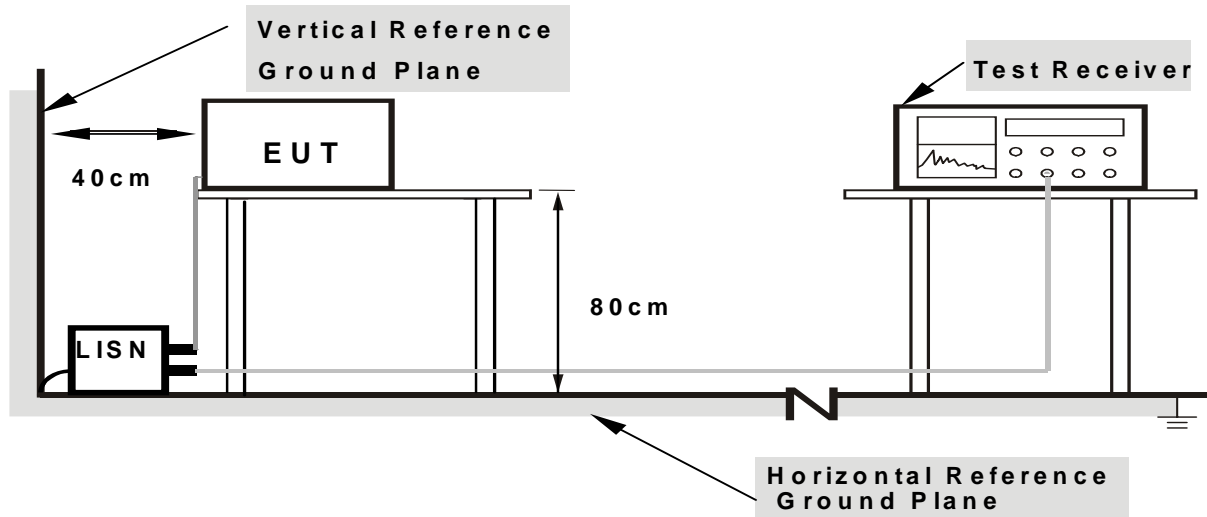

Note: 1. Support units were connected to second LISN.

2. Both of LISNs (AMN) are 80 cm from EUT and at least 80 from other units and other metal planes

3.1.5 EUT OPERATING CONDITIONS

The EUT was configured for testing in a typical fashion (as a customer would normally use it). The EUT has been programmed to continuously transmit during test. This operating condition was tested and used to collect the included data.



3.1.6 TEST RESULTS

EUT :	With Wifi Touch Screen PC	Model Name. :	FT15PC
Temperature :	26 °C	Relative Humidity :	56%
Pressure :	1010hPa	Phase :	L
Test Voltage :	AC 120V/60Hz	Test Mode :	Mode 4

Freq. (MHz)	Reading (dBuV)	Factor (dBuV)	Measurement (dBuV)	Limit (dBuV)	Over (dB)	Detector
0.574	26.95	10.4	37.35	46	-8.65	AVG
0.5899	40.73	10.4	51.13	56	-4.87	QP
3.45	39.2	10.6	49.8	56	-6.2	QP
3.45	22.84	10.6	33.44	46	-12.56	AVG
24.27	37.03	10.73	47.76	60	-12.24	QP

Remark:

1. All readings are Quasi-Peak and Average values.
2. Factor = Insertion Loss + Cable Loss.
3. N/A means All Data have pass Limit

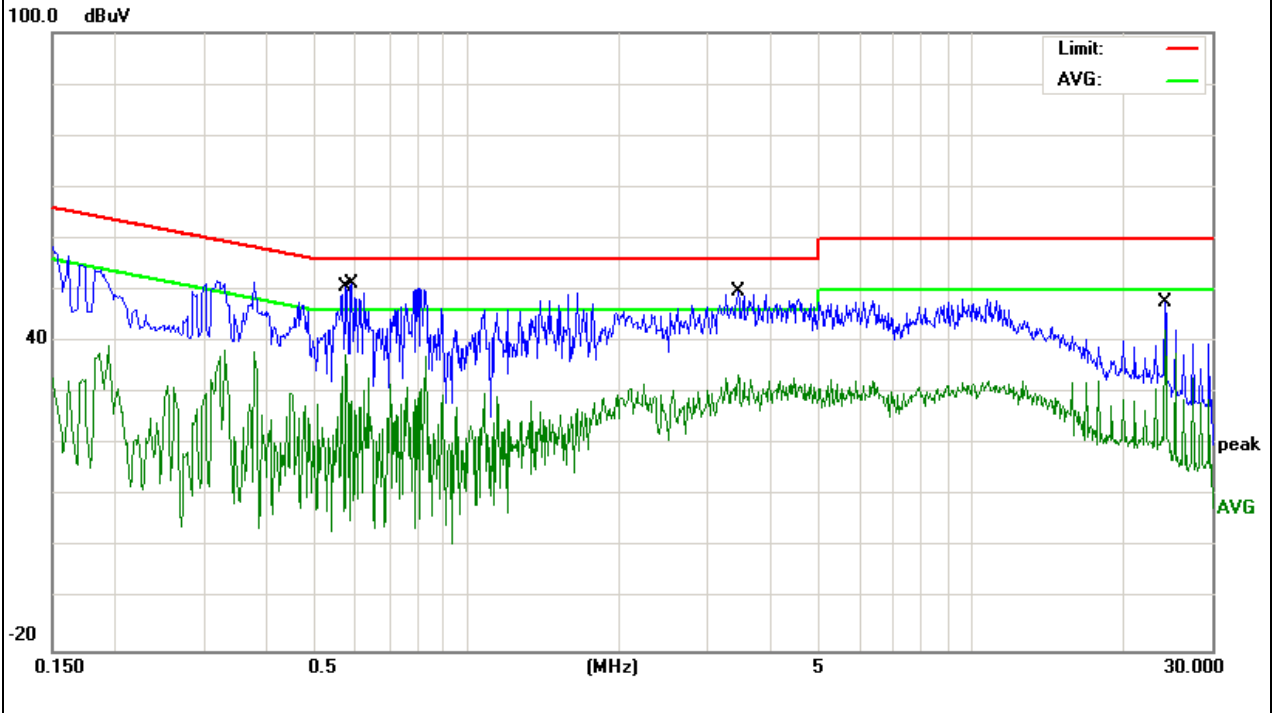



EUT :	With Wifi Touch Screen PC	Model Name. :	FT15PC
Temperature :	26 °C	Relative Humidity :	56%
Pressure :	1010hPa	Phase :	N
Test Voltage :	AC 120V/60Hz	Test Mode :	Mode 4

Freq. (MHz)	Reading (dBuV)	Factor (dBuV)	Measurement (dBuV)	Limit (dBuV)	Over (dB)	Detector
0.1539	48.65	11.17	59.82	65.78	-5.96	QP
0.1996	34.16	10.44	44.6	53.62	-9.02	AVG
1.526	40.13	10.41	50.54	56	-5.46	QP
1.87	20.16	10.42	30.58	46	-15.42	AVG
5.76	24.25	10.66	34.91	50	-15.09	AVG

Remark:

1. All readings are Quasi-Peak and Average values.
2. Factor = Insertion Loss + Cable Loss.
3. N/A means All Data have pass Limit

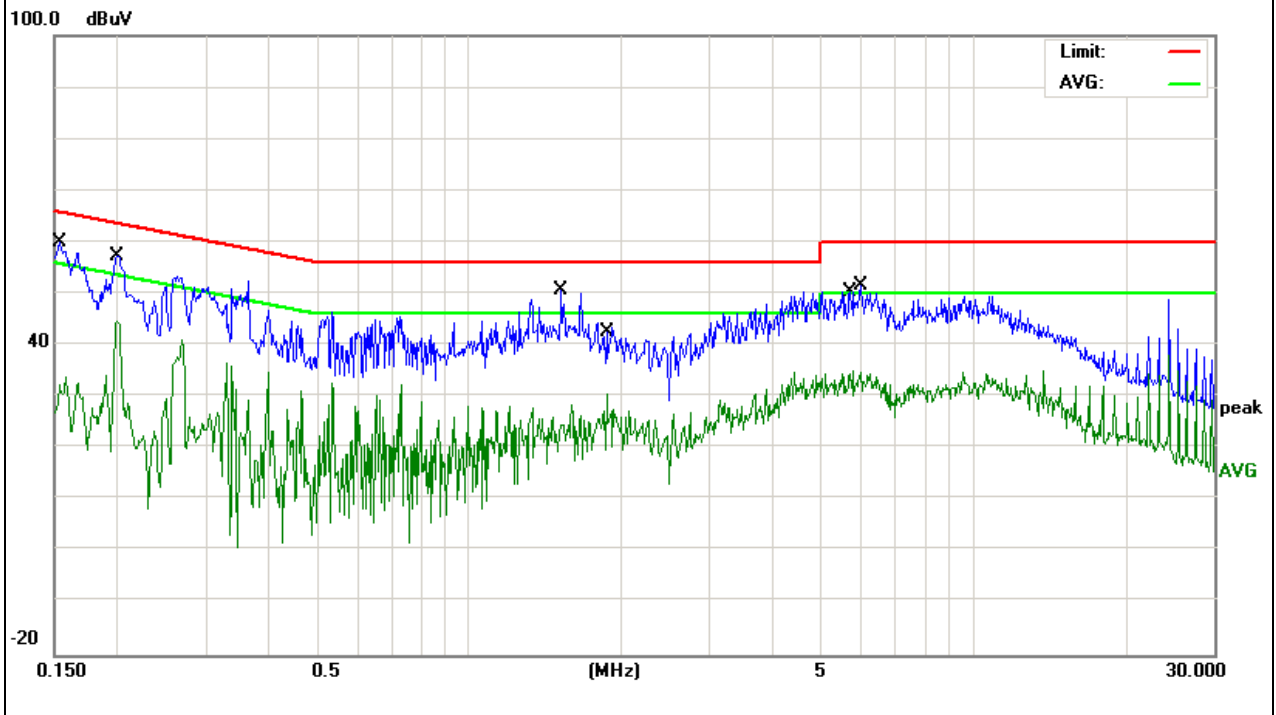



3.2 RADIATED EMISSION MEASUREMENT

3.2.1 RADIATED EMISSION LIMITS (Frequency Range 9kHz-1000MHz)

20dBc in any 100 kHz bandwidth outside the operating frequency band. In case the emission fall within the restricted band specified on 15.205(a), then the 15.209(a) limit in the table below has to be followed.

Frequencies (MHz)	Field Strength (microrvolts/meter)	Measurement Distance (meters)
0.009~0.490	2400/F(KHz)	300
0.490~1.705	24000/F(KHz)	30
1.705~30.0	30	30
30~88	100	3
88~216	150	3
216~960	200	3
Above 960	500	3

LIMITS OF RADIATED EMISSION MEASUREMENT (Above 1000MHz)

FREQUENCY (MHz)	Class A (dBuV/m) (at 3M)		Class B (dBuV/m) (at 3M)	
	PEAK	AVERAGE	PEAK	AVERAGE
Above 1000	80	60	74	54

Notes:

- (1) The limit for radiated test was performed according to FCC PART 15C.
- (2) The tighter limit applies at the band edges.
- (3) Emission level (dBuV/m)=20log Emission level (uV/m).

Spectrum Parameter	Setting
Attenuation	Auto
Start Frequency	1000 MHz
Stop Frequency	10th carrier harmonic
RB / VB (emission in restricted band)	1 MHz / 1 MHz for Peak, 1 MHz / 10Hz for Average

Receiver Parameter	Setting
Attenuation	Auto
Start ~ Stop Frequency	9kHz~150kHz / RB 200Hz for QP
Start ~ Stop Frequency	150kHz~30MHz / RB 9kHz for QP
Start ~ Stop Frequency	30MHz~1000MHz / RB 120kHz for QP



3.2.2 TEST PROCEDURE

- a. The measuring distance of at 3 m shall be used for measurements at frequency up to 1GHz. For frequencies above 1GHz, any suitable measuring distance may be used.
- b. The EUT was placed on the top of a rotating table 0.8 meters above the ground at a 3 meter open area test site. The table was rotated 360 degrees to determine the position of the highest radiation.
- c. The height of the equipment or of the substitution antenna shall be 0.8 m; the height of the test antenna shall vary between 1 m to 4 m. Both horizontal and vertical polarizations of the antenna are set to make the measurement.
- d. The initial step in collecting conducted emission data is a spectrum analyzer peak detector mode pre-scanning the measurement frequency range. Significant peaks are then marked and then Quasi Peak detector mode re-measured.
- e. If the Peak Mode measured value compliance with and lower than Quasi Peak Mode Limit, the EUT shall be deemed to meet QP Limits and then no additional QP Mode measurement performed.
- f. For the actual test configuration, please refer to the related Item –EUT Test Photos.

Note:

Both horizontal and vertical antenna polarities were tested and performed pretest to three orthogonal axis. The worst case emissions were reported

3.2.3 DEVIATION FROM TEST STANDARD

No deviation

3.2.4 TEST SETUP

(A) Radiated Emission Test-Up Frequency Below 30MHz

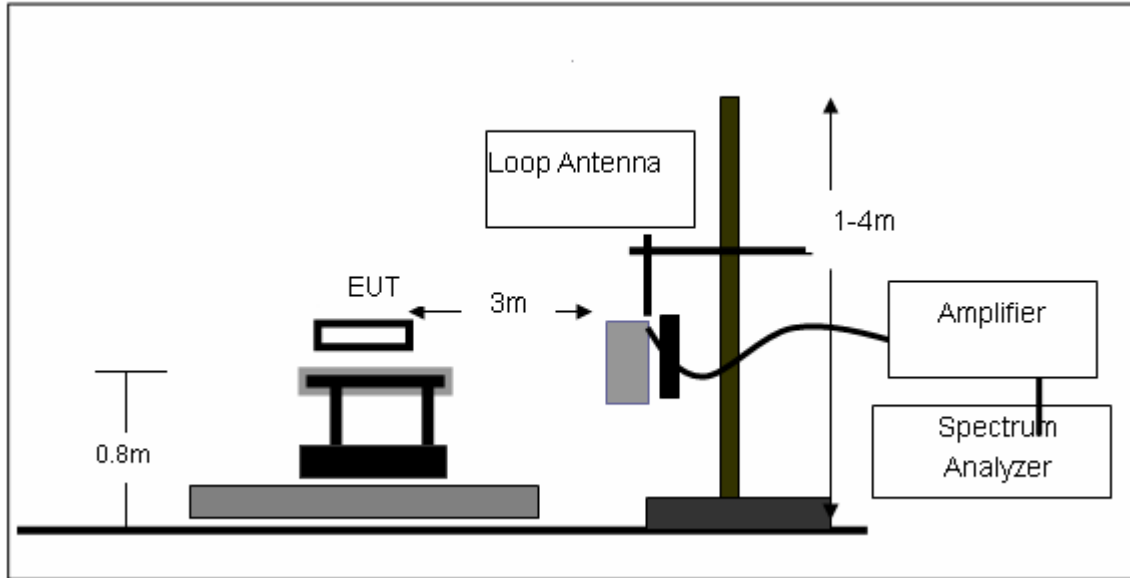

(B) Radiated Emission Test-Up Frequency 30MHz~1GHz

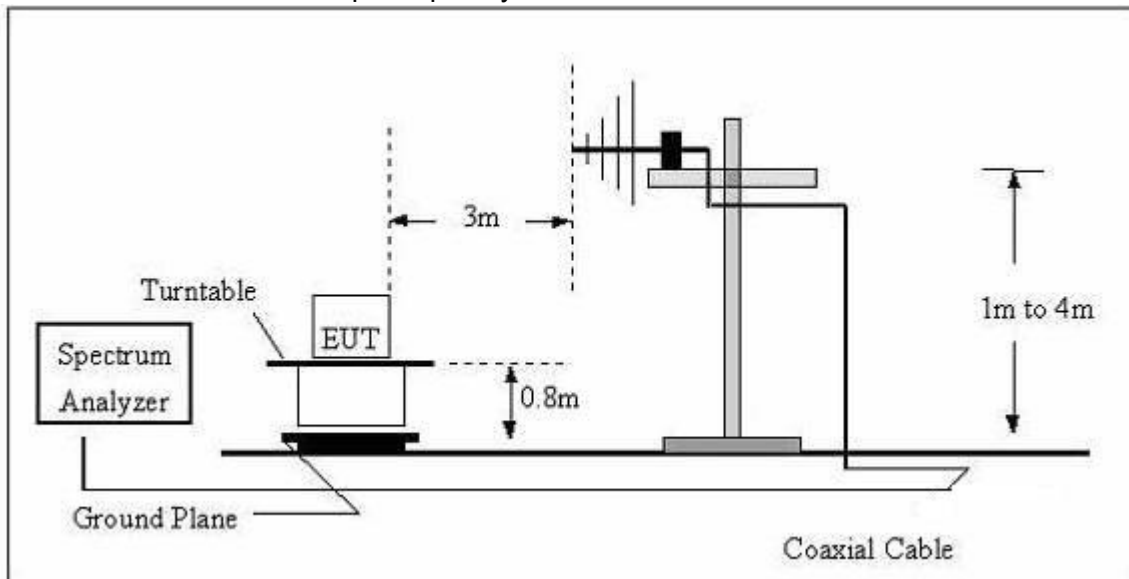

(C) Radiated Emission Test-Up Frequency Above 1GHz

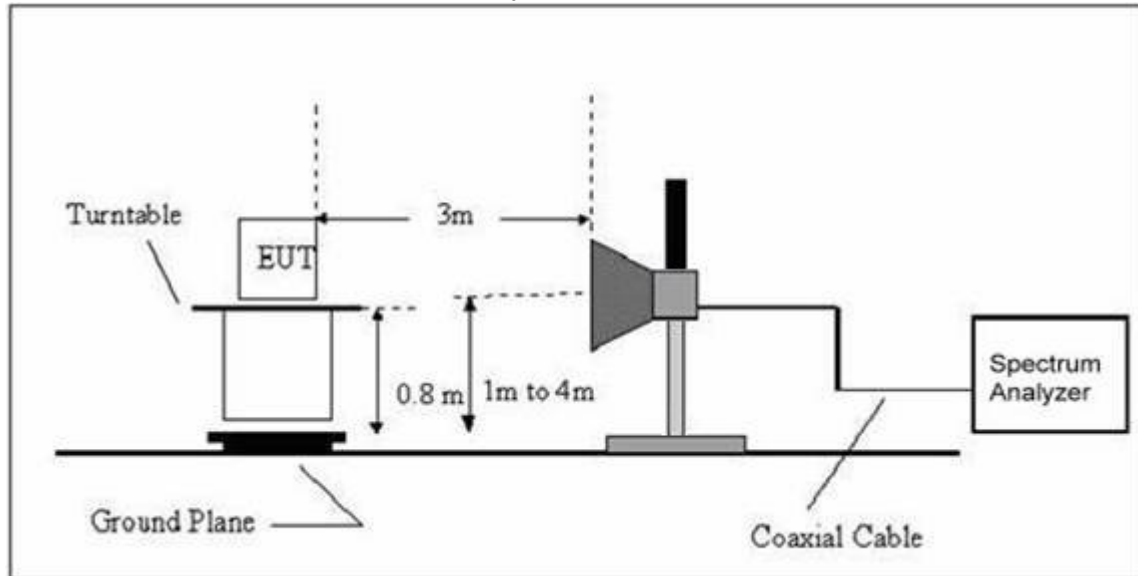
**3.2.5 EUT OPERATING CONDITIONS**

The EUT tested system was configured as the statements of 2.4 Unless otherwise a special operating condition is specified in the follows during the testing.

**3.2.6 TEST RESULTS (BETWEEN 9KHZ – 30 MHZ)**

EUT:	With Wifi Touch Screen PC	Model Name. :	FT15PC
Temperature:	20 °C	Relative Humidity:	48%
Pressure:	1010 hPa	Test Voltage :	AC 120V/60Hz
Test Mode :	TX	Polarization :	--

Freq. (MHz)	Reading (dBuV/m)	Limit (dBuV/m)	Margin (dB)	State P/F
--	--	--	--	N/A
--	--	--	--	N/A

NOTE:

The amplitude of spurious emissions which are attenuated by more than 20dB below the permissible value has no need to be reported.

Distance extrapolation factor = $40 \log (\text{specific distance}/\text{test distance})$ (dB);

Limit line = specific limits(dBuv) + distance extrapolation factor.

**3.2.7 TEST RESULTS (BETWEEN 30MHZ – 1GHZ)**

EUT :	With Wifi Touch Screen PC	Model Name :	FT15PC
Temperature :	20 °C	Relative Humidity :	48%
Pressure:	1010 hPa	Test Voltage :	AC 120V/60Hz
Test Mode :	TX		

Frequency (MHz)	Meter Reading (dB μ V)	Factor (dB)	Emission Level (dB μ V/m)	Limits (dB μ V/m)	Margin (dB)	Detect or Type	Polarization
Below 1G							
31.5093	18.26	17.6	35.86	40	-4.14	QP	H
47.4917	25.84	9.36	35.2	40	-4.8	QP	H
119.436	24.68	11.76	36.44	43.5	-7.06	QP	H
46.503	24.28	9.84	34.12	40	-5.88	QP	V
102.7192	24.6	10.8	35.4	43.5	-8.1	QP	V
134.5592	28.08	11.98	40.06	43.5	-3.44	QP	V

**3.2.8 TEST RESULTS (ABOVE 1000 MHZ)**

Frequency (MHz)	Meter Reading (dB μ V)	Factor (dB)	Emission Level (dB μ V/m)	Limits (dB μ V/m)	Margin (dB)	Detect or Type	Comment
Low Channel (2412 MHz)-Above 1G							
4824.22	45.73	10.44	56.17	74	-17.83	Pk	Vertical
4824.22	37.67	10.44	48.11	54	-5.89	Av	Vertical
7236.43	42.17	12.39	54.56	74	-19.44	Pk	Vertical
7236.43	35.33	12.39	47.72	54	-6.28	Av	Vertical
4824.54	47.55	10.44	57.99	74	-16.01	Pk	Horizontal
4824.54	38.68	10.44	49.12	54	-4.88	Av	Horizontal
7236.55	48.54	12.39	60.93	74	-13.07	Pk	Horizontal
7236.55	35.66	12.39	48.05	54	-5.95	Av	Horizontal
Mid Channel (2437 MHz)-Above 1G							
4874.55	46.35	10.4	56.75	74	-17.25	Pk	Vertical
4874.55	33.63	10.4	44.03	54	-9.97	Av	Vertical
7311.11	44.72	12.75	57.47	74	-16.53	Pk	Vertical
7311.11	34.64	12.75	47.39	54	-6.61	Av	Vertical
4874.36	45.54	10.4	55.94	74	-18.06	Pk	Horizontal
4874.36	34.63	10.4	45.03	54	-8.97	Av	Horizontal
7311.65	41.32	12.75	54.07	74	-19.93	Pk	Horizontal
7311.65	33.55	12.75	46.3	54	-7.7	Av	Horizontal
High Channel (2462 MHz)- Above 1G							
4924.87	45.63	10.39	56.02	74	-17.98	Pk	Vertical
4924.87	31.87	10.39	42.26	54	-11.74	Av	Vertical
7386.37	44.75	12.68	57.43	74	-16.57	Pk	Vertical
7386.37	32.86	12.68	45.54	54	-8.46	Av	Vertical
4924.59	45.74	10.39	56.13	74	-17.87	Pk	Horizontal
4924.59	34.74	10.39	45.13	54	-8.87	Av	Horizontal
7386.47	45.63	12.68	58.31	74	-15.69	Pk	Horizontal
7386.47	32.53	12.68	45.21	54	-8.79	Av	Horizontal

Note: "802.11b" mode is the worst mode.



Conducted Spurious Emissions at Antenna Port:
802.11b Low Channel

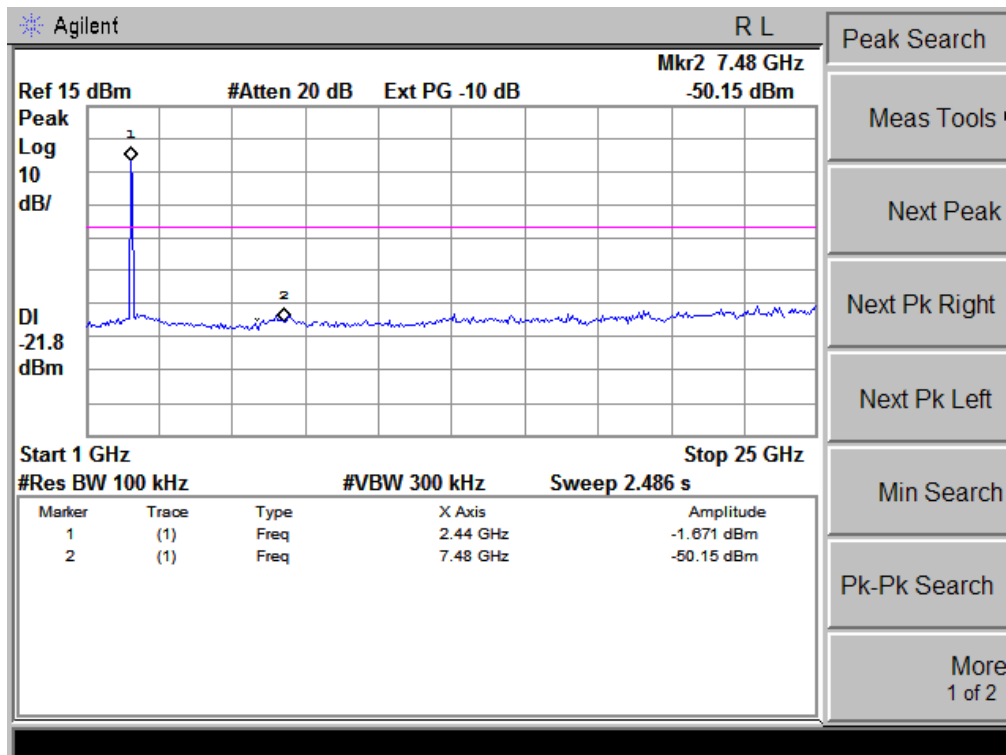
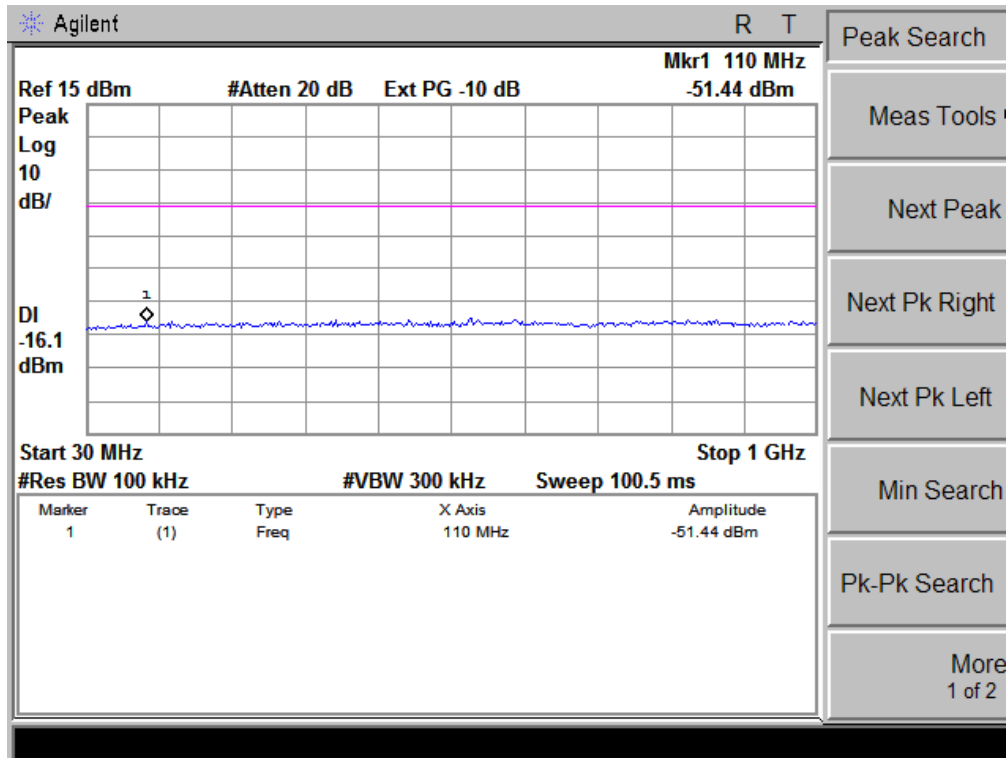



802.11b Middle Channel

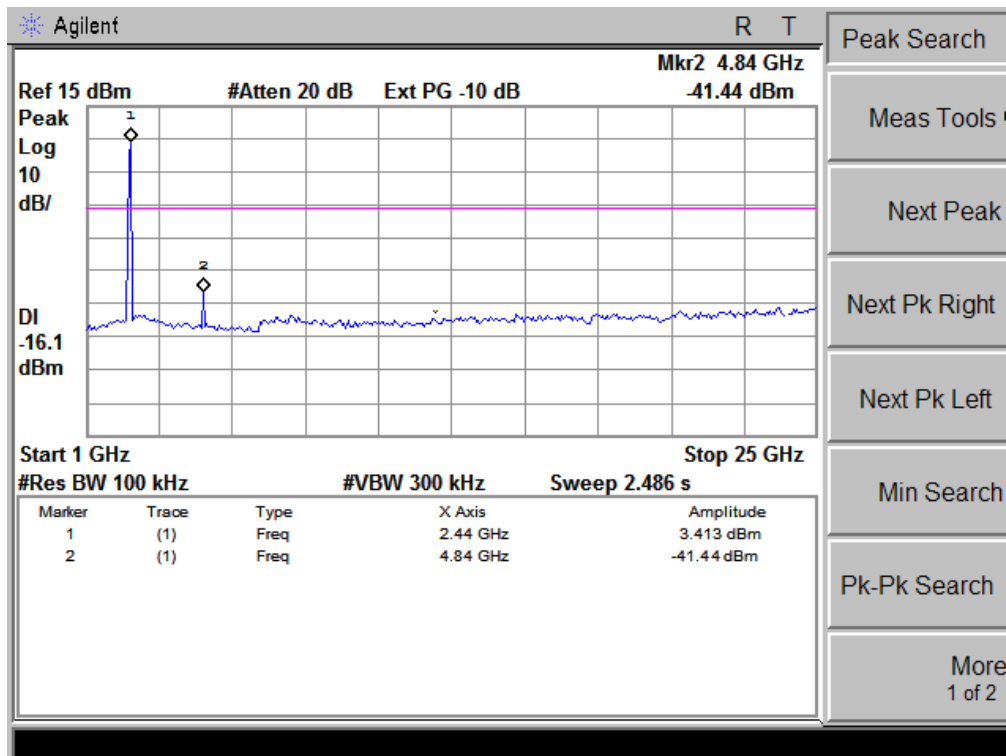
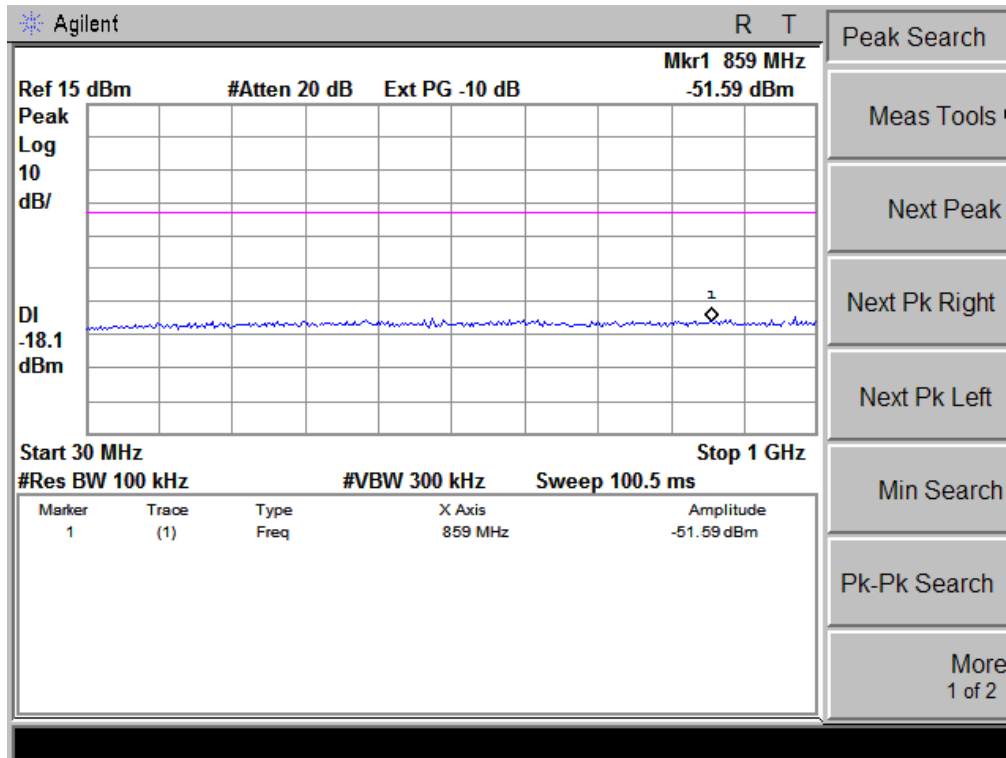



802.11b High Channel

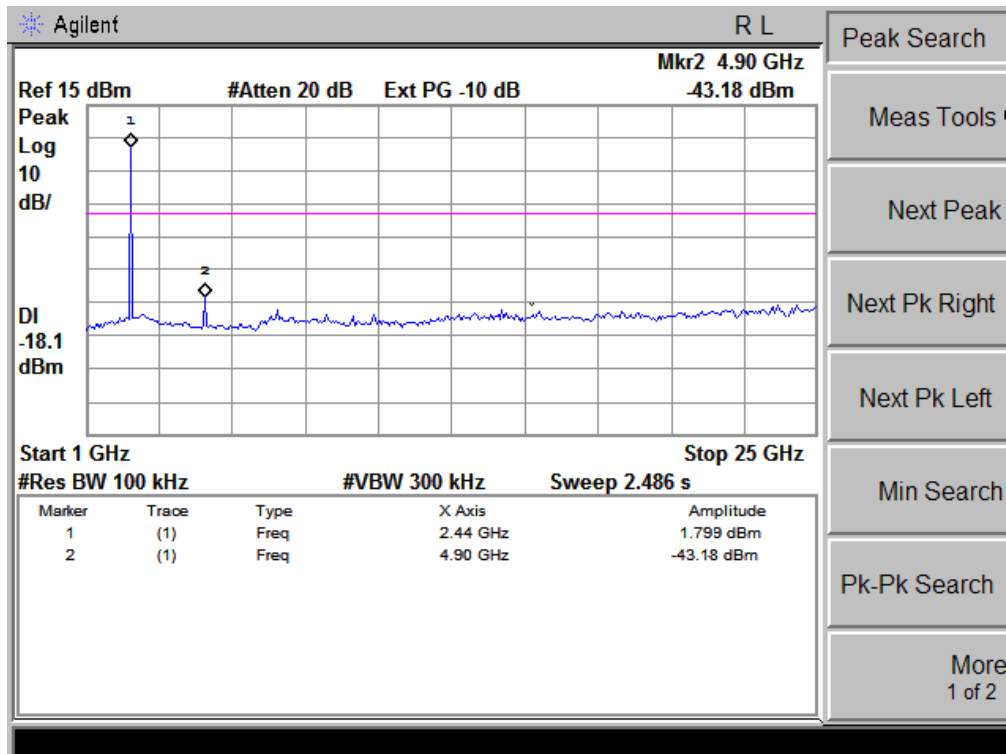
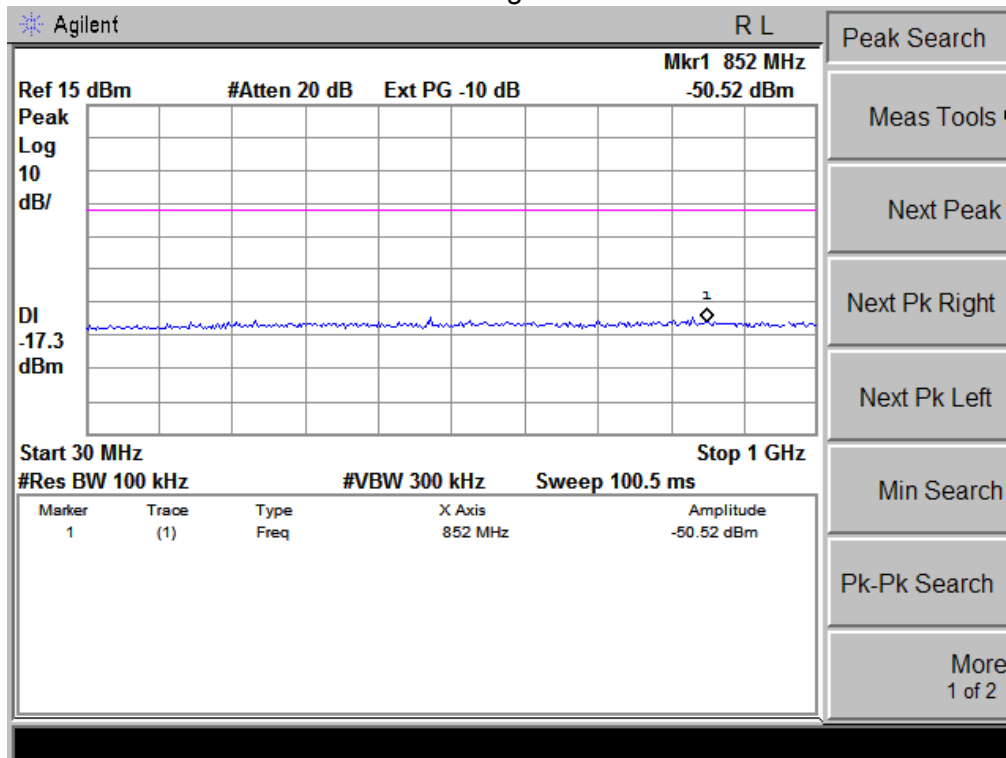



802.11g Low Channel

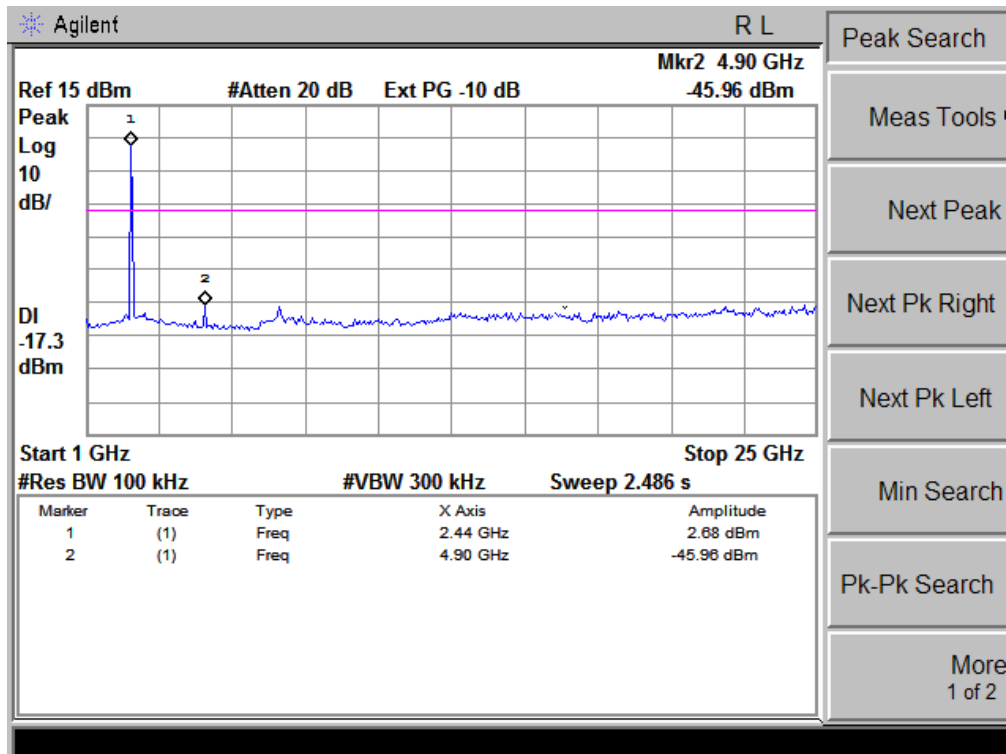
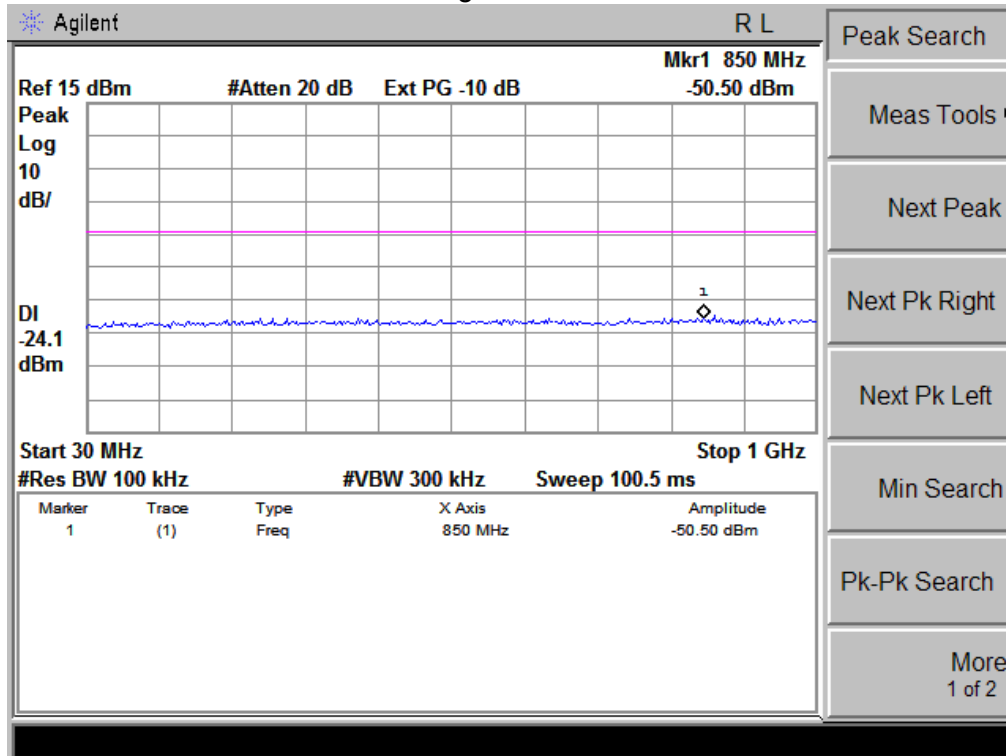



802.11g Middle Channel

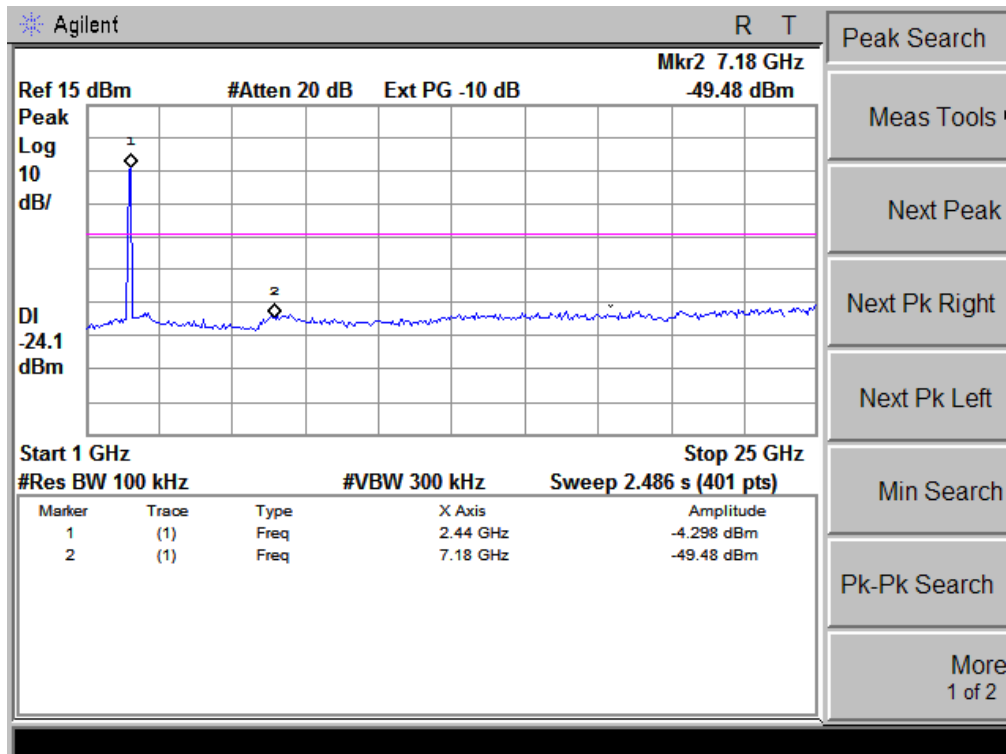
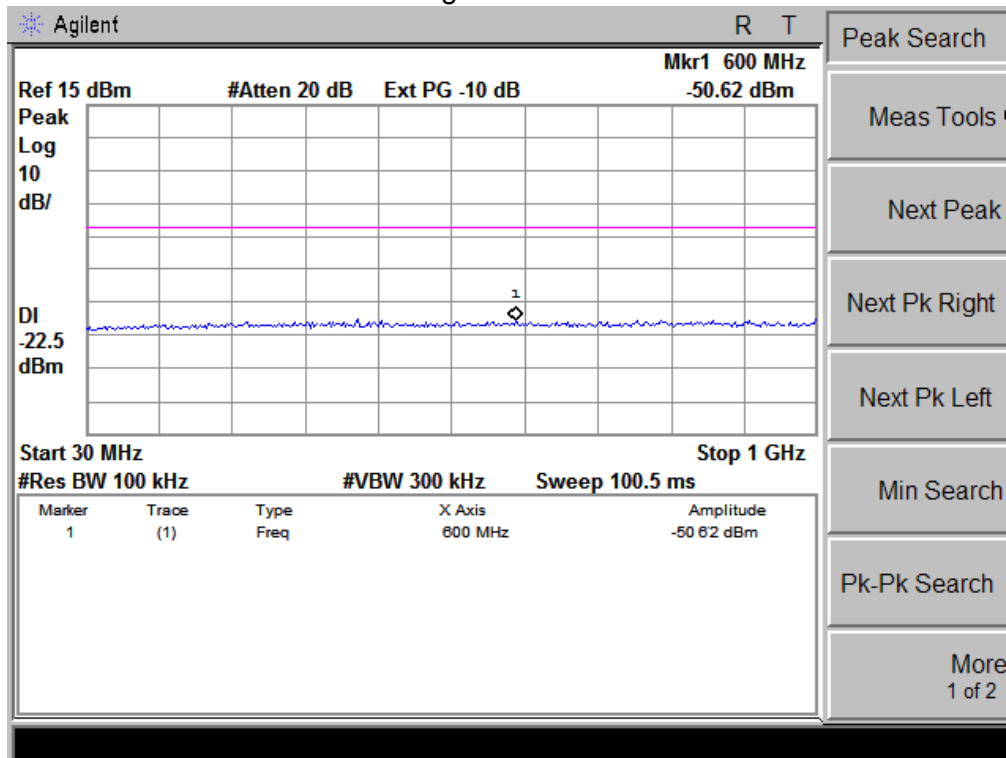



802.11g High Channel

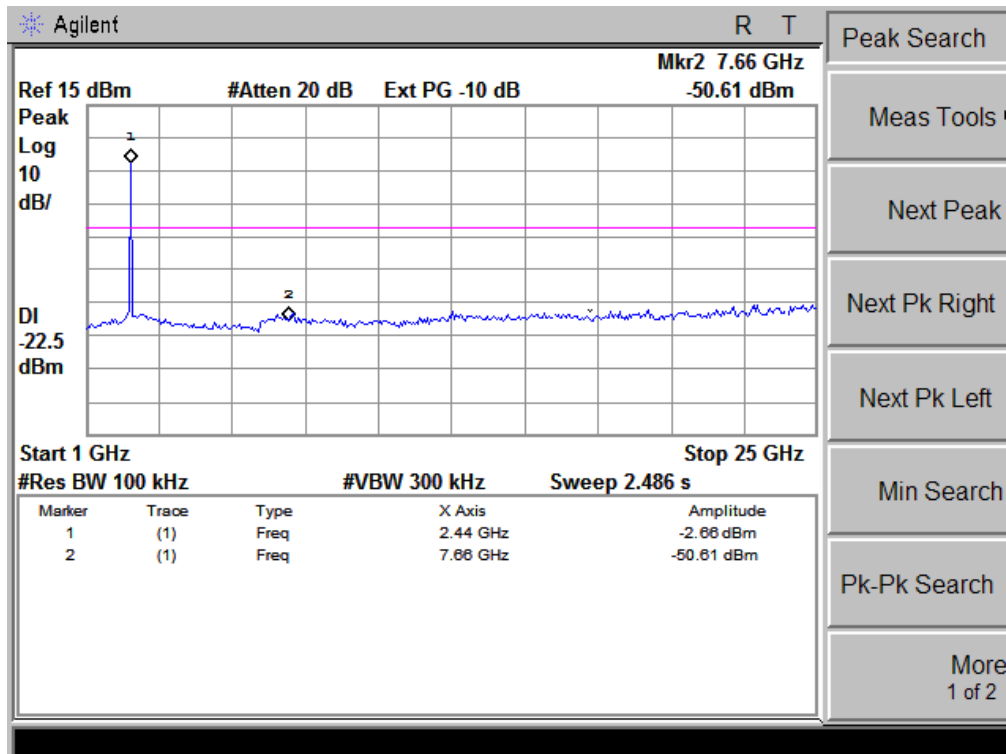
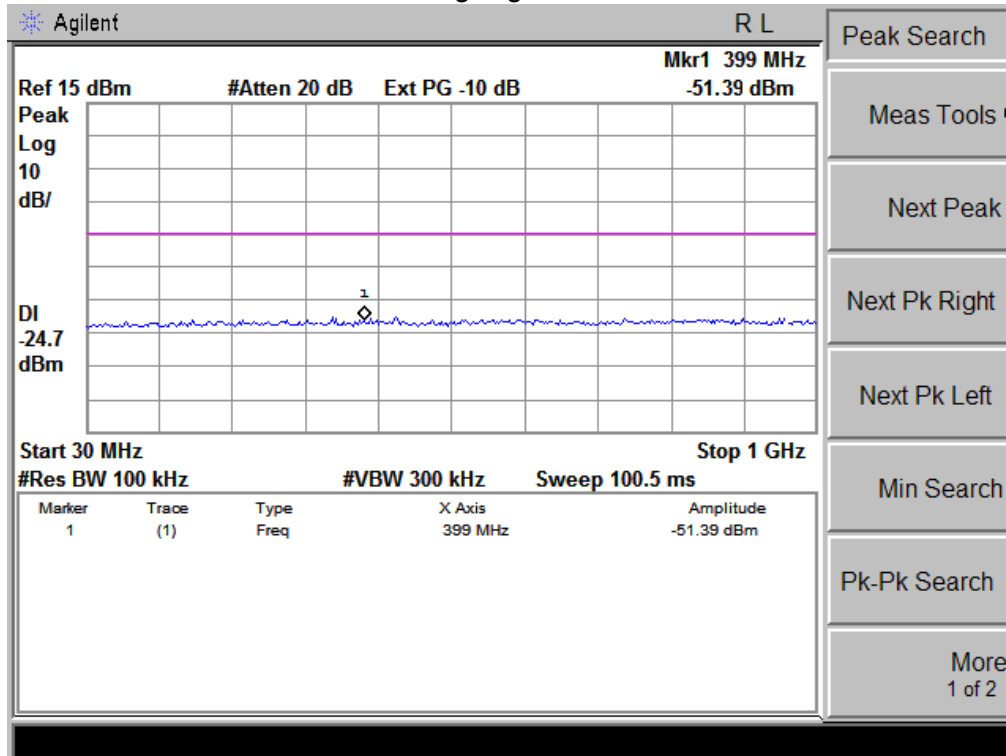



802.11n-HT20 Low Channel

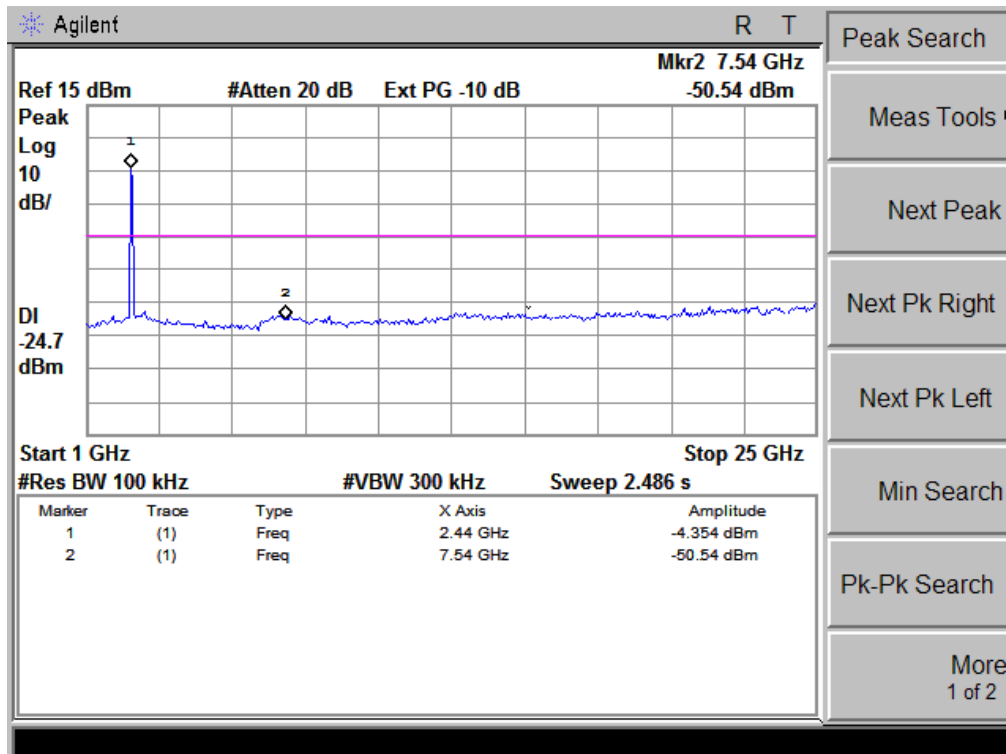
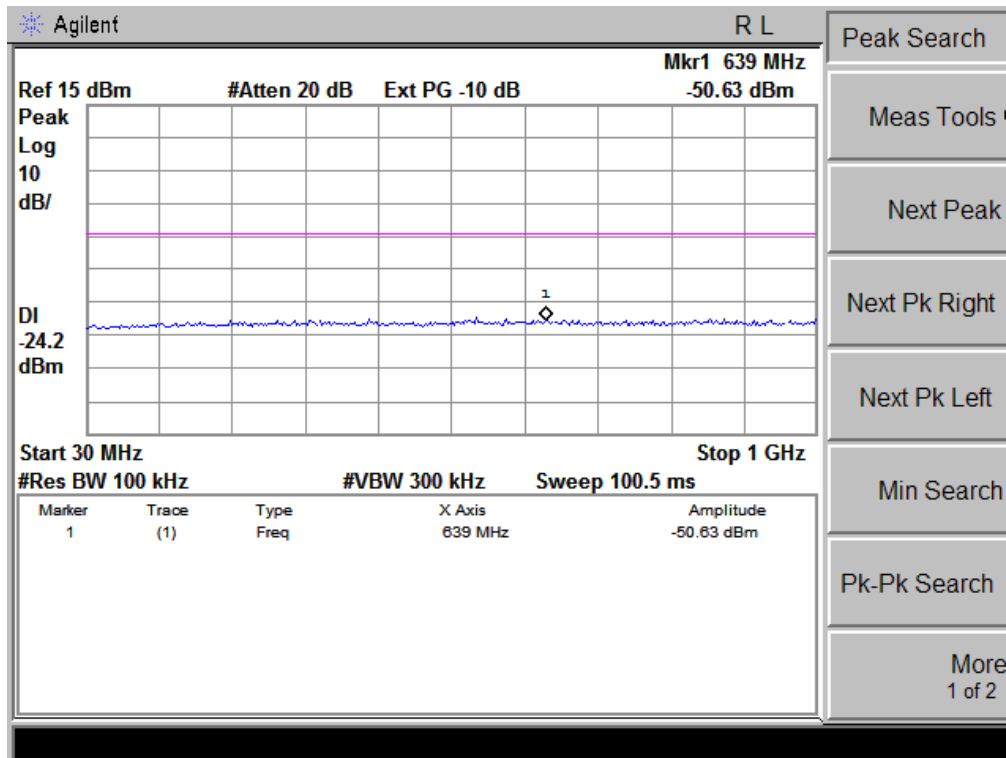



802.11n-HT20 Middle Channel

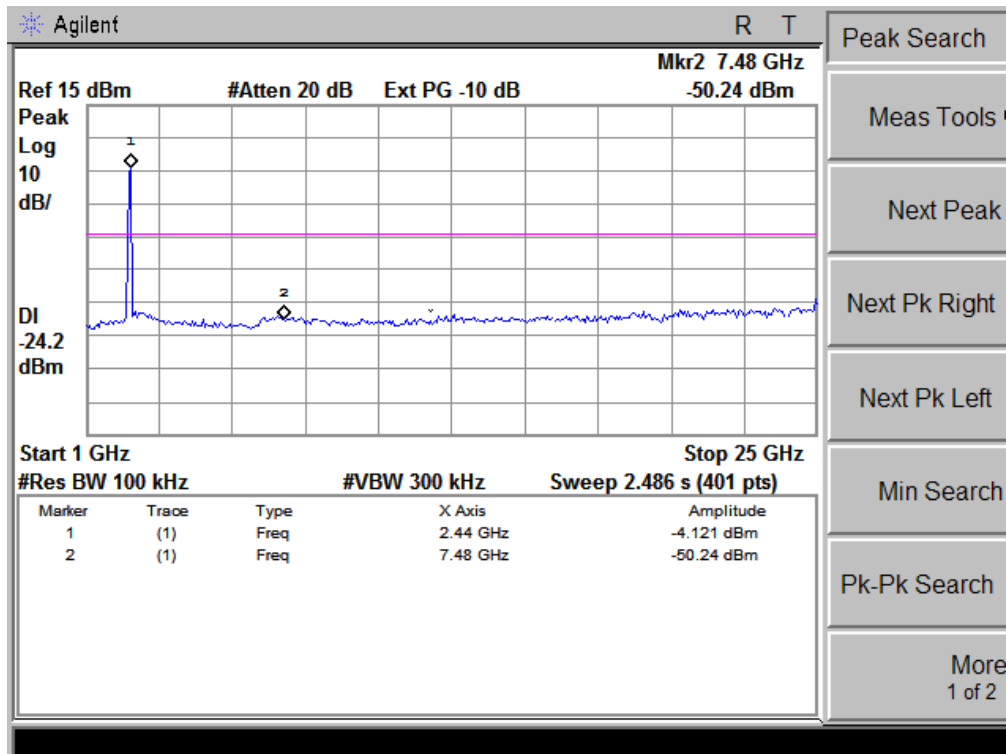
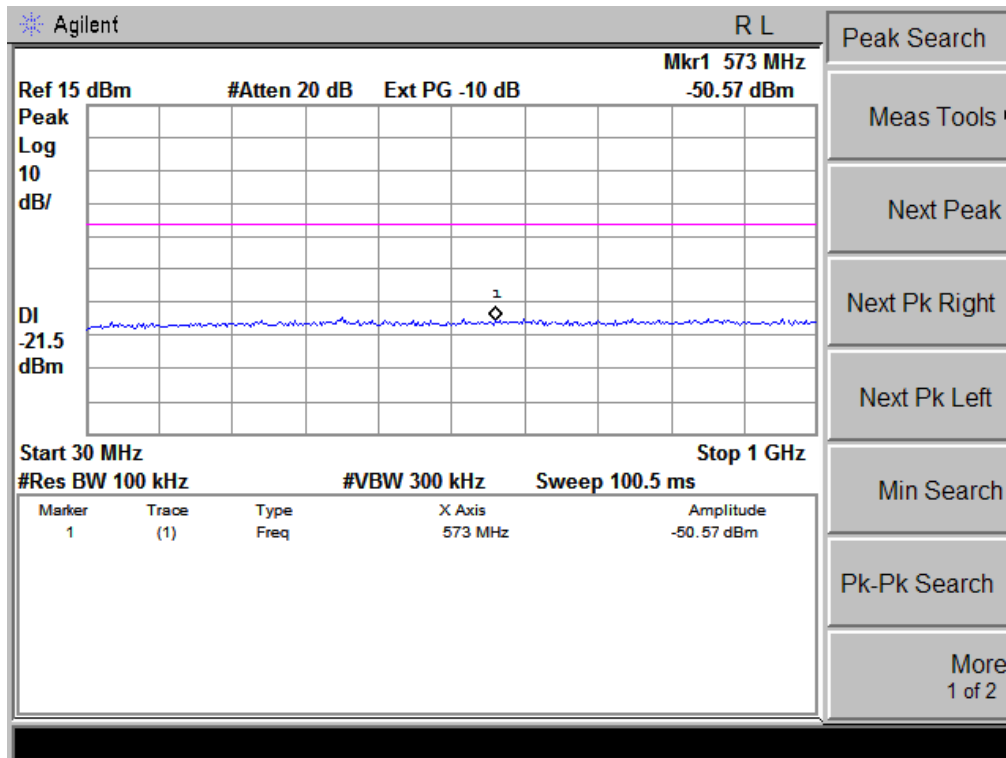



802.11n-HT20 High Channel

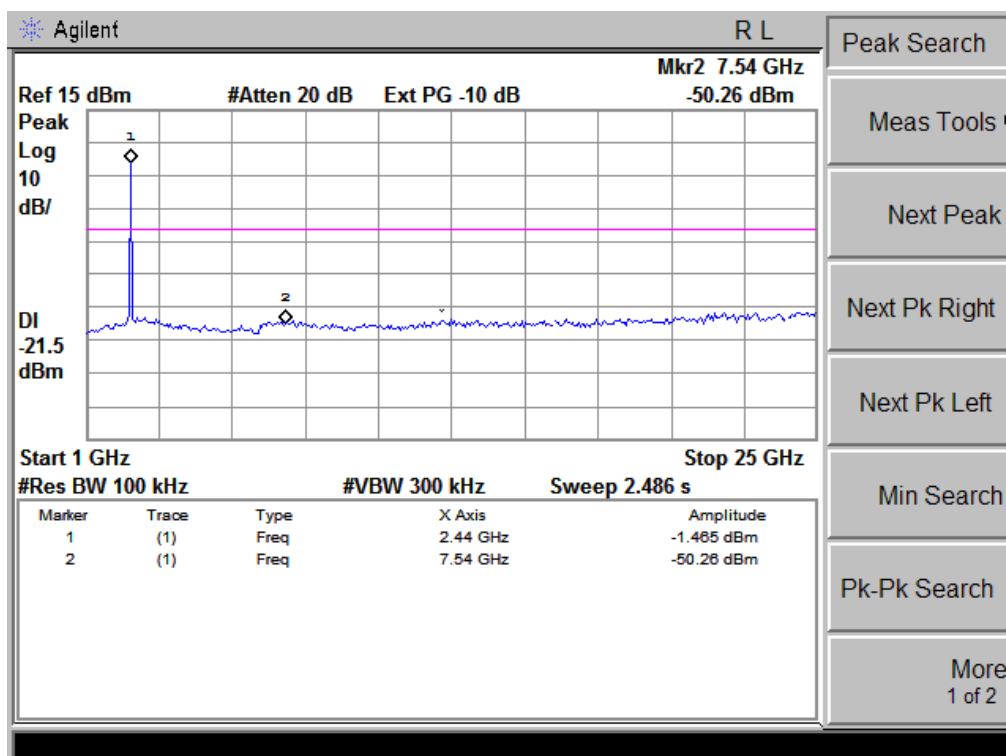
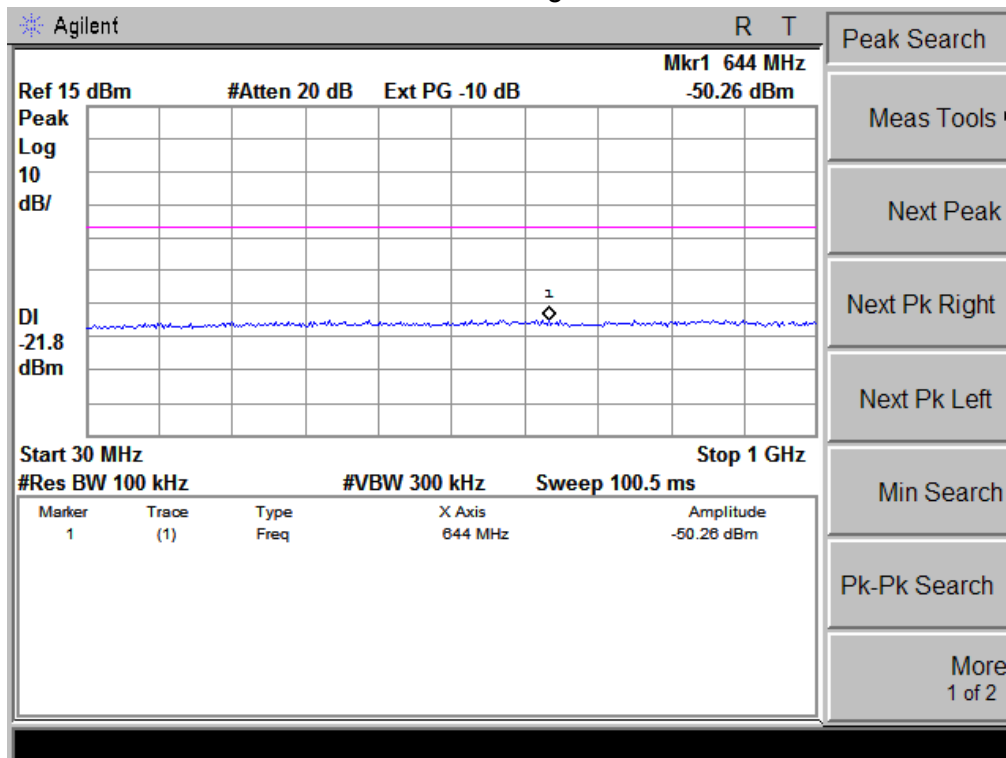



4. POWER SPECTRAL DENSITY TEST

4.1 APPLIED PROCEDURES / LIMIT

FCC Part15 (15.247) , Subpart C				
Section	Test Item	Limit	Frequency Range (MHz)	Result
15.247	Power Spectral Density	8 dBm (in any 3KHz)	2400-2483.5	PASS

4.1.1 TEST PROCEDURE

1. Set analyzer center frequency to DTS channel center frequency.
2. Set the span to 1.5 times the DTS channel bandwidth.
3. Set the RBW \geq 3 kHz.
4. Set the VBW \geq 3 x RBW.
5. Detector = peak.
6. Sweep time = auto couple.
7. Trace mode = max hold.
8. Allow trace to fully stabilize.
9. Use the peak marker function to determine the maximum amplitude level.
10. If measured value exceeds limit, reduce RBW (no less than 3 kHz) and repeat.

4.1.2 DEVIATION FROM STANDARD

No deviation.

4.1.3 TEST SETUP

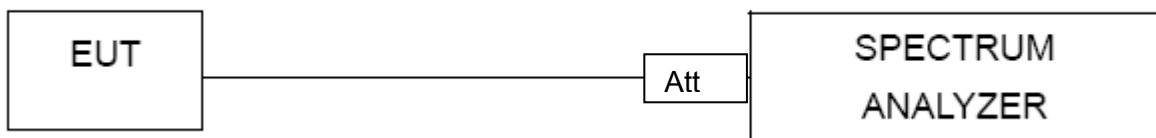

4.1.4 EUT OPERATION CONDITIONS

The EUT tested system was configured as the statements of 2.1 Unless otherwise a special operating condition is specified in the follows during the testing.



4.1.5 TEST RESULTS

EUT :	With Wifi Touch Screen PC	Model Name :	FT15PC
Temperature :	25 °C	Relative Humidity :	56%
Pressure :	1015 hPa	Test Voltage :	AC 120V/60Hz
Test Mode :	TX b Mode /CH01, CH06, CH11		

Frequency	Power Density (dBm)	Limit (dBm)	Result
2412 MHz	-9.266	8	PASS
2437 MHz	-9.206	8	PASS
2462 MHz	-8.751	8	PASS

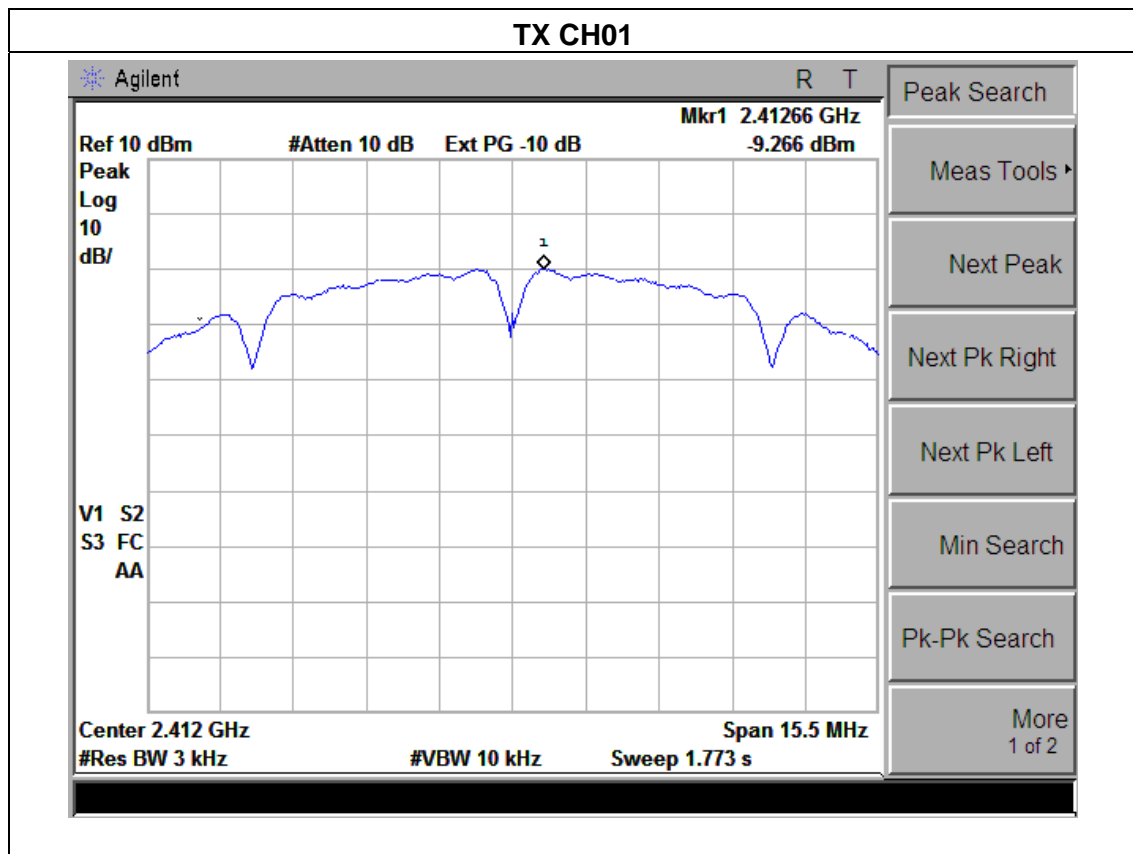

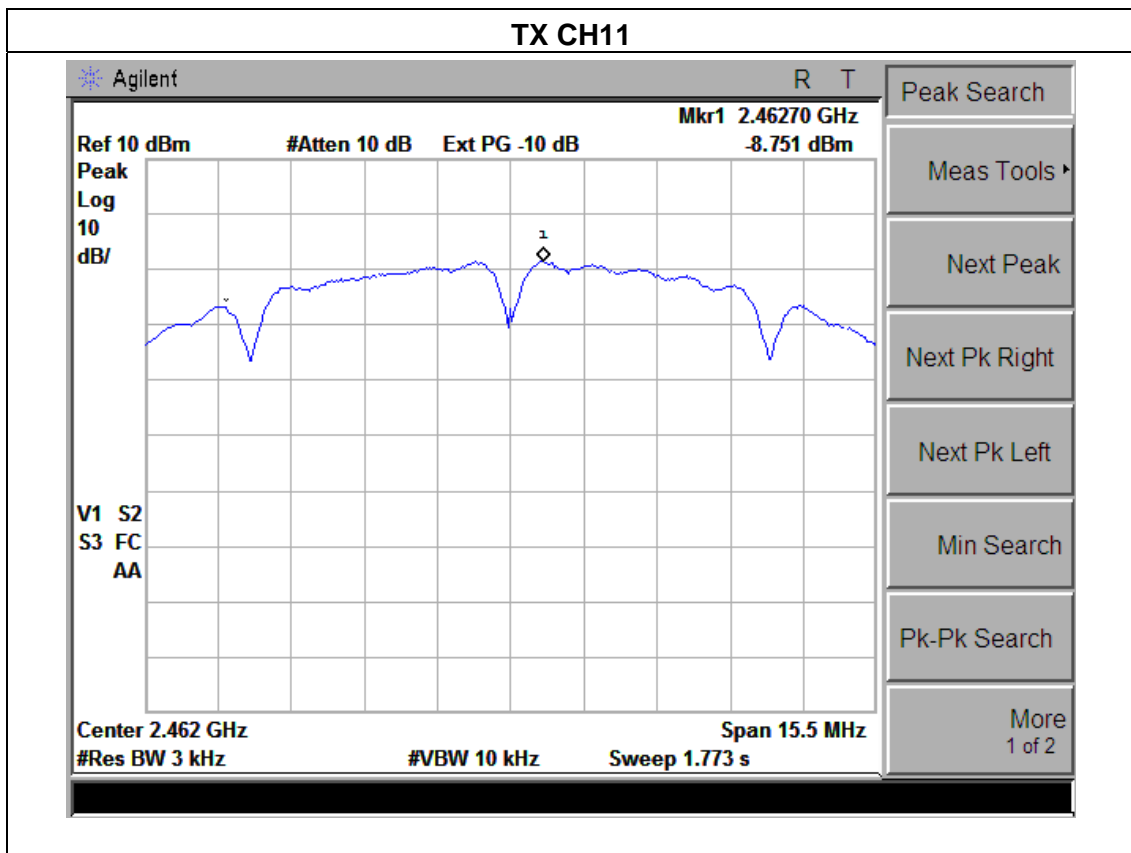
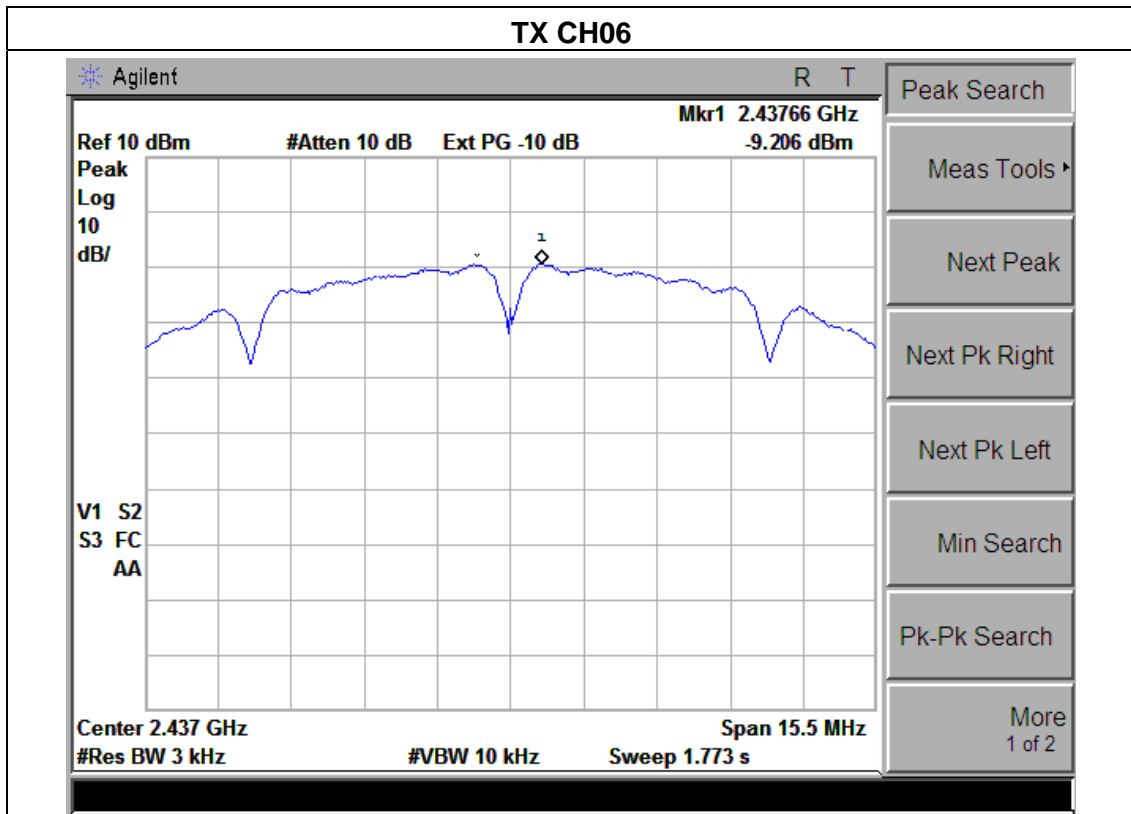



EUT :	With Wifi Touch Screen PC	Model Name :	FT15PC
Temperature :	25 °C	Relative Humidity :	56%
Pressure :	1015 hPa	Test Voltage :	AC 120V/60Hz
Test Mode :	TX g Mode /CH01, CH06, CH11		

Frequency	Power Density (dBm)	Limit (dBm)	Result
2412 MHz	-12.41	8	PASS
2437 MHz	-15.77	8	PASS
2462 MHz	-13.28	8	PASS

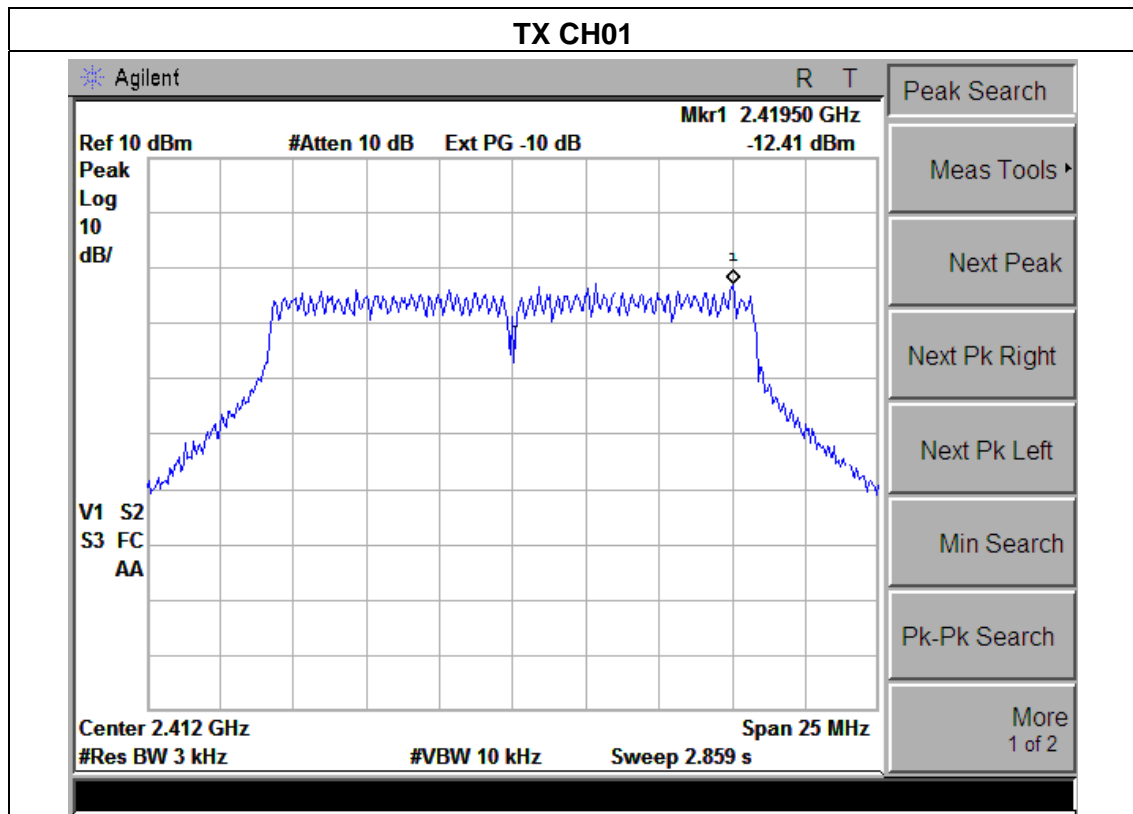

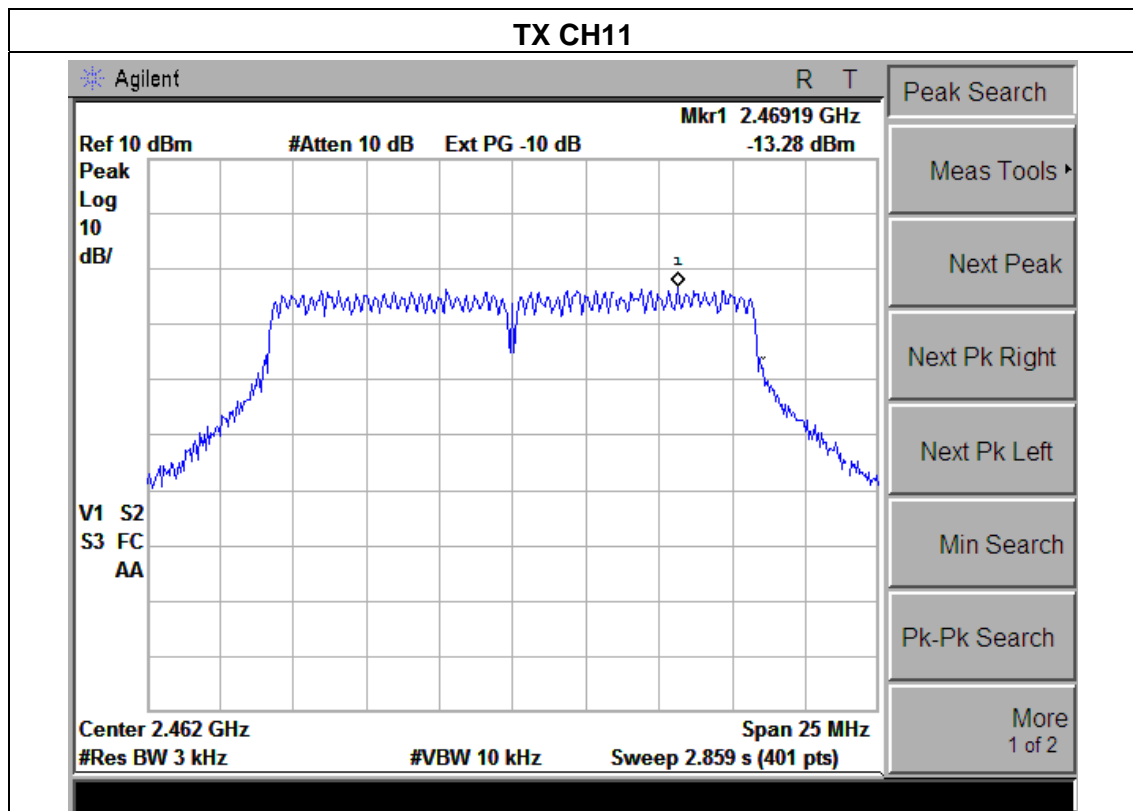
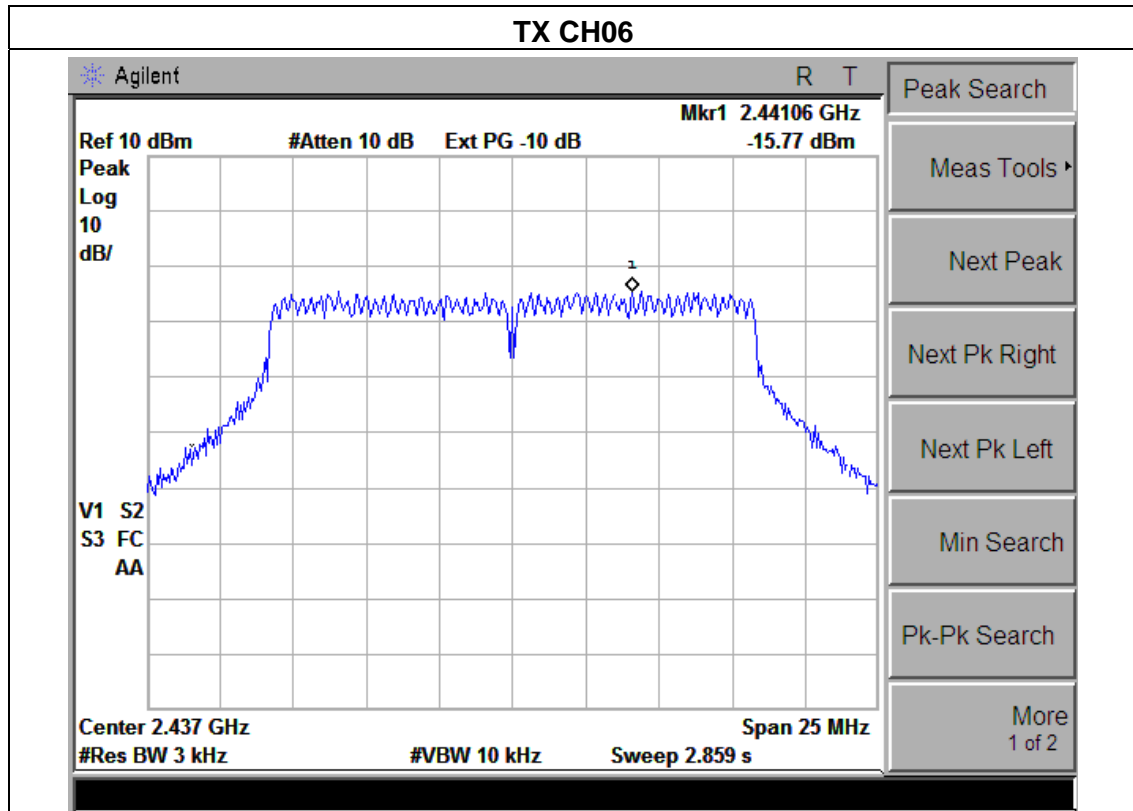



EUT :	With Wifi Touch Screen PC	Model Name :	FT15PC
Temperature :	25 °C	Relative Humidity :	56%
Pressure :	1015 hPa	Test Voltage :	AC 120V/60Hz
Test Mode :	TX n Mode(20M) /CH01, CH06, CH11		

Frequency	Power Density (dBm)	Limit (dBm)	Result
2412 MHz	-14.85	8	PASS
2437 MHz	-15.84	8	PASS
2462 MHz	-14.39	8	PASS

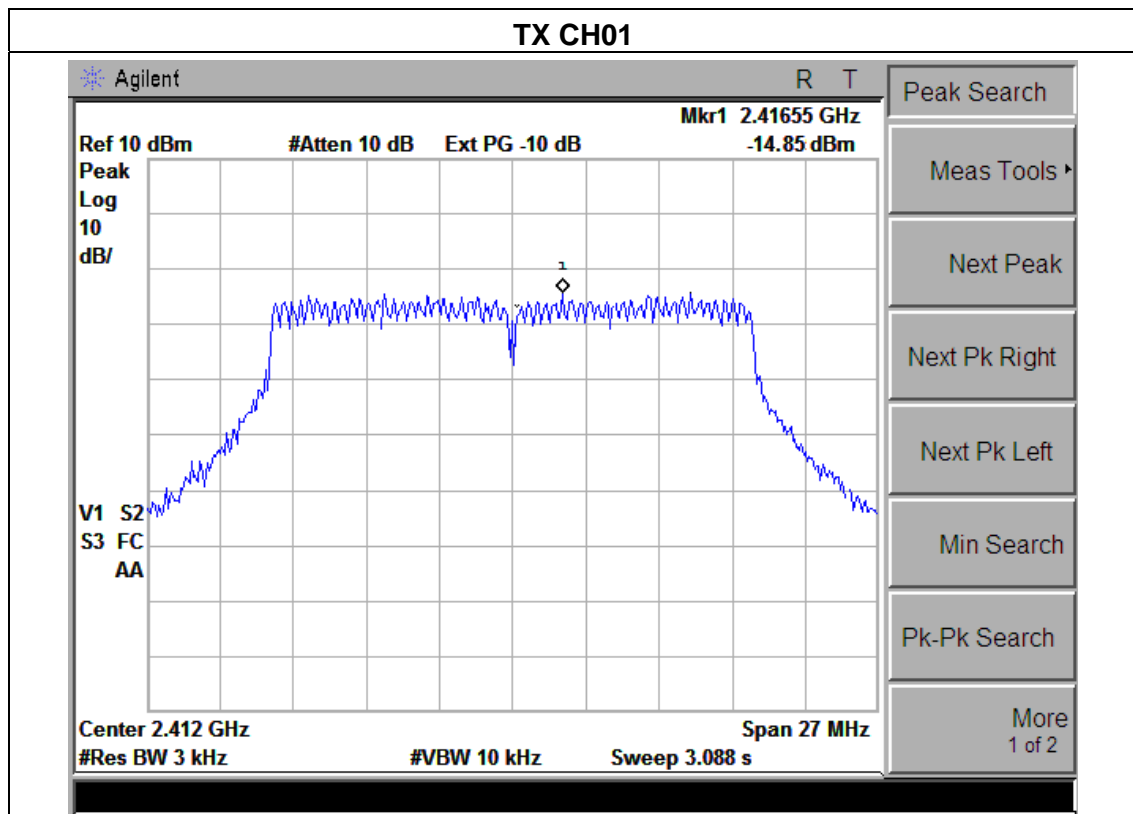

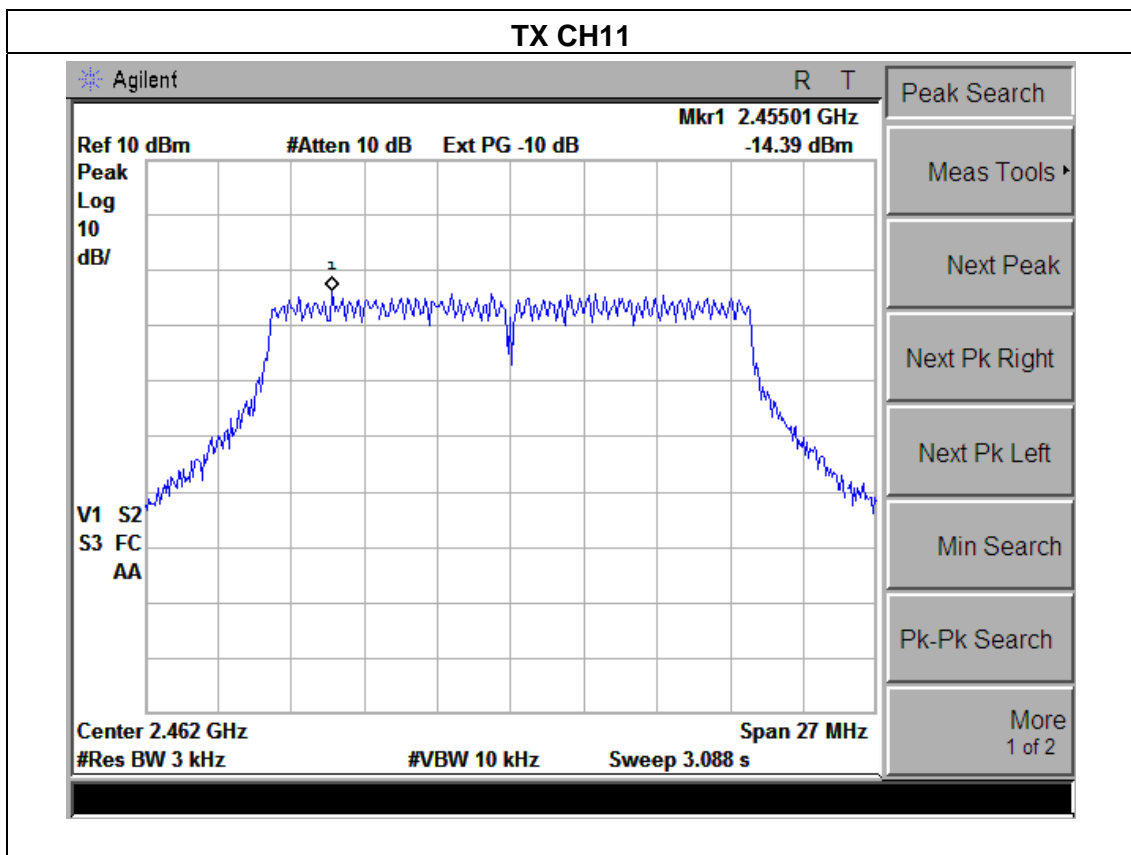
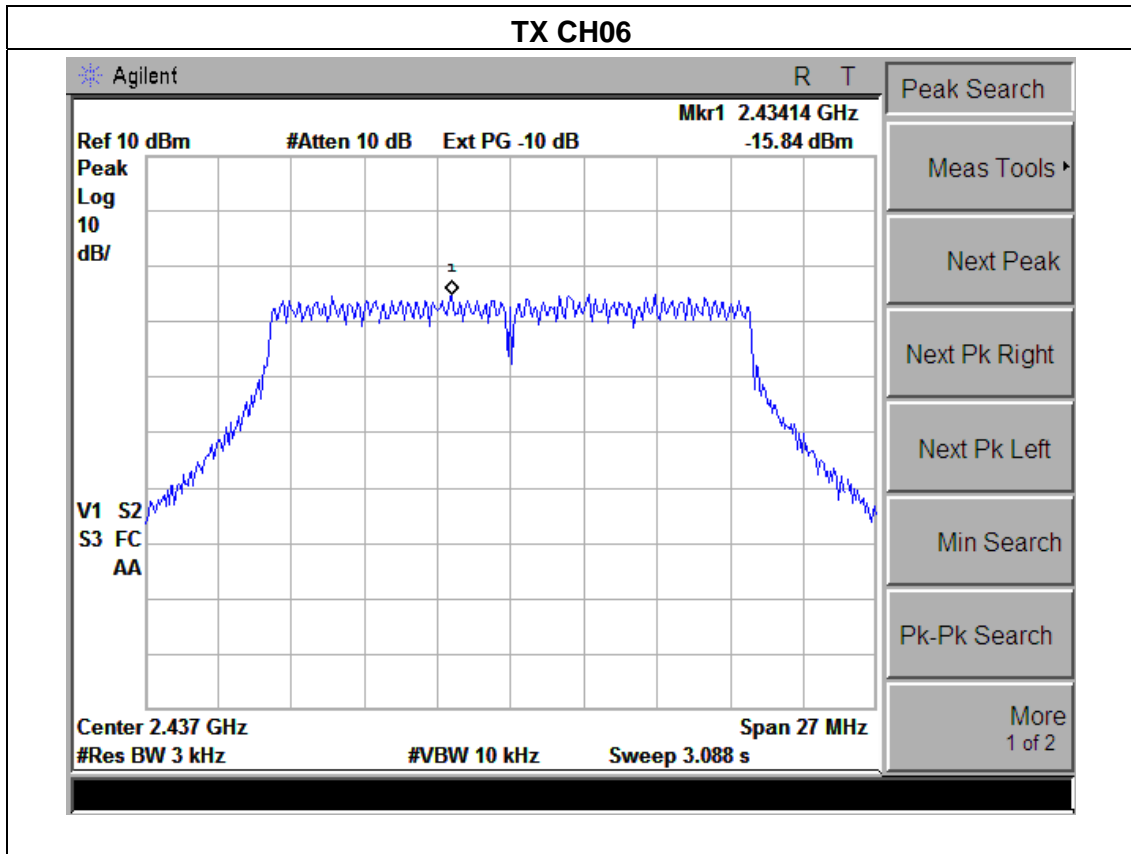

5. BANDWIDTH TEST

5.1 APPLIED PROCEDURES / LIMIT

FCC Part15 (15.247) , Subpart C				
Section	Test Item	Limit	Frequency Range (MHz)	Result
15.247(a)(2)	Bandwidth	$\geq 500\text{KHz}$ (6dB bandwidth)	2400-2483.5	PASS

5.1.1 TEST PROCEDURE

According to KDB 558074 D01 DTS Meas Guidance v03r01

1. Check the calibration of the measuring instrument using either an internal calibrator or a known signal from an external generator
2. Position the EUT without connection to measurement instrument. Turn on the EUT and connect it to measurement instrument. Then set it to any one convenient frequency within its operating range. Set a reference level on the measuring instrument equal to the highest peak value.
3. Measure the frequency difference of two frequencies that were attenuated 6 dB from the reference level. Record the frequency difference as the emission bandwidth.
4. Repeat above procedures until all frequencies measured were complete.

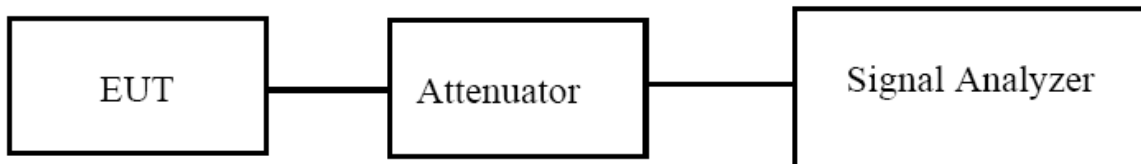

5.1.2 EUT OPERATION CONDITIONS

The EUT tested system was configured as the statements of 2.4 Unless otherwise a special operating condition is specified in the follows during the testing.



5.1.3 TEST RESULTS

EUT :	With Wifi Touch Screen PC	Model Name :	FT15PC
Temperature :	25 °C	Relative Humidity :	56%
Pressure :	1012 hPa	Test Voltage :	AC 120V/60Hz
Test Mode :	TX b Mode /CH01, CH06, CH11		

Channel	Frequency (MHz)	6dB bandwidth (MHz)	Limit (kHz)	Result
Low	2412	10.184	500	Pass
Middle	2437	10.688	500	Pass
High	2462	10.519	500	Pass

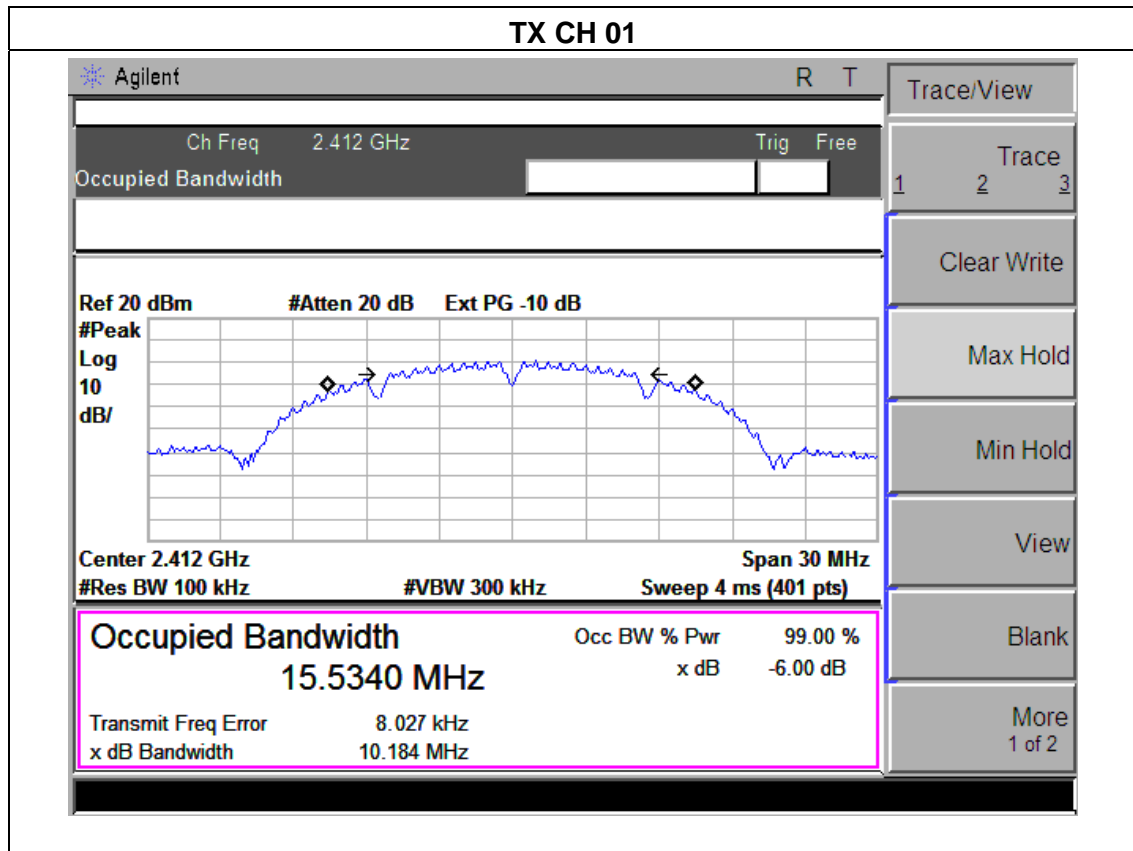

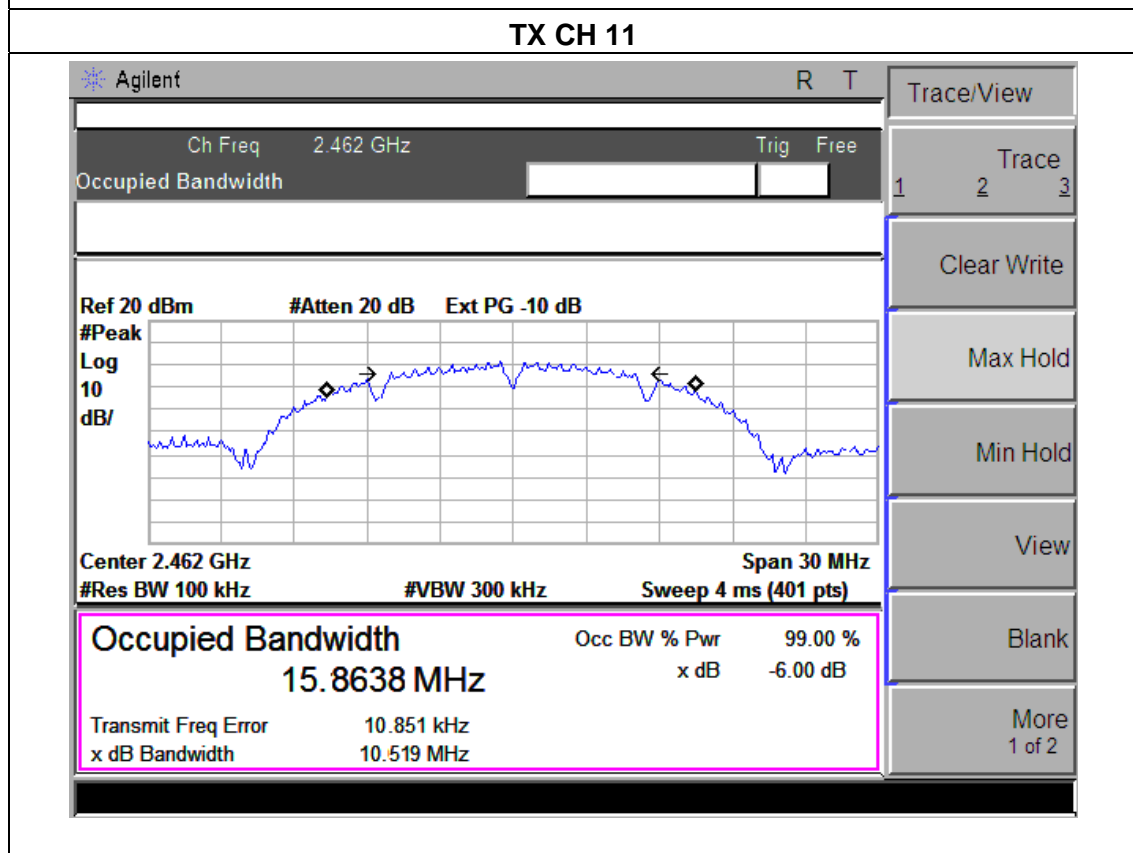
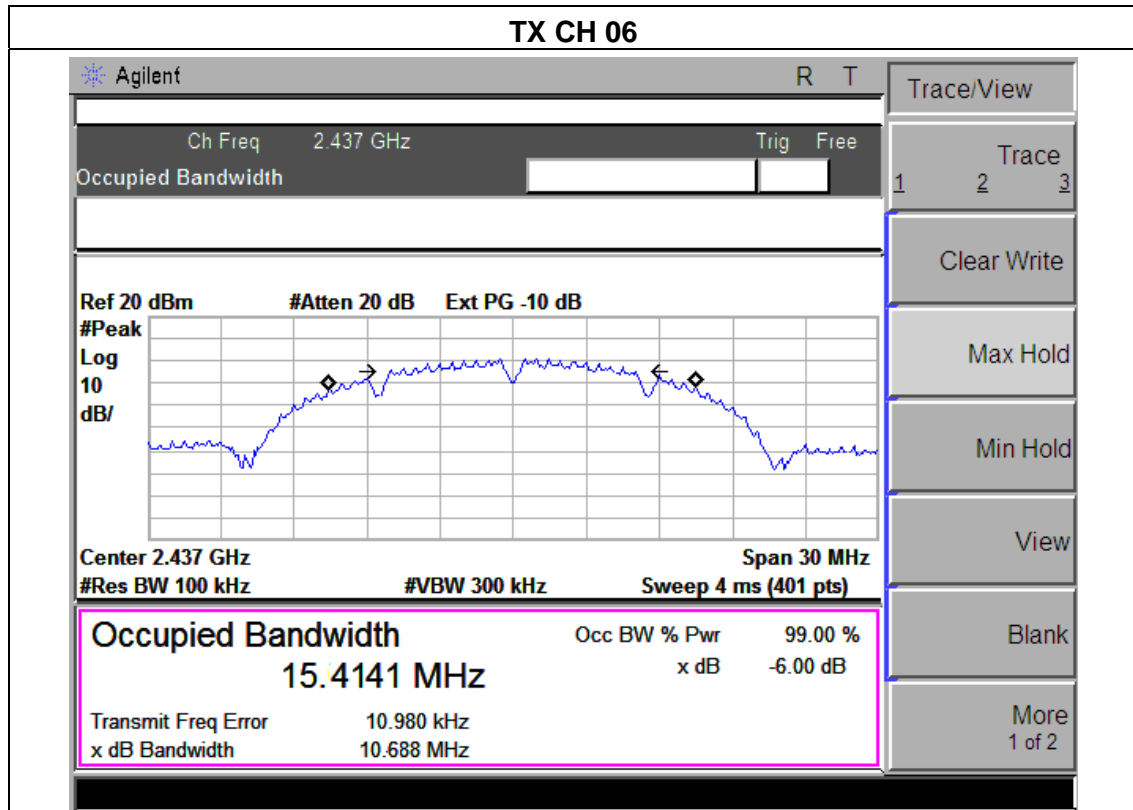



EUT :	With Wifi Touch Screen PC	Model Name :	FT15PC
Temperature :	25 °C	Relative Humidity :	60%
Pressure :	1012 hPa	Test Voltage :	AC 120V/60Hz
Test Mode :	TX g Mode /CH01, CH06, CH11		

Channel	Frequency (MHz)	6dB bandwidth (MHz)	Limit (kHz)	Result
Low	2412	16.609	500	Pass
Middle	2437	16.579	500	Pass
High	2462	16.996	500	Pass

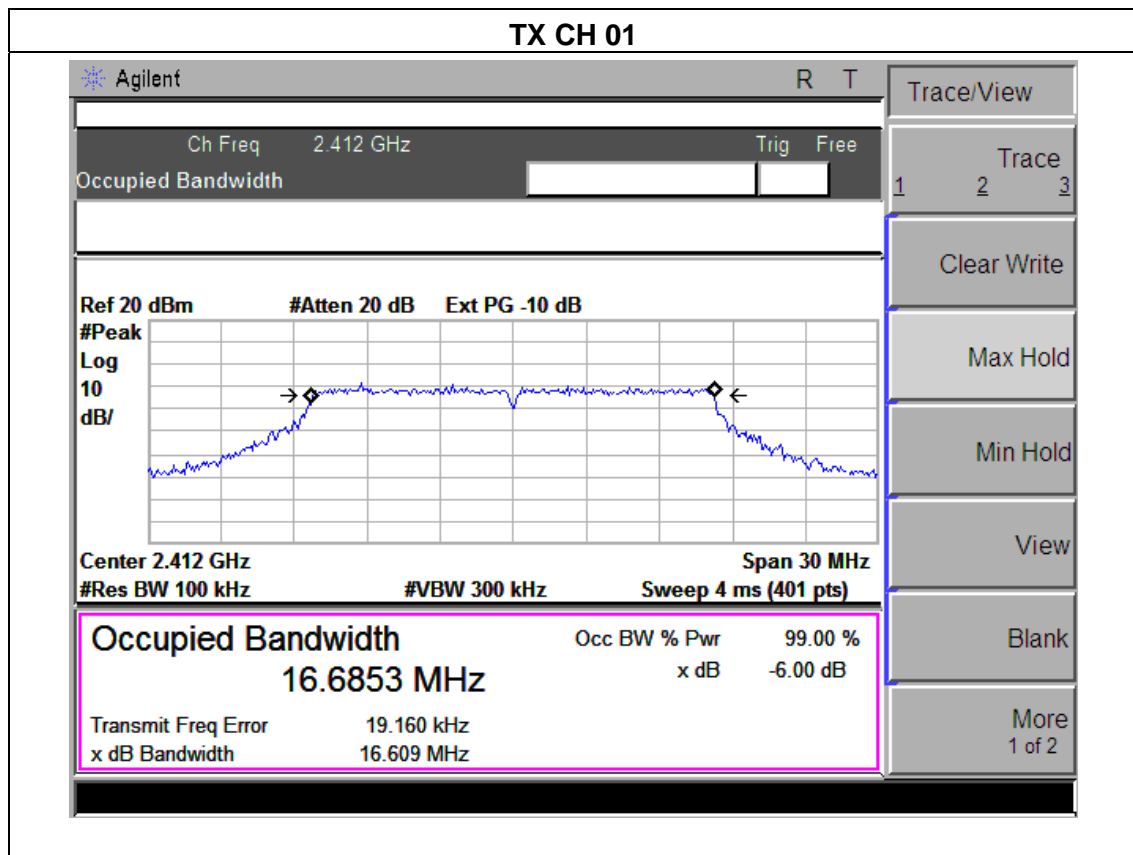

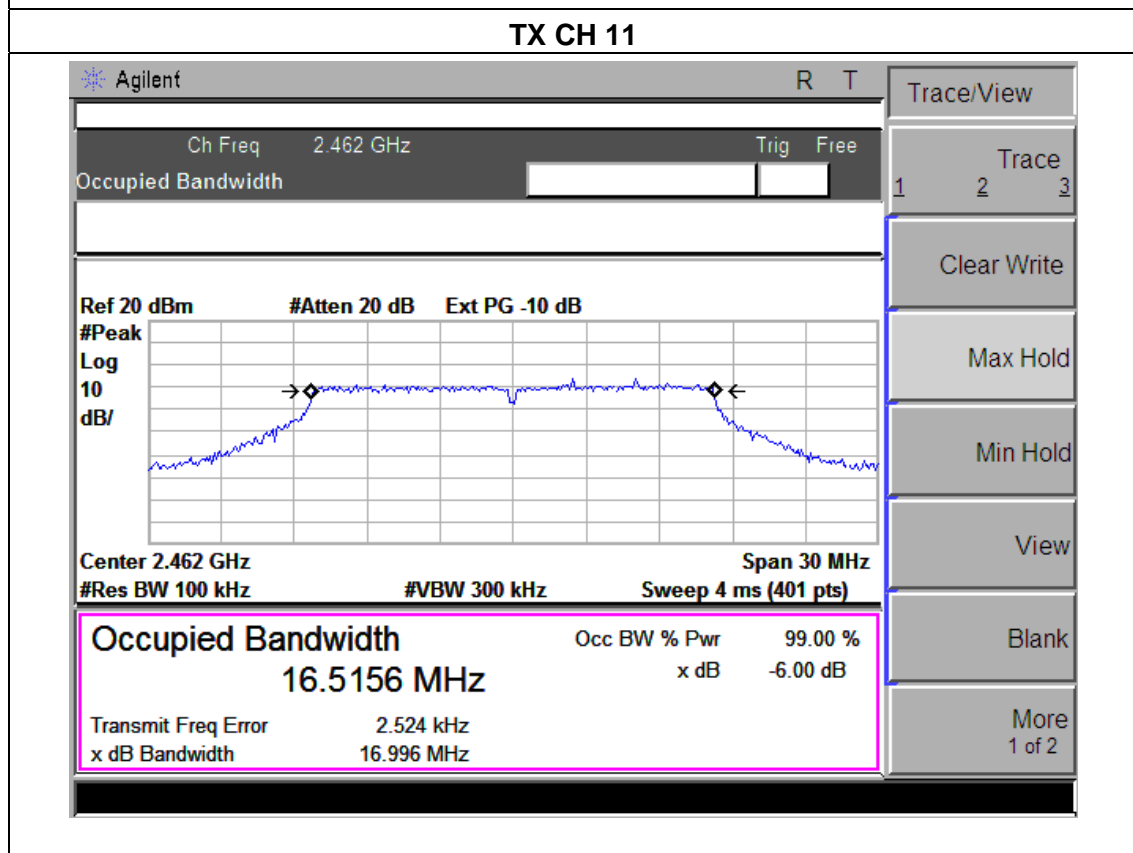
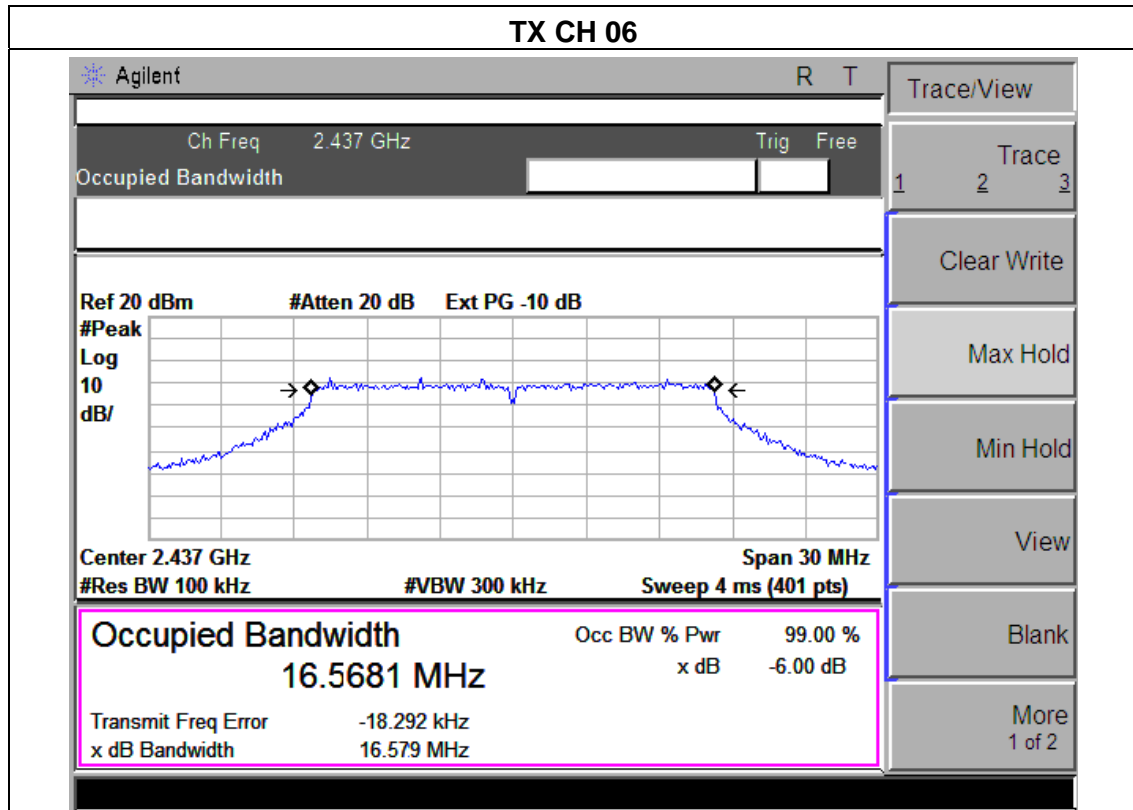



EUT :	With Wifi Touch Screen PC	Model Name :	FT15PC
Temperature :	25 °C	Relative Humidity :	56%
Pressure :	1012 hPa	Test Voltage :	AC 120V/60Hz
Test Mode :	TX n Mode(20M) /CH01, CH06, CH11		

Channel	Frequency (MHz)	6dB bandwidth (MHz)	Limit (kHz)	Result
Low	2412	17.422	500	Pass
Middle	2437	17.639	500	Pass
High	2462	16.616	500	Pass

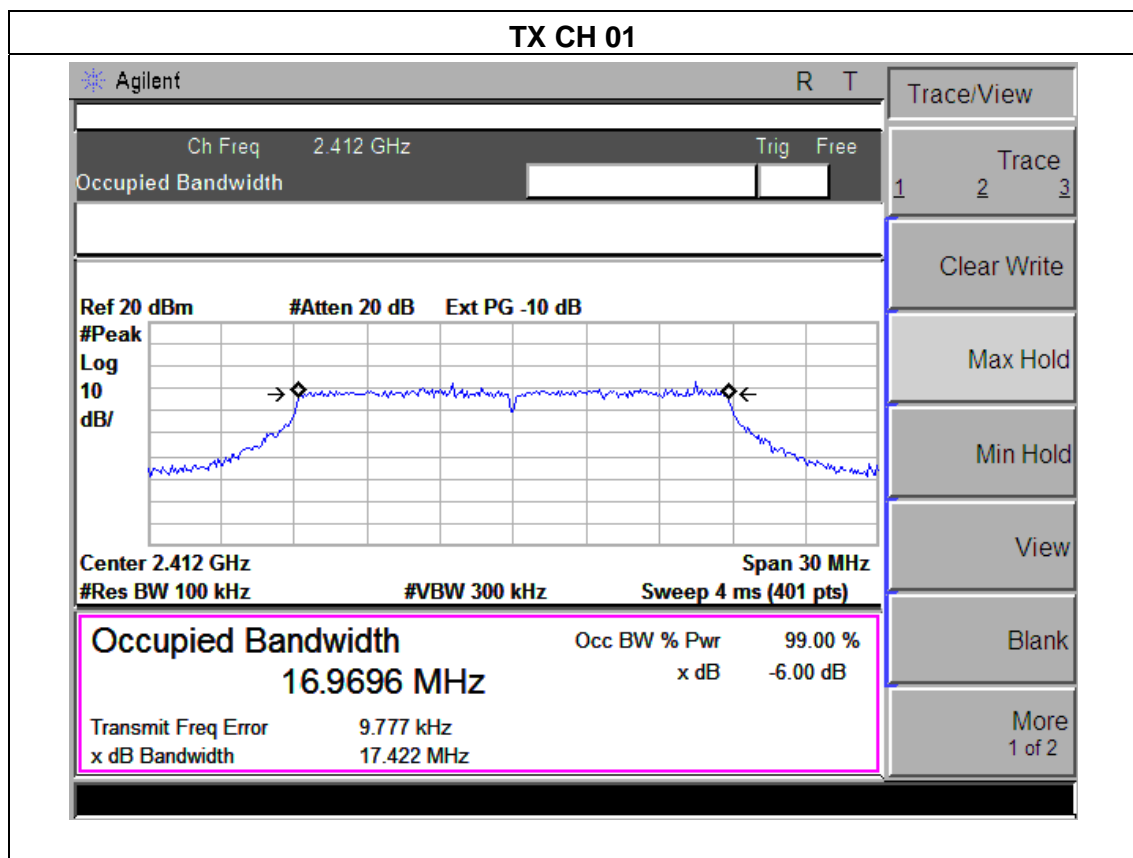

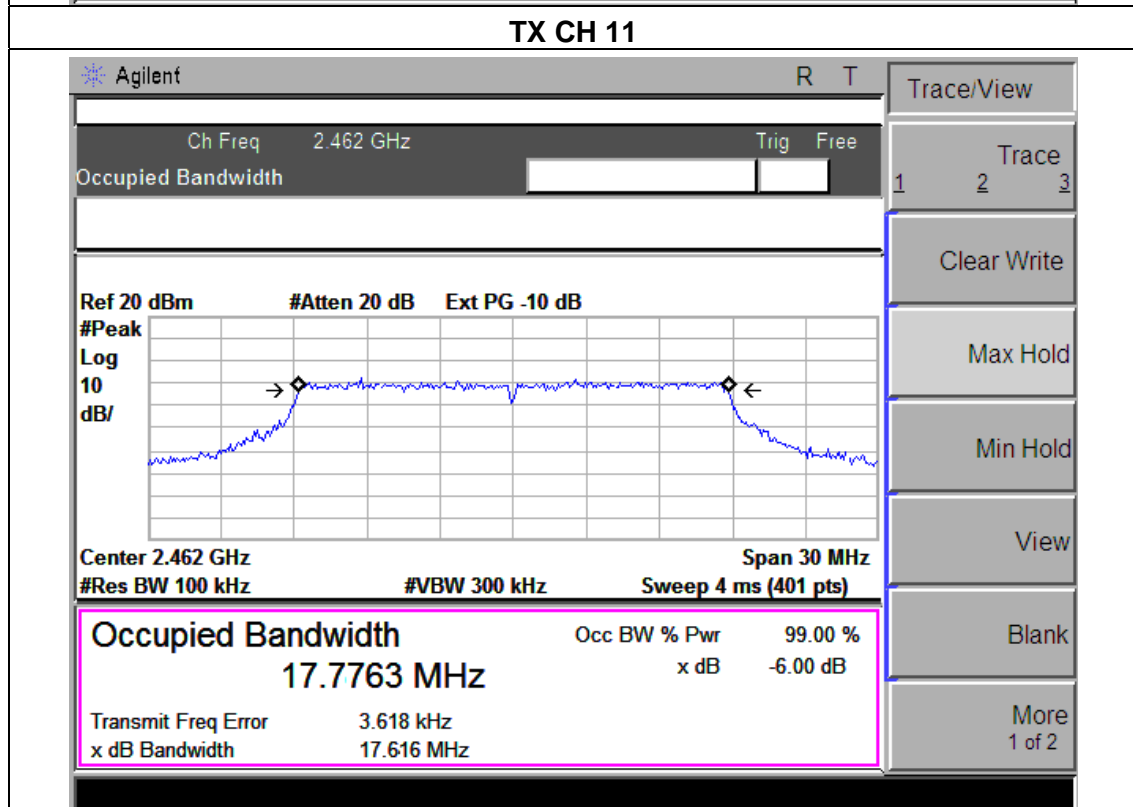
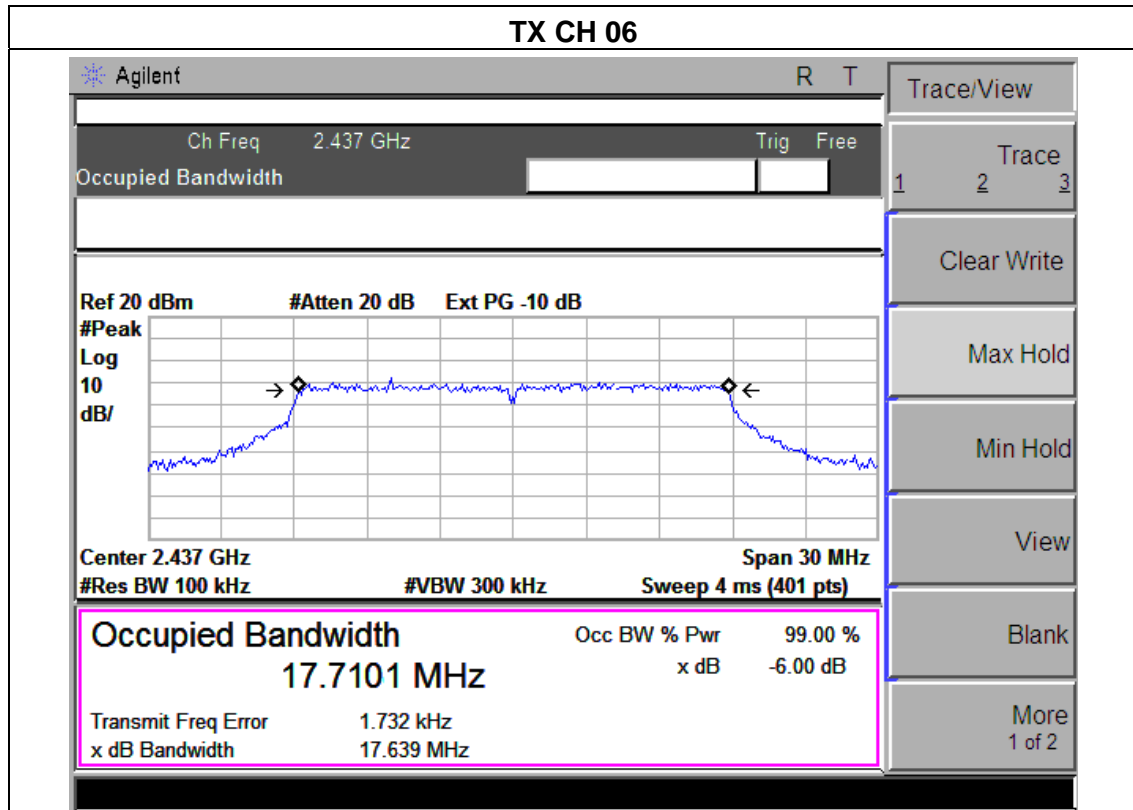



6. PEAK OUTPUT POWER TEST

6.1 APPLIED PROCEDURES / LIMIT

FCC Part15 (15.247) , Subpart C				
Section	Test Item	Limit	Frequency Range (MHz)	Result
15.247(b)(3)	Peak Output Power	1 watt or 30dBm	2400-2483.5	PASS

6.1.1 TEST PROCEDURE

- a. The EUT was directly connected to the Power meter

6.1.2 DEVIATION FROM STANDARD

No deviation.

6.1.3 TEST SETUP



6.1.4 EUT OPERATION CONDITIONS

The EUT tested system was configured as the statements of 2.4 Unless otherwise a special operating condition is specified in the follows during the testing.

**6.1.5 TEST RESULTS**

EUT :	With Wifi Touch Screen PC	Model Name :	FT15PC
Temperature :	25 °C	Relative Humidity :	60%
Pressure :	1012 hPa	Test Voltage :	AC 120V/60Hz
Test Mode :	TX b/g/n20/n40 Mode		

TX 802.11b Mode				
Test Channel	Frequency	Maximum Conducted Output Power(PK)	Maximum Conducted Output Power(AV)	LIMIT
	(MHz)	(dBm)	(dBm)	(dBm)
CH01	2412	13.35	12.88	30
CH06	2437	13.16	12.96	30
CH11	2462	13.52	12.97	30
TX 802.11g Mode				
CH01	2412	12.58	11.74	30
CH06	2437	12.72	11.86	30
CH11	2462	12.57	11.83	30
TX 802.11n-HT20 Mode				
CH01	2412	11.88	10.85	30
CH06	2437	11.83	10.62	30
CH11	2462	11.88	10.51	30

7. 100 KHZ BANDWIDTH OF FREQUENCY BAND EDGE

APPLICABLE STANDARD

In any 100 kHz bandwidth outside the frequency band in which the spread spectrum or digitally modulated intentional radiator is operating, the radio frequency power that is produced by the intentional radiator shall be at least 20 dB below that in the 100 kHz bandwidth within the band that contains the highest level of the desired power, based on either an RF conducted or a radiated measurement, provided the transmitter demonstrates compliance with the peak conducted power limits. If the transmitter complies with the conducted power limits based on the use of RMS averaging over a time interval, as permitted under paragraph (b)(3) of this section, the attenuation required under this paragraph shall be 30 dB instead of 20 dB. Attenuation below the general limits specified in §15.209(a) is not required. In addition, radiated emissions which fall in the restricted bands, as defined in §15.205(a), must also comply with the radiated emission limits specified in §15.209(a) (see §15.205(c)).

TEST PROCEDURE

- a) Check the calibration of the measuring instrument using either an internal calibrator or a known signal from an external generator.
- b) Position the EUT without connection to measurement instrument. Turn on the EUT and connect its antenna terminal to measurement instrument via a low loss cable. Then set it to any one measured frequency within its operating range, and make sure the instrument is operated in its linear range.
- c) Set RBW to 100 kHz and VBW of spectrum analyzer to 300 kHz with a convenient frequency span including 100 kHz bandwidth from band edge.
- d) Measure the highest amplitude appearing on spectral display and set it as a reference level. Plot the graph with marking the highest point and edge frequency.
- e) Repeat above procedures until all measured frequencies were complete.

7.1 DEVIATION FROM STANDARD

No deviation.

7.2 TEST SETUP

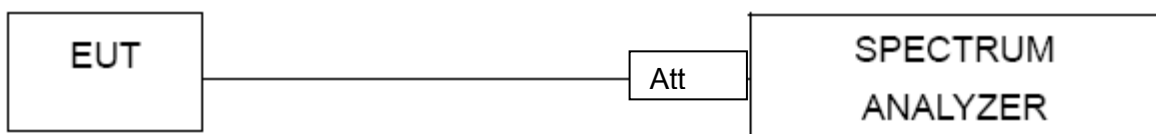

7.3 EUT OPERATION CONDITIONS

The EUT tested system was configured as the statements of 2.4 Unless otherwise a special operating condition is specified in the follows during the testing.

**7.4 TEST RESULTS**

EUT :	With Wifi Touch Screen PC	Model Name :	FT15PC
Temperature :	25 °C	Relative Humidity :	56%
Pressure :	1012 hPa	Test Voltage :	AC 120V/60Hz

Frequency Band	Delta Peak to band emission (dBc)	> Limit (dBc)	Result
802.11b			
Left-band	42.56	20	Pass
Right-band	41.38	20	Pass
802.11g			
Left-band	38.85	20	Pass
Right-band	41.36	20	Pass
802.11n20			
Left-band	43.77	20	Pass
Right-band	42.66	20	Pass
802.11n40			
Left-band	40.47	20	Pass
Right-band	39.85	20	Pass



Frequency (MHz)	Meter Reading (dBµV)	Factor (dB)	Emission Level (dBµV/m)	Limits (dBµV/m)	Margin (dB)	Detector Type	Comment
802.11b							
2390	62.74	-13.06	49.68	74	-24.32	peak	Vertical
2390	60.53	-13.06	47.47	74	-26.53	peak	Horizontal
2483.5	61.79	-12.78	49.01	74	-24.99	peak	Vertical
2483.5	63.28	-12.78	50.5	74	-23.5	peak	Horizontal
802.11g							
2390	60.82	-13.06	47.76	74	-26.24	peak	Vertical
2390	59.83	-13.06	46.77	74	-27.23	peak	Horizontal
2483.5	61.82	-12.78	49.04	74	-24.96	peak	Vertical
2483.5	59.69	-12.78	46.91	74	-27.09	peak	Horizontal
802.11n20							
2390	63.76	-13.06	50.7	74	-23.3	peak	Vertical
2390	61.15	-13.06	48.09	74	-25.91	peak	Horizontal
2483.5	59.97	-12.78	47.19	74	-26.81	peak	Vertical
2483.5	61.88	-12.78	49.1	74	-24.9	peak	Horizontal

Note: Test method to see chapter 3.2 . When PK value is lower than the Average value limit, average not record.



802.11b: Band Edge, Left Side

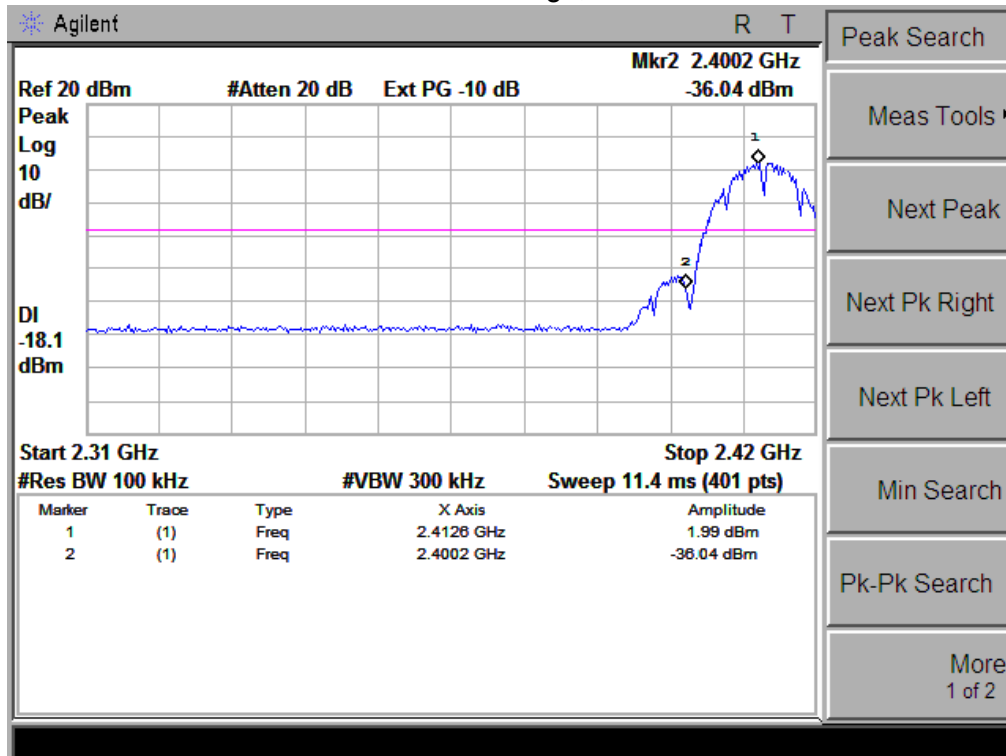

802.11b: Band Edge, Right Side

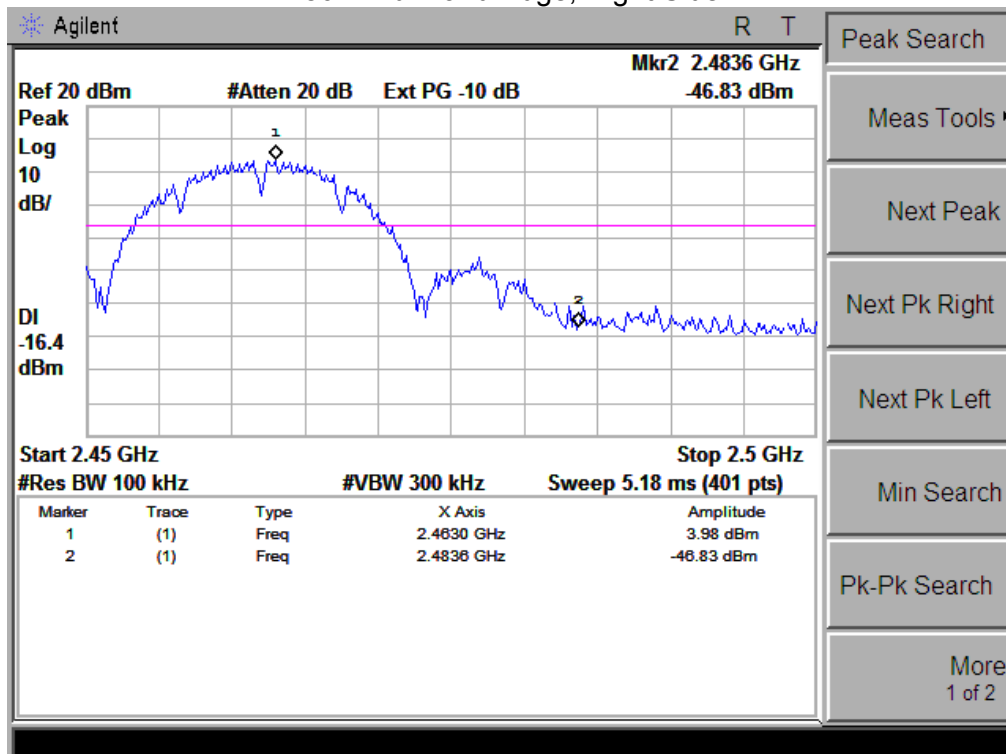



802.11g: Band Edge, Left Side

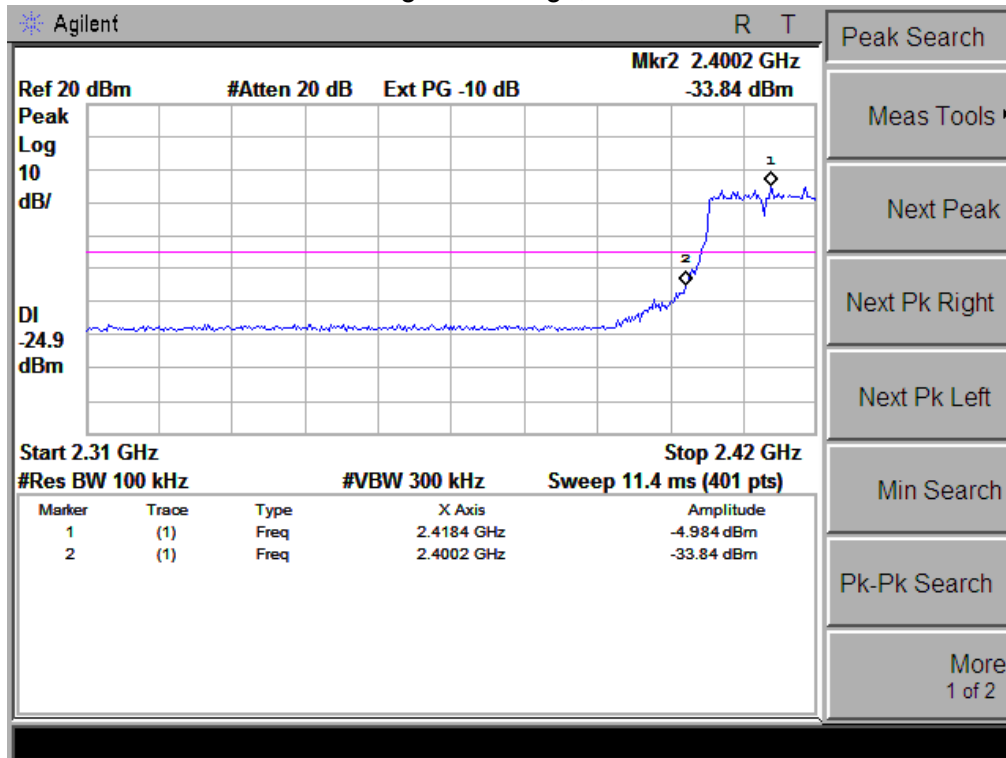

802.11g: Band Edge, Right Side

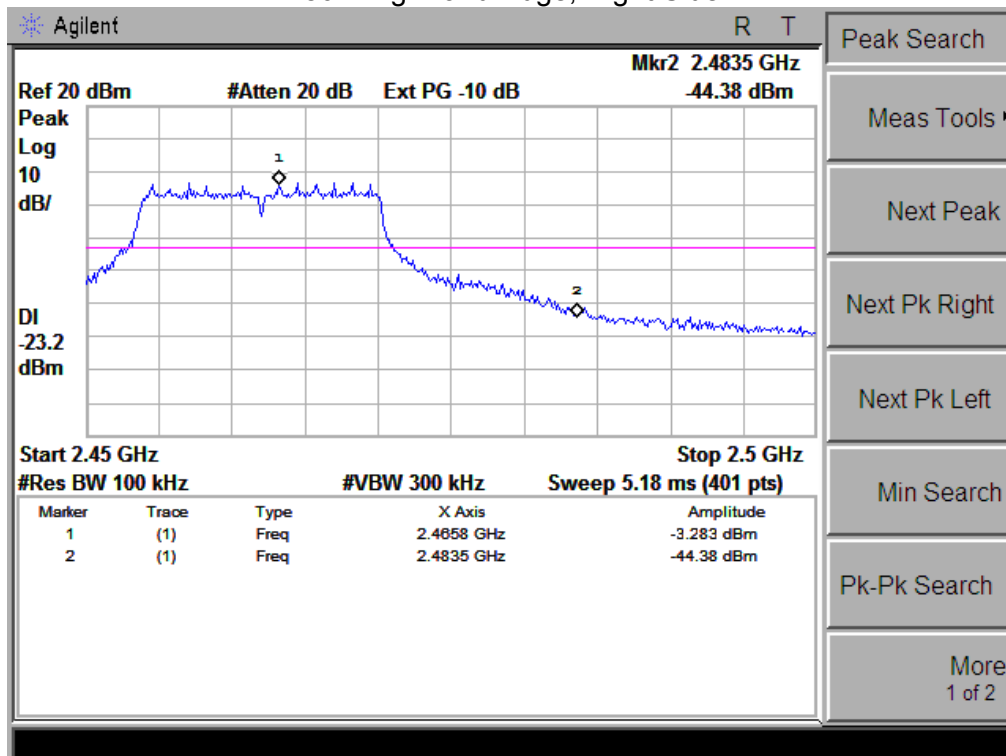



802.11n-HT20: Band Edge, Left Side

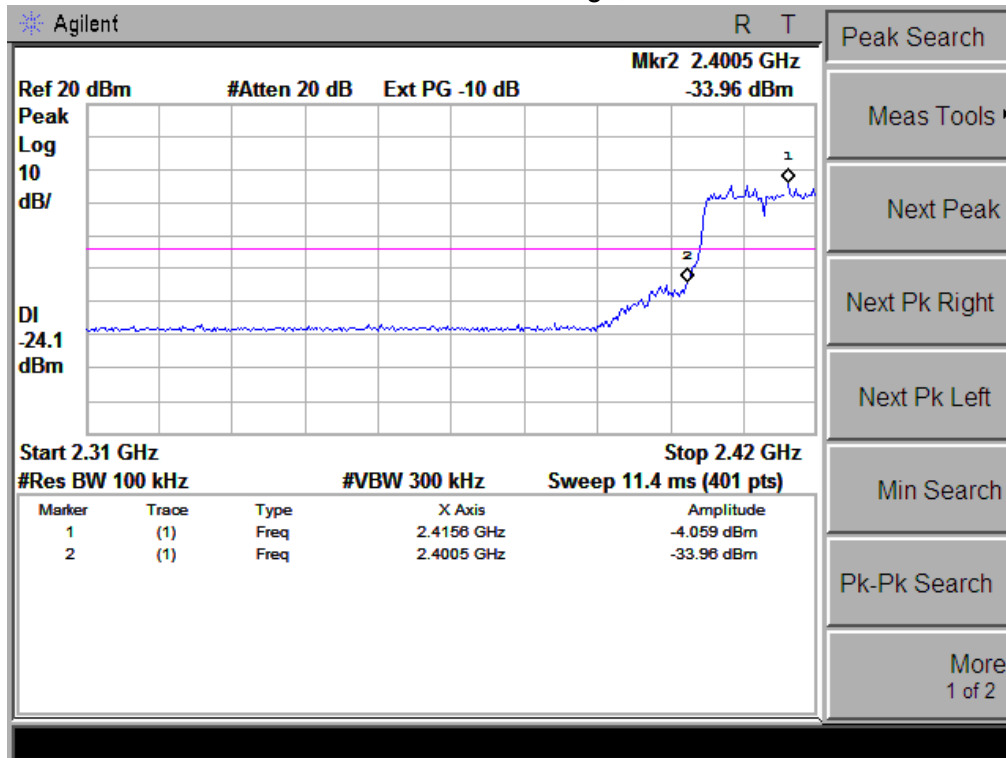

802.11n-HT20: Band Edge, Right Side

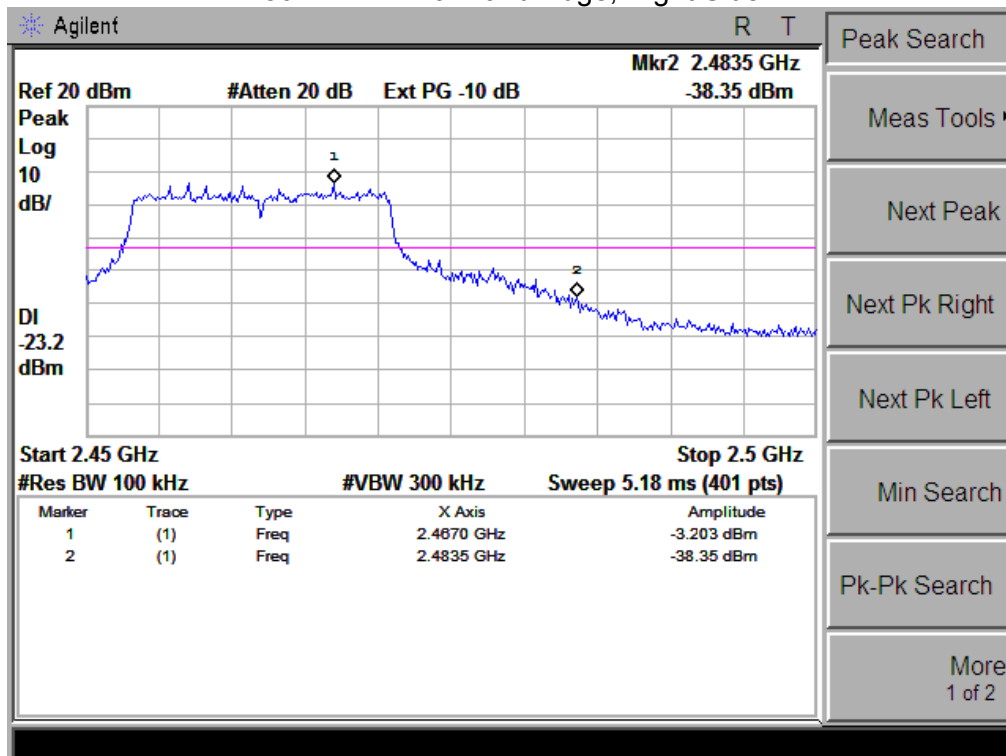



8. ANTENNA REQUIREMENT

8.1 STANDARD REQUIREMENT

15.203 requirement: For intentional device, according to 15.203: an intentional radiator shall be designed to ensure that no antenna other than that furnished by the responsible party shall be used with the device.

8.2 EUT ANTENNA

The EUT antenna is PIFA Antenna. It comply with the standard requirement.

9. EUT TEST PHOTO

Radiated Measurement Photos

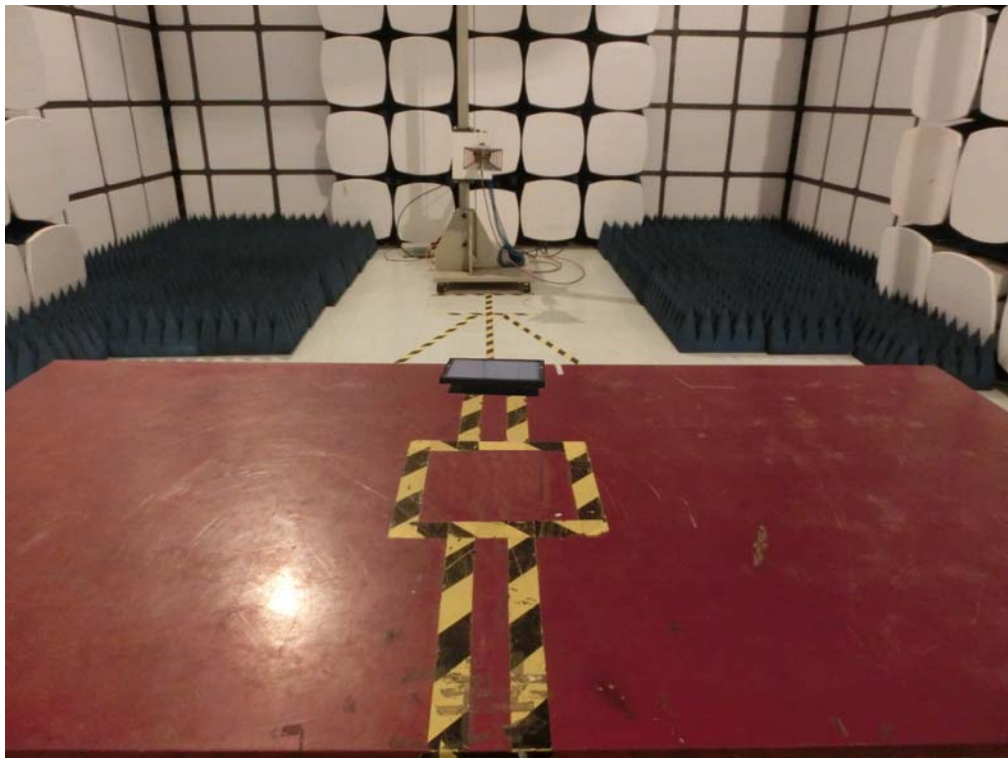
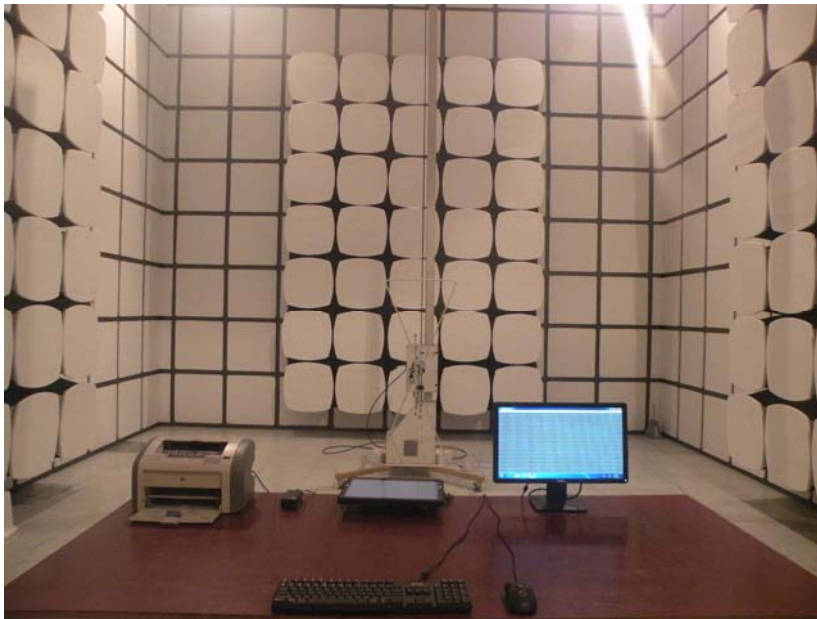



Conducted Measurement Photos

