



# FCC RADIO TEST REPORT

## FCC ID:2AC8IFTLSTK

**Product** : Large Size Touch Kiosk

**Trade Name** : faytech

**Model Name** : FT55PC

**Serial Model** : FT42PC, FT215PC, FT32PC

### Prepared for

faytech Tech. Co., Ltd.

Fl. 4, Hongmen Tech Zone, Jihua Road, Longgang District, Shenzhen, China

### Prepared by

Shenzhen Asia Test Technology Co.,Ltd.

1/6, Bldg.8, Zhonghua Industrial City, Chuangye Rd., Nanshan District,  
Shenzhen, Guangdong, China



### TEST RESULT CERTIFICATION

**Applicant's name** ..... faytech Tech. Co., Ltd.  
Address ..... Fl. 4, Hongmen Tech Zone, Jihua Road, Longgang District, Shenzhen, China

**Manufacture's Name**... faytech Tech. Co., Ltd.  
Address ..... Fl. 4, Hongmen Tech Zone, Jihua Road, Longgang District, Shenzhen, China

**Product description**

Product name ..... Large Size Touch Kiosk  
Model and/or type reference ..... FT55PC  
Serial Model ..... FT42PC, FT215PC, FT32PC

**Standards** ..... FCC Part15.247

Test procedure ..... ANSI C63.4-2003

This device described above has been tested by ATT, and the test results show that the equipment under test (EUT) is in compliance with the FCC requirements. And it is applicable only to the tested sample identified in the report.

This report shall not be reproduced except in full, without the written approval of ATT, this document may be altered or revised by ATT, personal only, and shall be noted in the revision of the document.

**Date of Test** .....

Date (s) of performance of tests ..... Nov 11, 2014 ~ Nov 18, 2014

Date of Issue..... Nov 18, 2014

Test Result..... **Pass**

Testing Engineer : *Eric Wang*  
(Eric Wang)

Technical Manager : *Jerry You*  
(Jerry You)

Authorized Signatory : *Jack Yu*  
(Jack Yu)

**Table of Contents**

	<b>Page</b>
<b>1 . SUMMARY OF TEST RESULTS</b>	<b>5</b>
1.1 TEST FACILITY	6
1.2 MEASUREMENT UNCERTAINTY	6
<b>2 . GENERAL INFORMATION</b>	<b>7</b>
2.1 GENERAL DESCRIPTION OF EUT	7
2.2 DESCRIPTION OF TEST MODES	9
2.3 BLOCK DIGRAM SHOWING THE CONFIGURATION OF SYSTEM TESTED	10
2.4 DESCRIPTION OF SUPPORT UNITS(CONDUCTED MODE)	11
2.5 EQUIPMENTS LIST FOR ALL TEST ITEMS	12
<b>3 . EMC EMISSION TEST</b>	<b>13</b>
3.1 CONDUCTED EMISSION MEASUREMENT	13
3.1.1 POWER LINE CONDUCTED EMISSION LIMITS	13
3.1.2 TEST PROCEDURE	14
3.1.3 DEVIATION FROM TEST STANDARD	14
3.1.4 TEST SETUP	14
3.1.5 EUT OPERATING CONDITIONS	14
3.1.6 TEST RESULTS	15
3.2 RADIATED EMISSION MEASUREMENT	17
3.2.1 RADIATED EMISSION LIMITS	17
3.2.2 TEST PROCEDURE	18
3.2.3 DEVIATION FROM TEST STANDARD	18
3.2.4 TEST SETUP	19
3.2.5 EUT OPERATING CONDITIONS	20
3.2.6 TEST RESULTS (BETWEEN 9KHZ – 30 MHZ)	21
3.2.7 TEST RESULTS (BETWEEN 30MHZ – 1GHZ)	22
3.2.8 TEST RESULTS (ABOVE 1000 MHZ)	23
<b>4 . POWER SPECTRAL DENSITY TEST</b>	<b>36</b>
4.1 APPLIED PROCEDURES / LIMIT	36
4.1.1 TEST PROCEDURE	36
4.1.2 DEVIATION FROM STANDARD	36
4.1.3 TEST SETUP	36
4.1.4 EUT OPERATION CONDITIONS	36
4.1.5 TEST RESULTS	37
<b>5 . BANDWIDTH TEST</b>	<b>41</b>



<b>Table of Contents</b>	
	<b>Page</b>
<b>5.1 APPLIED PROCEDURES / LIMIT</b>	<b>41</b>
<b>5.1.1 TEST PROCEDURE</b>	<b>41</b>
<b>5.1.2 EUT OPERATION CONDITIONS</b>	<b>41</b>
<b>5.1.3 TEST RESULTS</b>	<b>42</b>
<b>6 . PEAK OUTPUT POWER TEST</b>	<b>47</b>
<b>6.1 APPLIED PROCEDURES / LIMIT</b>	<b>47</b>
<b>6.1.1 TEST PROCEDURE</b>	<b>47</b>
<b>6.1.2 DEVIATION FROM STANDARD</b>	<b>47</b>
<b>6.1.3 TEST SETUP</b>	<b>47</b>
<b>6.1.4 EUT OPERATION CONDITIONS</b>	<b>47</b>
<b>6.1.5 TEST RESULTS</b>	<b>48</b>
<b>7 . 100 KHZ BANDWIDTH OF FREQUENCY BAND EDGE</b>	<b>49</b>
<b>7.1 DEVIATION FROM STANDARD</b>	<b>49</b>
<b>7.2 TEST SETUP</b>	<b>49</b>
<b>7.3 EUT OPERATION CONDITIONS</b>	<b>49</b>
<b>7.4 TEST RESULTS</b>	<b>51</b>
<b>8 . ANTENNA REQUIREMENT</b>	<b>54</b>
<b>8.1 STANDARD REQUIREMENT</b>	<b>54</b>
<b>8.2 EUT ANTENNA</b>	<b>54</b>
<b>9 . EUT TEST PHOTO</b>	<b>55</b>
<b>APPENDIX-PHOTOGRAPHS OF EUT CONSTRUCTIONAL DETAILS</b>	



## 1. SUMMARY OF TEST RESULTS

Test procedures according to the technical standards:

<b>FCC Part15 (15.247) , Subpart C</b>			
Standard Section	Test Item	Judgment	Remark
15.207	Conducted Emission	PASS	
15.247 (a)(2)	6dB Bandwidth	PASS	
15.247 (b)	Peak Output Power	PASS	
15.247 (c)	Radiated Spurious Emission	PASS	
15.247 (d)	Power Spectral Density	PASS	
15.205	Band Edge Emission	PASS	
15.203	Antenna Requirement	PASS	

**NOTE:**

(1) "N/A" denotes test is not applicable in this Test Report



## 1.1 TEST FACILITY

Shenzhen STONE Testing Technology Co.,Ltd.

Add.: F/6, Bldg.12, Zhongxing Industrial City, Chuangye Rd., Nanshan District Shenzhen P.R. China

FCC Registration No.: 323508; IC Registration No.: 11043A

## 1.2 MEASUREMENT UNCERTAINTY

The reported uncertainty of measurement  $y \pm U$ , where expanded uncertainty  $U$  is based on a standard uncertainty multiplied by a coverage factor of  $k=2$ , providing a level of confidence of approximately **95 %**.

No.	Item	Uncertainty
1	Conducted Emission Test	$\pm 1.38\text{dB}$
2	RF power,conducted	$\pm 0.16\text{dB}$
3	Spurious emissions,conducted	$\pm 0.21\text{dB}$
4	All emissions,radiated(<1G)	$\pm 4.68\text{dB}$
5	All emissions,radiated(>1G)	$\pm 4.89\text{dB}$
6	Temperature	$\pm 0.5^{\circ}\text{C}$
7	Humidity	$\pm 2\%$



## 2. GENERAL INFORMATION

### 2.1 GENERAL DESCRIPTION OF EUT

Equipment	Large Size Touch Kiosk														
Model Name	FT55PC														
Serial Model	FT42PC, FT215PC, FT32PC														
Model Difference	All the models are the same circuit and RF module, except model name.														
Product Description	<p>The EUT is a Large Size Touch Kiosk</p> <table border="1"> <tr> <td>Operation Frequency:</td> <td>802.11b/g: 2412~2462MHz</td> </tr> <tr> <td>Modulation Type:</td> <td>CCK/OFDM/DBPSK/DAPSK</td> </tr> <tr> <td>Bit Rate of Transmitter</td> <td>802.11b:11/5.5/2/1 Mbps 802.11g:54/48/36/24/18/12/9/6Mbps</td> </tr> <tr> <td>Number Of Channel</td> <td>802.11b/g:11CH</td> </tr> <tr> <td>Antenna Designation:</td> <td>Please see Note 3.</td> </tr> <tr> <td>Output Power(Conducted):</td> <td>802.11b: 9.50 dBm (Max.) 802.11g: 8.78dBm (Max.)</td> </tr> <tr> <td>Antenna Gain (dBi)</td> <td>2.10dbi</td> </tr> </table> <p>Based on the application, features, or specification exhibited in User's Manual, the EUT is considered as an ITE/Computing Device. More details of EUT technical specification, please refer to the User's Manual.</p>	Operation Frequency:	802.11b/g: 2412~2462MHz	Modulation Type:	CCK/OFDM/DBPSK/DAPSK	Bit Rate of Transmitter	802.11b:11/5.5/2/1 Mbps 802.11g:54/48/36/24/18/12/9/6Mbps	Number Of Channel	802.11b/g:11CH	Antenna Designation:	Please see Note 3.	Output Power(Conducted):	802.11b: 9.50 dBm (Max.) 802.11g: 8.78dBm (Max.)	Antenna Gain (dBi)	2.10dbi
Operation Frequency:	802.11b/g: 2412~2462MHz														
Modulation Type:	CCK/OFDM/DBPSK/DAPSK														
Bit Rate of Transmitter	802.11b:11/5.5/2/1 Mbps 802.11g:54/48/36/24/18/12/9/6Mbps														
Number Of Channel	802.11b/g:11CH														
Antenna Designation:	Please see Note 3.														
Output Power(Conducted):	802.11b: 9.50 dBm (Max.) 802.11g: 8.78dBm (Max.)														
Antenna Gain (dBi)	2.10dbi														
Channel List	Please refer to the Note 2.														
Ratings	AC100-240V, 4 A, 50/60 Hz														
Adapter	Input: AC100-240V, 4 A, 50/60 Hz Output: DC 24V, 9.2A														
Battery	N/A														

Note:

1. For a more detailed features description, please refer to the manufacturer's specifications or the User's Manual.
- 2.

Channel List for 802.11b/g							
Channel	Frequency (MHz)	Channel	Frequency (MHz)	Channel	Frequency (MHz)	Channel	Frequency (MHz)
01	2412	04	2427	07	2442	10	2457
02	2417	05	2432	08	2447	11	2462
03	2422	06	2437	09	2452		



3.

Table for Filed Antenna

Ant	Brand	Model Name	Antenna Type	Connector	Gain (dBi)	NOTE
A	N/A	N/A	Dipole	N/A	2.10	Wifi Antenna





## 2.2 DESCRIPTION OF TEST MODES

To investigate the maximum EMI emission characteristics generated from EUT, the test system was pre-scanning tested based on the consideration of following EUT operation mode or test configuration mode which possibly have effect on EMI emission level. Each of these EUT operation mode(s) or test configuration mode(s) mentioned above was evaluated respectively.

Pretest Mode	Description
Mode 1	802.11b CH1/ CH6/ CH11
Mode 2	802.11g CH1/ CH6/ CH11
Mode 3	Link Mode

For Conducted Emission	
Final Test Mode	Description
Mode 3	Link Mode

For Radiated Emission	
Final Test Mode	Description
Mode 1	802.11b CH1/ CH6/ CH11
Mode 2	802.11g CH1/ CH6/ CH11

Note:

- (1) The measurements are performed at the highest, middle, lowest available channels.
- (2) The measurements are performed at all Bit Rate of Transmitter, the worst data was reported. The EUT was programmed to be in continuously transmitting mode and the transmit duty cycle is not less than 98%.



### 2.3 BLOCK DIGRAM SHOWING THE CONFIGURATION OF SYSTEM TESTED

Conducted Emission Test

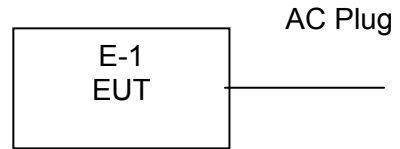

Radiated Spurious Emission Test

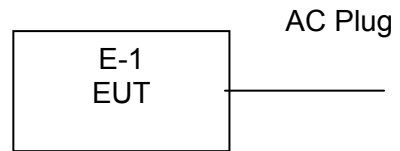



## 2.4 DESCRIPTION OF SUPPORT UNITS(CONDUCTED MODE)

The EUT has been tested as an independent unit together with other necessary accessories or support units. The following support units or accessories were used to form a representative test configuration during the tests.

Item	Equipment	Brand	Model/Type No.	Series No.	Note
E-1	Large Size Touch Kiosk	faytech	FT55PC	N/A	EUT

Item	Shielded Type	Ferrite Core	Length	Note
C-1	NO	NO	1.2m	

Note:

- (1) The support equipment was authorized by Declaration of Confirmation.
- (2) For detachable type I/O cable should be specified the length in cm in 『Length』 column.



## 2.5 EQUIPMENTS LIST FOR ALL TEST ITEMS

### Radiation Test equipment

Item	Kind of Equipment	Manufacturer	Type No.	Serial No.	Last calibration	Calibrated until	Calibration period
1	Spectrum Analyzer	Agilent	E4407B	MY45108040	2014.07.06	2015.07.05	1 year
2	Test Receiver	R&S	ESPI	101318	2014.06.07	2015.06.06	1 year
3	Bilog Antenna	TESEQ	CBL6111D	31216	2014.07.06	2015.07.05	1 year
4	50Ω Coaxial Switch	Anritsu	MP59B	6200264416	2014.06.07	2015.06.06	1 year
5	Spectrum Analyzer	ADVANTEST	R3132	150900201	2014.06.07	2015.06.06	1 year
6	Horn Antenna	EM	EM-AH-10180	2011071402	2014.07.06	2015.07.05	1 year
7	Horn Ant	Schwarzbeck	BBHA 9170	9170-181	2014.07.06	2015.07.05	1 year
8	Amplifier	EM	EM-30180	060538	2013.12.22	2014.12.21	1 year
9	Loop Antenna	ARA	PLA-1030/B	1029	2014.06.08	2015.06.07	1 year
10	Power Meter	R&S	NRVS	100696	2014.07.06	2015.07.05	1 year
11	Power Sensor	R&S	URV5-Z4	0395.1619.05	2014.07.06	2015.07.05	1 year
12	Power Meter	Anristu	ML2495A	1145054	2014.08.16	2015.08.15	1 year
13	Power Sensor	Anristu	MA2411B	1126096	2014.08.16	2015.08.15	1 year
14	Cable 1-26GHz	R&S	ATT-R02	201309R048	2014.06.08	2015.06.07	1 year

### Conduction Test equipment

Item	Kind of Equipment	Manufacturer	Type No.	Serial No.	Last calibration	Calibrated until	Calibration period
1	Test Receiver	R&S	ESCI	101160	2014.06.06	2015.06.05	1 year
2	LISN	R&S	ENV216	101313	2014.08.24	2015.08.23	1 year
3	LISN	EMCO	3816/2	00042990	2014.08.24	2015.08.23	1 year
4	50Ω Coaxial Switch	Anritsu	MP59B	6200264417	2014.06.07	2015.06.06	1 year
5	Passive Voltage Probe	R&S	ESH2-Z3	100196	2014.06.07	2015.06.06	1 year
6	Absorbing clamp	R&S	MOS-21	100423	2014.06.08	2015.06.07	1 year
7	Attenuation	MCE	24-10-34	BN9258	2014.06.08	2015.06.07	1 year
8	Cable 0.009-30MHz	R&S	ATT-C01	201309C006	2014.06.08	2015.06.07	1 year



### 3. EMC EMISSION TEST

#### 3.1 CONDUCTED EMISSION MEASUREMENT

##### 3.1.1 POWER LINE CONDUCTED EMISSION Limits (Frequency Range 150KHz-30MHz)

FREQUENCY (MHz)	Class A (dBuV)		Class B (dBuV)		Standard
	Quasi-peak	Average	Quasi-peak	Average	
0.15 -0.5	79.00	66.00	66 - 56 *	56 - 46 *	CISPR
0.50 -5.0	73.00	60.00	56.00	46.00	CISPR
5.0 -30.0	73.00	60.00	60.00	50.00	CISPR

0.15 -0.5	79.00	66.00	66 - 56 *	56 - 46 *	FCC
0.50 -5.0	73.00	60.00	56.00	46.00	FCC
5.0 -30.0	73.00	60.00	60.00	50.00	FCC

Note:

- (1) The tighter limit applies at the band edges.
- (2) The limit of " \* " marked band means the limitation decreases linearly with the logarithm of the frequency in the range.

The following table is the setting of the receiver

Receiver Parameters	Setting
Attenuation	10 dB
Start Frequency	0.15 MHz
Stop Frequency	30 MHz
IF Bandwidth	9 kHz



### 3.1.2 TEST PROCEDURE

- a. The EUT was placed 0.8 meters from the horizontal ground plane with EUT being connected to the power mains through a line impedance stabilization network (LISN). All other support equipments powered from additional LISN(s). The LISN provide 50 Ohm/ 50uH of coupling impedance for the measuring instrument.
- b. Interconnecting cables that hang closer than 40 cm to the ground plane shall be folded back and forth in the center forming a bundle 30 to 40 cm long.
- c. I/O cables that are not connected to a peripheral shall be bundled in the center. The end of the cable may be terminated, if required, using the correct terminating impedance. The overall length shall not exceed 1 m.
- d. LISN at least 80 cm from nearest part of EUT chassis.
- e. For the actual test configuration, please refer to the related Item –EUT Test Photos.

### 3.1.3 DEVIATION FROM TEST STANDARD

No deviation

### 3.1.4 TEST SETUP

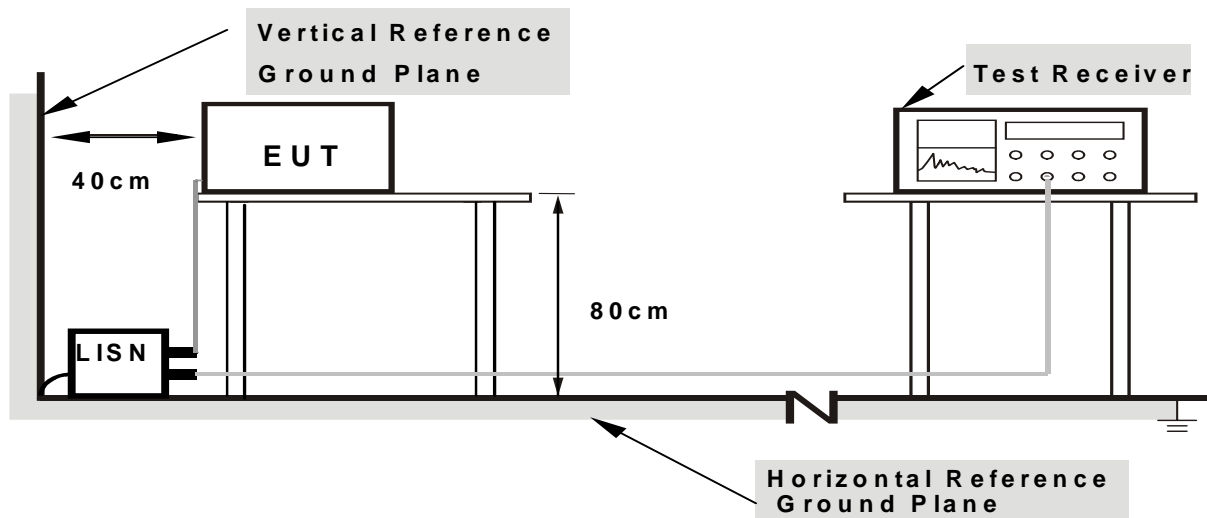

Note: 1. Support units were connected to second LISN.

2. Both of LISNs (AMN) are 80 cm from EUT and at least 80 cm from other units and other metal planes

### 3.1.5 EUT OPERATING CONDITIONS

The EUT was configured for testing in a typical fashion (as a customer would normally use it). The EUT has been programmed to continuously transmit during test. This operating condition was tested and used to collect the included data.



**3.1.6 TEST RESULTS**

EUT :	Large Size Touch Kiosk	Model Name. :	FT55PC
Temperature :	26 °C	Relative Humidity :	56%
Pressure :	1010hPa	Phase :	L
Test Voltage :	AC 120V/60Hz	Test Mode :	Mode 3

Freq. (MHz)	Reading (dBuV)	Factor (dBuV)	Measurement (dBuV)	Limit (dBuV)	Over (dB)	Detector
0.1860	36.41	10.44	46.85	64.21	-17.36	QP
0.2660	25.55	10.43	35.98	51.24	-15.26	AVG
0.6220	27.70	10.41	38.11	46.00	-7.89	AVG
0.6419	40.49	10.41	50.90	56.00	-5.10	QP
6.7419	40.11	10.66	50.77	60.00	-9.23	QP
6.8539	27.73	10.68	38.41	50.00	-11.59	AVG

Remark:

1. All readings are Quasi-Peak and Average values.
2. Factor = Insertion Loss + Cable Loss.
3. N/A means All Data have pass Limit

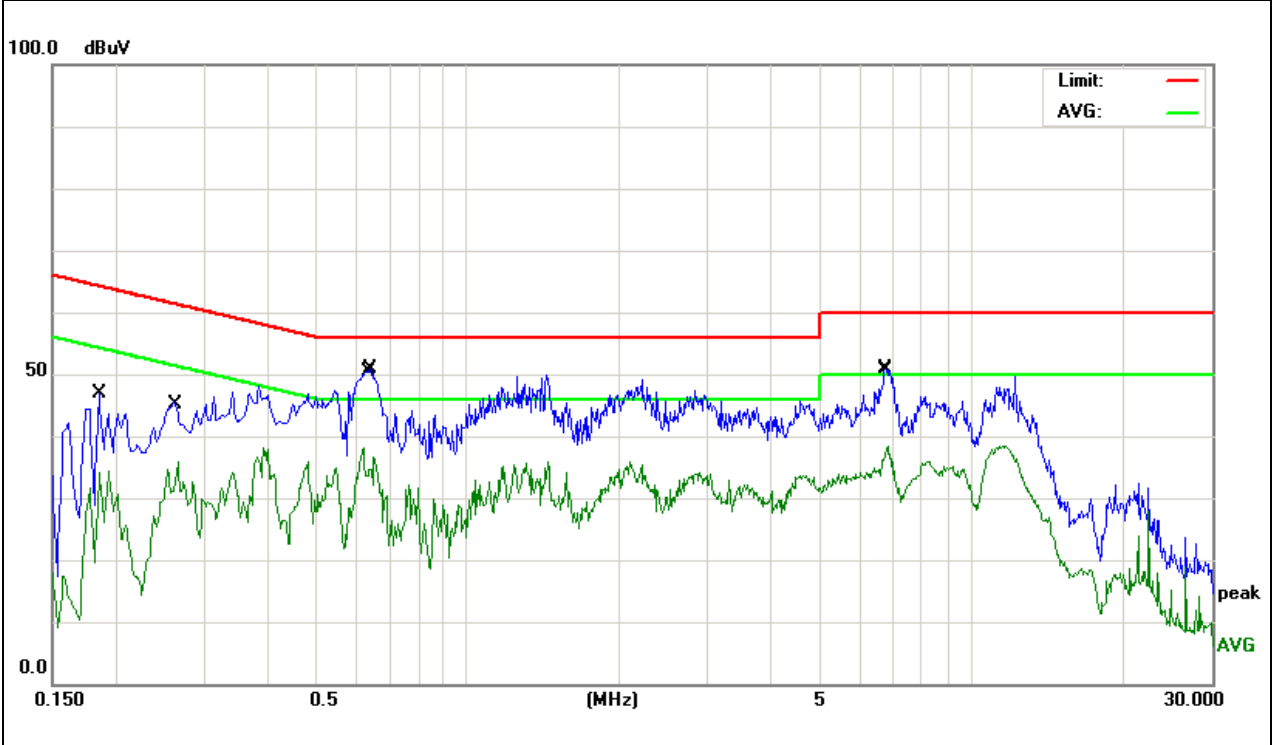



EUT :	Large Size Touch Kiosk	Model Name. :	FT55PC
Temperature :	26 °C	Relative Humidity :	56%
Pressure :	1010hPa	Phase :	N
Test Voltage :	AC 120V/60Hz	Test Mode :	Mode 3

Freq. (MHz)	Reading (dBuV)	Factor (dBuV)	Measurement (dBuV)	Limit (dBuV)	Over (dB)	Detector
0.1900	36.96	10.44	47.40	64.03	-16.63	QP
0.2020	23.90	10.44	34.34	53.52	-19.18	AVG
0.6220	27.25	10.41	37.66	46.00	-8.34	AVG
0.6460	41.61	10.41	52.02	56.00	-3.98	QP
6.7179	39.49	10.66	50.15	60.00	-9.85	QP
6.7739	26.78	10.68	37.46	50.00	-12.54	AVG

Remark:

1. All readings are Quasi-Peak and Average values.
2. Factor = Insertion Loss + Cable Loss.
3. N/A means All Data have pass Limit

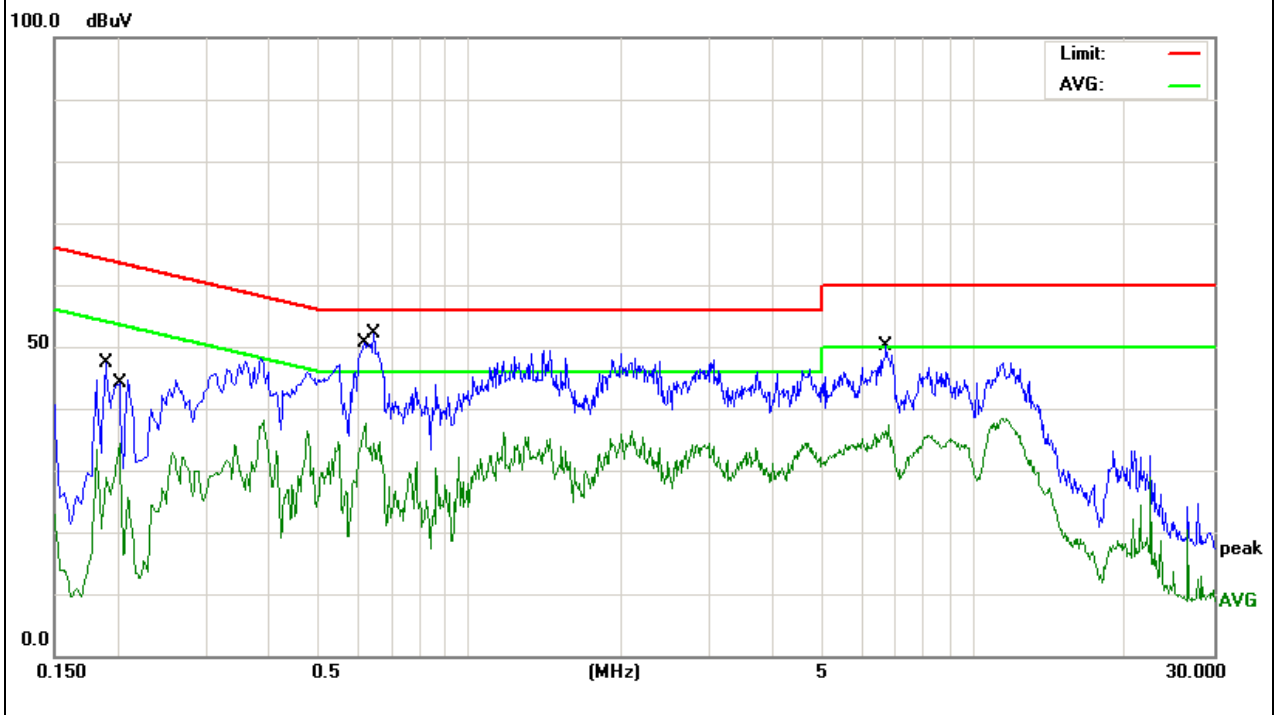





### 3.2 RADIATED EMISSION MEASUREMENT

#### 3.2.1 RADIATED EMISSION LIMITS (Frequency Range 9kHz-1000MHz)

20dBc in any 100 kHz bandwidth outside the operating frequency band. In case the emission fall within the restricted band specified on 15.205(a), then the 15.209(a) limit in the table below has to be followed.

Frequencies (MHz)	Field Strength (micorvolts/meter)	Measurement Distance (meters)
0.009~0.490	2400/F(KHz)	300
0.490~1.705	24000/F(KHz)	30
1.705~30.0	30	30
30~88	100	3
88~216	150	3
216~960	200	3
Above 960	500	3

#### LIMITS OF RADIATED EMISSION MEASUREMENT (Above 1000MHz)

FREQUENCY (MHz)	Class A (dBuV/m) (at 3M)		Class B (dBuV/m) (at 3M)	
	PEAK	AVERAGE	PEAK	AVERAGE
Above 1000	80	60	74	54

Notes:

- (1) The limit for radiated test was performed according to FCC PART 15C.
- (2) The tighter limit applies at the band edges.
- (3) Emission level (dBuV/m)=20log Emission level (uV/m).

Spectrum Parameter	Setting
Attenuation	Auto
Start Frequency	1000 MHz
Stop Frequency	10th carrier harmonic
RB / VB (emission in restricted band)	1 MHz / 1 MHz for Peak, 1 MHz / 10Hz for Average

Receiver Parameter	Setting
Attenuation	Auto
Start ~ Stop Frequency	9kHz~150kHz / RB 200Hz for QP
Start ~ Stop Frequency	150kHz~30MHz / RB 9kHz for QP
Start ~ Stop Frequency	30MHz~1000MHz / RB 120kHz for QP



### 3.2.2 TEST PROCEDURE

- a. The measuring distance of at 3 m shall be used for measurements at frequency up to 1GHz. For frequencies above 1GHz, any suitable measuring distance may be used.
- b. The EUT was placed on the top of a rotating table 0.8 meters above the ground at a 3 meter open area test site. The table was rotated 360 degrees to determine the position of the highest radiation.
- c. The height of the equipment or of the substitution antenna shall be 0.8 m; the height of the test antenna shall vary between 1 m to 4 m. Both horizontal and vertical polarizations of the antenna are set to make the measurement.
- d. The initial step in collecting conducted emission data is a spectrum analyzer peak detector mode pre-scanning the measurement frequency range. Significant peaks are then marked and then Quasi Peak detector mode re-measured.
- e. If the Peak Mode measured value compliance with and lower than Quasi Peak Mode Limit, the EUT shall be deemed to meet QP Limits and then no additional QP Mode measurement performed.
- f. For the actual test configuration, please refer to the related Item –EUT Test Photos.

Note:

Both horizontal and vertical antenna polarities were tested and performed pretest to three orthogonal axis. The worst case emissions were reported

### 3.2.3 DEVIATION FROM TEST STANDARD

No deviation

### 3.2.4 TEST SETUP

#### (A) Radiated Emission Test-Up Frequency Below 30MHz

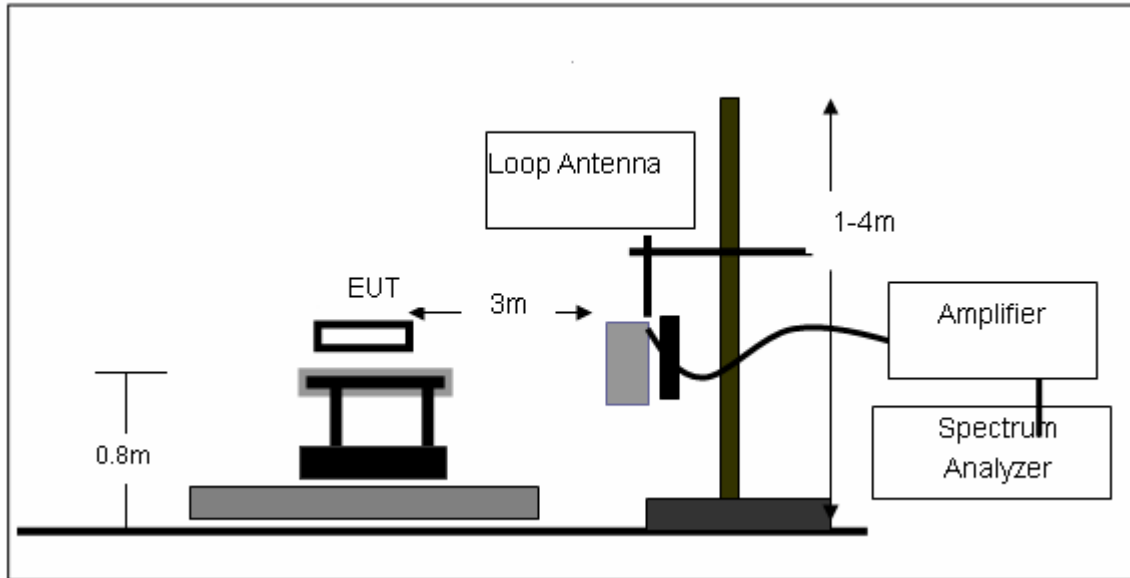

#### (B) Radiated Emission Test-Up Frequency 30MHz~1GHz

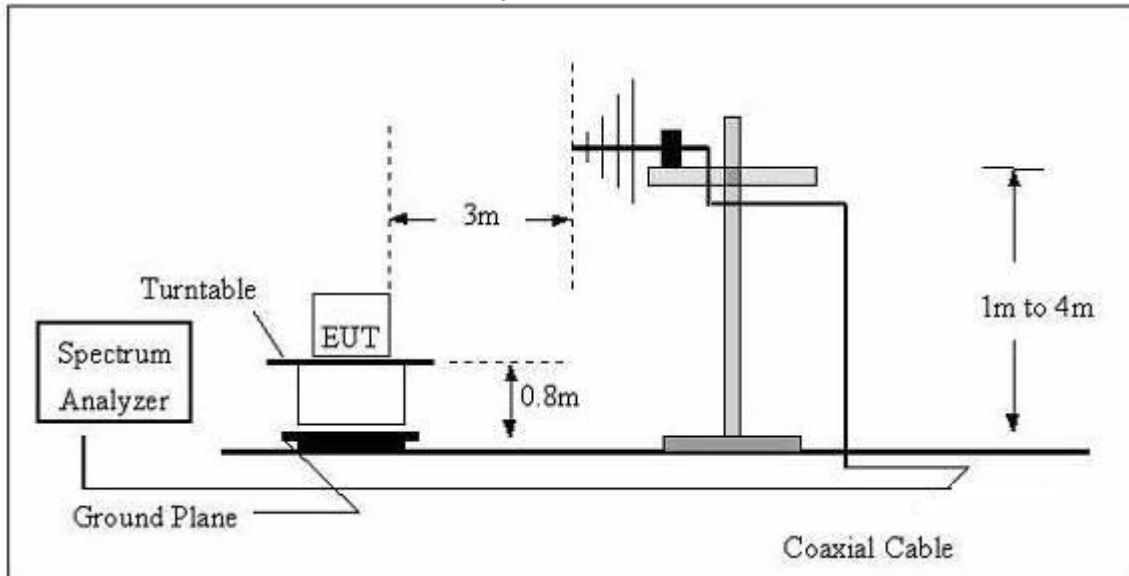

## (C) Radiated Emission Test-Up Frequency Above 1GHz

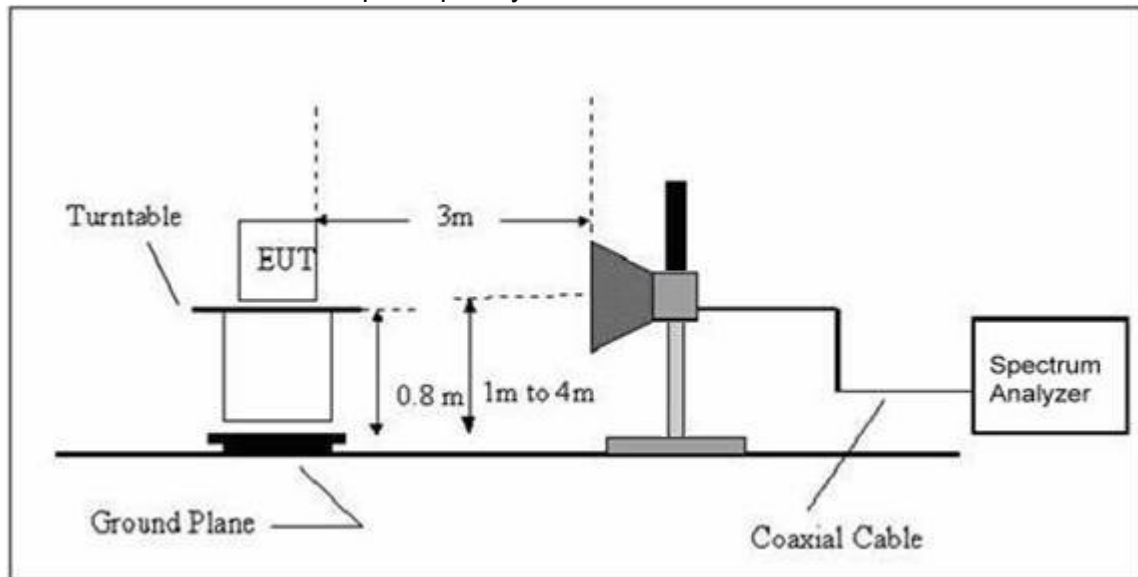
**3.2.5 EUT OPERATING CONDITIONS**

The EUT tested system was configured as the statements of 2.4 Unless otherwise a special operating condition is specified in the follows during the testing.

**3.2.6 TEST RESULTS (BETWEEN 9KHZ – 30 MHZ)**

EUT:	Large Size Touch Kiosk	Model Name. :	FT55PC
Temperature:	20 °C	Relative Humidity:	48%
Pressure:	1010 hPa	Test Voltage :	AC 120V/60Hz
Test Mode :	TX	Polarization :	--

Freq. (MHz)	Reading (dBuV/m)	Limit (dBuV/m)	Margin (dB)	State P/F
--	--	--	--	P
--	--	--	--	P

**NOTE:**

The amplitude of spurious emissions which are attenuated by more than 20dB below the permissible value has no need to be reported.

Distance extrapolation factor =  $40 \log (\text{specific distance}/\text{test distance})$ (dB);

Limit line = specific limits(dBuv) + distance extrapolation factor.

**3.2.7 TEST RESULTS (BETWEEN 30MHZ – 1GHZ)**

EUT :	Large Size Touch Kiosk	Model Name :	FT55PC
Temperature :	20 °C	Relative Humidity :	48%
Pressure:	1010 hPa	Test Voltage :	AC 120V/60Hz
Test Mode :	TX		

Frequency (MHz)	Meter Reading (dB $\mu$ V)	Factor (dB)	Emission Level (dB $\mu$ V/m)	Limits (dB $\mu$ V/m)	Margin (dB)	Detect or Type	Comment
Below 1G							
33.36	22.63	8.87	31.5	40	-8.5	QP	Vertical
121.65	23.52	10.99	34.51	43.5	-8.99	QP	Vertical
276.35	26.73	11.46	38.19	46	-7.81	QP	Vertical
368.54	22.19	15.77	37.96	46	-8.04	QP	Vertical
449.92	17.94	22.69	40.63	46	-5.37	QP	Vertical
561.04	15.77	23.71	39.48	46	-6.52	QP	Vertical
99.64	23.26	9.74	33	40	-7	QP	Horizontal
105.36	23.62	10.64	34.26	40	-5.74	QP	Horizontal
198.74	24.11	11.52	35.63	43.5	-7.87	QP	Horizontal
241.04	21.84	12.53	34.37	46	-11.63	QP	Horizontal
360.73	25.72	15.37	41.09	46	-4.91	QP	Horizontal
480.58	21.07	18.34	39.41	46	-6.59	QP	Horizontal



**3.2.8 TEST RESULTS (ABOVE 1000 MHZ)**

Frequency (MHz)	Meter Reading (dBµV)	Factor (dB)	Emission Level (dBµV/m)	Limits (dBµV/m)	Margin (dB)	Detect or Type	Comment
Low Channel (2412 MHz)-Above 1G							
4824.25	56.85	10.44	67.29	74	-6.71	Pk	Vertical
4824.25	40.63	10.44	51.07	54	-2.93	Av	Vertical
7235.02	54.12	12.39	66.51	74	-7.49	Pk	Vertical
7235.02	39.88	12.39	52.27	54	-1.73	Av	Vertical
4824.78	52.68	10.44	63.12	74	-10.88	Pk	Horizontal
4824.78	37.76	10.44	48.2	54	-5.8	Av	Horizontal
7236.81	50.33	12.39	62.72	74	-11.28	Pk	Horizontal
7236.81	34.27	12.39	46.66	54	-7.34	Av	Horizontal
Mid Channel (2437 MHz)-Above 1G							
4874.46	56.56	10.4	66.96	74	-7.04	Pk	Vertical
4874.46	40.11	10.4	50.51	54	-3.49	Av	Vertical
7311.51	54.83	12.75	67.58	74	-6.42	Pk	Vertical
7311.51	39.04	12.75	51.79	54	-2.21	Av	Vertical
4874.77	52.85	10.4	63.25	74	-10.75	Pk	Horizontal
4874.77	36.82	10.4	47.22	54	-6.78	Av	Horizontal
7311.89	50.17	12.75	62.92	74	-11.08	Pk	Horizontal
7311.89	33.84	12.75	46.59	54	-7.41	Av	Horizontal
High Channel (2462 MHz)- Above 1G							
4924.56	54.73	10.39	65.12	74	-8.88	Pk	Vertical
4924.56	40.36	10.39	50.75	54	-3.25	Av	Vertical
7386.82	52.63	12.68	65.31	74	-8.69	Pk	Vertical
7386.82	38.74	12.68	51.42	54	-2.58	Av	Vertical
4924.38	50.73	10.39	61.12	74	-12.88	Pk	Horizontal
4924.38	36.72	10.39	47.11	54	-6.89	Av	Horizontal
7386.22	47.34	12.68	60.02	74	-13.98	Pk	Horizontal
7386.22	33.56	12.68	46.24	54	-7.76	Av	Horizontal

Note: "802.11b" mode is the worst mode.



### Conducted Spurious Emissions at Antenna Port: 802.11b Low Channel

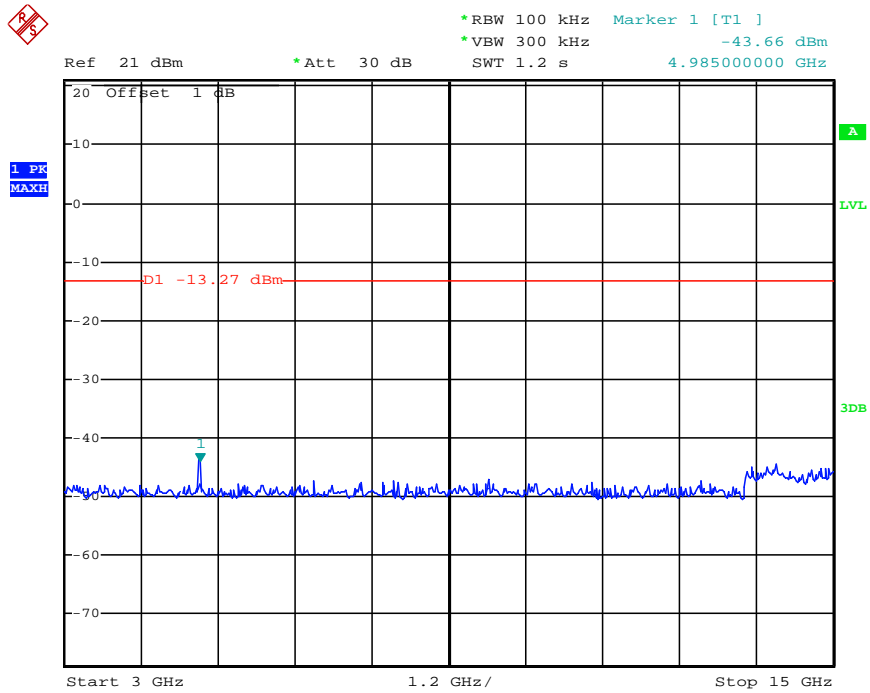
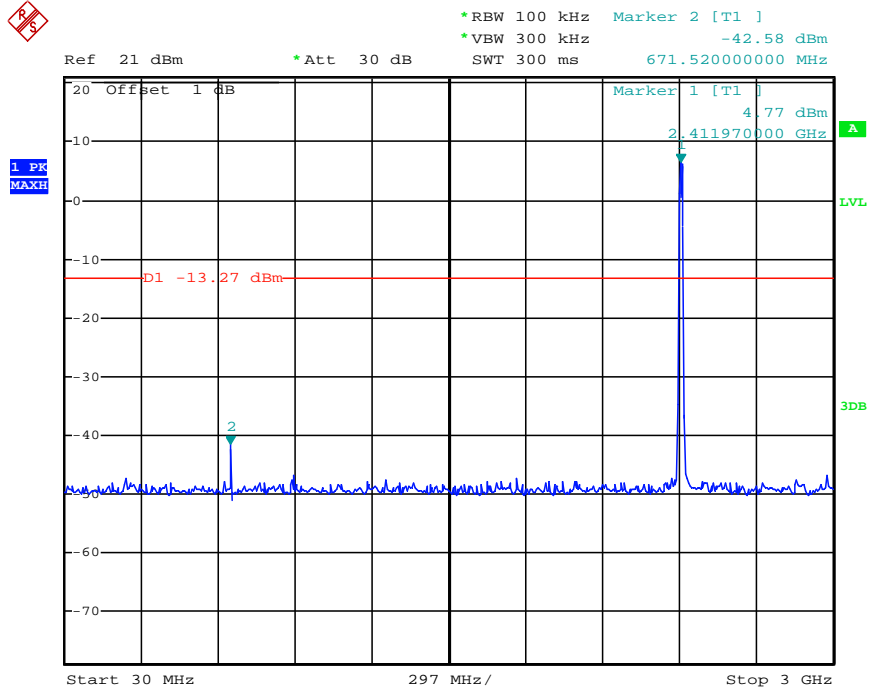



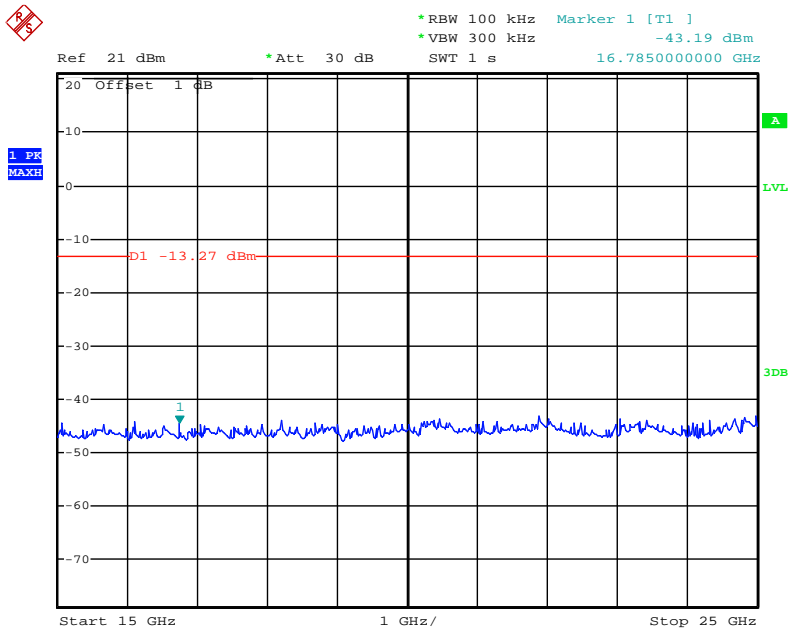



### 802.11b Middle Channel

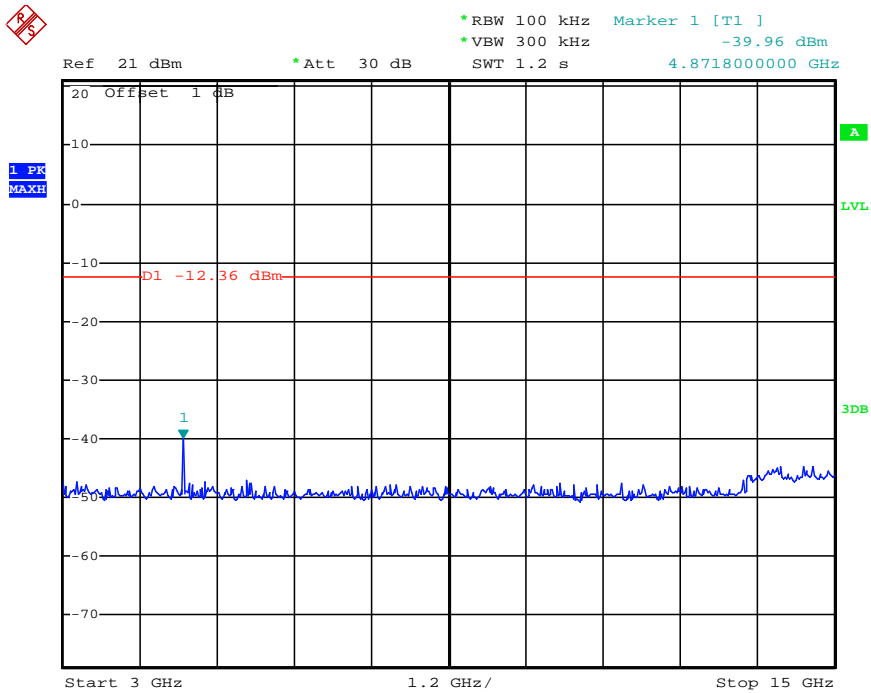
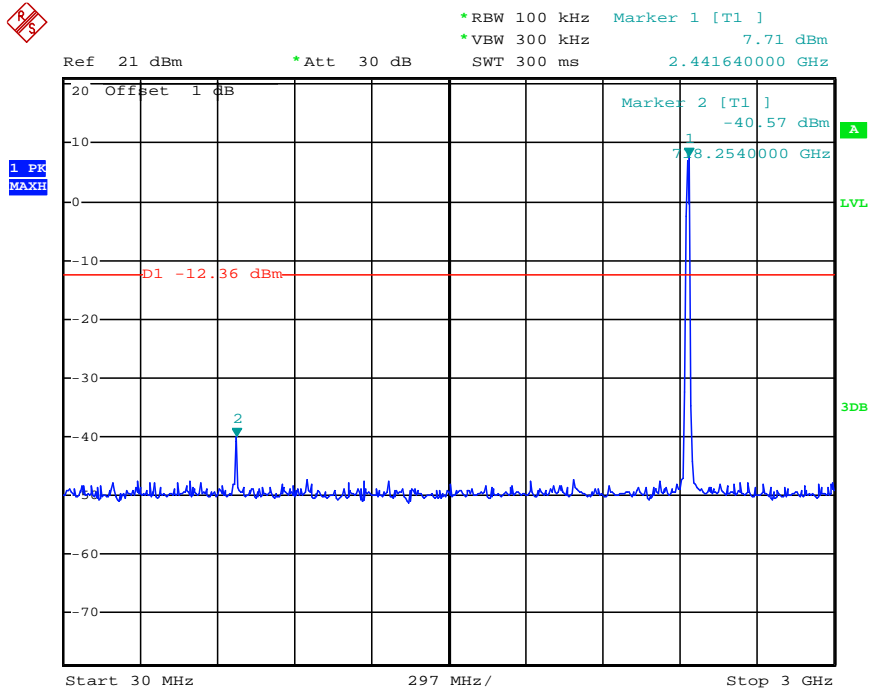

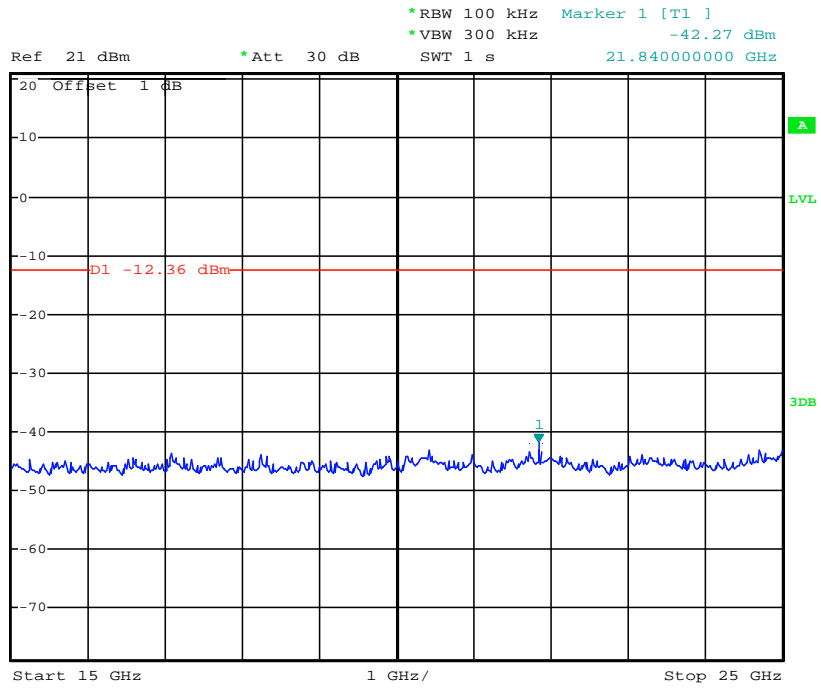



### 802.11b High Channel

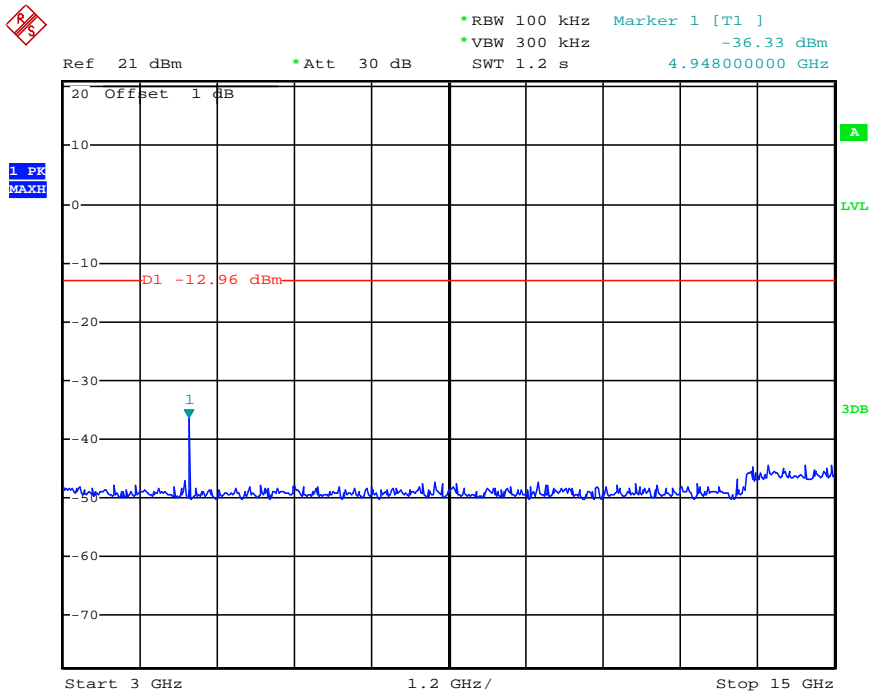
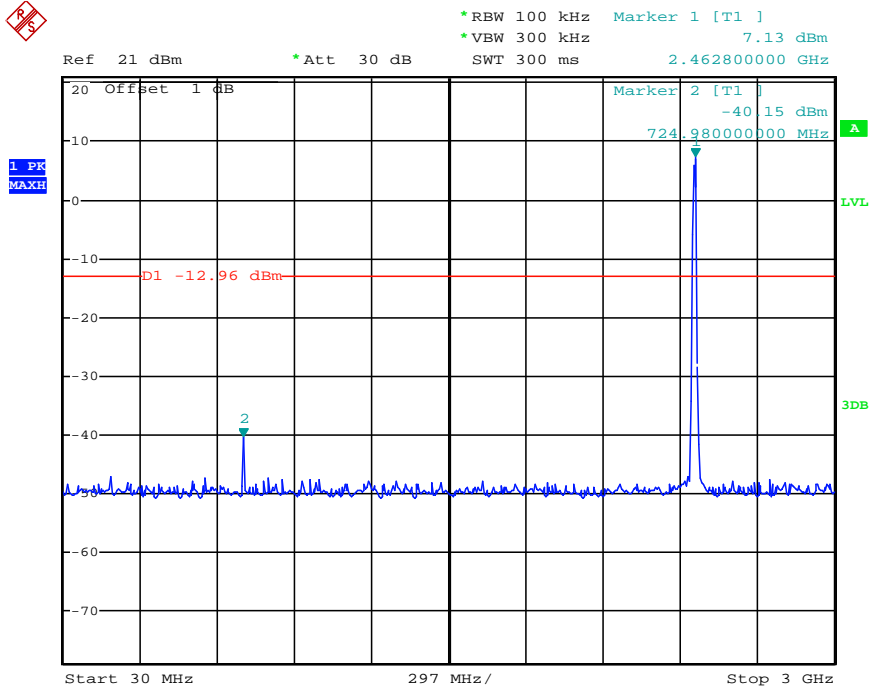



\*RBW 100 kHz    Marker 1 [T1 ]  
\*VBW 300 kHz    -42.71 dBm  
SWT 1 s            21.438000000 GHz

Ref 21 dBm

\*Att 30 dB

SWT 1 s

21.438000000 GHz

1 PK  
MAXH

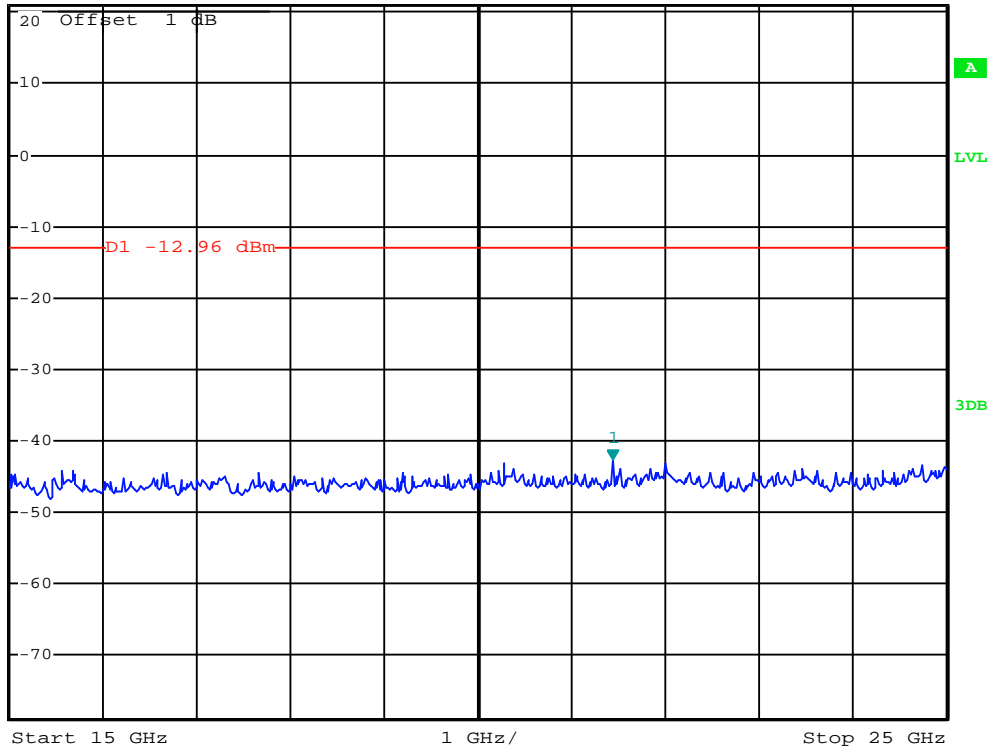



### 802.11g Low Channel

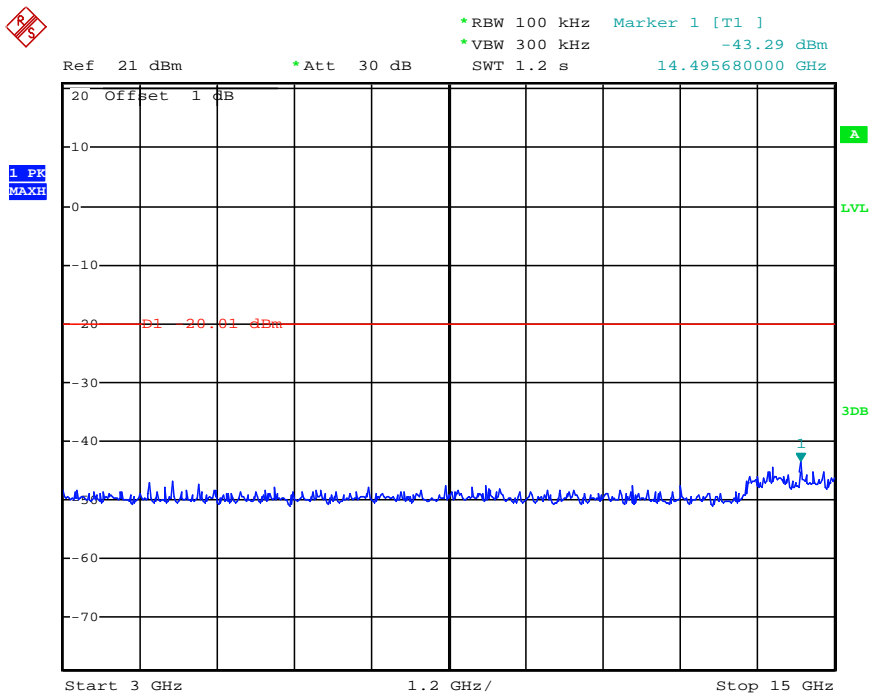
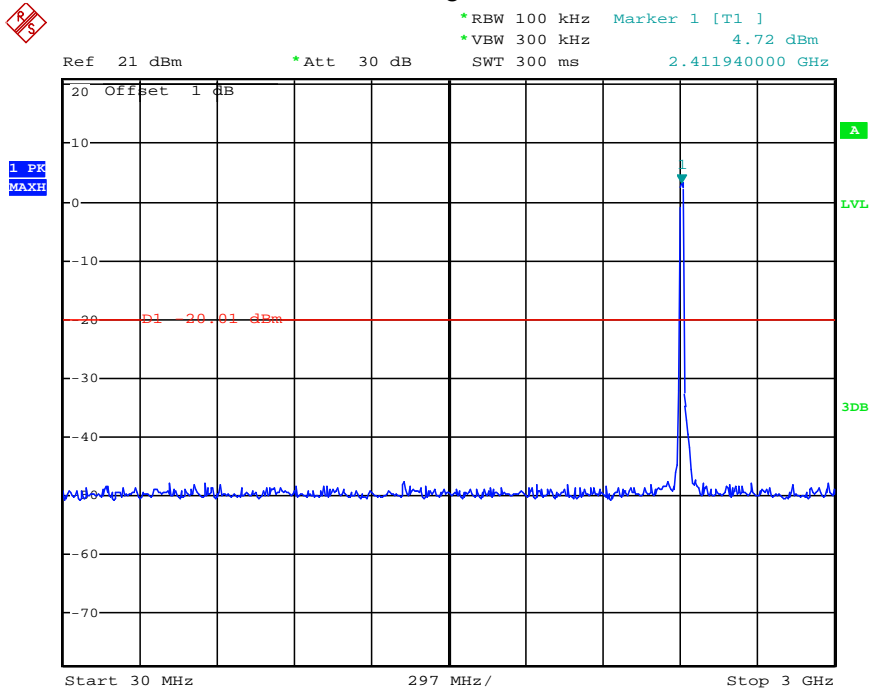

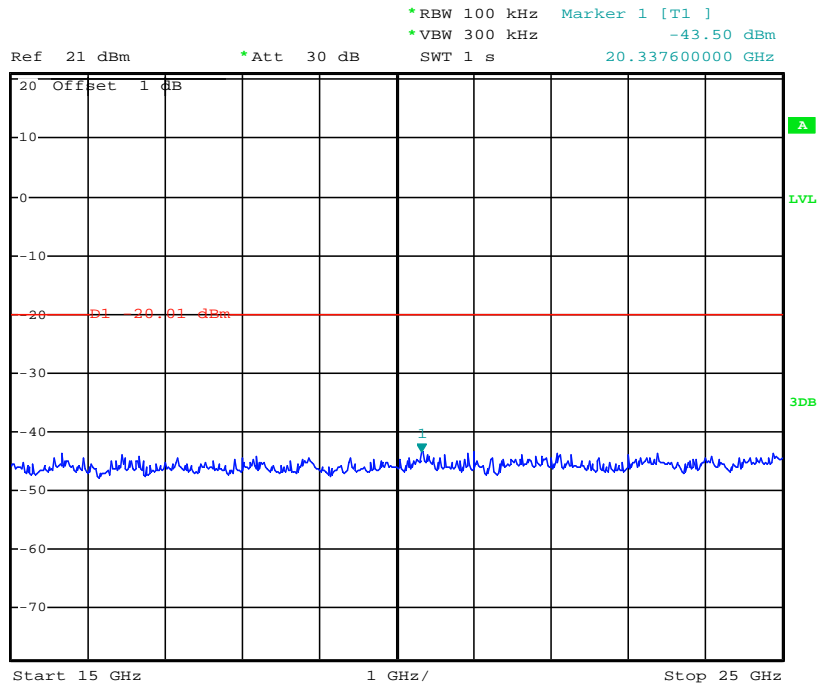



### 802.11g Middle Channel

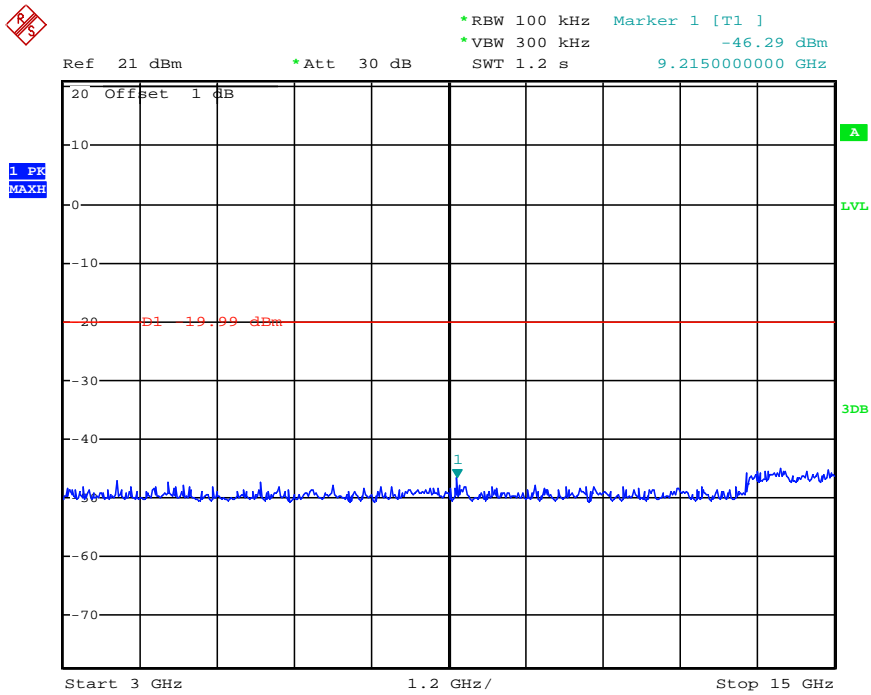
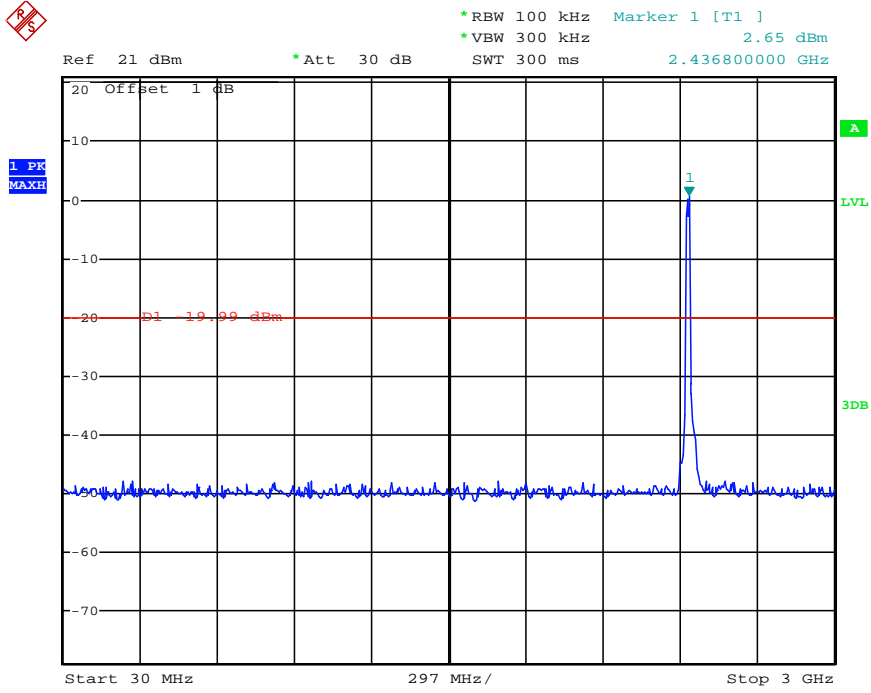





\*RBW 100 kHz Marker 1 [T1 ]  
\*VBW 300 kHz -42.81 dBm

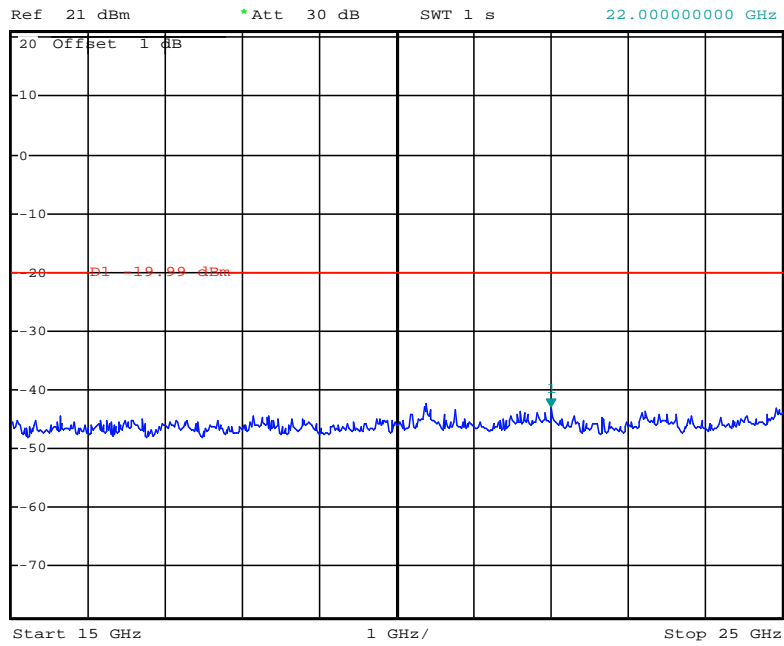



### 802.11g High Channel

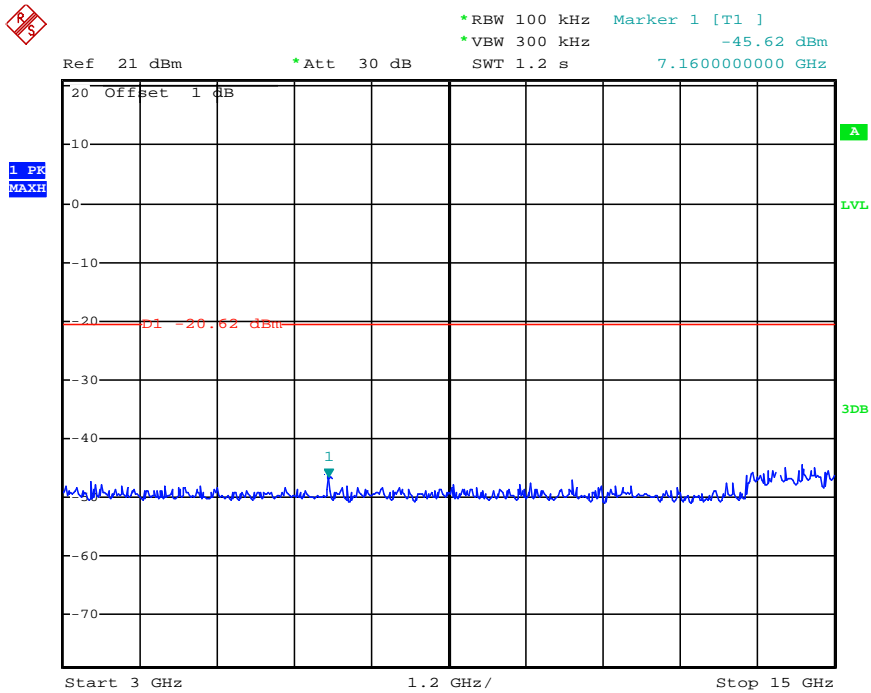
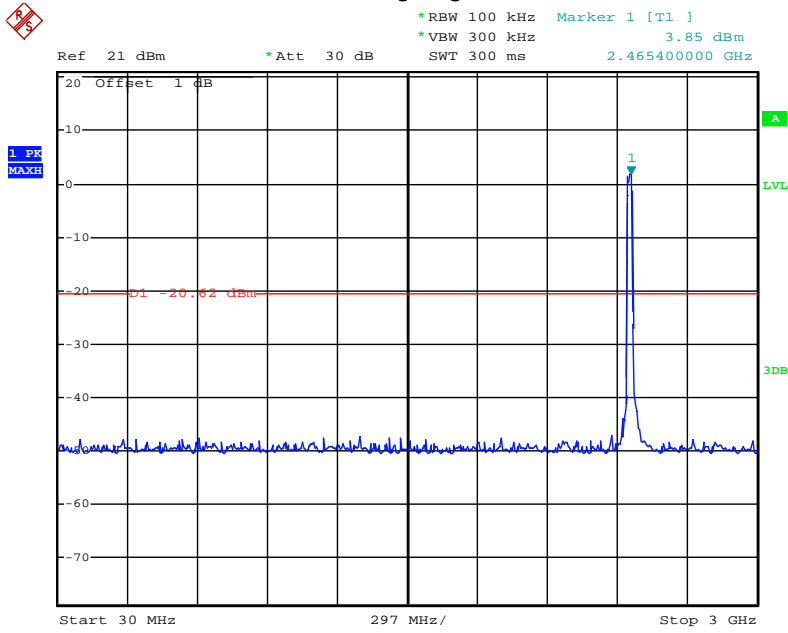

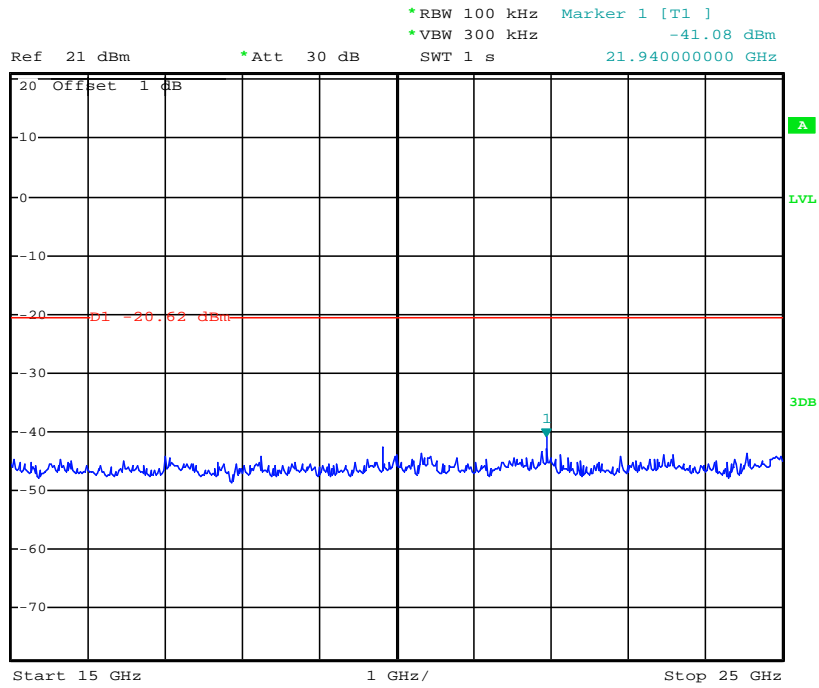



#### 4. POWER SPECTRAL DENSITY TEST

##### 4.1 APPLIED PROCEDURES / LIMIT

FCC Part15 (15.247) , Subpart C				
Section	Test Item	Limit	Frequency Range (MHz)	Result
15.247	Power Spectral Density	8 dBm (in any 3KHz)	2400-2483.5	PASS

##### 4.1.1 TEST PROCEDURE

1. Set analyzer center frequency to DTS channel center frequency.
2. Set the span to 1.5 times the DTS channel bandwidth.
3. Set the RBW  $\geq$  3 kHz.
4. Set the VBW  $\geq$  3 x RBW.
5. Detector = peak.
6. Sweep time = auto couple.
7. Trace mode = max hold.
8. Allow trace to fully stabilize.
9. Use the peak marker function to determine the maximum amplitude level.
10. If measured value exceeds limit, reduce RBW (no less than 3 kHz) and repeat.

##### 4.1.2 DEVIATION FROM STANDARD

No deviation.

##### 4.1.3 TEST SETUP

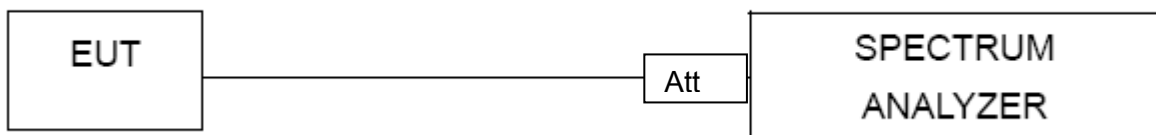

##### 4.1.4 EUT OPERATION CONDITIONS

The EUT tested system was configured as the statements of 2.1 Unless otherwise a special operating condition is specified in the follows during the testing.



**4.1.5 TEST RESULTS**

EUT :	Large Size Touch Kiosk	Model Name :	FT55PC
Temperature :	25 °C	Relative Humidity :	56%
Pressure :	1015 hPa	Test Voltage :	AC 120V/60Hz
Test Mode :	TX b Mode /CH01, CH06, CH11		

Frequency	Power Density (dBm)	Limit (dBm)	Result
2412 MHz	-14.69	8	PASS
2437 MHz	-13.49	8	PASS
2462 MHz	-14.66	8	PASS

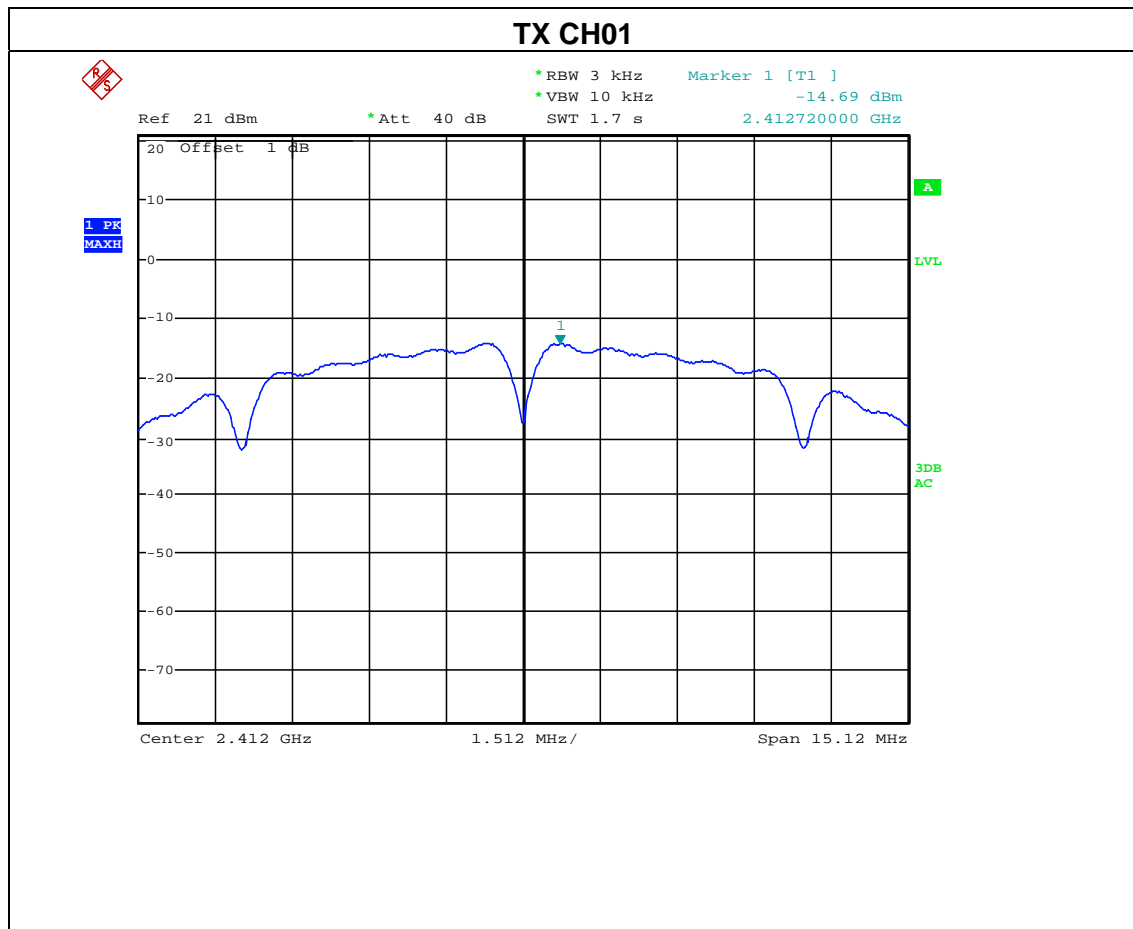

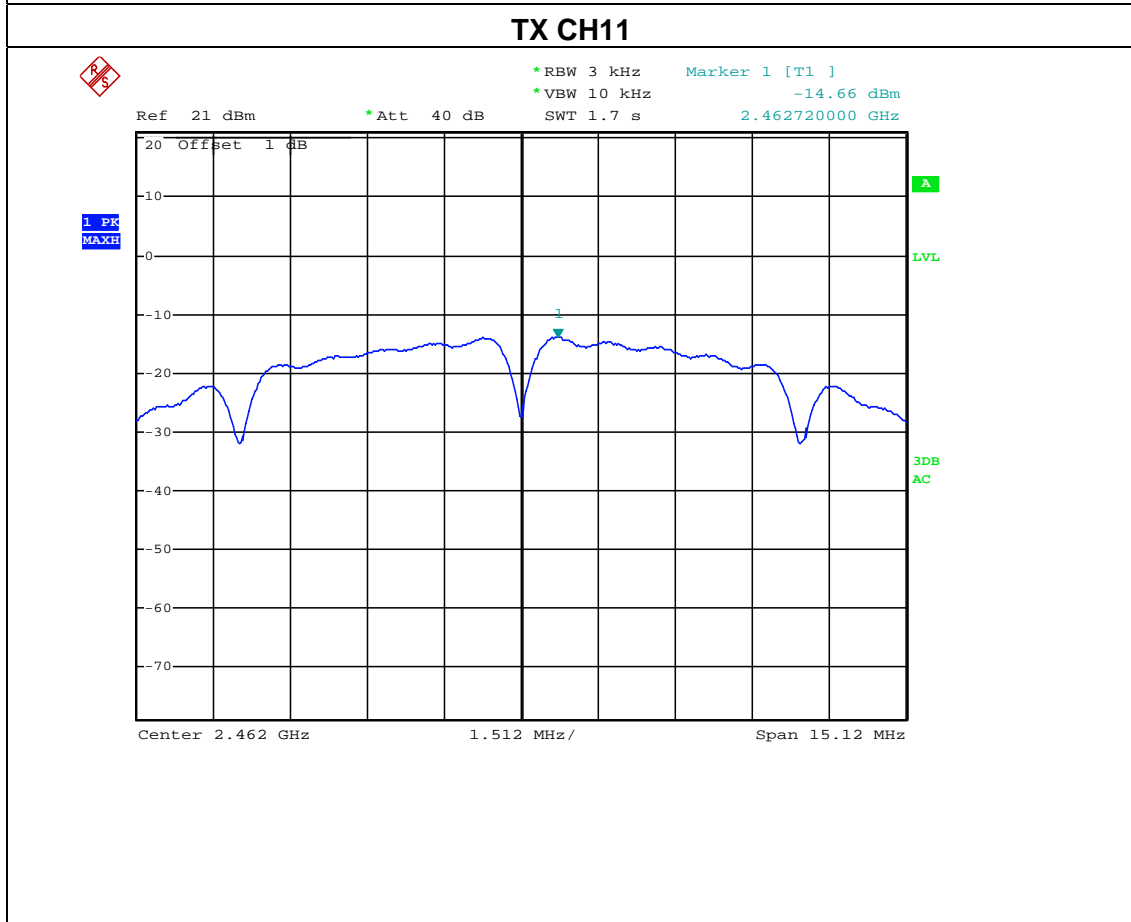
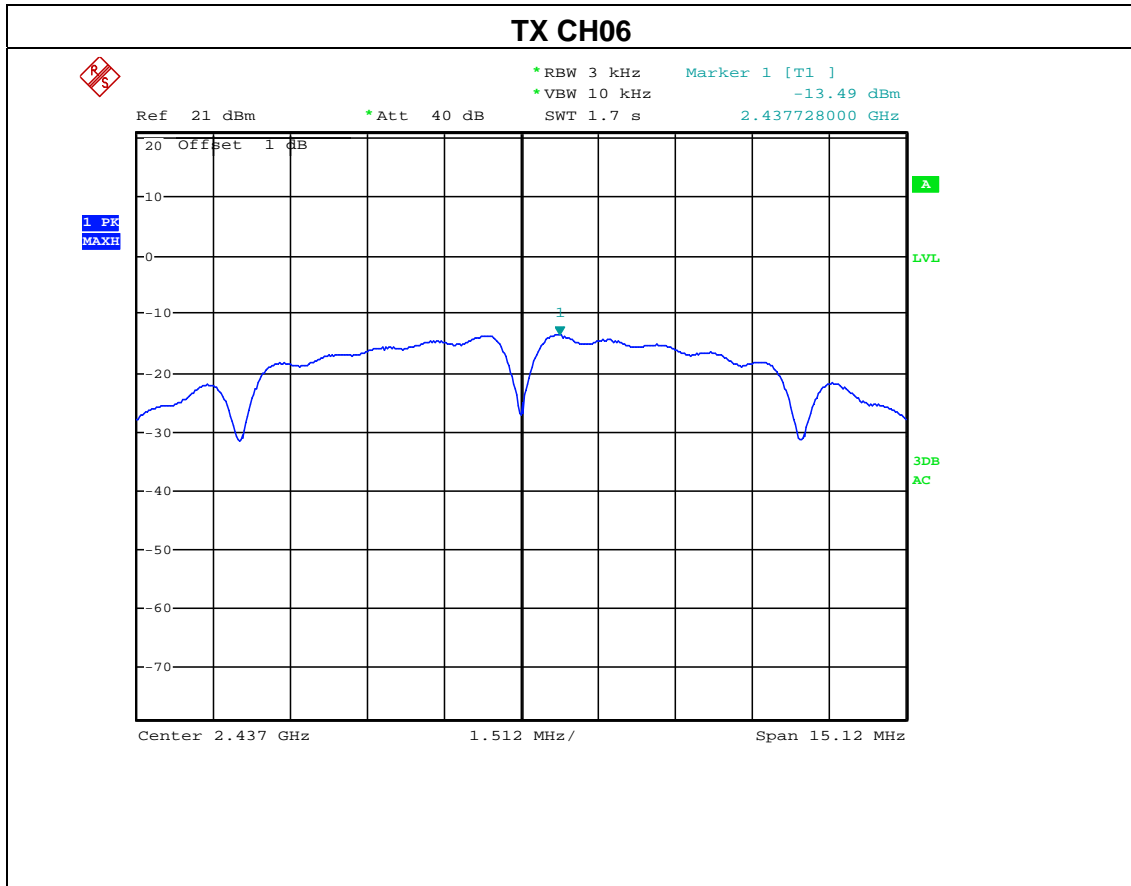



EUT :	Large Size Touch Kiosk	Model Name :	FT55PC
Temperature :	25 °C	Relative Humidity :	56%
Pressure :	1015 hPa	Test Voltage :	AC 120V/60Hz
Test Mode :	TX g Mode /CH01, CH06, CH11		

Frequency	Power Density (dBm)	Limit (dBm)	Result
2412 MHz	-12.32	8	PASS
2437 MHz	-13.77	8	PASS
2462 MHz	-13.90	8	PASS

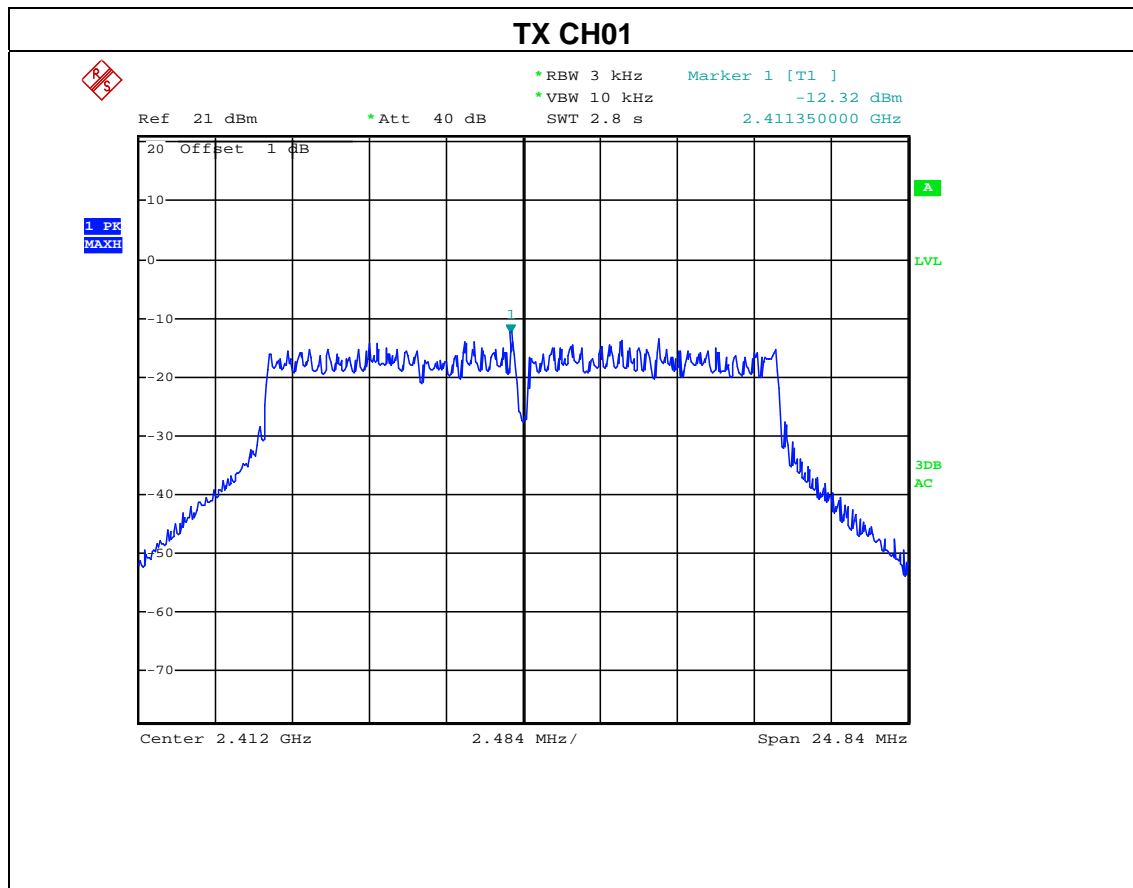

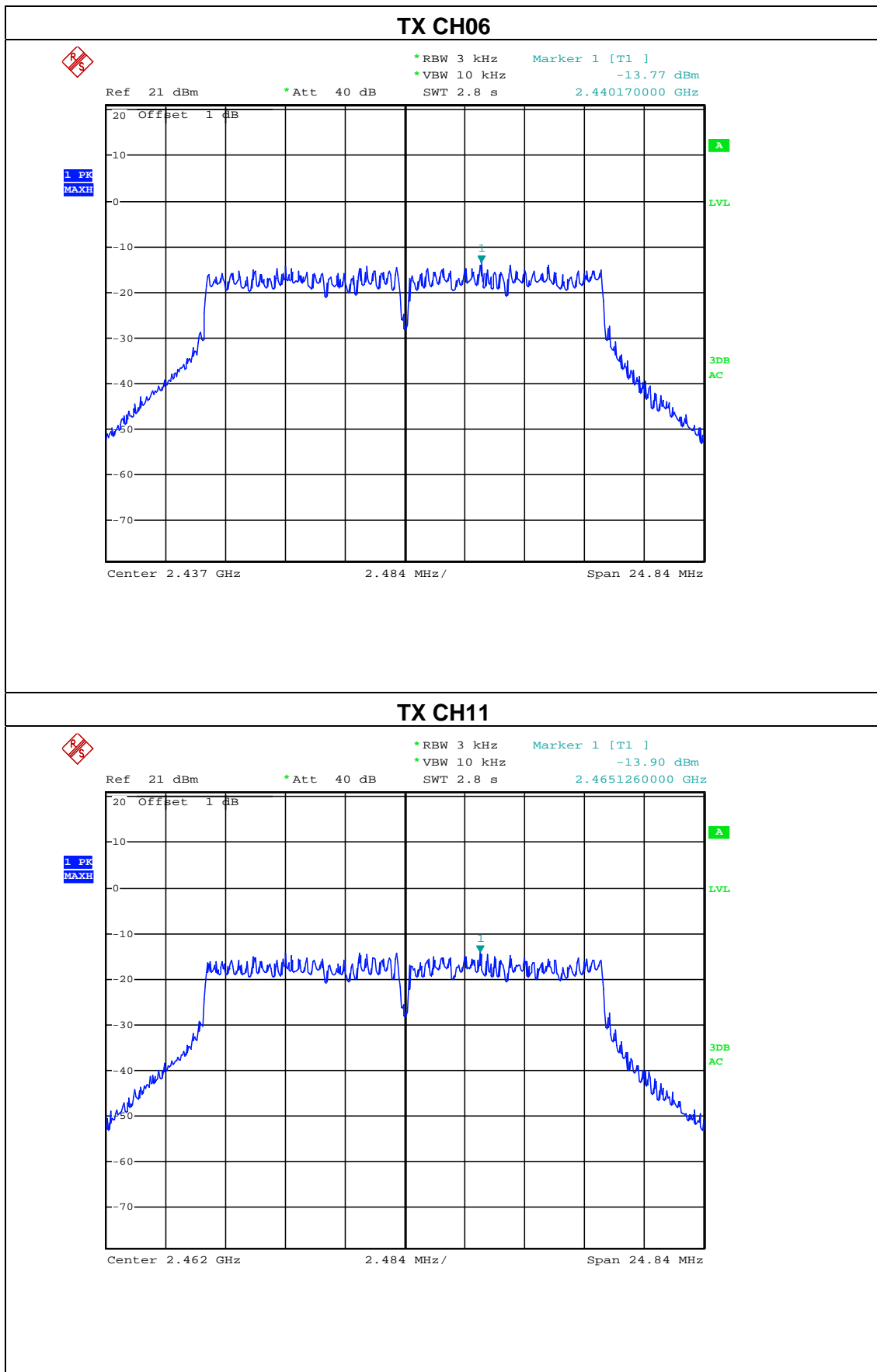





## 5. BANDWIDTH TEST

### 5.1 APPLIED PROCEDURES / LIMIT

FCC Part15 (15.247) , Subpart C				
Section	Test Item	Limit	Frequency Range (MHz)	Result
15.247(a)(2)	Bandwidth	$\geq 500\text{KHz}$ (6dB bandwidth)	2400-2483.5	PASS

#### 5.1.1 TEST PROCEDURE

According to KDB 558074 D01 DTS Meas Guidance v03r01

1. Check the calibration of the measuring instrument using either an internal calibrator or a known signal from an external generator
2. Position the EUT without connection to measurement instrument. Turn on the EUT and connect it to measurement instrument. Then set it to any one convenient frequency within its operating range. Set a reference level on the measuring instrument equal to the highest peak value.
3. Measure the frequency difference of two frequencies that were attenuated 6 dB from the reference level. Record the frequency difference as the emission bandwidth.
4. Repeat above procedures until all frequencies measured were complete.

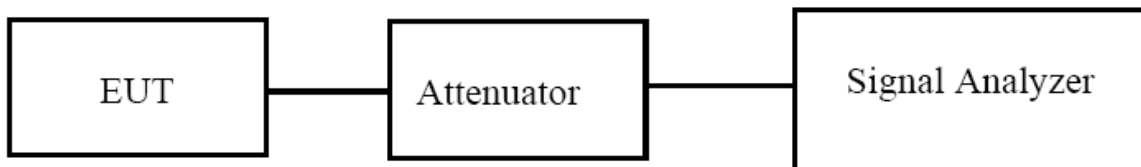

#### 5.1.2 EUT OPERATION CONDITIONS

The EUT tested system was configured as the statements of 2.4 Unless otherwise a special operating condition is specified in the follows during the testing.



5.1.3 TEST RESULTS

EUT :	Large Size Touch Kiosk	Model Name :	FT55PC
Temperature :	25 °C	Relative Humidity :	56%
Pressure :	1012 hPa	Test Voltage :	AC 120V/60Hz
Test Mode :	TX b Mode /CH01, CH06, CH11		

Channel	Frequency (MHz)	6dB bandwidth (MHz)	Limit (kHz)	Result
Low	2412	10.09	500	Pass
Middle	2437	10.15	500	Pass
High	2462	10.08	500	Pass

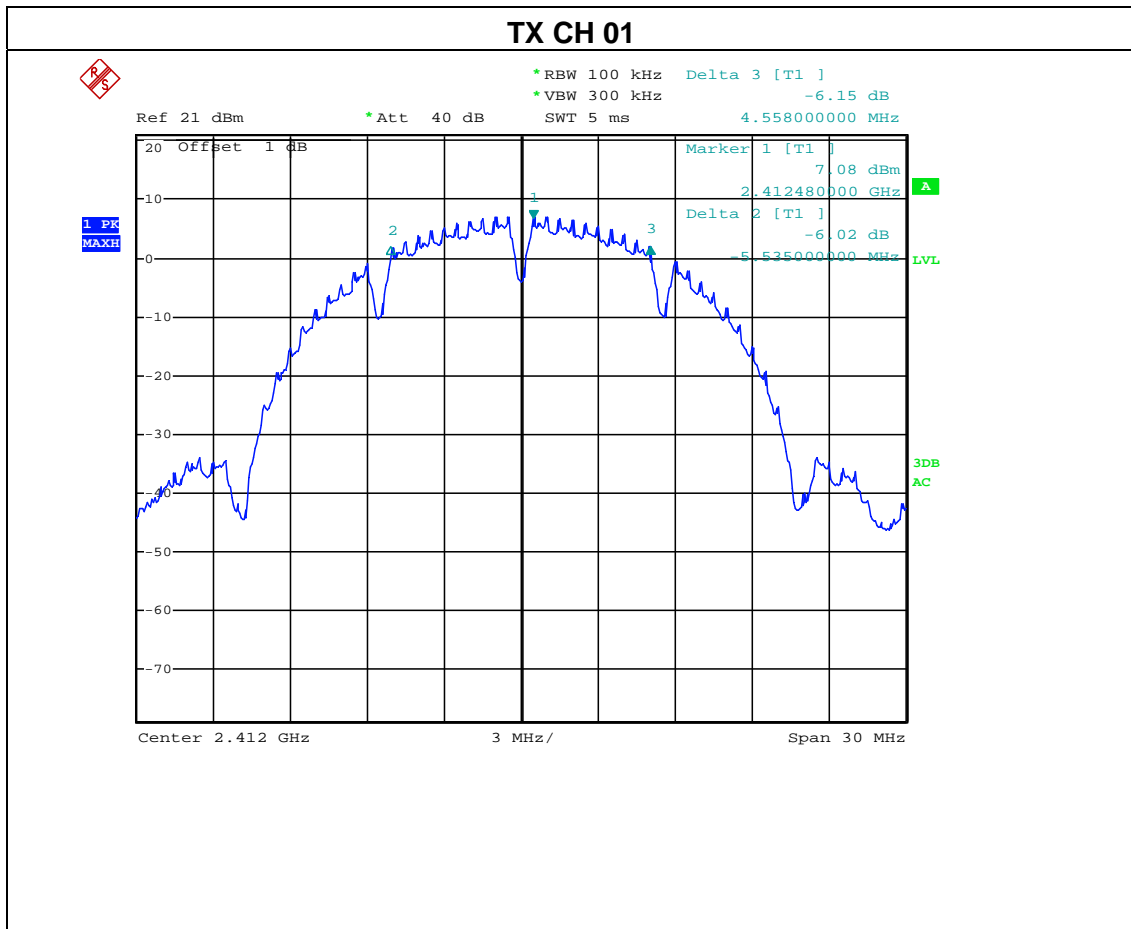

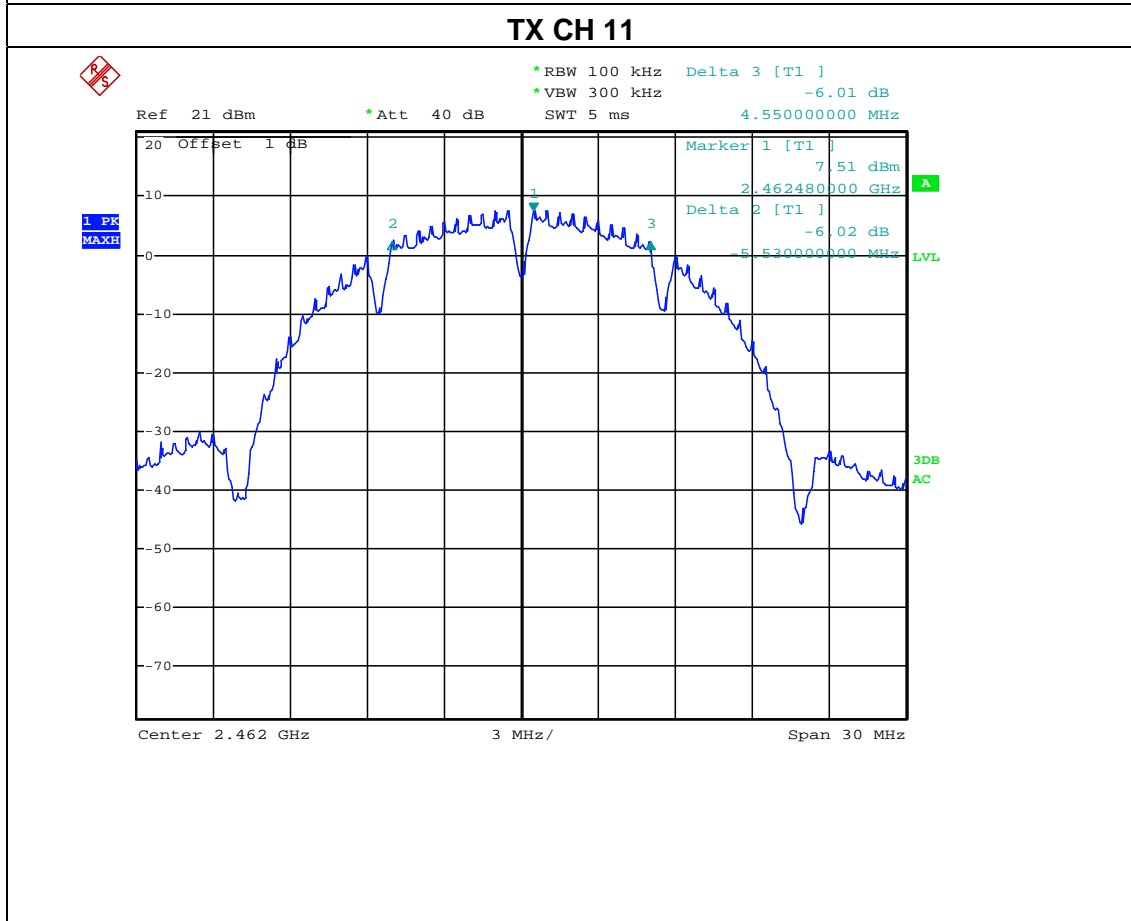
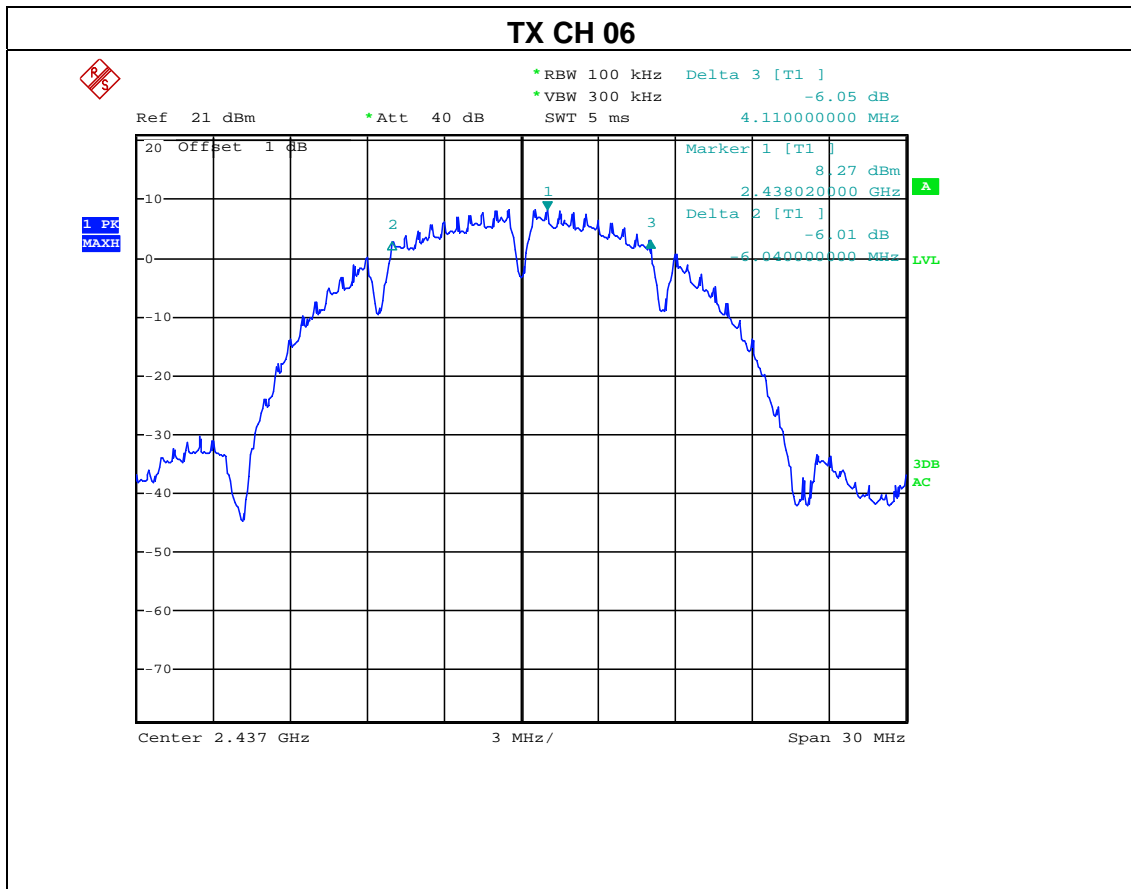



EUT :	Large Size Touch Kiosk	Model Name :	FT55PC
Temperature :	25 °C	Relative Humidity :	60%
Pressure :	1012 hPa	Test Voltage :	AC 120V/60Hz
Test Mode :	TX g Mode /CH01, CH06, CH11		

Channel	Frequency (MHz)	6dB bandwidth (MHz)	Limit (kHz)	Result
Low	2412	16.58	500	Pass
Middle	2437	16.58	500	Pass
High	2462	16.61	500	Pass

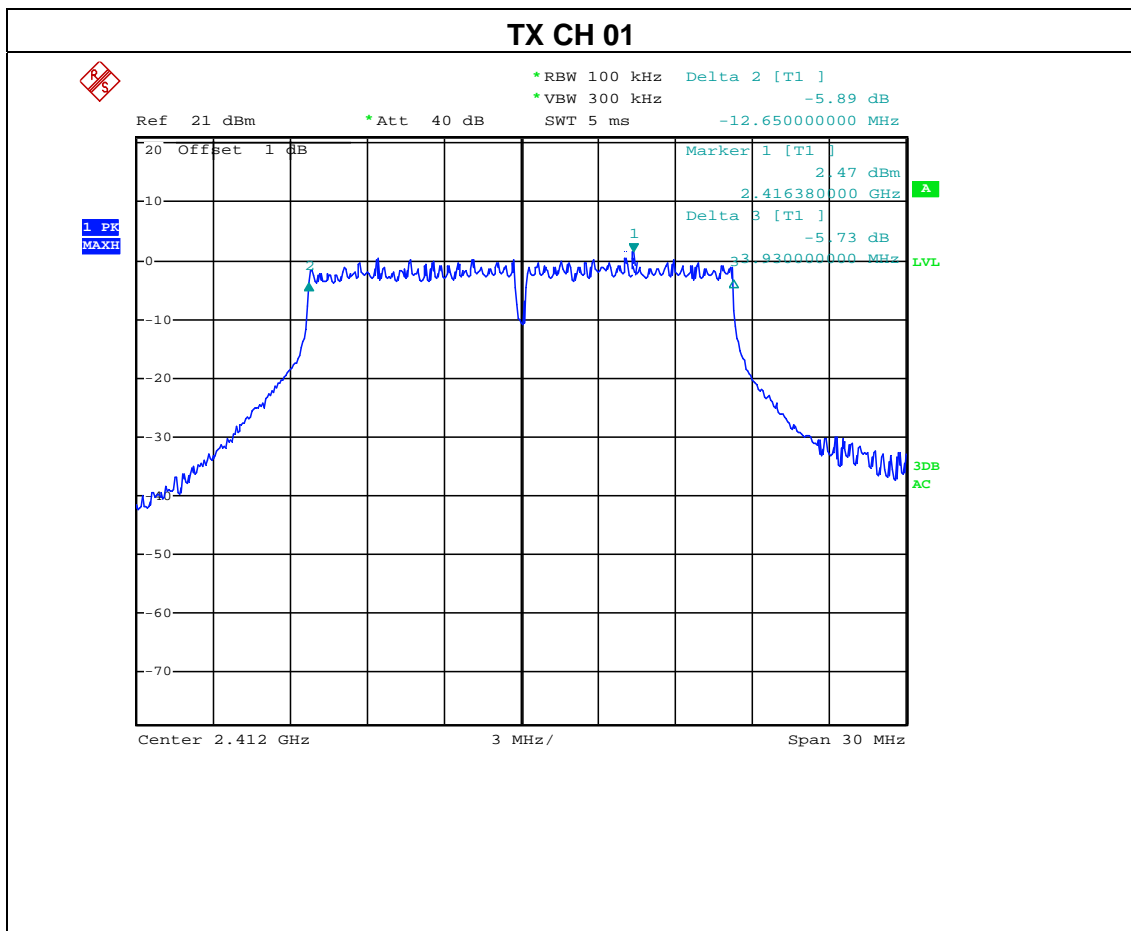

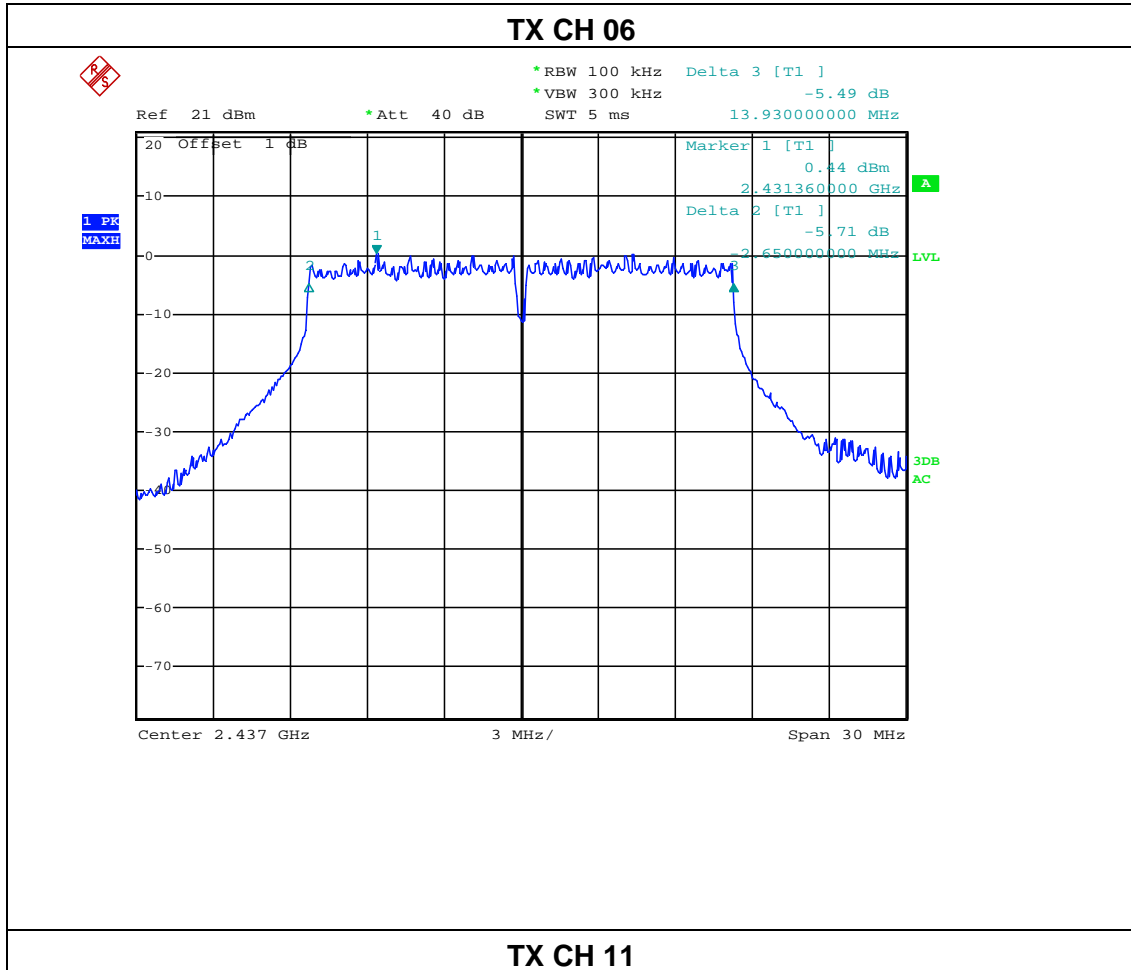

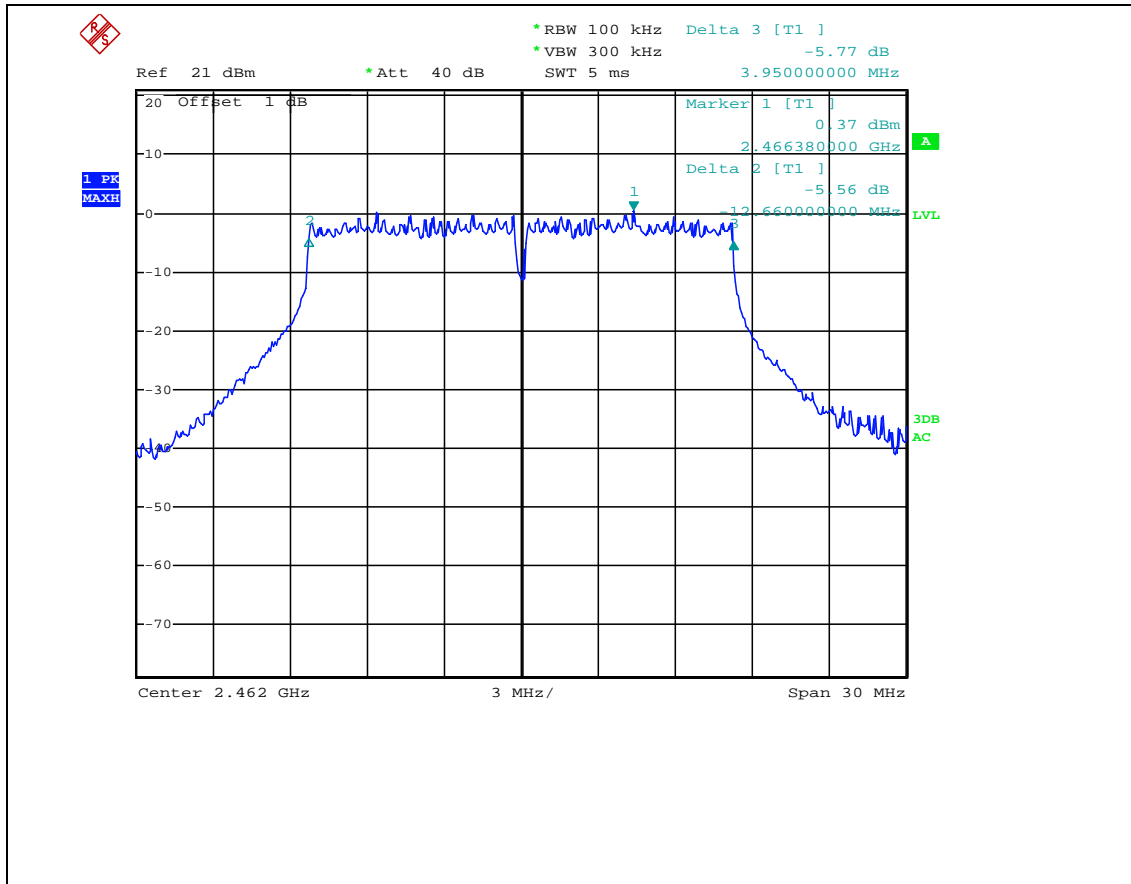



## 6. PEAK OUTPUT POWER TEST

### 6.1 APPLIED PROCEDURES / LIMIT

FCC Part15 (15.247) , Subpart C				
Section	Test Item	Limit	Frequency Range (MHz)	Result
15.247(b)(3)	Peak Output Power	1 watt or 30dBm	2400-2483.5	PASS

#### 6.1.1 TEST PROCEDURE

- a. The EUT was directly connected to the Power meter

#### 6.1.2 DEVIATION FROM STANDARD

No deviation.

#### 6.1.3 TEST SETUP



#### 6.1.4 EUT OPERATION CONDITIONS

The EUT tested system was configured as the statements of 2.4 Unless otherwise a special operating condition is specified in the follows during the testing.

**6.1.5 TEST RESULTS**

EUT :	Large Size Touch Kiosk	Model Name :	FT55PC
Temperature :	25 °C	Relative Humidity :	60%
Pressure :	1012 hPa	Test Voltage :	AC 120V/60Hz
Test Mode :	TX b/g Mode		

<b>TX 802.11b Mode</b>				
Test Channel	Frequency	Maximum Conducted Output Power(PK)	Maximum Conducted Output Power(AV)	LIMIT
	(MHz)	(dBm)	(dBm)	(dBm)
CH01	2412	12.87	9.50	30
CH06	2437	12.64	9.31	30
CH11	2462	12.59	9.27	30
<b>TX 802.11g Mode</b>				
CH01	2412	11.85	8.78	30
CH06	2437	11.73	8.74	30
CH11	2462	11.47	8.63	30

Note: the highest AVG powers for:

802.11b: 1Mbps

802.11g: 6Mbps





## 7. 100 KHZ BANDWIDTH OF FREQUENCY BAND EDGE APPLICABLE STANDARD

In any 100 kHz bandwidth outside the frequency band in which the spread spectrum or digitally modulated intentional radiator is operating, the radio frequency power that is produced by the intentional radiator shall be at least 20 dB below that in the 100 kHz bandwidth within the band that contains the highest level of the desired power, based on either an RF conducted or a radiated measurement, provided the transmitter demonstrates compliance with the peak conducted power limits. If the transmitter complies with the conducted power limits based on the use of RMS averaging over a time interval, as permitted under paragraph (b)(3) of this section, the attenuation required under this paragraph shall be 30 dB instead of 20 dB. Attenuation below the general limits specified in §15.209(a) is not required. In addition, radiated emissions which fall in the restricted bands, as defined in §15.205(a), must also comply with the radiated emission limits specified in §15.209(a) (see §15.205(c)).

### TEST PROCEDURE

- a) Check the calibration of the measuring instrument using either an internal calibrator or a known signal from an external generator.
- b) Position the EUT without connection to measurement instrument. Turn on the EUT and connect its antenna terminal to measurement instrument via a low loss cable. Then set it to any one measured frequency within its operating range, and make sure the instrument is operated in its linear range.
- c) Set RBW to 100 kHz and VBW of spectrum analyzer to 300 kHz with a convenient frequency span including 100 kHz bandwidth from band edge.
- d) Measure the highest amplitude appearing on spectral display and set it as a reference level. Plot the graph with marking the highest point and edge frequency.
- e) Repeat above procedures until all measured frequencies were complete.

### 7.1 DEVIATION FROM STANDARD

No deviation.

### 7.2 TEST SETUP

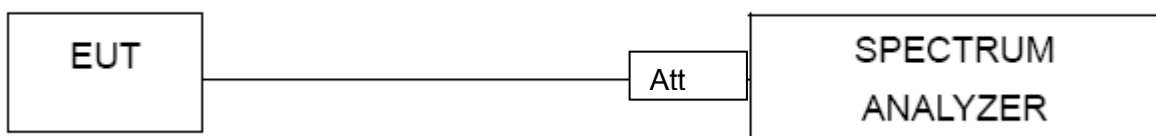

### 7.3 EUT OPERATION CONDITIONS



The EUT tested system was configured as the statements of 2.4 Unless otherwise a special operating condition is specified in the follows during the testing.



**7.4 TEST RESULTS**

EUT :	Large Size Touch Kiosk	Model Name :	FT55PC
Temperature :	25 °C	Relative Humidity :	56%
Pressure :	1012 hPa	Test Voltage :	AC 120V/60Hz

Frequency Band	Delta Peak to band emission (dBc)	> Limit (dBc)	Result
802.11b			
Left-band	42.84	20	Pass
Right-band	40.65	20	Pass
802.11g			
Left-band	39.43	20	Pass
Right-band	40.75	20	Pass

Frequency (MHz)	Meter Reading (dBµV)	Factor (dB)	Emission Level (dBµV/m)	Limits (dBµV/m)	Margin (dB)	Detect or Type	Comment
802.11b							
2390	46.64	9.86	56.5	74	-17.5	Pk	Vertical
2390	31.75	9.86	41.61	54	-12.39	Av	Vertical
2483.5	47.86	10.14	58	74	-16	Pk	Vertical
2483.5	32.85	10.14	42.99	54	-11.01	Av	Vertical
802.11g							
2390	47.64	9.86	57.5	74	-16.5	Pk	Vertical
2390	32.63	9.86	42.49	54	-11.51	Av	Vertical
2483.5	46.34	10.14	56.48	74	-17.52	Pk	Vertical
2483.5	33.06	10.14	43.2	54	-10.8	Av	Vertical



### 802.11b: Band Edge, Left Side

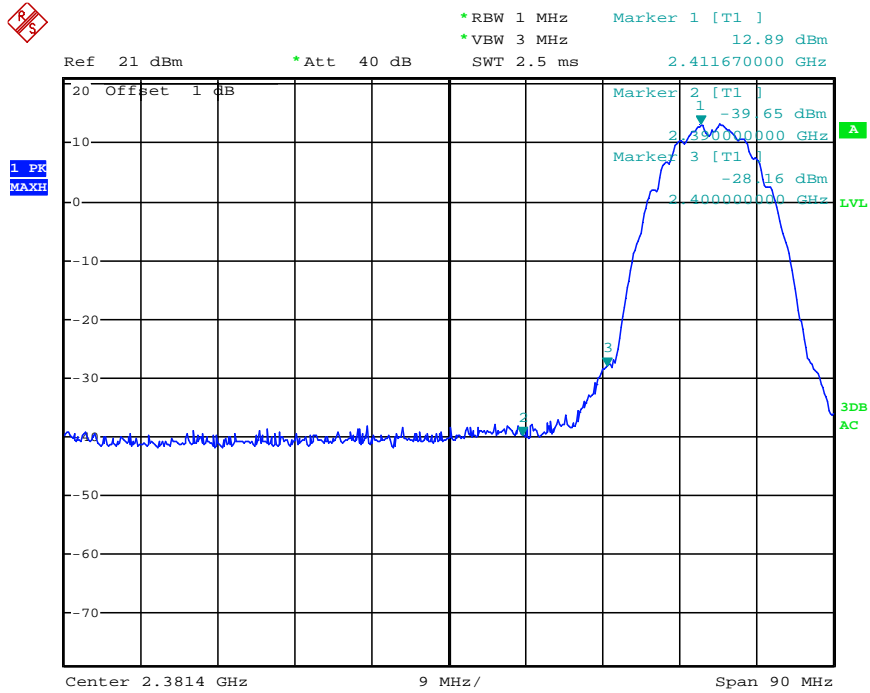

### 802.11b: Band Edge, Right Side

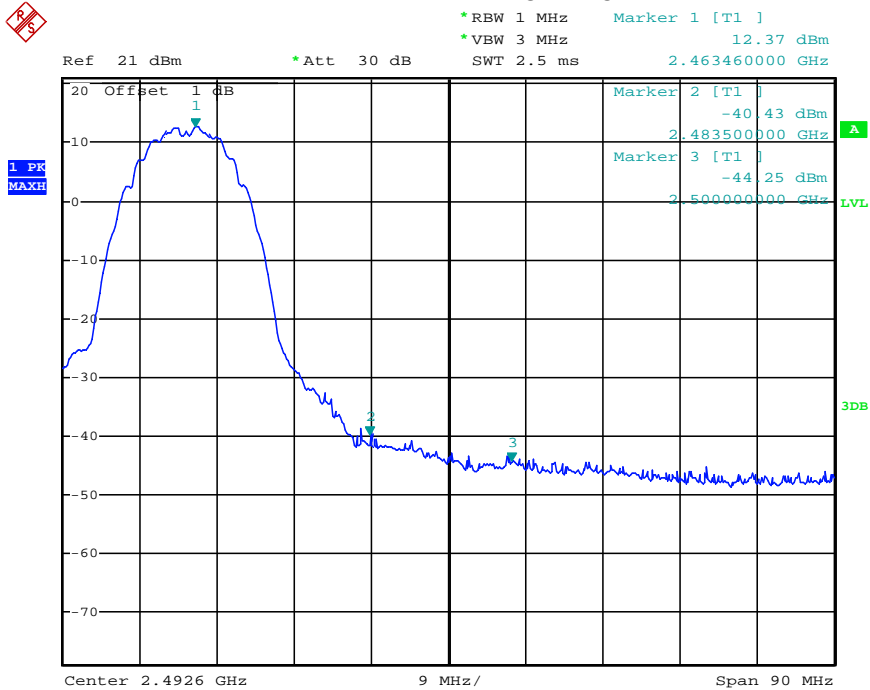



### 802.11g: Band Edge, Left Side

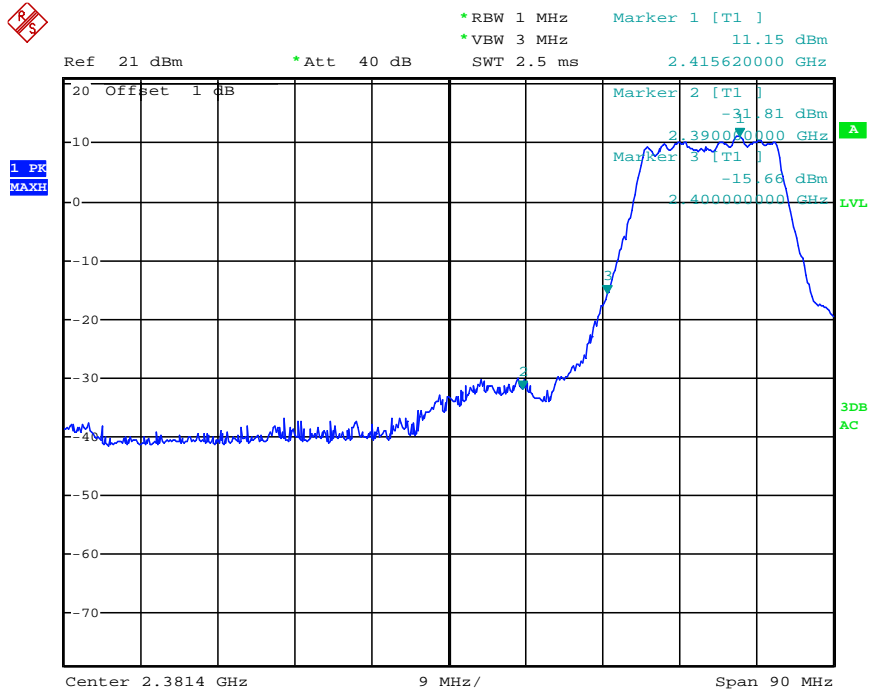

### 802.11g: Band Edge, Right Side

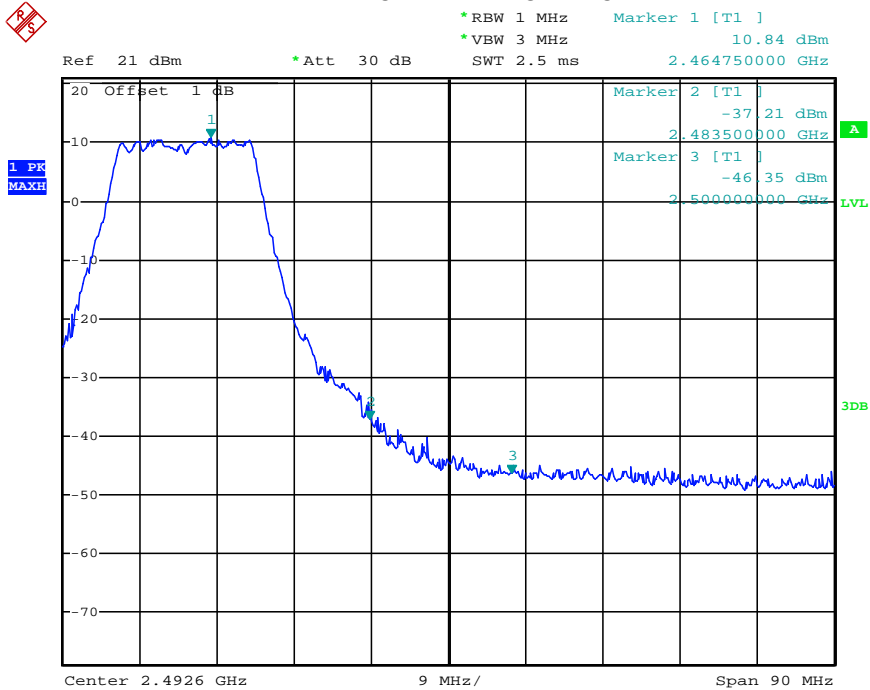



## **8. ANTENNA REQUIREMENT**

### **8.1 STANDARD REQUIREMENT**

15.203 requirement: For intentional device, according to 15.203: an intentional radiator shall be designed to ensure that no antenna other than that furnished by the responsible party shall be used with the device.

### **8.2 EUT ANTENNA**

The EUT antenna is Dipole Antenna. Using negative spiral interfacelt comply with the standard requirement.



## 9. EUT TEST PHOTO

### Radiated Measurement Photos





### Conducted Measurement Photos

