



# **RADIO TEST REPORT**

## **FCC ID: 2AC8IFT15A20M**

**Product:** Embedded Touch PC  
**Trade Name:** faytech  
**Model No.:** FT15A20M  
**Serial Model:** FT07A20M, FT08A20M, FT10A20M,  
FT101A20M, FT104A20M, FT116A20M,  
FT121A20M, FT133A20M, FT17A20M,  
FT19A20M, FT215A20M  
**Report No.:** NTEK-2015NT12283624F1  
**Issue Date:** 20 Apr. 2016

### **Prepared for**

faytech Tech. Co., Ltd.

FL. 4, HONGMEN TECH. ZONE, JIHUA ROAD, LONGGANG  
DISTRICT SHENZHEN, CHINA

### **Prepared by**

NTEK TESTING TECHNOLOGY CO., LTD.  
1/F, Building E, Fenda Science Park, Sanwei Community,  
Xixiang Street Bao'an District, Shenzhen, P.R. China  
Tel.: +86-0755-61156588  
Fax.: +86-0755-61156599  
Website: www.ntek.org.cn

## TABLE OF CONTENTS

<b>1</b>	<b>TEST RESULT CERTIFICATION .....</b>	<b>3</b>
<b>2</b>	<b>SUMMARY OF TEST RESULTS.....</b>	<b>4</b>
<b>3</b>	<b>FACILITIES AND ACCREDITATIONS .....</b>	<b>5</b>
3.1	FACILITIES.....	5
3.2	LABORATORY ACCREDITATIONS AND LISTINGS .....	5
3.3	MEASUREMENT UNCERTAINTY .....	5
<b>4</b>	<b>GENERAL DESCRIPTION OF EUT .....</b>	<b>6</b>
<b>5</b>	<b>DESCRIPTION OF TEST MODES .....</b>	<b>8</b>
<b>6</b>	<b>SETUP OF EQUIPMENT UNDER TEST .....</b>	<b>10</b>
6.1	BLOCK DIAGRAM CONFIGURATION OF TEST SYSTEM.....	10
6.2	SUPPORT EQUIPMENT.....	11
6.3	EQUIPMENTS LIST FOR ALL TEST ITEMS.....	12
<b>7</b>	<b>TEST REQUIREMENTS .....</b>	<b>13</b>
7.1	CONDUCTED EMISSIONS TEST .....	13
7.2	RADIATED SPURIOUS EMISSION .....	18
7.3	6DB BANDWIDTH.....	26
7.4	20DB BANDWIDTH.....	34
7.5	DUTY CYCLE.....	38
7.6	MAXIMUM OUTPUT POWER.....	42
7.7	POWER SPECTRAL DENSITY .....	50
7.8	CONDUCTED BAND EDGE MEASUREMENT.....	58
7.9	ANTENNA APPLICATION .....	64

# 1 TEST RESULT CERTIFICATION

Applicant's name .....	faytech Tech. Co., Ltd.
Address .....	Fl. 4, Hongmen Tech. Zone, Jihua Road, Longgang District Shenzhen, China
Manufacture's Name .....	faytech Tech. Co., Ltd.
Address .....	Fl. 4, Hongmen Tech. Zone, Jihua Road, Longgang District Shenzhen, China
Product description	
Product name .....	Embedded Touch PC
Model and/or type reference .....	FT15A20M
Serial Model .....	FT07A20M, FT08A20M, FT10A20M, FT101A20M, FT104A20M, FT116A20M, FT121A20M, FT133A20M, FT17A20M, FT19A20M, FT215A20M

Measurement Procedure Used:

APPLICABLE STANDARDS	
APPLICABLE STANDARD/ TEST PROCEDURE	TEST RESULT
FCC 47 CFR Part 2, Subpart J:2015 FCC 47 CFR Part 15, Subpart C:2015 KDB 174176 D01 Line Conducted FAQ v01r01 ANSI C63.10-2013 FCC KDB 558074 D01 DTS Meas Guidance v03r04	Complied

This device described above has been tested by NTEK Testing Technology Co., Ltd., and the test results show that the equipment under test (EUT) is in compliance with the FCC requirements. And it is applicable only to the tested sample identified in the report.

This report shall not be reproduced except in full, without the written approval of NTEK Testing Technology Co., Ltd., this document may be altered or revised by NTEK Testing Technology Co., Ltd., personnel only, and shall be noted in the revision of the document.

The test results of this report relate only to the tested sample identified in this report.

Date of Test : 28 Apr. 2015 ~ 20 Apr. 2016

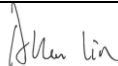
Testing Engineer :   
(Allen Liu)

Technical Manager :   
(Jason Chen)

Authorized Signatory :   
(Sam Chen)

## 2 SUMMARY OF TEST RESULTS

FCC Part15 (15.247), Subpart C			
Standard Section	Test Item	Verdict	Remark
15.207	Conducted Emission	PASS	
15.247 (a)(2)	6dB Bandwidth	PASS	
15.247 (b)	Maximum Output Power	PASS	
15.247 (c)	Radiated Spurious Emission	PASS	
15.247 (d)	Power Spectral Density	PASS	
15.205	Band Edge Emission	PASS	
15.203	Antenna Requirement	PASS	

Remark:

1. "N/A" denotes test is not applicable in this Test Report.
2. All test items were verified and recorded according to the standards and without any deviation during the test.
3. This EUT has also been tested and complied with the requirements of FCC Part 15, Subpart B, recorded in a separate test report.

### 3 FACILITIES AND ACCREDITATIONS

#### 3.1 FACILITIES

All measurement facilities used to collect the measurement data are located at 1/F, Building E, Fenda Science Park, Sanwei Community, Xixiang Street, Bao'an District, Shenzhen P.R. China.

The sites are constructed in conformance with the requirements of ANSI C63.7, ANSI C63.10 and CISPR Publication 22.

#### 3.2 LABORATORY ACCREDITATIONS AND LISTINGS

Site Description

EMC Lab. : Accredited by CNAS, 2014.09.04  
 The certificate is valid until 2017.09.03  
 The Laboratory has been assessed and proved to be in compliance with CNAS-CL01:2006 (identical to ISO/IEC 17025:2005)  
 The Certificate Registration Number is L5516.

Accredited by Industry Canada, August 29, 2012  
 The Certificate Registration Number is 9270A-1.

Accredited by FCC, September 06, 2013  
 The Certificate Registration Number is 238937.

Name of Firm : NTEK Testing Technology Co., Ltd  
 Site Location : 1/F, Building E, Fenda Science Park, Sanwei Community, Xixiang Street, Bao'an District, Shenzhen P.R. China.

#### 3.3 MEASUREMENT UNCERTAINTY

The reported uncertainty of measurement  $y \pm U$ , where expanded uncertainty  $U$  is based on a standard uncertainty multiplied by a coverage factor of  $k=2$ , providing a level of confidence of approximately 95 %.

No.	Item	Uncertainty
1	Conducted Emission Test	$\pm 1.38\text{dB}$
2	RF power, conducted	$\pm 0.16\text{dB}$
3	Spurious emissions, conducted	$\pm 0.21\text{dB}$
4	All emissions, radiated(<1G)	$\pm 4.68\text{dB}$
5	All emissions, radiated(>1G)	$\pm 4.89\text{dB}$
6	Temperature	$\pm 0.5^\circ\text{C}$
7	Humidity	$\pm 2\%$

#### 4 GENERAL DESCRIPTION OF EUT

Product Feature and Specification	
Equipment	Embedded Touch PC
Trade Name	faytech
FCC ID	2AC8IFT15A20M
Model No.	FT15A20M
Serial Model	FT07A20M, FT08A20M, FT10A20M, FT101A20M, FT104A20M, FT116A20M, FT121A20M, FT133A20M, FT17A20M, FT19A20M, FT215A20M
Model Difference	All the model are the same circuit and RF module, except the model name and colour.
Operating Frequency	2412-2462MHz for 802.11b/g/11n(HT20); 2422-2452MHz for 802.11n(HT40);
Modulation	DSSS with DBPSK/DQPSK/CCK for 802.11b; OFDM with BPSK/QPSK/16QAM/64QAM for 802.11g/n;
Number of Channels	11 channels for 802.11b/g/11n(HT20); 7 channels for 802.11n(HT40);
Antenna Type	External antenna
Antenna Gain	1 dBi
Power supply	<input type="checkbox"/> DC supply:
	<input checked="" type="checkbox"/> Adapter supply: Model: FJ-SW1203000 Input: 100-240V~, 50/60Hz, 1.5A MAX Output: 12V---,3000mA
HW Version	N/A
SW Version	N/A

Note: Based on the application, features, or specification exhibited in User's Manual, the EUT is considered as an ITE/Computing Device. More details of EUT technical specification, please refer to the User's Manual.



## 5 DESCRIPTION OF TEST MODES

To investigate the maximum EMI emission characteristics generates from EUT, the test system was pre-scanning tested base on the consideration of following EUT operation mode or test configuration mode which possible have effect on EMI emission level. Each of these EUT operation mode(s) or test configuration mode(s) mentioned above was evaluated respectively.

The Transmitter was operated in the normal operating mode. The TX frequency was fixed which was for the purpose of the measurements.

Test of channel included the lowest and middle and highest frequency to perform the test, then record on this report.

Those data rates (802.11b: 1 Mbps; 802.11g: 6 Mbps; 802.11n (HT20): MCS0; 802.11n (HT40): MCS0) were used for all test.

The EUT was pretested with 3 orientations placed on the table for the radiated emission measurement –X, Y, and Z-plane. The Y-plane results were found as the worst case and were shown in this report.

Frequency and Channel list for 802.11b/g/n (HT20):

Channel	Frequency(MHz)
1	2412
2	2417
...	...
5	2432
6	2437
...	...
10	2457
11	2462

Note:  $f_c=2412\text{MHz}+k \times 5\text{MHz}$   $k=0$  to  $10$

Frequency and Channel list for 802.11n (HT40):

Channel	Frequency(MHz)
3	2422
4	2427
5	2432
6	2437
7	2442
8	2447
9	2452

Note:  $f_c=2422\text{MHz}+k \times 5\text{MHz}$   $k=0$  to  $6$



The following summary table is showing all test modes to demonstrate in compliance with the standard.

<b>For AC Conducted Emission</b>	
Final Test Mode	Description
Mode 5	Link Mode

Note: AC power line Conducted Emission was tested under maximum output power.

<b>For Radiated Test Cases</b>	
Final Test Mode	Description
Mode 1	802.11b CH1/ CH6/ CH11
Mode 2	802.11g CH1/ CH6/ CH11
Mode 3	802.11n HT20 CH1/ CH6/ CH11
Mode 4	802.11n HT40 CH3/ CH6/ CH9

Note: For radiated test cases, the worst mode data rate was reported only, because this data rate has the highest RF output power at preliminary tests, and no other significantly frequencies found in conducted spurious emission.

Those data rates (802.11b: 1 Mbps; 802.11g: 6 Mbps; 802.11n (HT20): MCS0; 802.11n (HT40): MCS0) were used for all test.

<b>For Conducted Test Cases</b>	
Final Test Mode	Description
Mode 1	802.11b CH1/ CH6/ CH11
Mode 2	802.11g CH1/ CH6/ CH11
Mode 3	802.11n HT20 CH1/ CH6/ CH11
Mode 4	802.11n HT40 CH3/ CH6/ CH9

Note: The engineering test program was provided and the EUT was programmed to be in continuously transmitting mode.

## 6 SETUP OF EQUIPMENT UNDER TEST

### 6.1 BLOCK DIAGRAM CONFIGURATION OF TEST SYSTEM

For AC Conducted Emission Mode

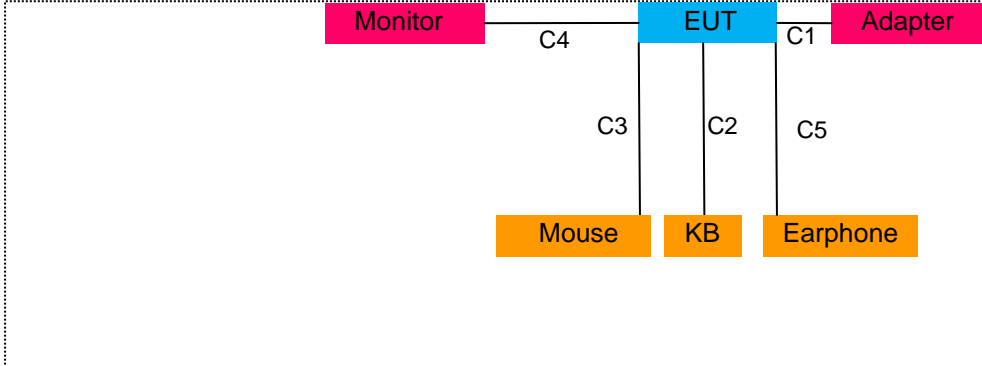

For Radiated Test Cases

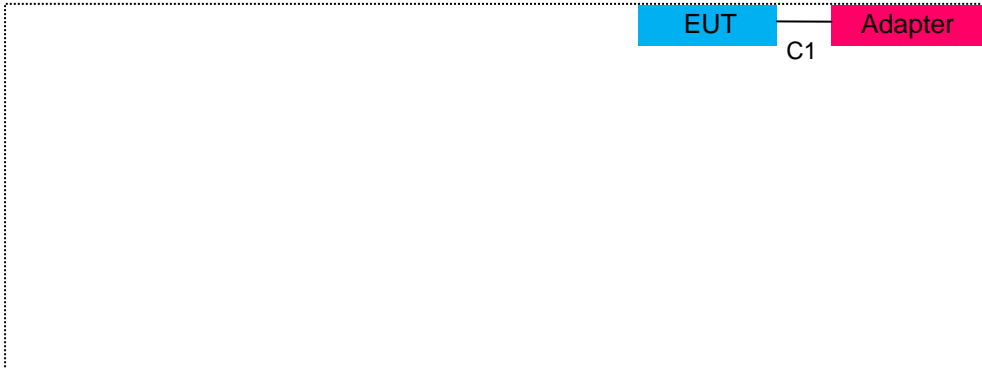

For Conducted Test Cases

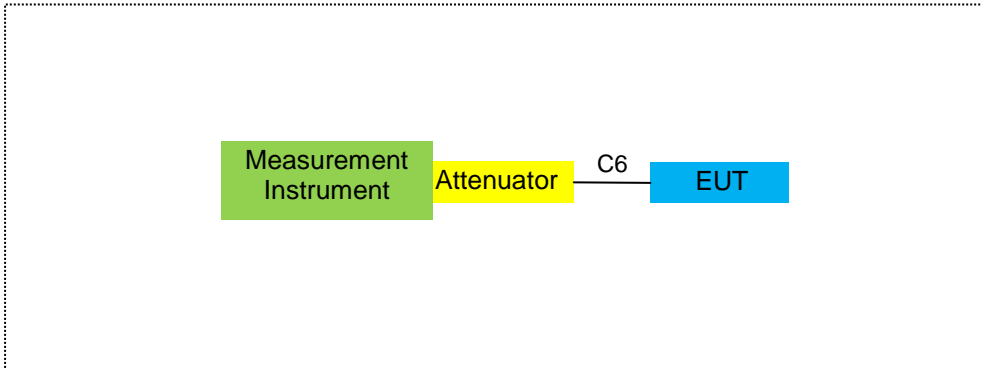

**6.2 SUPPORT EQUIPMENT**

The EUT has been tested as an independent unit together with other necessary accessories or support units. The following support units or accessories were used to form a representative test configuration during the tests.

Item	Equipment	Mfr/Brand	Model/Type No.	FCC ID	Note
1.	Embedded Touch PC	faytech	FT15A20M	2AC8IFT15A20M	EUT
2.	Adapter	N/A	FJ-SW1203000	N/A	Peripherals
3.	Earphone	N/A	L662	N/A	Peripherals
4.	Monitor	DELL	IN2020MB	N/A	Peripherals
5.	Keyboard	DELL	SK-8185	N/A	Peripherals
6.	Mouse	DELL	MS111-P	N/A	Peripherals

Item	Cable Type	Shielded Type	Ferrite Core	Length
C-1	DC Cable	NO	YES	1.2m
C-2	USB Cable	NO	NO	1.0m
C-3	USB Cable	NO	NO	1.0m
C-4	USB Cable	NO	NO	1.0m
C-5	Earphone	NO	NO	0.8m
C-6	RF Cable	NO	NO	0.5m

**Notes:**

- (1) The support equipment was authorized by Declaration of Confirmation.
- (2) For detachable type I/O cable should be specified the length in cm in 『Length』 column.
- (3) “YES” is means “shielded” “with core”; “NO” is means “unshielded” “without core”.

**6.3 EQUIPMENTS LIST FOR ALL TEST ITEMS**

Radiation Test equipment

Item	Kind of Equipment	Manufacturer	Type No.	Serial No.	Last calibration	Calibrated until	Calibration period
1	Spectrum Analyzer	Agilent	E4407B	MY45108040	2015.07.06	2016.07.05	1 year
2	Test Receiver	R&S	ESPI	101318	2015.06.07	2016.06.06	1 year
3	Bilog Antenna	TESEQ	CBL6111D	31216	2015.07.06	2016.07.05	1 year
4	50Ω Coaxial Switch	Anritsu	MP59B	6200264416	2015.06.07	2016.06.06	1 year
5	Spectrum Analyzer	ADVANTEST	R3132	150900201	2015.06.07	2016.06.06	1 year
6	Horn Antenna	EM	EM-AH-10180	2011071402	2015.07.06	2016.07.05	1 year
7	Horn Ant	Schwarzbeck	BBHA 9170	9170-181	2015.07.06	2016.07.05	1 year
8	Amplifier	EM	EM-30180	060538	2015.12.22	2016.12.21	1 year
9	Loop Antenna	ARA	PLA-1030/B	1029	2015.06.08	2016.06.07	1 year
10	Power Meter	R&S	NRVS	100696	2015.07.06	2016.07.05	1 year
11	Power Sensor	R&S	URV5-Z4	0395.1619.05	2015.07.06	2016.07.05	1 year
12	Test Cable	N/A	R-01	N/A	2015.07.06	2016.07.05	1 year
13	Test Cable	N/A	R-02	N/A	2015.07.06	2016.07.05	1 year

Conduction Test equipment

Item	Kind of Equipment	Manufacturer	Type No.	Serial No.	Last calibration	Calibrated until	Calibration period
1	Test Receiver	R&S	ESCI	101160	2015.06.06	2016.06.05	1 year
2	LISN	R&S	ENV216	101313	2015.08.24	2016.08.23	1 year
3	LISN	EMCO	3816/2	00042990	2015.08.24	2016.08.23	1 year
4	50Ω Coaxial Switch	Anritsu	MP59B	6200264417	2015.06.07	2016.06.06	1 year
5	Passive Voltage Probe	R&S	ESH2-Z3	100196	2015.06.07	2016.06.06	1 year
6	Absorbing clamp	R&S	MOS-21	100423	2015.06.08	2016.06.07	1 year
7	Test Cable	N/A	C01	N/A	2015.06.08	2016.06.07	1 year
8	Test Cable	N/A	C02	N/A	2015.06.08	2016.06.07	1 year
9	Test Cable	N/A	C03	N/A	2015.06.08	2016.06.07	1 year

1	Attenuation	MCE	24-10-34	BN9258	2015.06.08	2016.06.07	1 year
---	-------------	-----	----------	--------	------------	------------	--------

Note: Each piece of equipment is scheduled for calibration once a year.

## 7 TEST REQUIREMENTS

### 7.1 CONDUCTED EMISSIONS TEST

#### 7.1.1 Applicable Standard

According to FCC Part 15.207(a) and KDB 174176 D01 Line Conducted FAQ v01r01

#### 7.1.2 Conformance Limit

Frequency(MHz)	Conducted Emission Limit	
	Quasi-peak	Average
0.15-0.5	66-56*	56-46*
0.5-5.0	56	46
5.0-30.0	60	50

Note: 1. \*Decreases with the logarithm of the frequency  
 2. The lower limit shall apply at the transition frequencies  
 3. The limit decreases in line with the logarithm of the frequency in the range of 0.15 to 0.50MHz.

#### 7.1.3 Measuring Instruments

The Measuring equipment is listed in the section 6.3 of this test report.

#### 7.1.4 Test Configuration

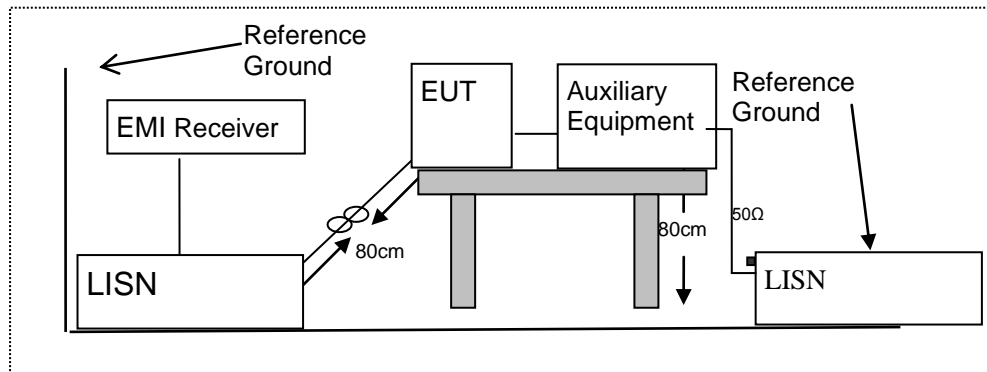

#### 7.1.5 Test Procedure

According to the requirements in Section 13.1.4.1 of ANSI C63.10-2013 Conducted emissions the EUT measured in the frequency range between 0.15 MHz and 30 MHz using CISPR Quasi-Peak and average detector mode.

1. The EUT was placed 0.4 meter from the conducting wall of the shielding room.
2. The EUT was placed on a table which is 0.8m above ground plane.
3. Connect EUT to the power mains through a line impedance stabilization network (LISN). All other support equipments powered from additional LISN(s). The LISN provide 50 Ohm/ 50uH of coupling impedance for the measuring instrument.
4. Interconnecting cables that hang closer than 40 cm to the ground plane shall be folded back and forth in the center forming a bundle 30 to 40cm long.
5. I/O cables that are not connected to a peripheral shall be bundled in the center. The end of the cable may be terminated, if required, using the correct terminating impedance. The overall length shall not exceed 1 m.
6. LISN at least 80 cm from nearest part of EUT chassis.
7. The frequency range from 150KHz to 30MHz was searched.
8. Set the test-receiver system to Peak Detect Function and specified bandwidth(IF bandwidth=9KHz) with Maximum Hold Mode
9. For the actual test configuration, please refer to the related Item –EUT Test Photos.

### 7.1.6 Test Results

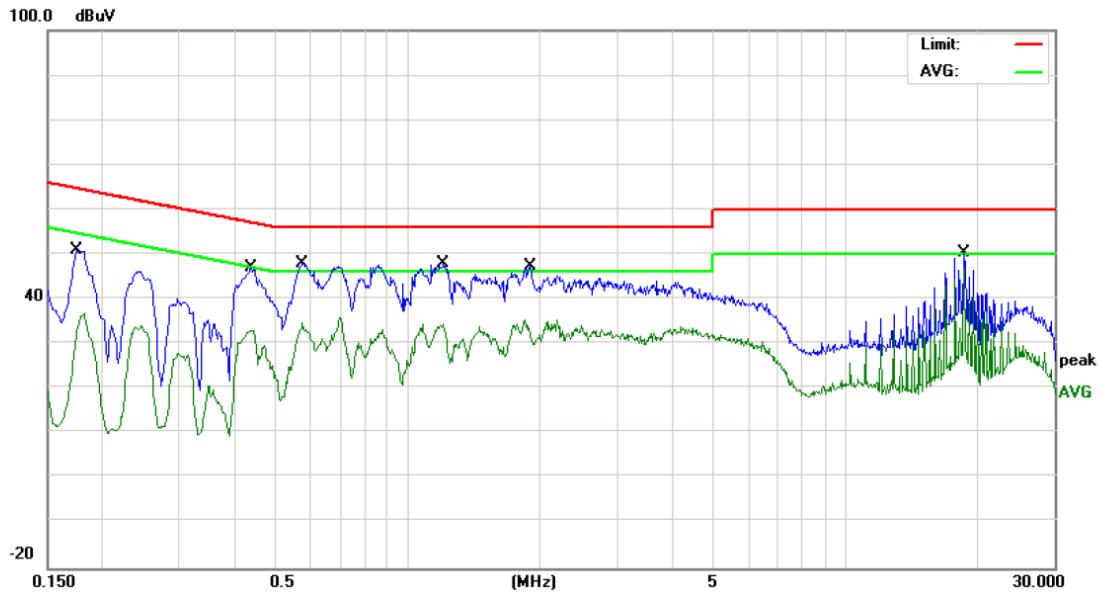

Site: Phase: **L1** Temperature: 22  
 Limit: FCC Part 15B\_(0.15-30MHz) \_Main\_QP Power: AC 120V/60Hz Humidity: 51 %  
 Mode: Mode 5  
 Note:

No.	Mk.	Freq. MHz	Reading Level dBuV	Correct Factor dB	Measure- ment dBuV	Limit dBuV	Over dB	Detector	Comment
1		0.1737	40.71	10.12	50.83	64.78	-13.95	QP	
2		0.1737	29.90	10.12	40.02	54.78	-14.76	AVG	
3		0.4380	37.01	9.95	46.96	57.10	-10.14	QP	
4		0.4380	18.57	9.95	28.52	47.10	-18.58	AVG	
5		0.5738	38.11	9.79	47.90	56.00	-8.10	QP	
6		0.5738	17.53	9.79	27.32	46.00	-18.68	AVG	
7	*	1.2058	38.13	9.83	47.96	56.00	-8.04	QP	
8		1.2058	19.50	9.83	29.33	46.00	-16.67	AVG	
9		1.9058	37.50	9.74	47.24	56.00	-8.76	QP	
10		1.9058	17.80	9.74	27.54	46.00	-18.46	AVG	
11		18.7017	40.53	9.92	50.45	60.00	-9.55	QP	
12		18.7017	30.40	9.92	40.32	50.00	-9.68	AVG	

\*:Maximum data    x:Over limit    !:over margin

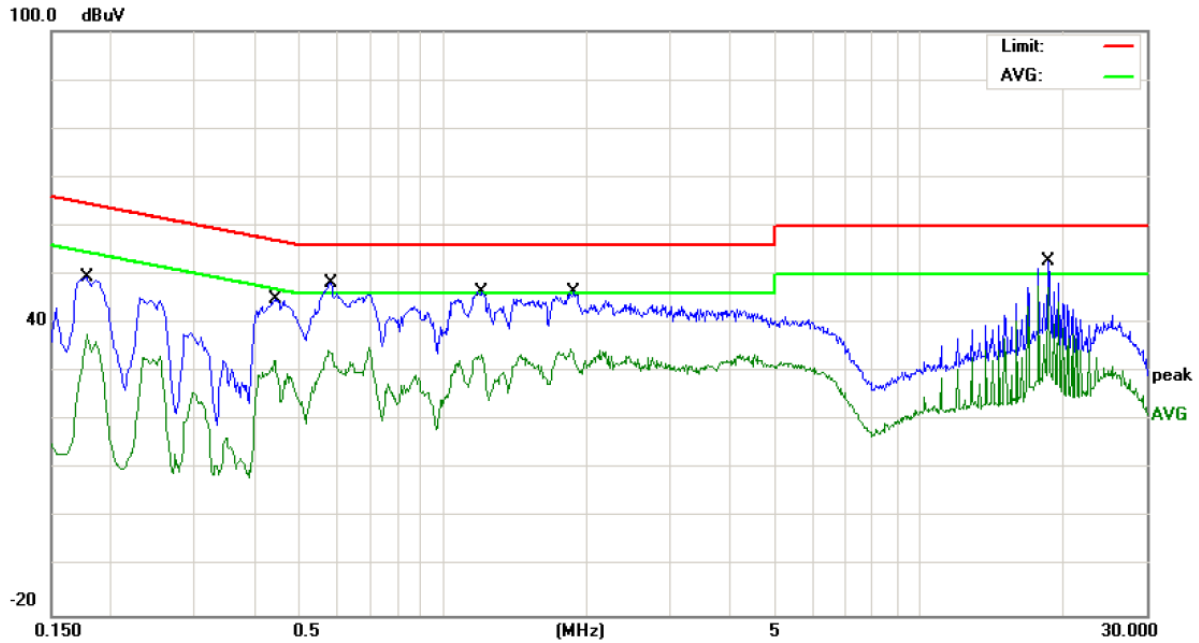

Site: \_\_\_\_\_ Phase: **N** Temperature: 22  
 Limit: FCC Part 15B\_(0.15-30MHz) \_Main\_QP Power: AC 120V/60Hz Humidity: 51 %  
 Mode: Mode 5  
 Note:

No.	Mk.	Freq. MHz	Reading Level dBuV	Correct Factor dB	Measure- ment dBuV	Limit dBuV	Over dB	Detector	Comment
1		0.1780	39.36	10.05	49.41	64.57	-15.16	QP	
2		0.1780	22.28	10.05	32.33	54.57	-22.24	AVG	
3		0.4460	34.97	9.94	44.91	56.95	-12.04	QP	
4		0.4460	25.08	9.94	35.02	46.95	-11.93	AVG	
5		0.5820	38.45	9.82	48.27	56.00	-7.73	QP	
6		0.5820	16.83	9.82	26.65	46.00	-19.35	AVG	
7		1.2059	36.70	9.85	46.55	56.00	-9.45	QP	
8		1.2059	18.70	9.85	28.55	46.00	-17.45	AVG	
9		1.8780	36.78	9.76	46.54	56.00	-9.46	QP	
10		1.8780	17.69	9.76	27.45	46.00	-18.55	AVG	
11	*	18.7059	42.79	9.88	52.67	60.00	-7.33	QP	
12		18.7059	30.32	9.88	40.20	50.00	-9.80	AVG	

\*:Maximum data    x:Over limit    !:over margin

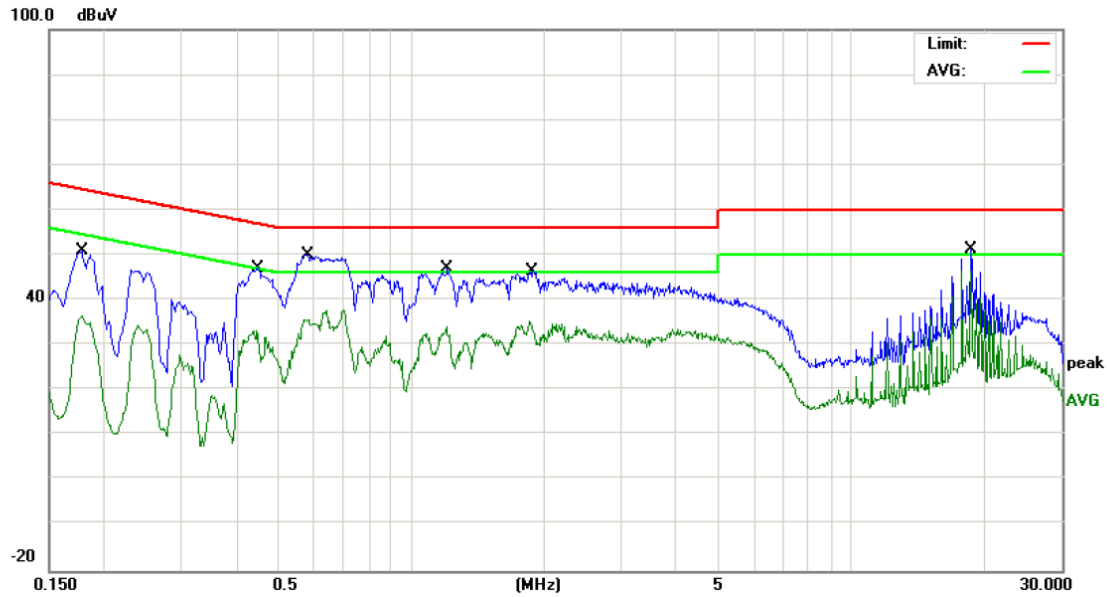

Site: \_\_\_\_\_ Phase: **L1** Temperature: 22  
 Limit: FCC Part 15B\_(0.15-30MHz) \_Main\_QP Power: AC 240V/50Hz Humidity: 51 %  
 Mode: Mode 5  
 Note:

No.	Mk.	Freq.	Reading Level	Correct Factor	Measurement	Limit	Over	Detector	Comment
		MHz	dBuV	dB	dBuV	dBuV	dB		
1		0.1780	40.82	10.13	50.95	64.57	-13.62	QP	
2		0.1780	29.89	10.13	40.02	54.57	-14.55	AVG	
3		0.4467	37.20	9.93	47.13	56.94	-9.81	QP	
4		0.4467	27.03	9.93	36.96	46.94	-9.98	AVG	
5	*	0.5820	40.25	9.79	50.04	56.00	-5.96	QP	
6		0.5820	29.65	9.79	39.44	46.00	-6.56	AVG	
7		1.2059	37.15	9.83	46.98	56.00	-9.02	QP	
8		1.2059	26.02	9.83	35.85	46.00	-10.15	AVG	
9		1.8780	36.69	9.74	46.43	56.00	-9.57	QP	
10		1.8780	24.00	9.74	33.74	46.00	-12.26	AVG	
11		18.7019	41.30	9.92	51.22	60.00	-8.78	QP	
12		18.7019	30.18	9.92	40.10	50.00	-9.90	AVG	

\*:Maximum data x:Over limit !:over margin



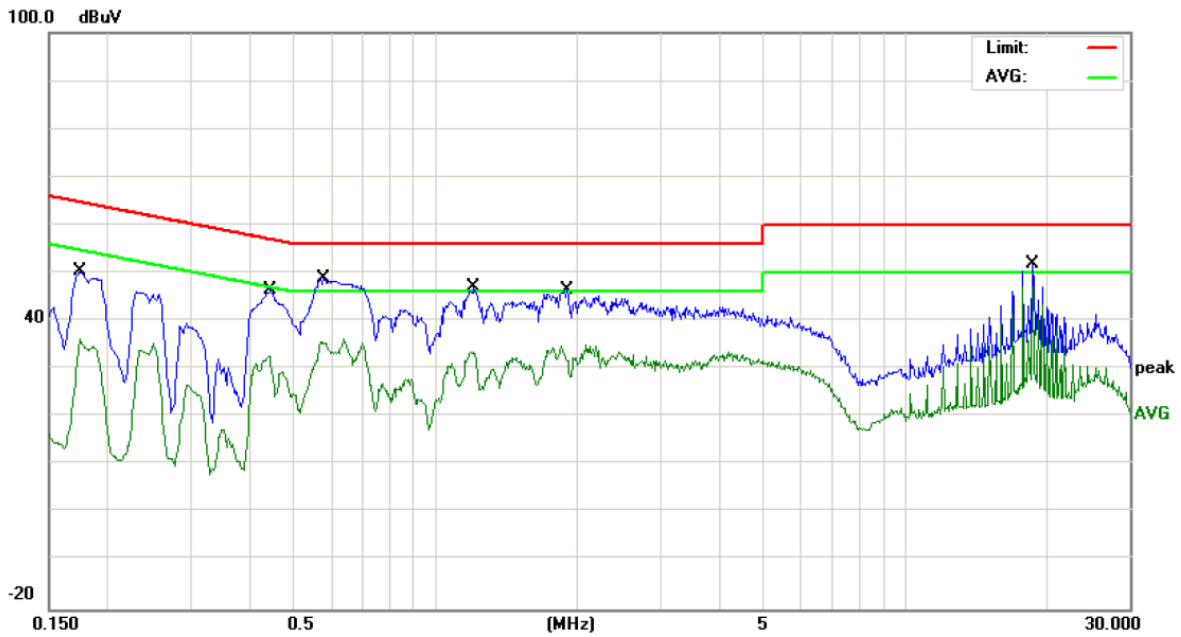

Site: Phase: *N* Temperature: 22  
 Limit: FCC Part 15B\_(0.15-30MHz) \_Main\_QP Power: AC 240V/50Hz Humidity: 51 %  
 Mode: Mode 5  
 Note:

No.	Mk.	Freq. MHz	Reading Level dBuV	Correct Factor dB	Measure- ment dBuV	Limit dBuV	Over dB	Detector	Comment
1		0.1737	40.23	10.05	50.28	64.78	-14.50	QP	
2		0.1737	26.27	10.05	36.32	54.78	-18.46	AVG	
3		0.4460	36.53	9.94	46.47	56.95	-10.48	QP	
4		0.4460	19.39	9.94	29.33	46.95	-17.62	AVG	
5	*	0.5778	39.04	9.82	48.86	56.00	-7.14	QP	
6		0.5778	16.06	9.82	25.88	46.00	-20.12	AVG	
7		1.2058	37.07	9.84	46.91	56.00	-9.09	QP	
8		1.2058	20.28	9.84	30.12	46.00	-15.88	AVG	
9		1.9018	36.81	9.76	46.57	56.00	-9.43	QP	
10		1.9018	20.69	9.76	30.45	46.00	-15.55	AVG	
11		18.7017	41.90	9.88	51.78	60.00	-8.22	QP	
12		18.7017	24.14	9.88	34.02	50.00	-15.98	AVG	

\*:Maximum data    x:Over limit    !:over margin

**7.2 RADIATED SPURIOUS EMISSION**

**7.2.1 Applicable Standard**

According to FCC Part 15.247(d) and 15.209 and DA 00-705

**7.2.2 Conformance Limit**

According to FCC Part 15.247(d): radiated emissions which fall in the restricted bands, as defined in §15.205(a), must also comply with the radiated emission limits specified in §15.209(a) (see §15.205(c)).  
According to FCC Part 15.205, Restricted bands

MHz	MHz	MHz	GHz
0.090-0.110	16.42-16.423	399.9-410	4.5-5.15
10.495-0.505	16.69475-16.69525	608-614	5.35-5.46
2.1735-2.1905	16.80425-16.80475	960-1240	7.25-7.75
4.125-4.128	25.5-25.67	1300-1427	8.025-8.5
4.17725-4.17775	37.5-38.25	1435-1626.5	9.0-9.2
4.20725-4.20775	73-74.6	1645.5-1646.5	9.3-9.5
6.215-6.218	74.8-75.2	1660-1710	10.6-12.7
6.26775-6.26825	123-138	2200-2300	14.47-14.5
8.291-8.294	149.9-150.05	2310-2390	15.35-16.2
8.362-8.366	156.52475-156.52525	2483.5-2500	17.7-21.4
8.37625-8.38675	156.7-156.9	2690-2900	22.01-23.12
8.41425-8.41475	162.0125-167.17	3260-3267	23.6-24.0
12.29-12.293	167.72-173.2	3332-3339	31.2-31.8
12.51975-12.52025	240-285	3345.8-3358	36.43-36.5
12.57675-12.57725	322-335.4	3600-4400	(2)
13.36-13.41			

20dBc in any 100 kHz bandwidth outside the operating frequency band. In case the emission fall within the restricted band specified on 15.205(a), then the 15.209(a) limit in the table below has to be followed.

Restricted Frequency(MHz)	Field Strength (µV/m)	Field Strength (dBµV/m)	Measurement Distance
0.009~0.490	2400/F(KHz)	20 log (uV/m)	300
0.490~1.705	2400/F(KHz)	20 log (uV/m)	30
1.705~30.0	30	29.5	30
30-88	100	40	3
88-216	150	43.5	3
216-960	200	46	3
Above 960	500	54	3

**Limits of Radiated Emission Measurement(Above 1000MHz)**

Frequency(MHz)	Class B (dBuV/m) (at 3M)	
	PEAK	AVERAGE
Above 1000	74	54

- Remark :
1. Emission level in dBuV/m=20 log (uV/m)
  2. Measurement was performed at an antenna to the closed point of EUT distance of meters.
  3. Distance extrapolation factor =40log(Specific distance/ test distance)( dB);  
Limit line=Specific limits(dBuV) + distance extrapolation factor.

**7.2.3 Measuring Instruments**

The Measuring equipment is listed in the section 6.3 of this test report.

### 7.2.4 Test Configuration

(a) For radiated emissions below 30MHz

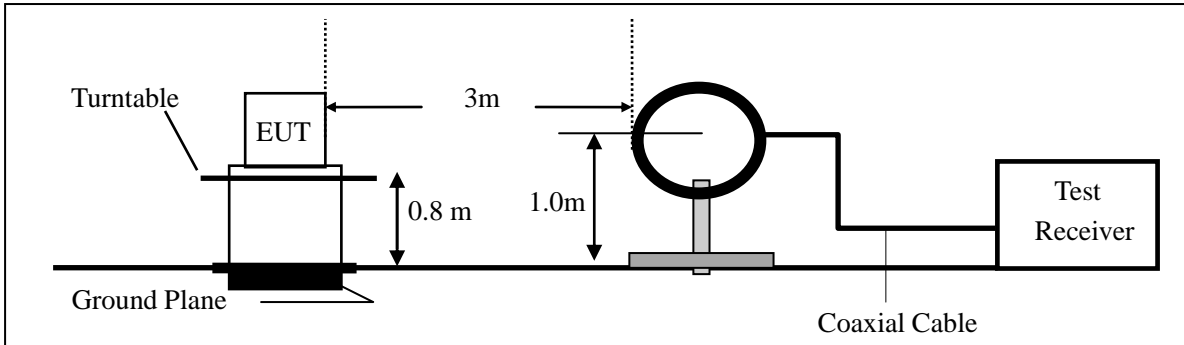

(b) For radiated emissions from 30MHz to 1000MHz

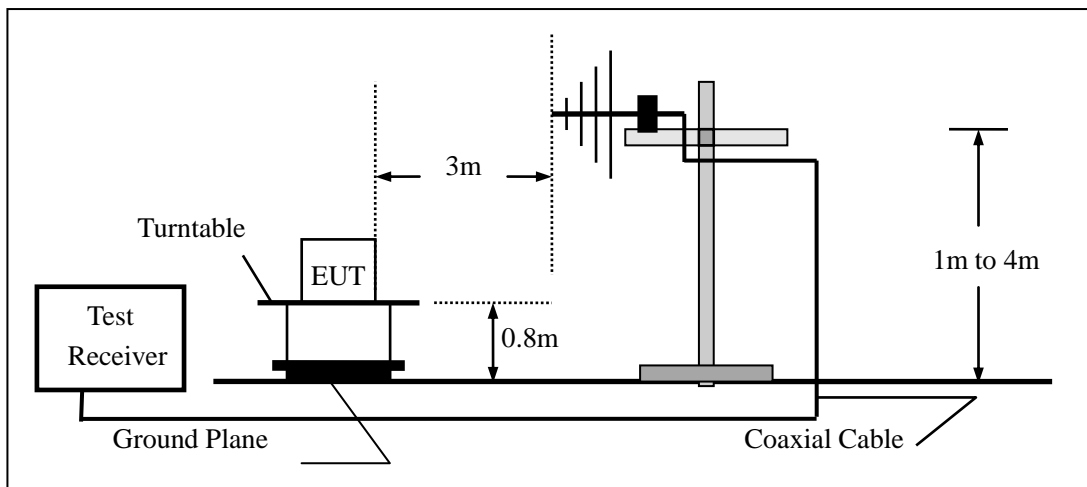

(c) For radiated emissions above 1000MHz

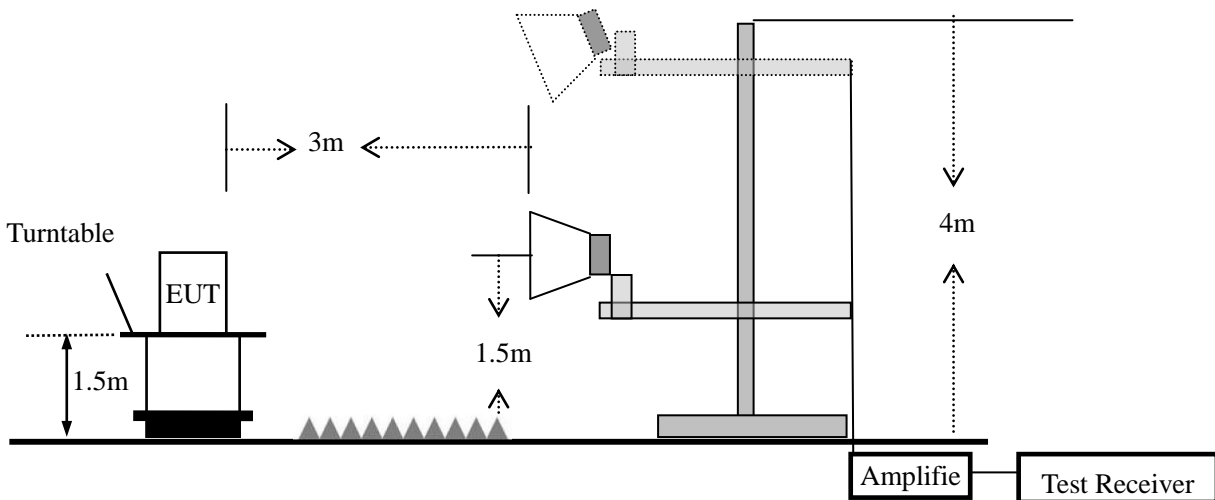

### 7.2.5 Test Procedure

The test site semi-anechoic chamber has met the requirement of NSA tolerance 4 dB according to the standards: ANSI C63.10-2013. The test distance is 3m. The setup is according to the requirements in Section 13.1.4.1 of ANSI C63.10-2013 and CAN/CSA-CEI/IEC CISPR 22.

This test is required for any spurious emission that falls in a Restricted Band, as defined in Section 15.205. It must be performed with the highest gain of each type of antenna proposed for use with the EUT.

Use the following spectrum analyzer settings:

Spectrum Parameter	Setting
Attenuation	Auto
Start Frequency	1000 MHz
Stop Frequency	10th carrier harmonic
RB / VB (emission in restricted band)	1 MHz / 1 MHz for Peak, 1 MHz / 10Hz for Average

Receiver Parameter	Setting
Attenuation	Auto
Start ~ Stop Frequency	9kHz~150kHz / RB 200Hz for QP
Start ~ Stop Frequency	150kHz~30MHz / RB 9kHz for QP
Start ~ Stop Frequency	30MHz~1000MHz / RB 120kHz for QP

- a. The measuring distance of at 3 m shall be used for measurements at frequency up to 1GHz. For frequencies above 1GHz, any suitable measuring distance may be used.
- b. The EUT was placed on the top of a rotating table 0.8 m for below 1GHz and 1.5m for above 1GHz the ground at a 3 meter. The table was rotated 360 degrees to determine the position of the highest radiation.
- c. The height of the equipment or of the substitution antenna shall be 0.8 m for below 1GHz and 1.5m for above 1GHz; the height of the test antenna shall vary between 1 m to 4 m. Both horizontal and vertical polarizations of the antenna are set to make the measurement.
- d. The initial step in collecting conducted emission data is a spectrum analyzer peak detector mode pre-scanning the measurement frequency range. Significant peaks are then marked and then Quasi Peak detector mode re-measured.
- e. If the Peak Mode measured value compliance with and lower than Quasi Peak Mode Limit, the EUT shall be deemed to meet QP Limits and then no additional QP Mode measurement performed.
- f. For the actual test configuration, please refer to the related Item –EUT Test Photos.

Note:

Both horizontal and vertical antenna polarities were tested and performed pretest to three orthogonal axis. The worst case emissions were reported

During the radiated emission test, the Spectrum Analyzer was set with the following configurations:

Frequency Band (MHz)	Function	Resolution bandwidth	Video Bandwidth
30 to 1000	QP	120 kHz	300 kHz
Above 1000	Peak	1 MHz	1 MHz
	Average	1 MHz	10 Hz

Note: for the frequency ranges below 30 MHz, a narrower RBW is used for these ranges but the measured value should add a RBW correction factor (RBWCF) where  $RBWCF [dB] = 10 \cdot \lg(100 [kHz]/\text{narrower RBW [kHz]})$ . , the narrower RBW is 1 kHz and RBWCF is 20 dB for the frequency 9 kHz to 150 kHz, and the narrower RBW is 10 kHz and RBWCF is 10 dB for the frequency 150 kHz to 30 MHz.

**7.2.6 Test Results**

■ Spurious Emission below 30MHz (9KHz to 30MHz)

EUT:	Embedded Touch PC	Model No.:	FT15A20M
Temperature:	20 °C	Relative Humidity:	48%
Test Mode:	Mode1/Mode2/Mode3/Mode4	Test By:	Allen Liu

Freq. (MHz)	Ant.Pol. H/V	Emission Level(dBuV/m)		Limit 3m(dBuV/m)		Over(dB)	
		PK	AV	PK	AV	PK	AV
--	--	--	--	--	--	--	--

Note: the amplitude of spurious emission that is attenuated by more than 20dB below the permissible limit has no need to be reported.

Distance extrapolation factor =  $20\log(\text{Specific distance/ test distance})$  ( dB);

Limit line=Specific limits(dBuV) + distance extrapolation factor

- Spurious Emission below 1GHz (30MHz to 1GHz)  
All the modulation modes have been tested, and the worst result was report as below:

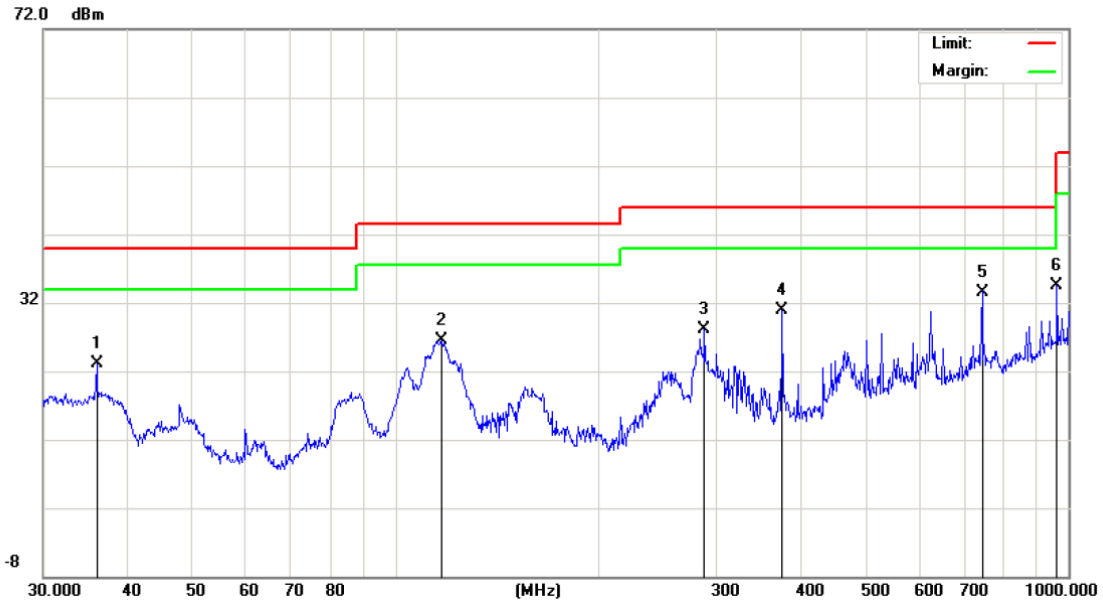

Site: Polarization: **Vertical** Temperature: 24  
 Limit: FCC\_PART15\_B\_03m\_QP Power: AC 120V/60Hz Humidity: 50 %  
 Mode: Mode 5  
 Note:

No.	Mk.	Freq. MHz	Reading Level dBm	Correct Factor dB	Measure- ment dBm	Limit dBm	Over dB	Antenna Height cm	Table Degree	Comment
1		36.0007	7.65	15.37	23.02	40.00	-16.98	QP		
2		116.9495	14.49	12.01	26.50	43.50	-17.00	QP		
3		287.9904	13.88	14.30	28.18	46.00	-17.82	QP		
4		375.9385	13.91	16.96	30.87	46.00	-15.13	QP		
5	*	744.8661	7.17	26.43	33.60	46.00	-12.40	QP		
6		962.1623	4.70	29.87	34.57	54.00	-19.43	QP		

\*:Maximum data    x:Over limit    !:over margin

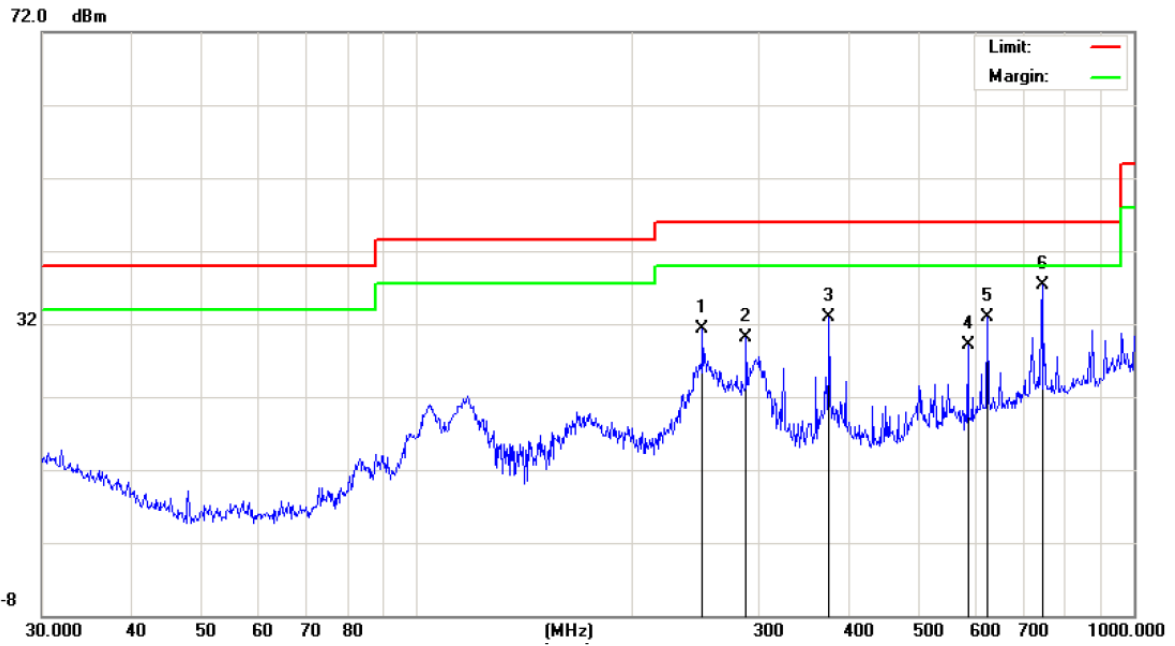

Site: Polarization: *Horizontal* Temperature: 24  
 Limit: FCC\_PART15\_B\_03m\_QP Power: AC 120V/60Hz Humidity: 50 %  
 Mode: Mode 5  
 Note:

No.	Mk.	Freq.	Reading Level	Correct Factor	Measurement	Limit	Over	Antenna Height	Table Degree
		MHz	dBm	dB	dBm	dBm	dB	cm	degree
1		250.3011	17.77	13.54	31.31	46.00	-14.69	QP	
2		287.9904	15.87	14.30	30.17	46.00	-15.83	QP	
3		375.9384	15.85	16.96	32.81	46.00	-13.19	QP	
4		586.8437	6.74	22.39	29.13	46.00	-16.87	QP	
5		625.0779	9.25	23.60	32.85	46.00	-13.15	QP	
6	*	744.8660	10.96	26.43	37.39	46.00	-8.61	QP	

\*:Maximum data    x:Over limit    !:over margin

■ Spurious Emission Above 1GHz (1GHz to 25GHz)

EUT:	Embedded Touch PC	Model No.:	FT15A20M
Temperature:	20 °C	Relative Humidity:	48%
Test Mode:	Mode1/Mode2/Mode3/Mode4	Test By:	Allen Liu

All the modulation modes have been tested, and the worst result was report as below:

Frequency (MHz)	Read Level (dBμV)	Cable loss (dB)	Antenna Factor dB/m	Preamp Factor (dB)	Emission Level (dBμV/m)	Limits (dBμV/m)	Margin (dB)	Remark	Comment
Low Channel (2412 MHz)-Above 1G									
4824.112	60.22	4.68	35.66	40.3	60.26	74	-13.74	Pk	Vertical
4824.112	45.32	4.68	35.66	40.3	45.36	54	-8.64	AV	Vertical
7236.147	56.55	7.10	36.22	38.85	61.02	74	-12.98	Pk	Vertical
7236.147	40.25	7.10	36.22	38.85	44.72	54	-9.28	AV	Vertical
4824.112	59.81	4.65	35.66	40.3	59.82	74	-14.18	Pk	Horizontal
4824.112	43.25	4.65	35.66	40.3	43.26	54	-10.74	AV	Horizontal
7236.044	59.11	7.11	36.24	38.85	63.61	74	-10.39	Pk	Horizontal
7236.044	39.69	7.11	36.24	38.85	44.19	54	-9.81	AV	Horizontal
Mid Channel (2437 MHz)-Above 1G									
4874.144	57.22	5.21	35.35	40.48	57.3	74	-16.7	Pk	Vertical
4874.144	41.02	5.21	35.35	40.48	41.1	54	-12.9	AV	Vertical
7311.056	54.35	7.10	36.53	38.86	59.12	74	-14.88	Pk	Vertical
7311.056	41.26	7.10	36.53	38.86	46.03	54	-7.97	AV	Vertical
4874.169	59.44	5.21	35.35	40.48	59.52	74	-14.48	Pk	Horizontal
4874.169	43.26	5.21	35.35	40.48	43.34	54	-10.66	AV	Horizontal
7311.412	56.54	7.10	36.53	38.86	61.31	74	-12.69	Pk	Horizontal
7311.412	39.58	7.10	36.53	38.86	44.35	54	-9.65	AV	Horizontal
High Channel (2462 MHz)- Above 1G									
4924.544	58.25	5.21	35.52	40.28	58.7	74	-15.3	Pk	Vertical
4924.544	41.02	5.21	35.52	40.28	41.47	54	-12.53	AV	Vertical
7386.411	56.52	7.10	36.29	38.92	60.99	74	-13.01	Pk	Vertical
7386.411	40.22	7.10	36.29	38.92	44.69	54	-9.31	AV	Vertical
4924.247	60.35	5.21	35.52	40.28	60.80	74.00	-13.20	Pk	Horizontal
4924.247	41.02	5.21	35.52	40.28	41.47	54.00	-12.53	AV	Horizontal
7386.458	55.32	7.10	36.29	38.92	59.79	74.00	-14.21	Pk	Horizontal
7386.458	39.04	7.10	36.29	38.92	43.51	54.00	-10.49	AV	Horizontal

- Note: (1) All Readings are Peak Value (VBW=3MHz) and Peak Value (VBW=10Hz).  
 (2) Emission Level= Reading Level+Probe Factor +Cable Loss.  
 (3)All other emissions more than 20dB below the limit



■ Spurious Emission in Band edge

EUT:	Embedded Touch PC	Model No.:	FT15A20M
Temperature:	20 °C	Relative Humidity:	48%
Test Mode:	Mode2/Mode3/Mode4	Test By:	Allen liu

All the modulation modes have been tested and other emissions more than 20dB below the limit, the worst result was report as below:

Frequency	Reading Level	Cable Loss	Antenna Factor	Preamp Factor	Emission Level	Limits	Margin	Detector	Comment
(MHz)	(dBμV)	(dB)	dB/m	(dB)	(dBμV/m)	(dBμV/m)	(dB)	Type	
820.11b									
2390	55.15	3.14	27.21	39.12	46.38	74	-27.62	Pk	Vertical
2390	36.33	3.14	27.21	39.12	27.56	54	-26.44	AV	Vertical
2483.5	56.12	3.58	27.7	39.45	47.95	74	-26.05	Pk	Horizontal
2483.5	36.25	3.58	27.7	39.45	28.08	54	-25.92	AV	Horizontal
802.11g									
2390	54.59	3.14	27.21	39.12	45.82	74	-28.18	Pk	Vertical
2390	36.32	3.14	27.21	39.12	27.55	54	-26.45	AV	Vertical
2483.5	56.36	3.58	27.7	39.45	48.19	74	-25.81	Pk	Horizontal
2483.5	36.12	3.58	27.7	39.45	27.95	54	-26.05	AV	Horizontal
802.11n(20)									
2390	55.24	3.14	27.21	39.12	46.47	74	-27.53	Pk	Vertical
2390	36.02	3.14	27.21	39.12	27.25	54	-26.75	AV	Vertical
2483.5	55.42	3.58	27.7	39.45	47.25	74	-26.75	Pk	Horizontal
2483.5	36.69	3.58	27.7	39.45	28.52	54	-25.48	AV	Horizontal
802.11n(40)									
2390	55.15	3.14	27.21	39.12	46.38	74	-27.62	Pk	Vertical
2390	36.21	3.14	27.21	39.12	27.44	54	-26.56	AV	Vertical
2483.5	57.22	3.58	27.7	39.45	49.05	74	-24.95	Pk	Horizontal
2483.5	39.66	3.58	27.7	39.45	31.49	54	-22.51	AV	Horizontal

■ Spurious Emission in Restricted Bands 3260MMHz- 18000MHz

EUT:	Embedded Touch PC	Model No.:	FT15A20M
Temperature:	20 °C	Relative Humidity:	48%
Test Mode:	Mode2/Mode3/Mode4	Test By:	Allen liu

All the modulation modes have been tested, the worst result was report as below:

Frequency	Reading Level	Cable Loss	Antenna Factor	Preamp Factor	Emission Level	Limits	Margin	Detector	Comment
(MHz)	(dBμV)	(dB)	dB/m	(dB)	(dBμV/m)	(dBμV/m)	(dB)	Type	
802.11b									
3260	63.02	4.24	27.21	38.43	56.04	74	-17.96	Pk	Vertical
3260	43.65	4.24	27.21	38.43	36.67	54	-17.33	AV	Vertical
3260	59.33	4.24	27.7	38.43	52.84	74	-21.16	Pk	Horizontal
3260	50.12	4.24	27.7	38.43	43.63	54	-10.37	AV	Horizontal
3332	65.52	4.36	27.21	40.80	56.29	74	-17.71	Pk	Vertical
3332	50.45	4.36	27.21	40.80	41.22	54	-12.78	AV	Vertical
3332	59.36	4.36	27.7	40.8	50.62	74	-23.38	Pk	Horizontal
3332	48.22	4.36	27.7	40.8	39.48	54	-14.52	AV	Horizontal
17789	62.05	12.14	27.21	40.72	60.68	74	-13.32	Pk	Vertical
17789	45.11	12.14	27.21	40.72	43.74	54	-10.26	AV	Vertical
17957	62.58	12.58	27.7	40.78	62.08	74	-11.92	Pk	Horizontal
17957	43.20	12.58	27.7	40.78	42.7	54	-11.3	AV	Horizontal

### **7.3 6DB BANDWIDTH**

#### **7.3.1 Applicable Standard**

According to FCC Part 15.247(a)(2) and KDB 558074 DTS 01 Meas. Guidance v03r04

#### **7.3.2 Conformance Limit**

The minimum permissible 6dB bandwidth is 500 kHz.

#### **7.3.3 Measuring Instruments**

The Measuring equipment is listed in the section 6.3 of this test report.

#### **7.3.4 Test Setup**

Please refer to Section 6.1 of this test report.

#### **7.3.5 Test Procedure**

The testing follows KDB 558074 DTS 01 Meas. Guidance v03r04

The RF output of EUT was connected to the spectrum analyzer by RF cable and attenuator.

The path loss was compensated to the results for each measurement.

Set to the maximum power setting and enable the EUT transmit continuously.

The EUT was operating in controlled its channel.

Use the following spectrum analyzer settings:

Span = the frequency band of operation

RBW = 100KHz

VBW  $\geq$  3\*RBW

Sweep = auto

Detector function = peak

Trace = max hold

**7.3.6 Test Results**

EUT:	Embedded Touch PC	Model No.:	FT15A20M
Temperature:	20 °C	Relative Humidity:	48%
Test Mode:	Mode1/Mode2/Mode3/Mode4	Test By:	Allen Liu

Channel	Frequency (MHz)	6dB bandwidth (kHz)	Limit (kHz)	Result
802.11b				
1	2412	10103.000	500	Pass
6	2437	8155.000	500	Pass
11	2462	8660.000	500	Pass
802.11g				
1	2412	15979.000	500	Pass
6	2437	9270.000	500	Pass
11	2462	12014.000	500	Pass
802.11n HT20				
1	2412	17640.000	500	Pass
6	2437	7931.000	500	Pass
11	2462	15123.000	500	Pass
802.11n HT40				
3	2422	13800.000	500	Pass
6	2437	6809.000	500	Pass
9	2452	35857.000	500	Pass

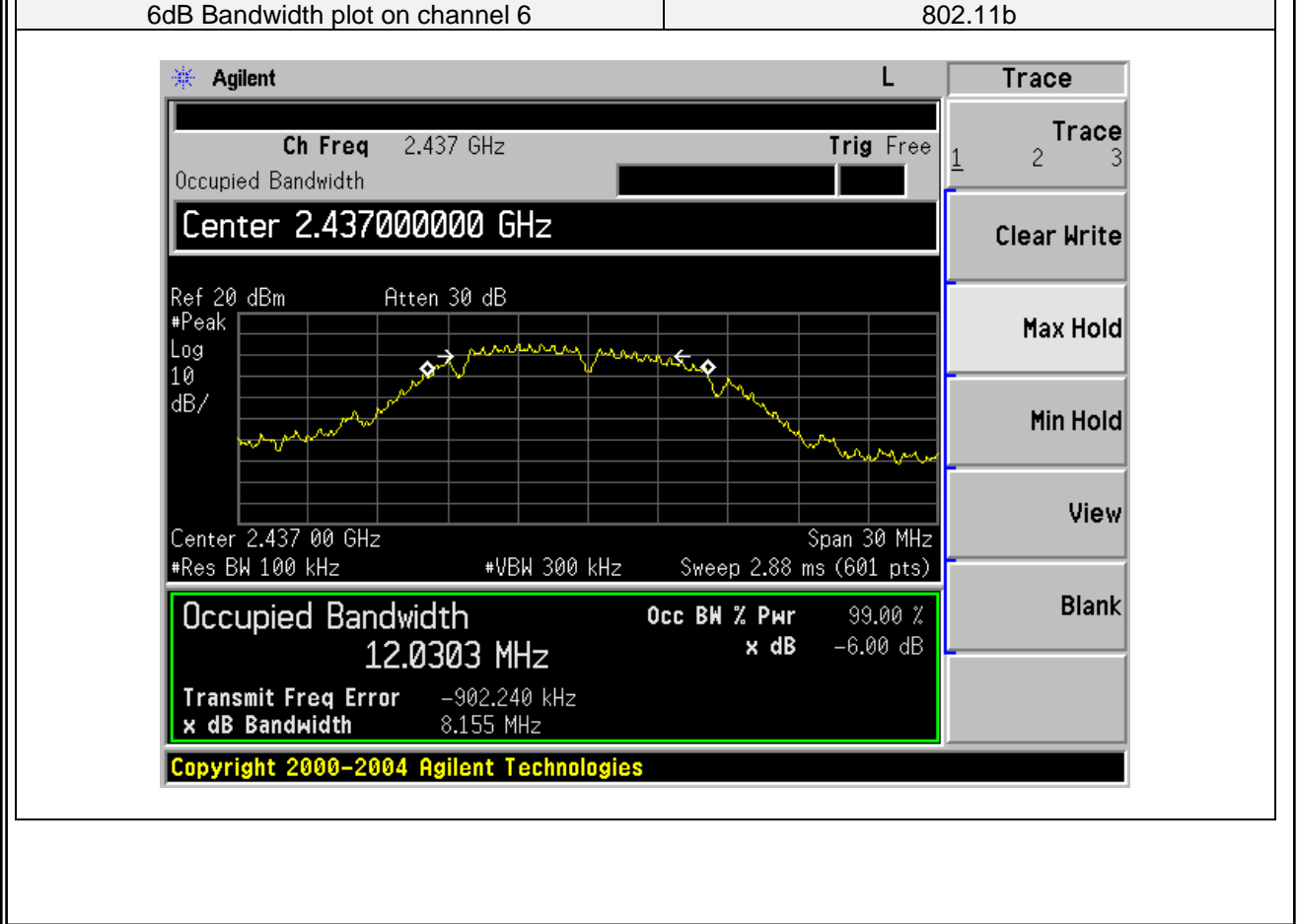
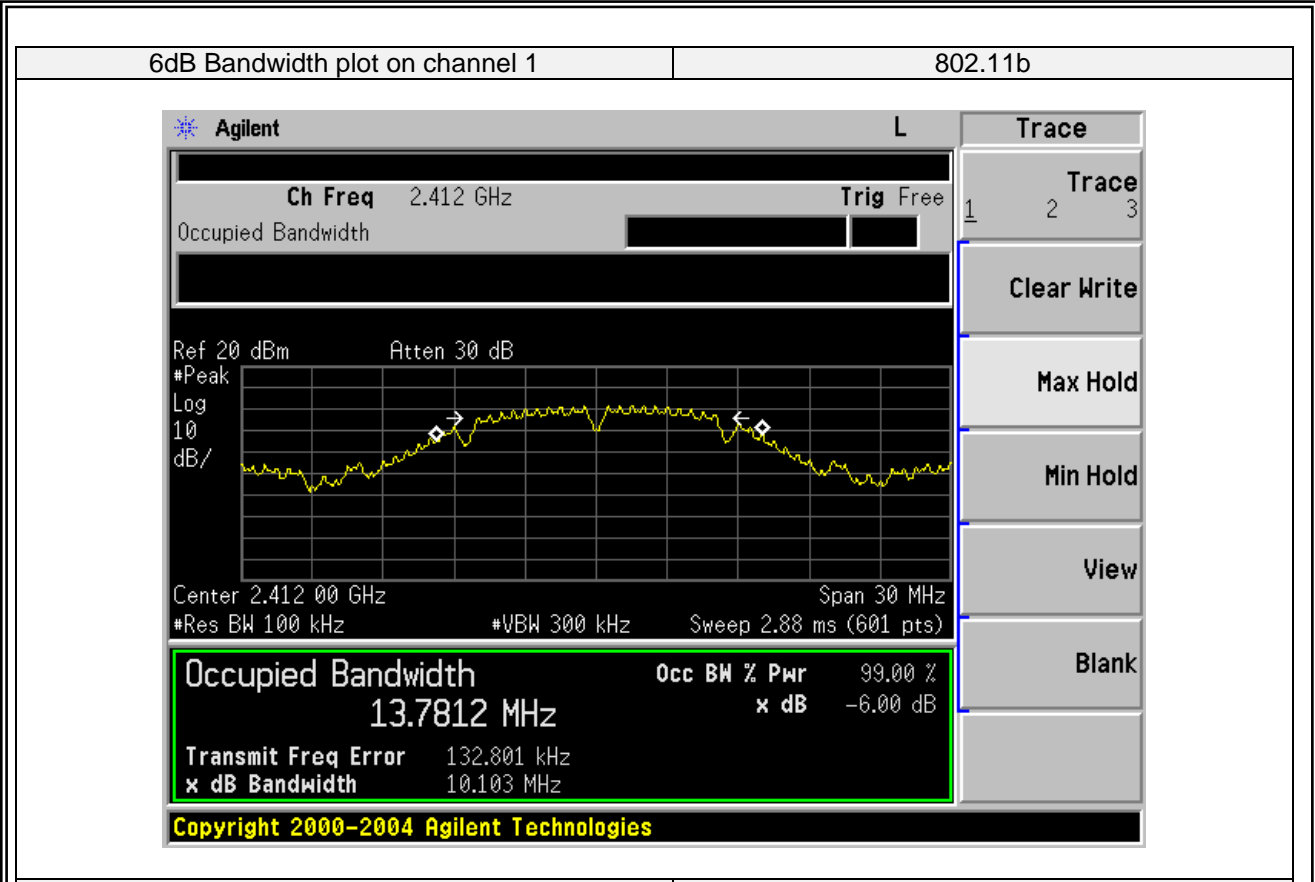

6dB Bandwidth plot on channel 11

802.11b

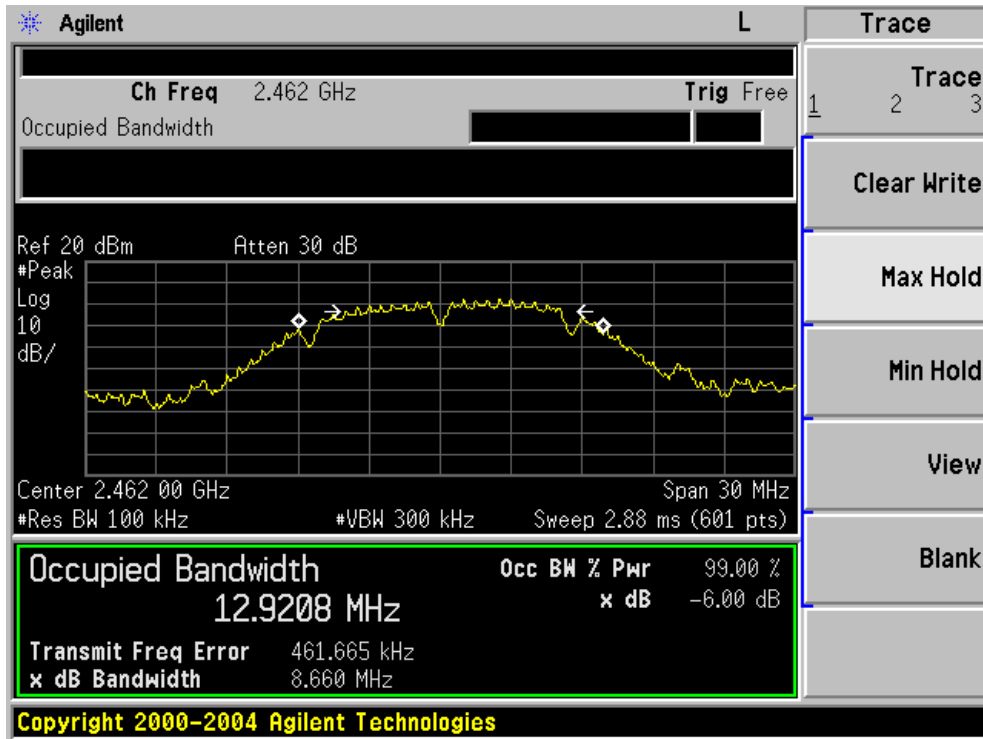

6dB Bandwidth plot on channel 1

802.11g

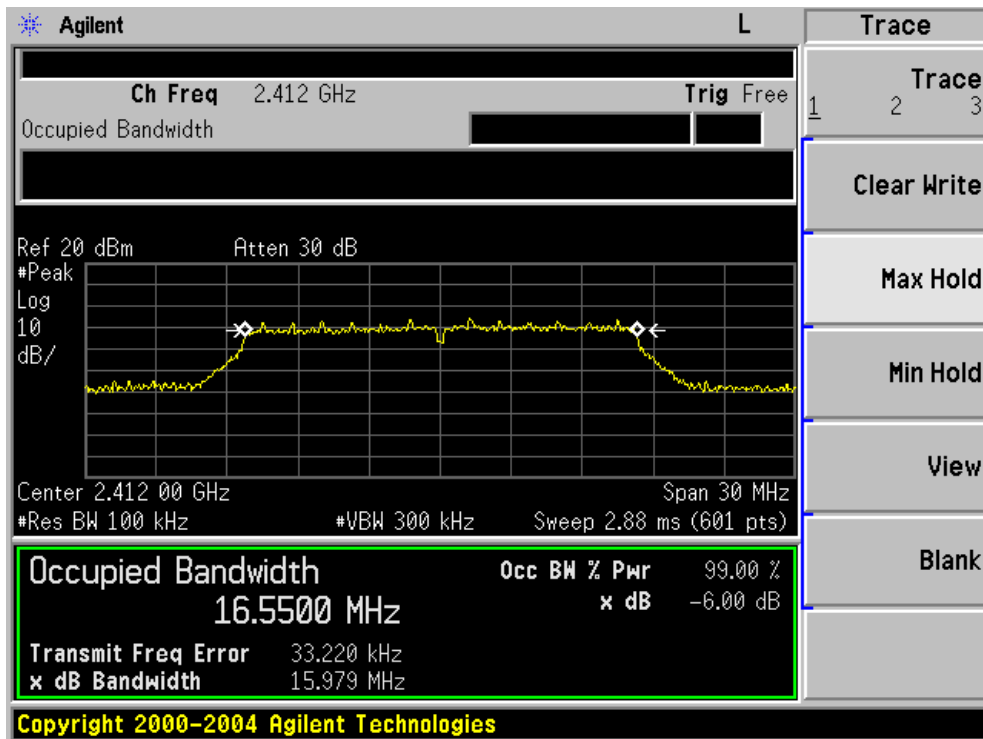

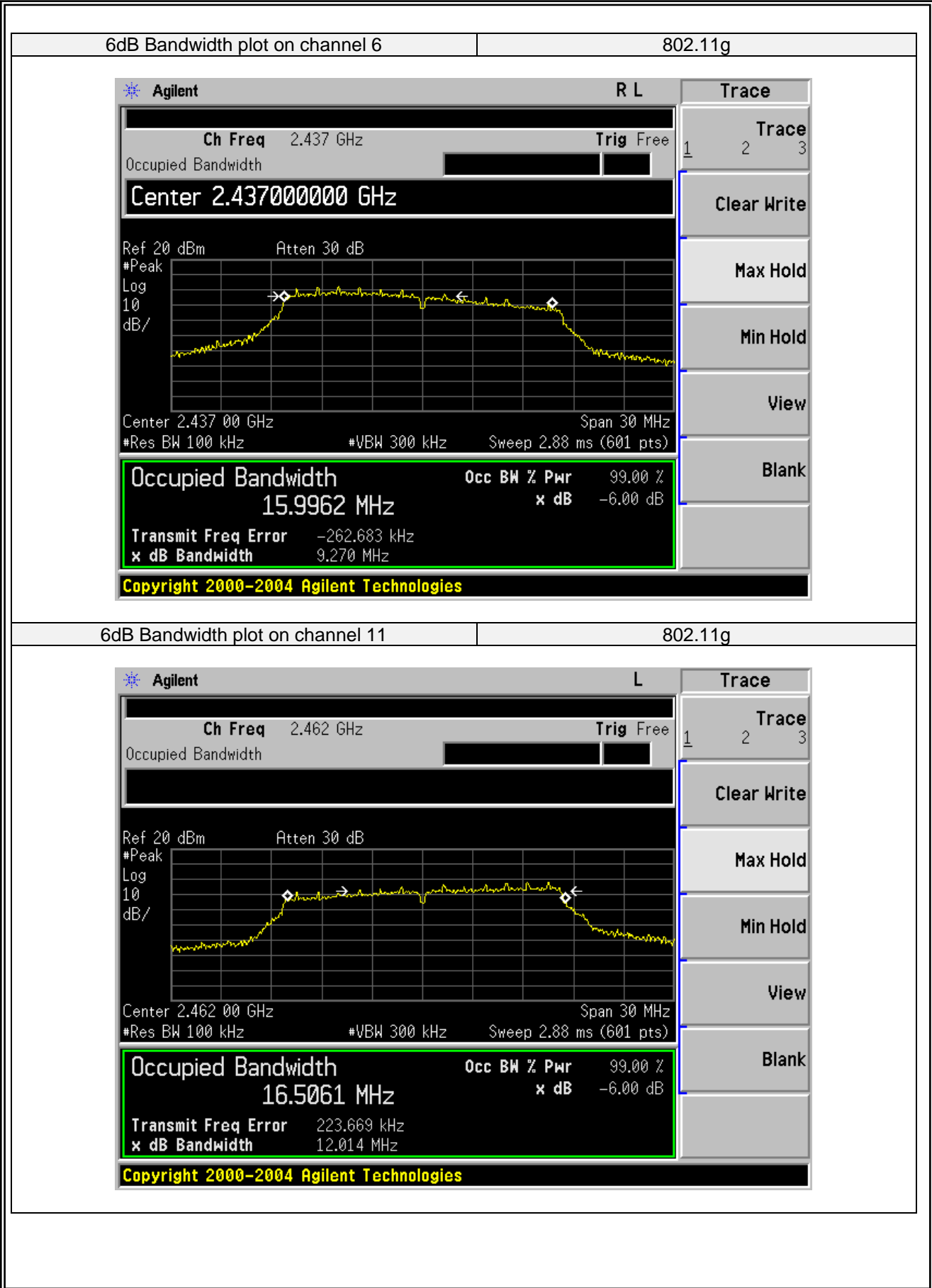

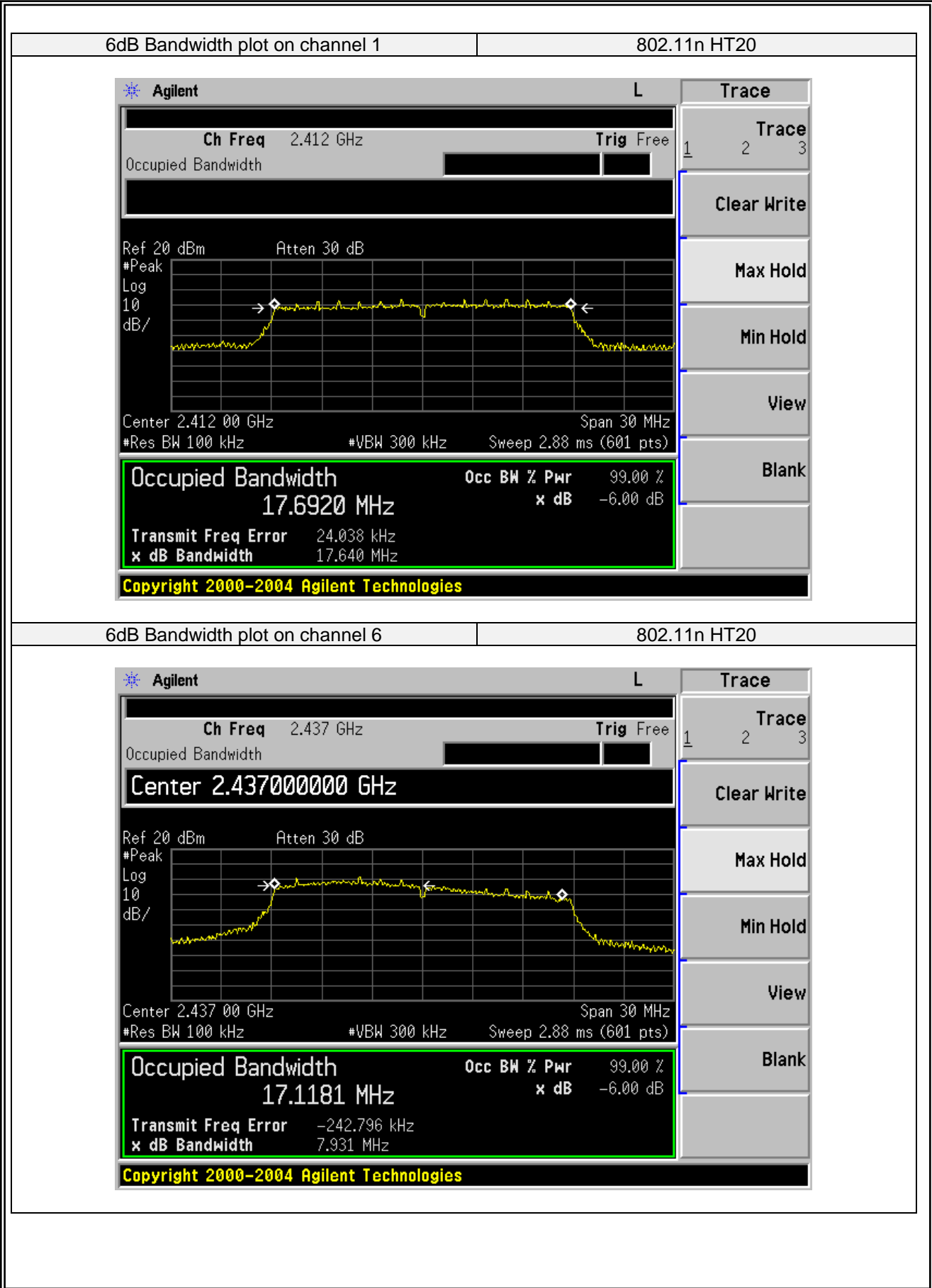

6dB Bandwidth plot on channel 11

802.11n HT20

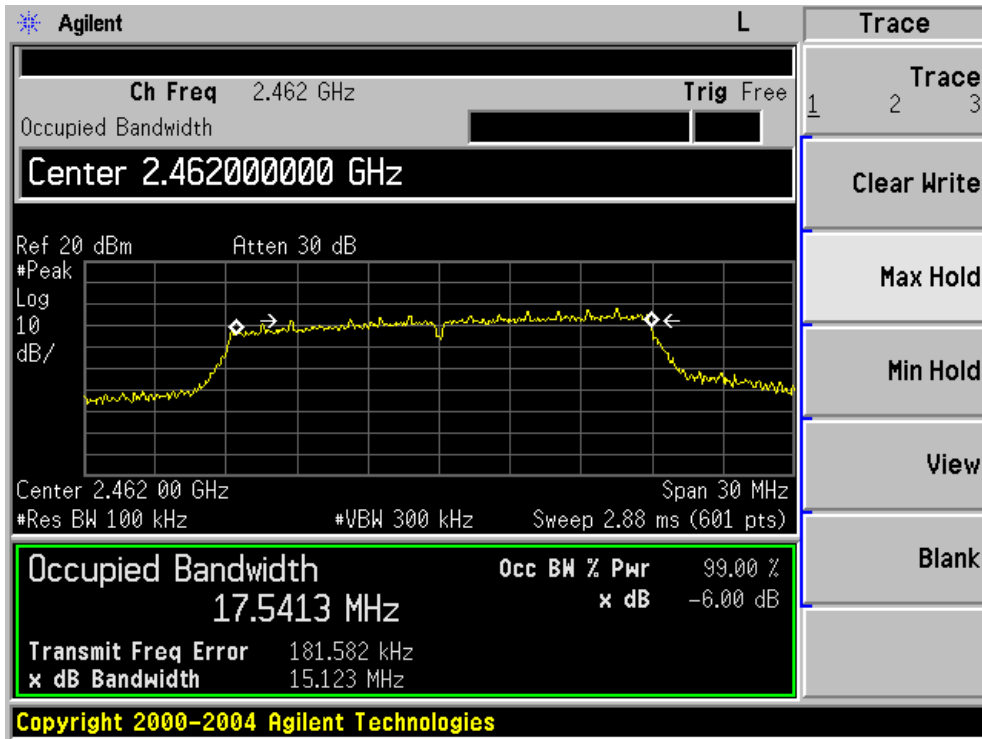

6dB Bandwidth plot on channel 3

802.11n HT40

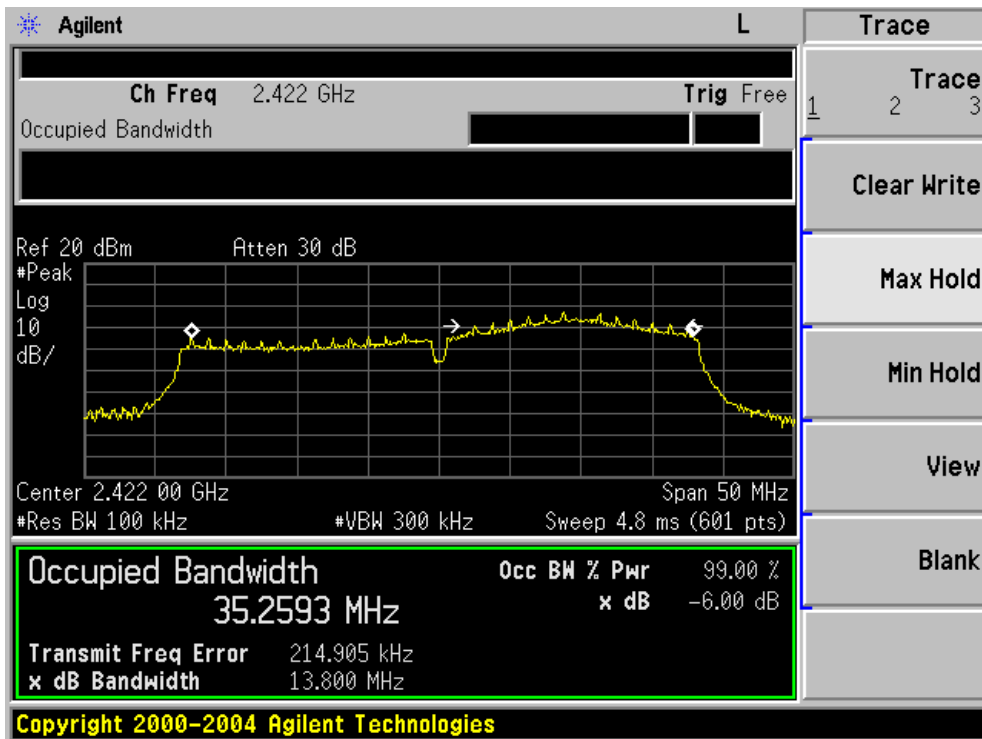



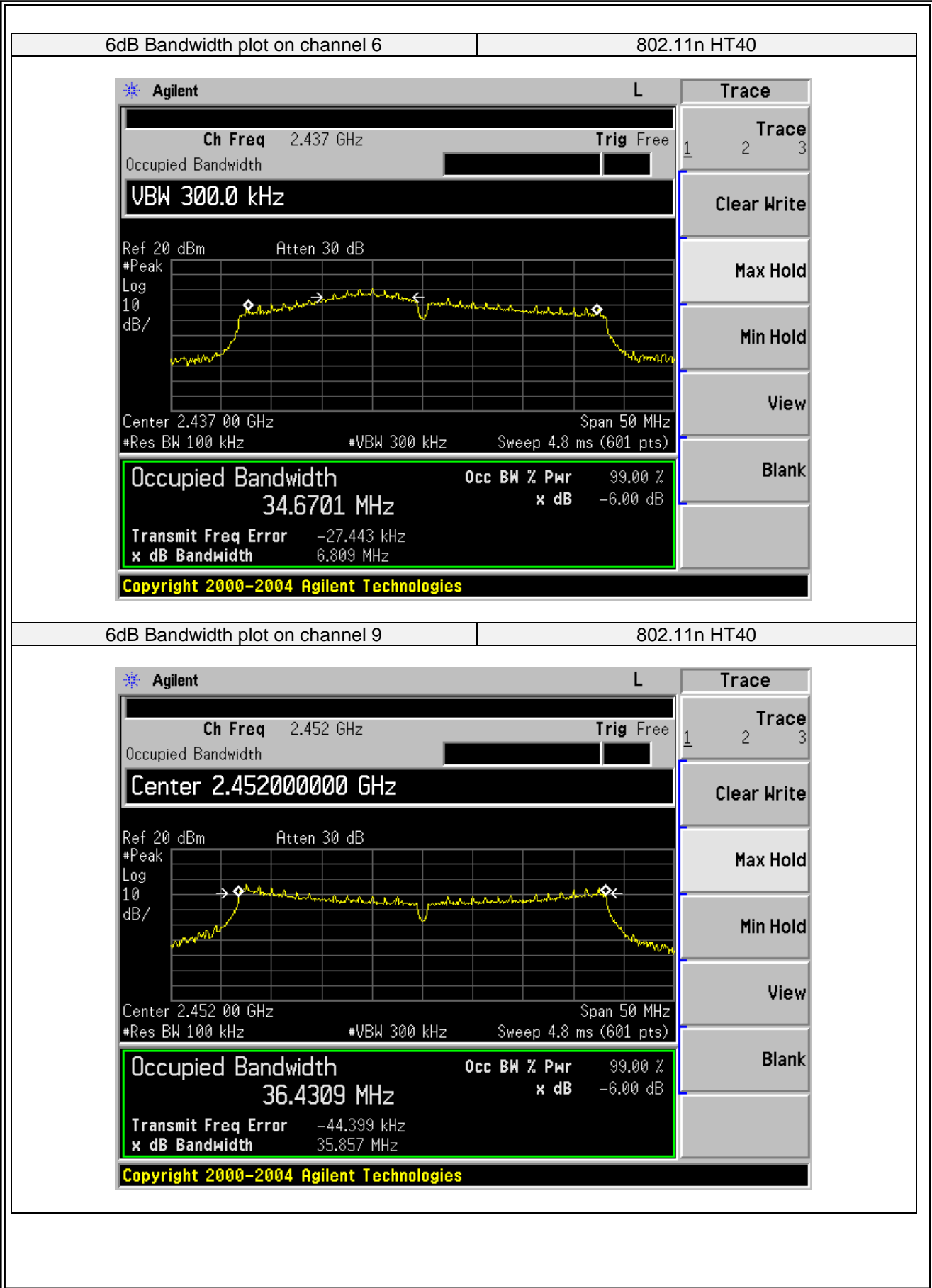

## **7.4 20DB BANDWIDTH**

### **7.4.1 Applicable Standard**

According to FCC Part 15.247(a)(2) and KDB 558074 DTS 01 Meas. Guidance v03r04

### **7.4.2 Conformance Limit**

The minimum permissible 6dB bandwidth is 500 kHz.

### **7.4.3 Measuring Instruments**

The Measuring equipment is listed in the section 6.3 of this test report.

### **7.4.4 Test Setup**

Please refer to Section 6.1 of this test report.

### **7.4.5 Test Procedure**

The testing follows KDB 558074 DTS 01 Meas. Guidance v03r04

The RF output of EUT was connected to the spectrum analyzer by RF cable and attenuator.

The path loss was compensated to the results for each measurement.

Set to the maximum power setting and enable the EUT transmit continuously.

The EUT was operating in controlled its channel.

Use the following spectrum analyzer settings:

Span = the frequency band of operation

RBW = 100KHz

VBW  $\geq$  3\*RBW

Sweep = auto

Detector function = peak

Trace = max hold

**7.4.6 Test Results**

EUT:	Embedded Touch PC	Model No.:	FT15A20M
Temperature:	20 °C	Relative Humidity:	48%
Test Mode:	Mode1/Mode2/Mode3/Mode4	Test By:	Allen Liu

Band	Frequency (MHz)	20dB bandwidth (kHz)	Limit (kHz)	Result
802.11b	2437	15169.000	N/A	Pass
802.11g	2437	17823.000	N/A	Pass
802.11n HT20	2437	18580.000	N/A	Pass
802.11n HT40	2437	37091.000	N/A	Pass

20dB Bandwidth plot on channel 6

802.11b

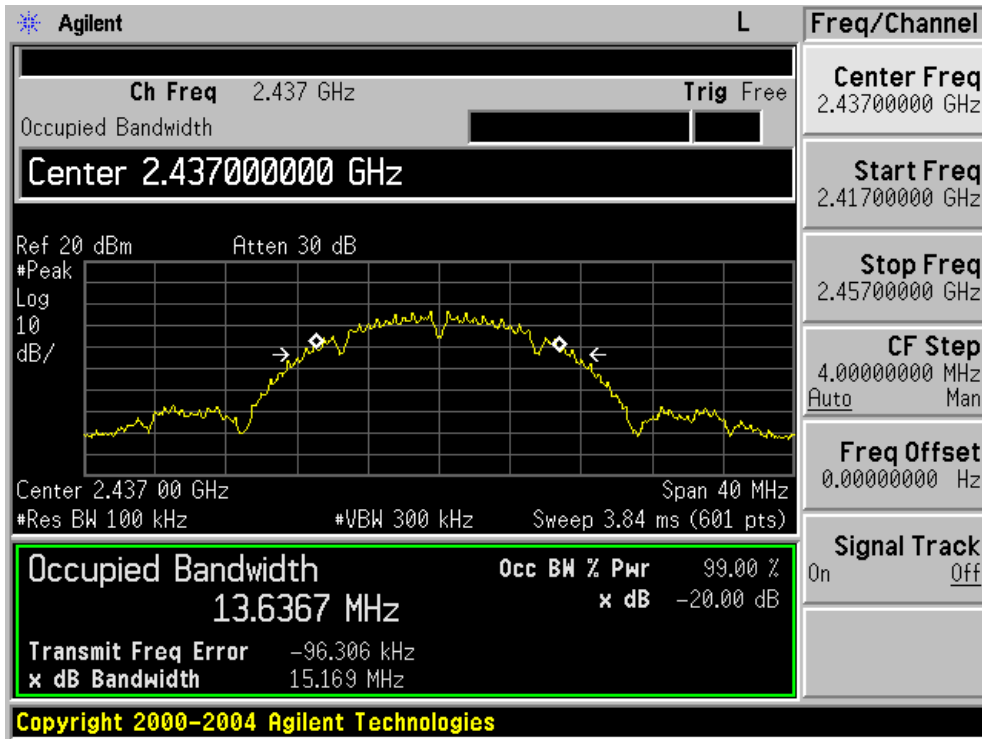

20dB Bandwidth plot on channel 6

802.11g

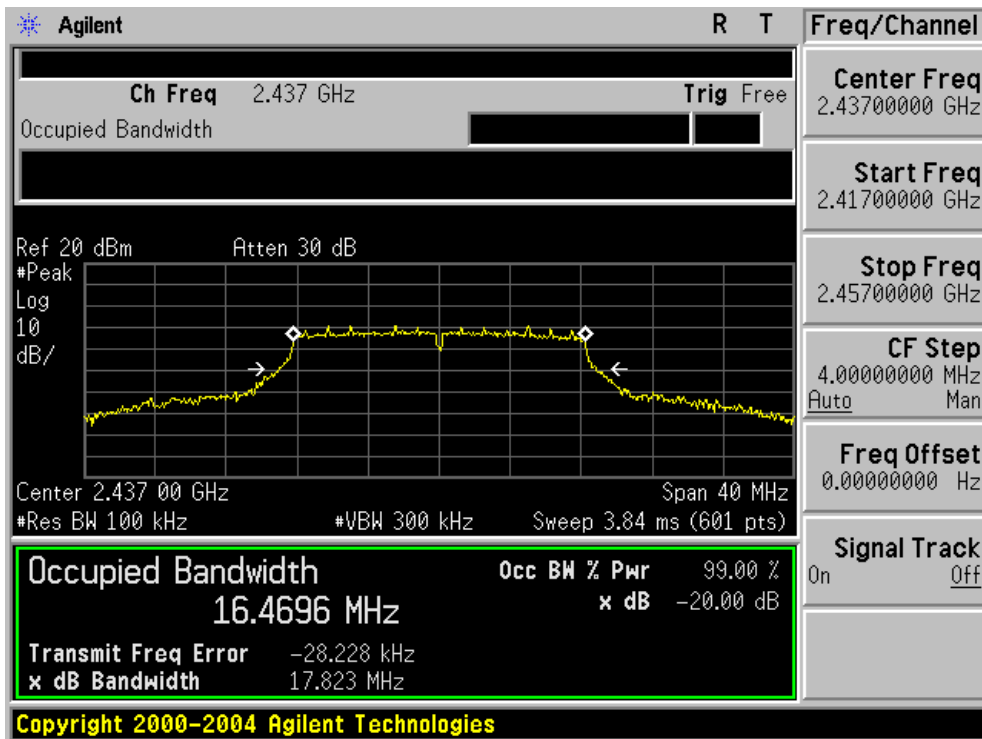

20dB Bandwidth plot on channel 6

802.11n HT20

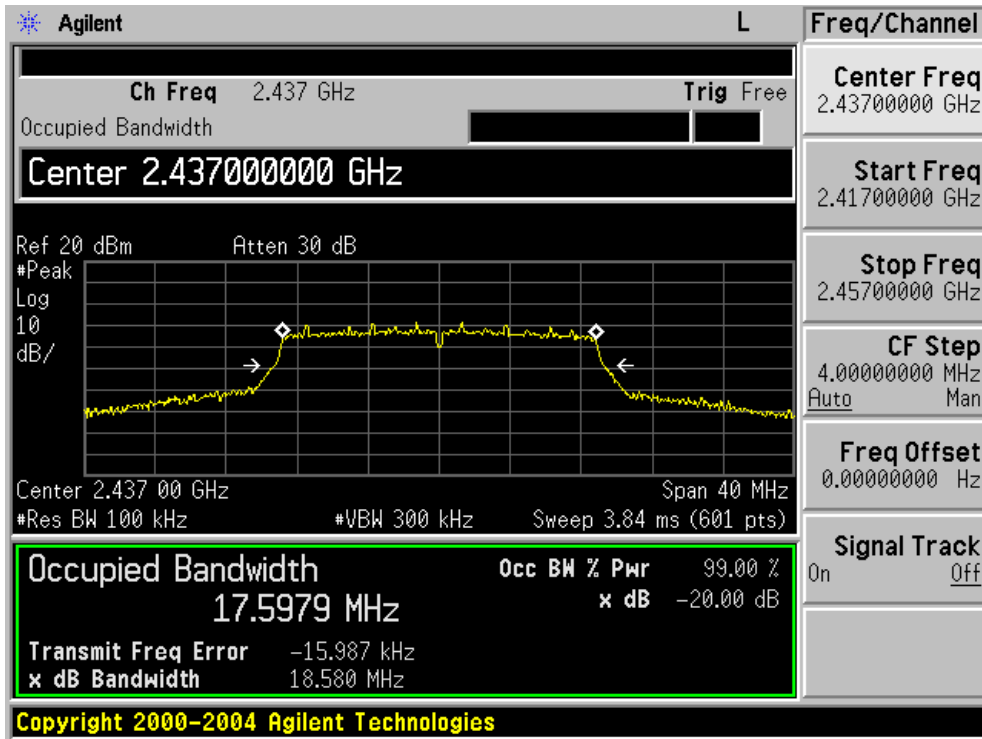

20dB Bandwidth plot on channel 6

802.11n HT40

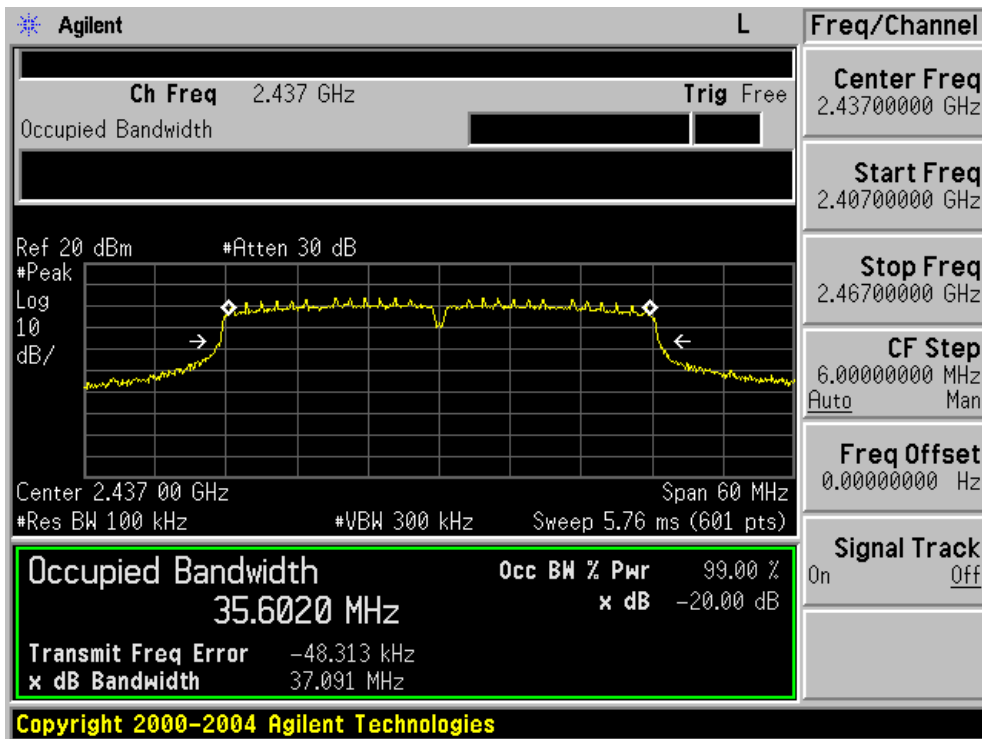

## 7.5 DUTY CYCLE

### 7.5.1 Applicable Standard

According to KDB 558074)6)b), issued 06/09/2015

### 7.5.2 Conformance Limit

No limit requirement.

### 7.5.3 Measuring Instruments

The Measuring equipment is listed in the section 6.3 of this test report.

### 7.5.4 Test Setup

Please refer to Section 6.1 of this test report.

### 7.5.5 Test Procedure

The zero-span mode on a spectrum analyzer or EMI receiver if the response time and spacing between bins on the sweep are sufficient to permit accurate measurements of the on and off times of the transmitted signal. Set the center frequency of the instrument to the center frequency of the transmission. Set  $RBW \geq OBW$  if possible; otherwise, set RBW to the largest available value. Set  $VBW \geq RBW$ . Set detector = peak or average. The zero-span measurement method shall not be used unless both RBW and VBW are  $> 50/T$  and the number of sweep points across duration T exceeds 100. (For example, if VBW and/or RBW are limited to 3 MHz, then the zero-span method of measuring duty cycle shall not be used if  $T \leq 16.7$  microseconds.)

The transmitter output is connected to the Spectrum Analyzer. We tested according to the zero-span measurement method, 6.0)b) in KDB 558074(issued 06/09/2015)

The largest available value of RBW is 8 MHz and VBW is 50 MHz. The zero-span method of measuring duty cycle shall not be used if  $T \leq 6.25$  microseconds. ( $50/6.25 = 8$ )

The zero-span method was used because all measured T data are  $> 6.25$  microseconds and both RBW and VBW are  $> 50/T$ .

The RF output of EUT was connected to the spectrum analyzer by RF cable and attenuator.

The path loss was compensated to the results for each measurement.

Set to the maximum power setting and enable the EUT transmit continuously.

The EUT was operating in controlled its channel.

Use the following spectrum analyzer settings:

Span = Zero Span

RBW = 8MHz(the largest available value)

VBW = 8MHz ( $\geq$  RBW)

Number of points in Sweep  $>100$

Detector function = peak

Trace = Clear write

Measure  $T_{total}$  and  $T_{on}$

Calculate Duty Cycle =  $T_{on} / T_{total}$  and Duty Cycle Factor= $10 \cdot \log(1/\text{Duty Cycle})$

**7.5.6 Test Results**

EUT:	Embedded Touch PC	Model No.:	FT15A20M
Temperature:	20 °C	Relative Humidity:	48%
Test Mode:	Mode1/Mode2/Mode3/Mode4	Test By:	Allen Liu

Mode	Data rate	Channel	T <sub>on</sub>	T <sub>total</sub>	Duty Cycle	Duty Cycle Factor (dB)
802.11b	1Mbps	6	8283.7	8417	0.9842	0.069
802.11g	6Mbps	6	1267	1417	0.8941	0.486
802.11n HT20	MCS0	6	1183	1333	0.8875	0.518
802.11n HT40	MCS0	6	550	683.3	0.8049	0.942

Note: All the modulation modes were tested, the data of the worst mode are described in the following table.

Duty Cycle plot on channel 6

802.11b

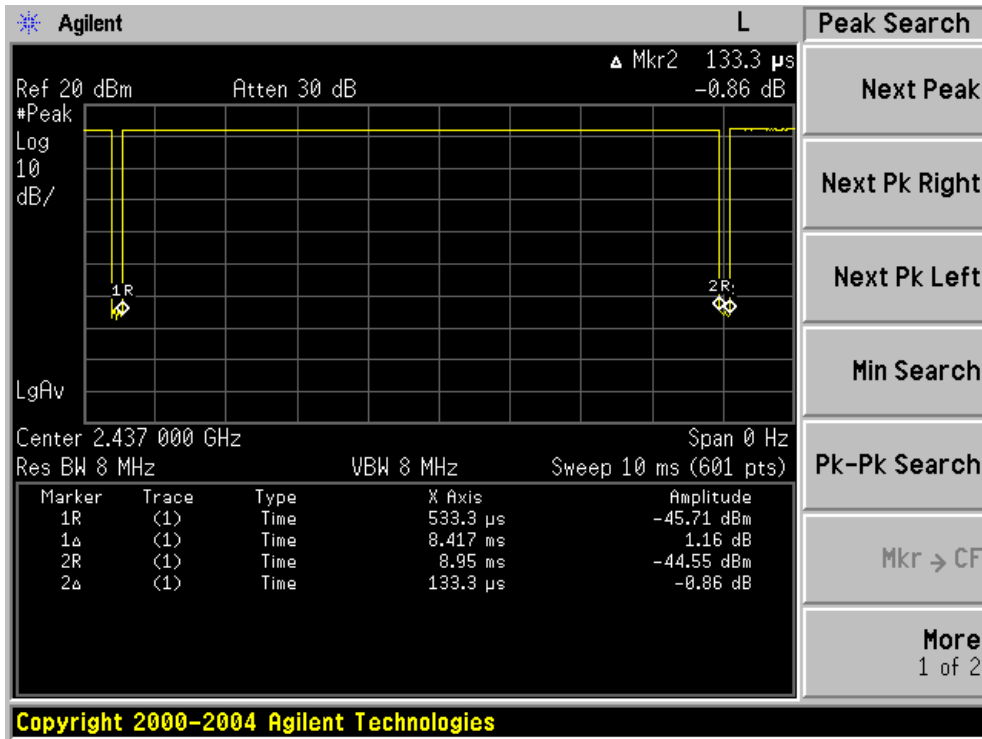

Duty Cycle plot on channel 6

802.11g

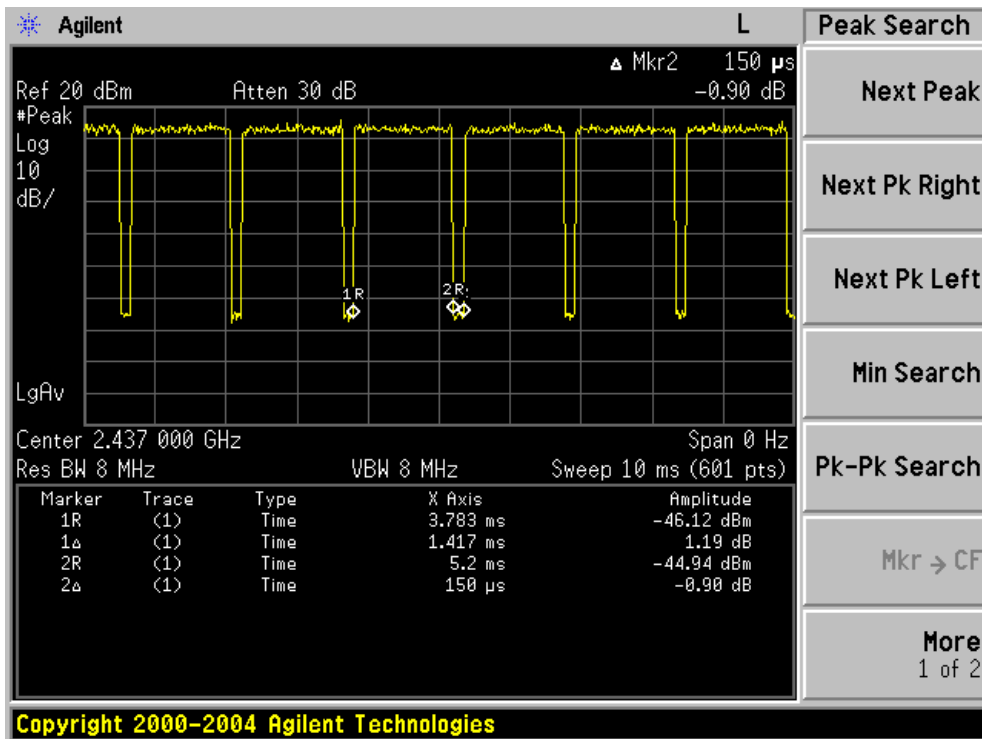



Duty Cycle plot on channel 6

802.11n HT20

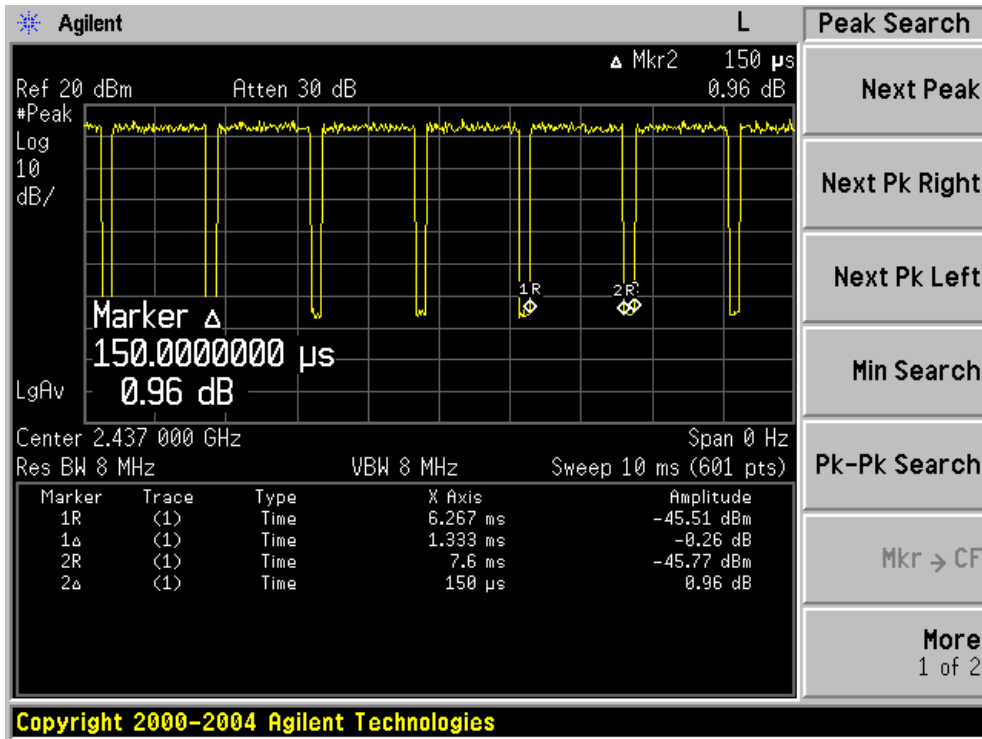

Duty Cycle plot on channel 6

802.11n HT40

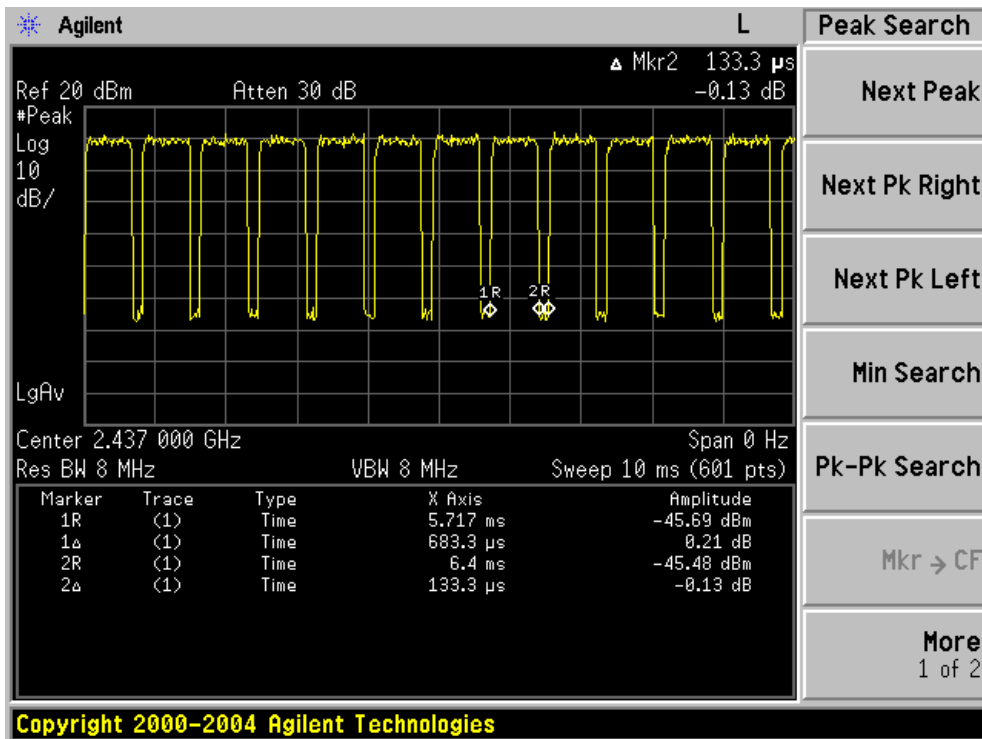

## 7.6 MAXIMUM OUTPUT POWER

### 7.6.1 Applicable Standard

According to FCC Part 15.247(b)(3) and KDB 558074 DTS 01 Meas. Guidance v03r04

### 7.6.2 Conformance Limit

The maximum peak conducted output power of the intentional radiator for systems using digital modulation in the 2400 - 2483.5 MHz bands shall not exceed: 1 Watt (30dBm). If transmitting antenna of directional gain greater than 6dBi is used, the peak output power from the intentional radiator shall be reduced below the above stated value by the amount in dB that the directional gain of the antenna exceeds 6 dBi. In case of point-to-point operation, the limit has to be reduced by 1dB for every 3dB that the directional gain of the antenna exceeds 6dBi.

### 7.6.3 Measuring Instruments

The Measuring equipment is listed in the section 6.3 of this test report.

### 7.6.4 Test Setup

Please refer to Section 6.1 of this test report.

### 7.6.5 Test Procedure

The testing follows KDB 558074 DTS 01 Meas. Guidance v03r04 section 9.2.2

The RF output of EUT was connected to the spectrum analyzer by RF cable and attenuator.

The path loss was compensated to the results for each measurement.

Set to the maximum power setting and enable the EUT transmit continuously.

The EUT was operating in controlled its channel.

- a) Set instrument center frequency to DTS channel center frequency.
- b) Set span to at least 1.5 times the OBW.
- c) Set RBW = 1-5% of the OBW, not to exceed 1MHz.
- d) Set VBW  $\geq 3 \times$  RBW.
- e) Number of points in sweep  $\geq 2 \times$  span / RBW.  
(This gives bin-to-bin spacing  $\leq$  RBW/2, so that narrowband signals are not lost between frequency bins.)
- f) Sweep time = auto.
- g) Detector = RMS (i.e., power averaging), if available. Otherwise, use sample detector mode.
- h) If transmit duty cycle < 98 %, use a sweep trigger with the level set to enable triggering only on full power pulses. The transmitter shall operate at maximum power control level for the entire duration of every sweep. If the EUT transmits continuously (i.e., with no off intervals) or at duty cycle  $\geq 98$  %, and if each transmission is entirely at the maximum power control level, then the trigger shall be set to "free run".
- i) Trace average at least 100 traces in power averaging (i.e., RMS) mode.
- j) Compute power by integrating the spectrum across the OBW of the signal using the instrument's band power measurement function, with band limits set equal to the OBW band edges. If the instrument does not have a band power function, sum the spectrum levels (in power units) at intervals equal to the RBW extending across the entire OBW of the spectrum.

**7.6.6 Test Results**

EUT:	Embedded Touch PC	Model No.:	FT15A20M
Temperature:	20 °C	Relative Humidity:	48%
Test Mode:	Mode1/Mode2/Mode3/Mode4	Test By:	Allen Liu

Test Channel	Frequency (MHz)	Power Setting	Average Output Power (dBm)	LIMIT (dBm)	Verdict
<b>802.11b</b>					
1	2412	Default	10.11	30	PASS
6	2437	Default	11.15	30	PASS
11	2462	Default	10.44	30	PASS
<b>802.11g</b>					
1	2412	Default	6.76	30	PASS
6	2437	Default	6.85	30	PASS
11	2462	Default	7.59	30	PASS
<b>802.11n HT20</b>					
1	2412	Default	5.72	30	PASS
6	2437	Default	5.68	30	PASS
11	2462	Default	6.96	30	PASS
<b>802.11n HT40</b>					
3	2422	Default	6.46	30	PASS
6	2437	Default	6.49	30	PASS
9	2452	Default	5.56	30	PASS

Output Power plot on channel 1

802.11b

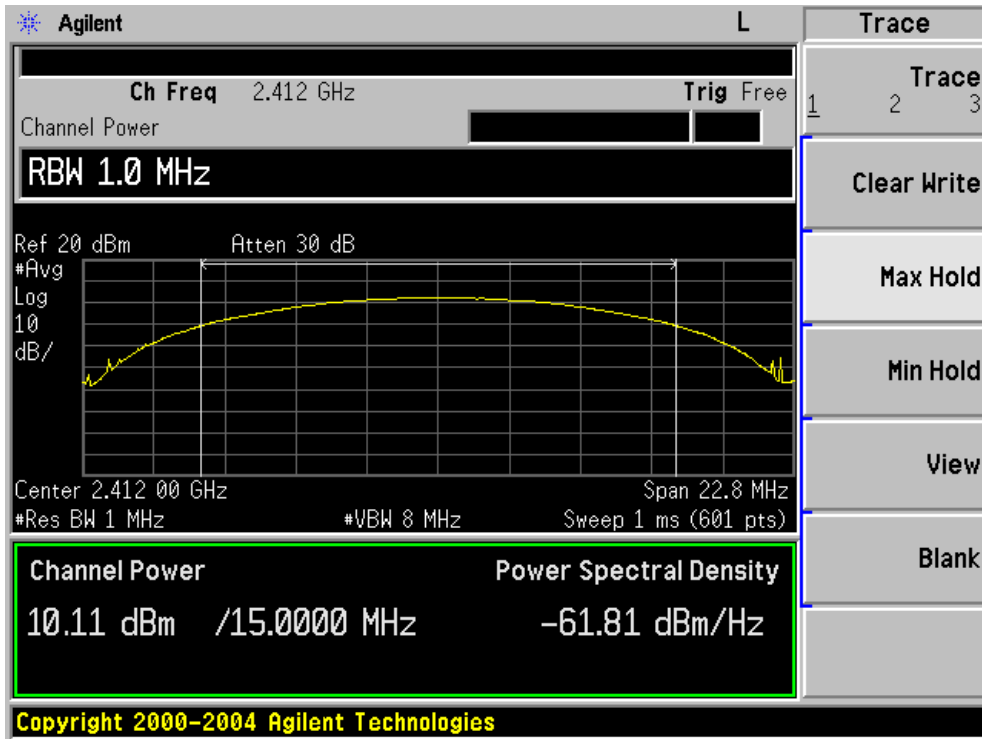

Output Power plot on channel 6

802.11b

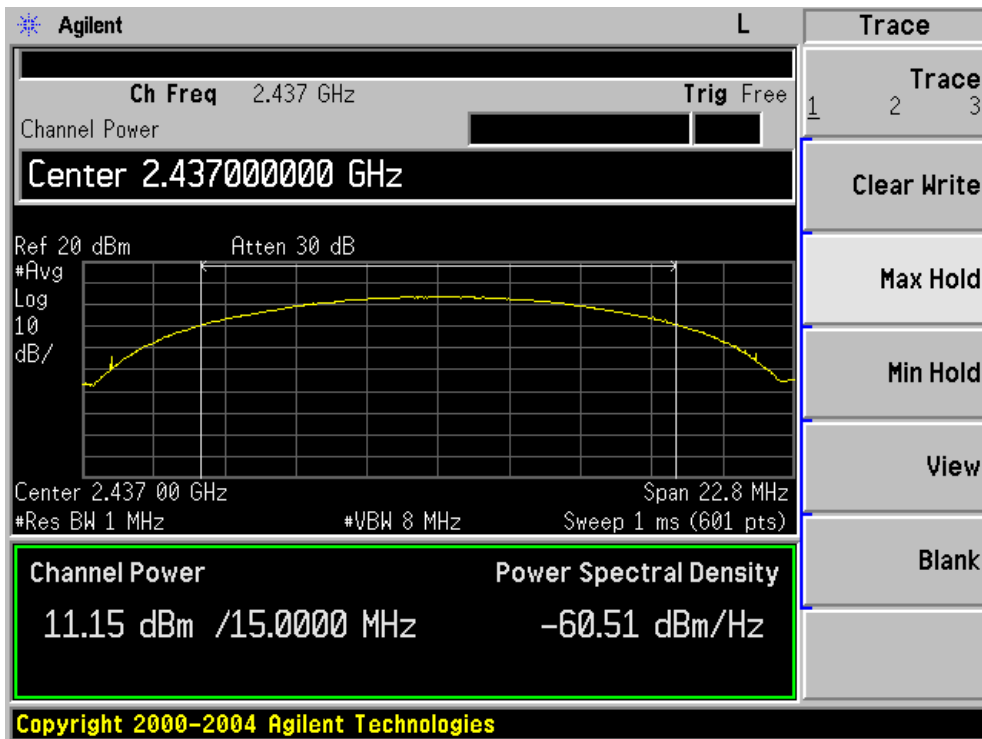

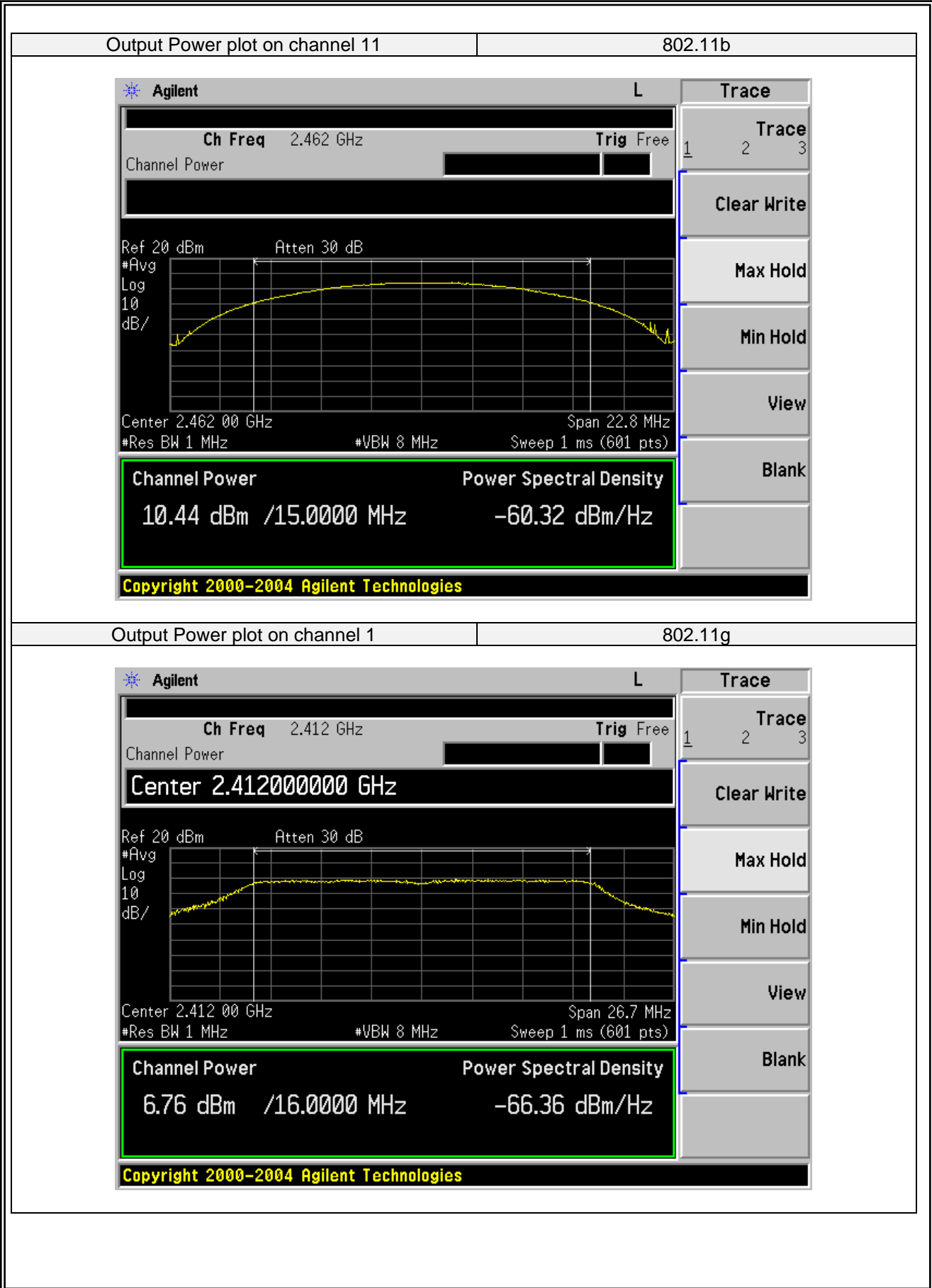

Output Power plot on channel 6

802.11g

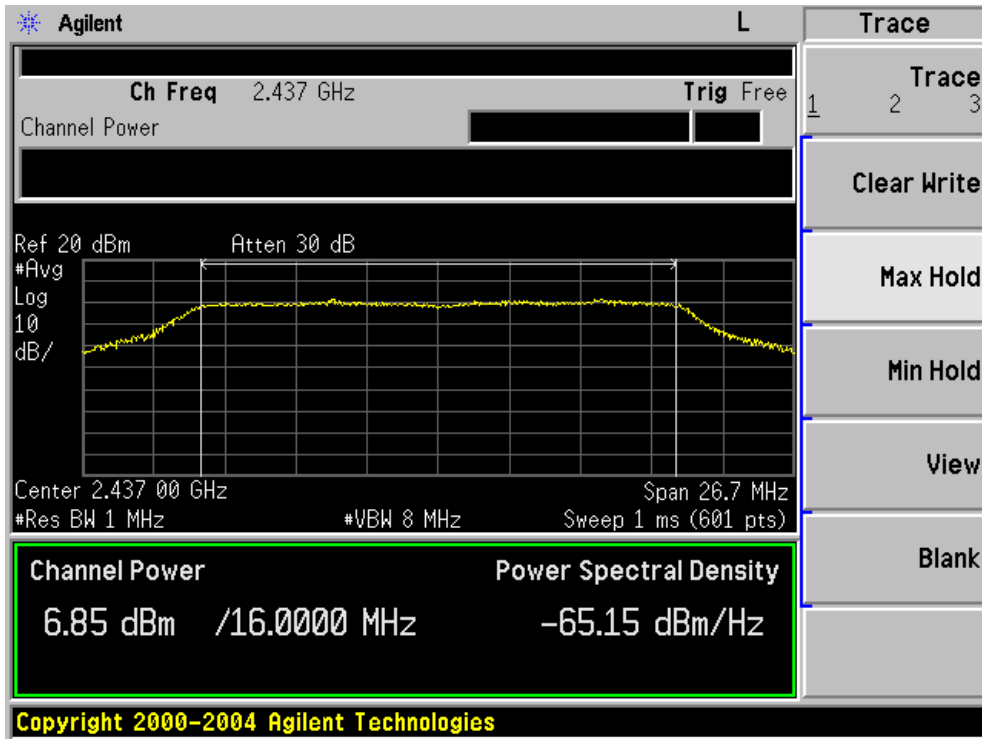

Output Power plot on channel 11

802.11g

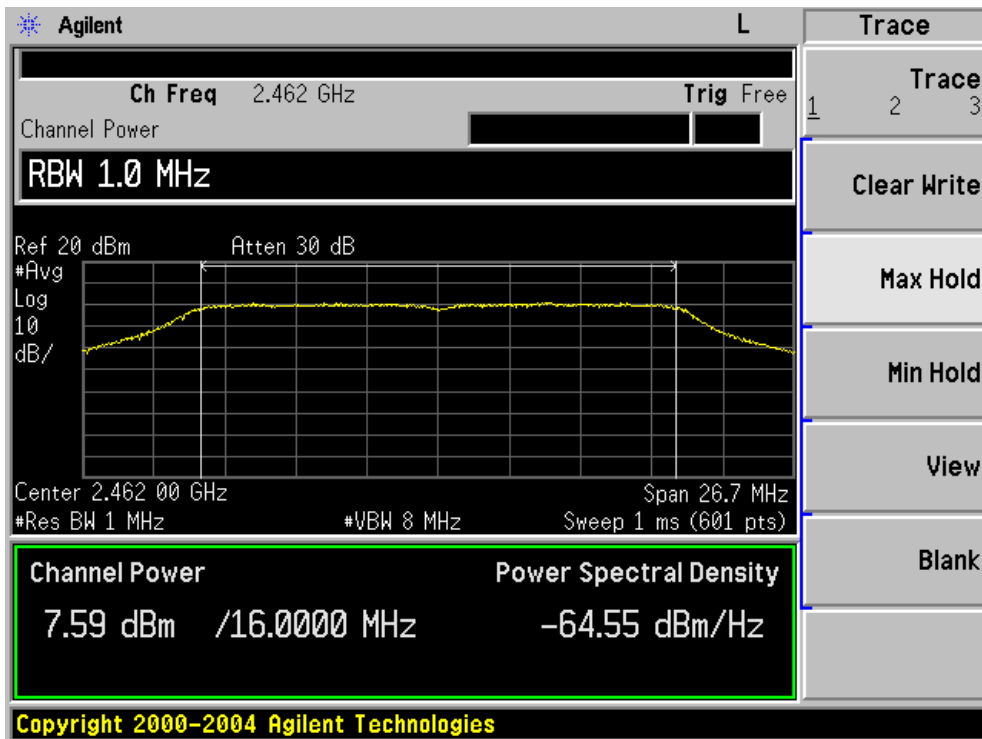

Output Power plot on channel 1

802.11n HT20

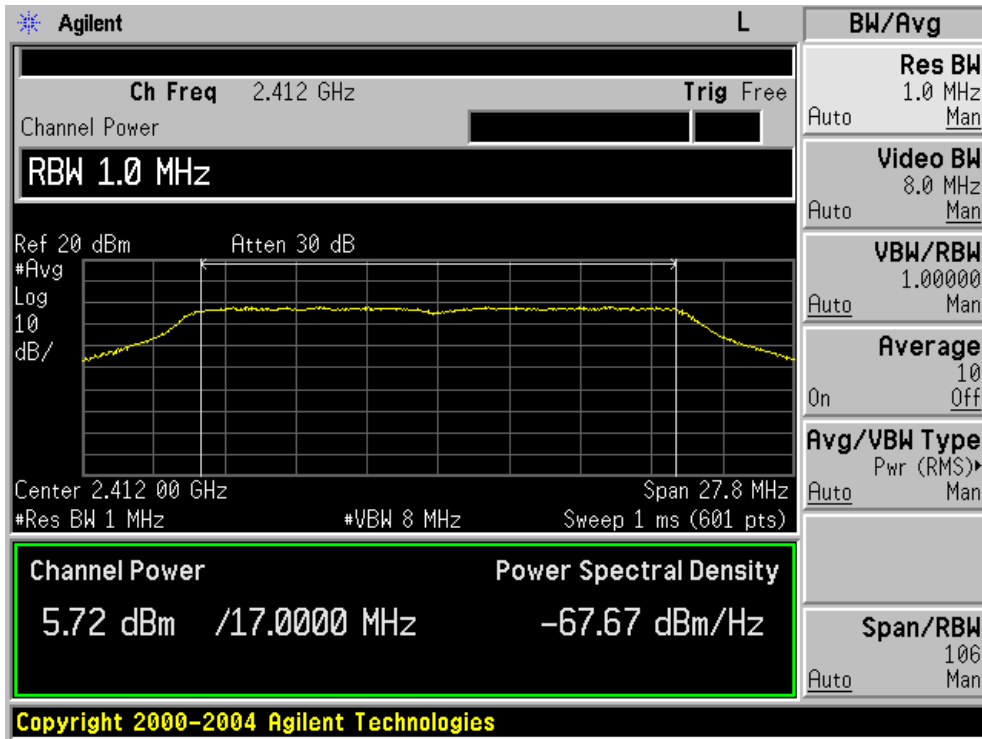

Output Power plot on channel 6

802.11n HT20

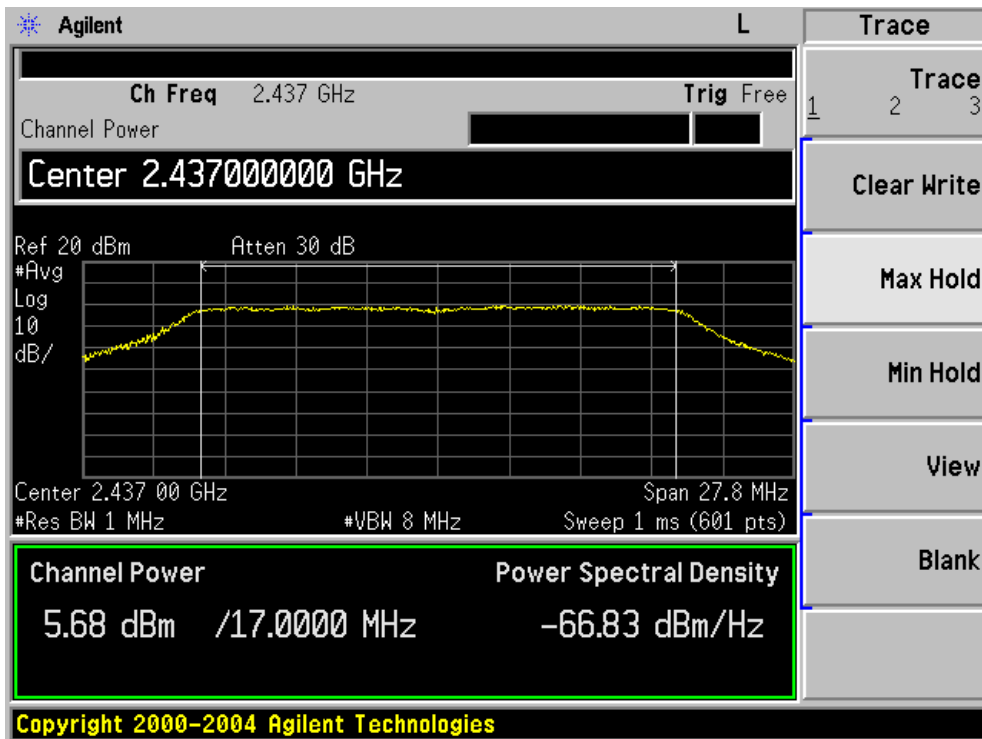

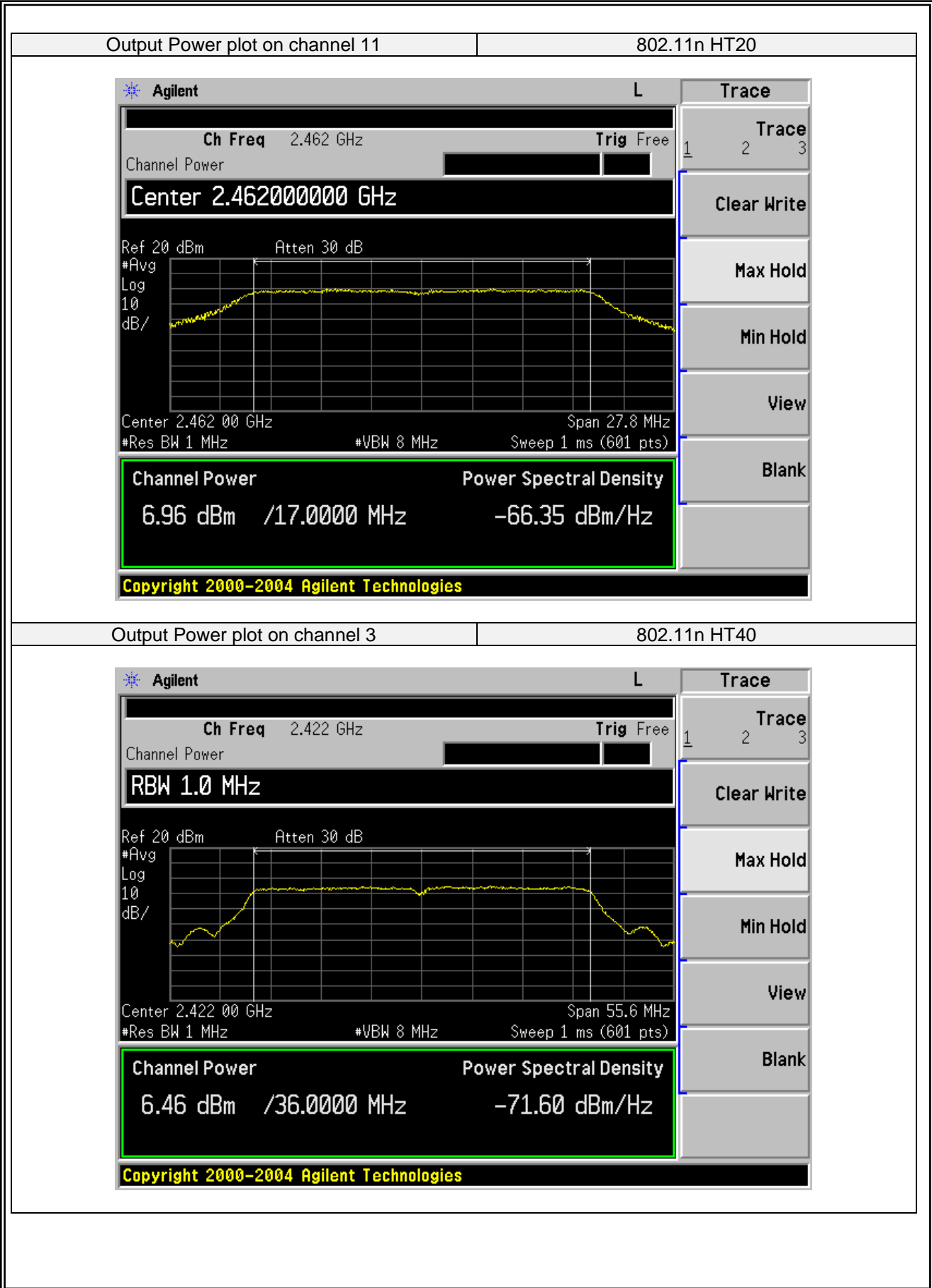



Output Power plot on channel 6

802.11n HT40

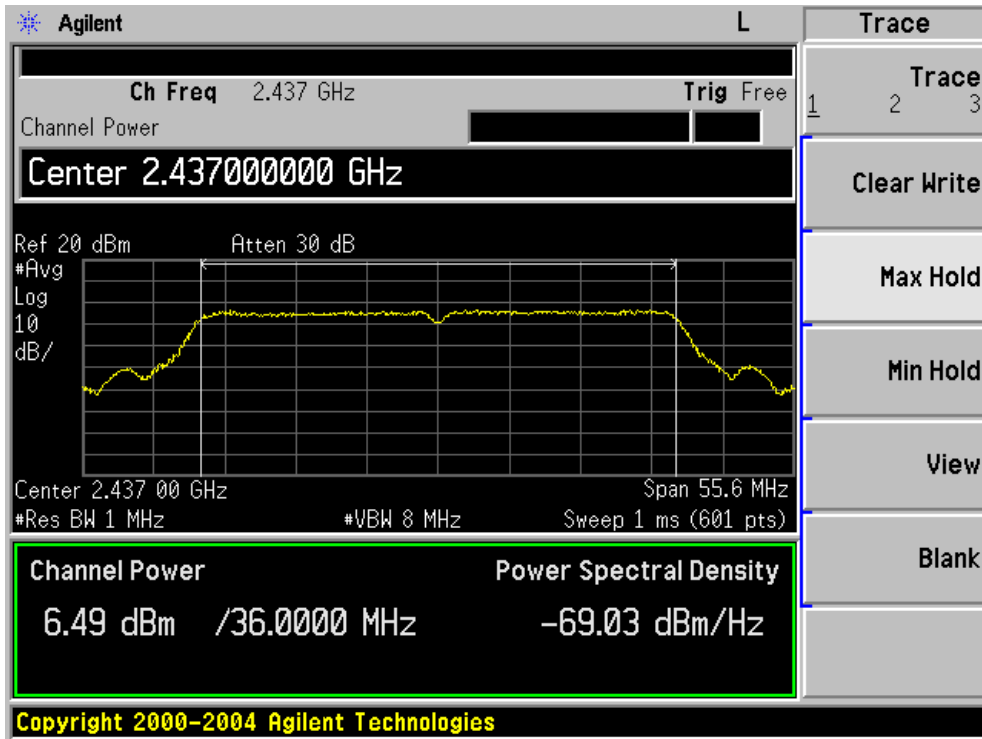

Output Power plot on channel 9

802.11n HT40

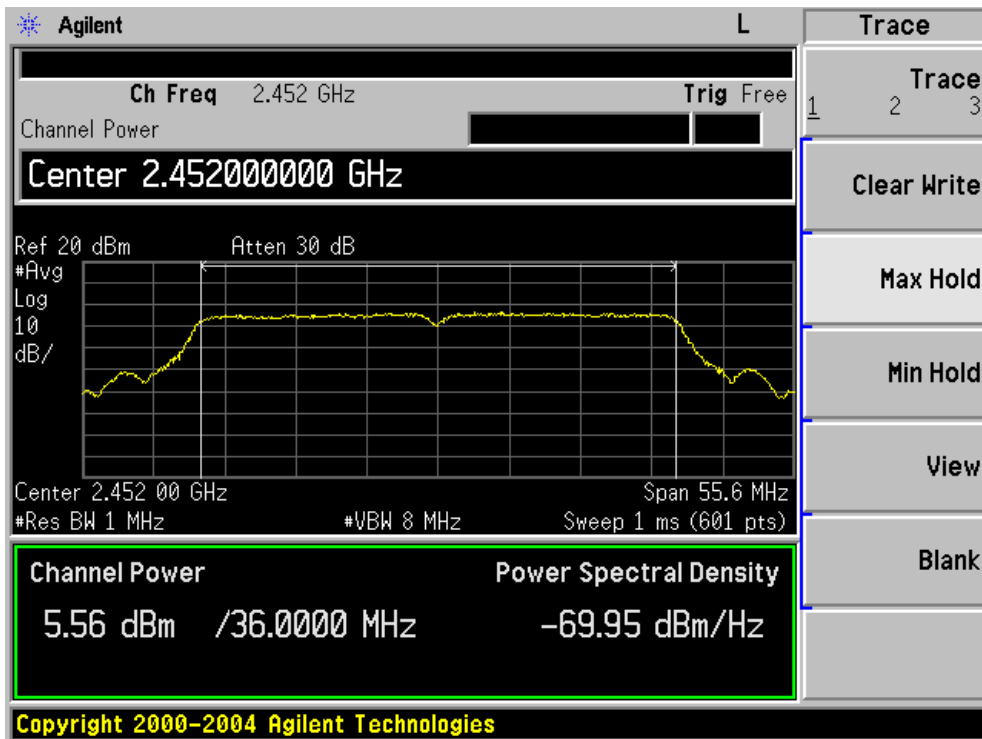

## 7.7 POWER SPECTRAL DENSITY

### 7.7.1 Applicable Standard

According to FCC Part 15.247(e) and KDB 558074 DTS 01 Meas. Guidance v03r04

### 7.7.2 Conformance Limit

The transmitter power spectral density conducted from the transmitter to the antenna shall not be greater than 8 dBm in any 3 kHz band during any time interval of continuous transmission.

### 7.7.3 Measuring Instruments

The Measuring equipment is listed in the section 6.3 of this test report.

### 7.7.4 Test Setup

Please refer to Section 6.1 of this test report.

### 7.7.5 Test Procedure

The testing follows Measurement Procedure 10.3 Method AVGPSD of FCC KDB Publication No. 558074 D01 DTS Meas. Guidance v03r04

This procedure may be used when the maximum (average) conducted output power was used to demonstrate compliance to the output power limit. This is the baseline method for determining the maximum (average) conducted PSD level. If the instrument has an RMS power averaging detector, it must be used; otherwise, use the sample detector. The EUT must be configured to transmit continuously (duty cycle  $\geq 98\%$ ); otherwise sweep triggering/signal gating must be implemented to ensure that measurements are made only when the EUT is transmitting at its maximum power control level (no transmitter off time is to be considered).

The RF output of EUT was connected to the spectrum analyzer by RF cable and attenuator.

The path loss was compensated to the results for each measurement.

Set to the maximum power setting and enable the EUT transmit continuously.

The EUT was operating in controlled its channel.

- a) Set instrument center frequency to DTS channel center frequency.
- b) Set span to at least 1.5 times the OBW.
- c) Set RBW to:  $3 \text{ kHz} \leq \text{RBW} \leq 100 \text{ kHz}$ .
- d) Set VBW  $\geq 3 \times \text{RBW}$ .
- e) Detector = power averaging (RMS) or sample detector (when RMS not available).
- f) Ensure that the number of measurement points in the sweep  $\geq 2 \times \text{span}/\text{RBW}$ .
- g) Sweep time = auto couple.
- h) Employ trace averaging (RMS) mode over a minimum of 100 traces.
- i) Use the peak marker function to determine the maximum amplitude level.
- j) If measured value exceeds limit, reduce RBW (no less than 3 kHz) and repeat (note that this may require zooming in on the emission of interest and reducin

**7.7.6 Test Results**

EUT:	Embedded Touch PC	Model No.:	FT15A20M
Temperature:	20 °C	Relative Humidity:	48%
Test Mode:	Mode1/Mode2/Mode3/Mode4	Test By:	Allen Liu

Test Channel	Frequency (MHz)	Power Density (dBm/3KHz)	Limit (dBm/3KHz)	Verdict
<b>802.11b</b>				
1	2412	-11.46	8	PASS
6	2437	-11.51	8	PASS
11	2462	-10.70	8	PASS
<b>802.11g</b>				
1	2412	-16.36	8	PASS
6	2437	-13.81	8	PASS
11	2462	-16.56	8	PASS
<b>802.11n HT20</b>				
1	2412	-15.93	8	PASS
6	2437	-14.86	8	PASS
11	2462	-15.68	8	PASS
<b>802.11n HT40</b>				
3	2422	-22.39	8	PASS
6	2437	-17.82	8	PASS
9	2452	-21.47	8	PASS

Power spectral density plot on channel 1

802.11b

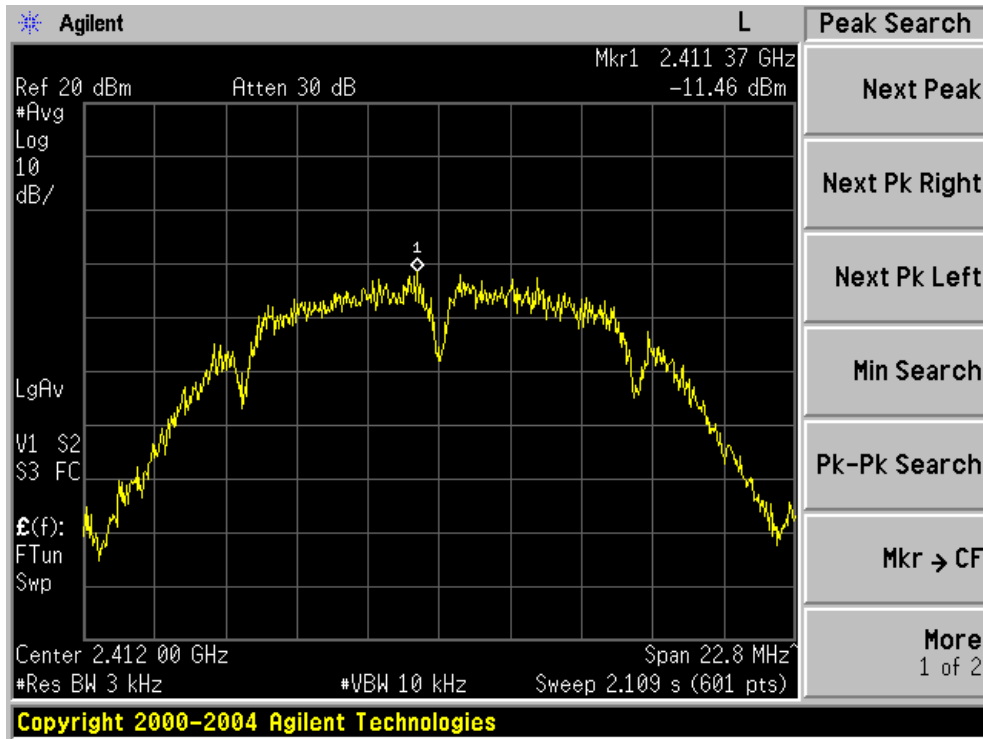

Power spectral density plot on channel 6

802.11b

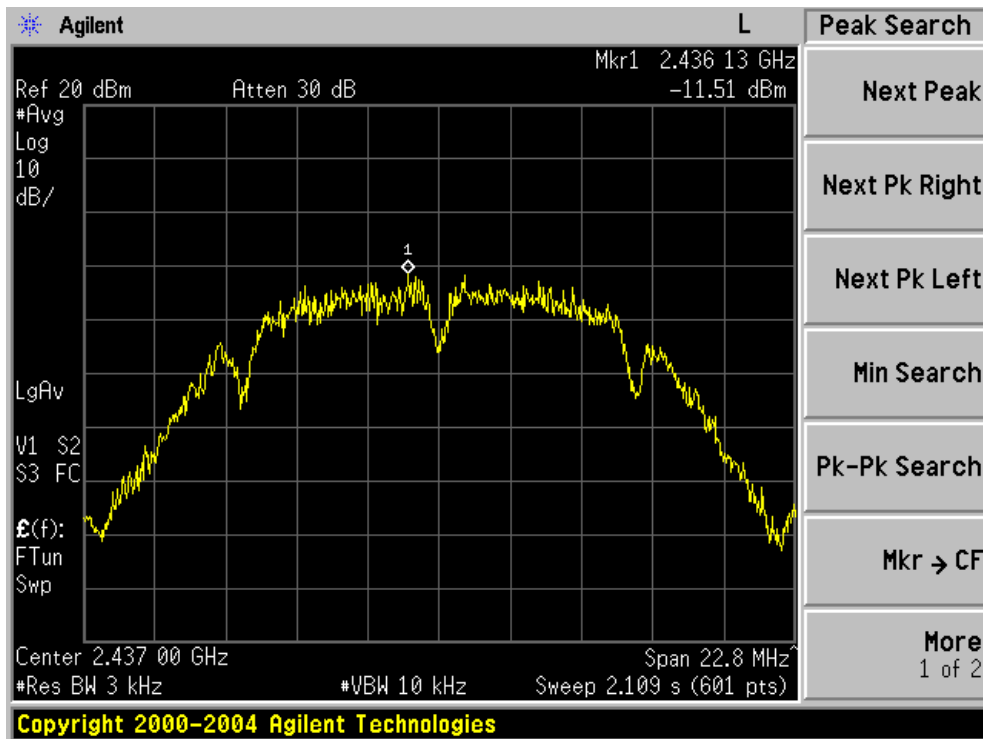

Power spectral density plot on channel 11 802.11b

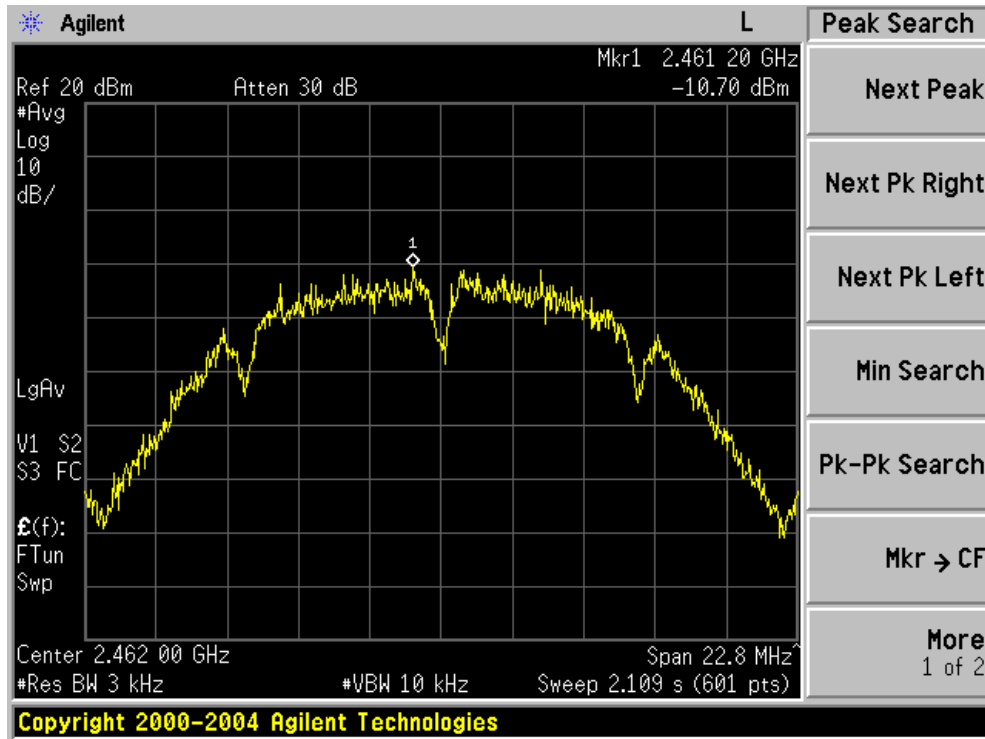

Power spectral density plot on channel 1 802.11g

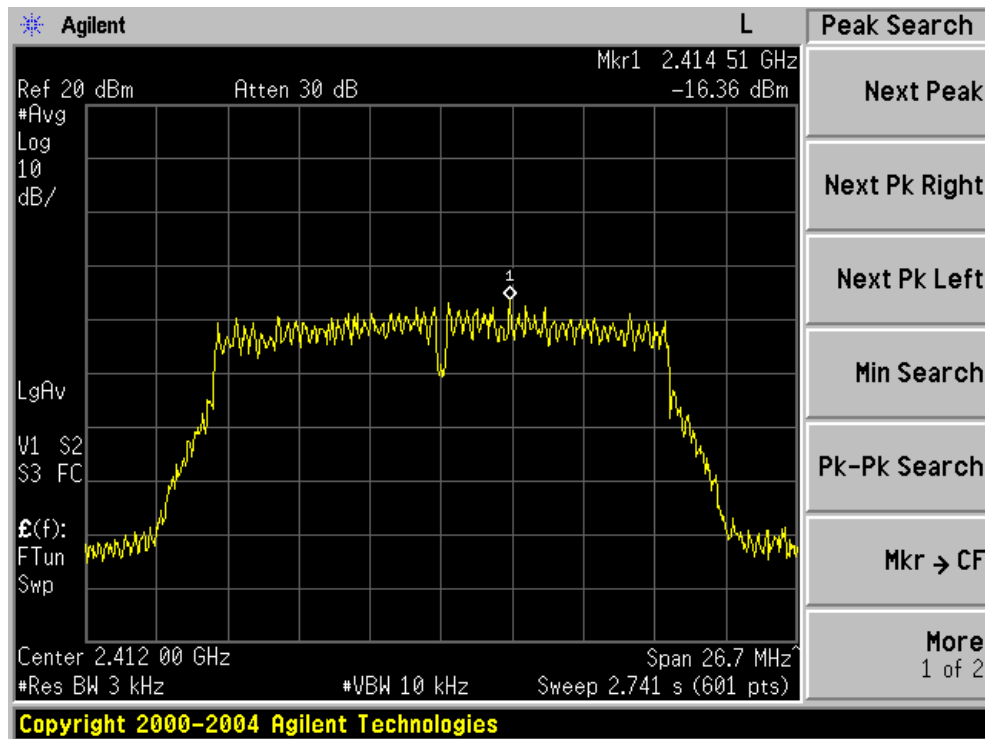

Power spectral density plot on channel 6 802.11g

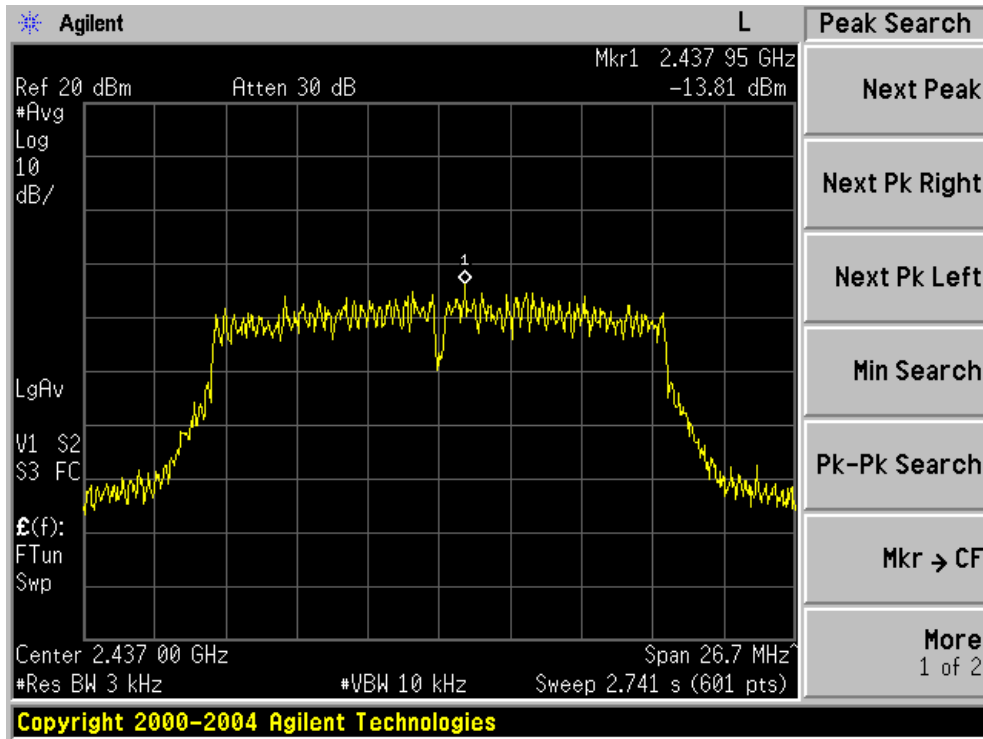

Power spectral density plot on channel 11 802.11g

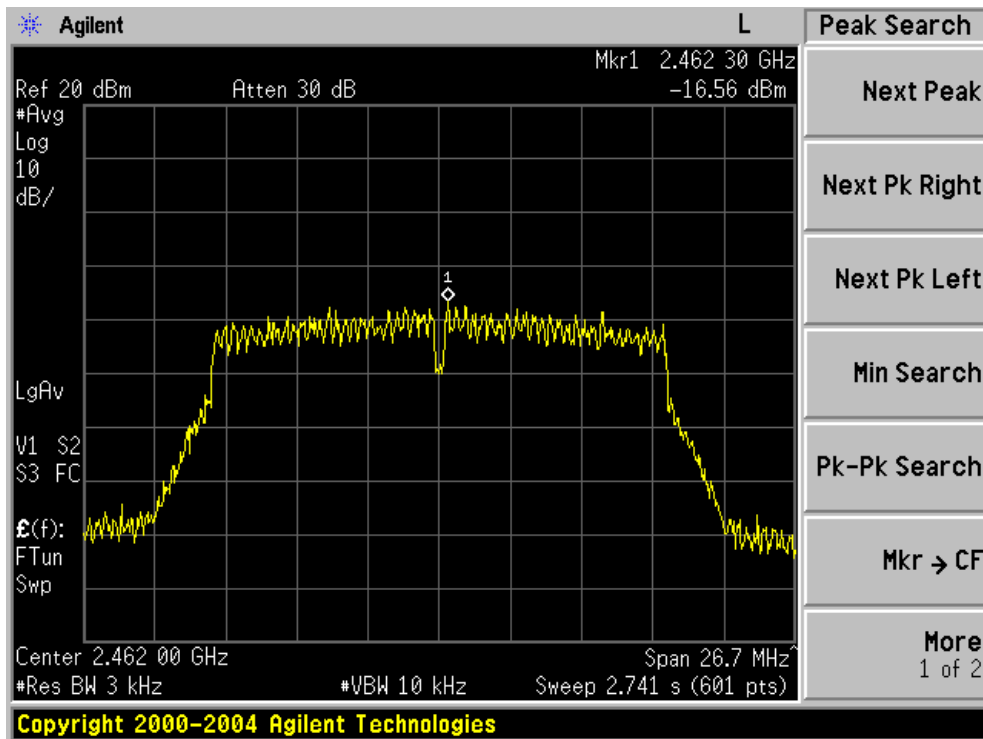

Power spectral density plot on channel 1

802.11n HT20

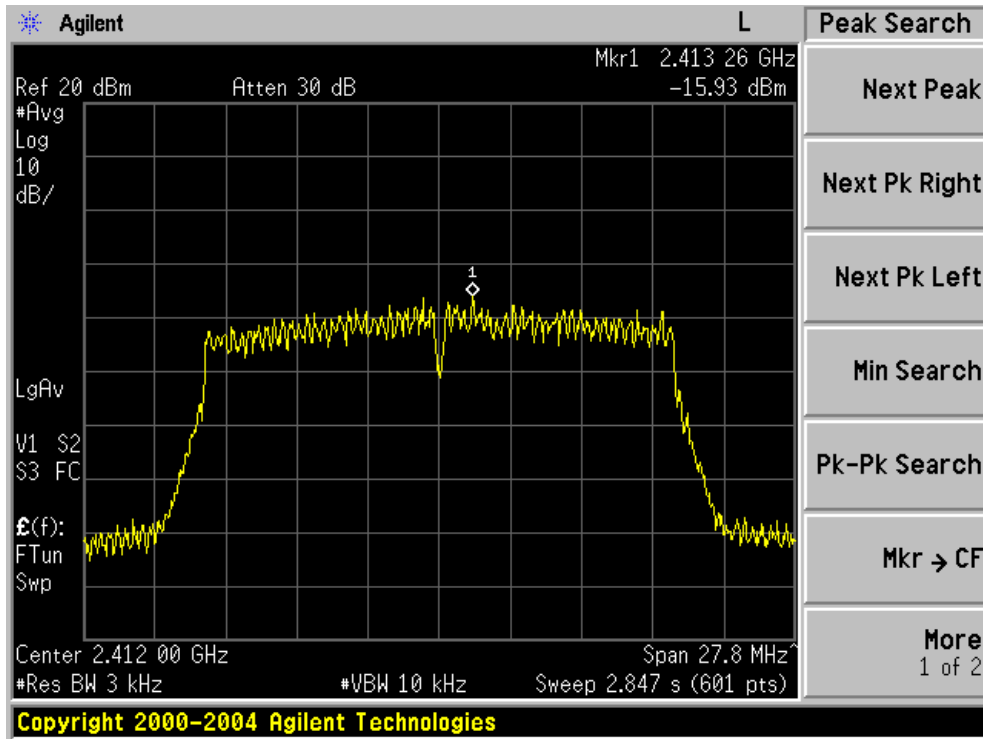

Power spectral density plot on channel 6

802.11n HT20

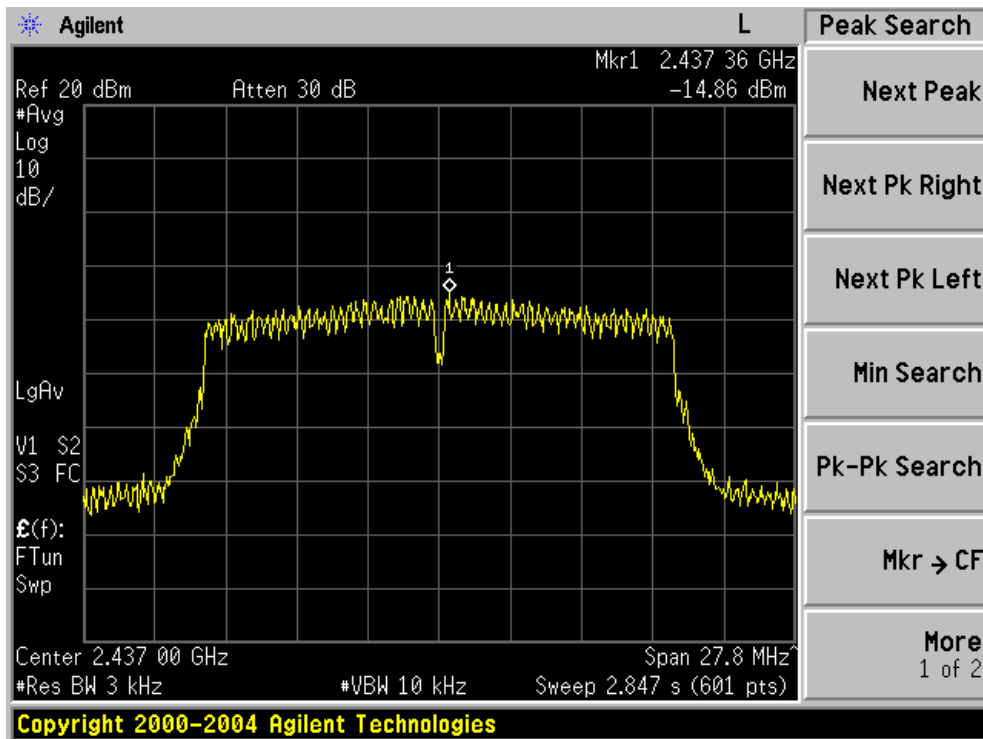

Power spectral density plot on channel 11	802.11n HT20
---	--------------

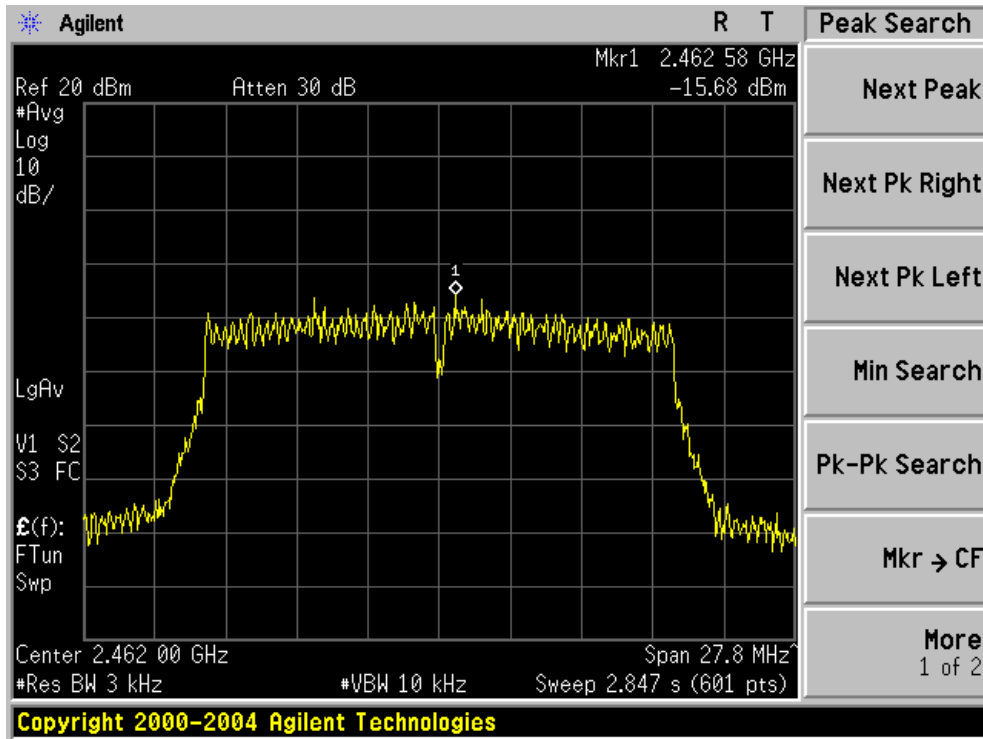

Power spectral density plot on channel 3	802.11n HT40
--	--------------

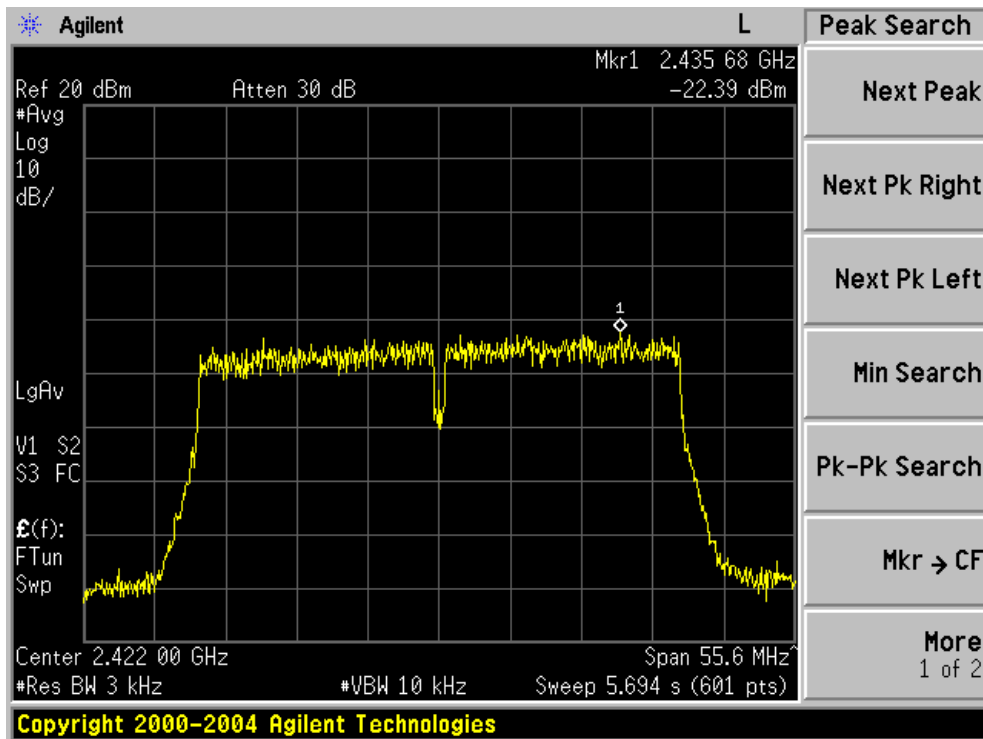



Power spectral density plot on channel 6

802.11n HT40

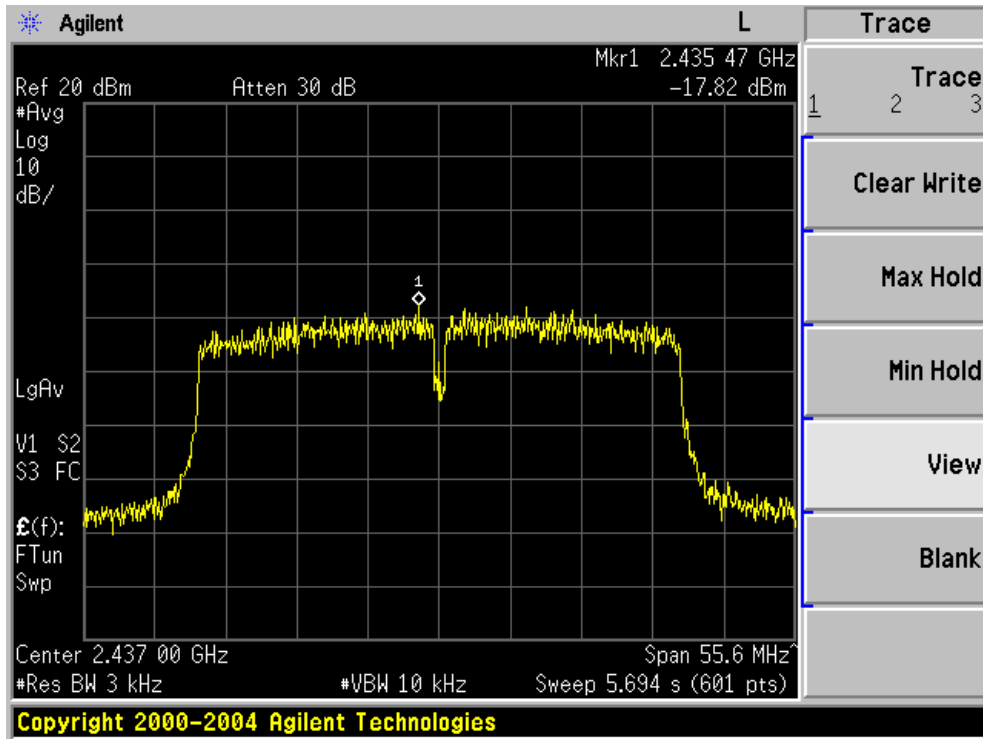

Power spectral density plot on channel 9

802.11n HT40

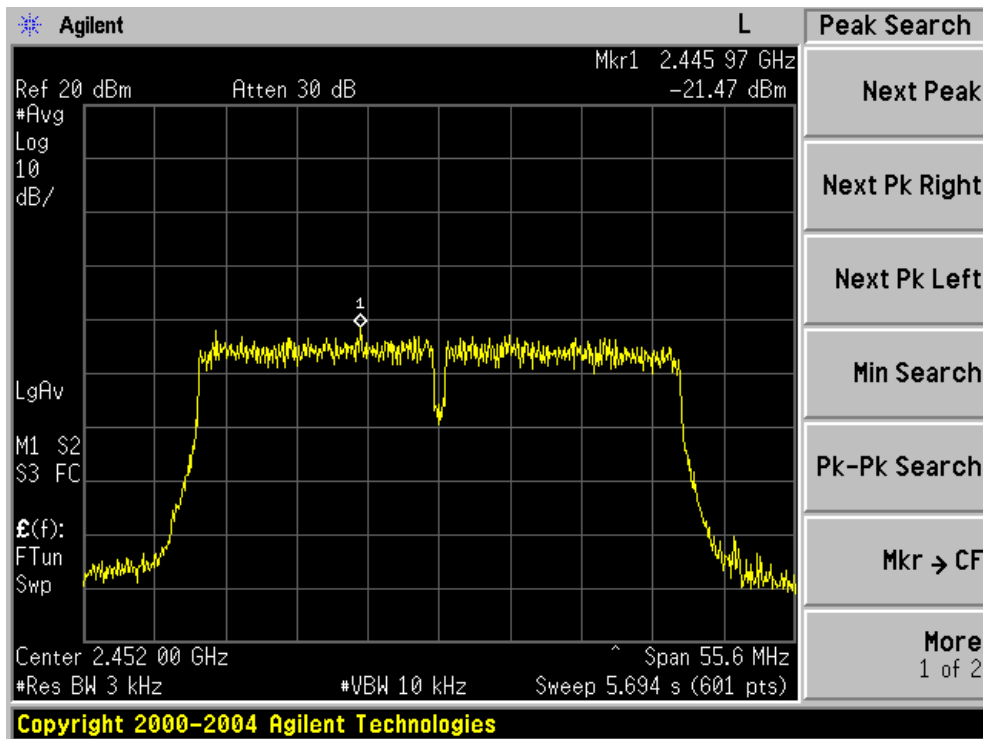

## **7.8 CONDUCTED BAND EDGE MEASUREMENT**

### **7.8.1 Applicable Standard**

According to FCC Part 15.247(d) and KDB 558074 DTS 01 Meas. Guidance v03r04

### **7.8.2 Conformance Limit**

In any 100 kHz bandwidth outside the frequency band in which the spread spectrum or digitally modulated intentional radiator is operating, the radio frequency power that is produced by the intentional radiator shall be at least 20 dB below that in the 100 kHz bandwidth within the band that contains the highest level of the desired power, based on either an RF conducted or a radiated measurement, provided the transmitter demonstrates compliance with the peak conducted power limits. If the transmitter complies with the conducted power limits based on the use of RMS averaging over a time interval, as permitted under paragraph (b)(3) of this section, the attenuation required under this paragraph shall be 30 dB instead of 20 dB.

### **7.8.3 Measuring Instruments**

The Measuring equipment is listed in the section 6.3 of this test report.

### **7.8.4 Test Setup**

Please refer to Section 6.1 of this test report.

### **7.8.5 Test Procedure**

The testing follows FCC KDB Publication No. 558074 D01 DTS Meas. Guidance v03r04.

The RF output of EUT was connected to the spectrum analyzer by RF cable and attenuator.

The path loss was compensated to the results for each measurement.

Set to the maximum power setting and enable the EUT transmit continuously.

The EUT was operating in controlled its channel.

Set RBW to 100 kHz and VBW of spectrum analyzer to 300 kHz with a convenient frequency span including 100 kHz bandwidth from band edge.

Measure the highest amplitude appearing on spectral display and set it as a reference level. Plot the graph with marking the highest point and edge frequency.

Repeat above procedures until all measured frequencies were complete.

**7.8.6 Test Results**

EUT:	Embedded Touch PC	Model No.:	FT15A20M
Temperature:	20 °C	Relative Humidity:	48%
Test Mode:	Mode1/Mode2/Mode3/Mode4	Test By:	Allen Liu

Frequency Band	Delta Peak to band emission(dBc)	>Limit(dBc)	Verdict
802.11b			
2400	53.51	20	Pass
2483.5	52.51	20	Pass
802.11g			
2400	39.02	20	Pass
2483.5	52.09	20	Pass
802.11n HT20			
2400	40.09	20	Pass
2483.5	50.38	20	Pass
802.11n HT40			
2400	39.92	20	Pass
2483.5	42.82	20	Pass

802.11b: Band Edge-Low Channel

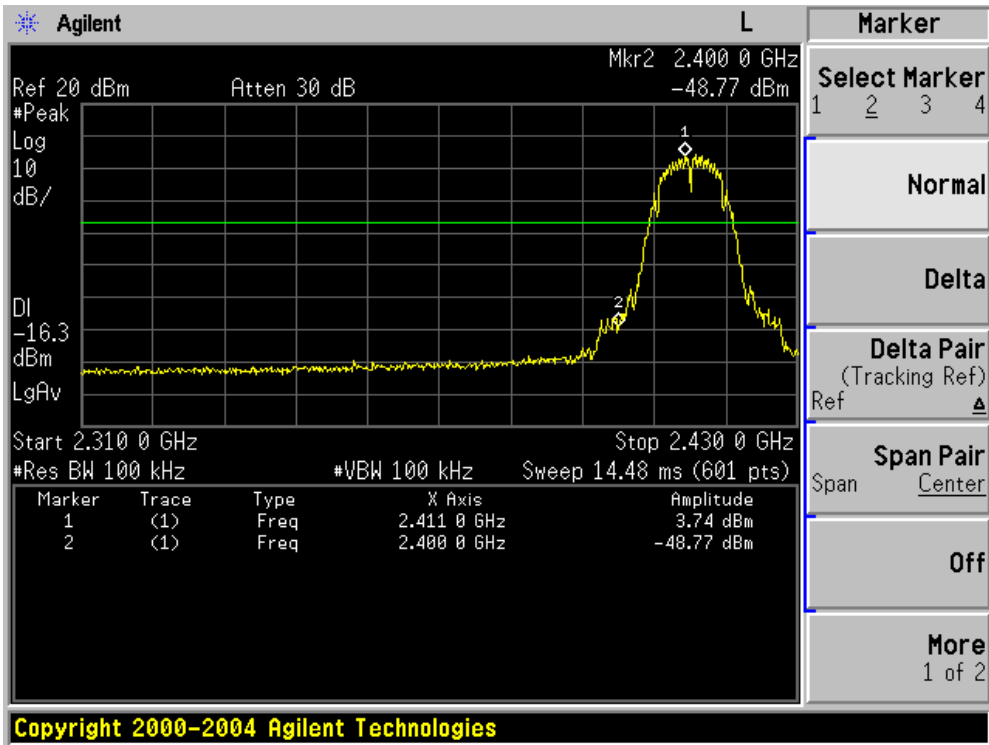

802.11b: Band Edge-High Channel

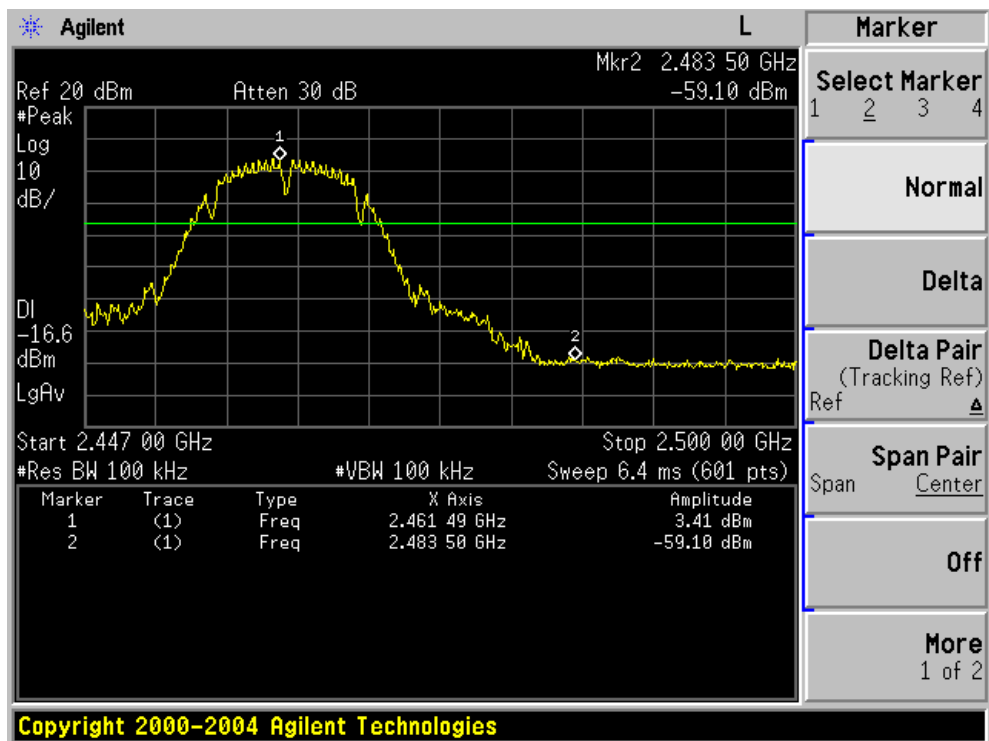

802.11g: Band Edge-Low Channel

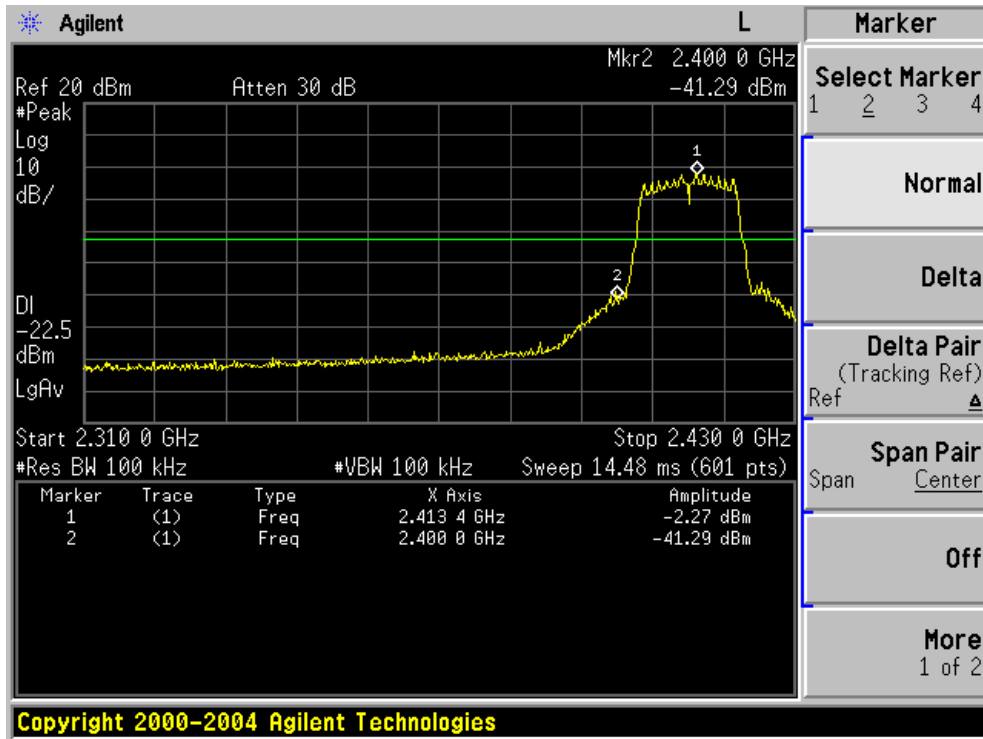

802.11g: Band Edge-High Channel

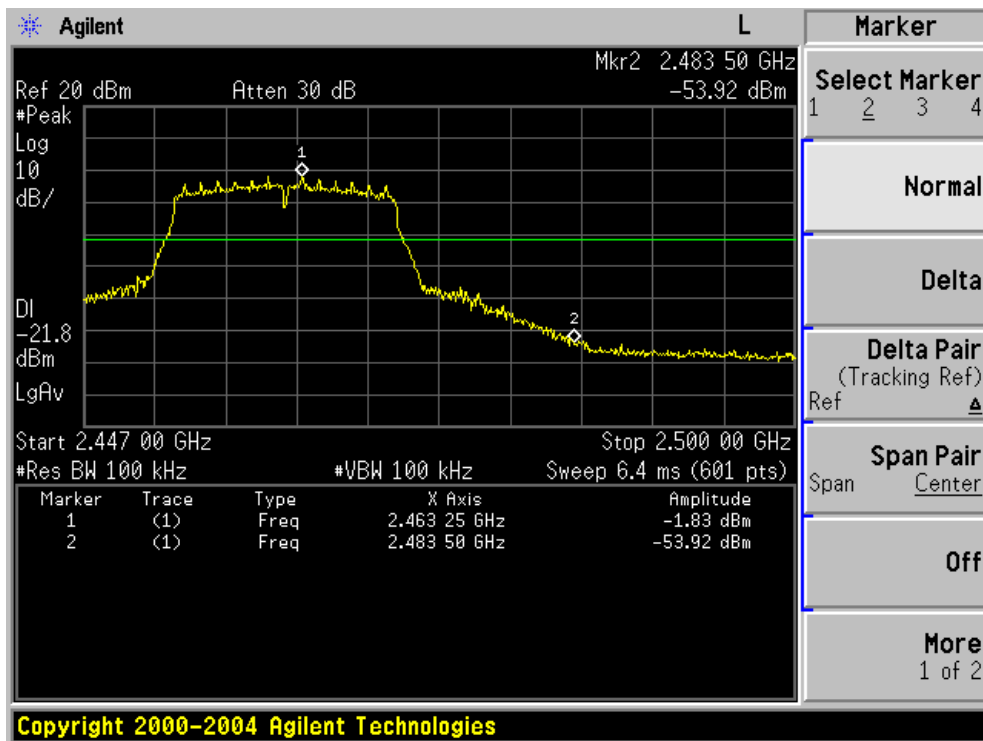

802.11n HT20: Band Edge-Low Channel

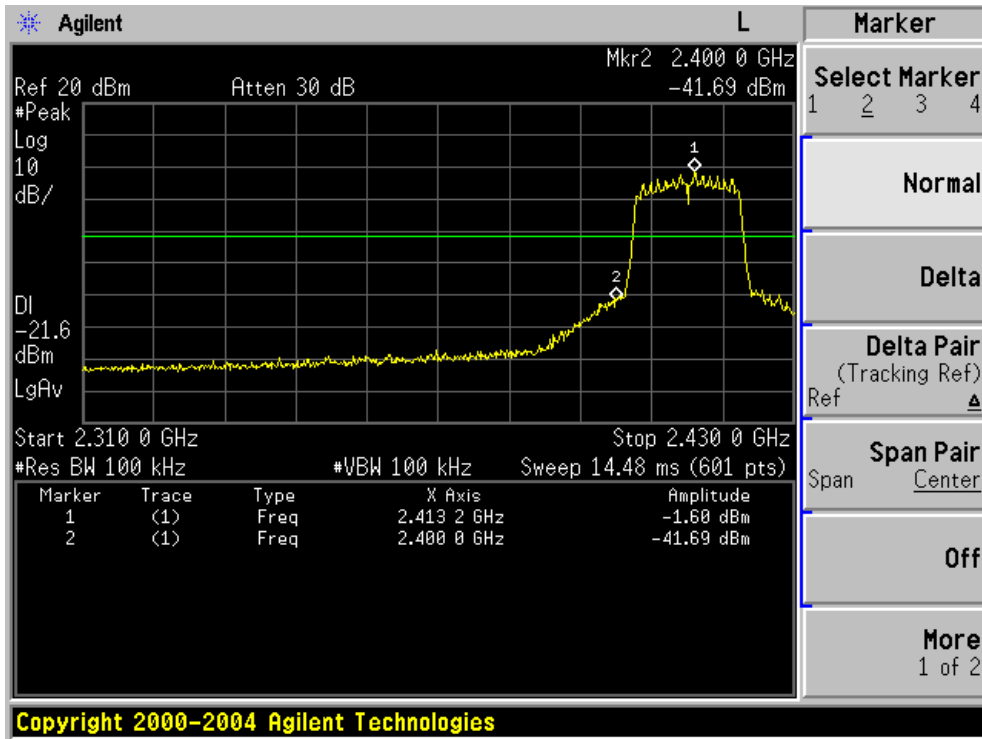

802.11n HT20: Band Edge-High Channel

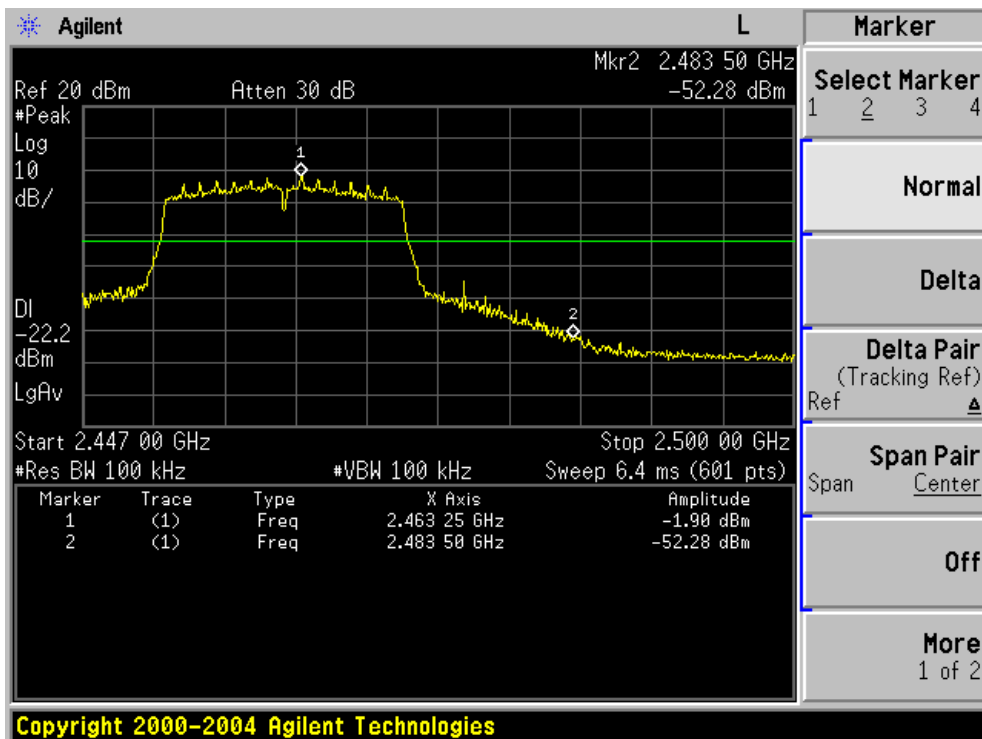

802.11n HT40: Band Edge-Low Channel

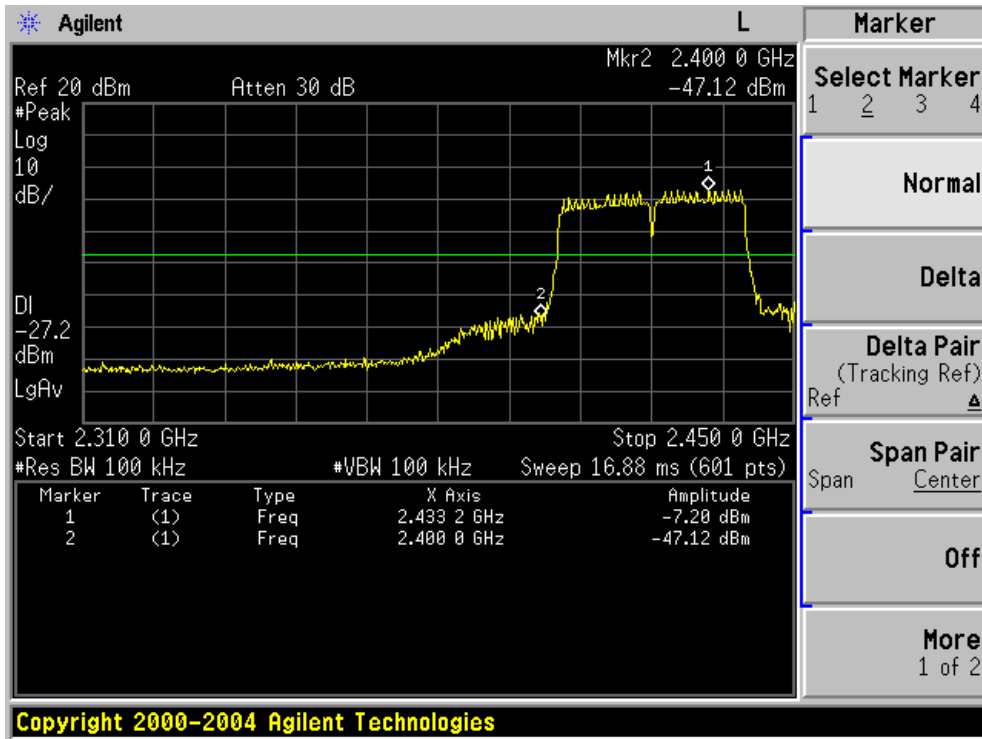

802.11n HT40: Band Edge-High Channel

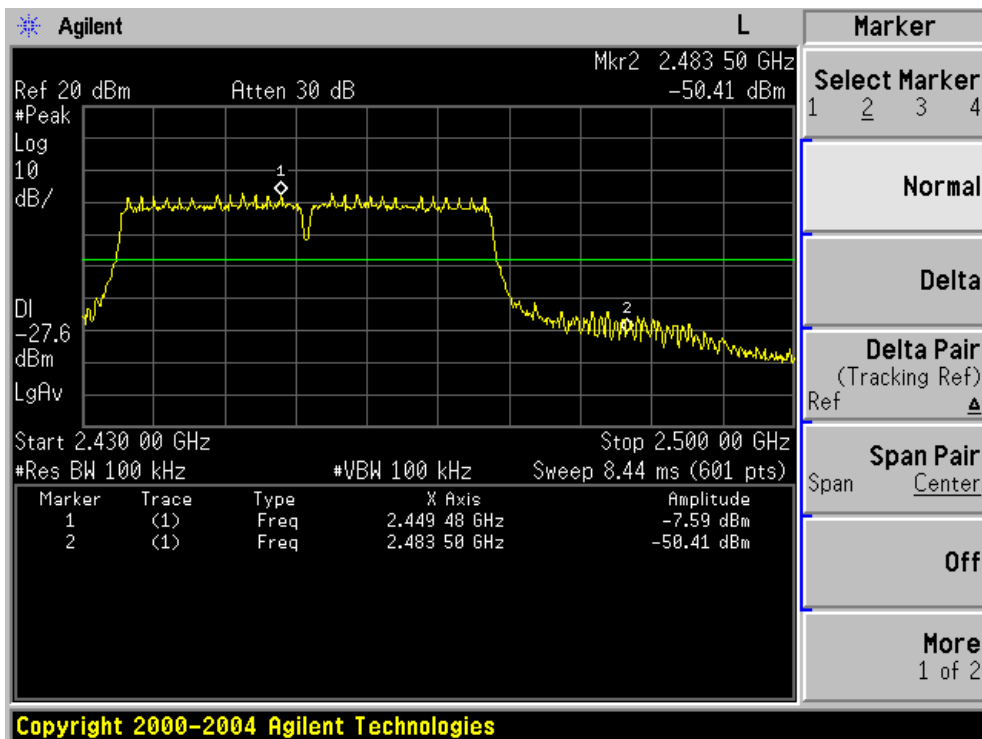

## **7.9 ANTENNA APPLICATION**

### **7.9.1 Antenna Requirement**

15.203 requirement: For intentional device, according to 15.203: an intentional radiator shall be designed to ensure that no antenna other than that furnished by the responsible party shall be used with the device.

### **7.9.2 Result**

The EUT antenna is external antenna. The manufacturer may design the unit so that a broken antenna can be replaced by the user, but the use of a standard antenna jack or electrical connector is prohibited. This antenna is a special type, belonging to the opposite polarity SMA antenna connector male, the "outer spiral hole +", "+ pin spiral" design mode the user can not be replaced, and then free to buy on the market, It comply with the standard requirement



END OF REPORT