



CTC Laboratories, Inc.

1-2/F., Building 2, Jiaquan Building, Guanlan High-Tech Park, Shenzhen, Guangdong, China
Tel: +86-755- 27521059 Fax: +86-755- 27521011 Http://www.sz-ctc.org.cn

TEST REPORT

Report No.: **CTC20211136E15**

FCC ID.....: **2AC88-GLMR21A02**

Applicant.....: **HONGKONG UCLOUDLINK NETWORK TECHNOLOGY LIMITED**

Address.....: Suite 603, 6/F, Laws Commercial Plaza, 788 Cheung Sha Wan Road, Kowloon, Hong Kong

Manufacturer.....: HONGKONG UCLOUDLINK NETWORK TECHNOLOGY LIMITED

Address.....: Suite 603, 6/F, Laws Commercial Plaza, 788 Cheung Sha Wan Road, Kowloon, Hong Kong

Product Name.....: **4G LTE Wireless Router**

Trade Mark.....: GlocalMe

Model/Type reference.....: GLMR21A02

Listed Model(s): N/A

Standard.....: **FCC CFR Title 47 Part 2**
FCC CFR Title 47 Part 22H
FCC Part 90S

Date of receipt of test sample: Jul. 01, 2021

Date of testing.....: Jul. 02, 2021 ~ Jul. 29, 2021

Date of issue.....: Jul. 30, 2021

Result.....: **PASS**

Compiled by:		
(Printed name+signature)	Terry Su	
Supervised by:		
(Printed name+signature)	Miller Ma	
Approved by:		
(Printed name+signature)	Walter Chen	

Testing Laboratory Name.....: **CTC Laboratories, Inc.**

Address.....: 1-2/F., Building 2, Jiaquan Building, Guanlan High-Tech Park, Shenzhen, Guangdong, China

This test report may be duplicated completely for legal use with the approval of the applicant. It should not be reproduced except in full, without the written approval of our laboratory. The client should not use it to claim product endorsement by CTC. The test results in the report only apply to the tested sample. The test report shall be invalid without all the signatures of testing engineers, reviewer and approver. Any objections must be raised to CTC within 15 days since the date when the report is received. It will not be taken into consideration beyond this limit. The test report merely correspond to the test sample.



Table of Contents

Page

1. SUMMARY..... 3

1.1. TEST STANDARDS.....3

1.2. REPORT VERSION.....3

1.3. TEST DESCRIPTION.....4

1.4. TEST FACILITY5

1.5. MEASUREMENT UNCERTAINTY5

1.6. ENVIRONMENTAL CONDITIONS6

2. GENERAL INFORMATION..... 7

2.1. CLIENT INFORMATION7

2.2. GENERAL DESCRIPTION OF EUT7

2.3. DESCRIPTION OF TEST MODES AND TEST FREQUENCY.....8

2.4. MEASUREMENT INSTRUMENTS LIST9

3. TEST ITEM AND RESULTS..... 10

3.1. CONDUCTED OUTPUT POWER10

3.2. PEAK-TO-AVERAGE RATIO11

3.3. OCCUPY BANDWIDTH.....12

3.4. OUT OF BAND EMISSION AT ANTENNA TERMINALS.....13

3.5. RECEIVER SPURIOUS EMISSIONS AT ANTENNA TERMINAL14

3.6. BAND EDGE COMPLIANCE15

3.7. RADIATED POWER MEASUREMENT16

3.8. RADIATED SPURIOUS EMISSION.....20

3.9. FREQUENCY STABILITY23



1. SUMMARY

1.1. Test Standards

[FCC Part 22 Subpart H](#): Cellular Radiotelephone Service.

[FCC Part 90 Subpart S](#): Regulations Governing Licensing and Use of Frequencies in the 806-824, 851-869, 896-901, and 935-940 MHz Bands.

[FCC Part 2](#): FREQUENCY ALLOCATIONS AND RADIO TREATY MATTERS; GENERAL RULES AND REGULATIONS.

[ANSI C63.26: 2015](#): American National Standard for Compliance Testing of Transmitters Used in Licensed Radio Services.

[KDB 971168 D01 Power Meas License Digital Systems v03](#): MEASUREMENT GUIDANCE FOR CERTIFICATION OF LICENSED DIGITAL TRANSMITTERS.

1.2. Report version

Revised No.	Date of issue	Description
01	Jul. 30, 2021	Original



1.3. Test Description

Test Item	Section in CFR 47	RSS Rule	Result	Test Engineer
Conducted Output Power	Part 2.1046 Part 22.913(a)	RSS-119(5.4)	Pass	Alicia Liu
Peak-to-Average Ratio	Part 24.232	/	Pass	Alicia Liu
99% Occupied Bandwidth & 26 dB Bandwidth	Part 2.1049 Part 22.917(b) Part 90.209	RSS-119(5.5)	Pass	Alicia Liu
Band Edge	Part 2.1051 Part 22.917 Part 90.691	RSS-119(5.8)	Pass	Alicia Liu
Conducted Spurious Emissions	Part 2.1051 Part 22.917 Part 90.691	RSS-119(5.3)	Pass	Alicia Liu
Frequency stability vs temperature	Part 2.1055(a)(1)(b) Part 22.355 Part 90.213	RSS-GEN(6.11) RSS-119(5.3)	Pass	Alicia Liu
Frequency stability vs voltage	Part 2.1055(d)(1)(2) Part 22.355 Part 90.213	RSS-GEN(6.11) RSS-119(5.3)	Pass	Alicia Liu
ERP and EIRP	Part 22.913(a) Part 90.635	RSS-119(5.8)	Pass	Alicia Liu
Radiated Spurious Emissions	Part 2.1053 Part 22.917 Part 90.691	RSS-119(5.8)	Pass	Alicia Liu
Receiver Spurious Emissions	/	RSS-GEN(7.1.3)	N/A	N/A

Note: The measurement uncertainty is not included in the test result.



1.4. Test Facility

Address of the report laboratory

CTC Laboratories, Inc.

Add: 1-2/F., Building 2, Jiaquan Building, Guanlan High-Tech Park, Shenzhen, Guangdong, China

Laboratory accreditation

The test facility is recognized, certified, or accredited by the following organizations:

CNAS-Lab Code: L5365

CTC Laboratories, Inc. has been assessed and proved to be in compliance with CNAS-CL01 Accreditation. Criteria for Testing and Calibration Laboratories (identical to ISO/IEC17025:2017 General Requirements) the Competence of Testing and Calibration Laboratories.

A2LA-Lab Cert. No.: 4340.01

CTC Laboratories, Inc. EMC Laboratory has been accredited by A2LA for technical competence in the field of electrical testing, and proved to be in compliance with ISO/IEC 17025:2017 General Requirements for the Competence of Testing and Calibration Laboratories and any additional program requirements in the identified field of testing.

Industry Canada (Registration No.: 9783A, CAB Identifier: CN0029)

CTC Laboratories, Inc. EMC Laboratory has been registered by Certification and Engineer Bureau of Industry Canada for the performance of with Registration NO.: 9783A on Jan, 2016.

FCC (Registration No.: 951311, Designation Number CN1208)

CTC Laboratories, Inc. EMC Laboratory has been registered and fully described in a report filed with the (FCC)Federal Communications Commission. The acceptance letter from the FCC is maintained in our files. Registration 951311, Aug 26, 2017.

1.5. Measurement Uncertainty

The data and results referenced in this document are true and accurate. The reader is cautioned that there may be errors within the calibration limits of the equipment and facilities. The measurement uncertainty was calculated for all measurements listed in this test report acc. To CISPR 16 – 4 Specification for radio disturbance and immunity measuring apparatus and methods – Part 4: Uncertainty in EMC Measurements and is documented in the CTC Laboratories, Inc. quality system acc. To DIN EN ISO/IEC 17025. Furthermore, component and process variability of devices similar to that tested may result in additional deviation. The manufacturer has the sole responsibility of continued compliance of the device.

Hereafter the best measurement capability for CTC Laboratories, Inc. is reported:

Test Items	Measurement Uncertainty	Notes
Frequency stability	25 Hz	(1)
Transmitter power conducted	0.57 dB	(1)
Transmitter power Radiated	2.20 dB	(1)
Conducted spurious emission 9KHz-12.75 GHz	1.60 dB	(1)
Conducted Emission 9KHz-30MHz	3.39 dB	(1)
Radiated Emission 30~1000MHz	4.24 dB	(1)
Radiated Emission 1~18GHz	5.16 dB	(1)

CTC Laboratories, Inc.

1-2/F., Building 2, Jiaquan Building, Guanlan High-Tech Park, Shenzhen, Guangdong, China

Tel.: (86)755-27521059

Fax: (86)755-27521011

Http://www.sz-ctc.org.cn



For anti-fake verification, please visit the official website of Certification and Accreditation Administration of the People's Republic of China : <http://yz.cnca.cn>



Radiated Emission 18-40GHz	5.54 dB	(1)
Occupied Bandwidth	-----	(1)
Emission Mask	-----	(1)
Modulation Characteristic	-----	(1)
Transmitter Frequency Behavior	-----	(1)

Note: This uncertainty represents an expanded uncertainty expressed at approximately the 95% confidence level using a coverage factor of $k=1.96$.

1.6. Environmental conditions

During the measurement the environmental conditions were within the listed ranges:

Normal Temperature:	25°C
Relative Humidity:	55 %
Air Pressure:	101 kPa



2. GENERAL INFORMATION

2.1. Client Information

Applicant:	HONGKONG UCLOUDLINK NETWORK TECHNOLOGY LIMITED
Address:	Suite 603, 6/F, Laws Commercial Plaza, 788 Cheung Sha Wan Road, Kowloon, Hong Kong
Manufacturer:	HONGKONG UCLOUDLINK NETWORK TECHNOLOGY LIMITED
Address:	Suite 603, 6/F, Laws Commercial Plaza, 788 Cheung Sha Wan Road, Kowloon, Hong Kong
Factory:	Shenzhen uCloudlink Network Technology Co., Ltd.
Address:	3rd Floor, A part of Building 1, Shenzhen Software Industry Base, Nanshan District Xuefu Road, 518057 Shenzhen City, Guangdong, China

2.2. General Description of EUT

Product Name:	4G LTE Wireless Router
Trade Mark:	GlocalMe
Model/Type reference:	GLMR21A02
Listed Model(s):	N/A
Power supply:	12Vdc/2A from AC/DC Adapter
Adapter model:	KA2401A-1202000US Input: 100-240V~ 50/60Hz 0.65A Max Output: 12Vdc/2A
Hardware version:	R4P-MAIN-VA
Software version:	UCLKO_202107261814
LTE	
Operation Band:	FDD Band 18: UL: 817.5MHz, DL: 862.5MHz FDD Band 26 (814~824MHz): UL: 814MHz~824MHz, DL: 859MHz~869MHz
Modulation Type:	QPSK, 16QAM
Antenna type:	FPC Antenna
Antenna Gain:	Main Antenna: FDD Band 18: 1.75dBi FDD Band 26 (814~824MHz): 1.75dBi



2.3. Description of Test Modes and Test Frequency

The EUT has been tested under typical operating condition. The CMW500 used to control the EUT staying in continuous transmitting and receiving mode for testing.

Test Frequency:

FDD Band 18	Test channel	Bandwidth(MHz)	N _{UL}	Frequency of Uplink (MHz)
	Mid Range	5	23875	817.5

FDD Band 26	Test channel	Bandwidth(MHz)	N _{UL}	Frequency of Uplink (MHz)
Low Range		1.4	26697	814.70
		3	26705	815.50
		5	26715	816.50
Mid Range		1.4/3/5/10	26740	819.00
High Range		1.4	26783	823.30
		3	26775	822.50
		5	26765	821.50



2.4. Measurement Instruments List

Output Power (Radiated) & Radiated Spurious Emission					
Item	Test Equipment	Manufacturer	Model No.	Serial No.	Calibrated until
1	EMI Test Receiver	R&S	ESCI	100967	Dec. 27, 2020
2	High pass filter	Compliance Direction systems	BSU-6	34202	Dec. 27, 2020
3	Log-Bicon Antenna	Schwarzbeck	CBL6141A	4180	Dec. 27, 2020
4	Log-Bicon Antenna	Schwarzbeck	CBL6141A	4181	Dec. 27, 2020
5	Spectrum Analyzer	HP	8563E	02052	Dec. 27, 2020
6	Horn Antenna	Schwarzbeck	BBHA 9120D	648	Dec. 27, 2020
7	Horn Antenna	Schwarzbeck	BBHA 9120D	649	Dec. 27, 2020
8	Ultra-Broadband Antenna	Schwarzbeck	BBHA9170	25841	Dec. 27, 2020
9	Ultra-Broadband Antenna	Schwarzbeck	BBHA9170	25842	Dec. 27, 2020
10	Pre-Amplifier	HP	8447D	1937A03050	Dec. 27, 2020
11	Pre-Amplifier	EMCI	EMC051835	980075	Dec. 27, 2020
12	Splitter	Mini-Circuit	ZAPD-4	400059	Dec. 27, 2020
13	Signal Generator	Agilent	N5182A	1019356	Dec. 27, 2020
14	Wideband Radio Communication Tester	Rohde & Schwarz	CMW500	116410	Dec. 27, 2020
15	Antenna Mast	UC	UC3000	N/A	N/A
16	Antenna mast	MATURO	TAM-4.0-P	N/A	N/A
17	Turn Table	UC	UC3000	N/A	N/A
18	Cable Below 1GHz	Schwarzbeck	AK9515E	33155	Dec. 27, 2020
19	Cable Above 1GHz	Hubersuhner	SUCOFLEX102	DA1580	Dec. 27, 2020

Output Power(Conducted) & Occupied Bandwidth & Emission Bandwidth & Band Edge Compliance & Conducted Spurious Emission					
Item	Test Equipment	Manufacturer	Model No.	Serial No.	Calibrated until
1	UNIVERSAL RADIO COMMUNICATION	Rohde & Schwarz	CMU200	114694	Dec. 27, 2020
2	Spectrum Analyzer	Rohde & Schwarz	FSU	100105	Dec. 27, 2020
3	Spectrum Analyzer	Rohde & Schwarz	FUV40-N	101331	Mar. 15, 2021
4	Splitter	Mini-Circuit	ZAPD-4	400059	Dec. 27, 2020

Frequency Stability					
Item	Test Equipment	Manufacturer	Model No.	Serial No.	Calibrated until
1	UNIVERSAL RADIO COMMUNICATION	Rohde & Schwarz	CMU200	114694	Dec. 27, 2020
2	Spectrum Analyzer	Rohde & Schwarz	FSU	100105	Dec. 27, 2020
3	Spectrum Analyzer	Rohde & Schwarz	FUV40-N	101331	Mar. 15, 2021
4	Splitter	Mini-Circuit	ZAPD-4	400059	Dec. 27, 2020
5	Climate Chamber	ESPEC	EL-10KA	05107008	Dec. 27, 2020

Note: 1. The Cal. Interval was one year.

2. The cable loss has calculated in test result which connection between each test instruments.



3. TEST ITEM AND RESULTS

3.1. Conducted Output Power

LIMIT:

Conducted Output Power: N/A

TEST CONFIGURATION

- For Conducted output Power



Note: Measurement setup for testing on Antenna connector

TEST PROCEDURE

- For Conducted output Power
 1. The transmitter output port was connected to base station.
 2. The RF output of EUT was connected to the power meter by RF cable and attenuator, the path loss was compensated to the results for each measurement.
 3. Set EUT at maximum power through base station.
 4. Select lowest, middle, and highest channels for each band and different modulation.
 5. Measure the maximum PK burst power and maximum Avg. burst power.

TEST RESULTS

Please see the appendix for every tested band.

3.2. Peak-to-Average Ratio

LIMIT

The Peak-to-Average Ratio (PAR) of the transmission may not exceed 13dB.

TEST CONFIGURATION

- For Peak-to-Average Ratio

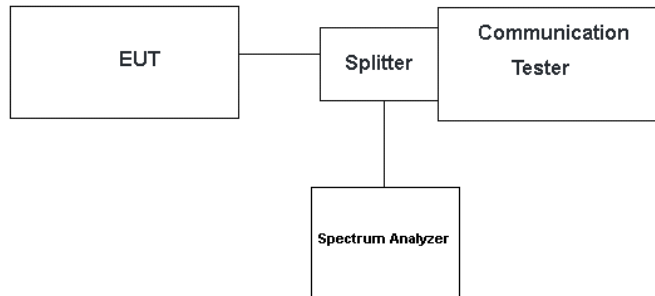

TEST PROCEDURE

- For Peak-to-Average Ratio
 1. The testing follows FCC KDB 971168 v02r02 Section 5.7.1.
 2. The EUT was connected to spectrum and communication tester via a splitter
 3. Set the CCDF (Complementary Cumulative Distribution Function) option in spectrum analyzer.
 4. The highest RF powers were measured and recorded the maximum PAPR level associated with a probability of 0.1 %.
 6. Record the deviation as Peak to Average Ratio.

TEST RESULTS

Please see the appendix for every tested band.



3.3. Occupy Bandwidth

LIMIT

N/A

TEST CONFIGURATION

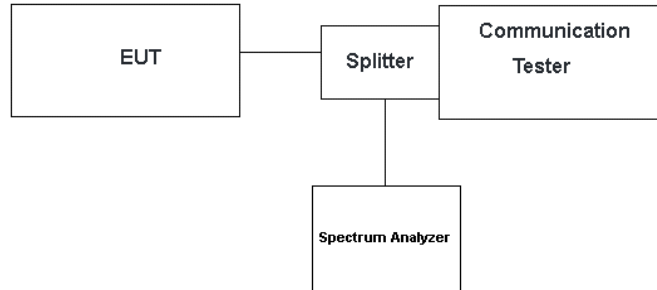

TEST PROCEDURE

1. The EUT's output RF connector was connected with a short cable to the spectrum analyzer
2. RBW was set to about 1% of emission BW, VBW \geq 3 times RBW.
3. -26dBc display line was placed on the screen (or 99% bandwidth), the occupied bandwidth is the delta frequency between the two points where the display line intersects the signal trace.

TEST RESULTS

Please see the appendix for every tested band.



3.4. Out of band emission at antenna terminals

LIMIT

FDD Band 26: The power of any emission outside of the authorized operating frequency ranges must be attenuated below the transmitting power (P) by a factor of at least $43 + 10 \log(P)$ dB.

The specification that emissions shall be attenuated below the transmitter power (P) by at least $43 + 10 \log(P)$ dB, translates in the relevant power range (1 to 0.001 W) to -13 dBm. At 1 W the specified minimum attenuation becomes 43 dB and relative to a 30 dBm (1 W) carrier becomes a limit of -13 dBm. At 0.001 W (0 dBm) the minimum attenuation is 13 dB, which again yields a limit of -13 dBm. In this way a translation of the specification from relative to absolute terms is carried out.

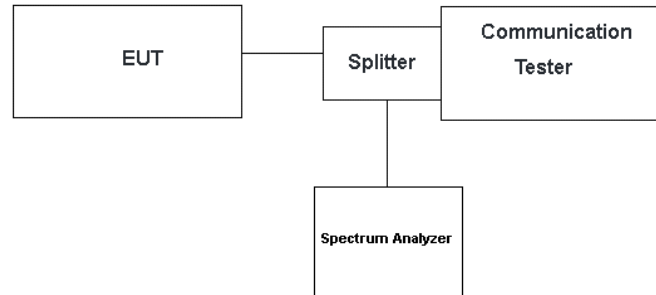

TEST PROCEDURE

1. The RF output of the transceiver was connected to a spectrum analyzer through appropriate attenuation.
2. The resolution bandwidth of the spectrum analyzer was set at 1MHz; sufficient scans were taken to show the out of band Emissions if any up to 10th harmonic.
3. For the out of band: Set the RBW = 1MHz VBW \geq 3 times RBW, Start=30MHz, Stop= 10th harmonic.

TEST RESULTS

Please see the appendix for every tested band.



3.5. Receiver Spurious Emissions at Antenna Terminal

LIMIT

RSS-GEN7.1.3, Receiver-spurious emissions at any discrete frequency shall not exceed 2 nW in the band 30-1000 MHz, nor 5 nW above 1000 MHz.

TEST CONFIGURATION

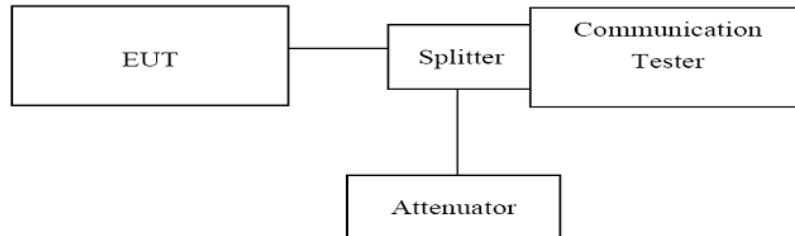

TEST PROCEDURE

1. The RF output of the transceiver was connected to a spectrum analyzer through appropriate attenuation.
2. The resolution bandwidth of the spectrum analyzer was set at 1MHz, sufficient scans were taken to show the out of band Emissions if any up to 10th harmonic.
3. Set the RBW= 100kHz, VBW =300kHz,below 1GHz
4. Set the RBW= 1MHz, VBW = 3MHz,above1GHz,
5. Start=30MHz, Stop= 10th harmonic.

TEST RESULTS

Note: Not Applicable.



3.6. Band Edge compliance

LIMIT

Part 22.917 specify that the power of any emission outside of the authorized operating frequency ranges must be attenuated below the transmitting power (P) by a factor of at least $43 + 10 \log(P)$ dB.

The specification that emissions shall be attenuated below the transmitter power (P) by at least $43 + 10 \log(P)$ dB, translates in the relevant power range (1 to 0.001 W) to -13 dBm. At 1 W the specified minimum attenuation becomes 43 dB and relative to a 30 dBm (1 W) carrier becomes a limit of -13 dBm. At 0.001 W (0 dBm) the minimum attenuation is 13 dB, which again yields a limit of -13 dBm. In this way a translation of the specification from relative to absolute terms is carried out.

Part 90.691 (a) Out of band emission requirement shall apply only to the “outer” channels included in an EA license and to spectrum adjacent to interior channels used by incumbent licensees. The emission limits are as follows:

(1) For any frequency removed from the EA licensee's frequency block by up to and including 37.5 kHz, the power of any emission shall be attenuated below the transmitter power (P) in watts by at least $116 \log_{10}(f/6.1)$ decibels or $50 + 10 \log_{10}(P)$ decibels or 80 decibels, whichever is the lesser attenuation, where f is the frequency removed from the center of the outer channel in the block in kilohertz and where f is greater than 12.5 kHz.

(2) For any frequency removed from the EA licensee's frequency block greater than 37.5 kHz, the power of any emission shall be attenuated below the transmitter power (P) in watts by at least $43 + 10 \log_{10}(P)$ decibels or 80 decibels, whichever is the lesser attenuation, where f is the frequency removed from the center of the outer channel in the block in kilohertz and where f is greater than 37.5 kHz.

TEST CONFIGURATION

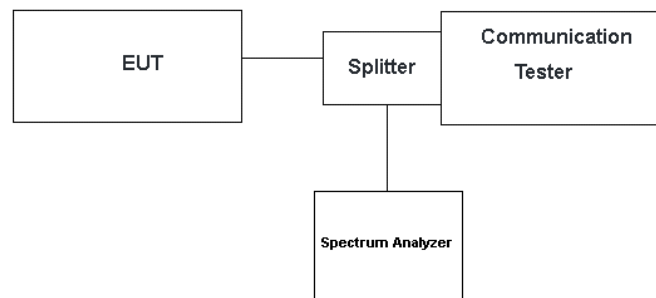

TEST PROCEDURE

- The RF output of the transceiver was connected to a spectrum analyzer through appropriate attenuation.
- RBW was set to about 1% of emission BW, $VBW \geq 3$ times RBW.

TEST RESULTS

Please see the appendix for every tested band.

3.7. Radiated Power Measurement

LIMIT

LTE FDD Band 18: 7W(38.45dBm) EPR
LTE FDD Band 26: 7W(38.45dBm) EPR

TEST CONFIGURATION

For the actual test configuration, please refer to the related Item – EUT Test Photos.

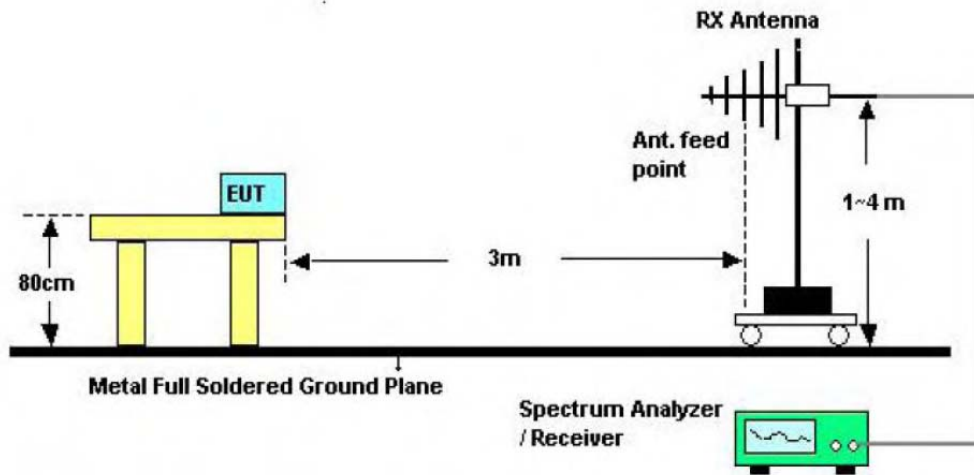

Below 1GHz

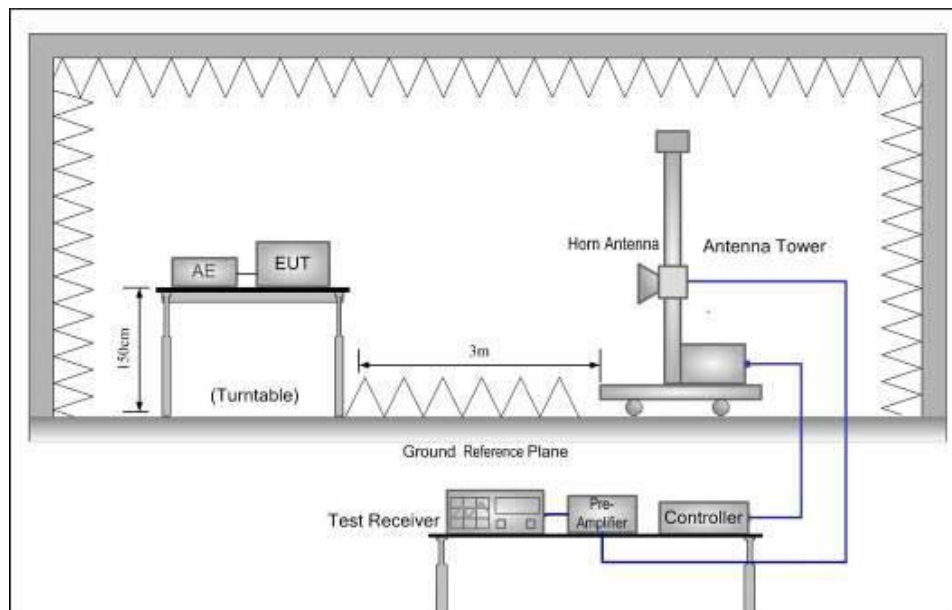

Above 1GHz



TEST PROCEDURE

1. EUT was placed on a 1.50 meter high non-conductive stand at a 3 meter test distance from the receive antenna. A receiving antenna was placed on the antenna mast 3 meters from the EUT for emission measurements. The height of receiving antenna is 1.50m. Detected emissions were maximized at each frequency by rotating the EUT through 360° and adjusting the receiving antenna polarization. The radiated emission measurements of all transmit frequencies in three channels (High, Middle, Low) were measured with peak detector.
2. A log-periodic antenna or double-ridged waveguide horn antenna shall be substituted in place of the EUT. The log-periodic antenna will be driven by a signal generator and the level will be adjusted till the same power value on the spectrum analyzer or receiver. The level of the spurious emissions can be calculated through the level of the signal generator, cable loss, the gain of the substitution antenna and the reading of the spectrum analyzer or receiver.
3. The EUT is then put into continuously transmitting mode at its maximum power level during the test. Set Test Receiver or Spectrum RBW=1MHz, VBW=3MHz, and the maximum value of the receiver should be recorded as (Pr).
4. The EUT shall be replaced by a substitution antenna. In the chamber, an substitution antenna for the frequency band of interest is placed at the reference point of the chamber. An RF Signal source for the frequency band of interest is connected to the substitution antenna with a cable that has been constructed to not interfere with the radiation pattern of the antenna. A power (PMea) is applied to the input of the substitution antenna, and adjusts the level of the signal generator output until the value of the receiver reach the previously recorded (Pr). The power of signal source (PMea) is recorded. The test should be performed by rotating the test item and adjusting the receiving antenna polarization.
5. An amplifier should be connected to the Signal Source output port. And the cable should be connecting between the Amplifier and the Substitution Antenna. The cable loss (Pcl), the Substitution Antenna Gain (Ga) and the Amplifier Gain (PAg) should be recorded after test.
6. The measurement results are obtained as described below:
Power(EIRP)=PMea- PAg - Pcl + Ga
We used N5182A microwave signal generator which signal level can up to 33dBm,so we not used power Amplifier for substitution test; The measurement results are amend as described below:
Power(EIRP)=PMea- Pcl + Ga
7. This value is EIRP since the measurement is calibrated using an antenna of known gain (2.15dBi) and known input power.
ERP can be calculated from EIRP by subtracting the gain of the dipole, ERP = EIRP-2.15dBi.

TEST RESULTS

Remark:

1. By preliminary testing and verifying three axis (X, Y and Z) position of EUT transmitted status, it was found that "Z axis" position was the worst, and test data recorded in this report.



LTE Band 18 (817.5) - 5MHz					
Modulation	Channel	ERP (dBm)		Limit (dBm)	Result
		Vertical	Horizontal		
QPSK	Mid	23.47	20.82	≤38.45	PASS
16QAM	Mid	24.17	20.51		

LTE Band 26 (814-824) - 1.4MHz					
Modulation	Channel	ERP (dBm)		Limit (dBm)	Result
		Vertical	Horizontal		
QPSK	Low	23.93	20.96	≤38.45	PASS
	Mid	23.78	20.42		
	High	23.75	20.98		
16QAM	Low	23.73	20.94		
	Mid	24.35	20.27		
	High	23.54	20.40		

LTE Band 26 (814-824) - 3MHz					
Modulation	Channel	ERP (dBm)		Limit (dBm)	Result
		Vertical	Horizontal		
QPSK	Low	23.50	20.27	≤38.45	PASS
	Mid	24.25	20.68		
	High	23.97	21.01		
16QAM	Low	24.19	20.68		
	Mid	23.87	20.91		
	High	24.43	20.67		

LTE Band 26 (814-824) - 5MHz					
Modulation	Channel	ERP (dBm)		Limit (dBm)	Result
		Vertical	Horizontal		
QPSK	Low	23.51	20.56	≤38.45	PASS
	Mid	24.25	20.47		
	High	23.64	20.29		
16QAM	Low	24.00	20.37		
	Mid	23.63	20.81		
	High	23.58	20.48		



LTE Band 26 (814-824) - 10MHz					
Modulation	Channel	ERP (dBm)		Limit (dBm)	Result
		Vertical	Horizontal		
QPSK	Mid	24.30	20.30	≤38.45	PASS
16QAM	Mid	24.60	20.97		

3.8. Radiated Spurious Emission

LIMIT

FDD Band 18: The power of any emission outside of the authorized operating frequency ranges must be attenuated below the transmitting power (P) by a factor of at least $43 + 10 \log(P)$ dB.

FDD Band 26: The power of any emission outside of the authorized operating frequency ranges must be attenuated below the transmitting power (P) by a factor of at least $43 + 10 \log(P)$ dB.

TEST CONFIGURATION

For the actual test configuration, please refer to the related Item – EUT Test Photos.

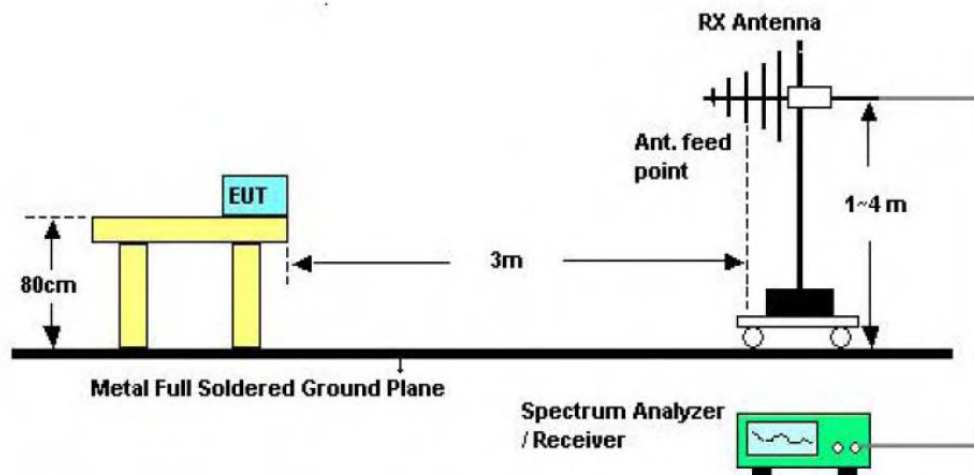

Below 1GHz

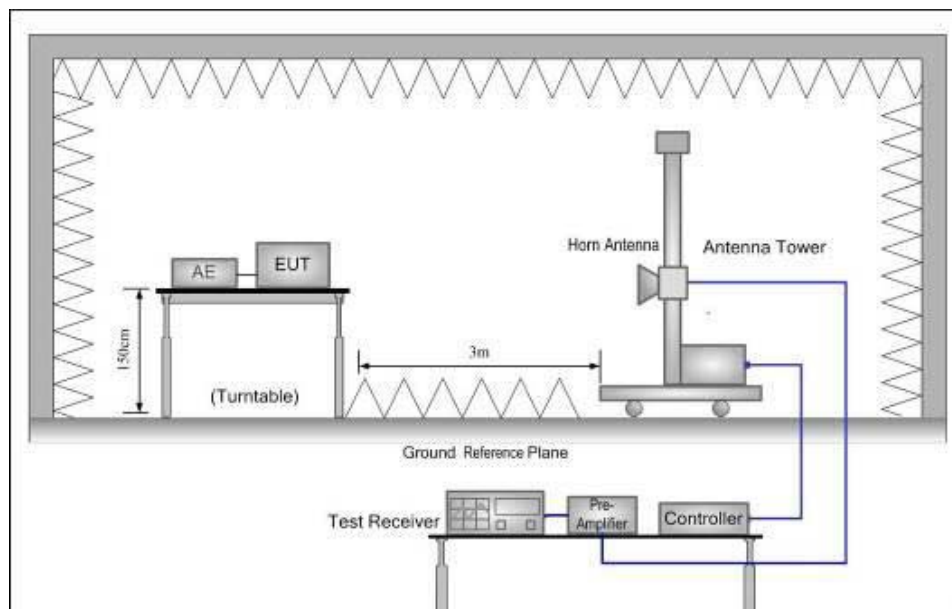

Above 1GHz



TEST PROCEDURE

1. EUT was placed on a 1.50 meter high non-conductive stand at a 3 meter test distance from the receive antenna. A receiving antenna was placed on the antenna mast 3 meters from the EUT for emission measurements. The height of receiving antenna is 1.50m. Detected emissions were maximized at each frequency by rotating the EUT through 360° and adjusting the receiving antenna polarization. The radiated emission measurements of all transmit frequencies in three channels (High, Middle, Low) were measured with peak detector.
2. A log-periodic antenna or double-ridged waveguide horn antenna shall be substituted in place of the EUT. The log-periodic antenna will be driven by a signal generator and the level will be adjusted till the same power value on the spectrum analyzer or receiver. The level of the spurious emissions can be calculated through the level of the signal generator, cable loss, the gain of the substitution antenna and the reading of the spectrum analyzer or receiver.
3. The EUT is then put into continuously transmitting mode at its maximum power level during the test. Set Test Receiver or Spectrum RBW=1MHz, VBW=3MHz, and the maximum value of the receiver should be recorded as (Pr).
4. The EUT shall be replaced by a substitution antenna. In the chamber, an substitution antenna for the frequency band of interest is placed at the reference point of the chamber. An RF Signal source for the frequency band of interest is connected to the substitution antenna with a cable that has been constructed to not interfere with the radiation pattern of the antenna. A power (PMea) is applied to the input of the substitution antenna, and adjusts the level of the signal generator output until the value of the receiver reach the previously recorded (Pr). The power of signal source (PMea) is recorded. The test should be performed by rotating the test item and adjusting the receiving antenna polarization.
5. An amplifier should be connected to the Signal Source output port. And the cable should be connecting between the Amplifier and the Substitution Antenna. The cable loss (Pcl) ,the Substitution Antenna Gain (Ga) and the Amplifier Gain (PAg) should be recorded after test.
6. The measurement results are obtained as described below:
Power(EIRP)=PMea- PAg - Pcl + Ga
We used SMF100A microwave signal generator which signal level can up to 33dBm,so we not used power Amplifier for substitution test; The measurement results are amend as described below:
Power(EIRP)=PMea- Pcl + Ga
7. This value is EIRP since the measurement is calibrated using an antenna of known gain (2.15 dBi) and known input power.
ERP can be calculated from EIRP by subtracting the gain of the dipole, ERP = EIRP-2.15dBi.
8. Test frequency range should extend to 10th harmonic of highest fundamental frequency.

TEST RESULTS

Remark:

1. By preliminary testing and verifying three axis (X, Y and Z) position of EUT transmitted status, it was found that “Z axis” position was the worst, and test data recorded in this report.



Measured data (worst case):

Band 18 (817.5) Radiated Spurious Emissions							
Bandwidth	Modulation	Test Channel	Spurious Emission			Limit (dBm)	Result
			Frequency	Level (dBm)	Polarization		
5MHz	QPSK	M	1635.0	-41.45	Vertical	-13.00	Pass
			2452.5	-49.32	Vertical		
			1635.0	-45.71	Horizontal		
			2452.5	-53.52	Horizontal		
5MHz	16QAM	M	1635.0	-41.70	Vertical	-13.00	Pass
			2452.5	-49.39	Horizontal		
			1635.0	-41.87	Vertical		
			2452.5	-54.63	Horizontal		

Remark:

1. The emission behavior belongs to narrowband spurious emission.
2. The emission levels of below 1 GHz are very lower than the limit above 10dB and not show in test report.

Band 26 (814-824) Radiated Spurious Emissions							
Bandwidth	Modulation	Test Channel	Spurious Emission			Limit (dBm)	Result
			Frequency	Level (dBm)	Polarization		
10MHz	QPSK	M	1638.0	-40.81	Vertical	-13.00	Pass
			2457.0	-48.83	Vertical		
			1638.0	-45.86	Horizontal		
			2457.0	-53.30	Horizontal		
10MHz	16QAM	M	1638.0	-41.78	Vertical	-13.00	Pass
			2457.0	-49.41	Horizontal		
			1638.0	-42.89	Vertical		
			2457.0	-52.12	Horizontal		

Remark:

3. The emission behavior belongs to narrowband spurious emission.
4. The emission levels of below 1 GHz are very lower than the limit above 10dB and not show in test report.



3.9. Frequency stability

LIMIT

Within the authorized frequency block

TEST CONFIGURATION

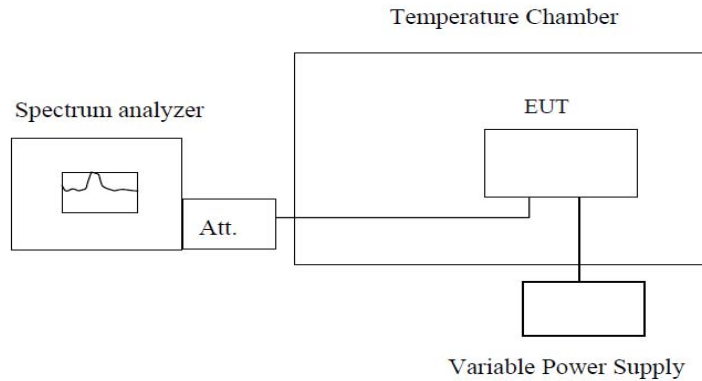

Note : Measurement setup for testing on Antenna connector

TEST PROCEDURE

1. The equipment under test was connected to an external DC power supply and input rated voltage.
2. RF output was connected to a frequency counter or spectrum analyzer via feed through attenuators.
3. The EUT was placed inside the temperature chamber.
4. Set the spectrum analyzer RBW low enough to obtain the desired frequency resolution and measure EUT 25°C operating frequency as reference frequency.
5. Turn EUT off and set the chamber temperature to 0°C. After the temperature stabilized for approximately 30 minutes recorded the frequency.
6. Repeat step measure with 10°C increased per stage until the highest temperature of +45°C reached.
7. Reduce the input voltage to specified extreme voltage variation (+/- 10%) and endpoint, record the maximum frequency change.

TEST RESULTS

Please see the appendix for every tested band.

*****THE END*****