



# TEST REPORT

Report Number: C21T00111-SRD03-V01

Applicant	ESPRESSIF SYSTEMS (SHANGHAI) CO., LTD
Product Name	Wi-Fi & Bluetooth Internet of Things Module
Model Name	ESP32-WROOM-DA
Brand Name	ESPRESSIF
FCC ID	2AC7Z-ESPWROOMDA

Industrial Internet Innovation Center (Shanghai) Co., Ltd. tested the above equipment in accordance with the requirements in FCC Part15, ANSI C63.10, KDB 558074, RSS-Gen Issue 5, RSS-247 Issue 2.

Prepared by

Reviewed by

Approved by

Issue Date

2021-11-30

**Industrial Internet Innovation Center (Shanghai) Co., Ltd.**



## NOTE

1. This report is invalid without the signature of the writer, reviewer and authorizer.
2. This report is invalid if altered.
3. For the benefit of clients, if you have any objection to the report, please inform the testing laboratory within 15 days from the date of receiving this report.
4. Samples in the test report are provided by the client. The test results are only applicable to the samples received by the laboratory. The source information of samples (such as sample sender, manufacturer, etc.) in the test report is provided by the client, and the laboratory is not responsible for its authenticity and the measurement accuracy.
5. The test report does not represent the identification of a product by a certification body or an authorized body.
6. This report is only valid as a whole, and no part of the report can be reproduced without the written approval of Industrial Internet Innovation Center (Shanghai) Co., Ltd.
7. Without the written permission of testing institutions and accreditation bodies, this report cannot be used in part or in whole for publicity or product introduction.
8. "N/A" is used in this report to indicate that it is not applicable or available.
9. Industrial Internet Innovation Center (Shanghai) Co., Ltd. assumes the legal responsibility for the report.
10. The measurement uncertainty is not taken into account when deciding conformity, and the results of measurement (or the average of measurement results) are directly used as the criterion for the stating conformity.

### **Test Laboratory:**

Industrial Internet Innovation Center (Shanghai) Co., Ltd.  
Add: Building 4, No. 766 Jingang Rd, Pudong, Shanghai, China  
Tel: +86 21 68866880



### Revision Version

Report Number	Revision	Date	Memo
C21T00111-SRD03-V00	00	2021-10-29	Initial creation of test report
C21T00111-SRD03-V01	01	2021-11-30	A description of the antenna is added in the fourth chapter.



## CONTENTS

<b>1. TEST LABORATORY .....</b>	<b>6</b>
<b>1.1. TESTING LOCATION .....</b>	<b>6</b>
<b>1.2. TESTING ENVIRONMENT .....</b>	<b>6</b>
<b>1.3. PROJECT INFORMATION .....</b>	<b>6</b>
<b>2. CLIENT INFORMATION .....</b>	<b>7</b>
<b>2.1. APPLICANT INFORMATION .....</b>	<b>7</b>
<b>2.2. MANUFACTURER INFORMATION .....</b>	<b>7</b>
<b>3. EQUIPMENT UNDER TEST (EUT) AND ANCILLARY EQUIPMENT (AE) .....</b>	<b>8</b>
<b>3.1. ABOUT EUT .....</b>	<b>8</b>
<b>3.2. INTERNAL IDENTIFICATION OF EUT USED DURING THE TEST .....</b>	<b>8</b>
<b>3.3. INTERNAL IDENTIFICATION OF AE USED DURING THE TEST .....</b>	<b>8</b>
<b>4. REFERENCE DOCUMENTS .....</b>	<b>9</b>
<b>4.1. REFERENCE DOCUMENTS FOR TESTING .....</b>	<b>9</b>
<b>4.2. REFERENCE INFORMATION FROM CLIENT .....</b>	<b>9</b>
<b>5. TEST SUMMARY .....</b>	<b>11</b>
<b>5.1. SUMMARY OF TEST RESULTS .....</b>	<b>11</b>
<b>5.2. STATEMENTS .....</b>	<b>12</b>
<b>6. MEASUREMENT RESULTS .....</b>	<b>13</b>
<b>6.1. OUTPUT POWER-CONDUCTED .....</b>	<b>14</b>
<b>6.1.1 Measurement Limit and method .....</b>	<b>14</b>
<b>6.1.2 Test procedure .....</b>	<b>14</b>
<b>6.2. PEAK POWER SPECTRAL DENSITY .....</b>	<b>19</b>
<b>6.2.1 Measurement Limit .....</b>	<b>19</b>
<b>6.2.2 Test procedures .....</b>	<b>19</b>
<b>6.2.3. Test Setup .....</b>	<b>19</b>



<b>6.3. OCCUPIED 6DB BANDWIDTH .....</b>	<b>23</b>
6.3.1 Measurement Limit .....	23
6.3.2 Test procedure .....	23
6.3.3 Test Setup .....	23
<b>6.4. BAND EDGES COMPLIANCE.....</b>	<b>27</b>
6.4.1 Measurement Limit .....	27
6.4.2 Test procedures .....	27
<b>6.5. TRANSMITTER SPURIOUS EMISSION-CONDUCTED .....</b>	<b>30</b>
6.5.1 Measurement Limit .....	30
6.5.2 Test procedures .....	30
6.5.3. Test Setup.....	31
<b>6.6. TRANSMITTER SPURIOUS EMISSION-RADIATED.....</b>	<b>38</b>
6.6.1 Measurement Limit .....	38
6.6.2 Limit in restricted band .....	38
6.6.3 Test procedures .....	38
6.6.4. Test Setup .....	39
<b>7. TEST EQUIPMENT LIST.....</b>	<b>53</b>
7.1. CONDUCTED TEST SYSTEM.....	53
7.2. RADIATED EMISSION TEST SYSTEM.....	53
<b>ANNEX A: MEASUREMENT UNCERTAINTY.....</b>	<b>54</b>
<b>ANNEX B: ACCREDITATION CERTIFICATE.....</b>	<b>55</b>

## 1. Test Laboratory

### 1.1. Testing Location

Primary Lab:

Company Name	Industrial Internet Innovation Center (Shanghai) Co., Ltd.
Address	Building 4, No. 766 Jingang Rd, Pudong, Shanghai, China
FCC Registration No.	958356
FCC Designation No.	CN1177
IC Designation No.	CN0067

Subcontracting Lab #1:

Company Name	N/A
Address	N/A

### 1.2. Testing Environment

Normal Temperature	15°C~35°C
Relative Humidity	30%RH~60%RH
Supply Voltage	120V/60Hz

### 1.3. Project Information

Project Leader	Wang Wenwen
Testing Start Date	2021-09-16
Testing End Date	2021-10-29



## 2. Client Information

### 2.1. Applicant Information

Company Name	ESPRESSIF SYSTEMS (SHANGHAI) CO., LTD
Address	Suite 101, Block 2, 690 Bibo Road, Zhang Jiang Hi-Tech Park, Shanghai, China
Telephone	15921838395

### 2.2. Manufacturer Information

Company Name	ESPRESSIF SYSTEMS (SHANGHAI) CO., LTD
Address	Suite 101, Block 2, 690 Bibo Road, Zhang Jiang Hi-Tech Park, Shanghai, China
Telephone	15921838395

### 3. Equipment under Test (EUT) and Ancillary Equipment (AE)

#### 3.1. About EUT

Product Name	Wi-Fi & Bluetooth Internet of Things Module
Model name	ESP32-WROOM-DA
Supported Radio Technology and Bands	BT BR/EDR /LE WLAN b/g/n
Hardware Version	V1.1
Software Version	V1.1.3.0
FCC ID	2AC7Z-ESPWROOMDA

#### 3.2. Internal Identification of EUT used during the test

EUT ID*	SN or IMEI	HW Version	SW Version	Date of Receipt
N01	N/A	V1.1	V1.1.3.0	2021-09-15
N03	N/A	V1.1	V1.1.3.0	2021-09-15
N04	N/A	V1.1	V1.1.3.0	2021-09-15

\*EUT ID: is internally used to identify the test sample in the lab.

#### 3.3. Internal Identification of AE used during the test

AE ID*	Description	Model	SN/Remark
AE1	RF Cable	N/A	N/A

\*AE ID: is internally used to identify the test sample in the lab.

\*The AE is provided by the client.



## 4. Reference Documents

### 4.1. Reference Documents for testing

The following documents listed in this section are referred for testing.

Reference	Title	Version
FCC Part15	FCC CFR 47, Part 15, Subpart C: 15.205 Restricted bands of operation; 15.209 Radiated emission limits, general requirements; 15.247 Operation within the bands 902-928MHz, 2400-2483.5MHz, and 5725-5850MHz.	2018-10-01
ANSI C63.10	American National Standard of Procedures for Compliance Testing of Unlicensed Wireless Devices	2013
KDB 558074	Guidance for Performing Compliance Measurements on Frequency Hopping Spread Spectrum systems (DSS) Operating Under §15.247	v05r02
RSS-247 Issue 2	Digital Transmission Systems (DTSs), Frequency Hopping Systems (FHSs) and Licence-Exempt Local Area Network (LE-LAN) Devices	2017
RSS-Gen Issue 5	General Requirements for Compliance of Radio Apparatus	2019

### 4.2. Reference Information from client

Antenna gain Information of the test sample provided by client.

Maximum of Antenna Gain: 1.06 dBi

This DUT has two antennas, one of antenna's gain is 0.91 dBi, another is 1.06 dBi, and the report results are tested by using the maximum gain antenna, which is the worst-case model showed in the the report.

Note:The product ESP32-WROOM-DA use an integral antenna which compliance with the requirement of 15.203.



## 5. Test Summary

### 5.1. Summary of Test Results

Measurement Items	Sub-clause of Part15C	Sub-clause of IC	Verdict
Maximum Peak Output Power	15.247(b)	RSS-247 5.4	Pass
Peak Power Spectral Density	15.247(e)	RSS-247 5.2	Pass
Occupied 6dB Bandwidth	15.247(a)	RSS-247 5.2	Pass
99% Occupied Bandwidth	N/A	RSS-Gen 6.7	Pass
Band Edges Compliance	15.247(d)	RSS-247 5.5	Pass
Transmitter Spurious Emission-Conducted	15.247(d)	RSS-247 5.5	Pass
Transmitter Spurious Emission-Radiated	15.247/15.205/1 5.209	RSS-Gen 8.9,8.10	Pass

#### Test Conditions

Tnom	Normal Temperature
Tmin	Low Temperature
Tmax	High Temperature
Vnom	Normal Voltage
Vmin	Low Voltage
Vmax	High Voltage
Hnom	Norm Humidity
Anom	Norm Air Pressure

For this report, all the test case listed above are tested under Normal Temperature and Normal Voltage, and also under norm humidity, the specific conditions as following:

Temperature	Tnom	25°C
Voltage	Vnom	24V
Humidity	Hnom	48%
Air Pressure	Anom	1010hPa

Note:

- a. All the test data for each data were verified, but only the worst case was reported.



## 5.2. Statements

The ESP32-WROOM-DA manufactured by Cippa Vision Ltd, Incorporated are new products for testing.

Industrial Internet Innovation Center (Shanghai) Co., Ltd. only performed test cases which identified with Pass/Fail/Inc result in section 5.1.

Industrial Internet Innovation Center (Shanghai) Co., Ltd. has verified that the compliance of the tested device specified in section 3 of this test report is successfully evaluated according to the procedure and test methods as defined in type certification requirement listed in section 4 of this test report.

## 6. Measurement Results

**Shielding Room1** (6.0 meters×3.0 meters×2.7 meters) did not exceed following limits along the conducted RF performance testing:

Temperature	Min. = 15 °C, Max. = 35 °C
Relative humidity	Min. = 20 %, Max. = 75 %
Shielding effectiveness	> 100 dB
Electrical insulation	> 10 kΩ
Ground system resistance	< 0.5 Ω

**Control room** did not exceed following limits along the EMC testing:

Temperature	Min. = 15 °C, Max. = 35 °C
Relative humidity	Min. =30 %, Max. = 60 %
Shielding effectiveness	> 100 dB
Electrical insulation	> 10 kΩ
Ground system resistance	< 0.5 Ω

**Fully-anechoic chamber1** (6.9 meters×10.9 meters×5.4 meters) did not exceed following limits along the EMC testing:

Temperature	Min. = 15 °C, Max. = 35 °C
Relative humidity	Min. = 25 %, Max. = 75 %
Shielding effectiveness	> 100 dB
Electrical insulation	> 10 kΩ
Ground system resistance	< 0.5 Ω
VSWR	Between 0 and 6 dB, from 1GHz to 18GHz
Site Attenuation Deviation	Between -4 and 4 dB,30MHz to 1GHz
Uniformity of field strength	Between 0 and 6 dB, from 80MHz to 3000 MHz

## 6.1. Output Power-Conducted

### 6.1.1 Measurement Limit and method

Standard	Limit(dBm)
FCC 47 Part 15.247(b) (3)	<30
RSS-247 5.4(d)	<30

### 6.1.2 Test procedure

The measurement is according to ANSI C63.10 clause 11.9.

- a) Set span to at least 1.5 times the OBW.
- b) Set RBW = 1-5% of the OBW, not to exceed 1 MHz.
- c) Set VBW  $\geq 3 \times$  RBW.
- d) Number of points in sweep  $\geq 2 \times$  span / RBW. (This gives bin-to-bin spacing  $\leq$  RBW/2, so that narrowband signals are not lost between frequency bins.)
- e) Sweep time = auto.
- f) Detector = RMS (i.e., power averaging), if available. Otherwise, use sample detector mode.
- g) If transmit duty cycle < 98 %, use a sweep trigger with the level set to enable triggering only on full power pulses. The transmitter shall operate at maximum power control level for the entire duration of every sweep. If the EUT transmits continuously (i.e., with no off intervals) or at duty cycle  $\geq 98$  %, and if each transmission is entirely at the maximum power control level, then the trigger shall be set to “free run” .
- h) Trace average at least 100 traces in power averaging (i.e., RMS) mode.i) Compute power by integrating the spectrum across the OBW of the signal using the instrument’ s band power measurement function, with band limits set equal to the OBW band edges. If the instrument does not have a band power function, sum the spectrum levels (in power units) at intervals equal to the RBW extending across the entire OBW of the spectrum.

## Test Setup

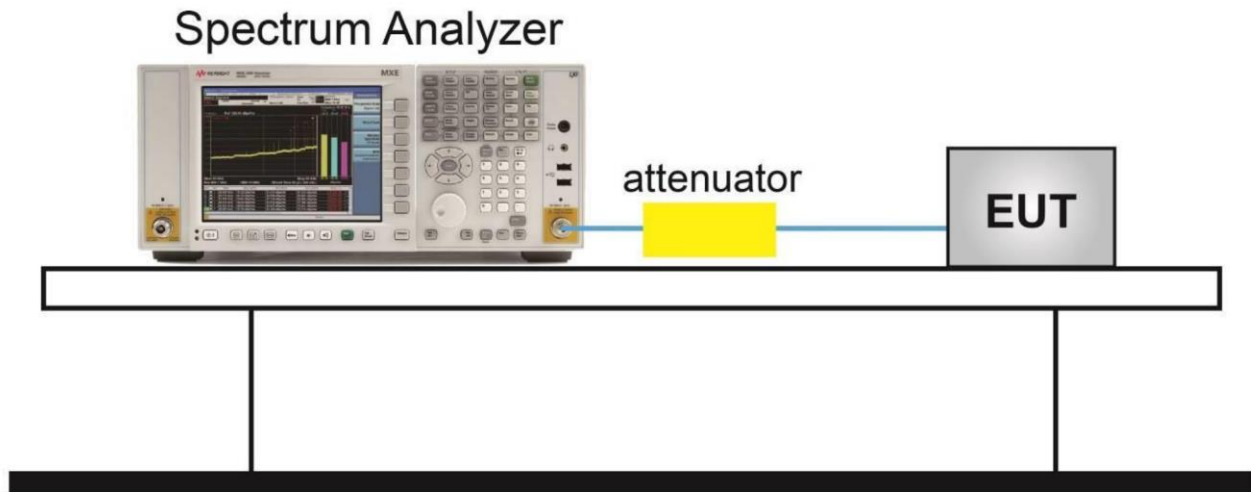

**Maximum Average Output Power-conducted  
Measurement Results**

Mode	Channel	Conducted (dBm)	E. I.R.P(dBm)	Duty cycle factor (dB)
802.11b	2412	17.74	18.95	0.15
	2437	17.57	18.78	0.15
	2462	17.87	19.08	0.15
802.11g	2412	16.44	18.29	0.79
	2437	16.17	18.02	0.79
	2462	16.82	18.67	0.79
802.11n(20MHz)	2412	16.18	17.34	0.1
	2437	15.83	16.99	0.1
	2462	16.47	17.63	0.1
802.11n(40MHz)	2422	15.8	17.19	0.33
	2437	15.59	16.98	0.33
	2452	14.9	16.29	0.33

**Conclusion: PASS**

**TEST PLOTS:**

Output Power-Conducted (802.11b, Ch1)

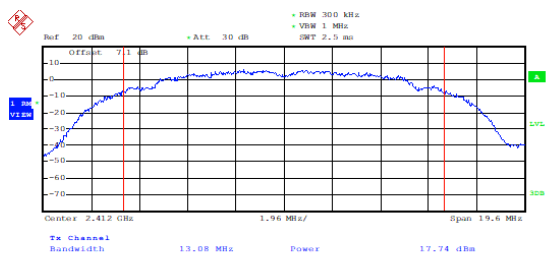

Date: 8.OCT.2021 14:37:23

Output Power-Conducted (802.11b, Ch6)

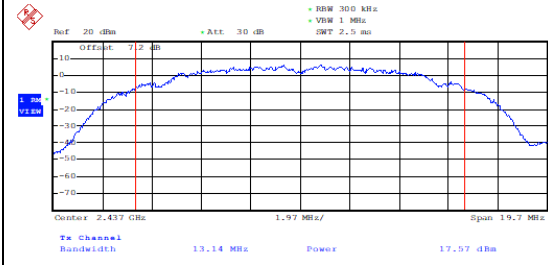

Date: 8.OCT.2021 14:37:48

Output Power-Conducted (802.11b, Ch11)

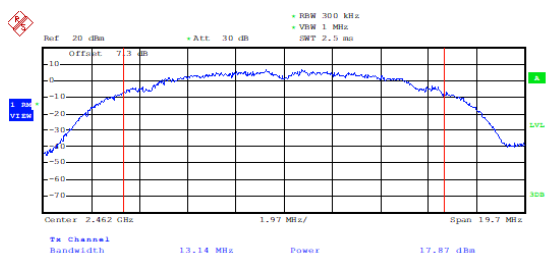

Date: 8.OCT.2021 14:38:28

Output Power-Conducted (802.11g, Ch1)

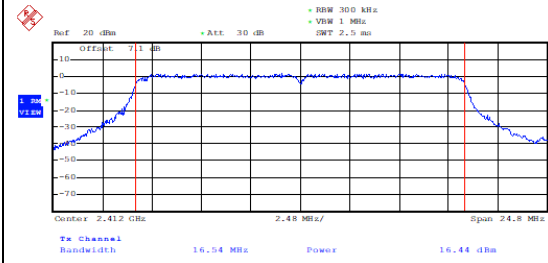

Date: 8.OCT.2021 14:38:56

Output Power-Conducted (802.11g, Ch6)

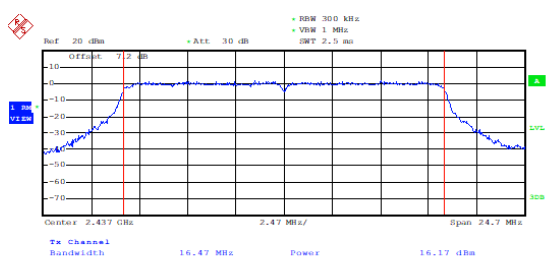

Date: 8.OCT.2021 14:39:24

Output Power-Conducted (802.11g, Ch11)

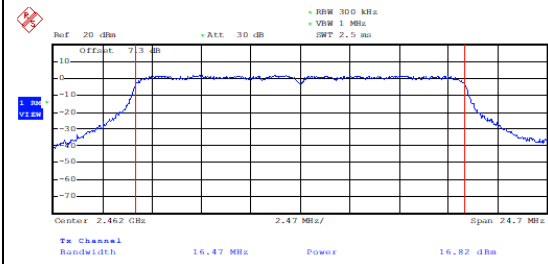

Date: 8.OCT.2021 14:39:50



### Output Power-Conducted (802.11n-HT20, Ch1)

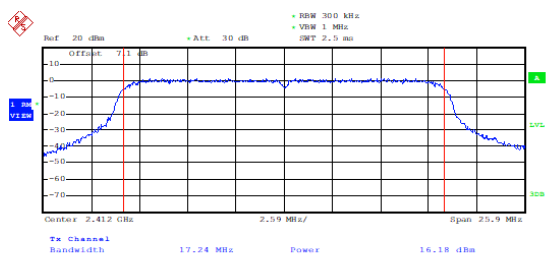

Date: 8.OCT.2021 14:40:28

### Output Power-Conducted (802.11n-HT20, Ch6)

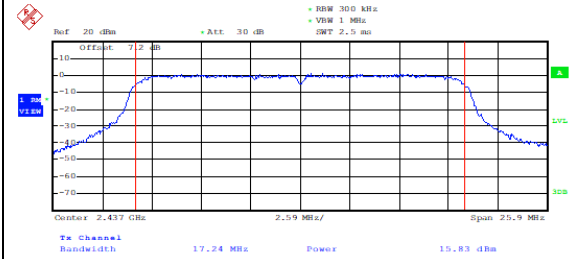

Date: 8.OCT.2021 14:41:32

### Output Power-Conducted (802.11n-HT20, Ch11)

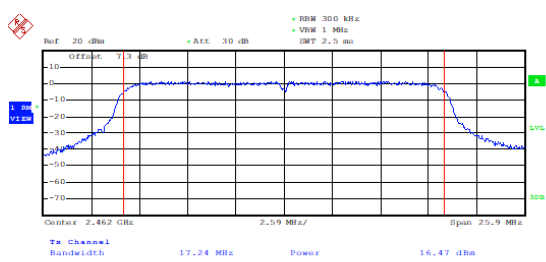

Date: 8.OCT.2021 14:42:17

### Output Power-Conducted (802.11n-HT40, Ch 3)

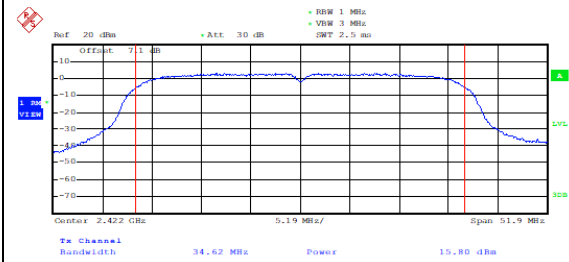

Date: 8.OCT.2021 14:42:48

### Output Power-Conducted (802.11n-HT40, Ch 6)

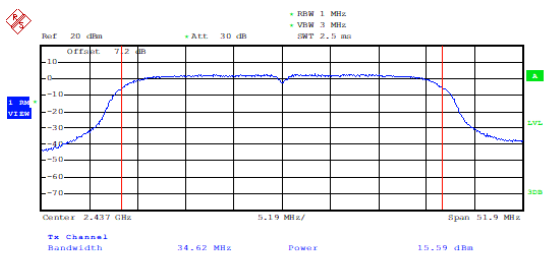

Date: 8.OCT.2021 14:49:25

### Output Power-Conducted (802.11n-HT40, Ch 9)

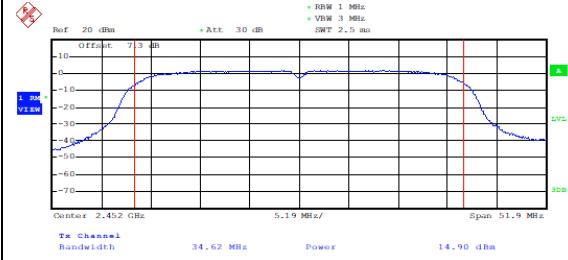

Date: 29.OCT.2021 12:22:21

## 6.2. Peak Power Spectral Density

### 6.2.1 Measurement Limit

Standard	Limit
FCC 47 Part 15.247(e)	$\leq 8\text{dBm}/3\text{ KHz}$
RSS-247 5.2(b)	$\leq 8\text{dBm}/3\text{ kHz}$

### 6.2.2 Test procedures

The measurement is according to ANSI C63.10 clause 11.10.

1. The output power of EUT was connected to the spectrum analyzer. The path loss was compensated to the results for each measurement.
2. Enable EUT transmitter maximum power continuously.
3. Set analyzer center frequency to DTS channel center frequency.
4. Set the span to 1.5 times the DTS bandwidth.
5. Set the RBW=3kHz
6. Set the VBW  $\geq [3 \times \text{RBW}]$ .
7. Detector = peak.
8. Sweep time = auto couple.
9. Trace mode = max hold.
10. Allow trace to fully stabilize.
11. Use the peak marker function to determine the maximum amplitude level within the RBW.
12. If measured value exceeds requirement, then reduce RBW (but no less than 3 kHz) and repeat.

### 6.2.3. Test Setup

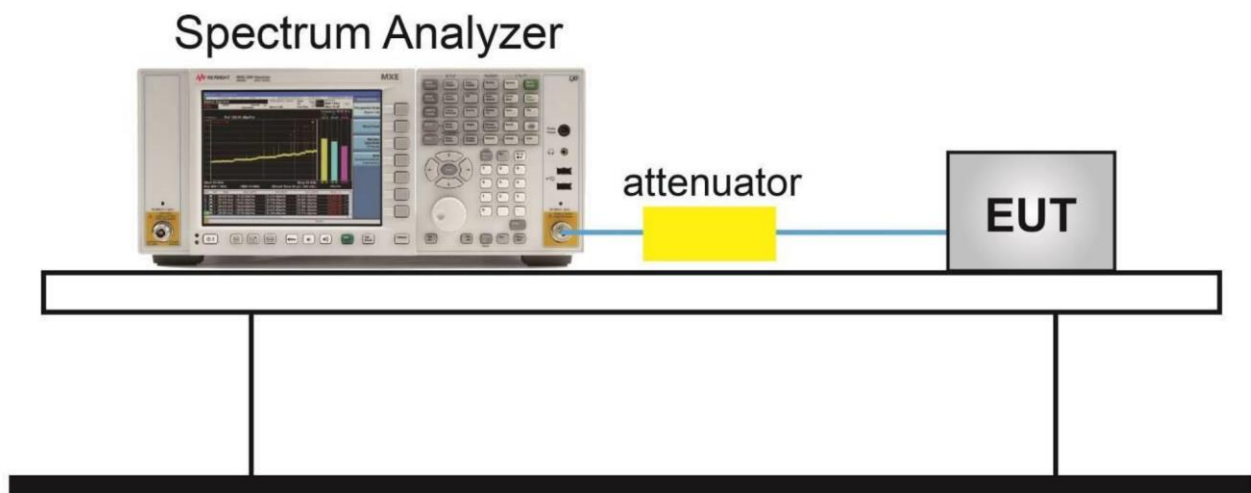

**Measurement Results:**

<p>Power Spectral Density(dBm/3kHz) (802.11b, Ch1)</p>	<p>-3.101</p>	<p>Power Spectral Density(dBm/3kHz) (802.11b, Ch6)</p>	<p>-3.740</p>
<p>Power Spectral Density (dBm/3kHz) (802.11b, Ch11)</p>	<p>-2.632</p>	<p>Power Spectral Density (dBm/3kHz) (802.11g, Ch1)</p>	<p>-7.026</p>

<p>Power Spectral Density (dBm/3kHz) (802.11g, Ch6)</p>	<p>-7.487</p>	<p>Power Spectral Density (dBm/3kHz) (802.11g, Ch11)</p>	<p>-6.804</p>
<p>Power Spectral Density (dBm/3kHz) (802.11n-20MHz, Ch1)</p>	<p>-7.509</p>	<p>Power Spectral Density (dBm/3kHz) (802.11n-20MHz, Ch6)</p>	<p>-7.670</p>

<p>Power Spectral Density (dBm/3kHz) (802.11n-20MHz, Ch 11)</p>	<p>-7.063</p>	<p>Power Spectral Density (dBm/3kHz) (802.11n-40MHz, Ch3)</p>	<p>-10.813</p>
<p>Date: 8.OCT.2021 15:15:27</p>	<p>Date: 8.OCT.2021 15:16:16</p>		
<p>Power Spectral Density (dBm/3kHz) (802.11n-40MHz, Ch6)</p>	<p>-11.236</p>	<p>Power Spectral Density (dBm/3kHz) (802.11n-40MHz, Ch9)</p>	<p>-10.565</p>
<p>Date: 8.OCT.2021 15:17:04</p>	<p>Date: 8.OCT.2021 15:18:26</p>		

### 6.3. Occupied 6dB Bandwidth

#### 6.3.1 Measurement Limit

Standard	Limit(KHz)
FCC 47 Part 15.247(a) (2)	≥500
RSS-247 5.2(a)	≥500kHz

#### 6.3.2 Test procedure

The measurement is according to ANSI C63.10 clause 11.8.

1. The output power of EUT was connected to the spectrum analyzer. The path loss was compensated to the results for each measurement.
2. Enable EUT transmitter maximum power continuously.
3. Set RBW = 100 kHz.
4. Set the VBW  $\geq [3 \times \text{RBW}]$ .
5. Detector = peak.
6. Trace mode = max hold.
7. Sweep = auto couple.
8. Allow the trace to stabilize.
9. Measure the maximum width of the emission that is constrained by the frequencies associated with the two outermost amplitude points (upper and lower frequencies) that are attenuated by 6 dB relative to the maximum level measured in the fundamental emission.

#### 6.3.3 Test Setup

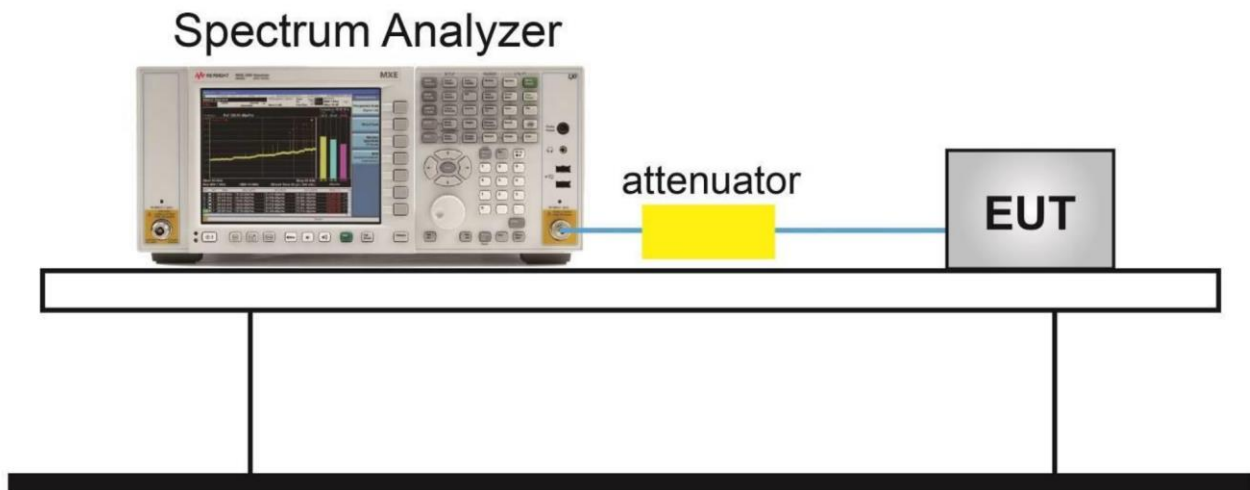

**Measurement Results**

Mode	Test Result (MHz)		
	2412MHz (Ch1)	2437MHz (Ch6)	2462MHz (Ch11)
802.11b	9.23	9.55	9.17
802.11g	16.47	16.47	16.47
802.11n(20MHz)	17.05	17.11	16.99
802.11n(40MHz)	32.69	32.95	32.82

**Conclusion: PASS**



Test graphs as below

Occupied 6dB Bandwidth (MHz) (802.11b, Ch1)

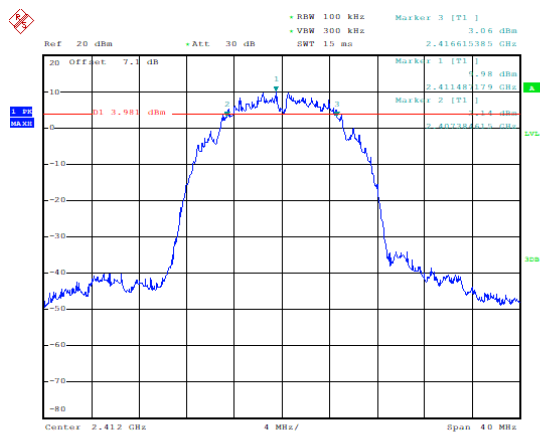

Date: 30.SEP.2021 11:07:14

Occupied 6dB Bandwidth (MHz) (802.11b, Ch6)

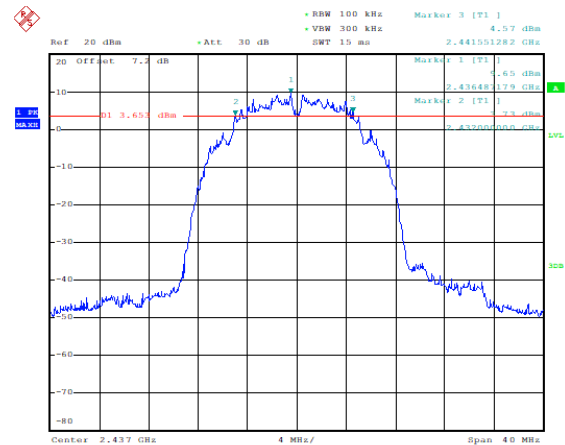

Date: 30.SEP.2021 11:09:26

Occupied 6dB Bandwidth (MHz) (802.11b, Ch11)

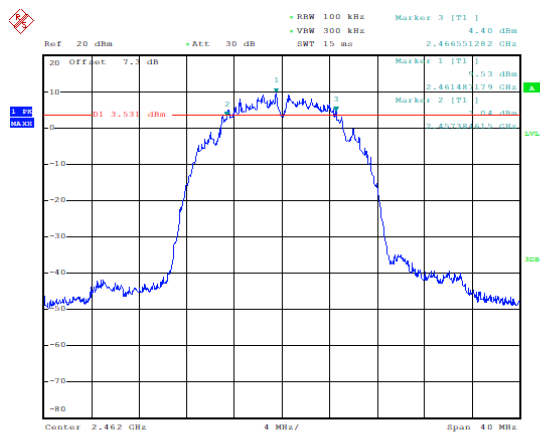

Date: 30.SEP.2021 11:09:49

Occupied 6dB Bandwidth (MHz) (802.11g, Ch1)

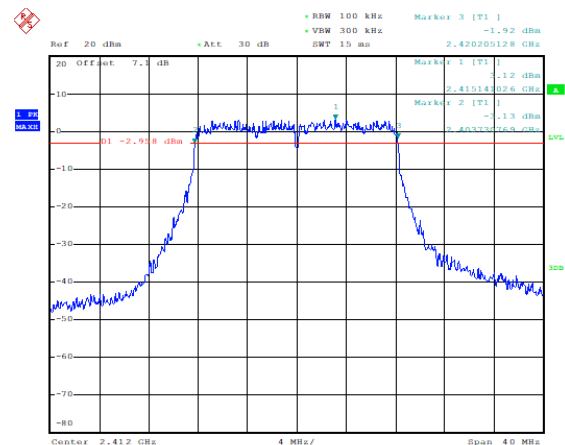

Date: 30.SEP.2021 11:10:20

Occupied 6dB Bandwidth (MHz) (802.11g, Ch6)

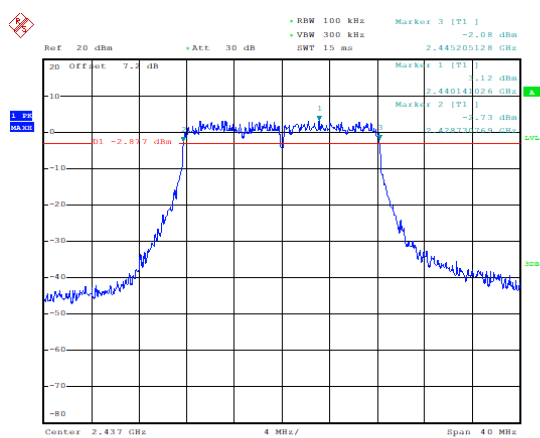

Date: 30.SEP.2021 11:10:47

Occupied 6dB Bandwidth (MHz) (802.11g, Ch11)

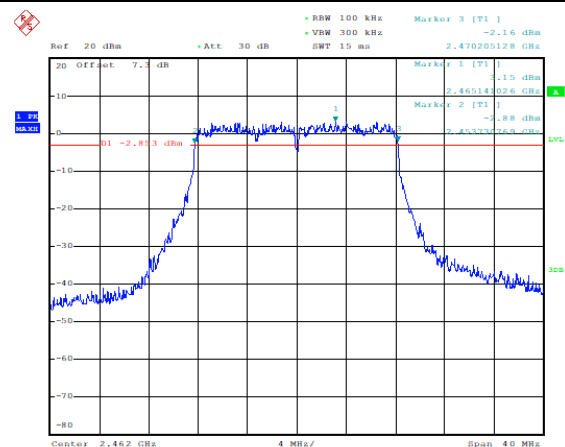

Date: 30.SEP.2021 11:12:15

Occupied 6dB Bandwidth (MHz) (802.11n-20MHz, Ch1)

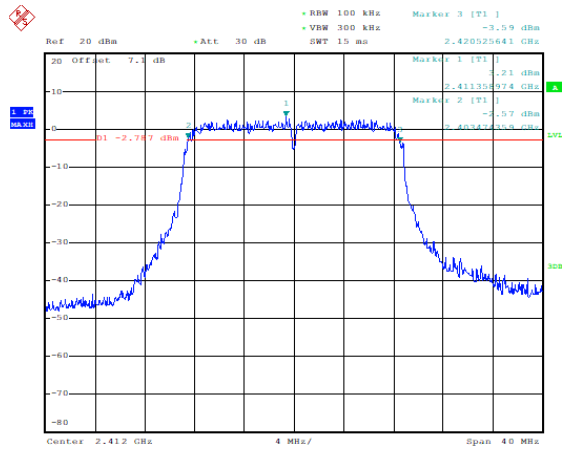

Date: 30.SEP.2021 11:14:21

Occupied 6dB Bandwidth (MHz) (802.11n-20MHz, Ch6)

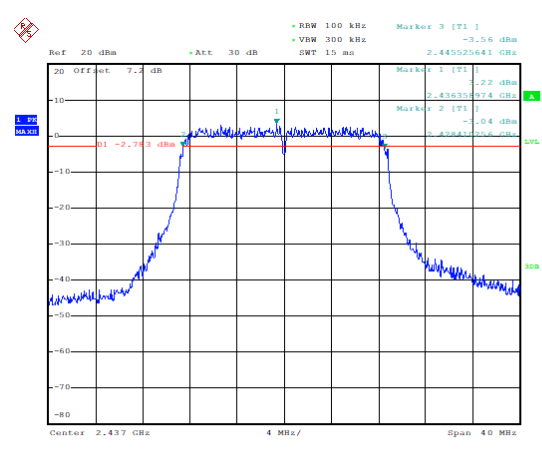

Date: 30.SEP.2021 11:14:49

Occupied 6dB Bandwidth (MHz) (802.11n-20MHz, Ch11)

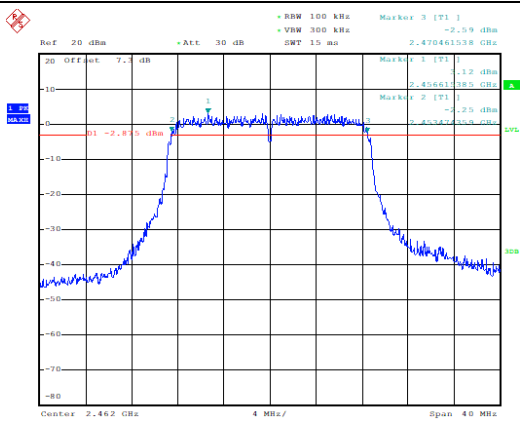

Date: 30.SEP.2021 11:18:11

Occupied 6dB Bandwidth (MHz) (802.11n-40MHz, Ch3)

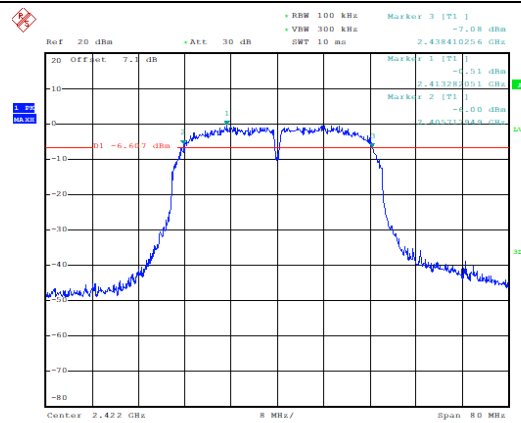

Date: 30.SEP.2021 11:18:36

Occupied 6dB Bandwidth (MHz) (802.11n-40MHz, Ch6)

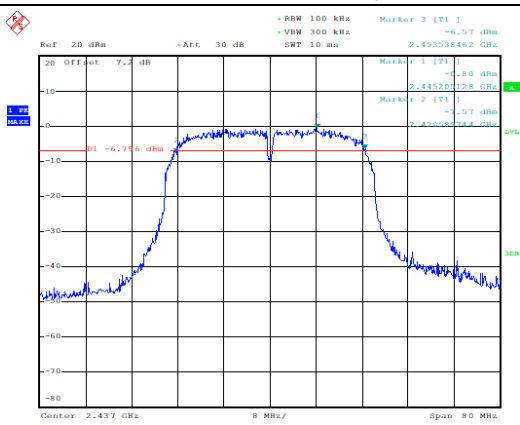

Date: 30.SEP.2021 11:16:54

Occupied 6dB Bandwidth (MHz) (802.11n-40MHz, Ch9)

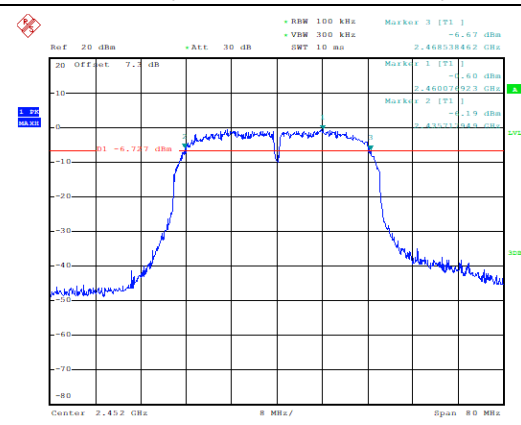

Date: 30.SEP.2021 11:17:51

## 6.4. Band Edges Compliance

### 6.4.1 Measurement Limit

Standard	Limited(dBc)
FCC 47 Part 15.247(d)	>20
RSS-247 5.5	>20

### 6.4.2 Test procedures

The measurement is according to ANSI C63.10 clause 11.13.

1. The output power of EUT was connected to the spectrum analyzer. The path loss was compensated to the results for each measurement.
2. Enable EUT transmitter maximum power continuously.
3. Set instrument center frequency to the frequency of the emission to be measured (must be within 2MHz of the authorized band edge).
4. Set span to 2 MHz.
5. RBW = 100 kHz.
6. VBW  $\geq$  [3  $\times$  RBW].
7. Detector = peak.
8. Sweep time = auto.
9. Trace mode = max hold.
10. Allow sweep to continue until the trace stabilizes

### Measurement results

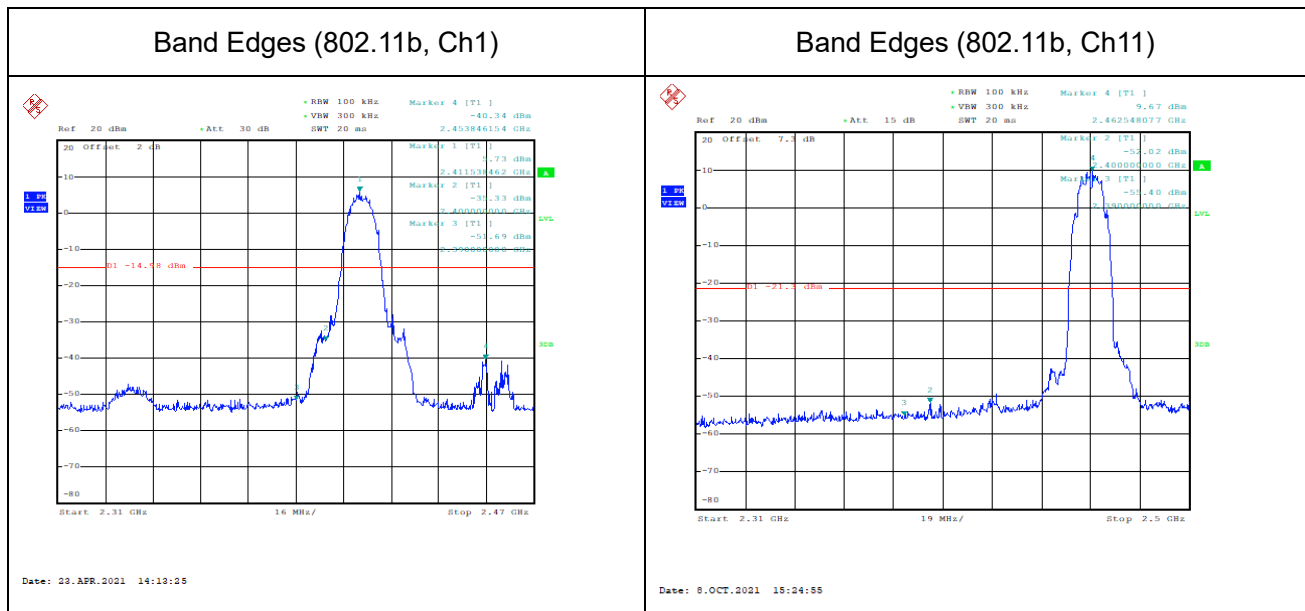

Band Edges (802.11g, Ch1)

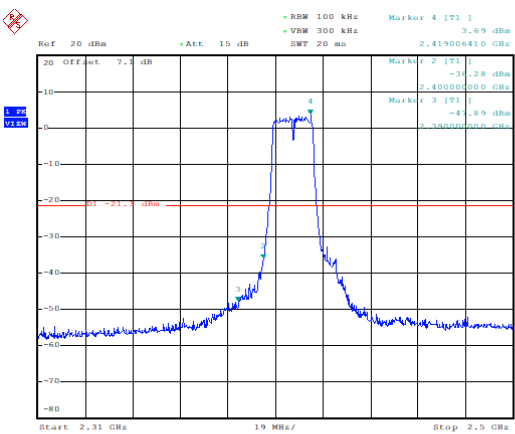

Date: 8.OCT.2021 15:25:38

Band Edges (802.11g, Ch11)

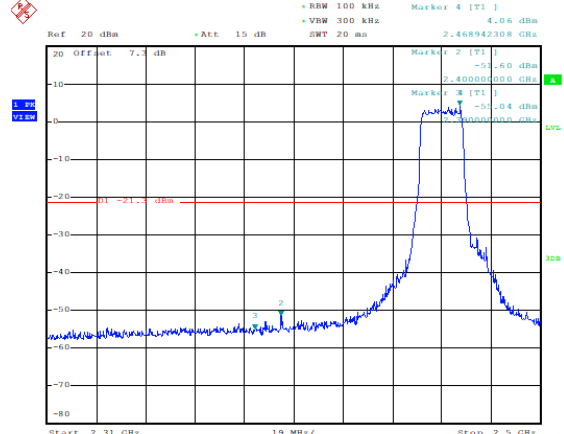

Date: 8.OCT.2021 15:26:20

Band Edges (802.11n-20MHz, Ch1)

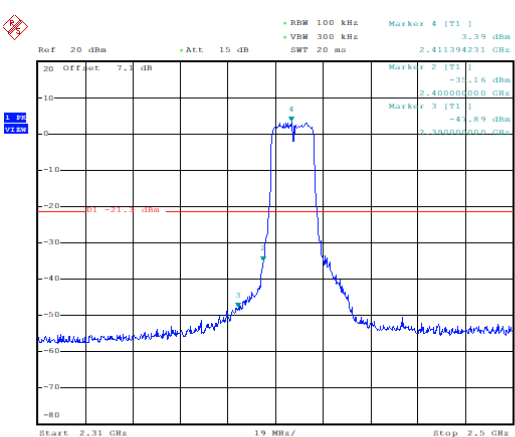

Date: 8.OCT.2021 15:27:05

Band Edges (802.11n-20MHz, Ch11)

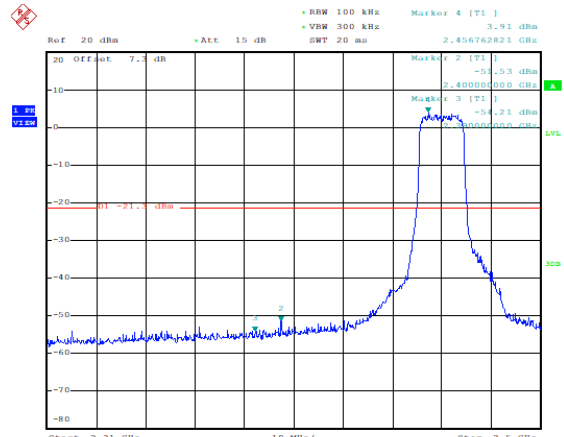

Date: 8.OCT.2021 15:27:48

### Band Edges (802.11n-40MHz, Ch3)

### Band Edges (802.11n-40MHz, Ch9)

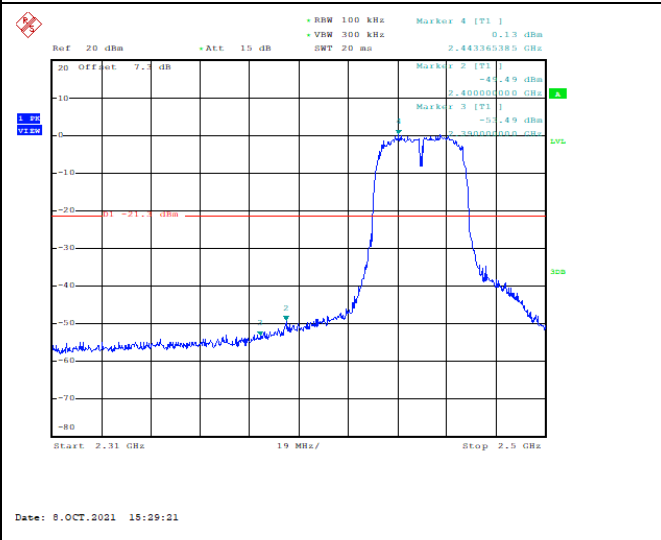
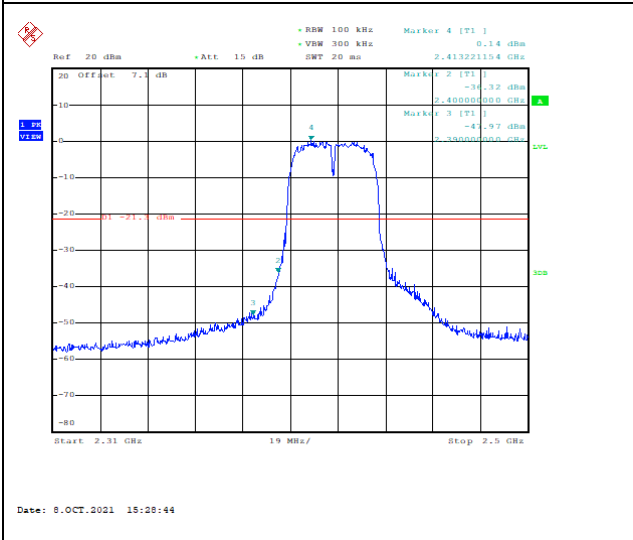

**Conclusion: PASS**

## 6.5. Transmitter Spurious Emission-conducted

### 6.5.1 Measurement Limit

Standard	Limit
FCC 47 Part 15.247(d)	20dB below peak output power in 100KHz
RSS-247 5.5	20dB below peak output power in 100KHz

### 6.5.2 Test procedures

This measurement is according to ANSI C63.10 clause 11.11.

1. The output power of EUT was connected to the spectrum analyzer. The path loss was compensated to the results for each measurement.
2. Enable EUT transmitter maximum power continuously.

Reference level measurement

3. Set instrument center frequency to DTS channel center frequency.
4. Set the span to  $\geq 1.5$  times the DTS bandwidth.
5. Set the RBW = 100 kHz.
6. Set the VBW  $\geq [3 \times \text{RBW}]$ .
7. Detector = peak.
8. Sweep time = auto couple.
9. Trace mode = max hold.
10. Allow trace to fully stabilize.
11. Use the peak marker function to determine the maximum PSD level.

Emission level measurement

12. Set the center frequency and span to encompass frequency range to be measured.
13. Set the RBW = 100 kHz.
14. Set the VBW  $\geq [3 \times \text{RBW}]$ .
15. Detector = peak.
16. Sweep time = auto couple.
17. Trace mode = max hold.
18. Allow trace to fully stabilize.
19. Use the peak marker function to determine the maximum amplitude level.

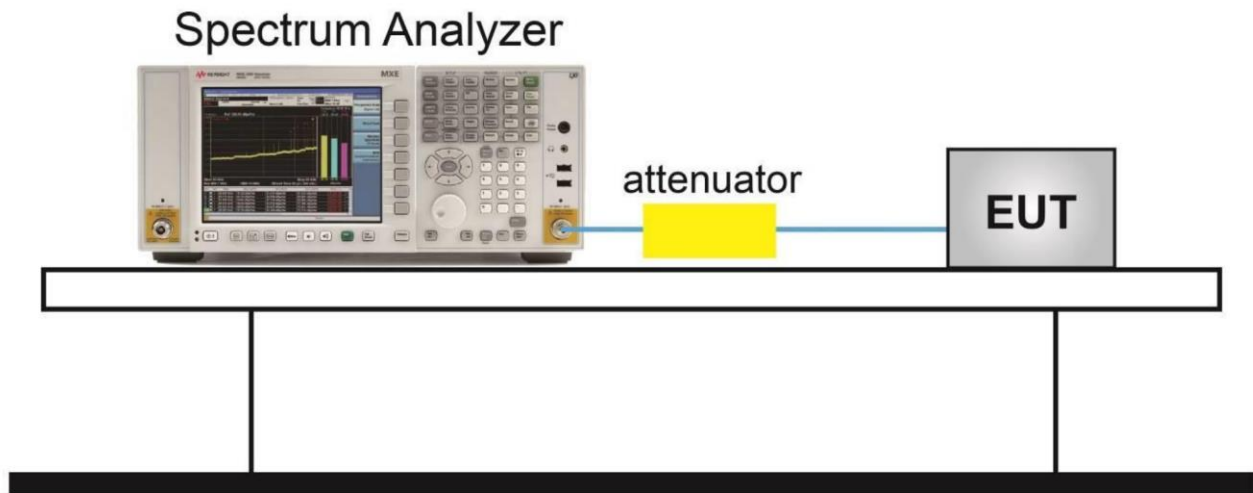

### Measurement Results

<h4 style="text-align: center;">Conducted Spurious Emission (802.11b, Ch1)</h4> <p style="font-size: small;">Date: 8.OCT.2021 15:30:15</p>	<h4 style="text-align: center;">Conducted Spurious Emission (802.11b, Ch1, 30MHz~26GHz)</h4> <p style="font-size: small;">Date: 8.OCT.2021 15:30:51</p>
<h4 style="text-align: center;">Conducted Spurious Emission (802.11b, Ch6)</h4> <p style="font-size: small;">Date: 8.OCT.2021 15:31:27</p>	<h4 style="text-align: center;">Conducted Spurious Emission (802.11b, Ch6, 30MHz~26GHz)</h4> <p style="font-size: small;">Date: 8.OCT.2021 15:32:17</p>



### Conducted Spurious Emission (802.11b, Ch11)

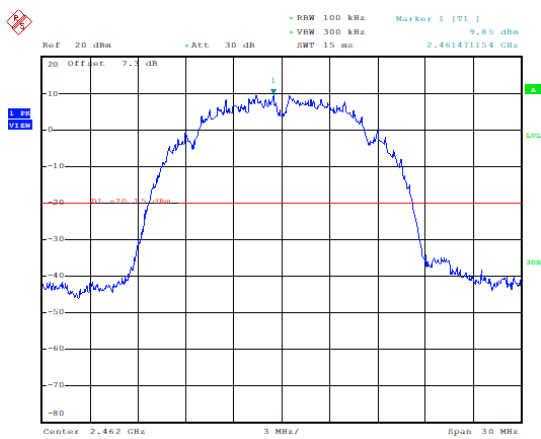

Date: 8.OCT.2021 15:22:50

### Conducted Spurious Emission (802.11b, Ch11, 30MHz~26GHz)

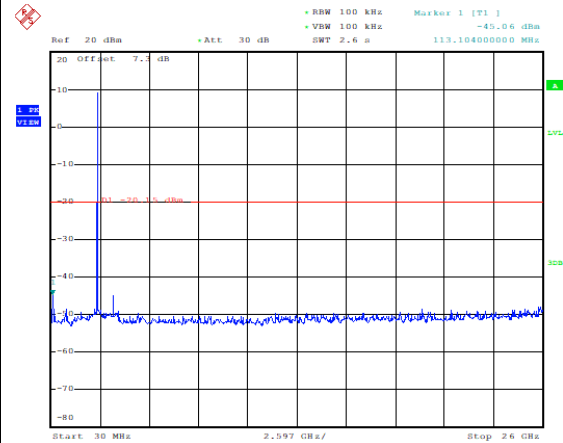

Date: 8.OCT.2021 15:33:27

### Conducted Spurious Emission (802.11g, Ch1)

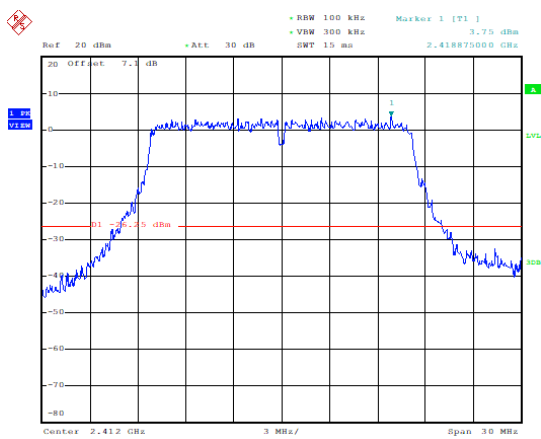

Date: 8.OCT.2021 15:34:11

### Conducted Spurious Emission (802.11g, Ch1, 30MHz~26GHz)

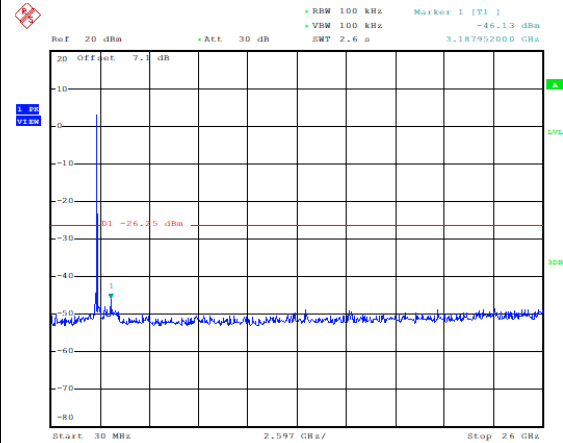

Date: 8.OCT.2021 15:34:47

### Conducted Spurious Emission (802.11g, Ch6)

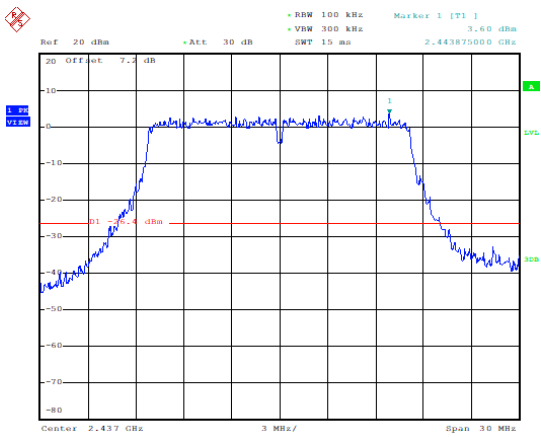

Date: 8.OCT.2021 15:35:17

### Conducted Spurious Emission (802.11g, Ch6, 30MHz~26GHz)

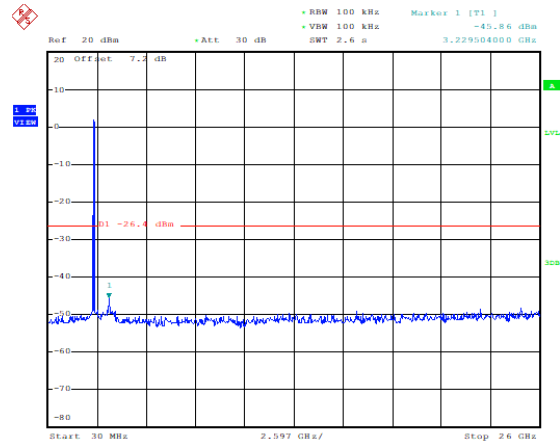

Date: 8.OCT.2021 15:35:58

### Conducted Spurious Emission (802.11g, Ch11)

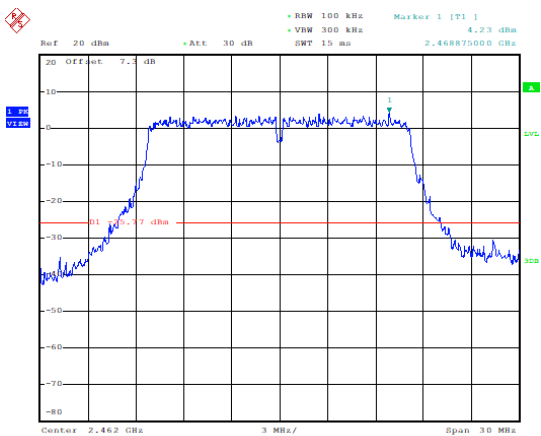

Date: 8.OCT.2021 15:36:26

### Conducted Spurious Emission (802.11g, Ch11, 30MHz~26GHz)

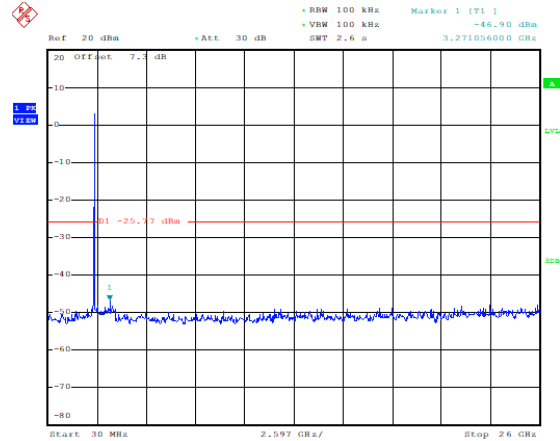

Date: 8.OCT.2021 15:37:02

### Conducted Spurious Emission (802.11n-20MHz, Ch1)

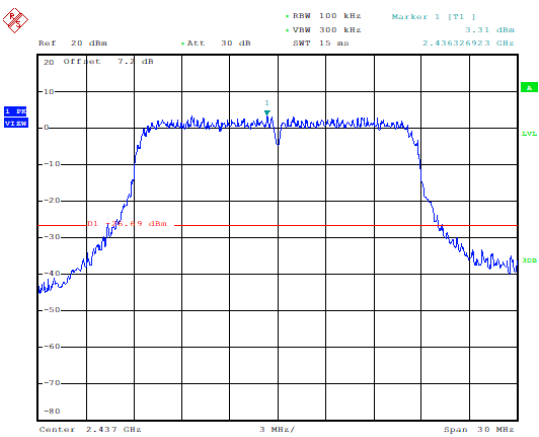

Date: 8.OCT.2021 15:28:57

### Conducted Spurious Emission (802.11n-20MHz, Ch1, 30MHz~26GHz)

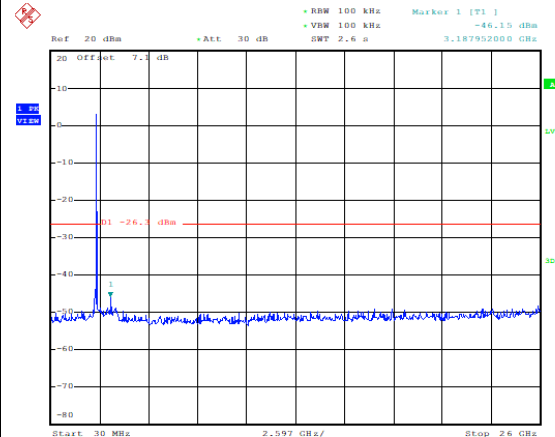

Date: 8.OCT.2021 15:28:27

### Conducted Spurious Emission (802.11n-20MHz, Ch6)

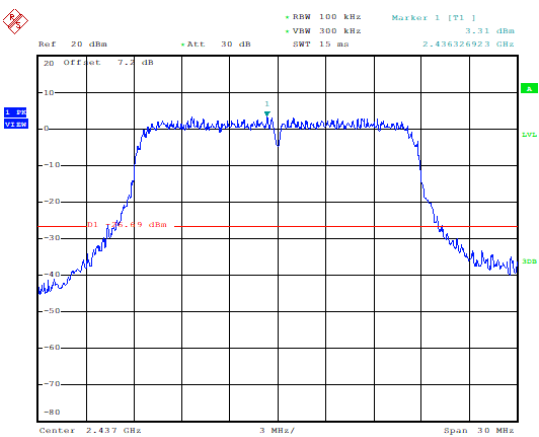

Date: 8.OCT.2021 15:28:57

### Conducted Spurious Emission (802.11n-20MHz, Ch6, 30MHz~26GHz)

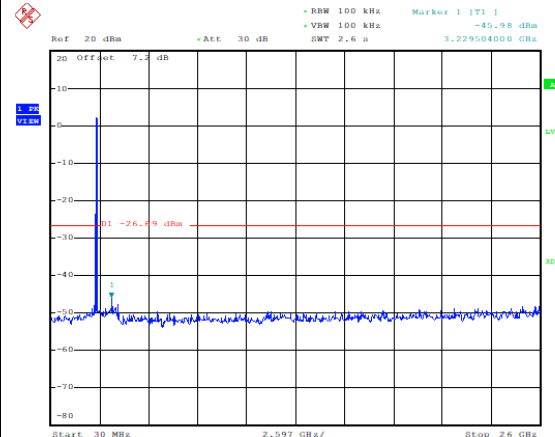

Date: 8.OCT.2021 15:29:28

### Conducted Spurious Emission (802.11n-20MHz, Ch11)

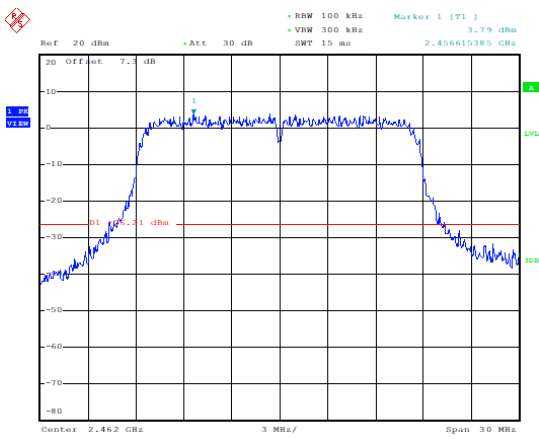

Date: 8.OCT.2021 15:41:01

### Conducted Spurious Emission (802.11n-20MHz, Ch11, 30MHz~26GHz)

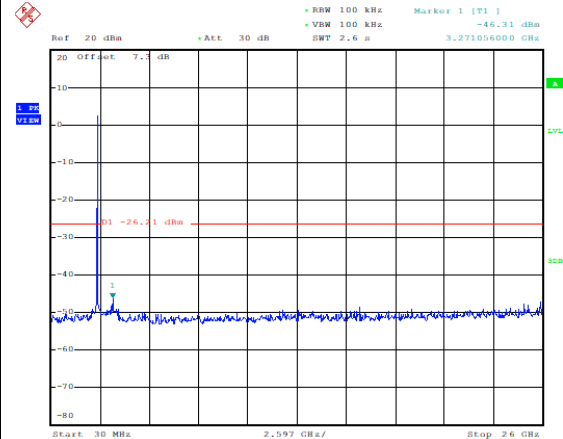

Date: 8.OCT.2021 15:41:28

### Conducted Spurious Emission (802.11n-40MHz, Ch3)

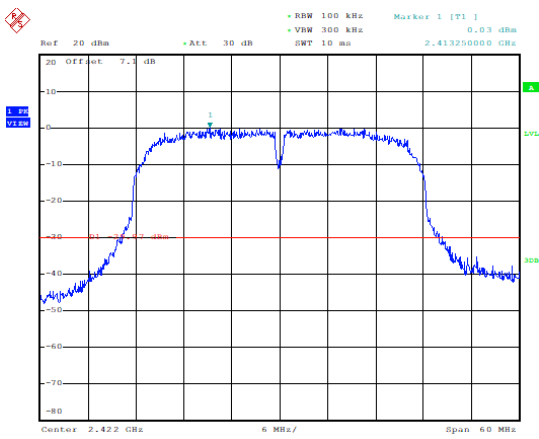

Date: 8.OCT.2021 15:42:12

### Conducted Spurious Emission (802.11n-40MHz, Ch3, 30MHz~26GHz)

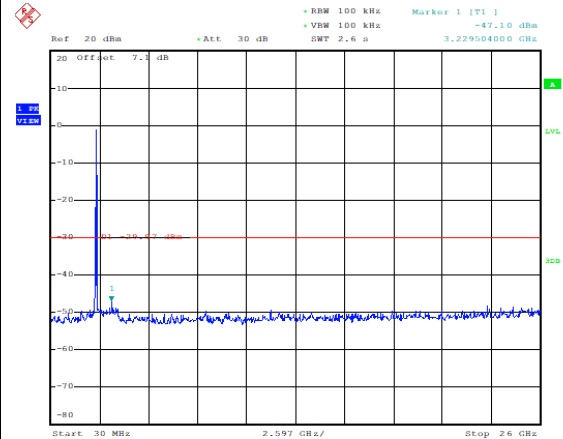

Date: 8.OCT.2021 15:42:48

Conducted Spurious Emission  
(802.11n-40MHz, Ch6)

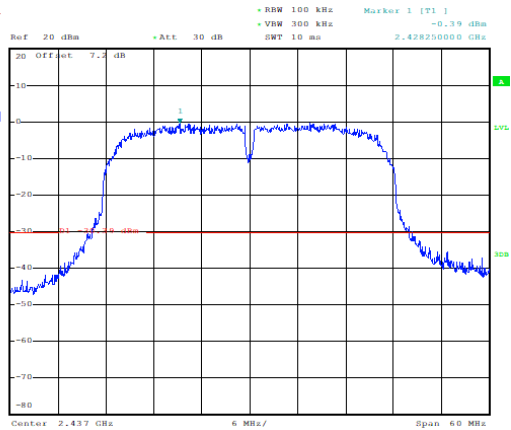

Date: 8.OCT.2021 15:49:13

Conducted Spurious Emission  
(802.11n-40MHz, Ch6, 30MHz~26GHz)

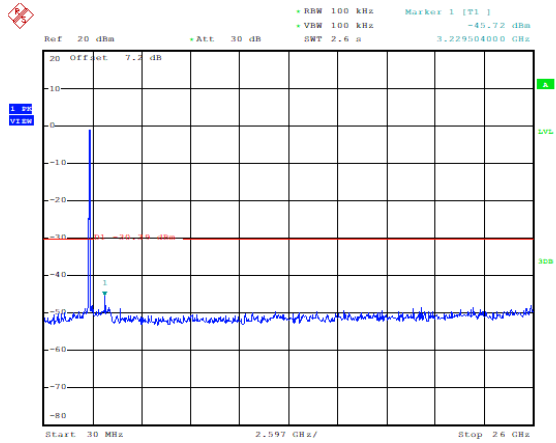

Date: 8.OCT.2021 15:48:54

Conducted Spurious Emission  
(802.11n-40MHz, Ch9)

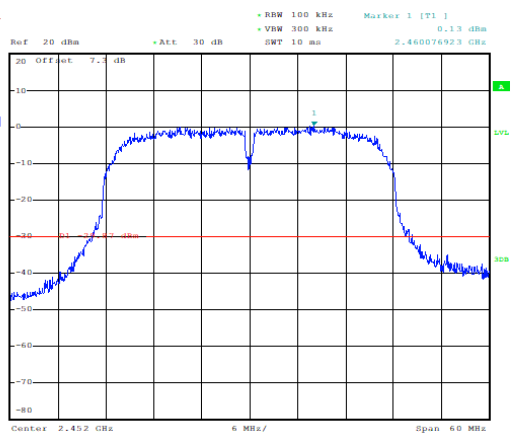

Date: 8.OCT.2021 15:44:36

Conducted Spurious Emission  
(802.11n-40MHz, Ch9, 30MHz~26GHz)

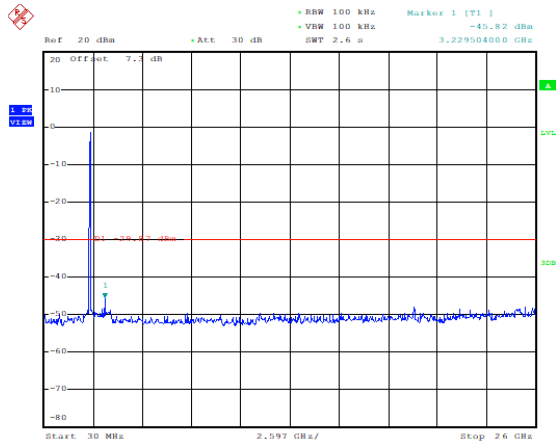

Date: 8.OCT.2021 15:45:02

## 6.6. Transmitter Spurious Emission-Radiated

### 6.6.1 Measurement Limit

Standard	Limit
FCC 47 Part 15.247,15.205,15.209	20dB below peak output power
RSS-Gen 8.9,8.10	20dB below peak output power

In addition, radiated emissions which fall in the restricted bands, as defined in 25.205(a), must also comply with the radiated emission limits specified in 15.209(a)(see 15.205(c)).

The measurement is according to ANSI C63.10 clause 11.11 and 11.12.

### 6.6.2 Limit in restricted band

Frequency of emission (MHz)	Field strength(uV/m)	Field strength(dBuV/m)
30~88	100	40
88~216	150	43.5
216~960	200	46
Above 960	500	54

### 6.6.3 Test procedures

Portable, small, lightweight, or modular devices that may be handheld, worn on the body, or placed on a table during operation shall be positioned on a nonconducting platform, the top of which is 80 cm above the reference ground plane. The preferred area occupied by the EUT arrangement is 1 m by 1.5 m, but it may be larger or smaller to accommodate various sized EUTs. For testing purposes, ceiling- and wall-mounted devices also shall be positioned on a tabletop (see also ANSI C63.4-2013 section 6.3.4 and 6.3.5). In making any tests involving handheld, body-worn, or ceiling-mounted equipment, it is essential to recognize that the measured levels may be dependent on the orientation (attitude) of the three orthogonal axes of the EUT. Thus, exploratory tests as specified in 8.3.1 shall be carried out for various axes orientations to determine the attitude having maximum or near-maximum emission level.

The EUT was placed on a non-conductive table. The measurement antenna was placed at a distance of 3 meters from the EUT. During testing, the antenna height and the EUT azimuth were varied in order to identify the maximum level of emission from the EUT. This maximization process was repeated with the EUT positioned in each of its three orthogonal orientations.

### 6.6.4. Test Setup

#### Below 1GHz Test Setup

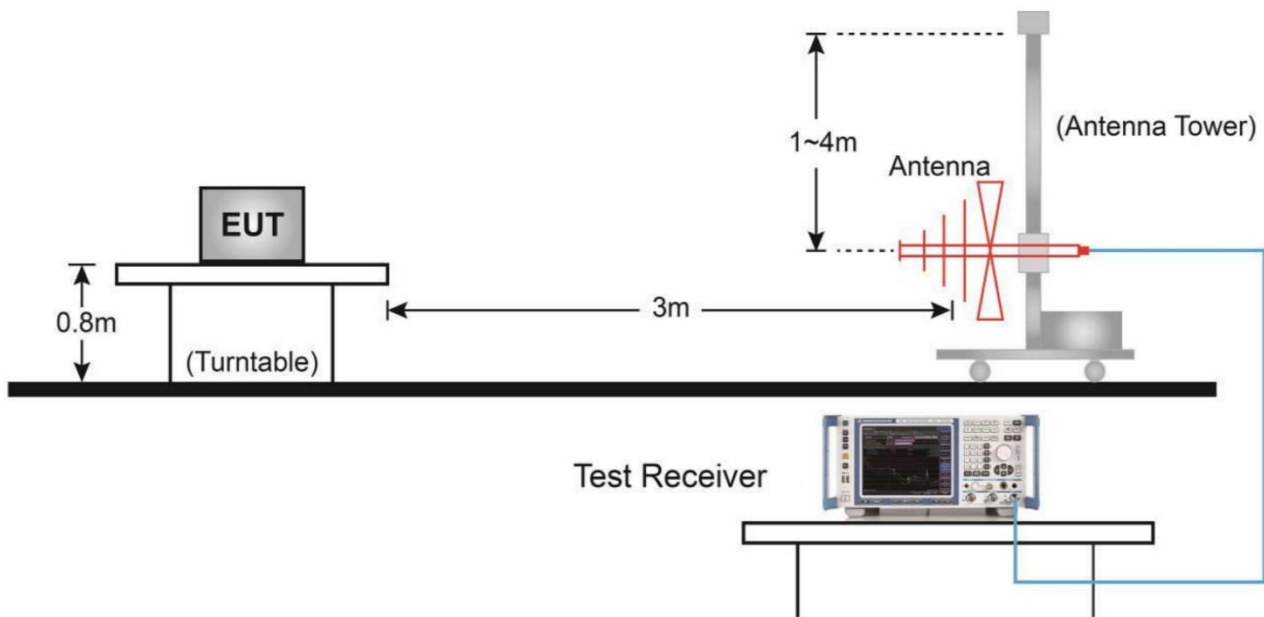

#### Above 1GHz Test Setup

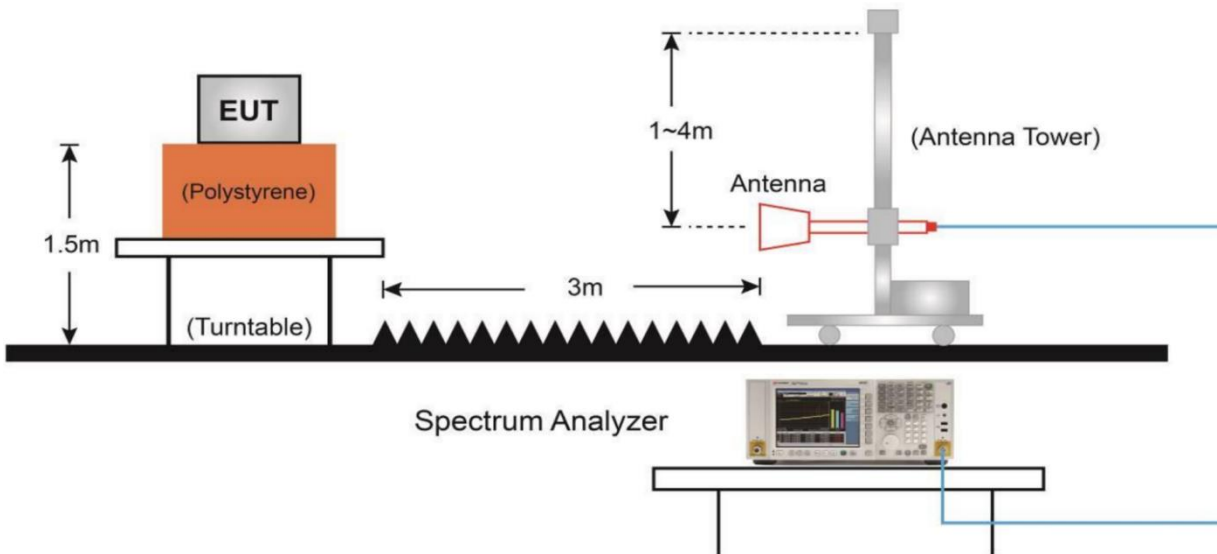

Frequency of emission (MHz)	RBW/VBW	Sweep Times (s)
30~1000	100KHz/300KHz	5
1000~4000	1MHz/3MHz	15
4000~18000	1MHz/3MHz	40
18000~26500	1MHz/3MHz	20





# Measurement Results

## Mainly Supply

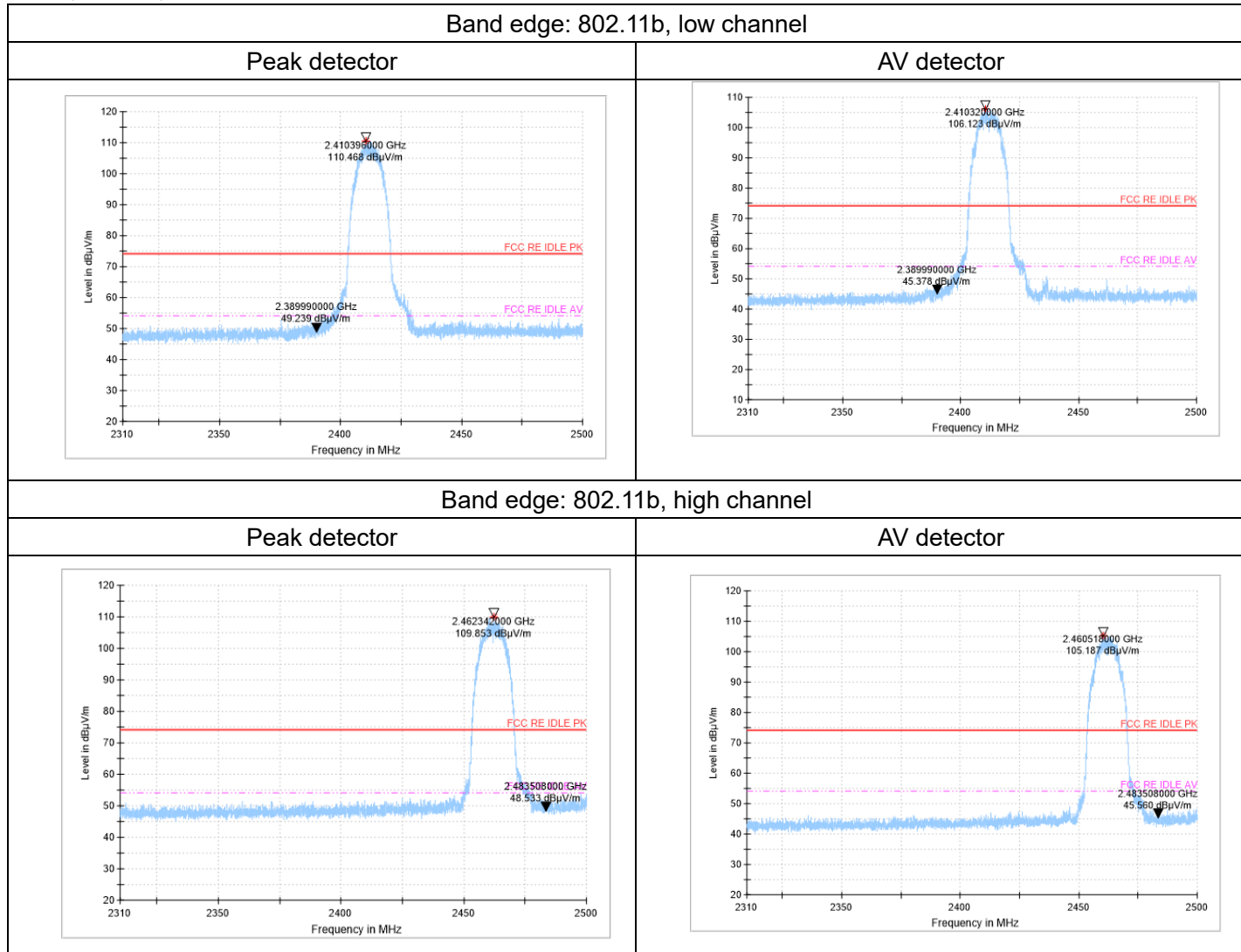

Radiated Spurious Emission  
(802.11b, Ch11,30MHz~1GHz)

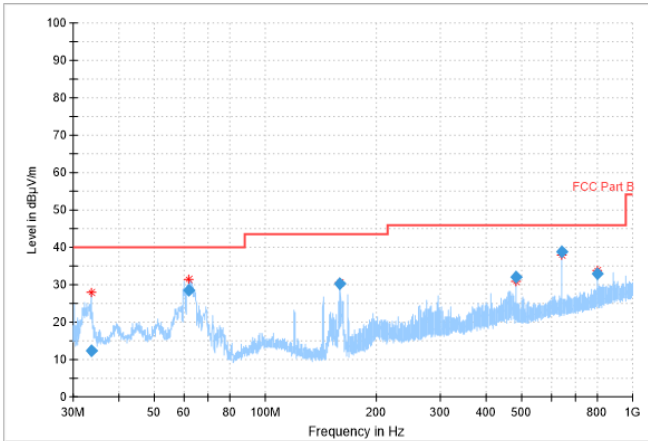

Radiated Spurious Emission  
(802.11b, Ch11,1GHz~3GHz)

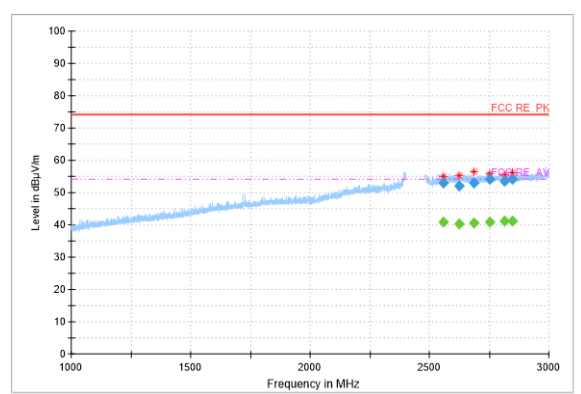

Radiated Spurious Emission  
(802.11b, Ch11,3GHz~18GHz)

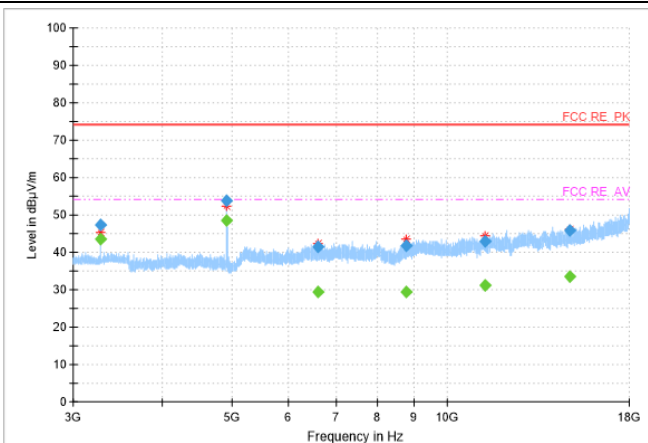

/

/

Band edge: 802.11g, low channel

Peak detector

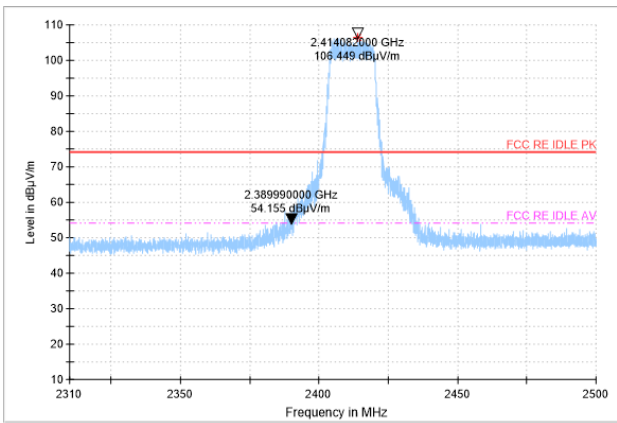

AV detector

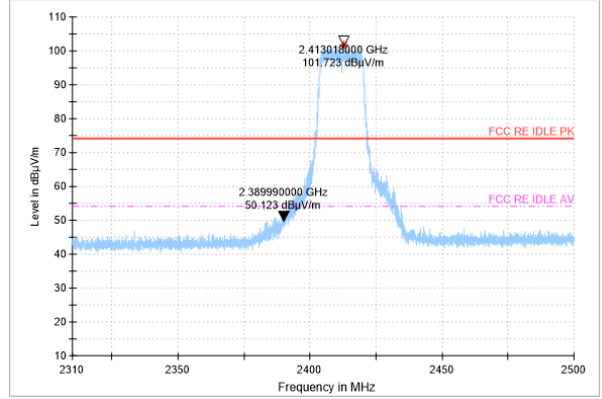

Band edge: 802.11g, high channel

Peak detector

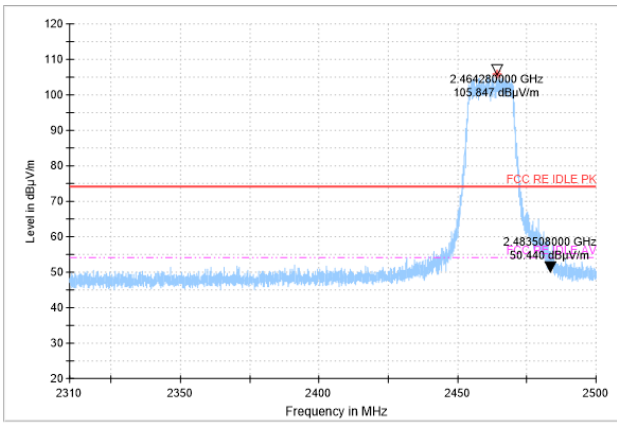

AV detector

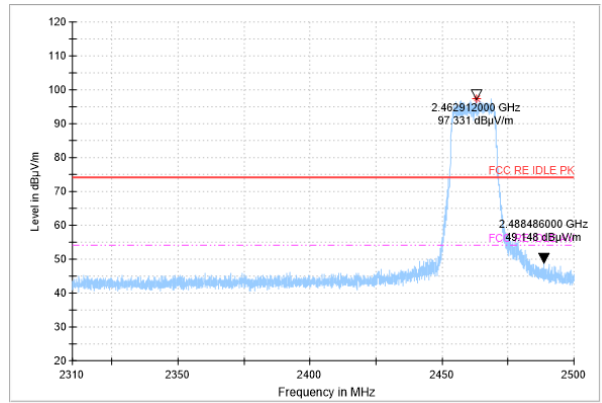

Radiated Spurious Emission  
(802.11g, Ch11, 30MHz~1GHz)

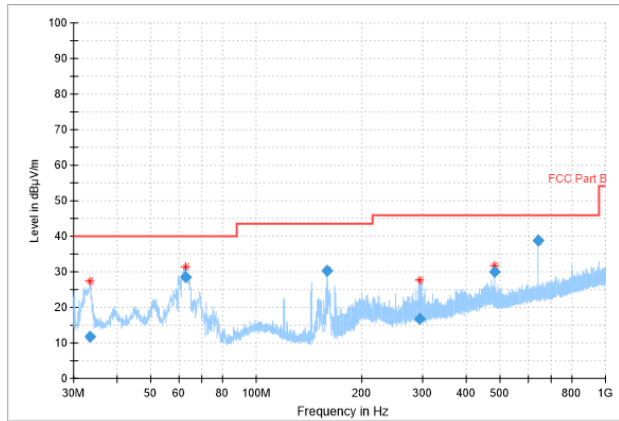

Radiated Spurious Emission  
(802.11g, Ch11, 1GHz~3GHz)

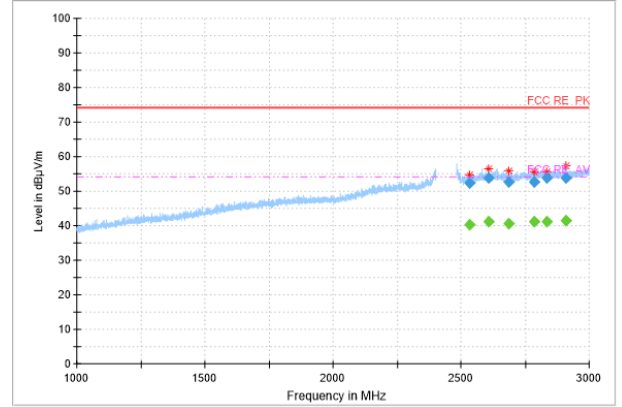

Radiated Spurious Emission  
(802.11g, Ch11, 3GHz~18GHz)

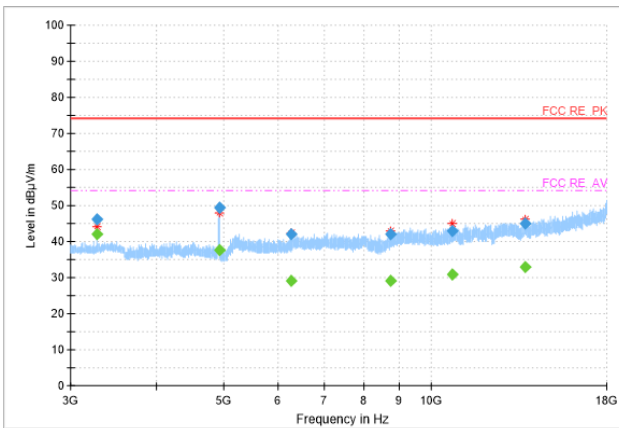

/

/

Band edge: 802.11n-20MHz, low channel

Peak detector

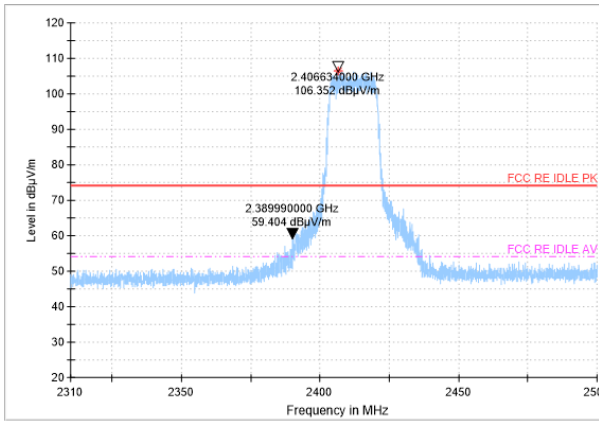

AV detector

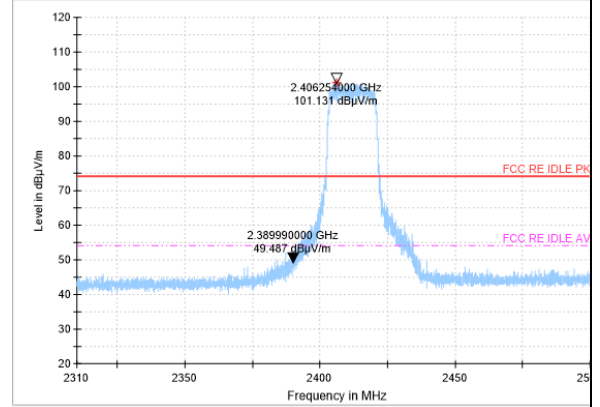

Band edge: 802.11n-20MHz, high channel

Peak detector

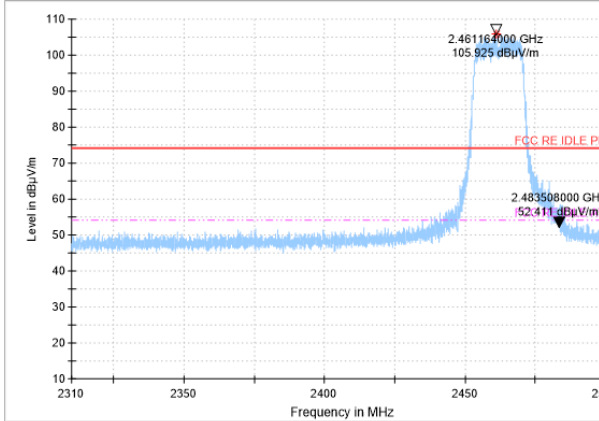

AV detector

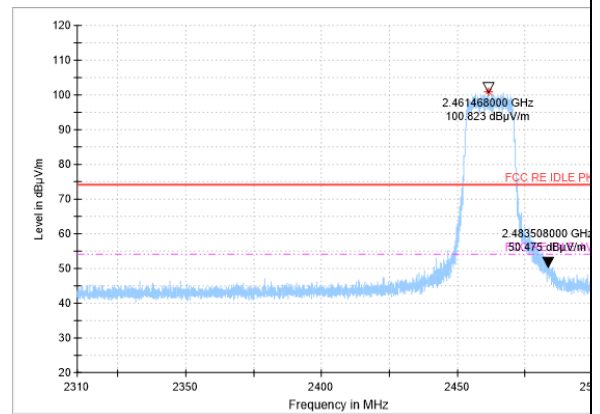

Radiated Spurious Emission  
(802.11n-20MHz, Ch11,30MHz~1GHz)

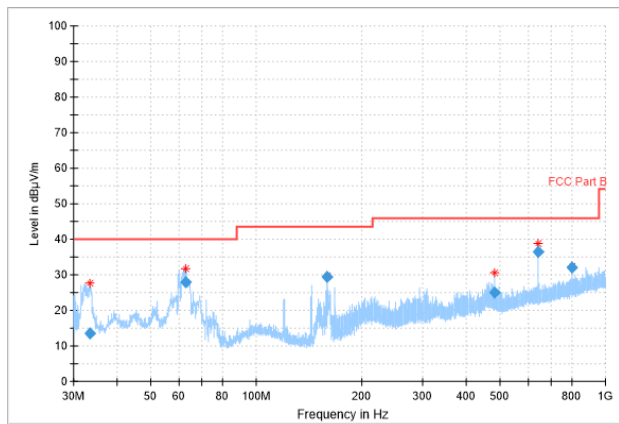

Radiated Spurious Emission  
(802.11n-20MHz, Ch11,1GHz~3GHz)

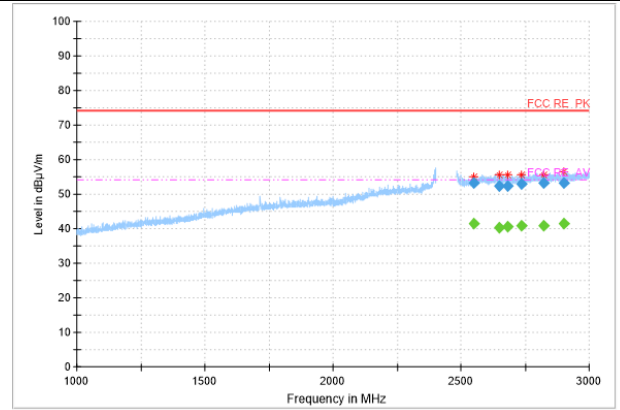

Radiated Spurious Emission  
(802.11n-20MHz, Ch11, 3GHz~18GHz)

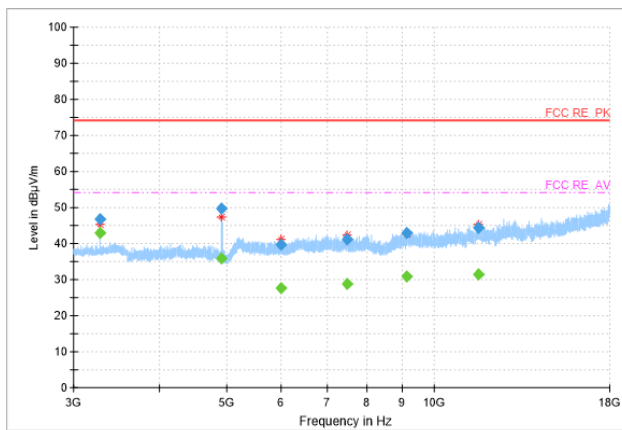

/

/

Band edge: 802.11n-40MHz, low channel

Peak detector

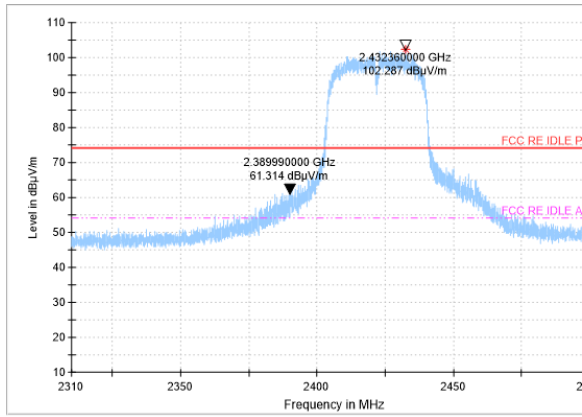

AV detector

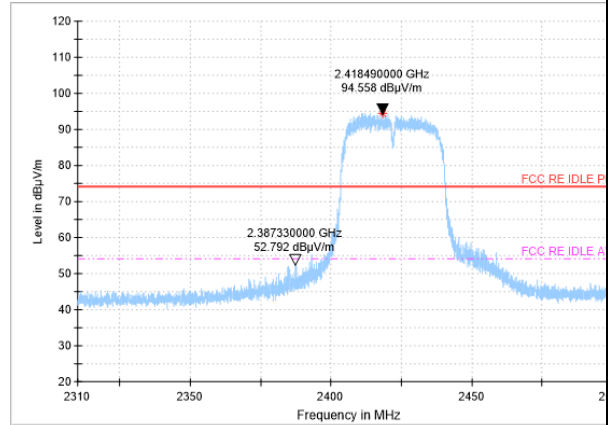

Band edge: 802.11n-40MHz, high channel

Peak detector

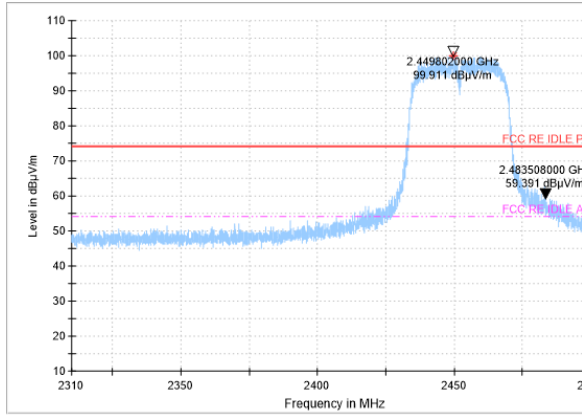

AV detector

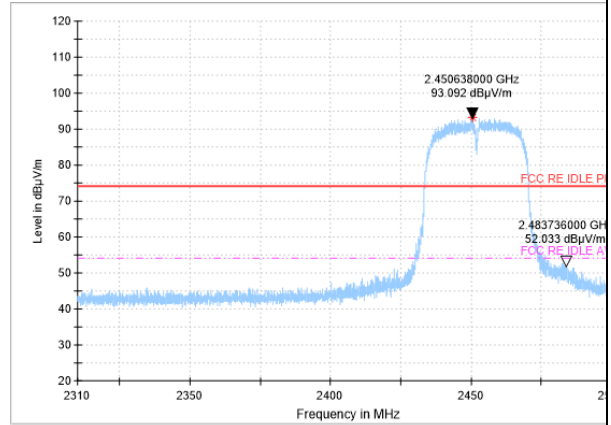

<p style="text-align: center;"><b>Radiated Spurious Emission</b> (802.11n-40MHz, Ch9,30MHz~1GHz)</p>	<p style="text-align: center;"><b>Radiated Spurious Emission</b> (802.11n-40MHz, Ch9,1GHz~3GHz)</p>
<p style="text-align: center;"><b>Radiated Spurious Emission</b> (802.11n-40MHz, Ch9, 3GHz~18GHz)</p>	<p style="text-align: center;">/</p>
	<p style="text-align: center;">/</p>

**Note:**

A "reference path loss" is established and  $A_{Rpi}$  is the attenuation of "reference path loss", and including the gain of receive antenna, the gain of the preamplifier, the cable loss.

$P_{Mea}$  is the field strength recorded from the instrument.

The measurement results are obtained as described below:

$$AR_{pi} = \text{Cable loss} + \text{Antenna Gain} - \text{Preamplifier gain}$$

$$\text{Result} = P_{Mea} + \text{Cable loss} + \text{Antenna Gain} - \text{Preamplifier gain} = P_{Mea} + AR_{pi}$$





Mainly Supply  
802.11b mode  
Ch11 30MHz~1GHz

Frequency(MHz)	Result(dBuV/m)	ARpl (dB)	PMea(dBuV/m)	Polarity
33.6	12.36	-14.1	26.46	V
61.9	28.5	-13	41.5	V
160.0	30.19	-16	46.19	H
480.0	32.14	-6.7	38.84	H
640.0	38.89	-3.5	42.39	H
800.0	32.8	-1.5	34.3	H

Ch11 1GHz~3GHz

Frequency(MHz)	Result(dBuV/m)	ARpl (dB)	PMea(dBuV/m)	Polarity
2558.4	52.97	15.2	37.77	H
2623.0	52.12	15.7	36.42	H
2687.7	52.99	15.9	37.09	V
2752.3	54.16	16.2	37.96	H
2815.1	53.56	16.6	36.96	H
2845.5	54.02	16.6	37.42	V

Ch11 1GHz~3GHz (Average)

Frequency(MHz)	Result(dBuV/m)	ARpl (dB)	PMea(dBuV/m)	Polarity
2752.3	40.78	16.2	24.58	H
2845.5	41.23	16.6	24.63	V

Ch11 3GHz~18GHz

Frequency(MHz)	Result(dBuV/m)	ARpl (dB)	PMea(dBuV/m)	Polarity
3282.7	47.24	-7.3	54.54	H
4923.9	53.69	-4.5	58.19	H
6612.0	41.35	-2.5	43.85	H
8783.7	41.7	-1.5	43.2	H
11303.0	43.06	1.6	41.46	H
14874.3	45.75	5.8	39.95	V



802.11g mode

Ch11 30MHz~1GHz

Frequency(MHz)	Result(dBuV/m)	ARpl (dB)	PMea(dBuV/m)	Polarity
33.5	11.83	-14.2	26.03	V
62.6	28.43	-13.2	41.63	V
160.0	30.44	-16	46.44	H
293.5	16.7	-11	27.7	H
480.0	30.05	-6.7	36.75	H
640.0	38.87	-3.5	42.37	H

Ch11 1GHz~3GHz

Frequency(MHz)	Result(dBuV/m)	ARpl (dB)	PMea(dBuV/m)	Polarity
2534.2	52.33	14.8	37.53	H
2608.3	53.69	15.6	38.09	H
2687.3	52.56	15.9	36.66	H
2785.6	52.69	16.5	36.19	V
2835.5	53.96	16.6	37.36	H
2908.8	53.71	16.7	37.01	V

Ch11 3GHz~18GHz

Frequency(MHz)	Result(dBuV/m)	ARpl (dB)	PMea(dBuV/m)	Polarity
3282.7	46.25	-7.3	53.55	H
4926.0	49.43	-4.5	53.93	H
6271.5	41.95	-2.6	44.55	H
8745.3	41.98	-1.7	43.68	V
10725.3	42.85	0.9	41.95	H
13712.6	44.86	4.1	40.76	H

802.11n-20MHz

Ch11 30MHz~1GHz

Frequency(MHz)	Result(dBuV/m)	ARpl (dB)	PMea(dBuV/m)	Polarity
33.4	13.59	-14.2	27.79	V
62.6	28	-13.2	41.2	V
160.0	29.29	-16	45.29	H
480.0	25.04	-6.7	31.74	H
640.0	36.53	-3.5	40.03	H
800.0	32.18	-1.5	33.68	H

**Ch11 1GHz~3GHz**

Frequency(MHz)	Result(dBuV/m)	ARpl (dB)	PMea(dBuV/m)	Polarity
2549.8	53.31	15.1	38.21	H
2646.8	52.47	15.9	36.57	V
2680.4	52.28	15.9	36.38	V
2734.6	53.08	16.1	36.98	H
2823.0	53.36	16.6	36.76	V
2899.9	53.26	16.7	36.56	V

**Ch11 3GHz~18GHz**

Frequency(MHz)	Result(dBuV/m)	ARpl (dB)	PMea(dBuV/m)	Polarity
3282.7	46.64	-7.3	53.94	H
4920.2	49.66	-4.5	54.16	H
5995.8	39.84	-4	43.84	H
7473.3	41.24	-2.3	43.54	H
9120.2	42.83	-0.4	43.23	V
11587.4	44.29	2.2	42.09	V

**802.11n-40MHz**
**Ch9 30MHz~1GHz**

Frequency(MHz)	Result(dBuV/m)	ARpl (dB)	PMea(dBuV/m)	Polarity
32.4	21.59	-14.2	35.79	V
63.3	27.99	-13.5	41.49	V
150.1	20.68	-17.1	37.78	H
279.6	20.8	-10.9	31.7	V
450.9	36.65	-7.3	43.95	H
640.0	33.52	-3.5	37.02	H

**Ch9 1GHz~3GHz**

Frequency(MHz)	Result(dBuV/m)	ARpl (dB)	PMea(dBuV/m)	Polarity
1258.7	40.62	3.3	37.32	H
1711.6	44.74	7.8	36.94	V
1910.3	46.99	9.2	37.79	V
2126.0	48.52	11.5	37.02	V
2614.4	53.43	15.6	37.83	V
2779.7	52.9	16.4	36.5	V



**Ch9 3GHz~18GHz**

Frequency(MHz)	Result(dBuV/m)	ARpl (dB)	PMea(dBuV/m)	Polarity
3269.4	46.69	-7.3	53.99	V
4904.0	54.67	-4.6	59.27	H
6372.5	41.64	-2.5	44.14	V
8026.0	42.4	-1.2	43.6	H
10233.6	43.39	0.1	43.29	H
12583.0	44.79	2.7	42.09	V

**Ch9 3GHz~18GHz (Average)**

Frequency(MHz)	Result(dBuV/m)	ARpl (dB)	PMea(dBuV/m)	Polarity
4904.0	43.24	-4.6	47.84	H

**Note: Only the worst case is written in the report.**

## 7. Test Equipment List

### 7.1. Conducted Test System

Item	Equipment Name	Type	Serial Number	Manufacturer	Cal. Date	Cal. interval
1	Vector Signal Analyzer	FSQ26	101091	R&S	2020-05-11	1 year
					2021-05-10	
2	DC Power Supply	ZUP60-14	LOC-220Z006-0007	TDL-Lambda	2020-05-11	1 year
					2021-05-10	
3	Eagle Test Software	Eagle V3.1 FCC BT/WIFI	N/A	ECIT	N/A	N/A

### 7.2. Radiated Emission Test System

Item	Equipment Name	Type	Serial Number	Manufacturer	Cal. Date	Cal. interval
1	Universal Radio Communication Tester	CMU200	123123	R&S	2020-05-11	1 year
					2021-05-10	
2	EMI Test Receiver	ESU40	100307	R&S	2021-03-03	1 year
3	TRILOG Broadband Antenna	VULB9163	VULB9163-515	Schwarzbeck	2021-02-03	2 years
4	Double-ridged Waveguide Antenna	ETS-3117	00135890	ETS	2020-02-28	3 years
5	Universal Radio Communication Tester	CMW500	104178	R&S	2020-05-11	1 year
					2021-05-10	
6	EMI Test Software	EMC32 V 9.15.00	N/A	R&S	N/A	N/A

Anechoic chamber

Fully anechoic chamber by ETS.

## Annex A: Measurement Uncertainty

Measurement uncertainty for all the testing in this report are within the limit specified in 3IN documents . The detailed measurement uncertainty is defined in 3IN documents.

Measurement Items	Range	Confidence Level	Calculated Uncertainty
Peak Output Power-Conducted	2412MHz-2462MHz	95%	0.544dB
Peak Power Spectral Density	2412MHz-2462MHz	95%	0.502dB
Occupied 6dB Bandwidth	2412MHz-2462MHz	95%	69.26kHz
Band Edges-Conducted	2412MHz-2462MHz	95%	0.544dB
Conducted Emission	30MHz-2GHz	95%	0.90dB
Conducted Emission	2GHz-3.6GHz	95%	0.88dB
Conducted Emission	3.6GHz-8GHz	95%	0.96dB
Conducted Emission	8GHz-20GHz	95%	0.94dB
Conducted Emission	20GHz-22GHz	95%	0.88dB
Conducted Emission	22GHz-26GHz	95%	0.86dB
Transmitter Spurious Emission-Radiated	9KHz-30MHz	95%	5.66dB
Transmitter Spurious Emission-Radiated	30MHz-1000MHz	95%	4.98dB
Transmitter Spurious Emission-Radiated	1000MHz -18000MHz	95%	5.06dB
Transmitter Spurious Emission-Radiated	18000MHz -40000MHz	95%	5.20dB
AC Power line Conducted Emission	0.15MHz-30MHz	95%	3.66 dB

## Annex B: Accreditation Certificate



### Accredited Laboratory

A2LA has accredited

## INDUSTRIAL INTERNET INNOVATION CENTER (SHANGHAI) CO., LTD.

Shanghai, People's Republic of China

for technical competence in the field of

### Electrical Testing

This laboratory is accredited in accordance with the recognized International Standard ISO/IEC 17025:2017 General requirements for the competence of testing and calibration laboratories. This accreditation demonstrates technical competence for a defined scope and the operation of a laboratory quality management system (refer to joint ISO-ILAC-IAF Communiqué dated April 2017).



Presented this 12<sup>th</sup> day of April 2021.

Vice President, Accreditation Services  
For the Accreditation Council  
Certificate Number 3682.01  
Valid to February 28, 2023

For the tests to which this accreditation applies, please refer to the laboratory's Electrical Scope of Accreditation.

\*\*\*\*\*END OF REPORT\*\*\*\*\*