



RF TEST REPORT

Applicant Espressif Systems (Shanghai) Co.,Ltd.
FCC ID 2AC7Z-ESPS2MINI1
Product Wi-Fi Internet of Things Module
Brand ESPRESSIF
Model ESP32-S2-MINI-1, ESP32-S2-MINI-1U
Report No. R2009A0623-R1V2
Issue Date November 20, 2020

TA Technology (Shanghai) Co., Ltd. tested the above equipment in accordance with the requirements in **FCC CFR47 Part 15C (2019)**. The test results show that the equipment tested is capable of demonstrating compliance with the requirements as documented in this report.

Prepared by: Peng Tao

Approved by: Kai Xu

TA Technology (Shanghai) Co., Ltd.

No.145, Jintang Rd, Tangzhen Industry Park, Pudong Shanghai, China

TEL: +86-021-50791141/2/3

FAX: +86-021-50791141/2/3-8000



TABLE OF CONTENT

1. Test Laboratory	5
1.1. Notes of the test report.....	5
1.2. Test facility	5
1.3. Testing Location.....	5
2. General Description of Equipment under Test.....	6
2.1. Applicant and Manufacturer Information.....	6
2.2. General information.....	6
3. Applied Standards	7
4. Test Configuration	8
5. Test Case Results	10
5.1. Maximum output power	10
5.2. 99% Bandwidth and 6dB Bandwidth	12
5.3. Band Edge	18
5.4. Power Spectral Density	20
5.5. Spurious RF Conducted Emissions.....	25
5.6. Unwanted Emission	29
5.7. Conducted Emission	88
6. Main Test Instruments.....	91
ANNEX A: The EUT Appearance	92
ANNEX B: Test Setup Photos	92



Version	Revision description	Issue Date
Rev.0	/	October 29, 2020
Rev.1	Add channel number in Section 5.1, 5.2 ,5.4 & 5.5.	November 5, 2020
Rev.2	Update channel list in page8&9. Update Duty cycle and Duty cycle correction Factor in page11.	November 20, 2020
Note: This revised report (Report No. R2009A0623-R1V2) supersedes and replaces the previously issued report (Report No. R2009A0623-R1V1). Please discard or destroy the previously issued report and dispose of it accordingly.		



Summary of measurement results

Number	Test Case	Clause in FCC rules	Verdict
1	Maximum output power	15.247(b)(3)	PASS
2	6 dB bandwidth	15.247(a)(2)	PASS
3	Power spectral density	15.247(e)	PASS
4	Band Edge	15.247(d)	PASS
5	Spurious RF Conducted Emissions	15.247(d)	PASS
6	Unwanted Emissions	15.247(d),15.205,15.209	PASS
7	Conducted Emissions	15.207	PASS
Date of Testing: September 25, 2020 ~ October 17, 2020			
Date of Sample Received:September 9, 2020			
Note: All indications of Pass/Fail in this report are opinions expressed by TA Technology (Shanghai) Co., Ltd. based on interpretations and/or observations of test results. Measurement Uncertainties were not taken into account and are published for informational purposes only.			



1. Test Laboratory

1.1. Notes of the test report

This report shall not be reproduced in full or partial, without the written approval of **TA technology (shanghai) co., Ltd.** The results documented in this report apply only to the tested sample, under the conditions and modes of operation as described herein .Measurement Uncertainties were not taken into account and are published for informational purposes only. This report is written to support regulatory compliance of the applicable standards stated above.

1.2. Test facility

FCC (Designation number: CN1179, Test Firm Registration Number: 446626)

TA Technology (Shanghai) Co., Ltd. has been listed on the US Federal Communications Commission list of test facilities recognized to perform electromagnetic emissions measurements.

A2LA (Certificate Number: 3857.01)

TA Technology (Shanghai) Co., Ltd. has been listed by American Association for Laboratory Accreditation to perform electromagnetic emission measurement.

1.3. Testing Location

Company: TA Technology (Shanghai) Co., Ltd.
Address: No.145, Jintang Rd, Tangzhen Industry Park, Pudong
City: Shanghai
Post code: 201201
Country: P. R. China
Contact: Xu Kai
Telephone: +86-021-50791141/2/3
Fax: +86-021-50791141/2/3-8000
Website: <http://www.ta-shanghai.com>
E-mail: xukai@ta-shanghai.com

2. General Description of Equipment under Test

2.1. Applicant and Manufacturer Information

Applicant	Espressif Systems (Shanghai) Co.,Ltd.
Applicant address	Suite 204, Block 2, 690 Bibo Road, Zhang Jiang Hi-Tech Park, Shanghai, China
Manufacturer	Espressif Systems (Shanghai) Co.,Ltd.
Manufacturer address	Suite 204, Block 2, 690 Bibo Road, Zhang Jiang Hi-Tech Park, Shanghai, China

2.2. General information

EUT Description	
Model	ESP32-S2-MINI-1, ESP32-S2-MINI-1U
SN	1#
Hardware Version	V1.4
Software Version	V1.1.3.0
Power Supply	External power supply
Antenna Type	ESP32-S2-MINI-1: PCB Antenna ESP32-S2-MINI-1U: External Antenna
Antenna Connector	ipex(meet with the standard FCC Part 15.203 requirement)
Antenna Gain	ESP32-S2-MINI-1: 3.71 dBi ESP32-S2-MINI-1U: 2.33 dBi
Test Mode	802.11b 802.11g, 802.11n(HT20/HT40);
Modulation Type	802.11b: DSSS; 802.11g/n(HT20/HT40): OFDM
Max. Conducted Power	Wi-Fi 2.4G :19.10dBm
Operating Frequency Range(s)	802.11b/g/n(HT20): 2412 ~ 2462 MHz 802.11n(HT40): 2422 ~ 2452 MHz
Number of Channels:	<input checked="" type="checkbox"/> 11 channels for Wi-Fi (802.11b/g/n HT20) <input checked="" type="checkbox"/> 9 channels for Wi-Fi (802.11n HT40 only)
<p>Note: 1. The EUT is sent from the applicant to TA and the information of the EUT is declared by the applicant.</p> <p>2. ESP32-S2-MINI-1 is the main model and ESP32-S2-MINI-1U is its series model. For conducted test items, this report only recorded the test results of ESP32-S2-MINI-1.</p>	



3. Applied Standards

According to the specifications of the manufacturer, it must comply with the requirements of the following standards:

Test standards:

FCC CFR47 Part 15C (2019) Radio Frequency Devices

ANSI C63.10 (2013)

Reference standard:

KDB 558074 D01 15.247 Meas Guidance v05r02

4. Test Configuration

Test Mode

The EUT has been associated with peripherals and configuration operated in a manner tended to maximize its emission characteristics in a typical application.

The radiated emission was measured in the following position: EUT stand-up position (Z axis), lie-down position (X, Y axis). The worst emission was found in lie-down position (X axis) and the loop antenna is vertical, the others are vertical and horizontal. and the worst case was recorded.

In order to find the worst case condition, Pre-tests are needed at the presence of different data rate. Preliminary tests have been done on all the configuration for confirming worst case. Data rate below means worst-case rate of each test item.

Worst-case data rates are shown as following table.

Mode	Data Rate
802.11b	1 Mbps
802.11g	6 Mbps
802.11n HT20	MCS0
802.11n HT40	MCS0

Test Frequency Range

Mode	Channel	Frequency
802.11b	1	2412MHz
	2	2417MHz
	3	2422MHz
	4	2427MHz
	5	2432MHz
	6	2437MHz
	7	2442MHz
	8	2447MHz
	9	2452MHz
	10	2457MHz
	11	2462MHz
802.11g	1	2412MHz
	2	2417MHz
	3	2422MHz



	4	2427MHz
	5	2432MHz
	6	2437MHz
	7	2442MHz
	8	2447MHz
	9	2452MHz
	10	2457MHz
	11	2462MHz
802.11n HT20	1	2412MHz
	2	2417MHz
	3	2422MHz
	4	2427MHz
	5	2432MHz
	6	2437MHz
	7	2442MHz
	8	2447MHz
	9	2452MHz
	10	2457MHz
	11	2462MHz
802.11n HT40	3	2422MHz
	4	2427MHz
	5	2432MHz
	6	2437MHz
	7	2442MHz
	8	2447MHz
	9	2452MHz

5. Test Case Results

5.1. Maximum output power

Ambient condition

Temperature	Relative humidity	Pressure
23°C ~25°C	45%~50%	101.5kPa

Methods of Measurement

During the process of the testing, The EUT was connected to Power meter with a known loss. The EUT is max power transmission with proper modulation.

Test Setup

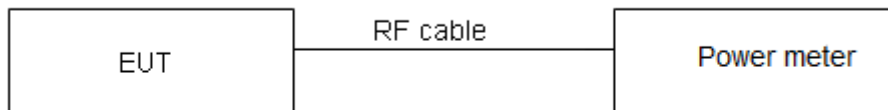

Limits

Rule Part 15.247 (b) (3) specifies that " For systems using digital modulation in the 902–928 MHz, 2400–2483.5 MHz: 1 Watt."

Average Output Power	≤ 1W (30dBm)
----------------------	--------------

Measurement Uncertainty

The assessed measurement uncertainty to ensure 95% confidence level for the normal distribution is with the coverage factor $k = 2$, $U = 0.44$ dB.



Test Results

ESP32-S2-MINI-1

Single Antenna Power Index			
Test Mode	CH1	CH6	CH11
802.11b	5	0	5
802.11g	15	0	20
802.11n HT20	15	0	25
Test Mode	CH3	CH6	CH9
802.11n HT40	15	0	30

Test Mode	T _{on} (ms)	T _(on+off) (ms)	Duty cycle	Duty cycle correction Factor(dB)
802.11b	0.595	0.675	0.882	0.547
802.11g	0.583	0.662	0.880	0.557
802.11n HT20	0.564	0.644	0.876	0.574
802.11n HT40	0.583	0.662	0.880	0.557

Note: when Duty cycle ≥ 0.98 , Duty cycle correction Factor not required.

Test Mode	Carrier frequency (MHz)/CH	Average Power Measured (dBm)	Average Power with duty factor (dBm)	Limit (dBm)	Conclusion
802.11b	2412/CH1	17.03	17.58	30	PASS
	2437/CH6	18.55	19.10	30	PASS
	2462/CH11	17.56	18.11	30	PASS
802.11g	2412/CH1	13.62	14.18	30	PASS
	2437/CH6	16.97	17.53	30	PASS
	2462/CH11	12.33	12.89	30	PASS
802.11n HT20	2412/CH1	13.54	14.11	30	PASS
	2437/CH6	16.82	17.39	30	PASS
	2462/CH11	11.20	11.77	30	PASS
802.11n HT40	2422/CH3	13.96	14.52	30	PASS
	2437/CH6	17.33	17.89	30	PASS
	2452/CH9	10.32	10.88	30	PASS

Note: Average Power with duty factor = Average Power Measured +Duty cycle correction factor

5.2. 99% Bandwidth and 6dB Bandwidth

Ambient condition

Temperature	Relative humidity	Pressure
23°C ~25°C	45%~50%	101.5kPa

Method of Measurement

The EUT was connected to the spectrum analyzer through an external attenuator (20dB) and a known loss cable. RBW is set to 100 kHz; VBW is set to 300 kHz on spectrum analyzer. Dector=Peak, Trace mode=max hold.

The EUT was connected to the spectrum analyzer through a known loss cable. The resolution bandwidth (RBW) shall be in the range of 1% to 5% of the actual occupied / x dB bandwidth and the video bandwidth (VBW) shall not be smaller than three times the RBW value.

Test Setup

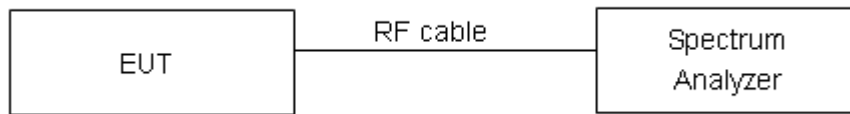

Limits

Rule Part 15.247 (a) (2) specifies that “Systems using digital modulation techniques may operate in the 902–928 MHz, 2400–2483.5 MHz bands. The minimum 6 dB bandwidth shall be at least 500 kHz.”

minimum 6 dB bandwidth	≥ 500 kHz
------------------------	-----------

Measurement Uncertainty

The assessed measurement uncertainty to ensure 95% confidence level for the normal distribution is with the coverage factor $k = 2$, $U = 936$ Hz.

Test Results:
ESP32-S2-MINI-1

Test Mode	Carrier frequency (MHz)/CH	99% bandwidth (MHz)	Minimum 6 dB bandwidth (MHz)	Limit (kHz)	Conclusion
802.11b	2412/CH1	13.259	10.07	500	PASS
	2437/CH6	13.414	10.08	500	PASS
	2462/CH11	13.247	10.05	500	PASS
802.11g	2412/CH1	16.797	16.39	500	PASS
	2437/CH6	16.882	16.36	500	PASS
	2462/CH11	16.802	16.38	500	PASS
802.11n HT20	2412/CH1	17.842	17.61	500	PASS
	2437/CH6	17.931	17.60	500	PASS
	2462/CH11	17.881	17.62	500	PASS
802.11n HT40	2422/CH3	36.533	36.41	500	PASS
	2437/CH6	36.676	36.39	500	PASS
	2452/CH9	36.553	36.43	500	PASS



99%bandwidth
ESP32-S2-MINI-1

802.11b, Carrier frequency (MHz): 2412

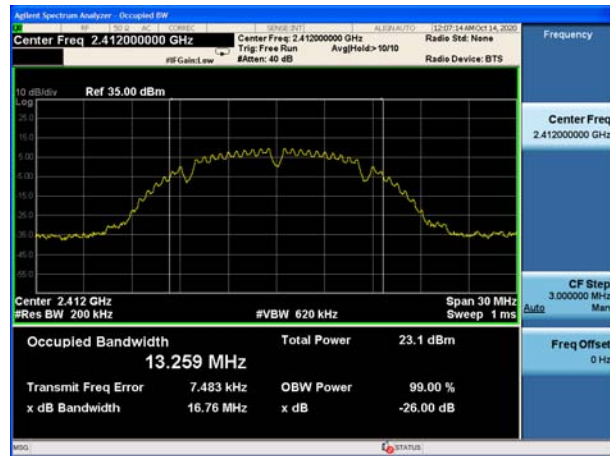

802.11g, Carrier frequency (MHz): 2412

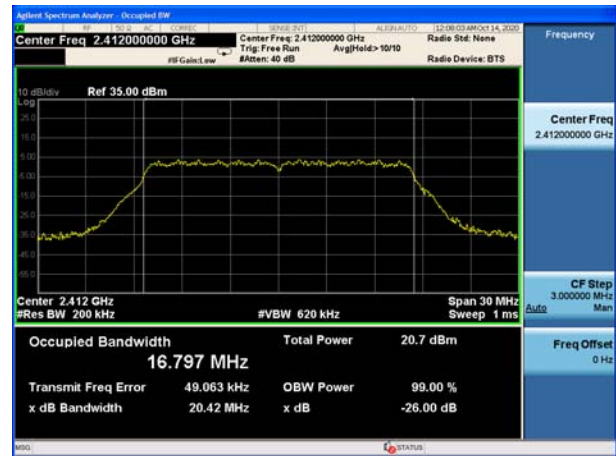

802.11b, Carrier frequency (MHz): 2437

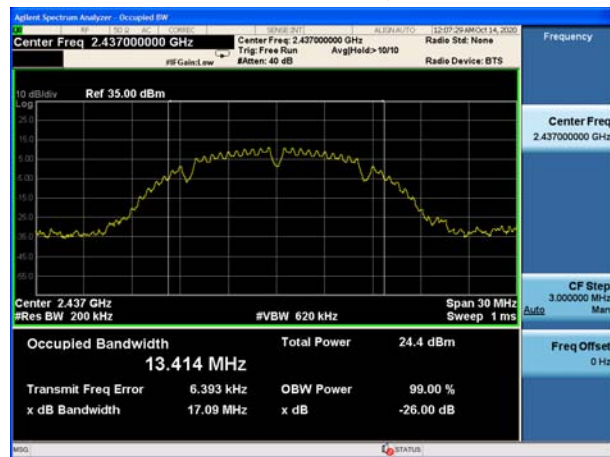

802.11g, Carrier frequency (MHz): 2437



802.11b, Carrier frequency (MHz):2462



802.11g, Carrier frequency (MHz):2462



802.11n(HT20), Carrier frequency (MHz): 2412

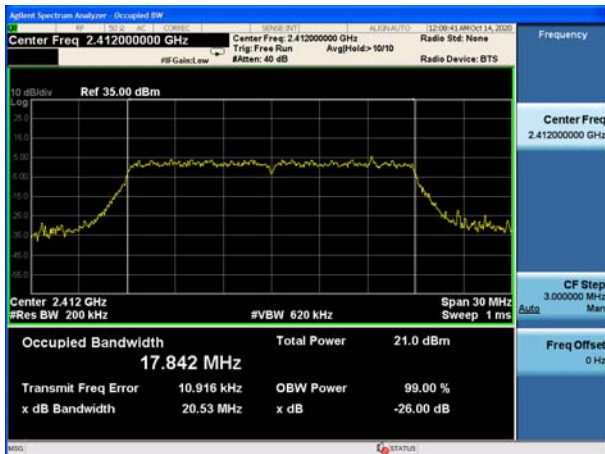

802.11n(HT40), Carrier frequency (MHz): 2422

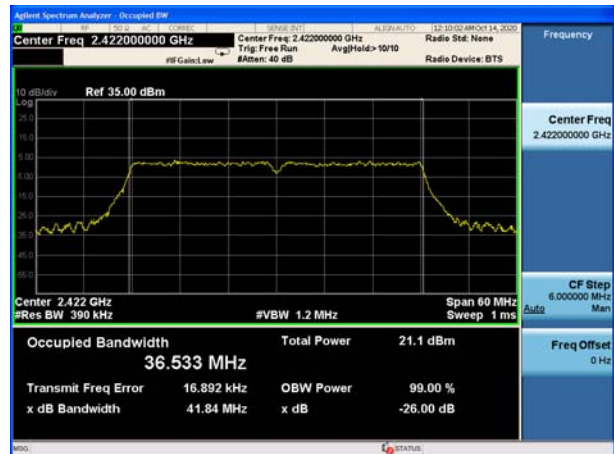

802.11n(HT20), Carrier frequency (MHz): 2437

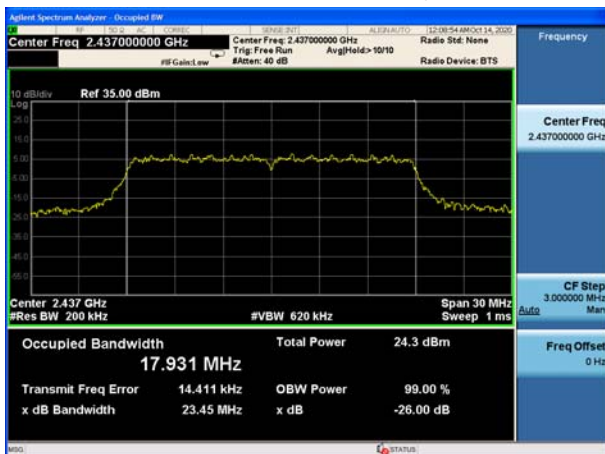

802.11n(HT40), Carrier frequency (MHz): 2437

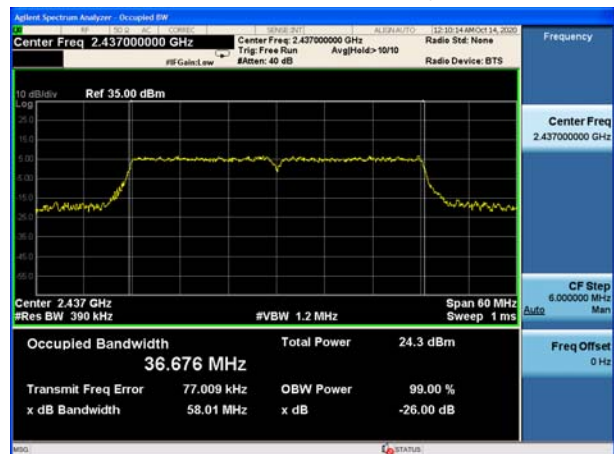

802.11n(HT20), Carrier frequency (MHz): 2462

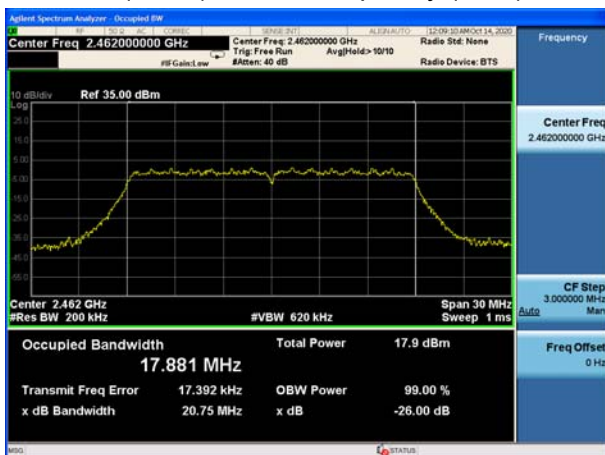

802.11n(HT40), Carrier frequency (MHz): 2452

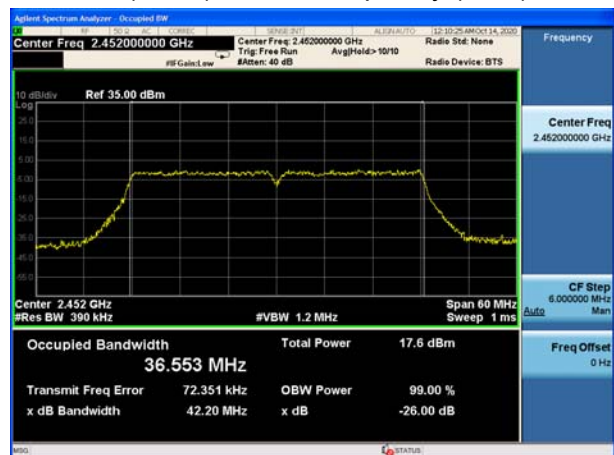



6 dB bandwidth

ESP32-S2-MINI-1

802.11b, Carrier frequency (MHz): 2412

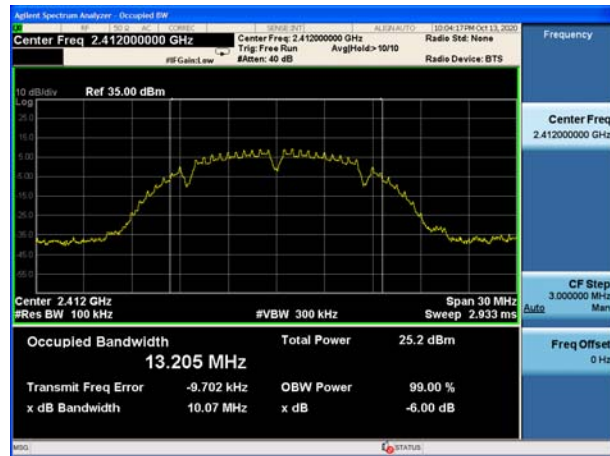

802.11g, Carrier frequency (MHz): 2412

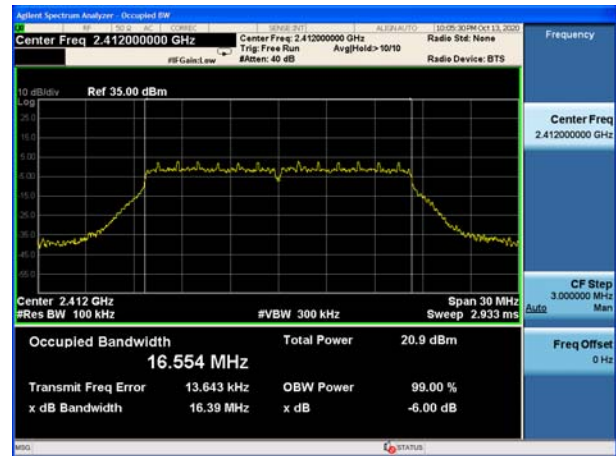

802.11b, Carrier frequency (MHz): 2437

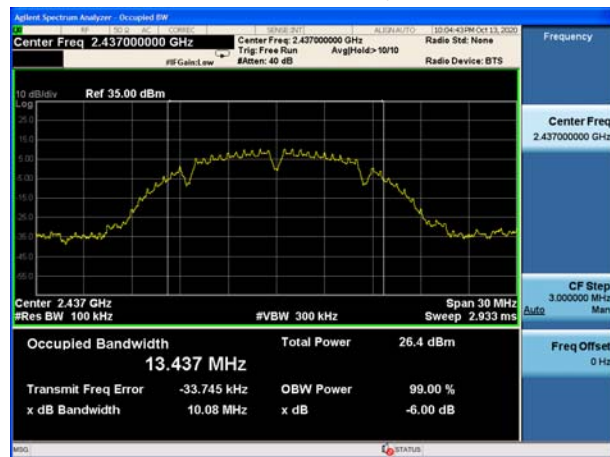

802.11g, Carrier frequency (MHz): 2437

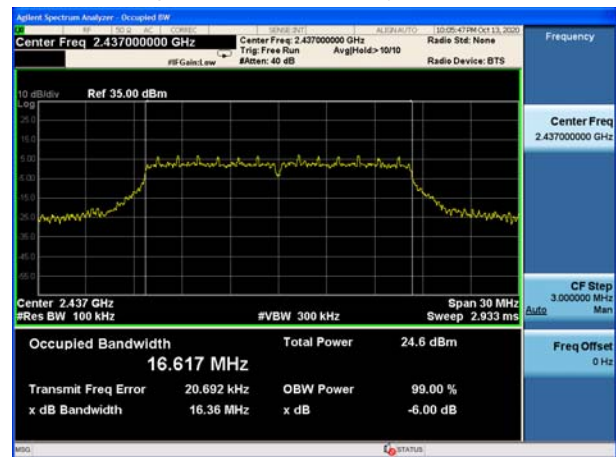

802.11b, Carrier frequency (MHz): 2462

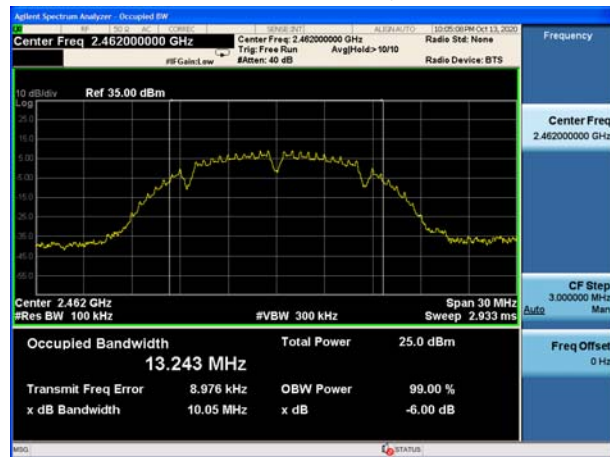

802.11g, Carrier frequency (MHz): 2462

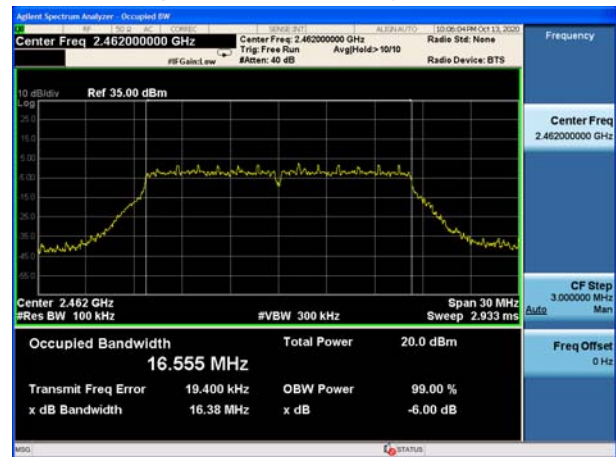



802.11n(HT20), Carrier frequency (MHz): 2412

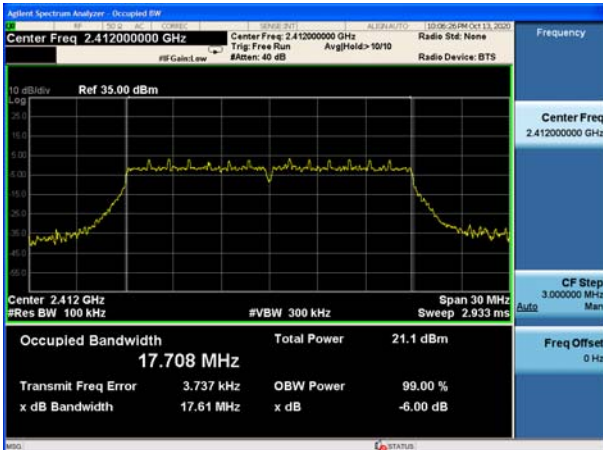

802.11n(HT40), Carrier frequency (MHz): 2422

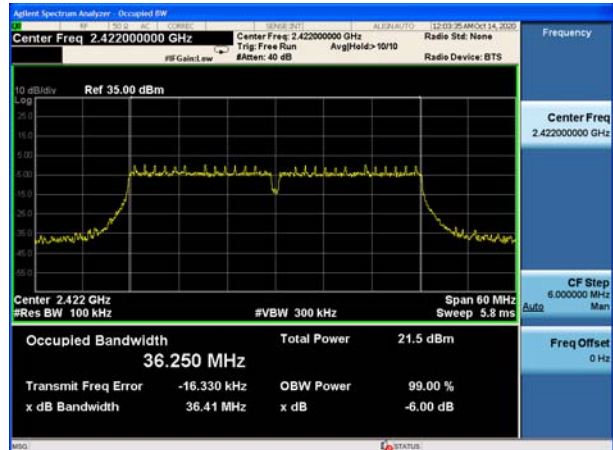

802.11n(HT20), Carrier frequency (MHz): 2437

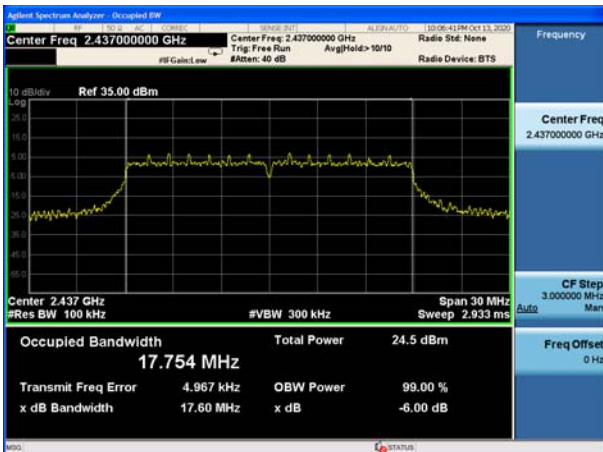

802.11n(HT40), Carrier frequency (MHz): 2437

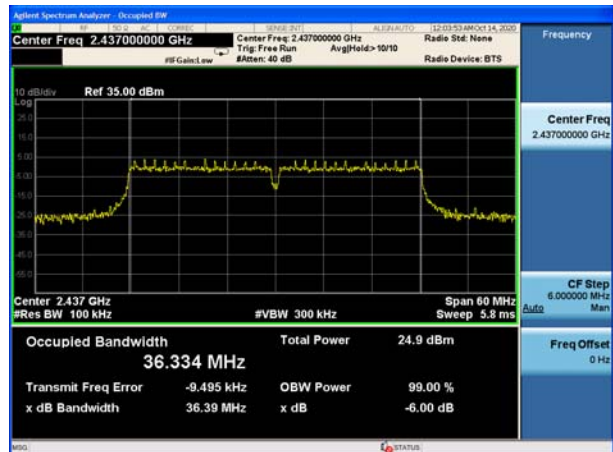

802.11n(HT20), Carrier frequency (MHz):2462

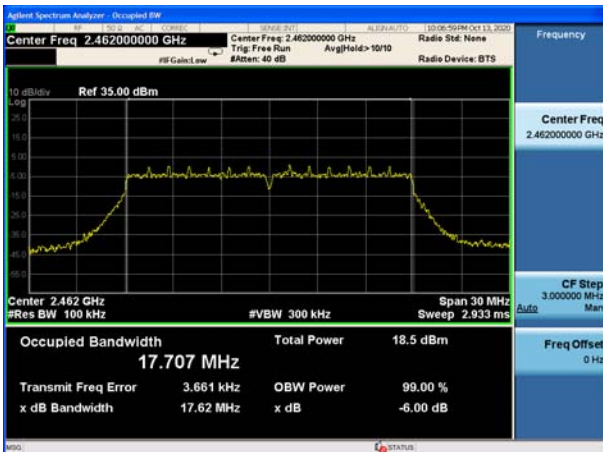

802.11n(HT40), Carrier frequency (MHz):2452

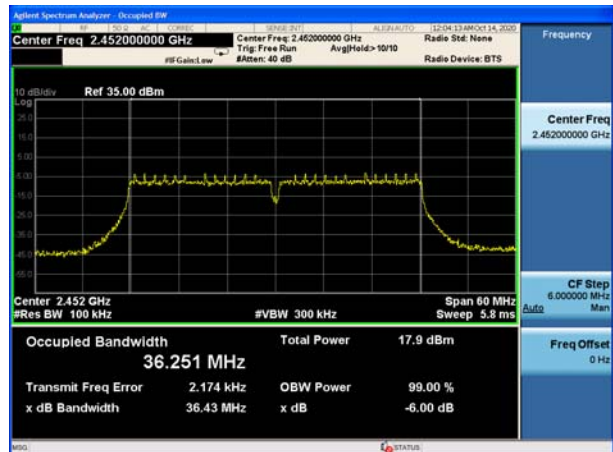

5.3. Band Edge

Ambient condition

Temperature	Relative humidity	Pressure
23°C ~25°C	45%~50%	101.5kPa

Method of Measurement

The EUT was connected to the spectrum analyzer through an external attenuator (20dB) and a known loss cable the band edge of the lowest and highest channels were measured. The peak detector is used and RBW is set to 100 kHz and VBW is set to 300 kHz on spectrum analyzer. Spectrum analyzer plots are included on the following pages.

Test Setup

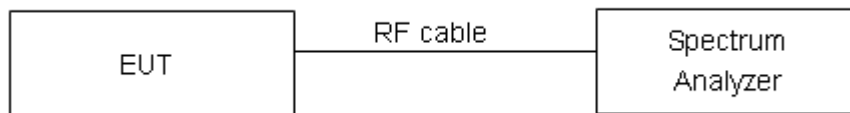

Limits

Rule Part 15.247(d) specifies that “In any 100 kHz bandwidth outside the frequency band in which the spread spectrum or digitally modulated intentional radiator is operating, the radio frequency power that is produced by the intentional radiator shall be at least 20 dB below that in the 100 kHz bandwidth within the band that contains the highest level of the desired power, based on either an RF conducted or a radiated measurement, provided the transmitter demonstrates compliance with the peak conducted power limits.” If the transmitter complies with the conducted power limits based on the use of RMS averaging over a time interval, as permitted under paragraph (b)(3) of this section, the attenuation required under this paragraph shall be 30 dB instead of 20 dB.”

Measurement Uncertainty

The assessed measurement uncertainty to ensure 95% confidence level for the normal distribution is with the coverage factor $k = 1.96$.

Frequency	Uncertainty
2GHz-3GHz	1.407 dB



Test Results: PASS

ESP32-S2-MINI-1

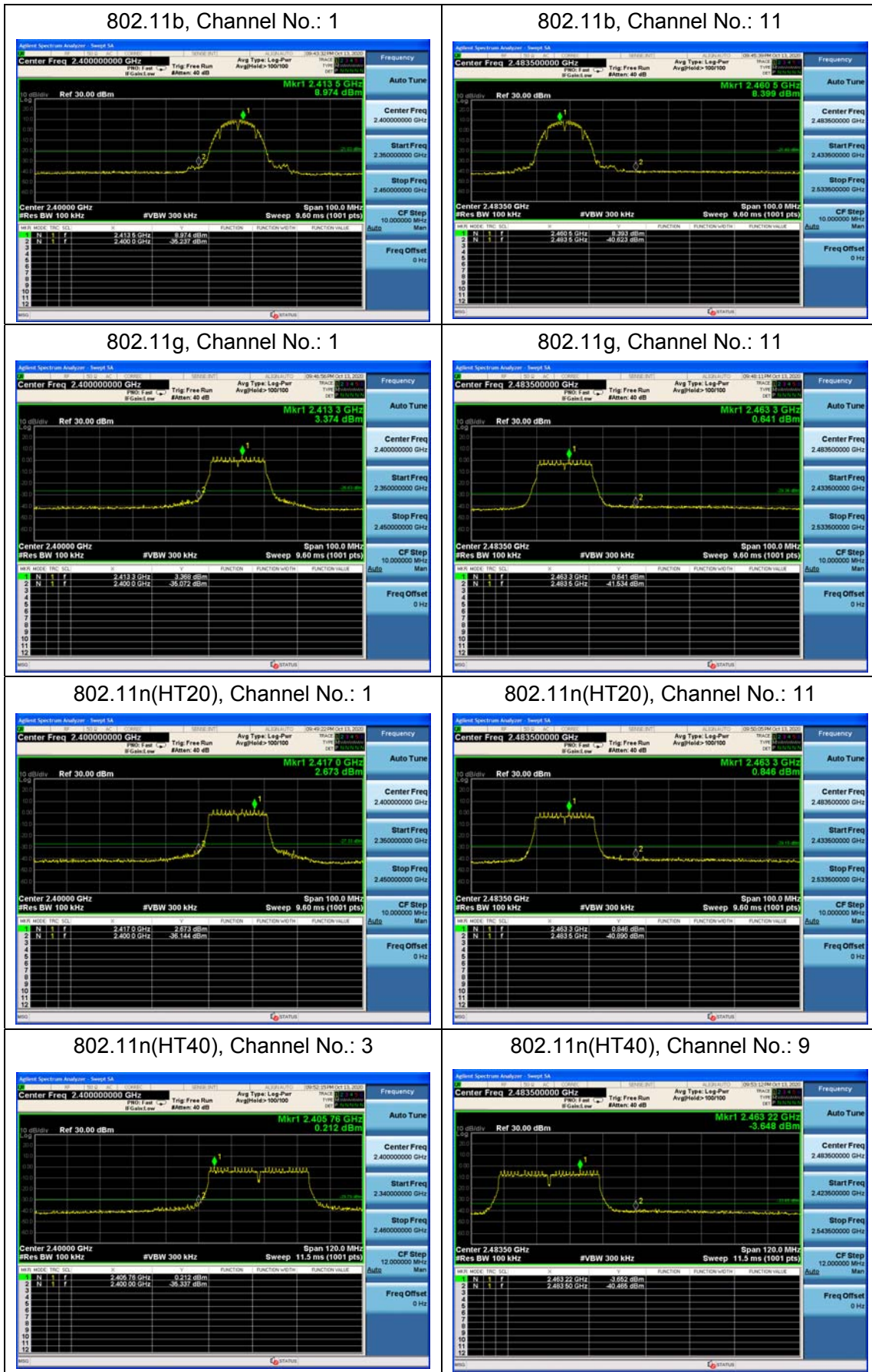

5.4. Power Spectral Density

Ambient condition

Temperature	Relative humidity	Pressure
23°C ~25°C	45%~50%	101.5kPa

Method of Measurement

During the process of the testing, The EUT was connected to Spectrum Analyzer with a known loss. The EUT is max power transmission with proper modulation.

Method AVGPSD-2 was used for this test.

- a) Measure the duty cycle(D)of the transmitter output signal as described in 11.6
- b) Set instrument center frequency to DTS channel center frequency
- c)Set span to at least 1.5 times the OBW
- d) Set RBW to: $3\text{kHz} \leq \text{RBW} \leq 100\text{Kh}$
- e) Set $\text{VBW} \geq [3x \text{RBW}]$
- f)Detector= power averaging(rms) or sample detector (when rms not available)
- g) Ensure that the number of measurement points in the sweep $2[2 X \text{span}/\text{RBW}]$
- h) Sweep time =auto couple
- i) Do not use sweep triggering; allow sweep to "free run"
- j) Employ trace averaging(rms) mode over a minimum of 100 traces
- k) Use the peak marker function to determine the maximum amplitude level
- l) Add $[10 \log(1/ D)]$, where D is the duty cycle measured in step a), to the measured PSD to compute the average PSD during the actual transmission time
- m) If measured value exceeds requirement specified by regulatory agency then reduce RBW(but o less than 3 kHz) and repeat(note that this may require zooming in on the emission of interest and reducing the span to meet the minimum measurement point requirement as the RBW is reduced)

Test setup

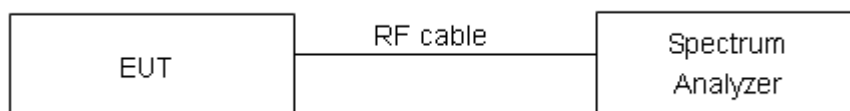



Limits

Rule Part 15.247(e) specifies that " For digitally modulated systems, the power spectral density conducted from the intentional radiator to the antenna shall not be greater than 8 dBm in any 3 kHz band during any time interval of continuous transmission. "

Limits	$\leq 8 \text{ dBm} / 3\text{kHz}$
--------	------------------------------------

Measurement Uncertainty

The assessed measurement uncertainty to ensure 95% confidence level for the normal distribution is with the coverage factor $k = 2$, $U = 0.75\text{dB}$.

**Test Results:****ESP32-S2-MINI-1**

Test Mode	Carrier Frequency (MHz)/CH	Read Value (dBm / 3kHz)	Power Spectral Density (dBm / 3kHz)	Limit (dBm / 3kHz)	Conclusion
802.11b	2412/CH1	-15.06	-14.52	8	PASS
	2437/CH6	-13.48	-12.94	8	PASS
	2462/CH11	-15.08	-14.53	8	PASS
802.11g	2412/CH1	-20.15	-19.59	8	PASS
	2437/CH6	-16.71	-16.16	8	PASS
	2462/CH11	-20.95	-20.39	8	PASS
802.11n HT20	2412/CH1	-20.01	-19.43	8	PASS
	2437/CH6	-16.30	-15.73	8	PASS
	2462/CH11	-22.05	-21.48	8	PASS
802.11n HT40	2422/CH3	-22.68	-22.13	8	PASS
	2437/CH6	-18.91	-18.35	8	PASS
	2452/CH9	-27.23	-26.67	8	PASS
Note: Power Spectral Density =Read Value+Duty cycle correction factor					

ESP32-S2-MINI-1

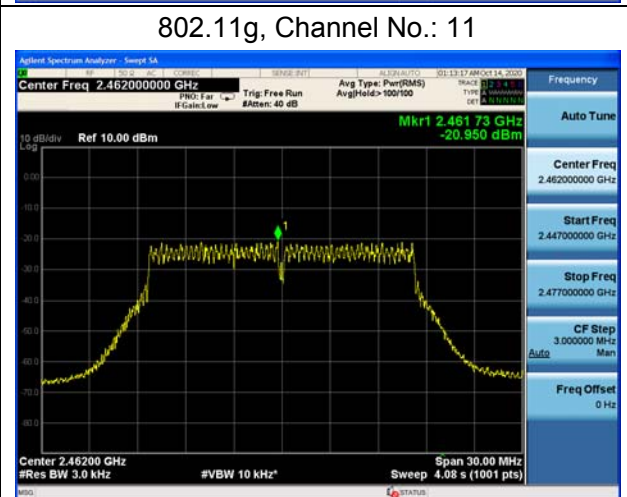
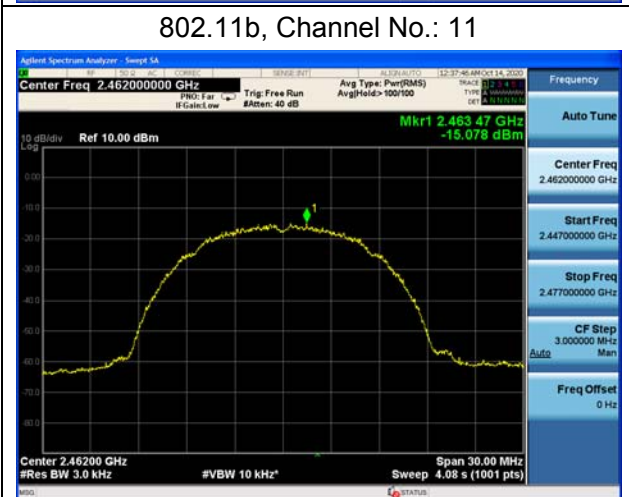
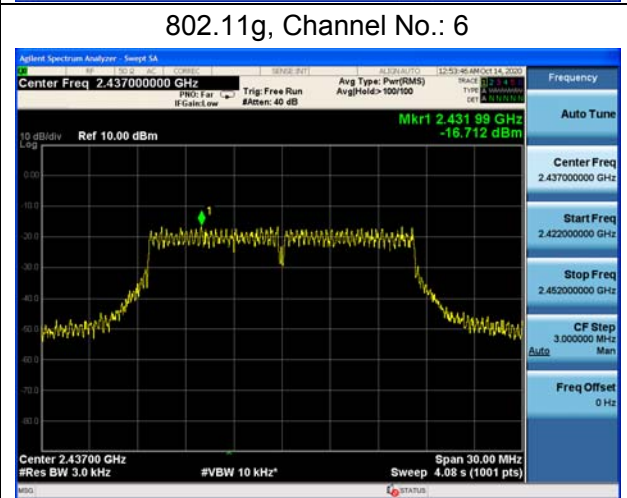
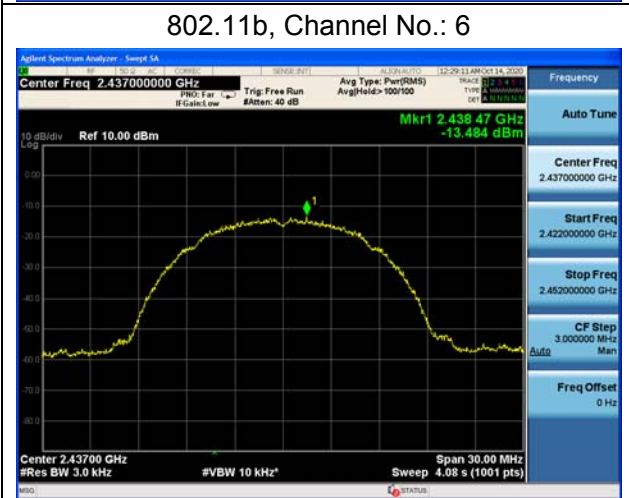
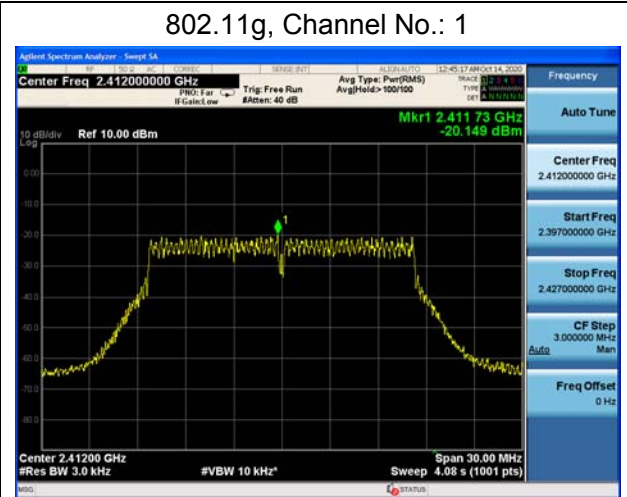
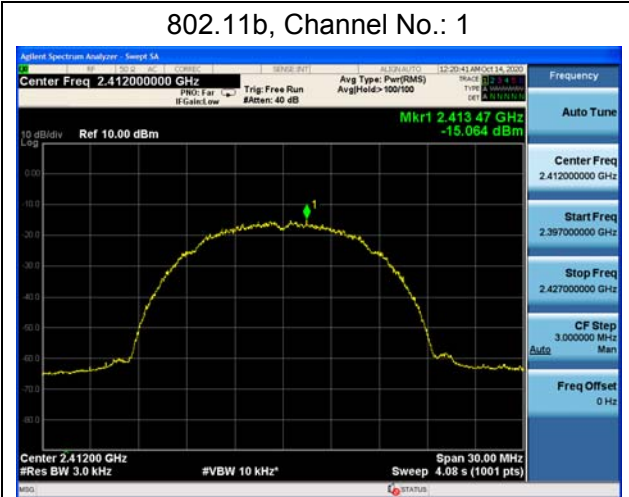

802.11n(HT20), Channel No. 1

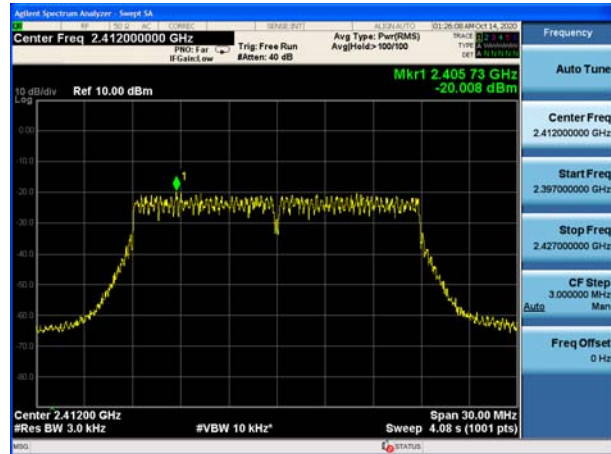

802.11n(HT40), Channel No. 3

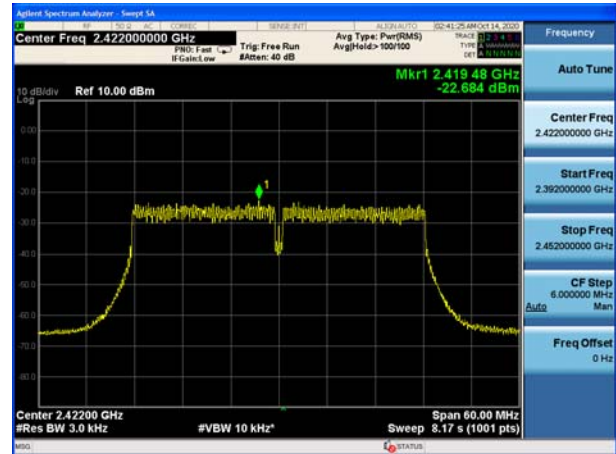

802.11n(HT20), Channel No. 6

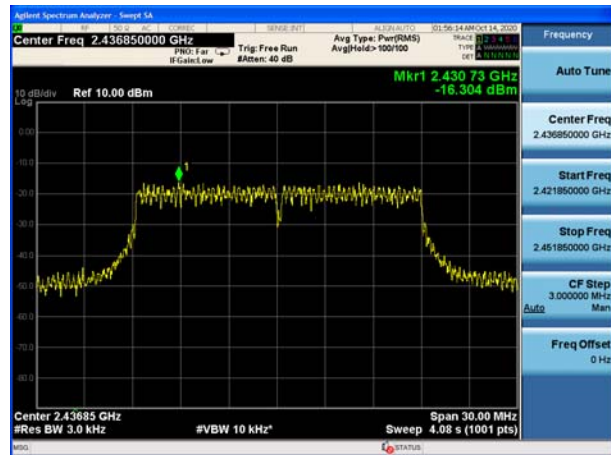

802.11n(HT40), Channel No. 6

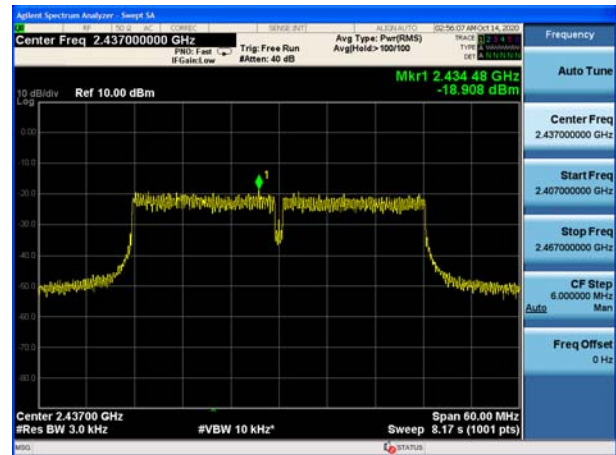

802.11n(HT20), Channel No. 11

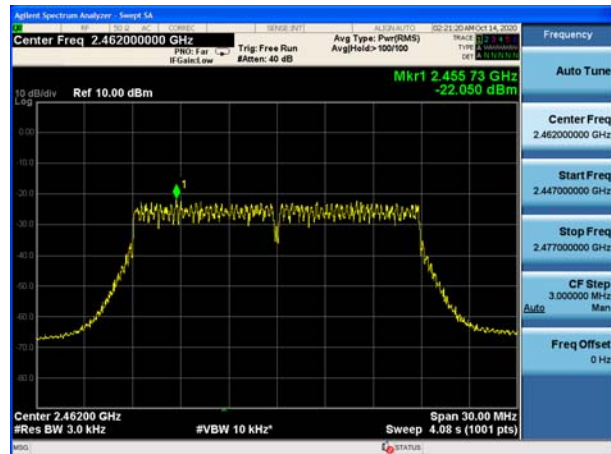

802.11n(HT40), Channel No. 9

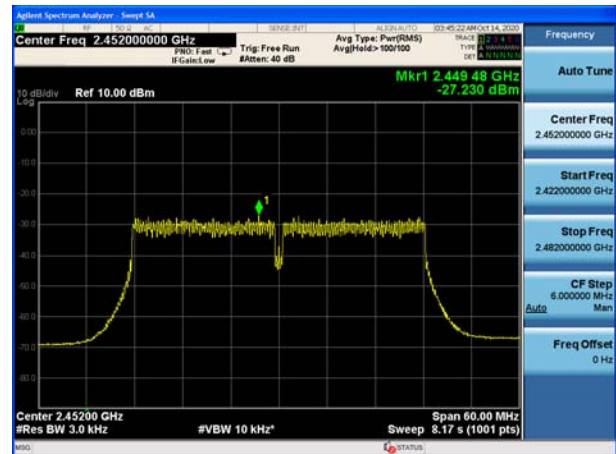

5.5. Spurious RF Conducted Emissions

Ambient condition

Temperature	Relative humidity	Pressure
23°C ~25°C	45%~50%	101.5kPa

Method of Measurement

The EUT was connected to the spectrum analyzer with a known loss. The spectrum analyzer scans from 30MHz to the 10th harmonic of the carrier. The peak detector is used. Set RBW to 100 kHz and VBW to 300 kHz, Sweep is set to ATUO.

The test is in transmitting mode.

Test setup



Limits

Rule Part 15.247(d) pacifies that “In any 100 kHz bandwidth outside the frequency band in which the spread spectrum or digitally modulated intentional radiator is operating, the radio frequency power that is produced by the intentional radiator shall be at least 20 dB below that in the 100 kHz bandwidth within the band that contains the highest level of the desired power, based on either an RF conducted or a radiated measurement, provided the transmitter demonstrates compliance with the peak conducted power limits. If the transmitter complies with the conducted power limits based on the use of RMS averaging over a time interval, as permitted under paragraph (b)(3) of this section, the attenuation required under this paragraph shall be 30 dB instead of 20 dB. ”

Test Mode	Carrier Frequency (MHz)/CH	Reference value (dBm)	Limit
802.11b	2412/CH1	8.71	-21.29
	2437/CH6	10.18	-19.82
	2462/CH11	8.68	-21.32
802.11g	2412/CH1	3.62	-26.38
	2437/CH6	6.62	-23.38
	2462/CH11	1.72	-28.28
802.11n HT20	2412/CH1	3.40	-26.60
	2437/CH6	6.38	-23.62
	2462/CH11	0.85	-29.15
802.11n HT40	2422/CH3	-0.18	-30.18
	2437/CH6	3.69	-26.31
	2452/CH9	-3.60	-33.60

Measurement Uncertainty

The assessed measurement uncertainty to ensure 95% confidence level for the normal distribution is with the coverage factor $k = 1.96$.

Frequency	Uncertainty
100kHz-2GHz	0.684 dB
2GHz-26GHz	1.407 dB



Test Results:

ESP32-S2-MINI-1

802.11b, Channel No.: 1

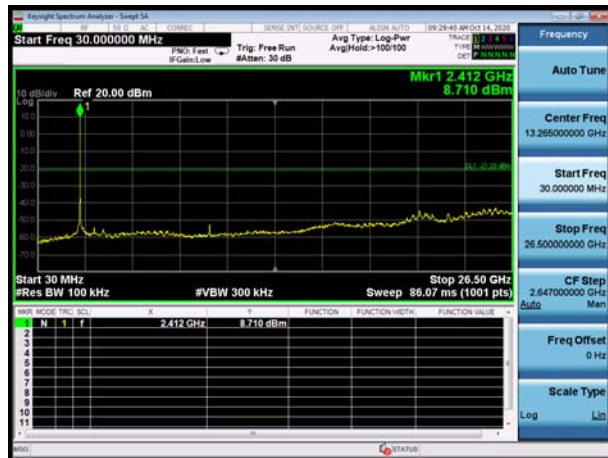

802.11g, Channel No.: 1

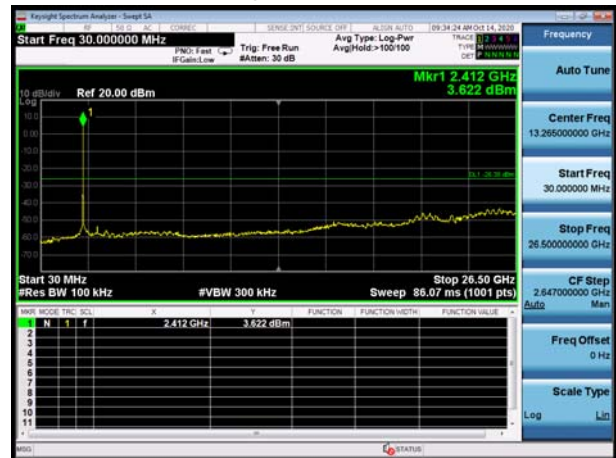

802.11b, Channel No.: 6

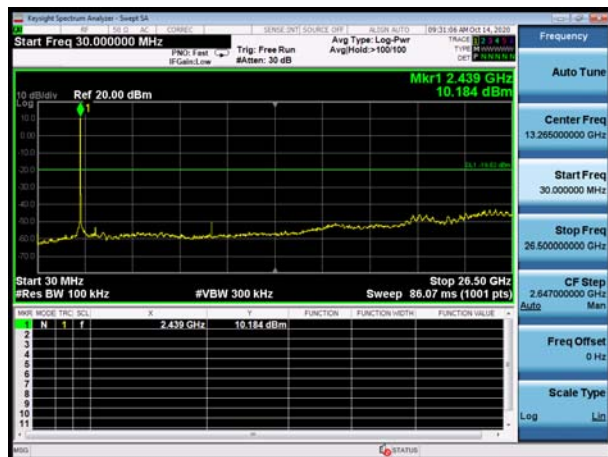

802.11g, Channel No.: 6

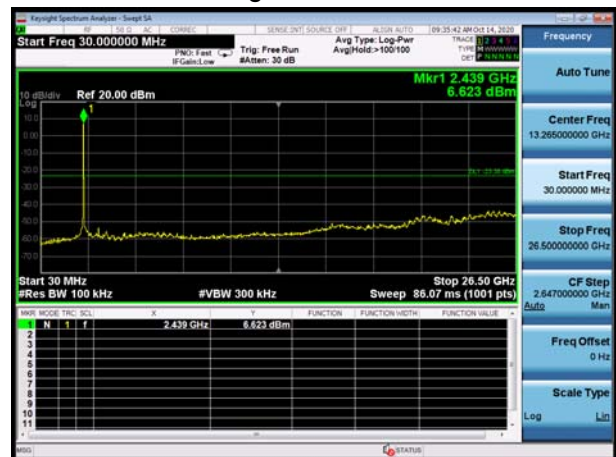

802.11b, Channel No.: 11

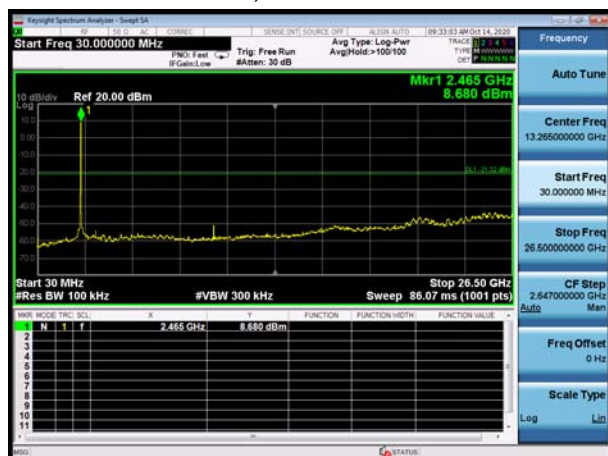

802.11g, Channel No.: 11

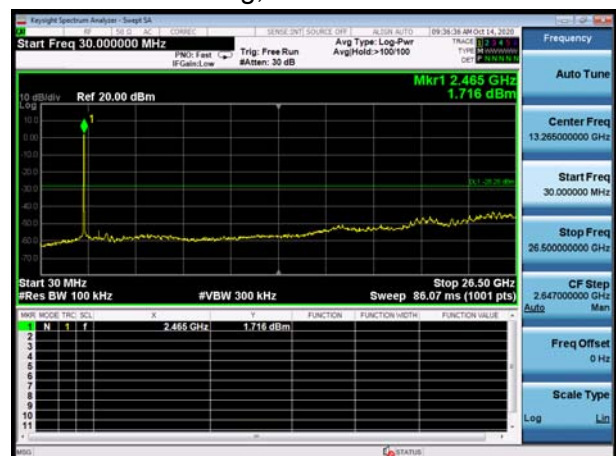

802.11n(HT20), Channel No. 1

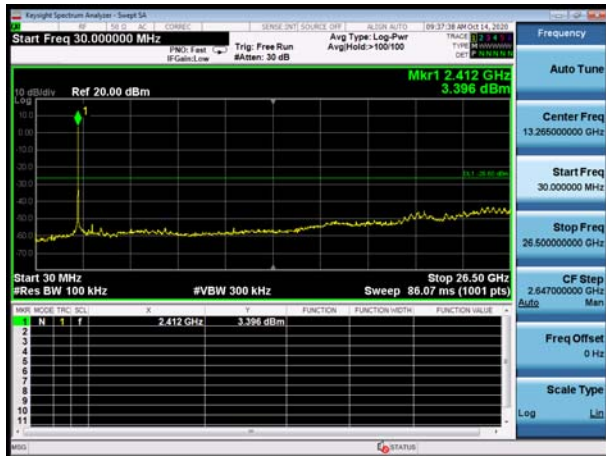

802.11n(HT40), Channel No. 3

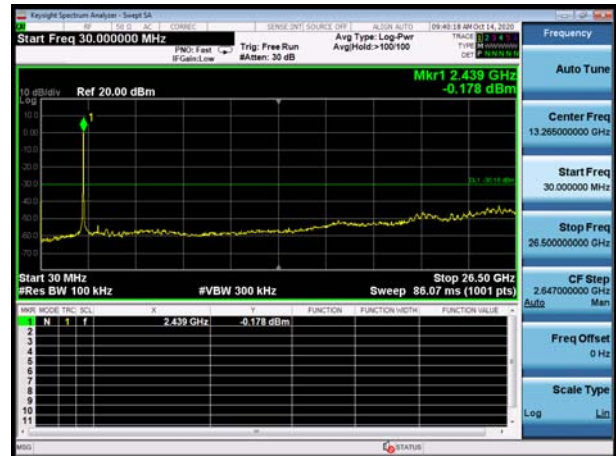

802.11n(HT20), Channel No. 6

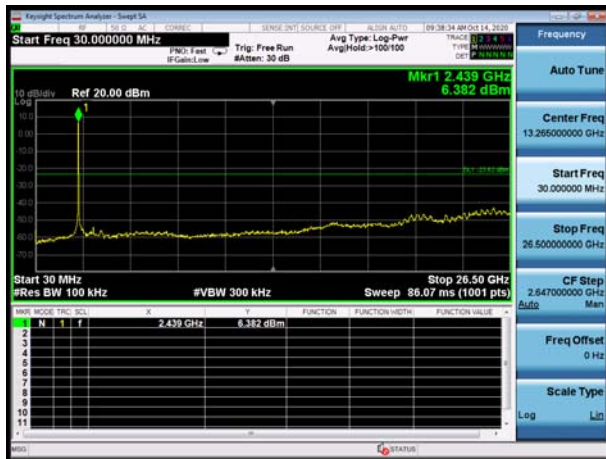

802.11n(HT40), Channel No. 6

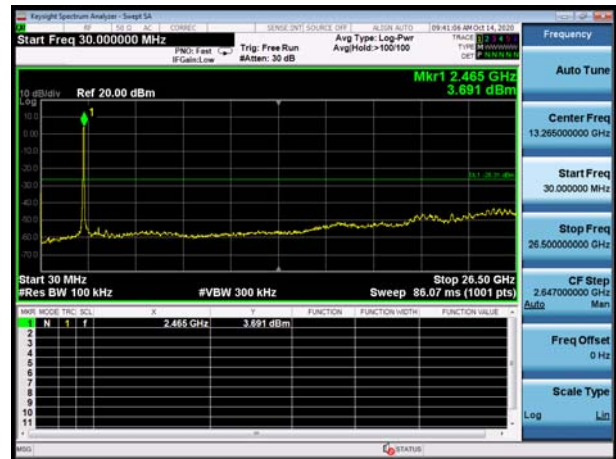

802.11n(HT20), Channel No. 11

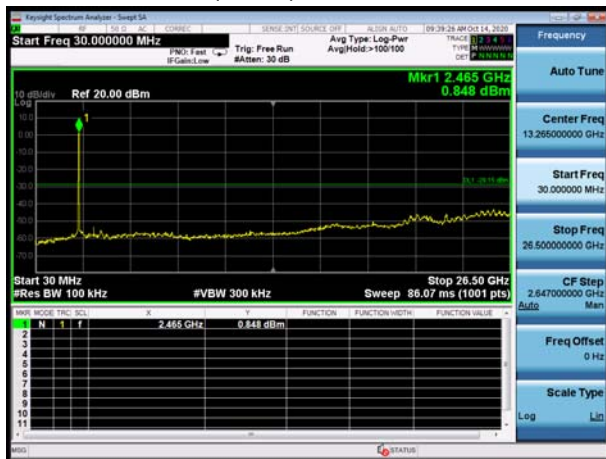

802.11n(HT40), Channel No. 9

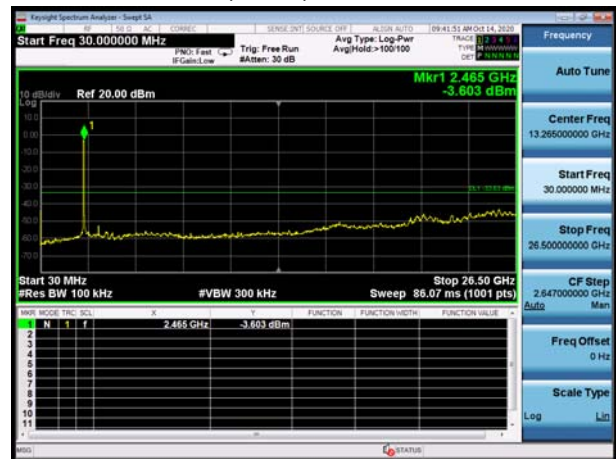

5.6. Unwanted Emission

Ambient condition

Temperature	Relative humidity	Pressure
23°C ~25°C	45%~50%	102.5kPa

Method of Measurement

The test set-up was made in accordance to the general provisions of ANSI C63.10-2013.

The Equipment Under Test (EUT) was set up on a non-conductive table in the semi-anechoic chamber. The test was performed at the distance of 3 m between the EUT and the receiving antenna.

The turntable shall be rotated from 0 to 360 degrees for detecting the maximum of radiated spurious signal level. The measurements shall be repeated with orthogonal polarization of the test antenna. The data of cable loss and antenna factor has been calibrated in full testing frequency range before the testing. Sweep the Restricted Band and the emissions less than 20 dB below the permissible value are reported.

The radiated emissions measurements were made in a typical installation configuration.

Sweep the whole frequency band through the range from 9 kHz to the 10th harmonic of the carrier, and the emissions less than 20 dB below the permissible value are reported.

This method refer to ANSI C63.10-2013.

The procedure for peak unwanted emissions measurements above 1000 MHz is as follows:

Set the spectrum analyzer in the following:

9kHz~150 kHz

RBW=200Hz, VBW=1kHz/ Sweep=AUTO

150 kHz~30MHz

RBW=9KHz, VBW=30KHz,/ Sweep=AUTO

Below 1GHz

RBW=100kHz / VBW=300kHz / Sweep=AUTO

a) Peak emission levels are measured by setting the instrument as follows:

Above 1GHz

PEAK: RBW=1MHz VBW=3MHz/ Sweep=AUTO

b) Average emission levels are measured by setting the instrument as follows:

Above 1GHz

AVERAGE: RBW=1MHz / VBW=3MHz / Sweep=AUTO

c) Detector: The measurements employing a CISPR quasi-peak detector except for the frequency bands 9-90 kHz, 110-490 kHz and above 1000 MHz. Radiated emission limits in these three bands are based on measurements employing an average detector.

d) Averaging type = power (i.e., rms) (As an alternative, the detector and averaging type may be set for linear voltage averaging. Some instruments require linear display mode to use linear voltage



averaging. Log or dB averaging shall not be used.)

e) Sweep time = auto.

f) Perform a trace average of at least 100 traces if the transmission is continuous. If the transmission is not continuous, then the number of traces shall be increased by a factor of $1 / D$, where D is the duty cycle. For example, with 50% duty cycle, at least 200 traces shall be averaged. (If a specific emission is demonstrated to be continuous—i.e., 100% duty cycle—then rather than turning ON and OFF with the transmit cycle, at least 100 traces shall be averaged.)

g) If tests are performed with the EUT transmitting at a duty cycle less than 98%, then a correction factor shall be added to the measurement results prior to comparing with the emission limit, to compute the emission level that would have been measured had the test been performed at 100% duty cycle. The correction factor is computed as follows:

1) If power averaging (rms) mode was used in the preceding step e), then the correction factor is $[10 \log (1 / D)]$, where D is the duty cycle. For example, if the transmit duty cycle was 50%, then 3 dB shall be added to the measured emission levels.

2) If linear voltage averaging mode was used in the preceding step e), then the correction factor is $[20 \log (1 / D)]$, where D is the duty cycle. For example, if the transmit duty cycle was 50%, then 6 dB shall be added to the measured emission levels.

3) If a specific emission is demonstrated to be continuous (100% duty cycle) rather than turning ON and OFF with the transmit cycle, then no duty cycle correction is required for that emission.

The test is in transmitting mode.

Test setup

9KHz ~ 30MHz

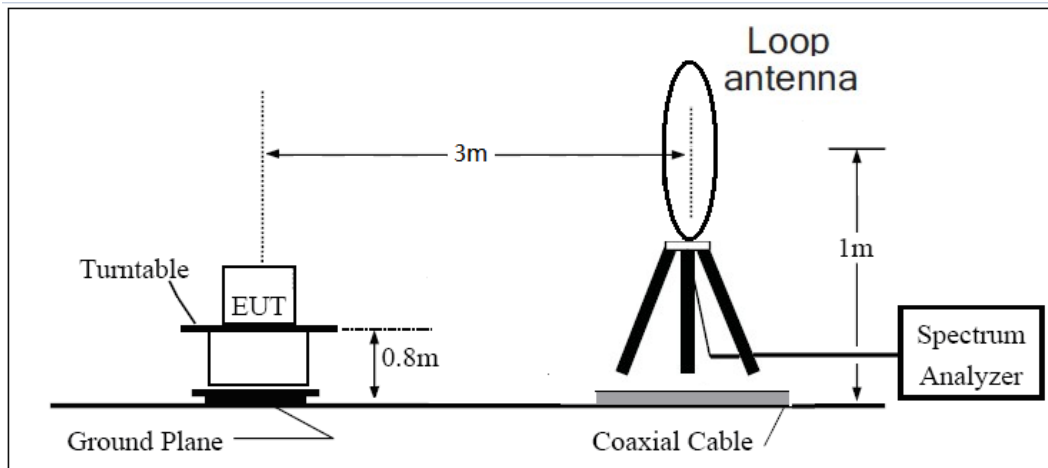

30MHz ~ 1GHz

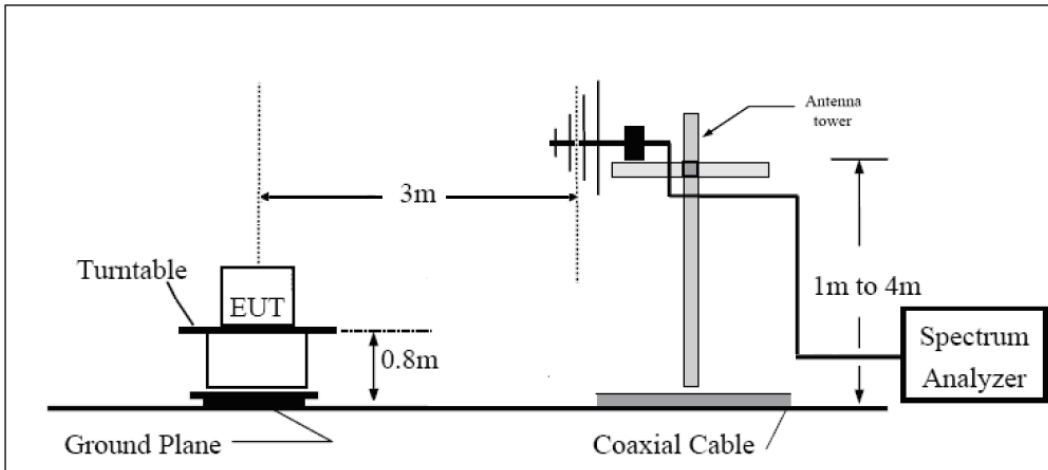

Above 1GHz

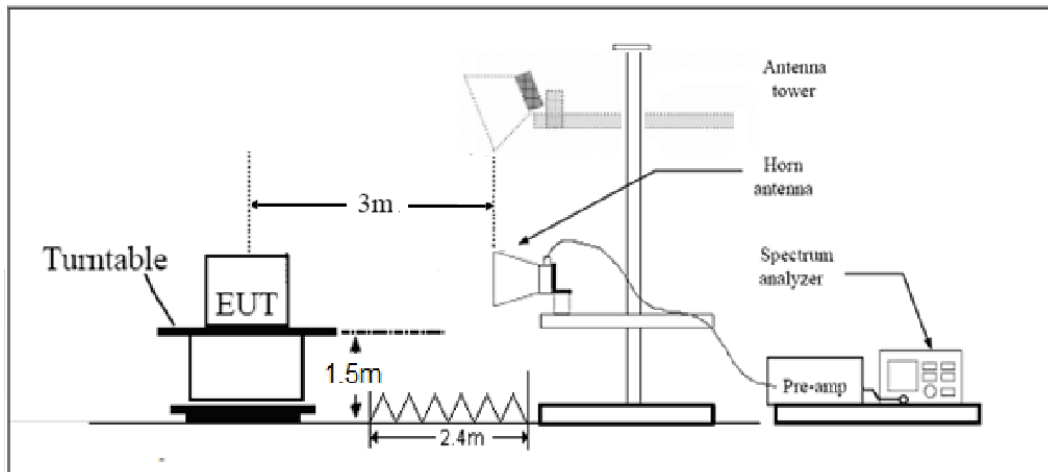

Note: Area side:2.4mX3.6m

Limits

Rule Part 15.247(d) specifies that “In addition, radiated emissions which fall in the restricted bands, as defined in § 15.205(a), must also comply with the radiated emission limits specified in § 15.209(a) (see § 15.205(c)).”

Limit in restricted band

Frequency of emission (MHz)	Field strength(uV/m)	Field strength(dBuV/m)
0.009–0.490	2400/F(kHz)	/
0.490–1.705	24000/F(kHz)	/
1.705–30.0	30	/
30-88	100	40
88-216	150	43.5
216-960	200	46
Above960	500	54

§15.35(b)

There is also a limit on the radio frequency emissions, as measured using instrumentation with a peak detector function, corresponding to 20 dB above the maximum permitted average limit.

Peak Limit=74 dBuV/m

Average Limit=54 dBuV/m

Spurious Radiated Emissions are permitted in any of the frequency bands listed below:

MHz	MHz	MHz	GHz
0.090 - 0.110	16.42 - 16.423	399.9 - 410	4.5 - 5.15
¹ 0.495 - 0.505	16.69475 - 16.69525	608 - 614	5.35 - 5.46
2.1735 - 2.1905	16.80425 - 16.80475	960 - 1240	7.25 - 7.75
4.125 - 4.128	25.5 - 25.67	1300 - 1427	8.025 - 8.5
4.17725 - 4.17775	37.5 - 38.25	1435 - 1626.5	9.0 - 9.2
4.20725 - 4.20775	73 - 74.6	1645.5 - 1646.5	9.3 - 9.5
6.215 - 6.218	74.8 - 75.2	1660 - 1710	10.6 - 12.7
6.26775 - 6.26825	108 - 121.94	1718.8 - 1722.2	13.25 - 13.4
6.31175 - 6.31225	123 - 138	2200 - 2300	14.47 - 14.5
8.291 - 8.294	149.9 - 150.05	2310 - 2390	15.35 - 16.2
8.362 - 8.366	156.52475 - 156.52525	2483.5 - 2500	17.7 - 21.4
8.37625 - 8.38675	156.7 - 156.9	2690 - 2900	22.01 - 23.12
8.41425 - 8.41475	162.0125 - 167.17	3260 - 3267	23.6 - 24.0
12.29 - 12.293	167.72 - 173.2	3332 - 3339	31.2 - 31.8
12.51975 - 12.52025	240 - 285	3345.8 - 3358	36.43 - 36.5
12.57675 - 12.57725	322 - 335.4	3600 - 4400	(²)
13.36 - 13.41			

**Measurement Uncertainty**

The assessed measurement uncertainty to ensure 95% confidence level for the normal distribution is with the coverage factor $k = 1.96$.

Frequency	Uncertainty
9KHz-30MHz	3.55 dB
30MHz-200MHz	4.17 dB
200MHz-1GHz	4.84 dB
1-18GHz	4.35 dB
18-26.5GHz	5.90 dB
26.5GHz~40GHz	5.92 dB



Test Results:

ESP32-S2-MINI-1

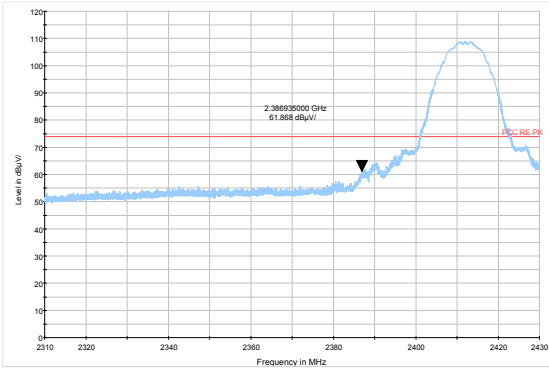

802.11b-Channel 1 Peak

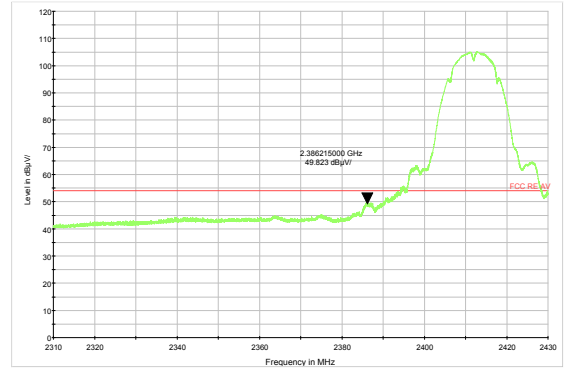

802.11b-Channel 1 Average

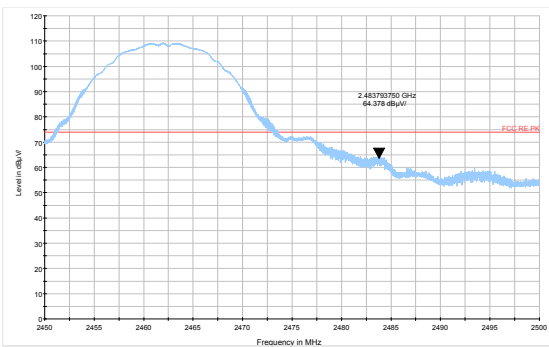

802.11b-Channel 11 Peak

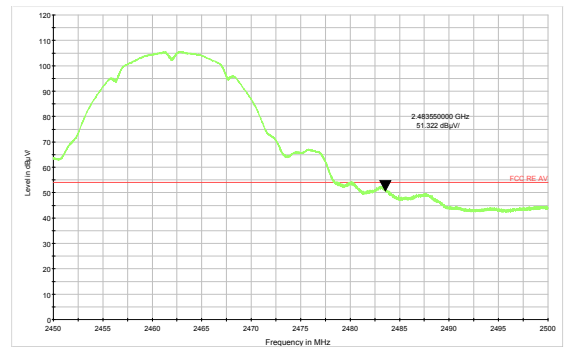

802.11b-Channel 11 Average

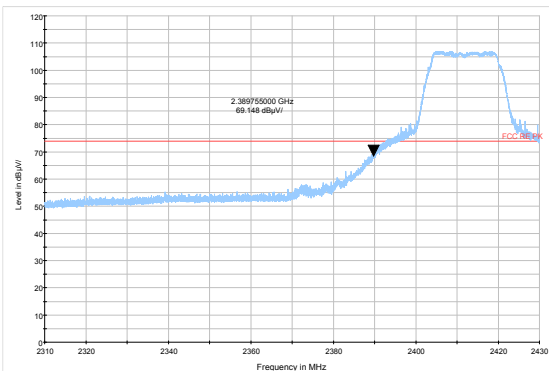

802.11g-Channel 1 Peak

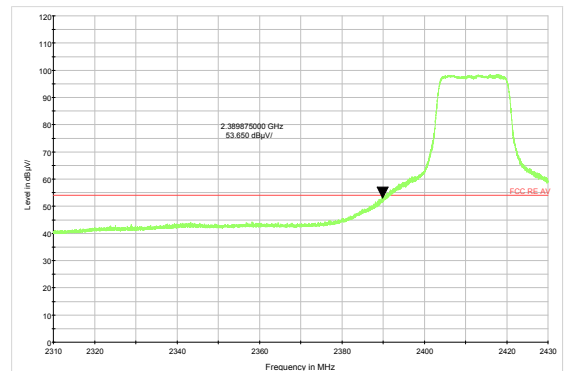

802.11g-Channel 1 Average

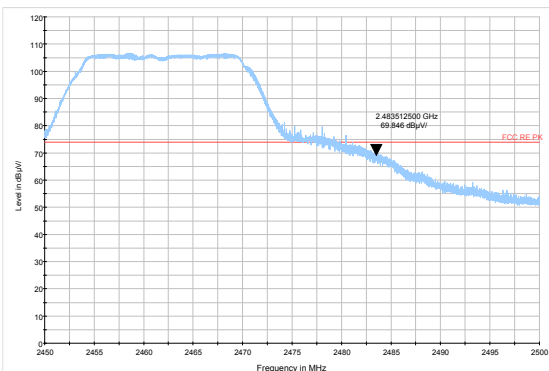

802.11g-Channel 11 Peak

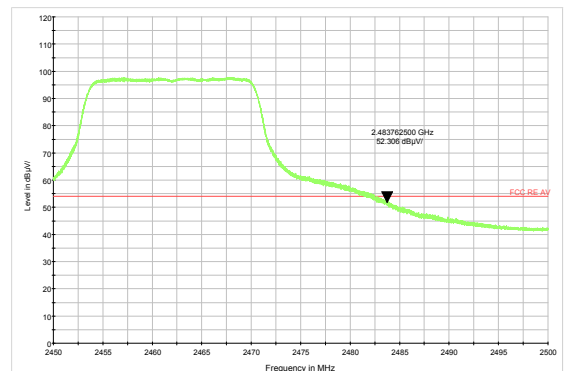

802.11g-Channel 11 Average

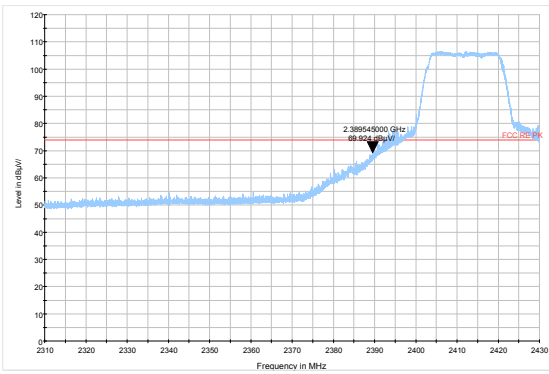

802.11n HT20 -Channel 1 Peak

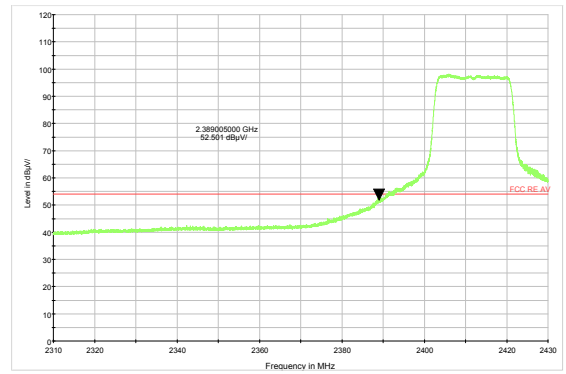

802.11n HT20 -Channel 1 Average

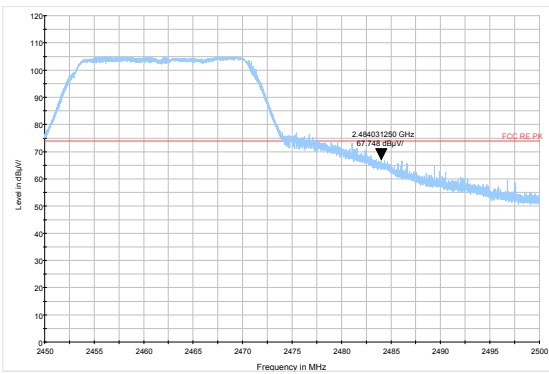

802.11n HT20 -Channel 11 Peak

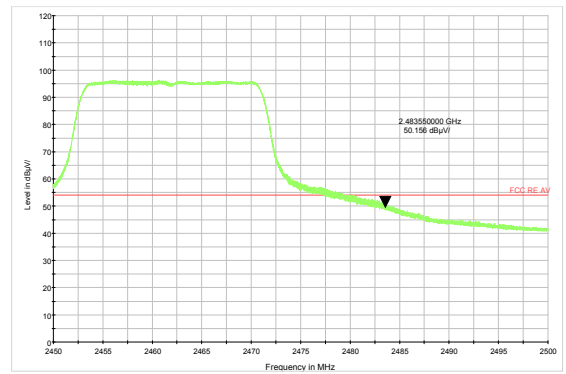

802.11n HT20 -Channel 11 Average

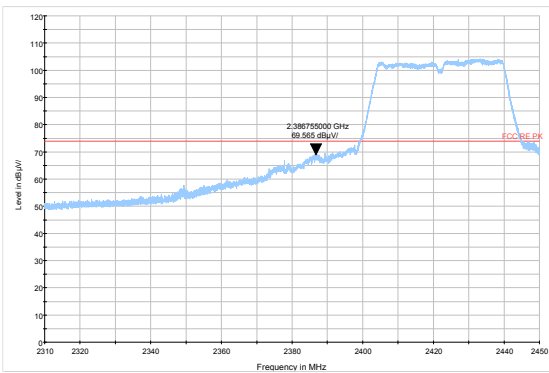

802.11n HT40 -Channel 3 Peak

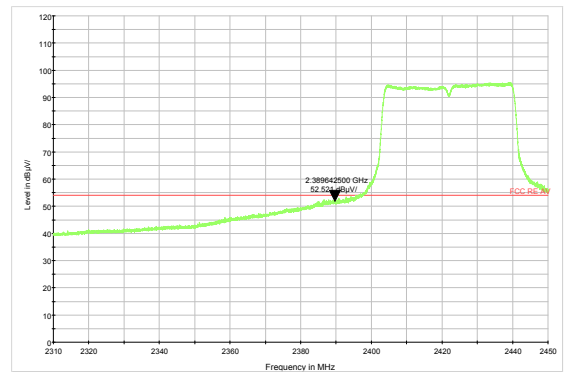

802.11n HT40 -Channel 3 Average

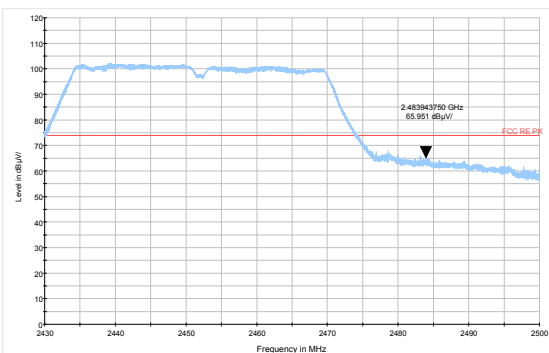

802.11n HT40 -Channel 9 Peak

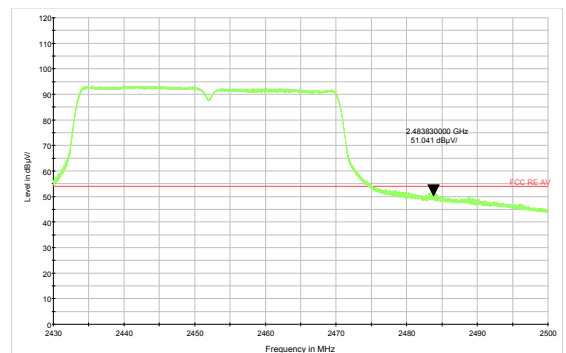

802.11n HT40 -Channel 9 Average



ESP32-S2-MINI-1U

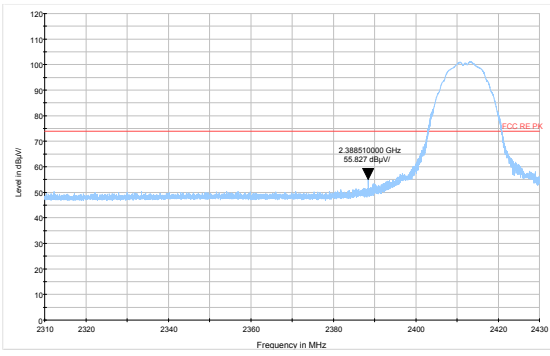

802.11b-Channel 1 Peak

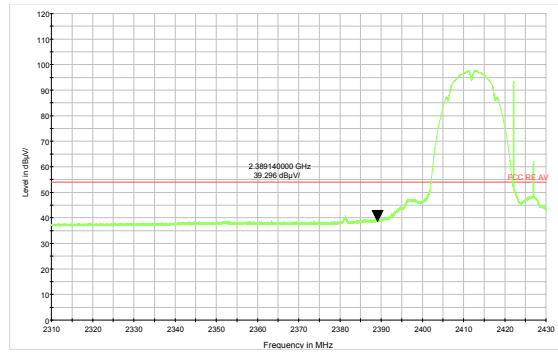

802.11b-Channel 1 Average

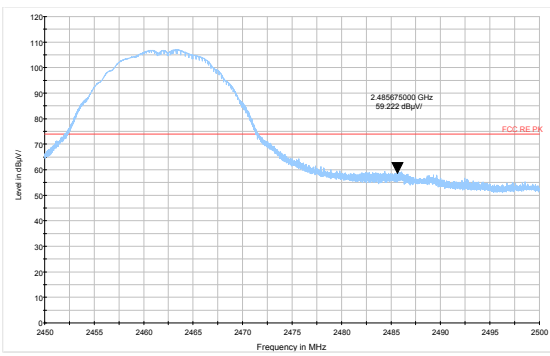

802.11b-Channel 11 Peak

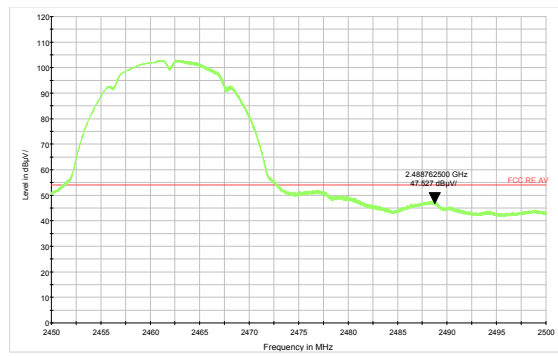

802.11b-Channel 11 Average

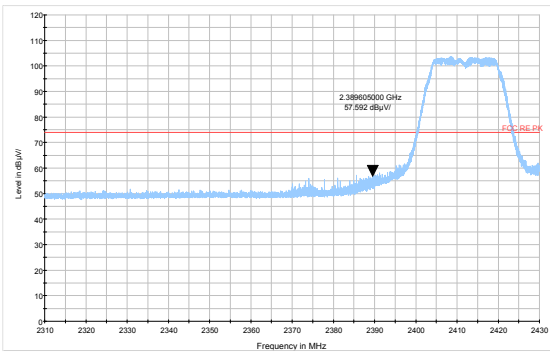

802.11g-Channel 1 Peak

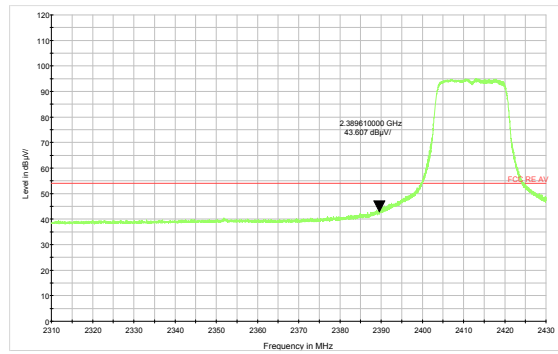

802.11g-Channel 1 Average

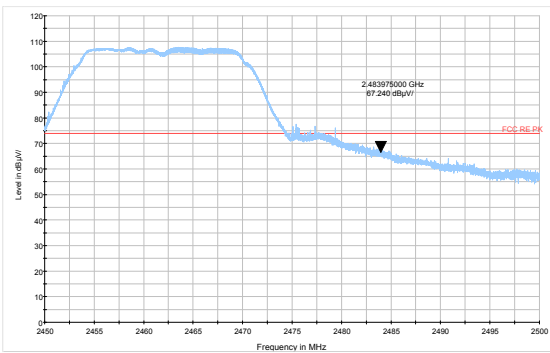

802.11g-Channel 11 Peak

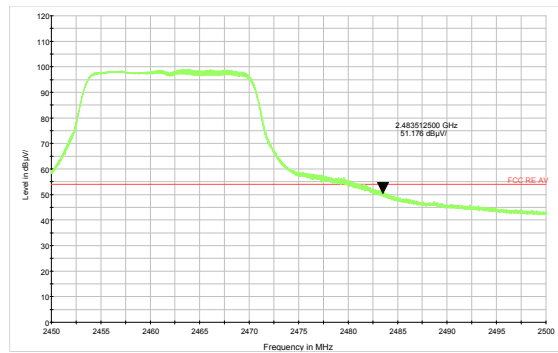

802.11g-Channel 11 Average

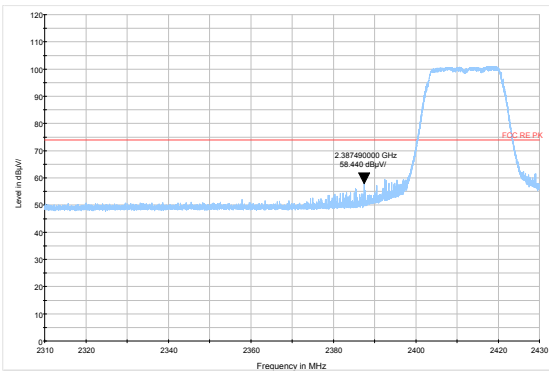

802.11n HT20 -Channel 1 Peak

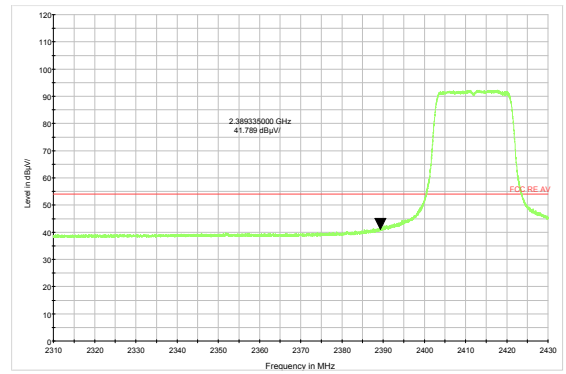

802.11n HT20 -Channel 1 Average

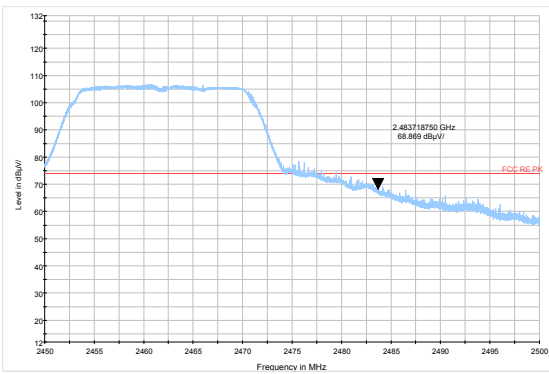

802.11n HT20 -Channel 11 Peak

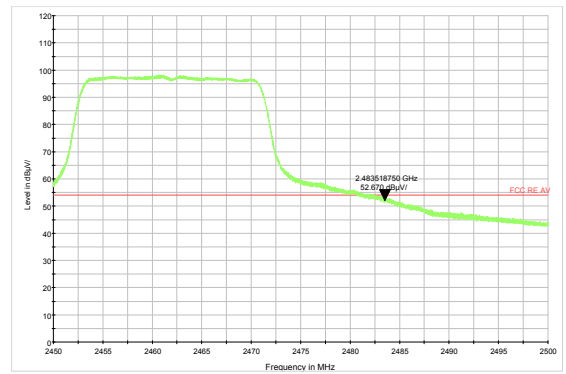

802.11n HT20 -Channel 11 Average

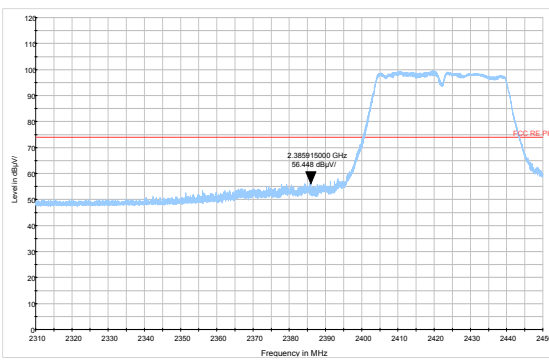

802.11n HT40 -Channel 3 Peak

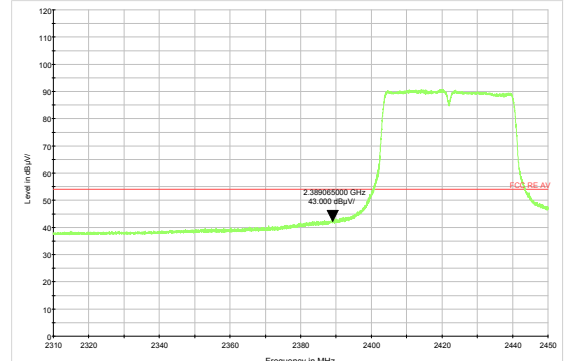

802.11n HT40 -Channel 3 Average

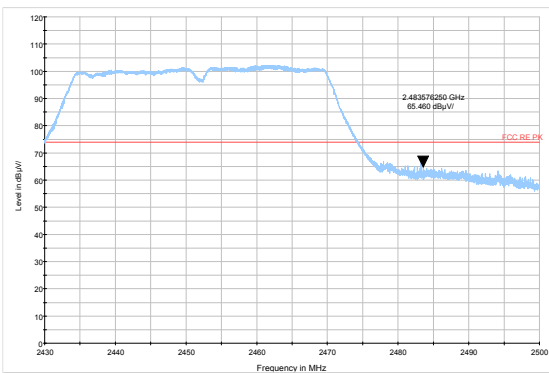

802.11n HT40 -Channel 9 Peak

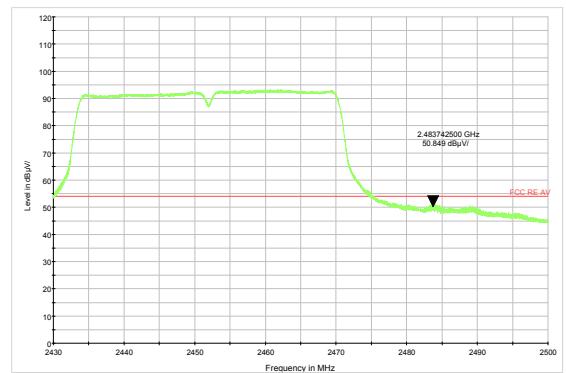

802.11n HT40 -Channel 9 Average

**Result of RE****Test result**

Sweep the whole frequency band through the range from 9kHz to the 10th harmonic of the carrier, the Emissions in the frequency band 9kHz-30MHz and 18GHz-26.5GHz are more than 20dB below the limit are not reported.

The following graphs display the maximum values of horizontal and vertical by software.
For above 1GHz, Blue trace uses the peak detection, Green trace uses the average detection.

During the test, the Radiates Emission from 30MHz to 1GHz was performed in all modes with all channels, 802.11n (HT40), Channel 9 of ESP32-S2-MINI-1 and 802.11n (HT40), Channel 3 of ESP32-S2-MINI-1U are selected as the worst condition. The test data of the worst-case condition was recorded in this report.

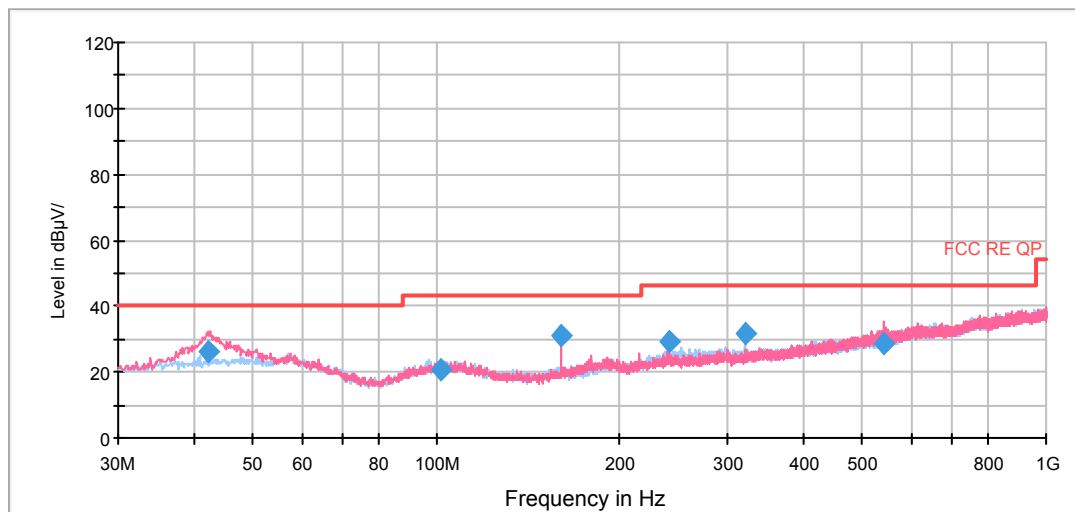
ESP32-S2-MINI-1**Continuous TX mode:**

Radiates Emission from 30MHz to 1GHz

Frequency (MHz)	Quasi-Peak (dBuV/m)	Height (cm)	Polarization	Azimuth (deg)	Correct Factor (dB)	Margin (dB)	Limit (dBuV/m)
42.088750	26.0	125.0	V	59.0	14.4	14.0	40.0
101.288750	20.5	125.0	H	327.0	13.6	23.0	43.5
159.980000	30.8	100.0	V	100.0	10.4	12.7	43.5
240.005000	29.0	118.0	H	270.0	14.5	17.0	46.0
319.990000	31.8	111.0	H	144.0	16.2	14.2	46.0
541.675000	28.7	100.0	V	39.0	21.0	17.3	46.0

Remark: 1. Correction Factor = Antenna factor+ Insertion loss(cable loss+amplifier gain)

2. Margin = Limit – Quasi-Peak

802.11b CH1

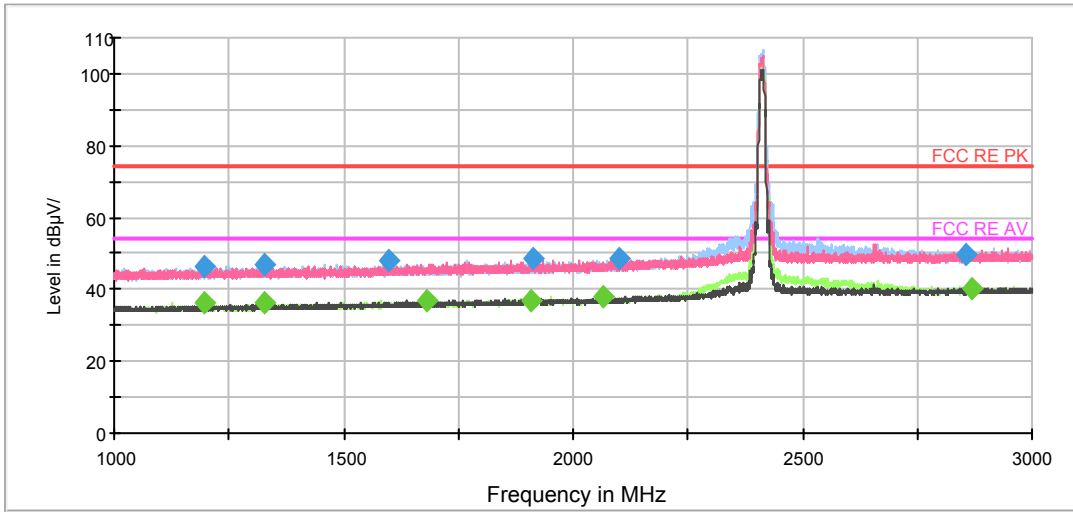

Note: The signal beyond the limit is carrier.
Radiates Emission from 1GHz to 3GHz

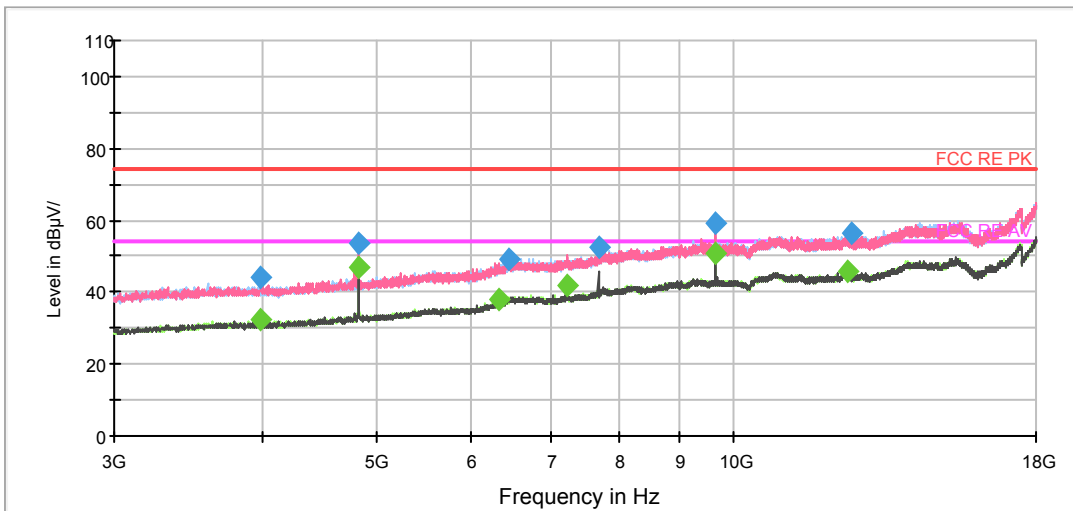

Radiates Emission from 3GHz to 18GHz



Frequency (MHz)	Peak (dBuV/m)	Height (cm)	Polarization	Azimuth (deg)	Correct Factor (dB)	Margin (dB)	Limit (dBuV/m)
1195.250000	46.1	200.0	V	255.0	-1.2	27.9	74.0
1327.750000	47.2	200.0	V	350.0	-0.9	26.8	74.0
1599.500000	47.8	100.0	H	334.0	0.0	26.2	74.0
1914.500000	48.5	100.0	V	166.0	0.9	25.5	74.0
2100.250000	48.7	200.0	H	0.0	1.7	25.3	74.0
2855.500000	49.6	100.0	H	358.0	4.4	24.4	74.0

Remark: 1. Correction Factor = Antenna factor+ Insertion loss (cable loss + amplifier gain)

Frequency (MHz)	Average (dBuV/m)	Height (cm)	Polarization	Azimuth (deg)	Correct Factor (dB)	Margin (dB)	Limit (dBuV/m)
1194.750000	36.5	100.0	V	98.0	-1.2	17.5	54.0
1327.750000	36.2	200.0	V	350.0	-0.9	17.8	54.0
1679.500000	36.8	200.0	V	353.0	0.3	17.2	54.0
1907.750000	37.0	100.0	H	201.0	0.9	17.0	54.0
2066.750000	37.8	100.0	H	151.0	1.5	16.2	54.0
2868.500000	40.1	100.0	H	0.0	4.4	13.9	54.0

Remark: 1. Correction Factor = Antenna factor+ Insertion loss (cable loss + amplifier gain)

802.11b CH6

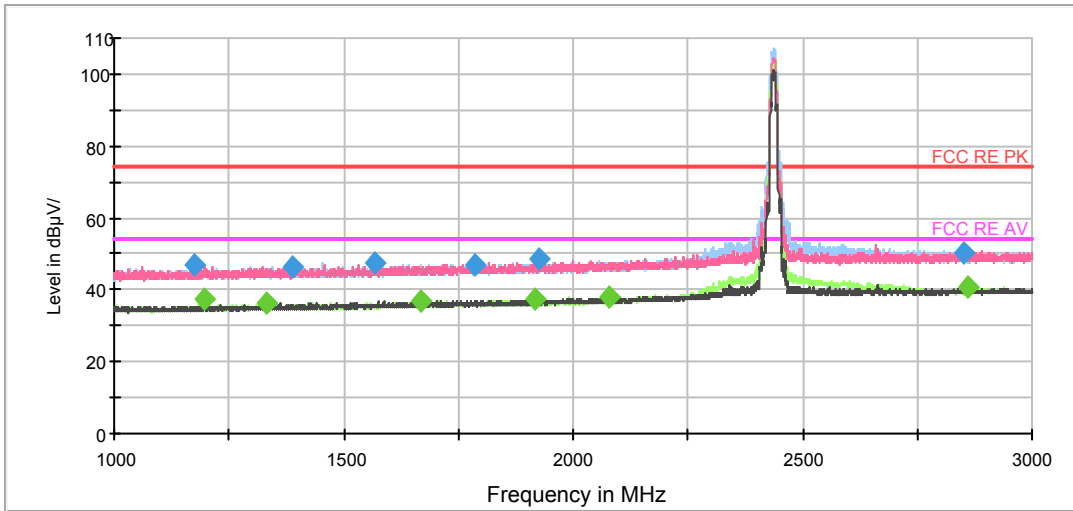

Note: The signal beyond the limit is carrier.
Radiates Emission from 1GHz to 3GHz

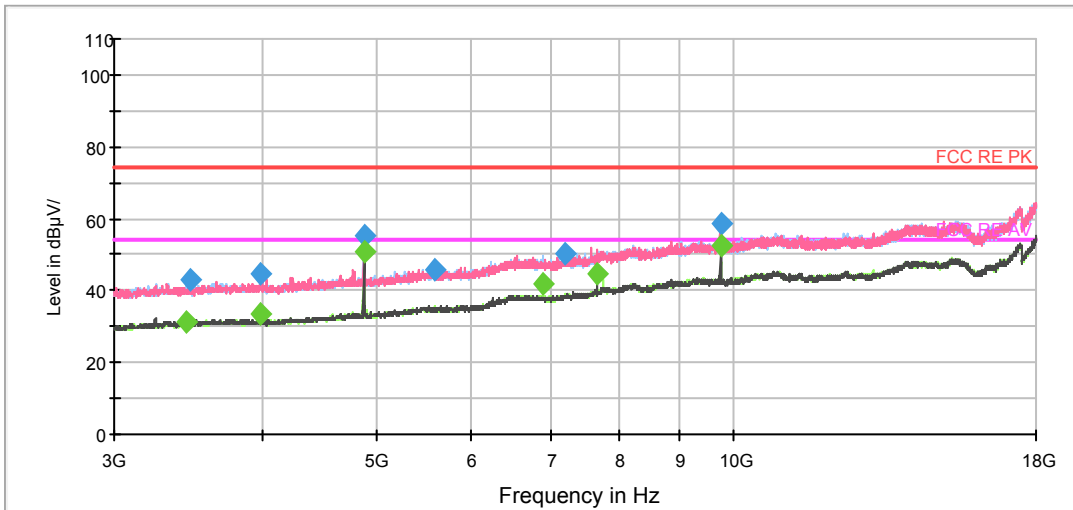

Radiates Emission from 3GHz to 18GHz



Frequency (MHz)	Peak (dBuV/m)	Height (cm)	Polarization	Azimuth (deg)	Correct Factor (dB)	Margin (dB)	Limit (dBuV/m)
1176.750000	46.9	100.0	H	182.0	-1.3	27.1	74.0
1389.750000	46.6	100.0	V	0.0	-0.7	27.4	74.0
1566.750000	47.4	200.0	H	91.0	-0.1	26.6	74.0
1786.500000	46.9	100.0	V	50.0	0.6	27.1	74.0
1925.750000	48.4	200.0	H	33.0	1.0	25.6	74.0
2850.000000	50.1	200.0	H	0.0	4.4	23.9	74.0

Remark: 1. Correction Factor = Antenna factor+ Insertion loss (cable loss + amplifier gain)

Frequency (MHz)	Average (dBuV/m)	Height (cm)	Polarization	Azimuth (deg)	Correct Factor (dB)	Margin (dB)	Limit (dBuV/m)
1196.000000	37.6	100.0	V	267.0	-1.2	16.4	54.0
1332.000000	36.3	200.0	V	79.0	-0.9	17.7	54.0
1666.250000	37.0	200.0	V	212.0	0.2	17.0	54.0
1916.000000	37.2	100.0	H	312.0	1.0	16.8	54.0
2079.250000	37.8	200.0	H	315.0	1.5	16.2	54.0
2860.500000	40.5	200.0	V	202.0	4.4	13.5	54.0

Remark: 1. Correction Factor = Antenna factor+ Insertion loss (cable loss + amplifier gain)

802.11b CH11

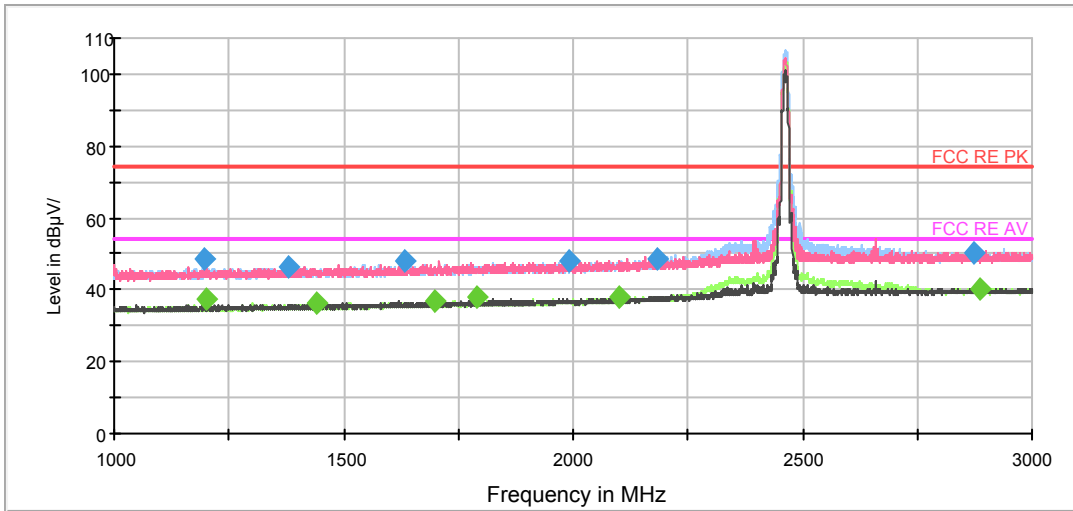

Note: The signal beyond the limit is carrier.
Radiates Emission from 1GHz to 3GHz

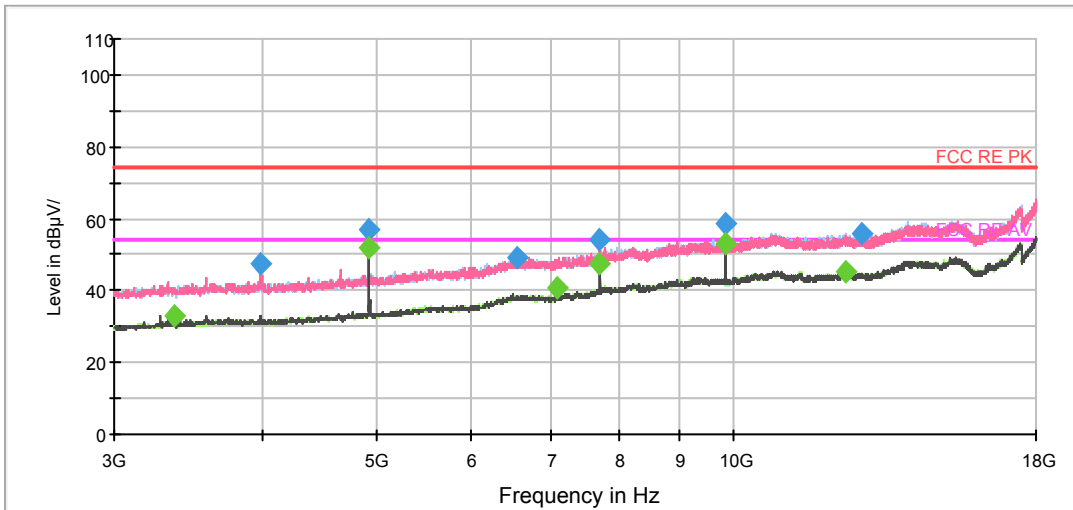

Radiates Emission from 3GHz to 18GHz



Frequency (MHz)	Peak (dBuV/m)	Height (cm)	Polarization	Azimuth (deg)	Correct Factor (dB)	Margin (dB)	Limit (dBuV/m)
1196.750000	48.4	100.0	V	0.0	-1.2	25.6	74.0
1380.000000	46.4	100.0	H	249.0	-0.7	27.6	74.0
1635.250000	47.9	100.0	V	8.0	0.1	26.1	74.0
1993.000000	48.1	100.0	V	51.0	1.1	25.9	74.0
2183.750000	48.8	200.0	H	113.0	2.1	25.2	74.0
2875.000000	50.0	200.0	V	354.0	4.5	24.0	74.0

Remark: 1. Correction Factor = Antenna factor+ Insertion loss (cable loss + amplifier gain)

Frequency (MHz)	Average (dBuV/m)	Height (cm)	Polarization	Azimuth (deg)	Correct Factor (dB)	Margin (dB)	Limit (dBuV/m)
1198.750000	37.7	100.0	V	0.0	-1.2	16.3	54.0
1441.750000	36.4	200.0	H	304.0	-0.6	17.6	54.0
1698.750000	36.7	100.0	H	338.0	0.4	17.3	54.0
1791.500000	37.7	100.0	V	24.0	0.6	16.3	54.0
2099.750000	37.9	100.0	V	109.0	1.7	16.1	54.0
2887.000000	40.0	200.0	H	9.0	4.5	14.0	54.0

Remark: 1. Correction Factor = Antenna factor+ Insertion loss (cable loss + amplifier gain)

802.11g CH1

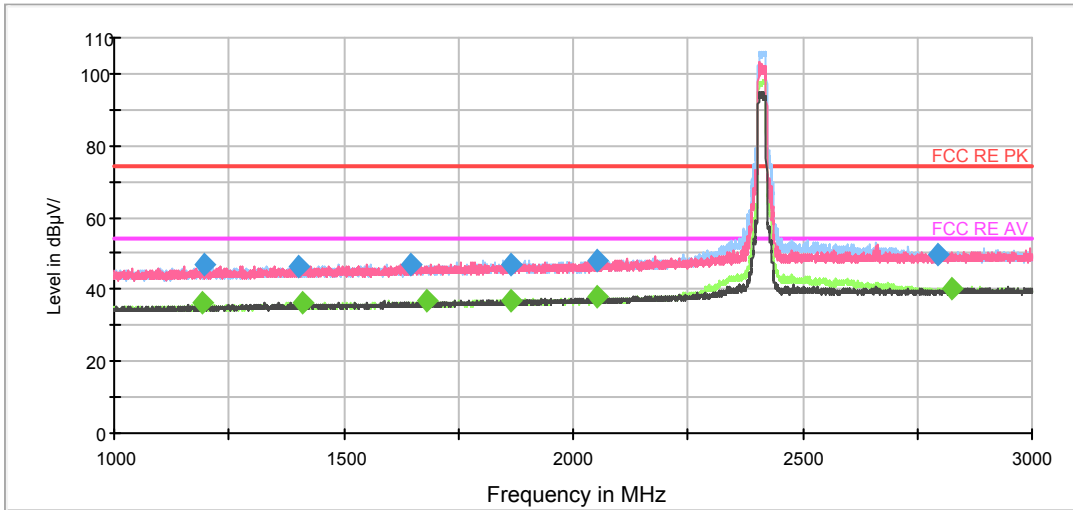

Note: The signal beyond the limit is carrier.
Radiates Emission from 1GHz to 3GHz

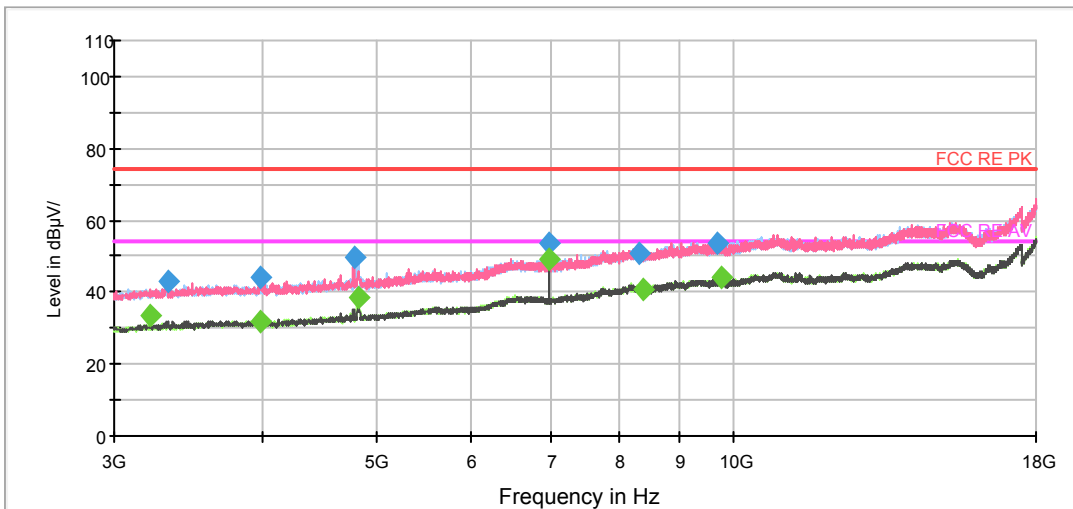

Radiates Emission from 3GHz to 18GHz



Frequency (MHz)	Peak (dBuV/m)	Height (cm)	Polarization	Azimuth (deg)	Correct Factor (dB)	Margin (dB)	Limit (dBuV/m)
1196.000000	46.9	100.0	H	298.0	-1.2	27.1	74.0
1402.000000	46.6	100.0	V	166.0	-0.7	27.4	74.0
1644.250000	47.1	100.0	V	186.0	0.2	26.9	74.0
1862.750000	46.9	200.0	V	359.0	0.8	27.1	74.0
2050.500000	48.3	100.0	V	352.0	1.4	25.7	74.0
2795.750000	49.7	200.0	H	88.0	4.3	24.3	74.0

Remark: 1. Correction Factor = Antenna factor+ Insertion loss (cable loss + amplifier gain)

Frequency (MHz)	Average (dBuV/m)	Height (cm)	Polarization	Azimuth (deg)	Correct Factor (dB)	Margin (dB)	Limit (dBuV/m)
1191.000000	36.3	200.0	V	342.0	-1.2	17.7	54.0
1409.500000	36.4	100.0	V	127.0	-0.7	17.6	54.0
1681.500000	37.0	100.0	V	1.0	0.3	17.0	54.0
1864.750000	36.6	100.0	H	182.0	0.8	17.4	54.0
2050.500000	37.9	100.0	H	269.0	1.4	16.1	54.0
2825.750000	40.4	200.0	H	15.0	4.4	13.6	54.0

Remark: 1. Correction Factor = Antenna factor+ Insertion loss (cable loss + amplifier gain)



802.11g CH6

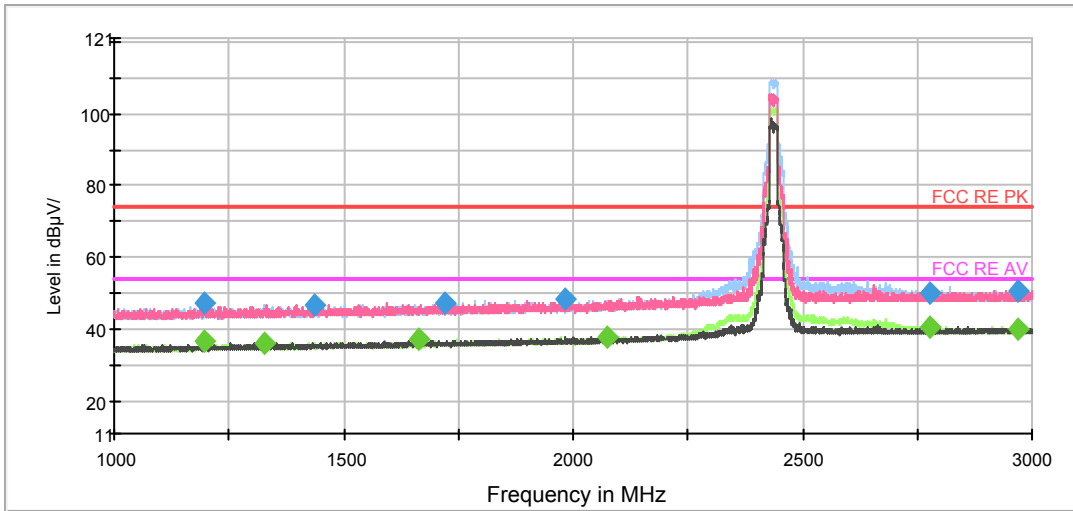

Note: The signal beyond the limit is carrier.
Radiates Emission from 1GHz to 3GHz

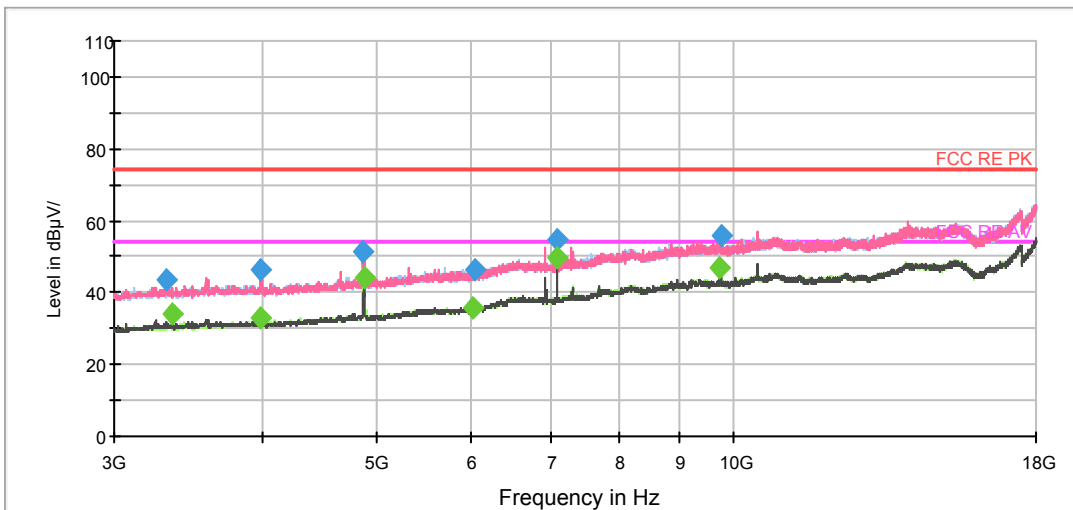

Radiates Emission from 3GHz to 18GHz



Frequency (MHz)	Peak (dBuV/m)	Height (cm)	Polarization	Azimuth (deg)	Correct Factor (dB)	Margin (dB)	Limit (dBuV/m)
1195.000000	47.1	100.0	V	79.0	-1.2	26.9	74.0
1436.250000	46.9	200.0	V	354.0	-0.6	27.1	74.0
1720.000000	47.2	100.0	H	354.0	0.4	26.8	74.0
1980.750000	48.2	100.0	V	128.0	1.1	25.8	74.0
2776.000000	50.2	100.0	V	1.0	4.2	23.8	74.0
2968.500000	50.4	200.0	V	249.0	4.7	23.6	74.0

Remark: 1. Correction Factor = Antenna factor+ Insertion loss (cable loss + amplifier gain)

Frequency (MHz)	Average (dBuV/m)	Height (cm)	Polarization	Azimuth (deg)	Correct Factor (dB)	Margin (dB)	Limit (dBuV/m)
1197.000000	36.9	100.0	V	79.0	-1.2	17.1	54.0
1329.500000	36.4	100.0	V	157.0	-0.9	17.6	54.0
1663.500000	37.0	100.0	V	2.0	0.2	17.0	54.0
2075.750000	37.8	200.0	H	122.0	1.5	16.2	54.0
2777.750000	40.4	100.0	H	297.0	4.2	13.6	54.0
2970.750000	39.9	200.0	V	0.0	4.7	14.1	54.0

Remark: 1. Correction Factor = Antenna factor+ Insertion loss (cable loss + amplifier gain)

802.11g CH11

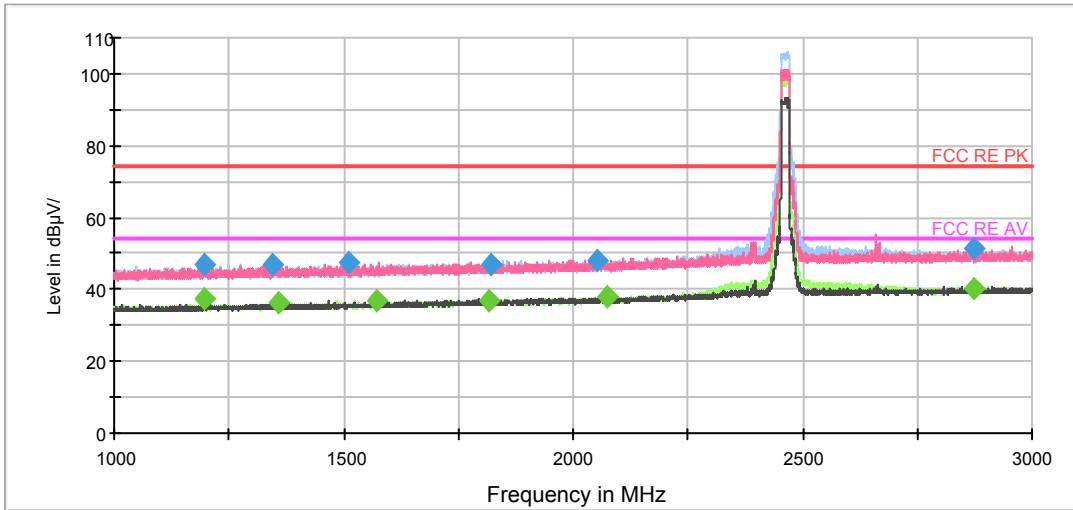

Note: The signal beyond the limit is carrier.
Radiates Emission from 1GHz to 3GHz

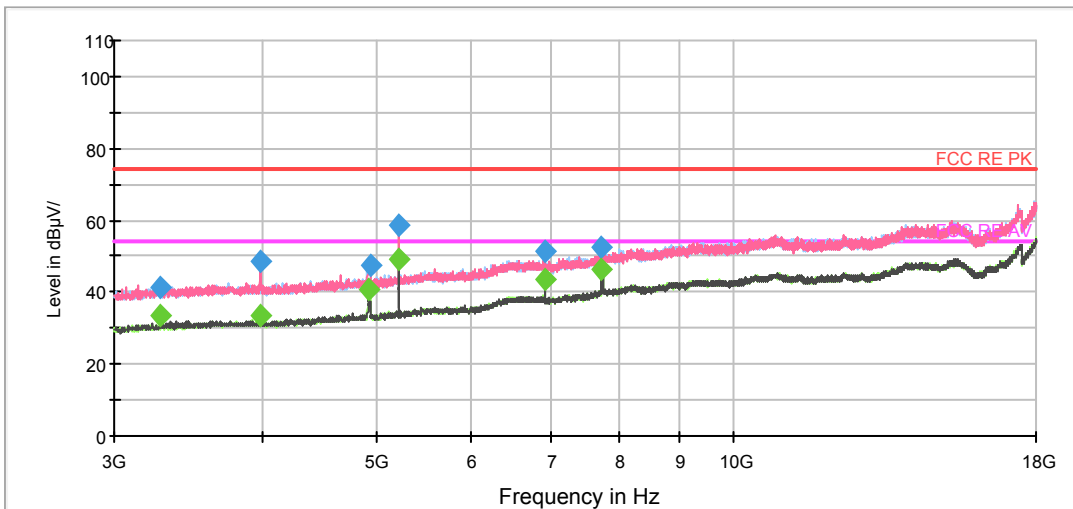

Radiates Emission from 3GHz to 18GHz



Frequency (MHz)	Peak (dBuV/m)	Height (cm)	Polarization	Azimuth (deg)	Correct Factor (dB)	Margin (dB)	Limit (dBuV/m)
1195.500000	46.9	200.0	V	314.0	-1.2	27.1	74.0
1344.250000	46.9	100.0	V	60.0	-0.9	27.1	74.0
1509.000000	47.3	100.0	H	357.0	-0.4	26.7	74.0
1819.000000	46.7	200.0	V	324.0	0.7	27.3	74.0
2054.000000	48.2	200.0	H	12.0	1.4	25.8	74.0
2871.250000	51.3	200.0	H	8.0	4.4	22.7	74.0

Remark: 1. Correction Factor = Antenna factor+ Insertion loss (cable loss + amplifier gain)

Frequency (MHz)	Average (dBuV/m)	Height (cm)	Polarization	Azimuth (deg)	Correct Factor (dB)	Margin (dB)	Limit (dBuV/m)
1195.500000	37.2	200.0	V	314.0	-1.2	16.8	54.0
1356.750000	36.6	100.0	H	354.0	-0.9	17.4	54.0
1572.250000	36.8	200.0	H	100.0	-0.1	17.2	54.0
1817.500000	37.1	200.0	V	112.0	0.7	16.9	54.0
2075.250000	37.9	100.0	V	89.0	1.5	16.1	54.0
2871.500000	40.1	200.0	V	340.0	4.4	13.9	54.0

Remark: 1. Correction Factor = Antenna factor+ Insertion loss (cable loss + amplifier gain)

802.11n (HT20) CH1

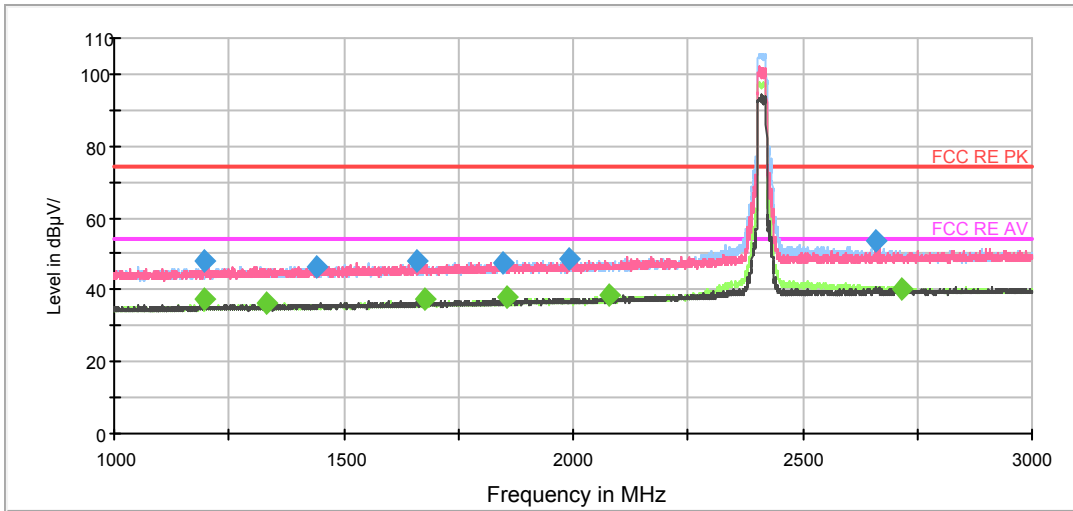

Note: The signal beyond the limit is carrier.
Radiates Emission from 1GHz to 3GHz

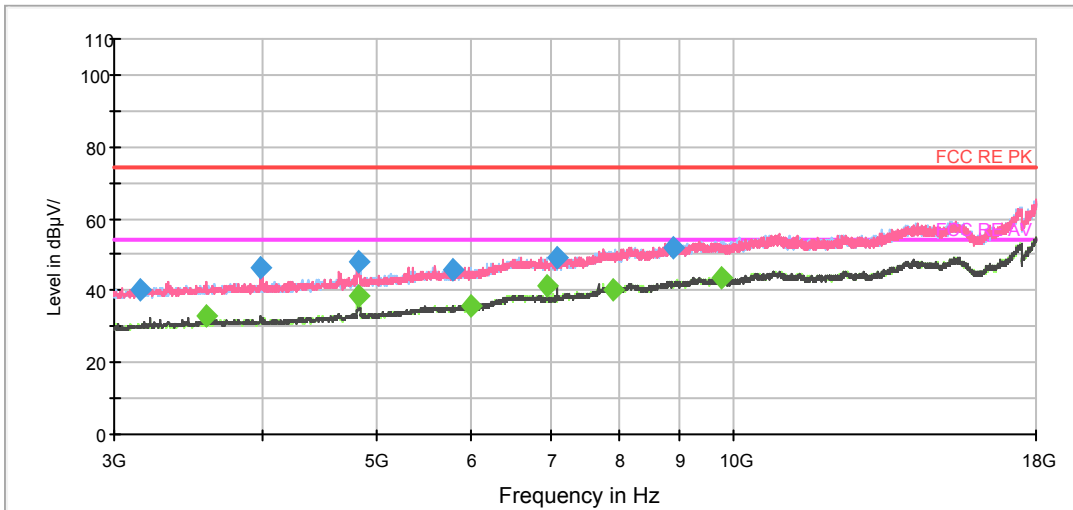

Radiates Emission from 3GHz to 18GHz



Frequency (MHz)	Peak (dBuV/m)	Height (cm)	Polarization	Azimuth (deg)	Correct Factor (dB)	Margin (dB)	Limit (dBuV/m)
1195.250000	47.9	200.0	V	132.0	-1.2	26.1	74.0
1440.250000	46.6	100.0	H	348.0	-0.6	27.4	74.0
1660.000000	48.0	100.0	V	219.0	0.2	26.0	74.0
1845.250000	47.4	200.0	H	9.0	0.7	26.6	74.0
1991.250000	48.6	200.0	V	351.0	1.1	25.4	74.0
2658.750000	53.4	100.0	V	229.0	3.9	20.6	74.0

Remark: 1. Correction Factor = Antenna factor+ Insertion loss (cable loss + amplifier gain)

Frequency (MHz)	Average (dBuV/m)	Height (cm)	Polarization	Azimuth (deg)	Correct Factor (dB)	Margin (dB)	Limit (dBuV/m)
1196.750000	37.6	100.0	V	260.0	-1.2	16.4	54.0
1330.750000	36.2	200.0	V	348.0	-0.9	17.8	54.0
1678.000000	37.4	100.0	V	43.0	0.3	16.6	54.0
1857.500000	37.9	100.0	V	199.0	0.8	16.1	54.0
2077.500000	38.3	100.0	H	356.0	1.5	15.7	54.0
2718.000000	40.2	100.0	H	292.0	4.1	13.8	54.0

Remark: 1. Correction Factor = Antenna factor+ Insertion loss (cable loss + amplifier gain)

802.11n (HT20) CH6

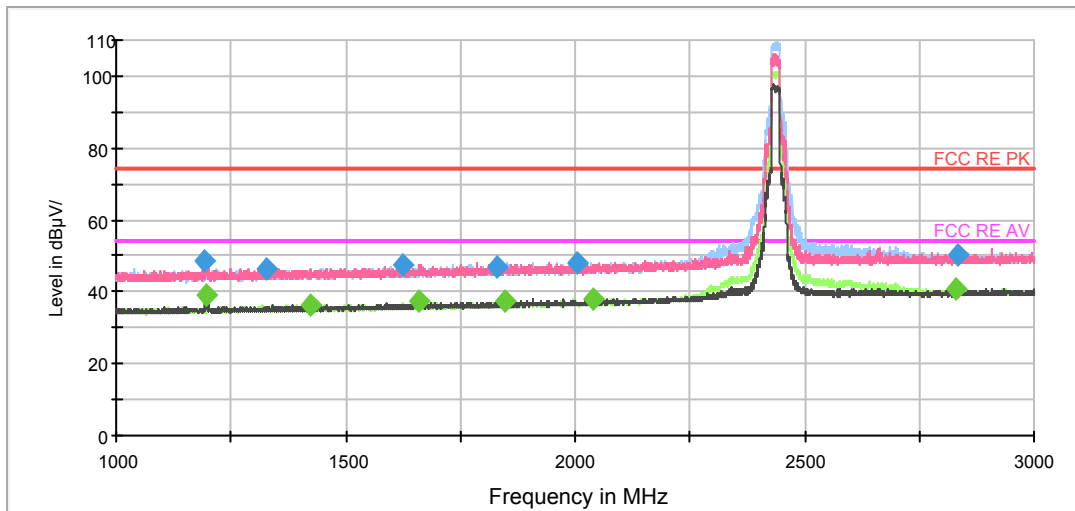

Note: The signal beyond the limit is carrier.
Radiates Emission from 1GHz to 3GHz

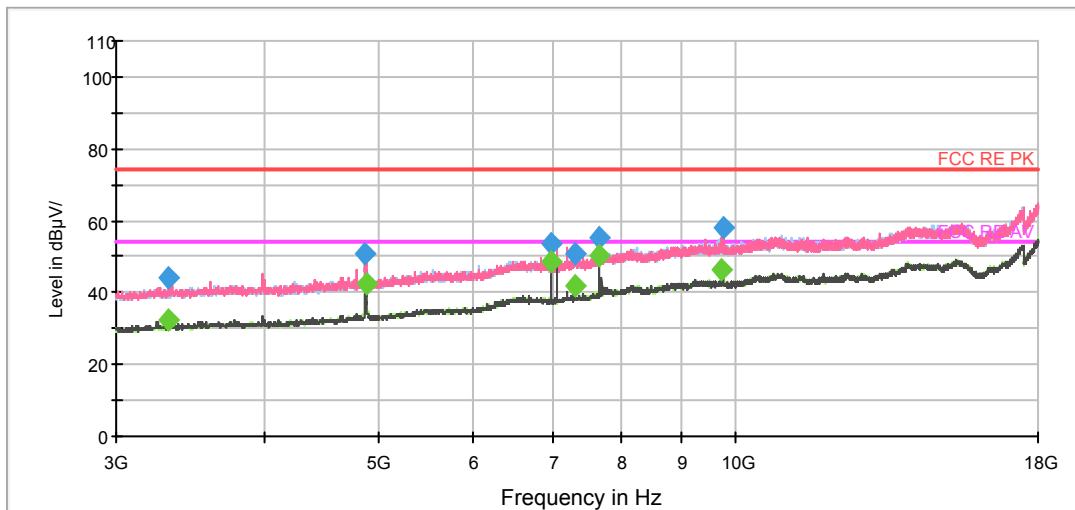

Radiates Emission from 3GHz to 18GHz



Frequency (MHz)	Peak (dBuV/m)	Height (cm)	Polarization	Azimuth (deg)	Correct Factor (dB)	Margin (dB)	Limit (dBuV/m)
1194.250000	48.8	100.0	V	0.0	-1.2	25.2	74.0
1328.000000	46.6	200.0	V	336.0	-0.9	27.4	74.0
1622.500000	47.5	200.0	H	272.0	0.1	26.5	74.0
1828.250000	46.8	200.0	V	222.0	0.7	27.2	74.0
2005.000000	48.2	200.0	V	309.0	1.1	25.8	74.0
2833.000000	50.0	200.0	H	2.0	4.4	24.0	74.0

Remark: 1. Correction Factor = Antenna factor+ Insertion loss (cable loss + amplifier gain)

Frequency (MHz)	Average (dBuV/m)	Height (cm)	Polarization	Azimuth (deg)	Correct Factor (dB)	Margin (dB)	Limit (dBuV/m)
1198.250000	39.0	100.0	V	0.0	-1.2	15.0	54.0
1425.750000	36.3	100.0	H	312.0	-0.6	17.7	54.0
1660.000000	37.5	200.0	V	222.0	0.2	16.5	54.0
1845.250000	37.4	100.0	V	191.0	0.7	16.6	54.0
2040.000000	37.9	200.0	H	0.0	1.3	16.1	54.0
2831.750000	40.6	200.0	V	261.0	4.4	13.4	54.0

Remark: 1. Correction Factor = Antenna factor+ Insertion loss (cable loss + amplifier gain)

802.11n (HT20) CH11

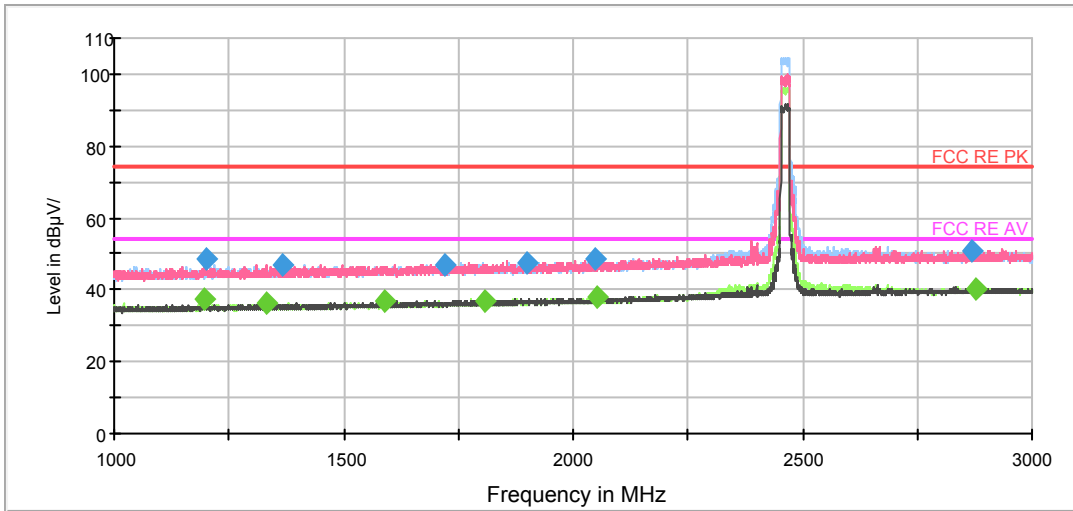

Note: The signal beyond the limit is carrier.
Radiates Emission from 1GHz to 3GHz

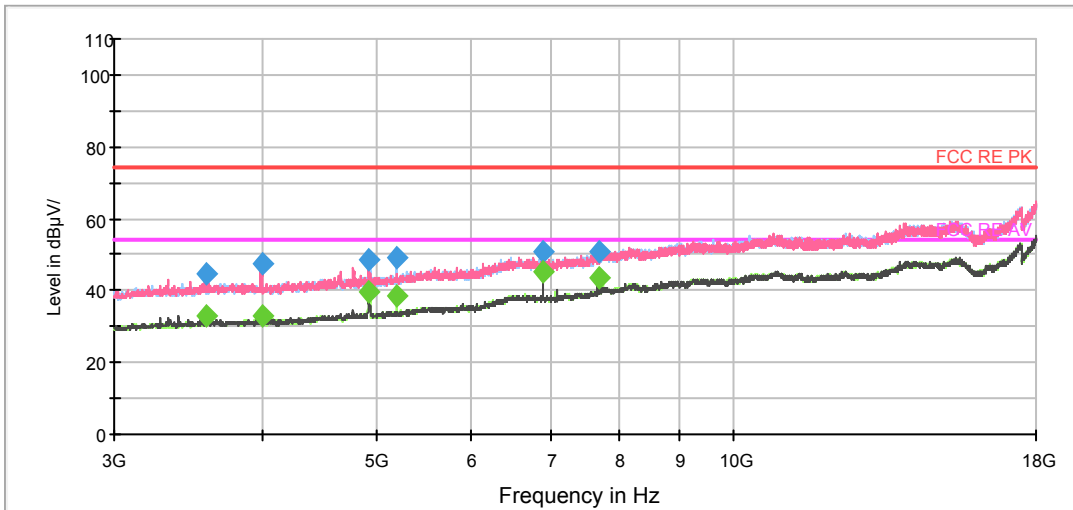

Radiates Emission from 3GHz to 18GHz



Frequency (MHz)	Peak (dBuV/m)	Height (cm)	Polarization	Azimuth (deg)	Correct Factor (dB)	Margin (dB)	Limit (dBuV/m)
1199.500000	48.3	200.0	V	358.0	-1.2	25.7	74.0
1368.750000	46.9	200.0	H	0.0	-0.8	27.1	74.0
1719.000000	47.1	100.0	H	354.0	0.4	26.9	74.0
1901.250000	47.5	100.0	H	341.0	0.9	26.5	74.0
2047.500000	48.4	100.0	H	171.0	1.4	25.6	74.0
2868.500000	50.7	100.0	H	298.0	4.4	23.3	74.0

Remark: 1. Correction Factor = Antenna factor+ Insertion loss (cable loss + amplifier gain)

Frequency (MHz)	Average (dBuV/m)	Height (cm)	Polarization	Azimuth (deg)	Correct Factor (dB)	Margin (dB)	Limit (dBuV/m)
1197.750000	37.7	200.0	V	358.0	-1.2	16.3	54.0
1332.250000	36.4	200.0	V	346.0	-0.9	17.6	54.0
1587.500000	36.9	200.0	V	355.0	-0.1	17.1	54.0
1808.750000	36.8	200.0	H	4.0	0.7	17.2	54.0
2050.250000	37.9	200.0	H	130.0	1.4	16.1	54.0
2877.500000	39.9	200.0	H	5.0	4.5	14.1	54.0

Remark: 1. Correction Factor = Antenna factor+ Insertion loss (cable loss + amplifier gain)

802.11n (HT40) CH3

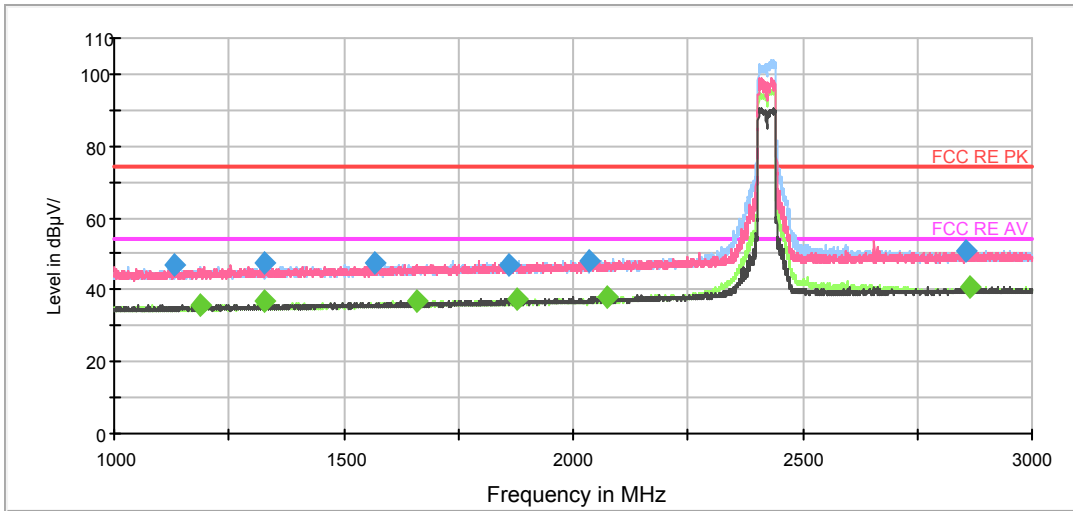

Note: The signal beyond the limit is carrier.
Radiates Emission from 1GHz to 3GHz

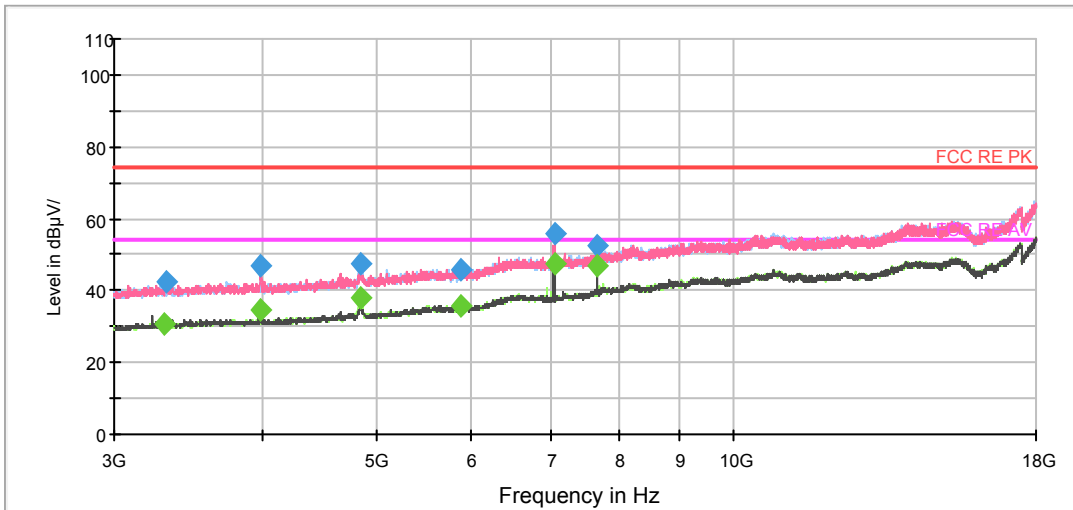

Radiates Emission from 3GHz to 18GHz



Frequency (MHz)	Peak (dBuV/m)	Height (cm)	Polarization	Azimuth (deg)	Correct Factor (dB)	Margin (dB)	Limit (dBuV/m)
1132.750000	46.9	100.0	V	167.0	-1.3	27.1	74.0
1328.250000	47.3	200.0	V	348.0	-0.9	26.7	74.0
1568.250000	47.4	200.0	H	207.0	-0.1	26.6	74.0
1860.500000	46.7	200.0	H	3.0	0.8	27.3	74.0
2035.500000	48.3	200.0	V	335.0	1.3	25.7	74.0
2855.250000	50.6	100.0	V	206.0	4.4	23.4	74.0

Remark: 1. Correction Factor = Antenna factor+ Insertion loss (cable loss + amplifier gain)

Frequency (MHz)	Average (dBuV/m)	Height (cm)	Polarization	Azimuth (deg)	Correct Factor (dB)	Margin (dB)	Limit (dBuV/m)
1186.750000	35.8	100.0	H	350.0	-1.3	18.2	54.0
1328.250000	37.0	200.0	V	348.0	-0.9	17.0	54.0
1658.250000	37.1	100.0	V	1.0	0.2	16.9	54.0
1879.750000	37.2	100.0	V	3.0	0.8	16.8	54.0
2075.500000	38.2	200.0	H	7.0	1.5	15.8	54.0
2863.500000	40.6	200.0	H	59.0	4.4	13.4	54.0

Remark: 1. Correction Factor = Antenna factor+ Insertion loss (cable loss + amplifier gain)

802.11n (HT40) CH6

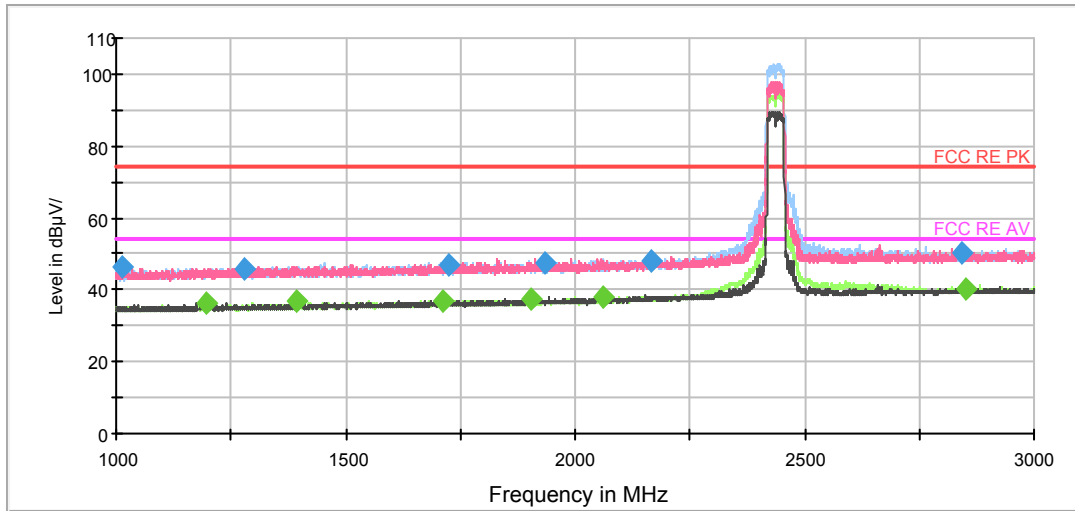

Note: The signal beyond the limit is carrier.
Radiates Emission from 1GHz to 3GHz

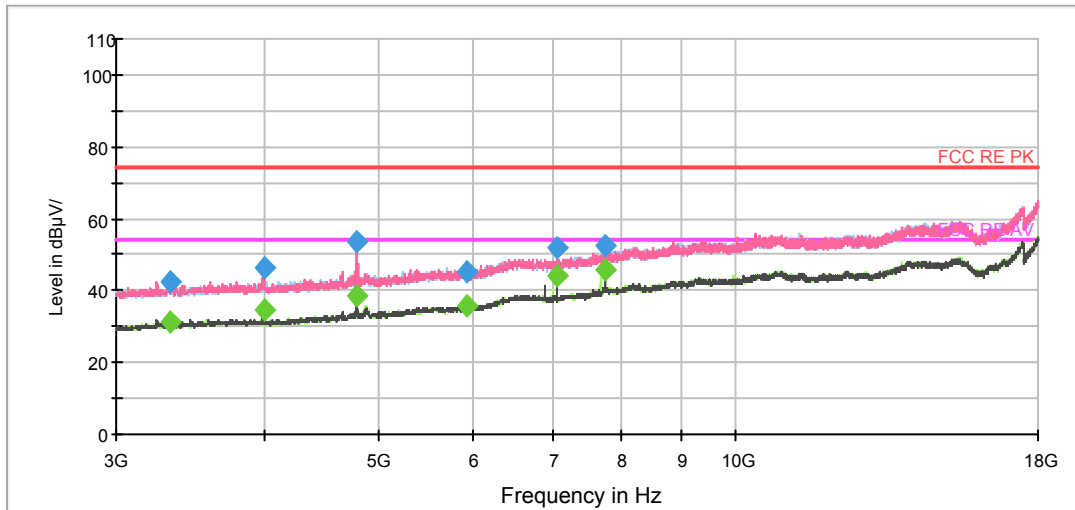

Radiates Emission from 3GHz to 18GHz



Frequency (MHz)	Peak (dBuV/m)	Height (cm)	Polarization	Azimuth (deg)	Correct Factor (dB)	Margin (dB)	Limit (dBuV/m)
1014.000000	46.1	200.0	H	4.0	-1.9	27.9	74.0
1278.750000	45.9	100.0	H	359.0	-1.1	28.1	74.0
1723.750000	46.7	200.0	H	296.0	0.4	27.3	74.0
1935.000000	47.2	100.0	H	288.0	1.0	26.8	74.0
2166.250000	48.1	200.0	H	204.0	2.1	25.9	74.0
2842.750000	50.5	200.0	H	0.0	4.4	23.5	74.0

Remark: 1. Correction Factor = Antenna factor+ Insertion loss (cable loss + amplifier gain)

Frequency (MHz)	Average (dBuV/m)	Height (cm)	Polarization	Azimuth (deg)	Correct Factor (dB)	Margin (dB)	Limit (dBuV/m)
1194.750000	36.5	200.0	V	146.0	-1.2	17.5	54.0
1391.750000	36.7	100.0	V	117.0	-0.7	17.3	54.0
1712.000000	36.9	200.0	V	245.0	0.4	17.1	54.0
1904.500000	37.2	100.0	H	0.0	0.9	16.8	54.0
2063.000000	38.2	100.0	H	259.0	1.5	15.8	54.0
2850.000000	40.4	200.0	H	264.0	4.4	13.6	54.0

Remark: 1. Correction Factor = Antenna factor+ Insertion loss (cable loss + amplifier gain)

802.11n (HT40) CH9

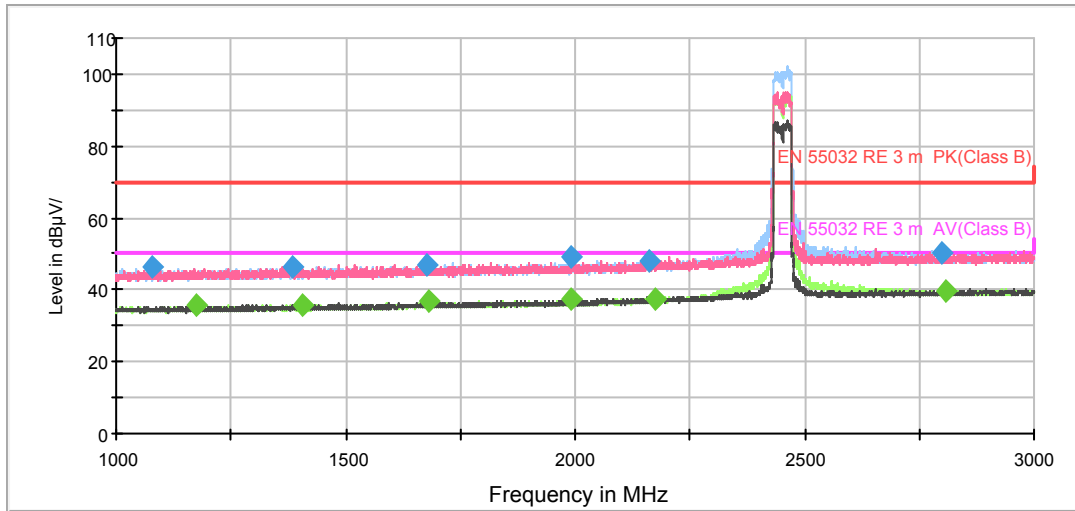

Note: The signal beyond the limit is carrier.
Radiates Emission from 1GHz to 3GHz

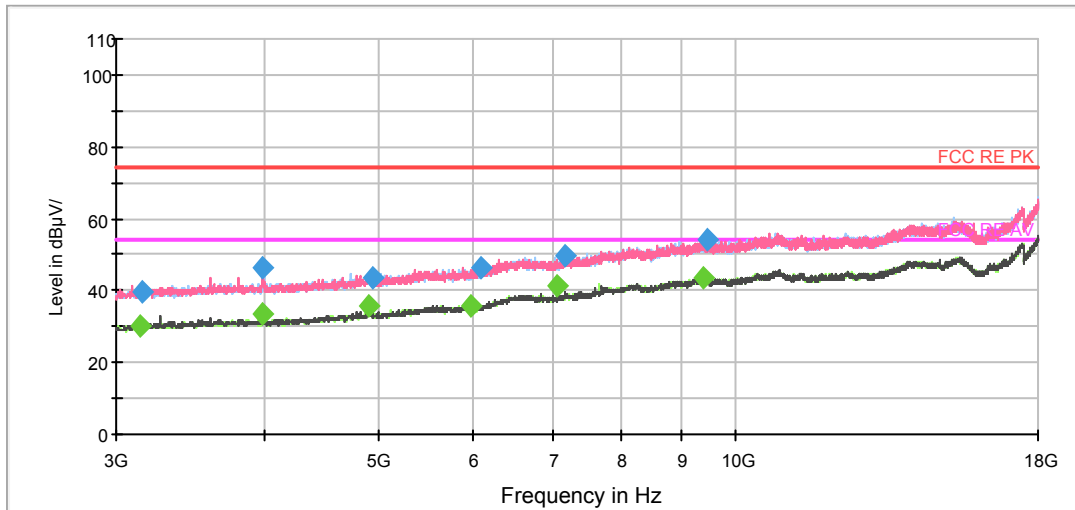

Radiates Emission from 3GHz to 18GHz



Frequency (MHz)	Peak (dBuV/m)	Height (cm)	Polarization	Azimuth (deg)	Correct Factor (dB)	Margin (dB)	Limit (dBuV/m)
1076.750000	46.2	200.0	H	4.0	-1.5	23.8	70.0
1382.250000	46.4	200.0	V	288.0	-0.7	23.6	70.0
1677.250000	46.9	100.0	H	290.0	0.3	23.1	70.0
1989.750000	48.9	100.0	V	29.0	1.1	21.1	70.0
2162.500000	48.1	200.0	H	6.0	2.0	21.9	70.0
2799.250000	50.1	200.0	H	93.0	4.3	19.9	70.0

Remark: 1. Correction Factor = Antenna factor+ Insertion loss (cable loss + amplifier gain)

Frequency (MHz)	Average (dBuV/m)	Height (cm)	Polarization	Azimuth (deg)	Correct Factor (dB)	Margin (dB)	Limit (dBuV/m)
1174.750000	35.8	200.0	H	6.0	-1.3	14.2	50.0
1408.250000	35.9	100.0	H	347.0	-0.7	14.1	50.0
1683.250000	36.7	100.0	H	195.0	0.3	13.3	50.0
1989.750000	37.6	100.0	V	29.0	1.1	12.4	50.0
2176.250000	37.3	100.0	H	342.0	2.1	12.7	50.0
2807.500000	39.4	200.0	H	0.0	4.3	10.6	50.0

Remark: 1. Correction Factor = Antenna factor+ Insertion loss (cable loss + amplifier gain)

ESP32-S2-MINI-1U

Continuous TX mode:

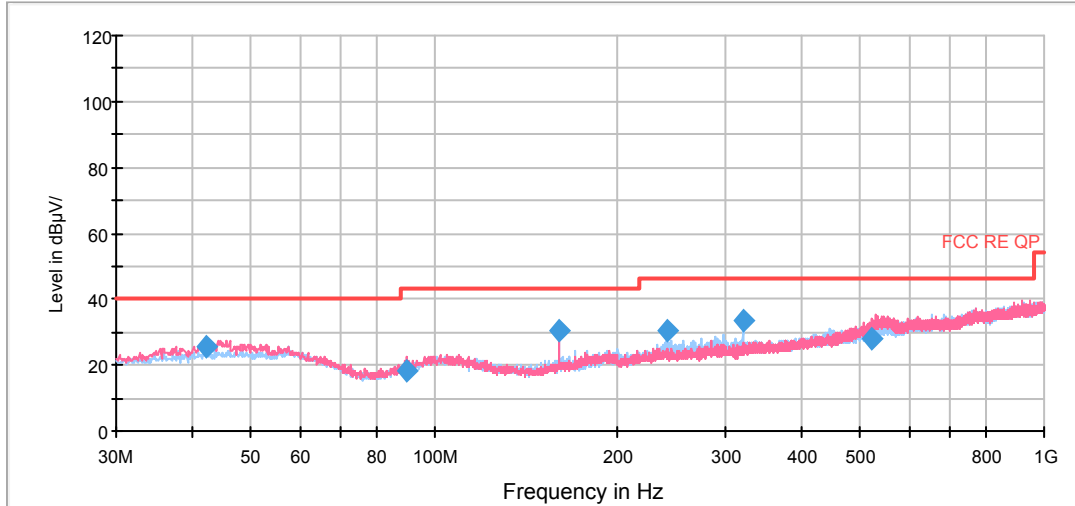

Radiates Emission from 30MHz to 1GHz

Frequency (MHz)	Quasi-Peak (dBuV/m)	Height (cm)	Polarization	Azimuth (deg)	Correct Factor (dB)	Margin (dB)	Limit (dBuV/m)
42.131250	25.5	125.0	V	84.0	14.4	14.5	40.0
89.893750	18.6	200.0	V	314.0	11.6	24.9	43.5
159.980000	30.5	100.0	V	84.0	10.4	13.0	43.5
240.003750	30.3	125.0	H	77.0	14.5	15.7	46.0
319.990000	33.8	100.0	H	144.0	16.2	12.2	46.0
522.390000	27.7	100.0	V	17.0	20.9	18.3	46.0

Remark: 1. Correction Factor = Antenna factor+ Insertion loss(cable loss+amplifier gain)

2. Margin = Limit – Quasi-Peak

802.11b CH1

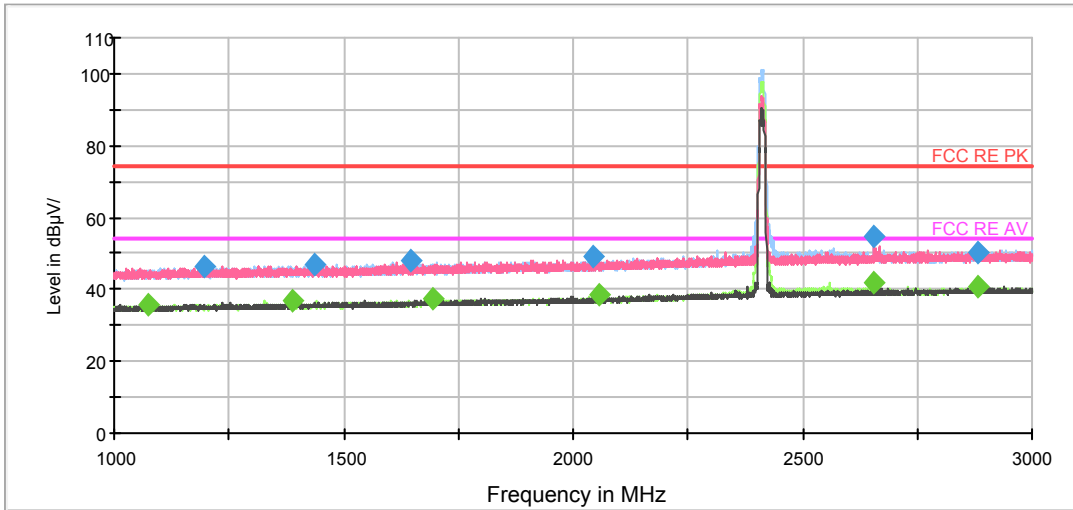

Note: The signal beyond the limit is carrier.
Radiates Emission from 1GHz to 3GHz

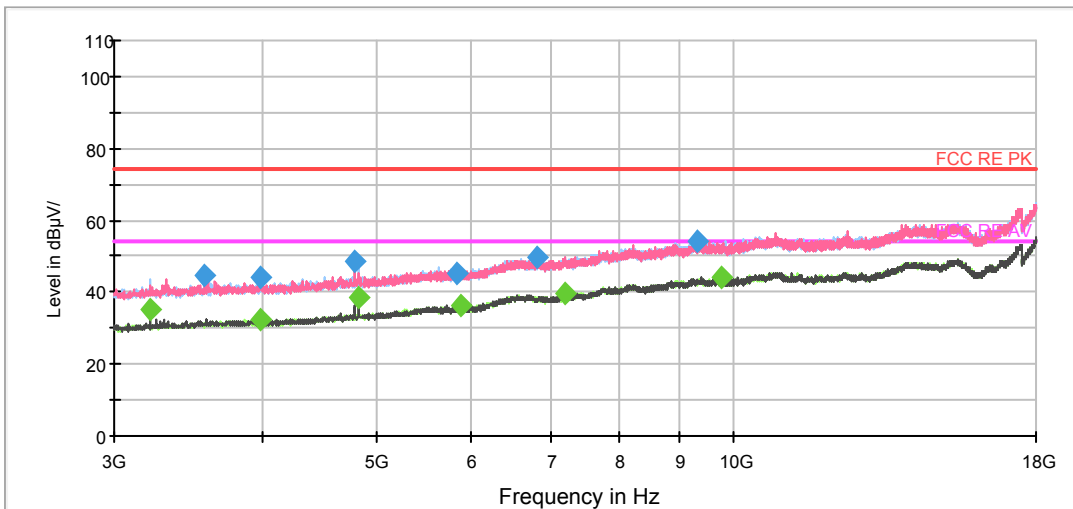

Radiates Emission from 3GHz to 18GHz



Frequency (MHz)	Peak (dBuV/m)	Height (cm)	Polarization	Azimuth (deg)	Correct Factor (dB)	Margin (dB)	Limit (dBuV/m)
1196.000000	46.3	100.0	V	127.0	-1.2	27.7	74.0
1435.750000	46.9	200.0	V	353.0	-0.6	27.1	74.0
1648.000000	48.0	100.0	H	306.0	0.2	26.0	74.0
2043.250000	48.9	200.0	H	34.0	1.4	25.1	74.0
2656.750000	54.5	100.0	V	230.0	3.9	19.5	74.0
2880.000000	50.2	200.0	H	91.0	4.5	23.8	74.0

Remark: 1. Correction Factor = Antenna factor+ Insertion loss (cable loss + amplifier gain)

Frequency (MHz)	Average (dBuV/m)	Height (cm)	Polarization	Azimuth (deg)	Correct Factor (dB)	Margin (dB)	Limit (dBuV/m)
1073.000000	35.9	100.0	H	296.0	-1.5	18.1	54.0
1387.000000	36.9	100.0	V	98.0	-0.7	17.1	54.0
1692.250000	37.1	200.0	H	238.0	0.4	16.9	54.0
2057.500000	38.3	200.0	H	34.0	1.4	15.7	54.0
2656.750000	41.8	100.0	V	230.0	3.9	12.2	54.0
2881.250000	40.6	100.0	V	1.0	4.5	13.4	54.0

Remark: 1. Correction Factor = Antenna factor+ Insertion loss (cable loss + amplifier gain)

802.11b CH6

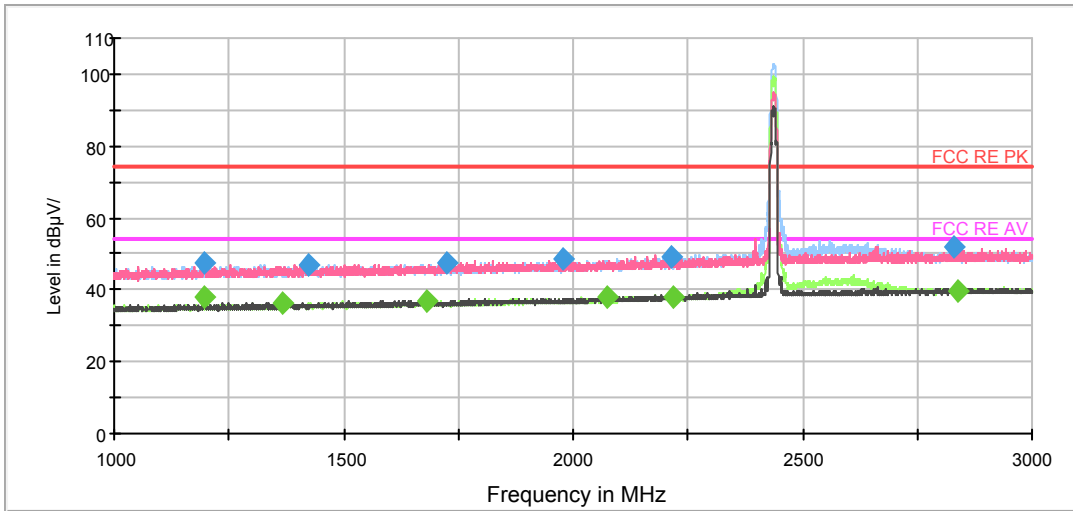

Note: The signal beyond the limit is carrier.
Radiates Emission from 1GHz to 3GHz

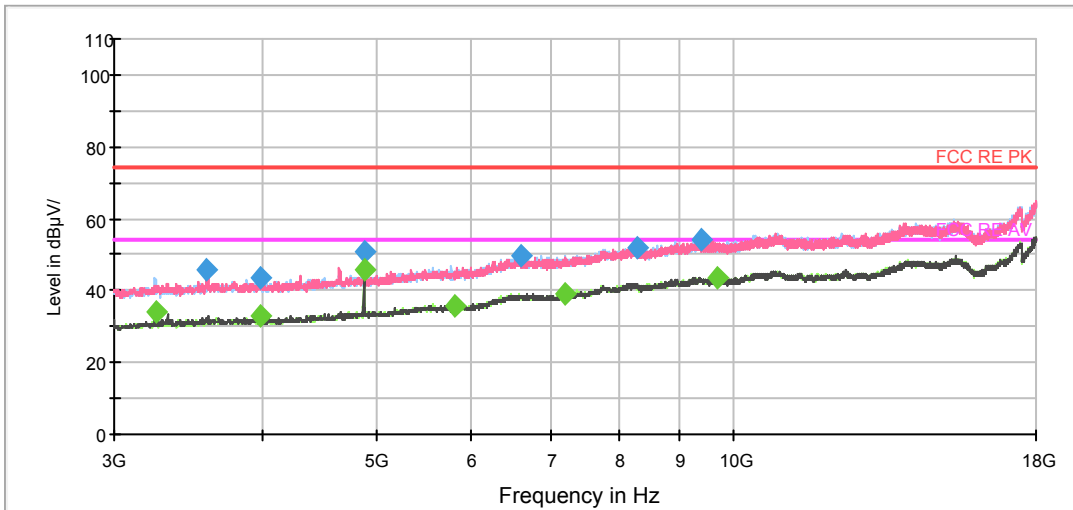

Radiates Emission from 3GHz to 18GHz



Frequency (MHz)	Peak (dBuV/m)	Height (cm)	Polarization	Azimuth (deg)	Correct Factor (dB)	Margin (dB)	Limit (dBuV/m)
1196.750000	47.7	100.0	V	20.0	-1.2	26.3	74.0
1422.750000	47.1	100.0	H	66.0	-0.6	26.9	74.0
1723.250000	47.5	200.0	V	277.0	0.4	26.5	74.0
1980.250000	48.3	100.0	V	200.0	1.1	25.7	74.0
2212.500000	48.9	200.0	V	170.0	2.3	25.1	74.0
2831.750000	51.9	200.0	V	198.0	4.4	22.1	74.0

Remark: 1. Correction Factor = Antenna factor+ Insertion loss (cable loss + amplifier gain)

Frequency (MHz)	Average (dBuV/m)	Height (cm)	Polarization	Azimuth (deg)	Correct Factor (dB)	Margin (dB)	Limit (dBuV/m)
1197.250000	37.8	100.0	V	20.0	-1.2	16.2	54.0
1366.500000	36.4	100.0	V	250.0	-0.8	17.6	54.0
1683.000000	37.1	200.0	H	29.0	0.3	16.9	54.0
2075.500000	38.0	200.0	H	316.0	1.5	16.0	54.0
2216.750000	38.2	200.0	V	267.0	2.3	15.8	54.0
2838.250000	39.9	200.0	V	315.0	4.4	14.1	54.0

Remark: 1. Correction Factor = Antenna factor+ Insertion loss (cable loss + amplifier gain)

802.11b CH11

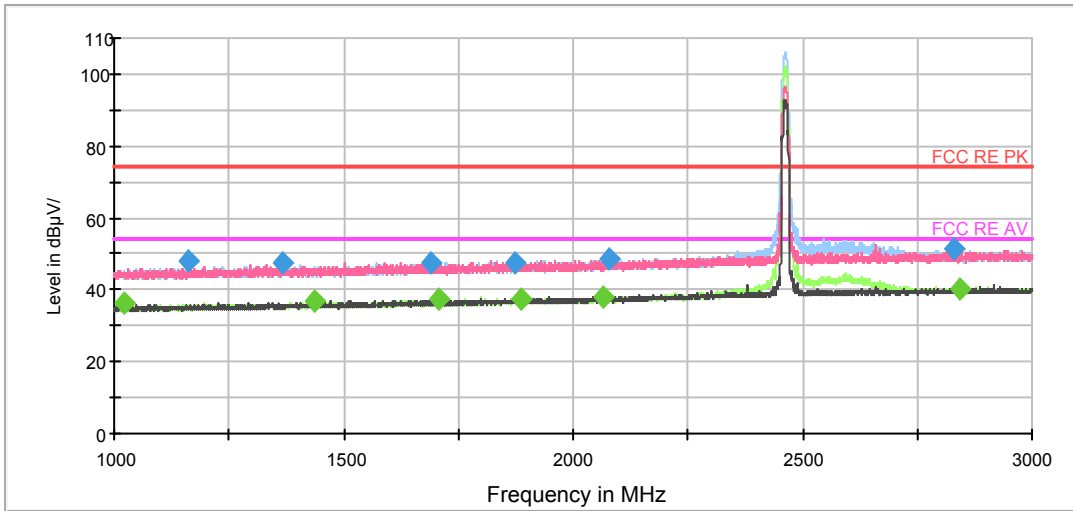

Note: The signal beyond the limit is carrier.
Radiates Emission from 1GHz to 3GHz

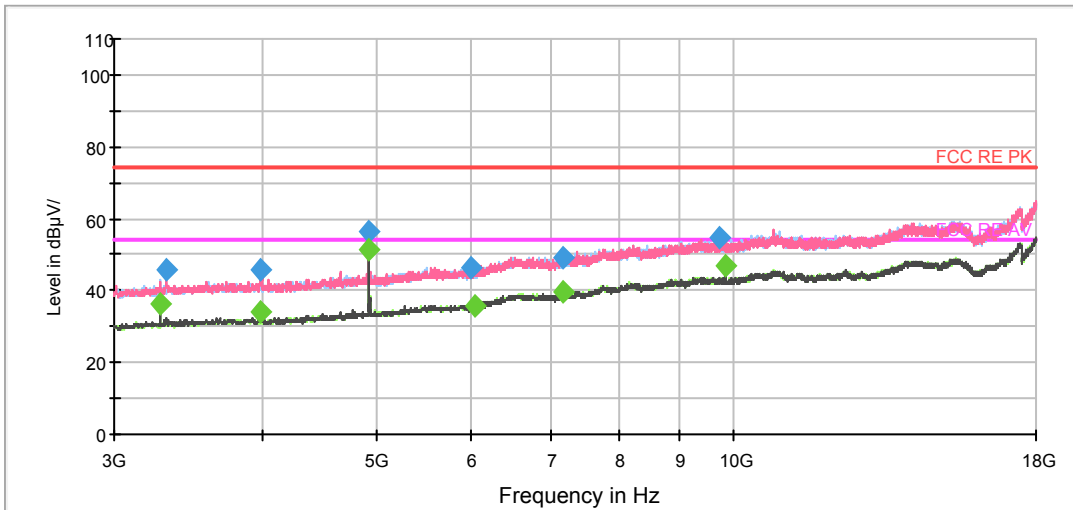

Radiates Emission from 3GHz to 18GHz



Frequency (MHz)	Peak (dBuV/m)	Height (cm)	Polarization	Azimuth (deg)	Correct Factor (dB)	Margin (dB)	Limit (dBuV/m)
1161.250000	48.0	100.0	V	17.0	-1.3	26.0	74.0
1364.750000	47.4	100.0	H	307.0	-0.8	26.6	74.0
1689.250000	47.6	100.0	V	22.0	0.4	26.4	74.0
1875.500000	47.2	100.0	H	334.0	0.8	26.8	74.0
2079.500000	48.6	100.0	V	210.0	1.5	25.4	74.0
2827.750000	51.5	100.0	H	177.0	4.4	22.5	74.0

Remark: 1. Correction Factor = Antenna factor+ Insertion loss (cable loss + amplifier gain)

Frequency (MHz)	Average (dBuV/m)	Height (cm)	Polarization	Azimuth (deg)	Correct Factor (dB)	Margin (dB)	Limit (dBuV/m)
1020.000000	36.3	100.0	V	0.0	-1.8	17.7	54.0
1436.500000	36.6	100.0	H	118.0	-0.6	17.4	54.0
1709.500000	37.3	200.0	V	278.0	0.4	16.7	54.0
1887.750000	37.2	100.0	H	207.0	0.8	16.8	54.0
2063.500000	38.1	200.0	V	351.0	1.5	15.9	54.0
2840.750000	40.1	100.0	V	170.0	4.4	13.9	54.0

Remark: 1. Correction Factor = Antenna factor+ Insertion loss (cable loss + amplifier gain)

802.11g CH1

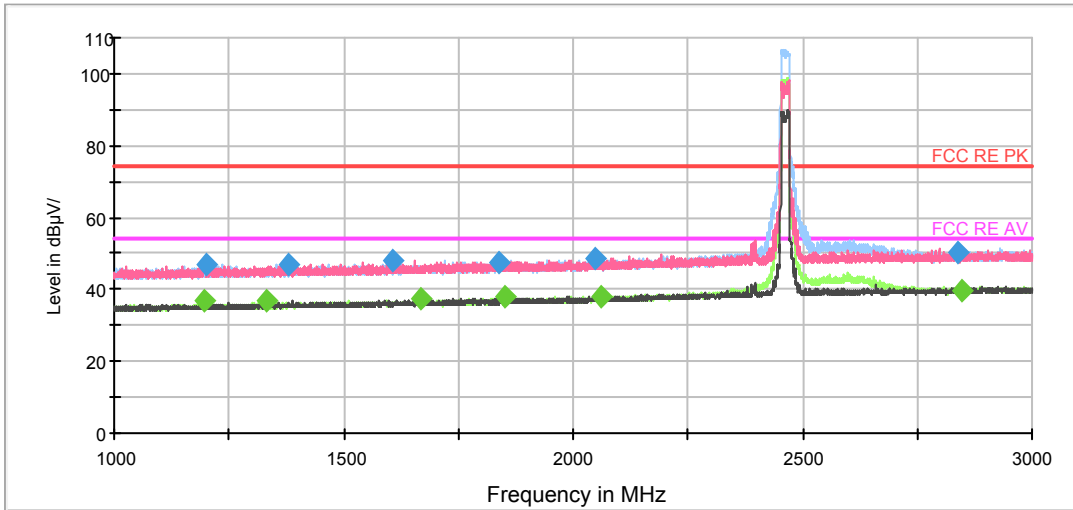

Note: The signal beyond the limit is carrier.
Radiates Emission from 1GHz to 3GHz

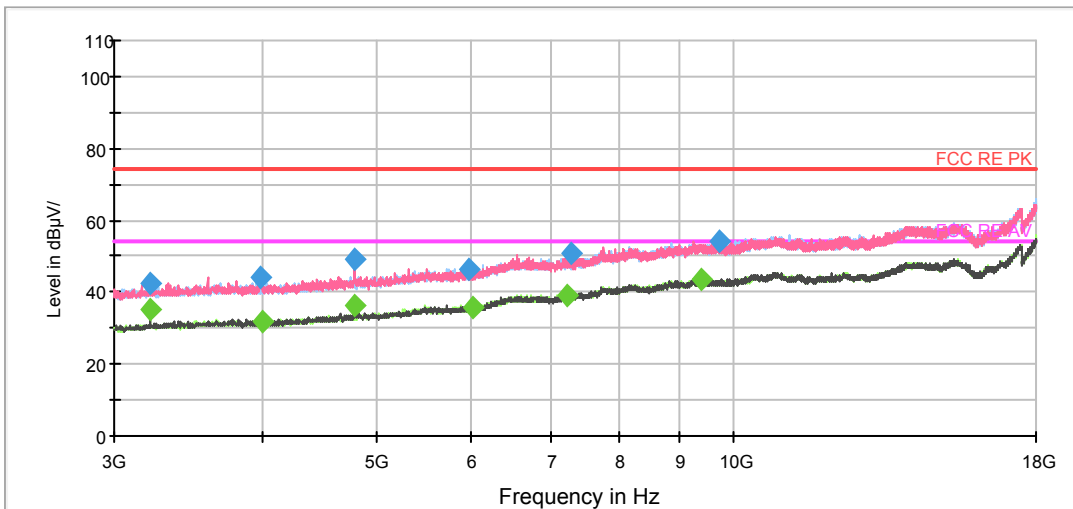

Radiates Emission from 3GHz to 18GHz



Frequency (MHz)	Peak (dBuV/m)	Height (cm)	Polarization	Azimuth (deg)	Correct Factor (dB)	Margin (dB)	Limit (dBuV/m)
1200.000000	46.8	100.0	H	264.0	-1.2	27.2	74.0
1377.750000	47.1	200.0	V	348.0	-0.7	26.9	74.0
1606.000000	48.1	200.0	H	263.0	0.0	25.9	74.0
1840.500000	47.4	100.0	H	206.0	0.7	26.6	74.0
2046.750000	48.3	100.0	H	56.0	1.4	25.7	74.0
2839.000000	50.1	100.0	V	199.0	4.4	23.9	74.0

Remark: 1. Correction Factor = Antenna factor+ Insertion loss (cable loss + amplifier gain)

Frequency (MHz)	Average (dBuV/m)	Height (cm)	Polarization	Azimuth (deg)	Correct Factor (dB)	Margin (dB)	Limit (dBuV/m)
1198.500000	37.0	200.0	V	155.0	-1.2	17.0	54.0
1332.250000	36.7	100.0	H	254.0	-0.9	17.3	54.0
1668.250000	37.3	200.0	V	0.0	0.2	16.7	54.0
1852.250000	37.7	100.0	H	321.0	0.8	16.3	54.0
2059.000000	37.9	200.0	V	358.0	1.4	16.1	54.0
2848.000000	39.9	100.0	H	292.0	4.4	14.1	54.0

Remark: 1. Correction Factor = Antenna factor+ Insertion loss (cable loss + amplifier gain)

802.11g CH6

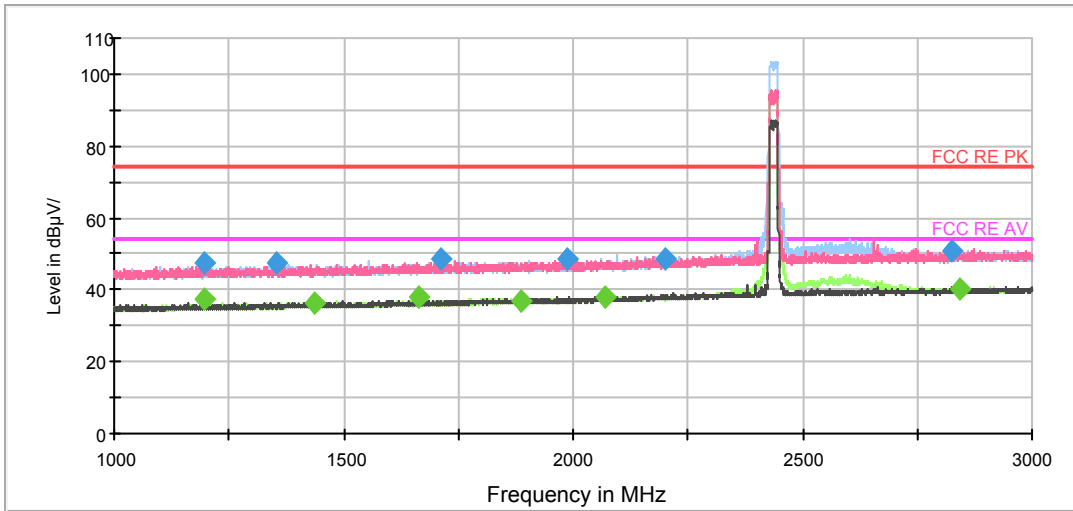

Note: The signal beyond the limit is carrier.
Radiates Emission from 1GHz to 3GHz

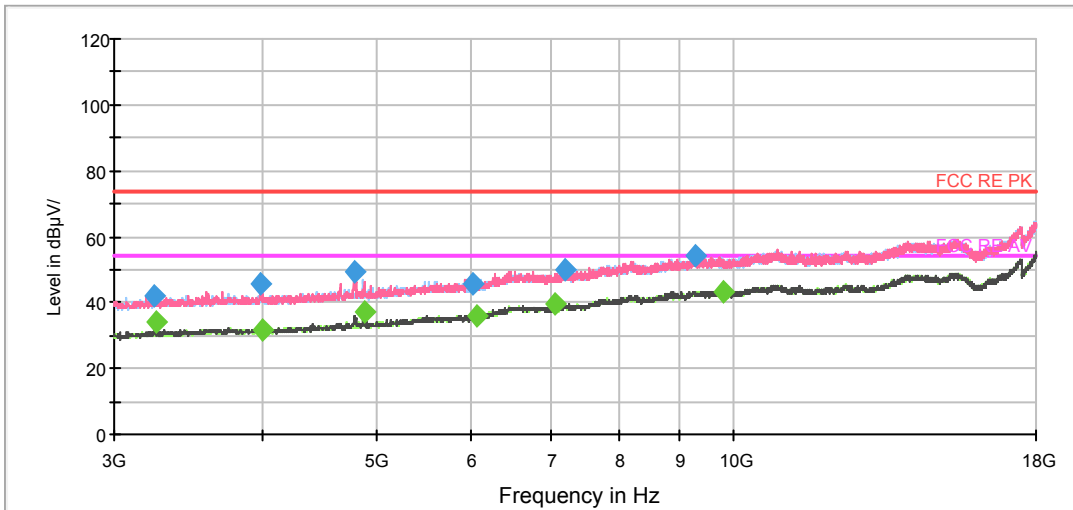

Radiates Emission from 3GHz to 18GHz



Frequency (MHz)	Peak (dBuV/m)	Height (cm)	Polarization	Azimuth (deg)	Correct Factor (dB)	Margin (dB)	Limit (dBuV/m)
1196.250000	47.5	200.0	V	120.0	-1.2	26.5	74.0
1352.750000	47.4	100.0	H	0.0	-0.9	26.6	74.0
1710.750000	48.4	100.0	V	209.0	0.4	25.6	74.0
1988.000000	48.5	100.0	V	219.0	1.1	25.5	74.0
2198.750000	48.6	200.0	V	0.0	2.2	25.4	74.0
2826.750000	50.8	100.0	V	229.0	4.4	23.2	74.0

Remark: 1. Correction Factor = Antenna factor+ Insertion loss (cable loss + amplifier gain)

Frequency (MHz)	Average (dBuV/m)	Height (cm)	Polarization	Azimuth (deg)	Correct Factor (dB)	Margin (dB)	Limit (dBuV/m)
1196.250000	37.3	200.0	V	120.0	-1.2	16.7	54.0
1436.250000	36.5	100.0	V	219.0	-0.6	17.5	54.0
1662.000000	37.7	200.0	V	348.0	0.2	16.3	54.0
1888.000000	36.8	200.0	V	140.0	0.8	17.2	54.0
2069.750000	38.1	100.0	H	278.0	1.5	15.9	54.0
2840.750000	40.0	100.0	V	119.0	4.4	14.0	54.0

Remark: 1. Correction Factor = Antenna factor+ Insertion loss (cable loss + amplifier gain)



802.11g CH11

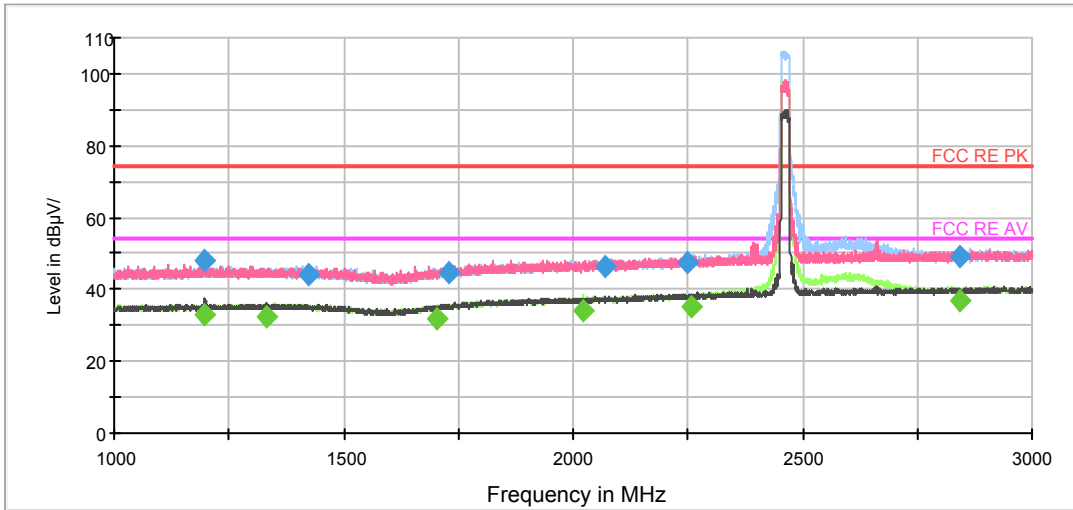

Note: The signal beyond the limit is carrier.
Radiates Emission from 1GHz to 3GHz

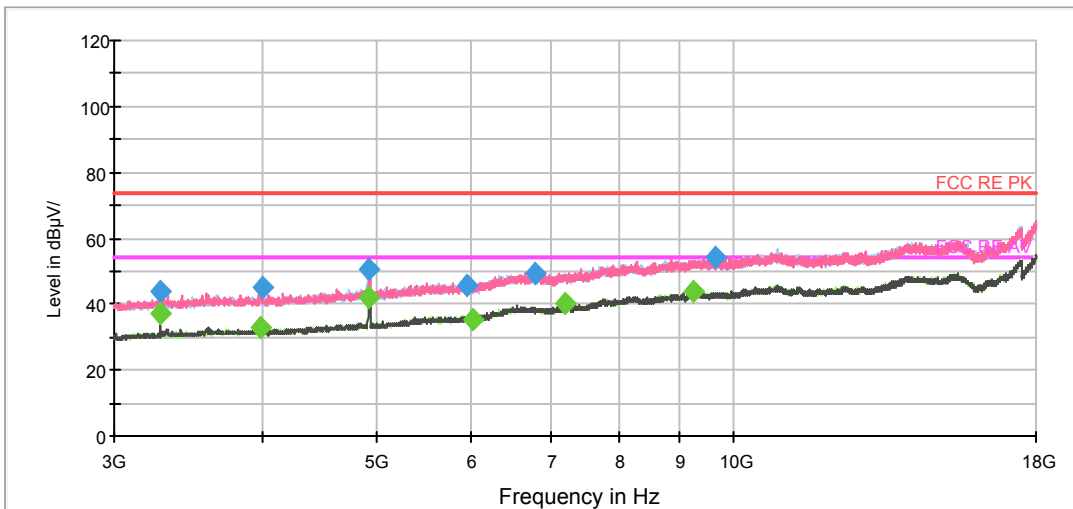

Radiates Emission from 3GHz to 18GHz



Frequency (MHz)	Peak (dBuV/m)	Height (cm)	Polarization	Azimuth (deg)	Correct Factor (dB)	Margin (dB)	Limit (dBuV/m)
1195.250000	47.8	197.0	V	180.0	-1.2	26.2	74.0
1425.750000	44.2	225.0	V	100.0	-0.6	29.8	74.0
1729.500000	44.7	119.0	V	44.0	0.5	29.3	74.0
2070.750000	46.3	125.0	H	200.0	1.5	27.7	74.0
2246.750000	47.7	175.0	V	215.0	2.4	26.3	74.0
2844.500000	49.4	100.0	V	37.0	4.4	24.6	74.0

Remark: 1. Correction Factor = Antenna factor+ Insertion loss (cable loss + amplifier gain)

Frequency (MHz)	Average (dBuV/m)	Height (cm)	Polarization	Azimuth (deg)	Correct Factor (dB)	Margin (dB)	Limit (dBuV/m)
1197.000000	32.9	125.0	V	10.0	-1.2	21.1	54.0
1329.750000	32.2	212.0	V	220.0	-0.9	21.8	54.0
1701.750000	31.9	225.0	H	4.0	0.4	22.1	54.0
2021.250000	33.8	100.0	H	0.0	1.2	20.2	54.0
2257.500000	35.1	100.0	H	203.0	2.5	18.9	54.0
2843.000000	36.8	100.0	H	0.0	4.4	17.2	54.0

Remark: 1. Correction Factor = Antenna factor+ Insertion loss (cable loss + amplifier gain)

802.11n (HT20) CH1

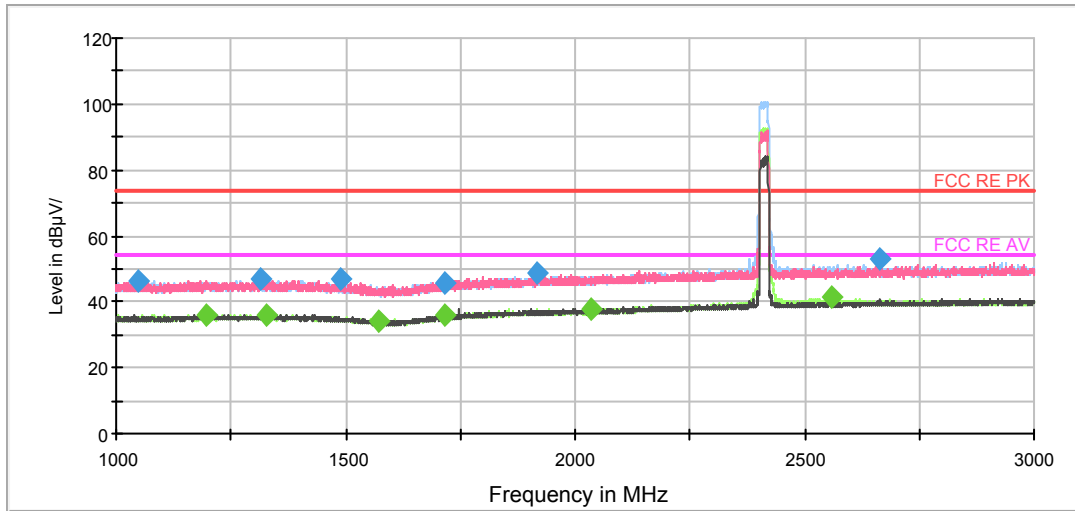

Note: The signal beyond the limit is carrier.
Radiates Emission from 1GHz to 3GHz

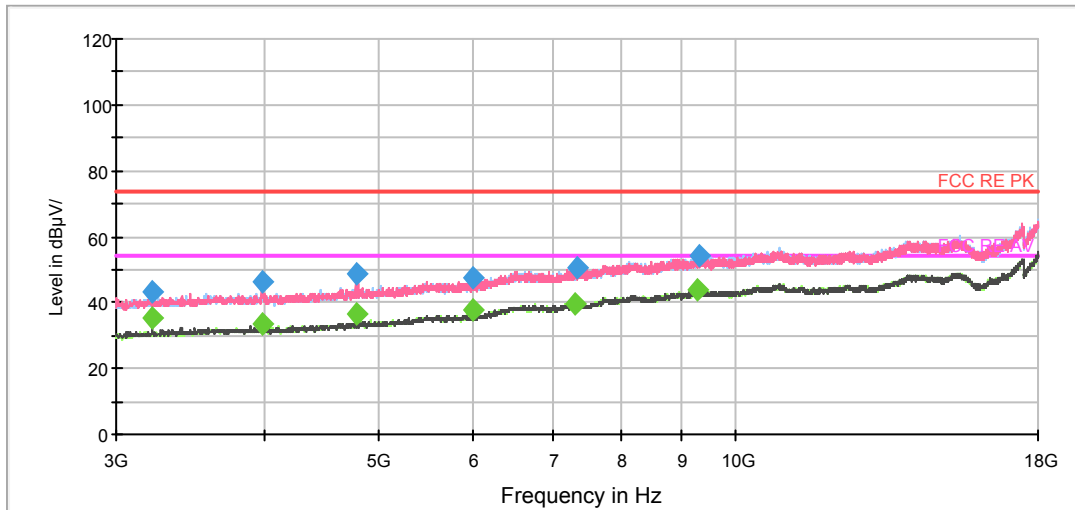

Radiates Emission from 3GHz to 18GHz



Frequency (MHz)	Peak (dBuV/m)	Height (cm)	Polarization	Azimuth (deg)	Correct Factor (dB)	Margin (dB)	Limit (dBuV/m)
1047.250000	46.5	200.0	H	15.0	-1.7	27.5	74.0
1314.750000	46.6	200.0	V	215.0	-0.9	27.4	74.0
1490.500000	46.6	100.0	H	334.0	-0.4	27.4	74.0
1717.250000	45.8	100.0	H	0.0	0.4	28.2	74.0
1918.750000	48.5	200.0	V	339.0	1.0	25.5	74.0
2665.750000	53.1	200.0	V	215.0	3.9	20.9	74.0

Remark: 1. Correction Factor = Antenna factor+ Insertion loss (cable loss + amplifier gain)

Frequency (MHz)	Average (dBuV/m)	Height (cm)	Polarization	Azimuth (deg)	Correct Factor (dB)	Margin (dB)	Limit (dBuV/m)
1197.750000	36.1	200.0	V	353.0	-1.2	17.9	54.0
1329.500000	36.1	100.0	V	65.0	-0.9	17.9	54.0
1572.000000	34.3	100.0	H	0.0	-0.1	19.7	54.0
1714.250000	35.9	100.0	V	3.0	0.4	18.1	54.0
2036.000000	38.0	200.0	H	168.0	1.3	16.0	54.0
2560.750000	41.2	100.0	H	0.0	3.7	12.8	54.0

Remark: 1. Correction Factor = Antenna factor+ Insertion loss (cable loss + amplifier gain)

802.11n (HT20) CH6

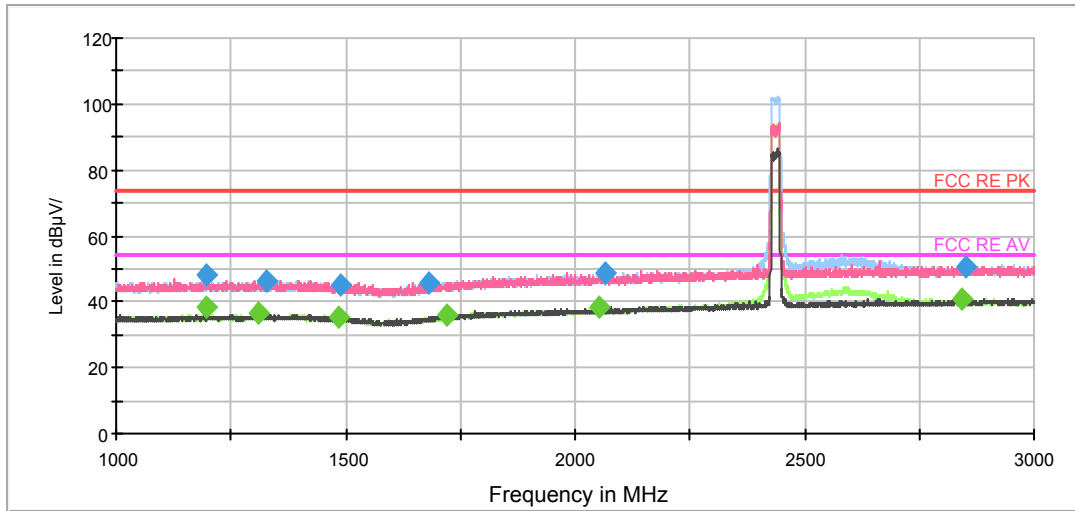

Note: The signal beyond the limit is carrier.
Radiates Emission from 1GHz to 3GHz

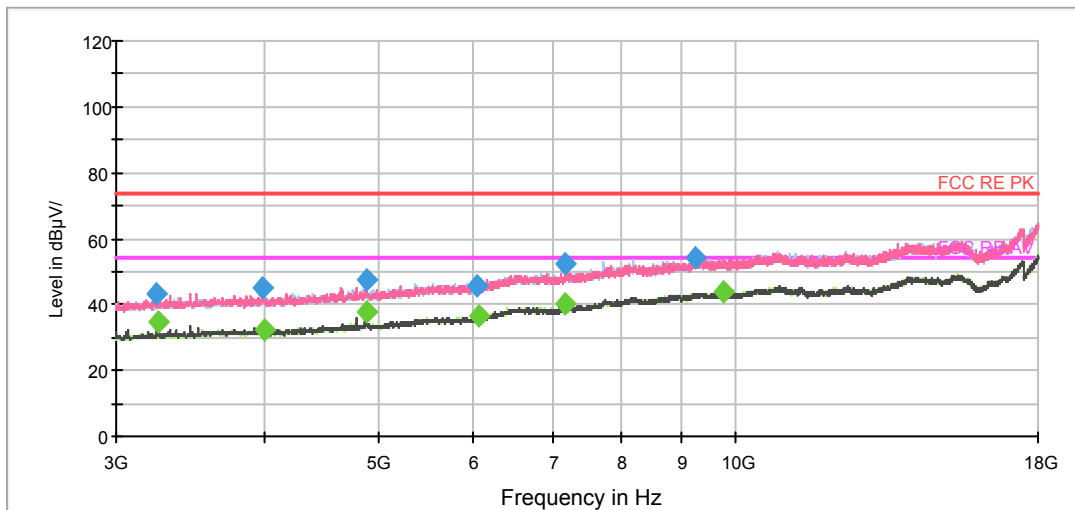

Radiates Emission from 3GHz to 18GHz



Frequency (MHz)	Peak (dBuV/m)	Height (cm)	Polarization	Azimuth (deg)	Correct Factor (dB)	Margin (dB)	Limit (dBuV/m)
1198.250000	48.1	100.0	V	0.0	-1.2	25.9	74.0
1325.500000	46.6	100.0	H	136.0	-0.9	27.4	74.0
1490.500000	44.9	100.0	H	0.0	-0.4	29.1	74.0
1682.250000	45.9	200.0	V	210.0	0.3	28.1	74.0
2064.750000	48.8	200.0	H	201.0	1.5	25.2	74.0
2850.250000	50.3	200.0	H	338.0	4.4	23.7	74.0

Remark: 1. Correction Factor = Antenna factor+ Insertion loss (cable loss + amplifier gain)

Frequency (MHz)	Average (dBuV/m)	Height (cm)	Polarization	Azimuth (deg)	Correct Factor (dB)	Margin (dB)	Limit (dBuV/m)
1198.250000	38.2	100.0	V	0.0	-1.2	15.8	54.0
1308.750000	36.4	200.0	H	20.0	-1.0	17.6	54.0
1486.000000	35.4	200.0	V	358.0	-0.5	18.6	54.0
1720.750000	35.8	200.0	V	352.0	0.4	18.2	54.0
2050.250000	38.3	100.0	V	66.0	1.4	15.7	54.0
2844.000000	40.6	100.0	V	32.0	4.4	13.4	54.0

Remark: 1. Correction Factor = Antenna factor+ Insertion loss (cable loss + amplifier gain)

802.11n (HT20) CH11

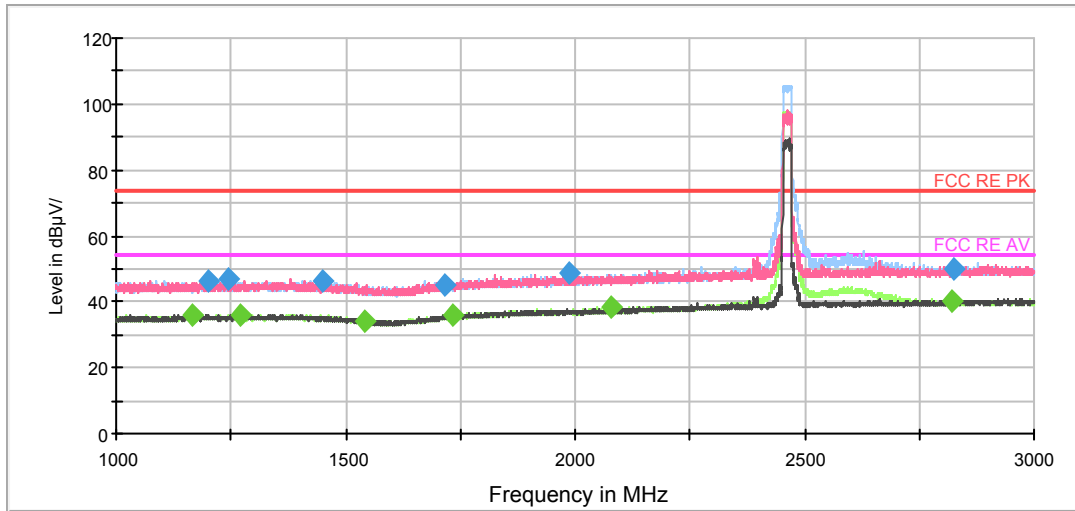

Note: The signal beyond the limit is carrier.
Radiates Emission from 1GHz to 3GHz

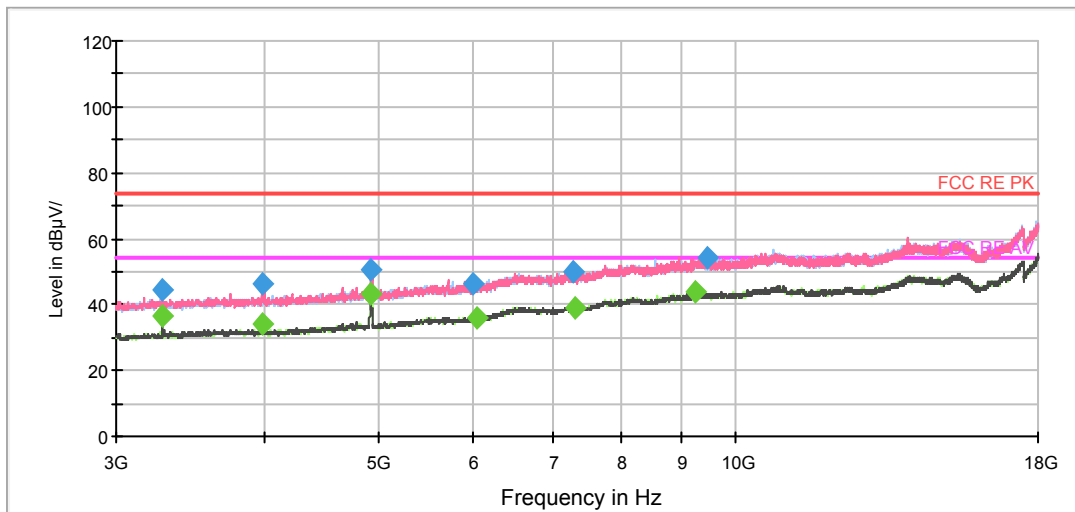

Radiates Emission from 3GHz to 18GHz



Frequency (MHz)	Peak (dBuV/m)	Height (cm)	Polarization	Azimuth (deg)	Correct Factor (dB)	Margin (dB)	Limit (dBuV/m)
1199.750000	46.3	100.0	V	122.0	-1.2	27.7	74.0
1246.250000	46.8	200.0	V	354.0	-1.1	27.2	74.0
1449.000000	46.3	100.0	V	108.0	-0.6	27.7	74.0
1714.000000	45.3	200.0	V	0.0	0.4	28.7	74.0
1985.500000	48.5	100.0	H	324.0	1.1	25.5	74.0
2823.250000	49.7	200.0	V	0.0	4.4	24.3	74.0

Remark: 1. Correction Factor = Antenna factor+ Insertion loss (cable loss + amplifier gain)

Frequency (MHz)	Average (dBuV/m)	Height (cm)	Polarization	Azimuth (deg)	Correct Factor (dB)	Margin (dB)	Limit (dBuV/m)
1166.000000	36.2	200.0	V	350.0	-1.3	17.8	54.0
1272.250000	35.9	200.0	V	324.0	-1.1	18.1	54.0
1542.750000	34.2	100.0	H	302.0	-0.3	19.8	54.0
1731.500000	35.9	100.0	V	180.0	0.5	18.1	54.0
2079.500000	38.1	100.0	H	302.0	1.5	15.9	54.0
2823.000000	40.0	200.0	H	99.0	4.4	14.0	54.0

Remark: 1. Correction Factor = Antenna factor+ Insertion loss (cable loss + amplifier gain)

802.11n (HT40) CH3

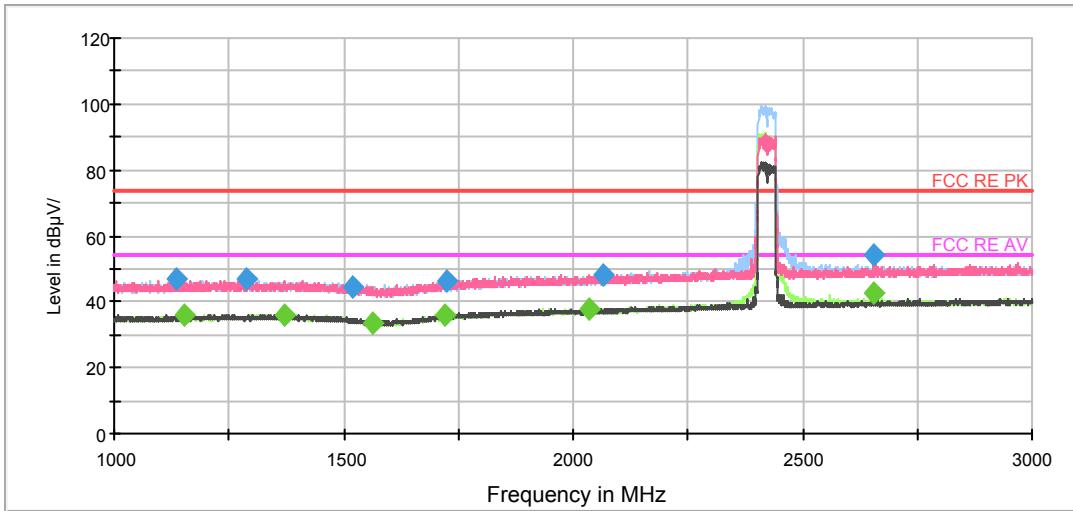

Note: The signal beyond the limit is carrier.
Radiates Emission from 1GHz to 3GHz

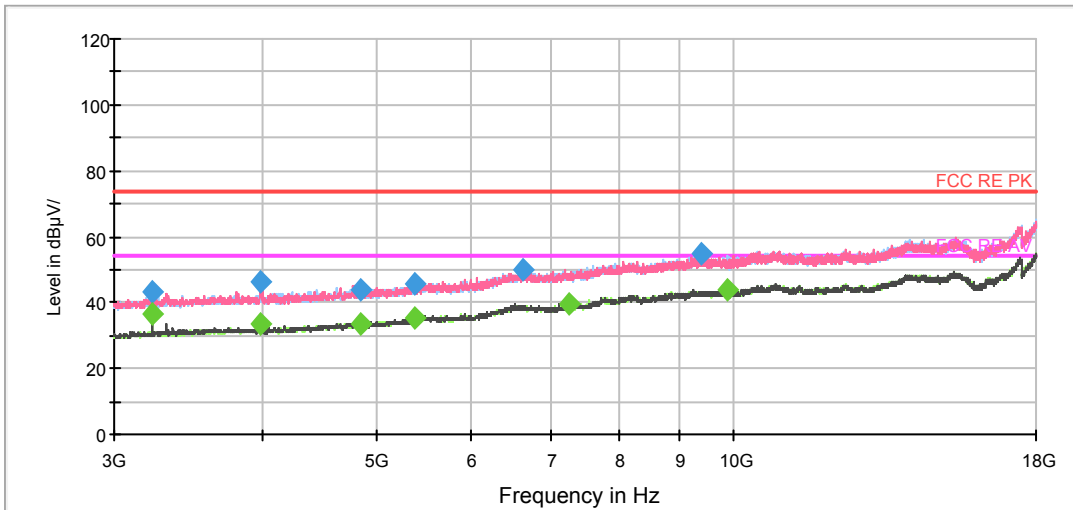

Radiates Emission from 3GHz to 18GHz



Frequency (MHz)	Peak (dBuV/m)	Height (cm)	Polarization	Azimuth (deg)	Correct Factor (dB)	Margin (dB)	Limit (dBuV/m)
1137.500000	46.8	100.0	H	275.0	-1.3	27.2	74.0
1288.500000	46.7	200.0	V	359.0	-1.0	27.3	74.0
1518.500000	44.5	100.0	H	359.0	-0.3	29.5	74.0
1725.750000	46.3	100.0	H	0.0	0.4	27.7	74.0
2067.500000	48.4	200.0	V	320.0	1.5	25.6	74.0
2656.500000	53.9	100.0	V	224.0	3.9	20.1	74.0

Remark: 1. Correction Factor = Antenna factor+ Insertion loss (cable loss + amplifier gain)

Frequency (MHz)	Average (dBuV/m)	Height (cm)	Polarization	Azimuth (deg)	Correct Factor (dB)	Margin (dB)	Limit (dBuV/m)
1154.500000	36.0	100.0	H	303.0	-1.3	18.0	54.0
1370.500000	36.1	200.0	V	343.0	-0.8	17.9	54.0
1565.000000	33.5	100.0	H	356.0	-0.2	20.5	54.0
1719.750000	36.2	200.0	V	210.0	0.4	17.8	54.0
2036.750000	38.0	100.0	V	136.0	1.3	16.0	54.0
2656.500000	42.4	100.0	V	224.0	3.9	11.6	54.0

Remark: 1. Correction Factor = Antenna factor+ Insertion loss (cable loss + amplifier gain)

802.11n (HT40) CH6

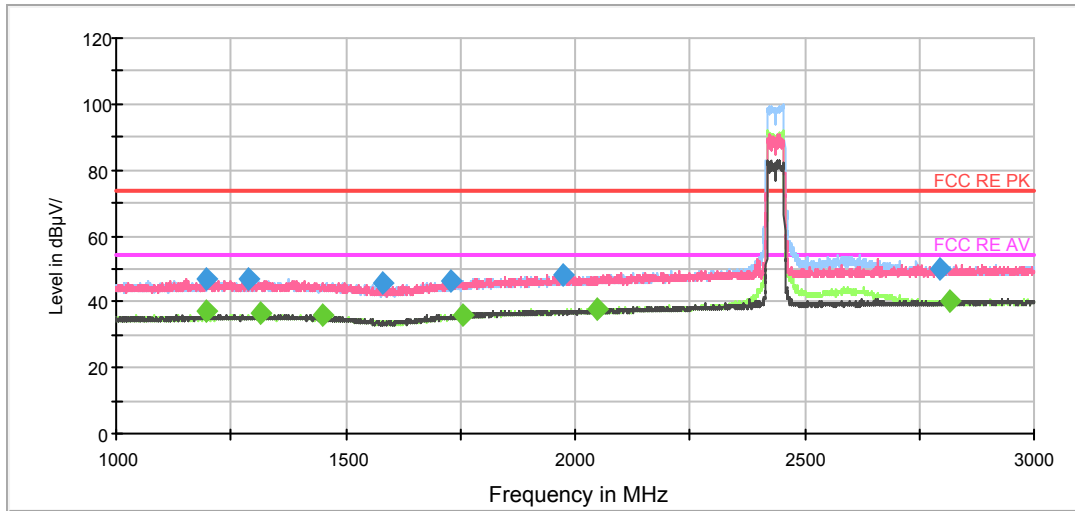

Note: The signal beyond the limit is carrier.
Radiates Emission from 1GHz to 3GHz

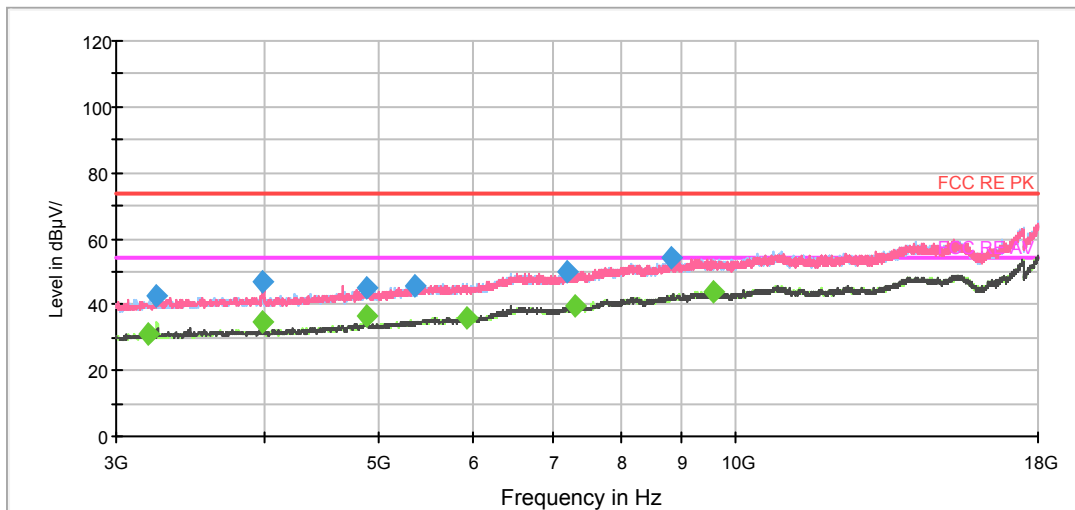

Radiates Emission from 3GHz to 18GHz



Frequency (MHz)	Peak (dBuV/m)	Height (cm)	Polarization	Azimuth (deg)	Correct Factor (dB)	Margin (dB)	Limit (dBuV/m)
1195.250000	47.0	200.0	V	128.0	-1.2	27.0	74.0
1288.750000	46.8	200.0	H	30.0	-1.0	27.2	74.0
1581.000000	45.5	100.0	V	17.0	-0.1	28.5	74.0
1731.250000	46.3	200.0	V	288.0	0.5	27.7	74.0
1973.250000	48.4	100.0	V	137.0	1.1	25.6	74.0
2796.000000	50.2	100.0	V	65.0	4.3	23.8	74.0

Remark: 1. Correction Factor = Antenna factor+ Insertion loss (cable loss + amplifier gain)

Frequency (MHz)	Average (dBuV/m)	Height (cm)	Polarization	Azimuth (deg)	Correct Factor (dB)	Margin (dB)	Limit (dBuV/m)
1197.500000	37.4	200.0	V	128.0	-1.2	16.6	54.0
1312.250000	36.3	100.0	V	24.0	-0.9	17.7	54.0
1449.250000	36.0	200.0	V	0.0	-0.6	18.0	54.0
1754.000000	35.8	100.0	H	233.0	0.5	18.2	54.0
2047.750000	38.0	200.0	V	350.0	1.4	16.0	54.0
2815.250000	39.9	200.0	V	187.0	4.3	14.1	54.0

Remark: 1. Correction Factor = Antenna factor+ Insertion loss (cable loss + amplifier gain)

802.11n (HT40) CH9

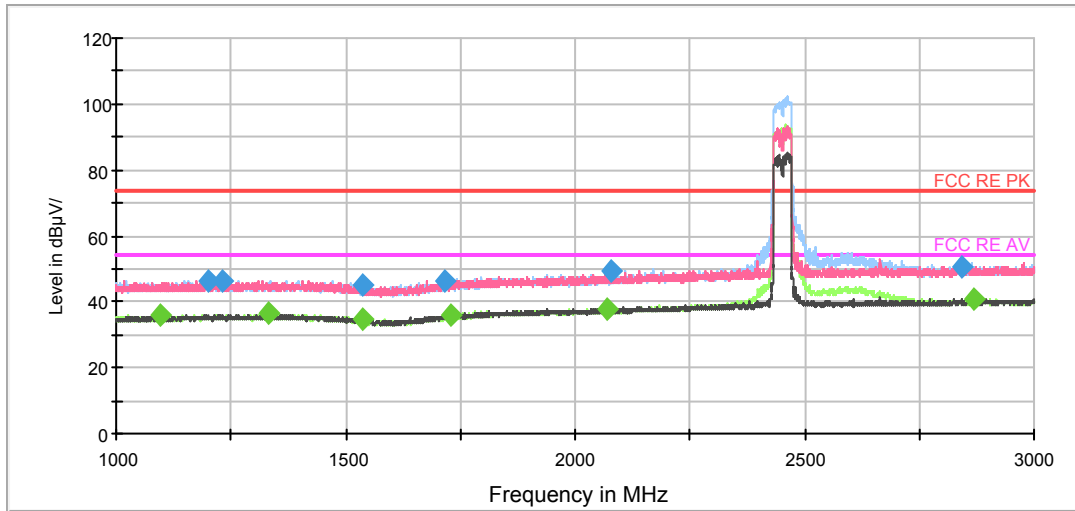

Note: The signal beyond the limit is carrier.
Radiates Emission from 1GHz to 3GHz

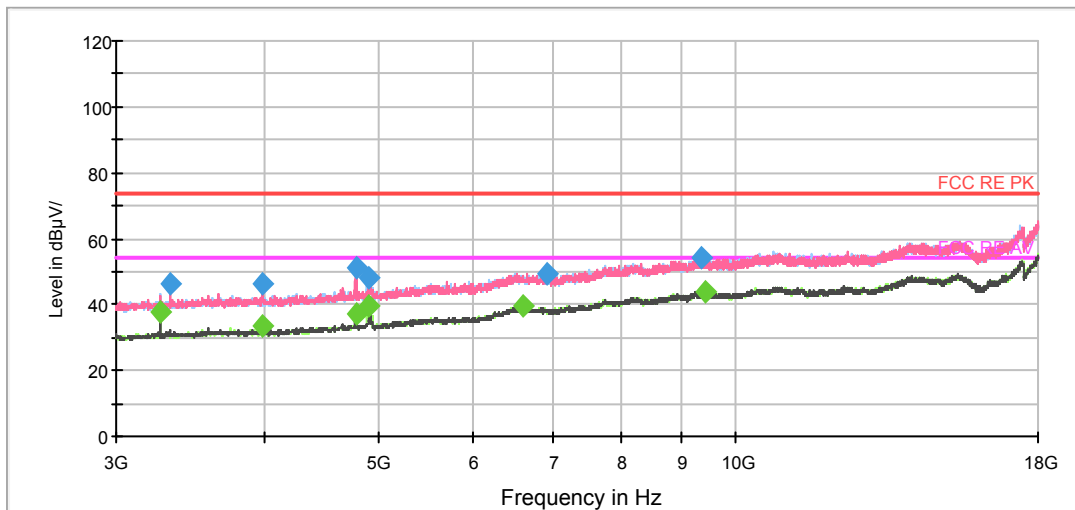

Radiates Emission from 3GHz to 18GHz



Frequency (MHz)	Peak (dBuV/m)	Height (cm)	Polarization	Azimuth (deg)	Correct Factor (dB)	Margin (dB)	Limit (dBuV/m)
1200.000000	46.4	200.0	V	152.0	-1.2	27.6	74.0
1232.250000	46.4	200.0	V	210.0	-1.2	27.6	74.0
1537.000000	45.1	200.0	H	19.0	-0.3	28.9	74.0
1718.250000	46.3	100.0	H	313.0	0.4	27.7	74.0
2077.500000	49.1	100.0	H	274.0	1.5	24.9	74.0
2844.250000	50.6	200.0	V	350.0	4.4	23.4	74.0

Remark: 1. Correction Factor = Antenna factor+ Insertion loss (cable loss + amplifier gain)

Frequency (MHz)	Average (dBuV/m)	Height (cm)	Polarization	Azimuth (deg)	Correct Factor (dB)	Margin (dB)	Limit (dBuV/m)
1096.000000	36.1	200.0	H	4.0	-1.4	17.9	54.0
1330.250000	36.8	200.0	V	121.0	-0.9	17.2	54.0
1537.250000	34.8	200.0	V	282.0	-0.3	19.2	54.0
1730.250000	36.0	100.0	V	2.0	0.5	18.0	54.0
2070.250000	38.0	200.0	V	332.0	1.5	16.0	54.0
2867.250000	40.5	200.0	H	27.0	4.4	13.5	54.0

Remark: 1. Correction Factor = Antenna factor+ Insertion loss (cable loss + amplifier gain)

5.7. Conducted Emission

Ambient condition

Temperature	Relative humidity	Pressure
23°C ~25°C	45%~50%	101.5kPa

Methods of Measurement

The EUT is placed on a non-metallic table of 80cm height above the horizontal metal reference ground plane. During the test, the EUT was operating in its typical mode. The test method is according to ANSI C63.10-2013. Connect the AC power line of the EUT to the L.I.S.N. Use EMI receiver to detect the average and Quasi-peak value. RBW is set to 9 kHz, VBW is set to 30kHz. The measurement result should include both L line and N line.

The test is in transmitting mode.

Test Setup

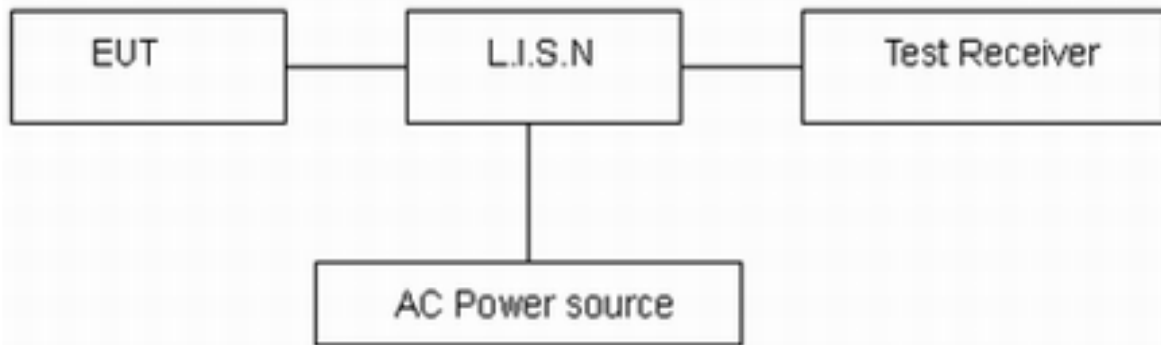

Note: AC Power source is used to change the voltage 110V/60Hz.

Limits

Frequency (MHz)	Conducted Limits(dBμV)	
	Quasi-peak	Average
0.15 - 0.5	66 to 56 *	56 to 46*
0.5 - 5	56	46
5 - 30	60	50

*: Decreases with the logarithm of the frequency.

Measurement Uncertainty

The assessed measurement uncertainty to ensure 95% confidence level for the normal distribution is with the coverage factor $k = 1.96$, $U = 2.69$ dB.

Test Results:

Following plots, Blue trace uses the peak detection and Green trace uses the average detection. During the test, the Conducted Emission was performed in all modes (WIFI 2.4G) with all channels, 802.11n (HT40), Channel 9 of ESP32-S2-MINI-1 are selected as the worst condition. The test data of the worst-case condition was recorded in this report.

ESP32-S2-MINI-1

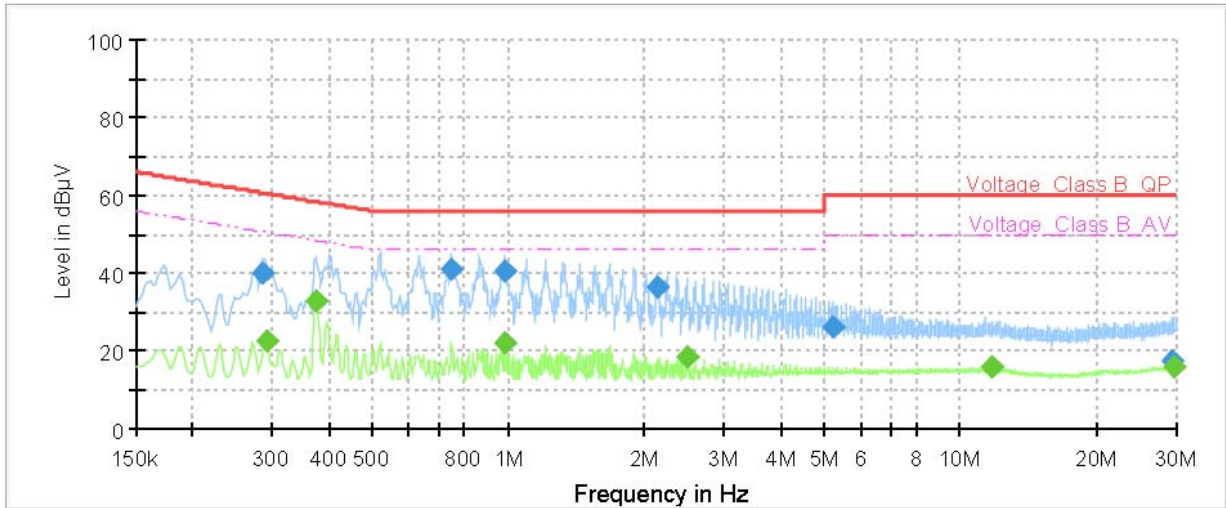

Frequency (MHz)	QuasiPeak (dBµV)	Average (dBµV)	Limit (dBµV)	Margin (dB)	Meas. Time (ms)	Bandwidth (kHz)	Line	Filter	Corr. (dB)
0.29	39.95	---	60.60	20.65	1000.0	9.000	L1	ON	19
0.29	---	22.52	50.47	27.95	1000.0	9.000	L1	ON	19
0.38	---	33.04	48.39	15.35	1000.0	9.000	L1	ON	19
0.75	41.02	---	56.00	14.98	1000.0	9.000	L1	ON	19
0.98	---	22.14	46.00	23.86	1000.0	9.000	L1	ON	19
0.98	40.54	---	56.00	15.46	1000.0	9.000	L1	ON	19
2.13	36.22	---	56.00	19.78	1000.0	9.000	L1	ON	19
2.48	---	18.66	46.00	27.34	1000.0	9.000	L1	ON	19
5.24	26.29	---	60.00	33.71	1000.0	9.000	L1	ON	19
11.76	---	15.75	50.00	34.25	1000.0	9.000	L1	ON	19
29.45	17.41	---	60.00	42.59	1000.0	9.000	L1	ON	20
29.70	---	15.95	50.00	34.05	1000.0	9.000	L1	ON	20

Remark: Correct factor=cable loss + LISN factor

L line Conducted Emission from 150 KHz to 30 MHz

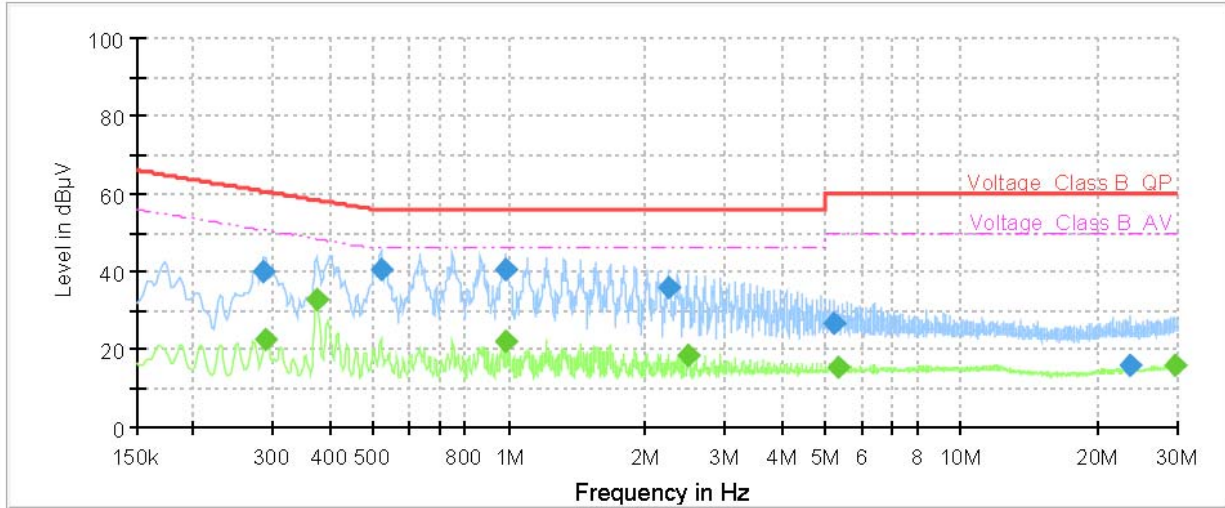

Frequency (MHz)	QuasiPeak (dBµV)	Average (dBµV)	Limit (dBµV)	Margin (dB)	Meas. Time (ms)	Bandwidth (kHz)	Line	Filter	Corr. (dB)
0.29	39.86	---	60.60	20.74	1000.0	9.000	N	ON	19
0.29	---	22.59	50.54	27.95	1000.0	9.000	N	ON	19
0.38	---	33.05	48.39	15.34	1000.0	9.000	N	ON	19
0.52	40.68	---	56.00	15.32	1000.0	9.000	N	ON	19
0.98	---	22.04	46.00	23.96	1000.0	9.000	N	ON	19
0.98	40.41	---	56.00	15.59	1000.0	9.000	N	ON	19
2.25	36.03	---	56.00	19.97	1000.0	9.000	N	ON	19
2.48	---	18.70	46.00	27.30	1000.0	9.000	N	ON	19
5.24	26.60	---	60.00	33.40	1000.0	9.000	N	ON	19
5.36	---	15.59	50.00	34.41	1000.0	9.000	N	ON	19
23.58	15.71	---	60.00	44.29	1000.0	9.000	N	ON	20
29.74	---	15.87	50.00	34.13	1000.0	9.000	N	ON	20

Remark: Correct factor=cable loss + LISN factor

N line Conducted Emission from 150 KHz to 30 MHz



6. Main Test Instruments

Name	Manufacturer	Type	Serial Number	Calibration Date	Expiration Date
Spectrum Analyzer	R&S	FSV30	100815	2019-12-15	2020-12-14
EMI Test Receiver	R&S	ESCI	100948	2020-05-18	2021-05-17
Loop Antenna	SCHWARZBECK	FMZB1519	1519-047	2020-04-02	2023-04-01
TRILOG Broadband Antenna	Schwarzbeck	VULB 9163	9163-201	2017-11-18	2020-11-17
Horn Antenna	R&S	HF907	102723	2018-08-11	2021-08-10
Horn Antenna	ETS-Lindgren	3160-09	00102643	2018-06-20	2021-06-19
EMI Test Receiver	R&S	ESR	101667	2020-05-18	2021-05-17
LISN	R&S	ENV216	101171	2018-12-15	2021-12-14
Spectrum Analyzer	Agilent	N9010A	MY47191109	2020-05-18	2021-05-17
Power Meter	R&S	NRP2	104306	2020-05-18	2021-05-17
Power Sensor	R&S	NRP-Z21	104799	2020-05-18	2021-05-17
20dB Attenuator	Star River Highlight	UCL-TS2S-20	18013001	2019-12-15	2020-12-14
RF Cable	Agilent	SMA 15cm	0001	2020-06-12	2020-12-11
Software	R&S	EMC32	9.26.0	/	/

*****END OF REPORT *****



ANNEX A: The EUT Appearance

The EUT Appearance are submitted separately.

ANNEX B: Test Setup Photos

The Test Setup Photos are submitted separately.