



RF TEST REPORT

Applicant Espressif Systems (Shanghai) Co.,Ltd.
FCC ID 2AC7Z-ESP32MINII
Product Wi-Fi & Bluetooth Internet of Things Module
Brand ESPRESSIF
Model ESP32-MINI-1U
Report No. R2105A0435-R1
Issue Date September 2, 2022

TA Technology (Shanghai) Co., Ltd. tested the above equipment in accordance with the requirements in **FCC CFR47 Part 15C (2021)**. The test results show that the equipment tested is capable of demonstrating compliance with the requirements as documented in this report.

Prepared by: Xu Ying

Approved by: Xu Kai

TA Technology (Shanghai) Co., Ltd.

Building 3, No.145, Jintang Rd, Tangzhen Industry Park, Pudong Shanghai, China

TEL: +86-021-50791141/2/3

FAX: +86-021-50791141/2/3-8000



TABLE OF CONTENT

1. Test Laboratory	4
1.1. Notes of the test report.....	4
1.2. Test facility	4
1.3. Testing Location.....	4
2. General Description of Equipment under Test.....	5
2.1. Applicant and Manufacturer Information.....	5
2.2. General information.....	5
3. Applied Standards	6
4. Test Configuration	7
5. Test Case Results	8
5.1. Maximum output power	8
5.2. 99% Bandwidth and 6dB Bandwidth	11
5.3. Band Edge	35
5.4. Power Spectral Density	52
5.5. Spurious RF Conducted Emissions.....	66
5.6. Unwanted Emission	89
5.7. Conducted Emission	137
6. Main Test Instruments.....	140
ANNEX A: The EUT Appearance	141
ANNEX B: Test Setup Photos	142



Summary of measurement results

Number	Test Case	Clause in FCC rules	Verdict
1	Maximum output power	15.247(b)(3)	PASS
2	6 dB bandwidth	15.247(a)(2)	PASS
3	Power spectral density	15.247(e)	PASS
4	Band Edge	15.247(d)	PASS
5	Spurious RF Conducted Emissions	15.247(d)	PASS
6	Unwanted Emissions	15.247(d),15.205,15.209	PASS
7	Conducted Emissions	15.207	PASS

Date of Testing: June 2, 2021~ September 17, 2021 and August 29, 2022 ~ September 1, 2022
Date of Sample Received: May 27, 2021

Note: All indications of Pass/Fail in this report are opinions expressed by TA Technology (Shanghai) Co., Ltd. based on interpretations and/or observations of test results. Measurement Uncertainties were not taken into account and are published for informational purposes only.



1. Test Laboratory

1.1. Notes of the test report

This report shall not be reproduced in full or partial, without the written approval of **TA technology (shanghai) co., Ltd.** The results documented in this report apply only to the tested sample, under the conditions and modes of operation as described herein .Measurement Uncertainties were not taken into account and are published for informational purposes only. This report is written to support regulatory compliance of the applicable standards stated above.

1.2. Test facility

FCC (Designation number: CN1179, Test Firm Registration Number: 446626)

TA Technology (Shanghai) Co., Ltd. has been listed on the US Federal Communications Commission list of test facilities recognized to perform measurements.

A2LA (Certificate Number: 3857.01)

TA Technology (Shanghai) Co., Ltd. has been listed by American Association for Laboratory Accreditation to perform measurement.

1.3. Testing Location

Company: TA Technology (Shanghai) Co., Ltd.
Address: Building 3, No.145, Jintang Rd, Tangzhen Industry Park, Pudong Shanghai, China
City: Shanghai
Post code: 201201
Country: P. R. China
Contact: Xu Kai
Telephone: +86-021-50791141/2/3
Fax: +86-021-50791141/2/3-8000
Website: <http://www.ta-shanghai.com>
E-mail: xukai@ta-shanghai.com

2. General Description of Equipment under Test

2.1. Applicant and Manufacturer Information

Applicant	Espressif Systems (Shanghai) Co.,Ltd.
Applicant address	Suite 204, Block 2, 690 Bibo Road, Zhang Jiang Hi-Tech Park, Shanghai, China
Manufacturer	Espressif Systems (Shanghai) Co.,Ltd.
Manufacturer address	Suite 204, Block 2, 690 Bibo Road, Zhang Jiang Hi-Tech Park, Shanghai, China

2.2. General information

EUT Description	
Model	ESP32-MINI-1U
Lab internal SN	R2105A0435/S01
Hardware Version	V1.0
Software Version	V171
Power Supply	External power supply
Antenna Type	IPEX Antenna
Antenna Connector	A permanently attached antenna (meet with the standard FCC Part 15.203 requirement)
Antenna Gain	2.33dBi
additional beamforming gain	NA
Test Mode	802.11b, 802.11g, 802.11n(HT20/HT40) Bluetooth LE V4.2
Modulation Type	802.11b: DSSS 802.11g/n(HT20/HT40): OFDM Bluetooth LE: GFSK
Operating Frequency Range(s)	802.11b/g/n(HT20): 2412 ~ 2462 MHz 802.11n(HT40): 2422 ~ 2452 MHz Bluetooth LE: 2402 ~2480 MHz
Note: 1. The EUT is sent from the applicant to TA and the information of the EUT is declared by the applicant.	



3. Applied Standards

According to the specifications of the manufacturer, it must comply with the requirements of the following standards:

Test standards:

FCC CFR47 Part 15C (2021) Radio Frequency Devices

ANSI C63.10-2013

Reference standard:

KDB 558074 D01 15.247 Meas Guidance v05r02



4. Test Configuration

Test Mode

The EUT has been associated with peripherals and configuration operated in a manner tended to maximize its emission characteristics in a typical application.

The radiated emission was measured in the following position: EUT stand-up position (Z axis), lie-down position (X, Y axis). The worst emission was found in lie-down position (X axis) and the loop antenna is vertical, the others are vertical and horizontal. and the worst case was recorded.

In order to find the worst case condition, Pre-tests are needed at the presence of different data rate. Preliminary tests have been done on all the configuration for confirming worst case. Data rate below means worst-case rate of each test item.

Test Mode	Data Rate
Bluetooth(Low Energy)	1Mbps
802.11b	1 Mbps
802.11g	6 Mbps
802.11n HT20	MCS0
802.11n HT40	MCS0

5. Test Case Results

5.1. Maximum output power

Ambient condition

Temperature	Relative humidity	Pressure
23°C ~25°C	45%~50%	101.5kPa

Methods of Measurement

During the process of the testing, The EUT was connected to Power meter with a known loss. The EUT is max power transmission with proper modulation.

Test Setup

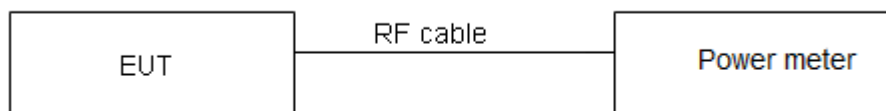

Limits

Rule Part 15.247 (b) (3) specifies that " For systems using digital modulation in the 902–928 MHz, 2400–2483.5 MHz: 1 Watt."

Average Output Power	$\leq 1W$ (30dBm)
----------------------	-------------------

Measurement Uncertainty

The assessed measurement uncertainty to ensure 95% confidence level for the normal distribution is with the coverage factor $k = 2$, $U = 0.44$ dB.

**Test Results**

Power Index					
Channel	802.11b	802.11g	802.11n HT20	Channel	802.11n HT40
CH1	16	12	14	CH3	20
CH2	/	0	0	CH4	0
CH6	16	0	0	CH6	0
CH10	/	0	0	CH8	0
CH11	16	12	12	CH9	16

Test Mode	Duty cycle	Duty cycle correction Factor(dB)
802.11b	1.00	0.00
802.11g	1.00	0.00
802.11n HT20	1.00	0.00
802.11n HT40	1.00	0.00
Bluetooth LE	0.84	0.77

Note: when Duty cycle ≥ 0.98 , Duty cycle correction Factor not required.



Test Mode	Carrier frequency (MHz) / Channel	Average Power Measured (dBm)	Average Power with duty factor (dBm)	Limit (dBm)	Conclusion
802.11b	2412/CH1	14.43	14.43	30	PASS
	2437/CH6	14.41	14.41	30	PASS
	2462/CH11	14.43	14.43	30	PASS
802.11g	2412/CH1	13.97	13.97	30	PASS
	2417/CH2	16.54	16.54	30	PASS
	2437/CH6	16.29	16.29	30	PASS
	2457/CH10	16.42	16.42	30	PASS
	2462/CH11	13.82	13.82	30	PASS
802.11n HT20	2412/CH1	13.42	13.42	30	PASS
	2417/CH2	16.51	16.51	30	PASS
	2437/CH6	16.17	16.17	30	PASS
	2457/CH10	16.26	16.26	30	PASS
	2462/CH11	13.73	13.73	30	PASS
802.11n HT40	2422/CH3	11.44	11.44	30	PASS
	2427/CH4	15.77	15.77	30	PASS
	2437/CH6	15.89	15.89	30	PASS
	2447/CH8	15.43	15.43	30	PASS
	2452/CH9	11.93	11.93	30	PASS
Bluetooth (Low Energy)	2402/CH0	7.18	7.95	30	PASS
	2440/CH19	7.21	7.98	30	PASS
	2480/CH39	6.91	7.68	30	PASS

Note: Average Power with duty factor = Average Power Measured +Duty cycle correction factor

5.2. 99% Bandwidth and 6dB Bandwidth

Ambient condition

Temperature	Relative humidity	Pressure
23°C ~25°C	45%~50%	101.5kPa

Method of Measurement

The EUT was connected to the spectrum analyzer through an external attenuator (20dB) and a known loss cable. RBW is set to 100 kHz; VBW is set to 300 kHz on spectrum analyzer. Dector=Peak, Trace mode=max hold.

The EUT was connected to the spectrum analyzer through a known loss cable. The resolution bandwidth (RBW) shall be in the range of 1% to 5% of the actual occupied / x dB bandwidth and the video bandwidth (VBW) shall not be smaller than three times the RBW value.

Test Setup

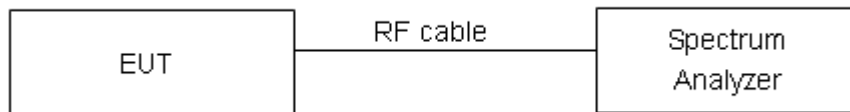

Limits

Rule Part 15.247 (a) (2) specifies that “Systems using digital modulation techniques may operate in the 902–928 MHz, 2400–2483.5 MHz bands. The minimum 6 dB bandwidth shall be at least 500 kHz.”

minimum 6 dB bandwidth	≥ 500 kHz
------------------------	-----------

Measurement Uncertainty

The assessed measurement uncertainty to ensure 95% confidence level for the normal distribution is with the coverage factor $k = 2$, $U = 936$ Hz.

**Test Results:**

Test Mode	Carrier frequency (MHz))/ Channel	99% bandwidth (MHz)	Minimum 6 dB bandwidth (MHz)	Limit (kHz)	Conclusion
802.11b	2412/CH1	13.192	8.87	500	PASS
	2437/CH6	13.109	10.02	500	PASS
	2462/CH11	13.095	9.57	500	PASS
802.11g	2412/CH1	16.530	16.41	500	PASS
	2417/CH2	16.540	16.40	500	PASS
	2437/CH6	16.552	16.39	500	PASS
	2457/CH10	16.539	16.43	500	PASS
	2462/CH11	16.577	16.40	500	PASS
802.11n HT20	2412/CH1	17.381	17.33	500	PASS
	2417/CH2	17.400	17.33	500	PASS
	2437/CH6	17.384	17.34	500	PASS
	2457/CH10	17.391	17.28	500	PASS
	2462/CH11	17.373	17.31	500	PASS
802.11n HT40	2422/CH3	34.699	33.53	500	PASS
	2427/CH4	34.700	33.21	500	PASS
	2437/CH6	34.711	33.50	500	PASS
	2447/CH8	34.630	33.15	500	PASS
	2452/CH9	34.687	33.31	500	PASS
Bluetooth (Low Energy)	2402/CH0	1.019	1.02	500	PASS
	2440/CH19	1.023	1.02	500	PASS
	2480/CH39	1.018	1.02	500	PASS



99%bandwidth

OBW 802.11b 2412MHz

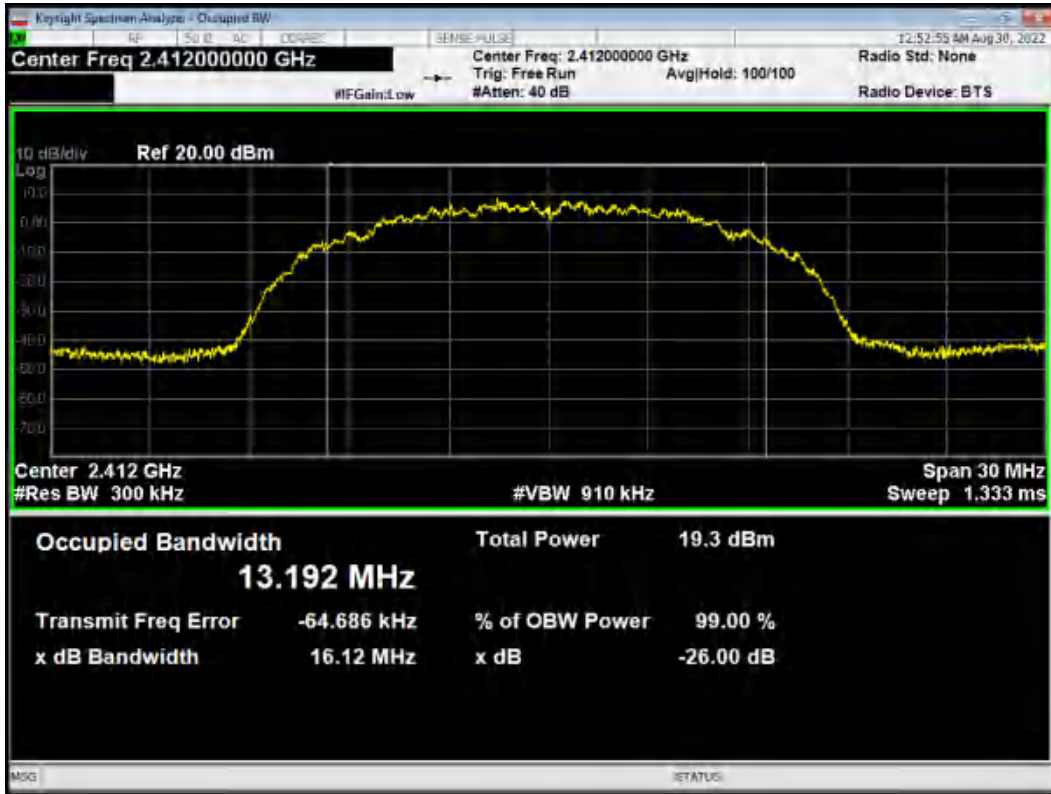

OBW 802.11b 2437MHz

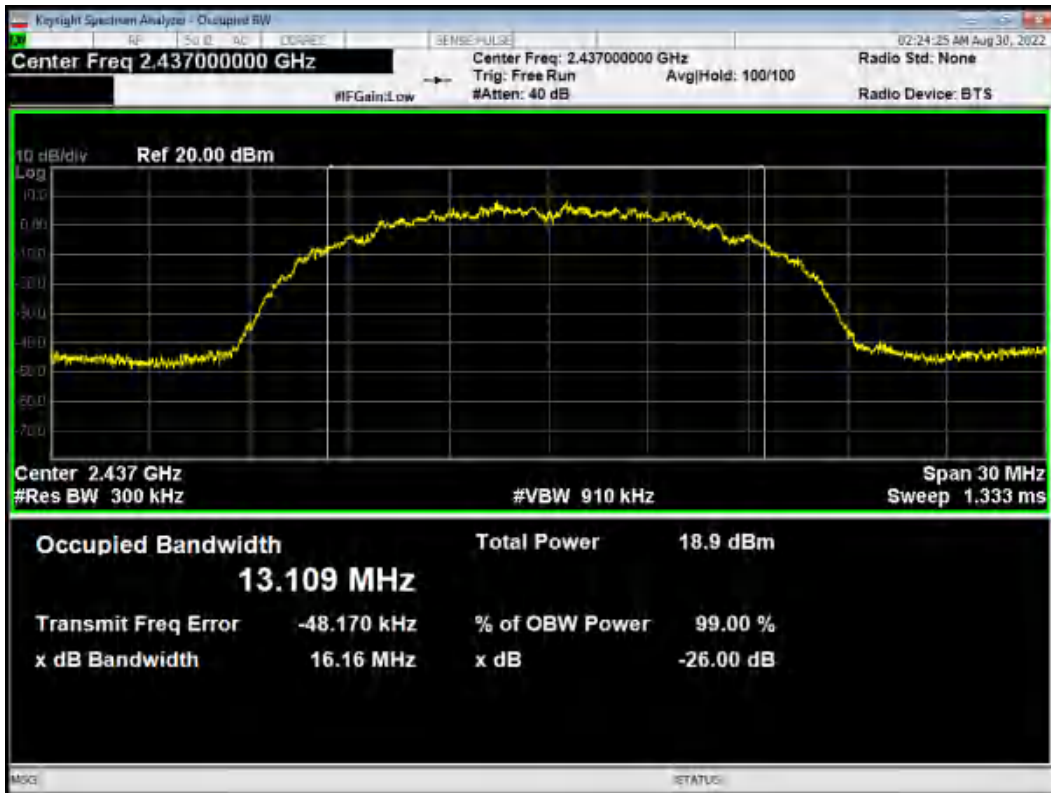



OBW 802.11b 2462MHz



OBW 802.11g 2412MHz

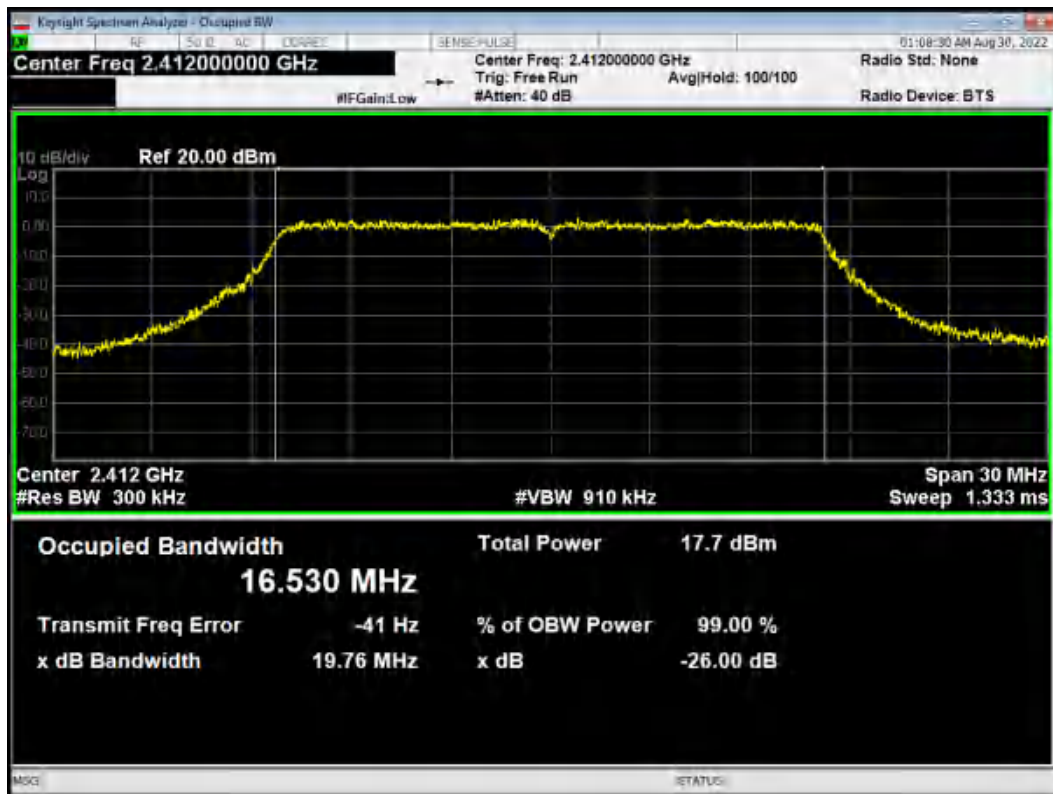



OBW 802.11g 2417MHz

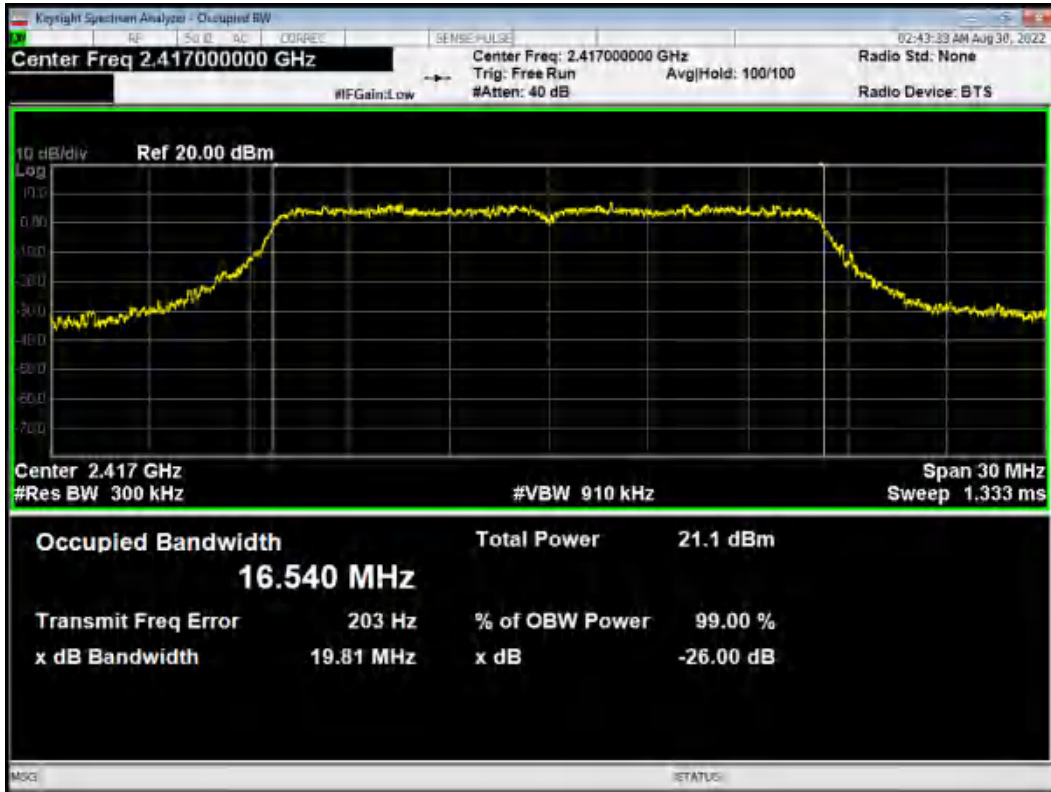

OBW 802.11g 2437MHz

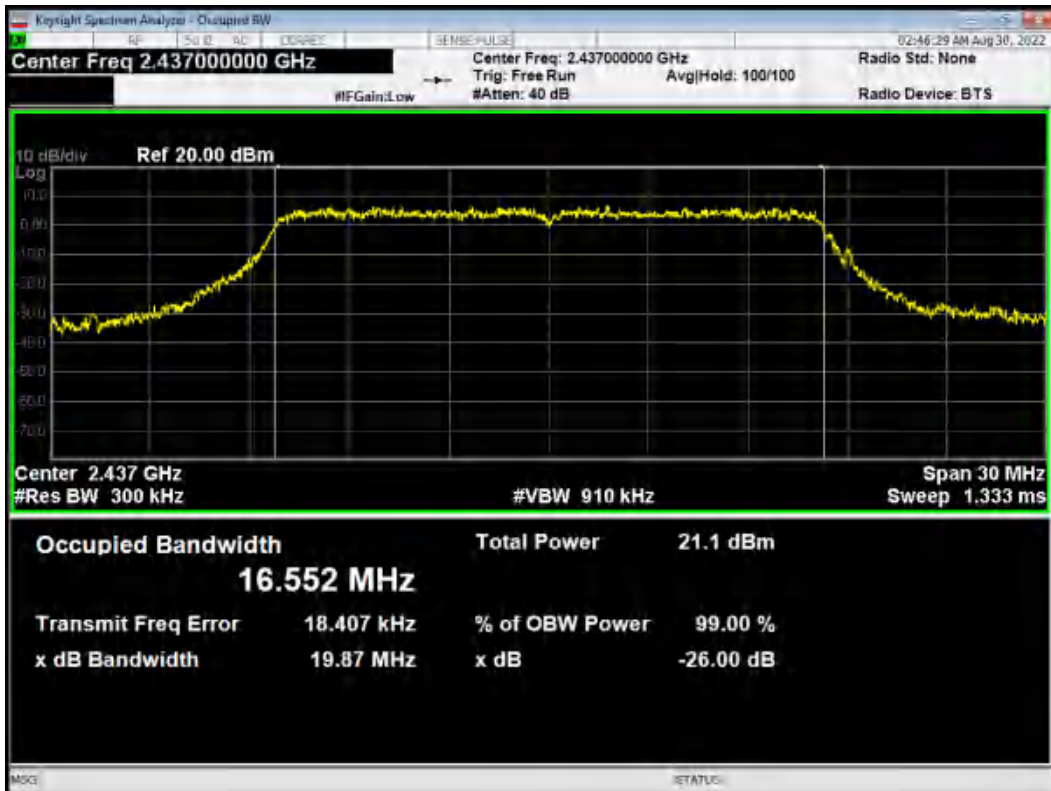



OBW 802.11g 2457MHz

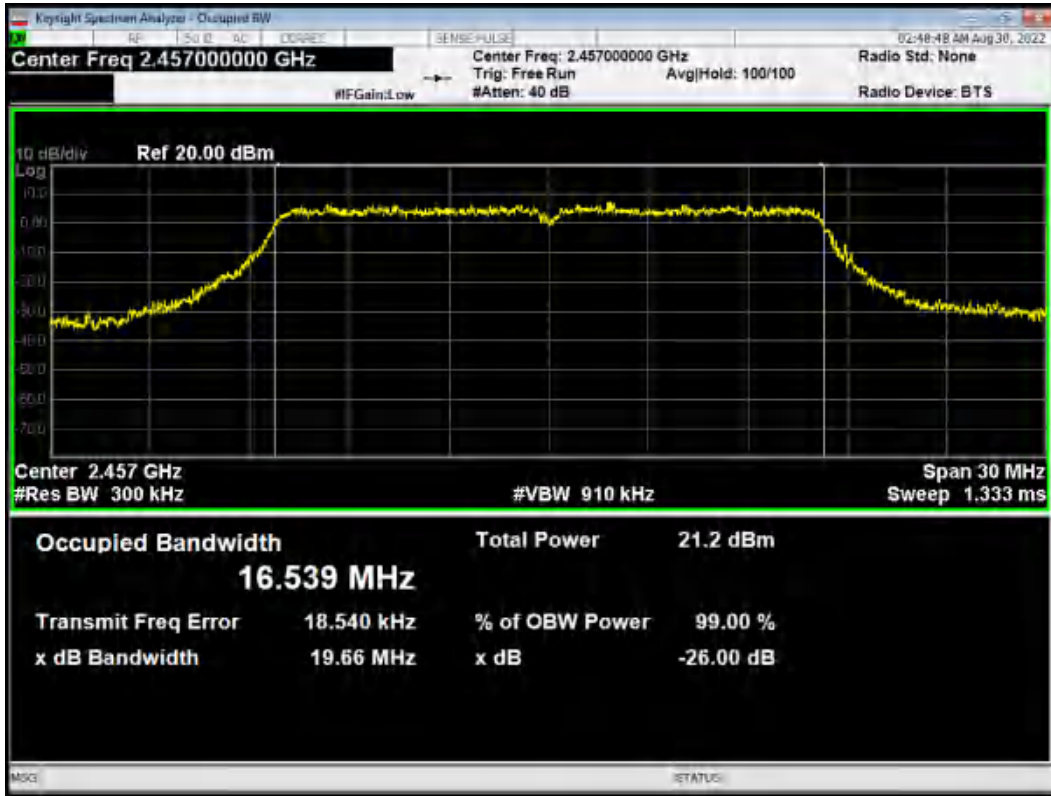

OBW 802.11g 2462MHz

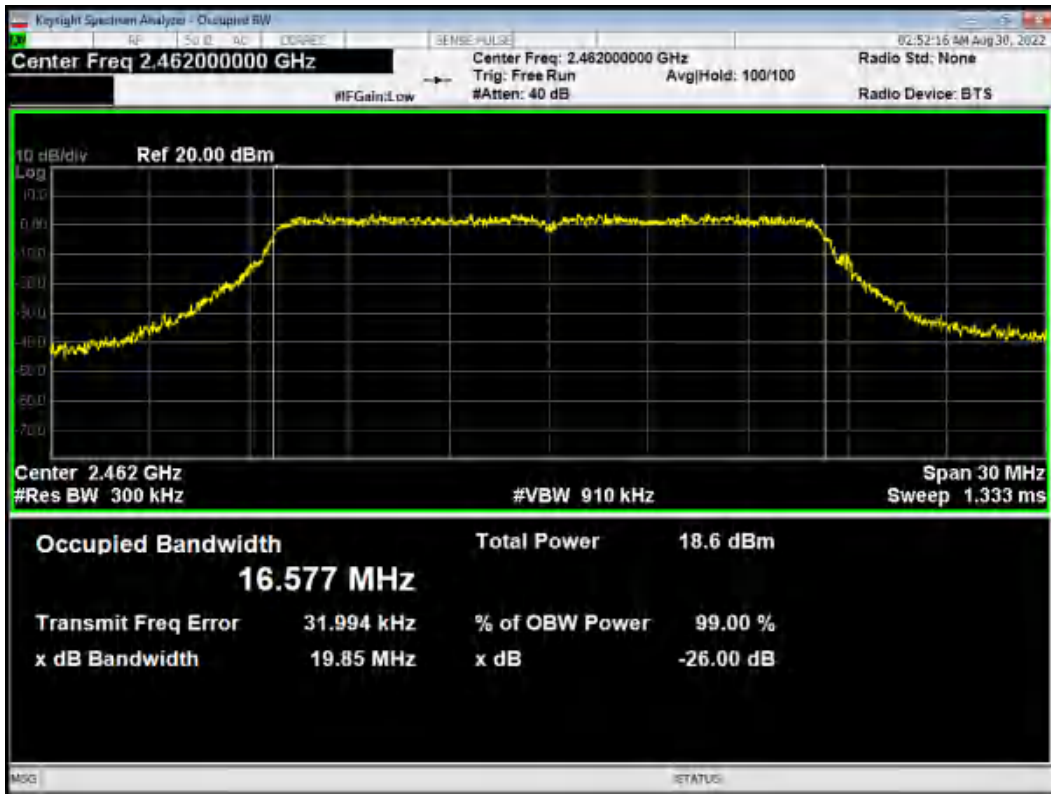



OBW 802.11n(HT20) 2412MHz

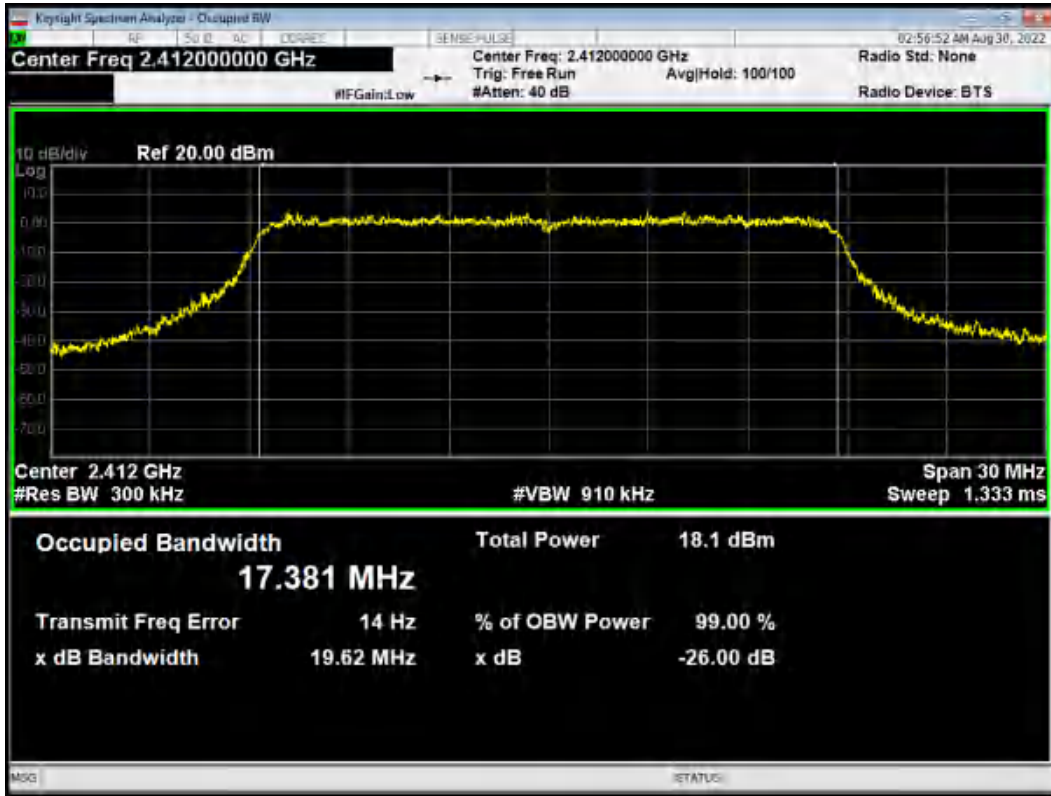

OBW 802.11n(HT20) 2417MHz

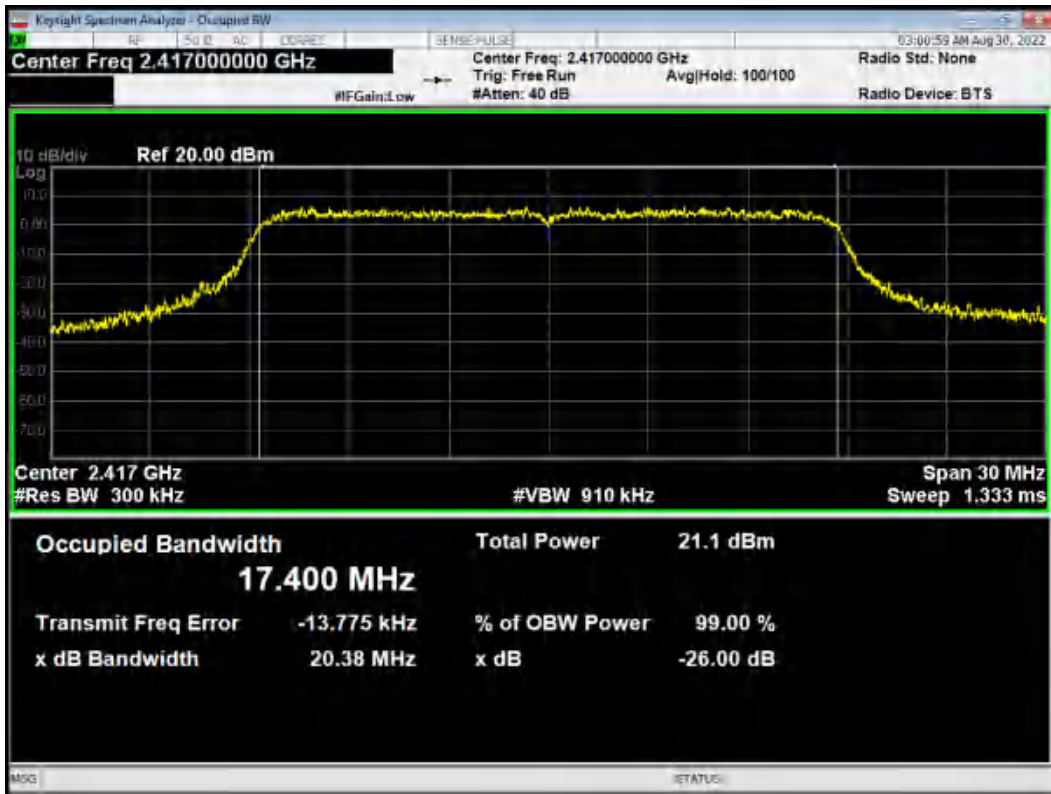



OBW 802.11n(HT20) 2437MHz

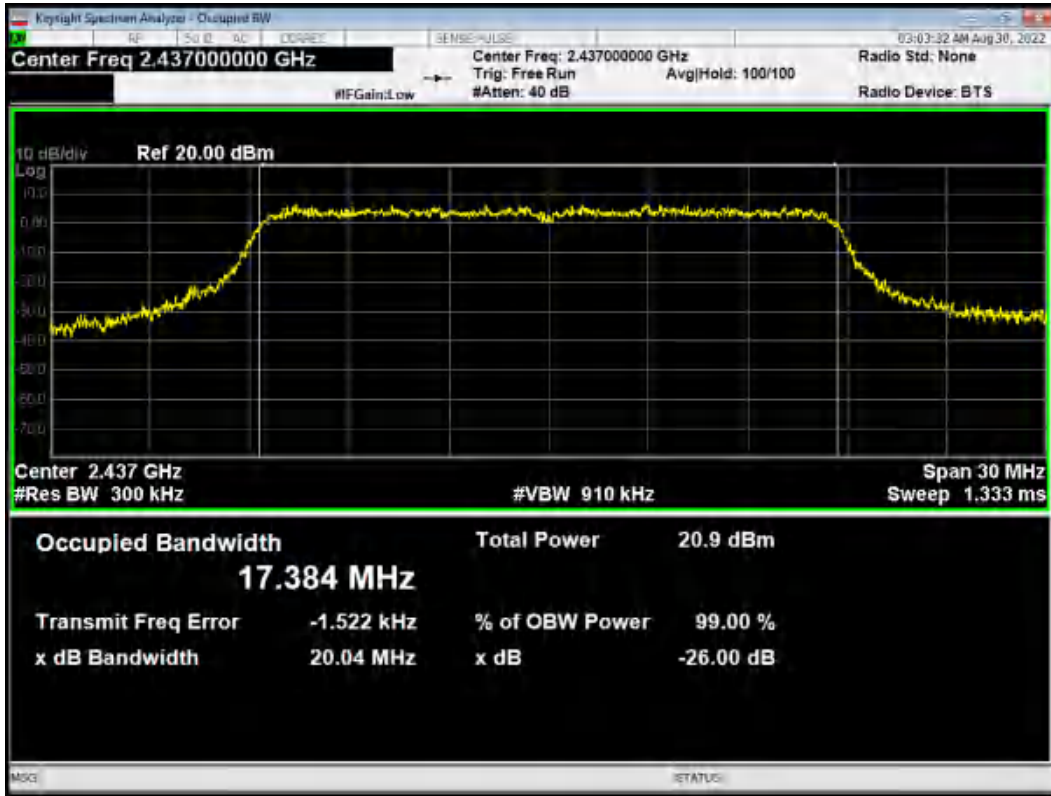

OBW 802.11n(HT20) 2457MHz

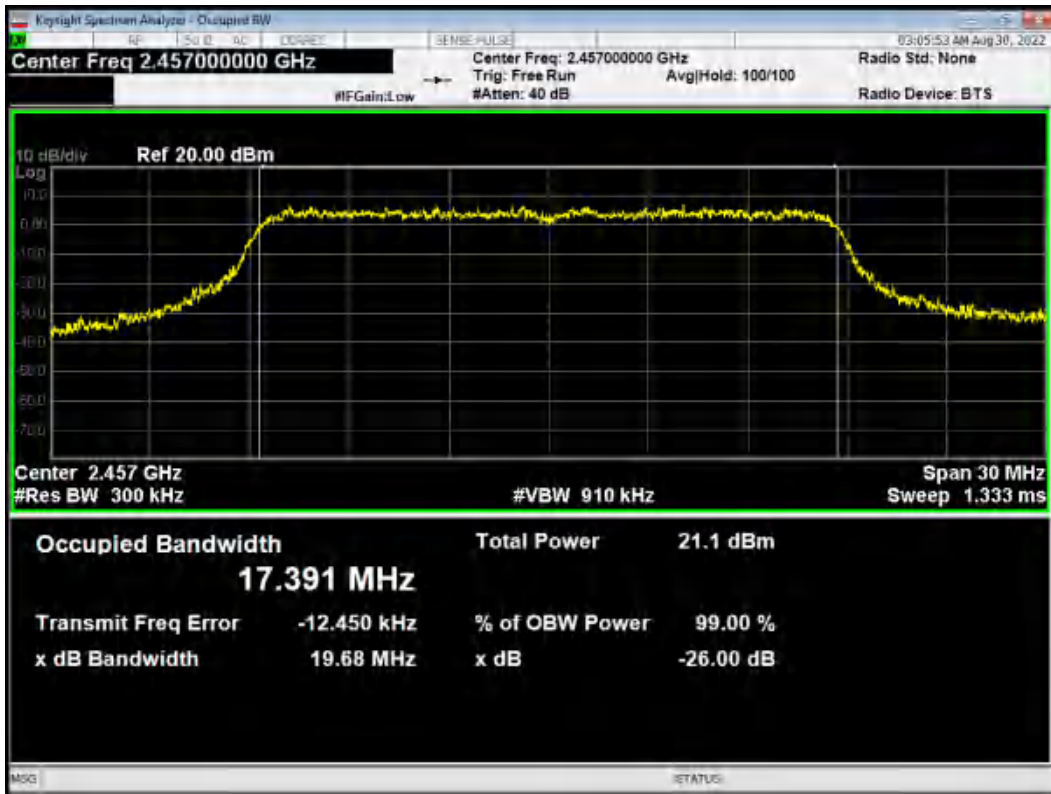



OBW 802.11n(HT20) 2462MHz

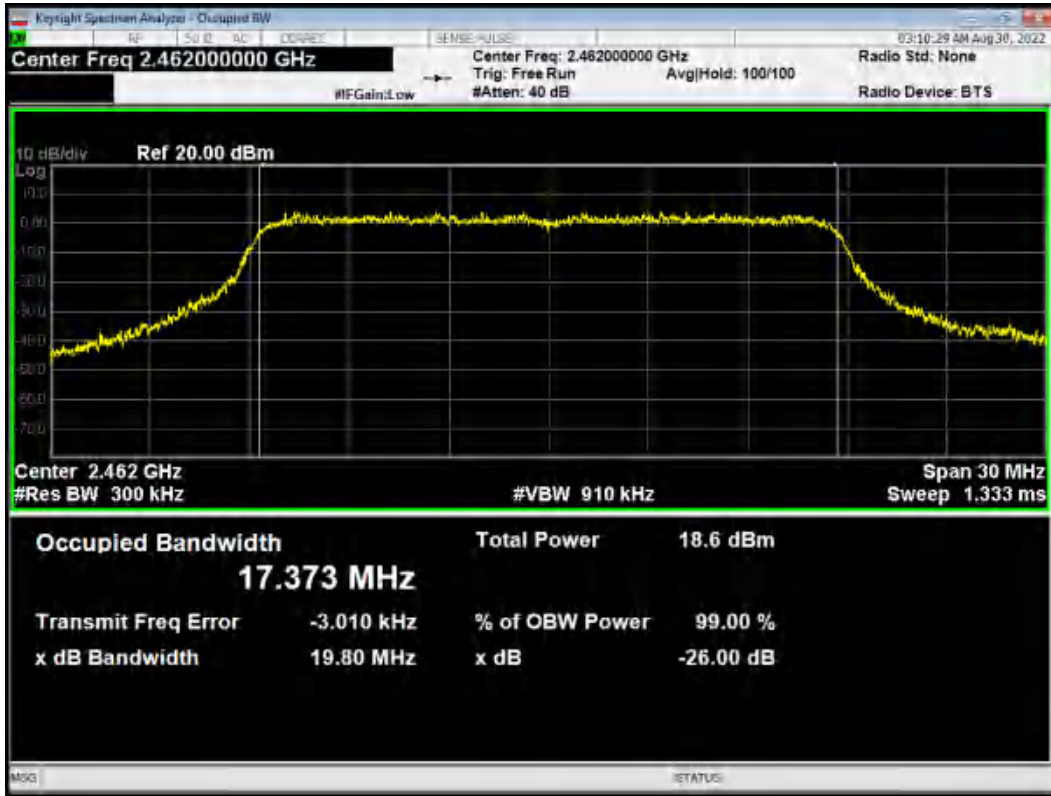

OBW 802.11n(HT40) 2422MHz

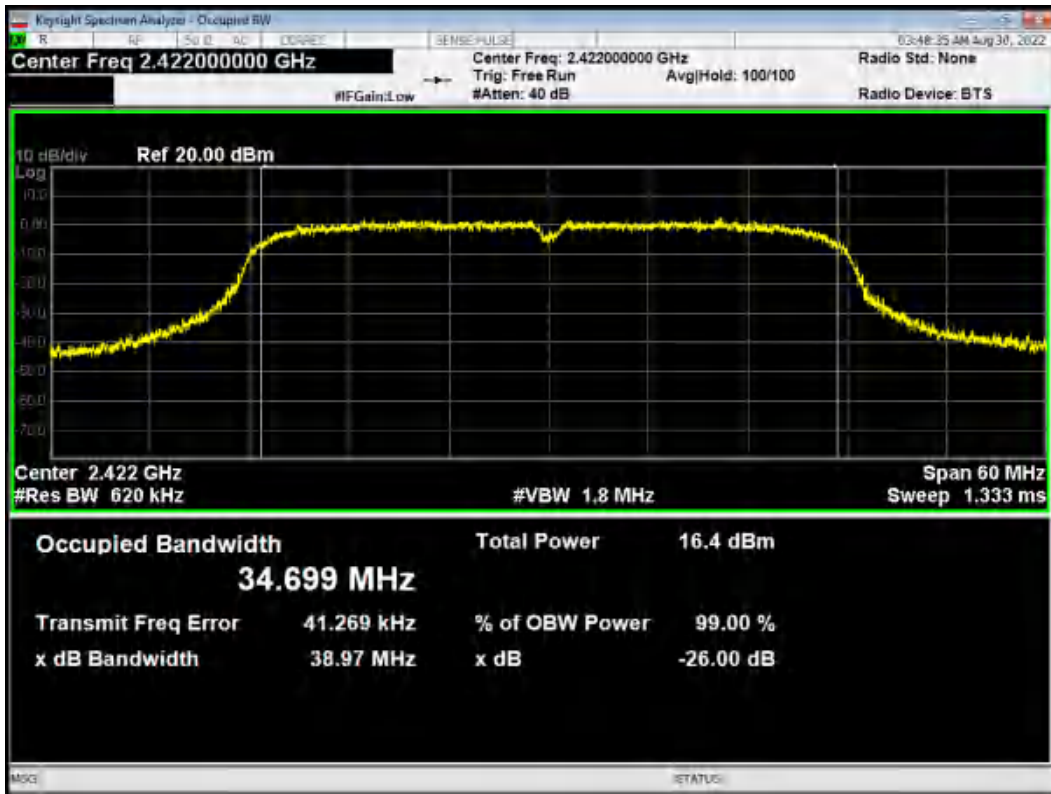



OBW 802.11n(HT40) 2427MHz

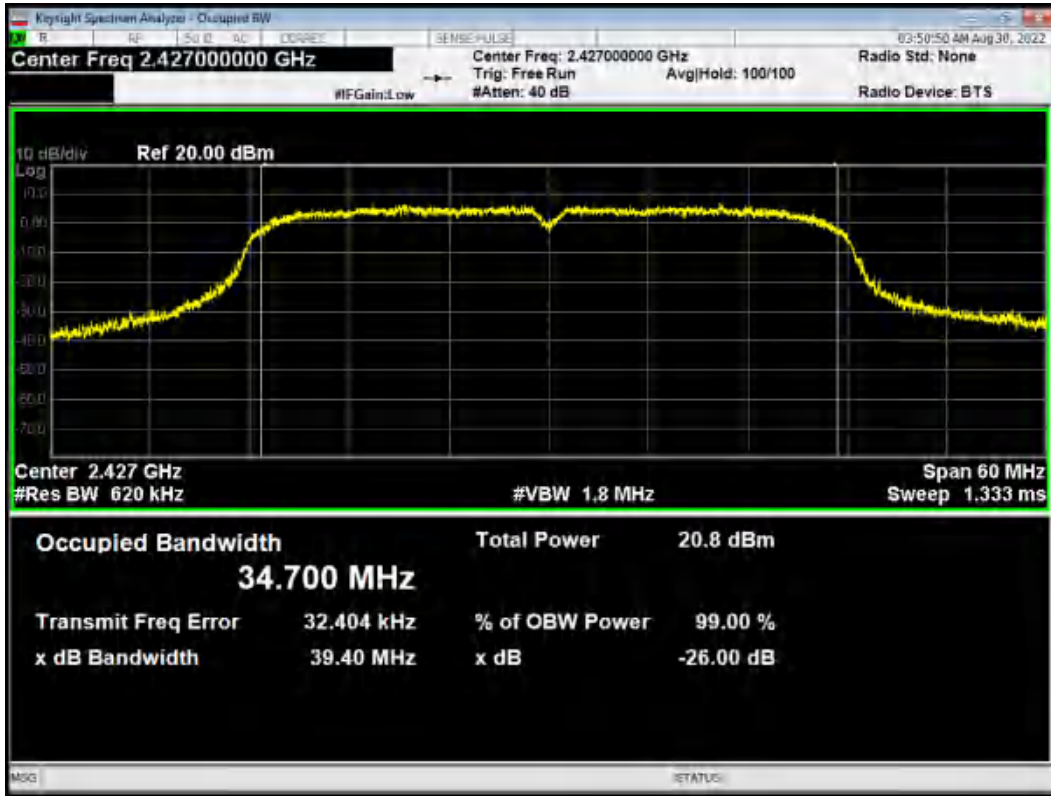

OBW 802.11n(HT40) 2437MHz

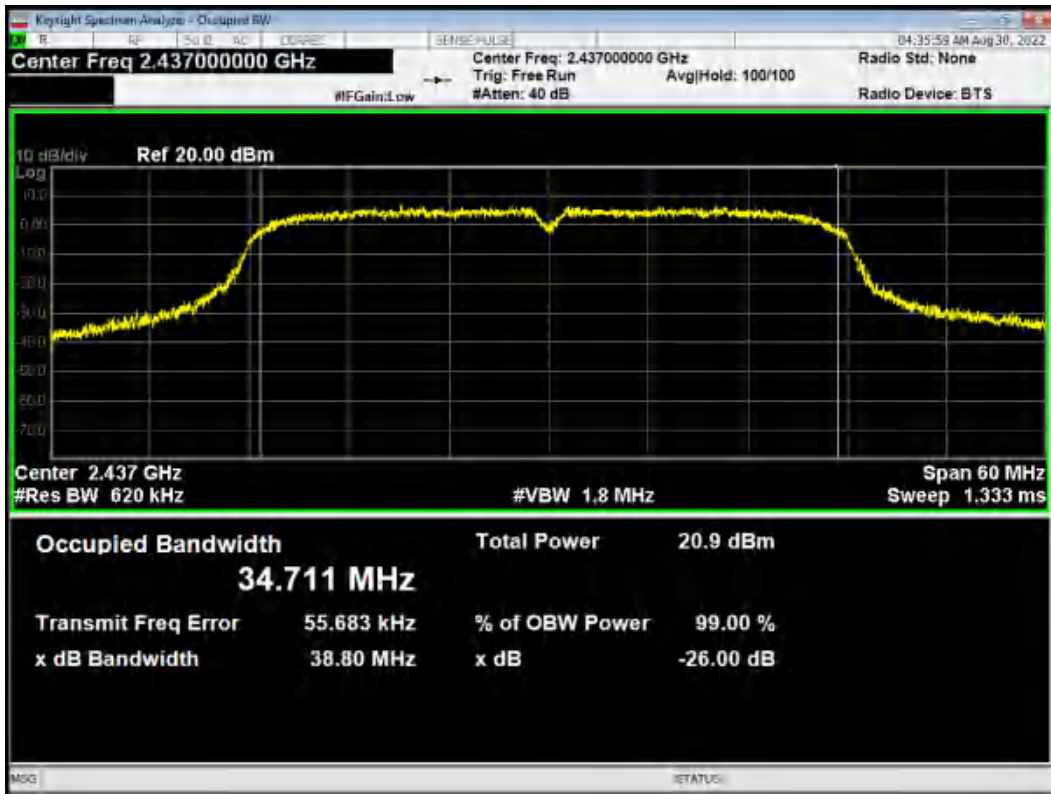



OBW 802.11n(HT40) 2447MHz

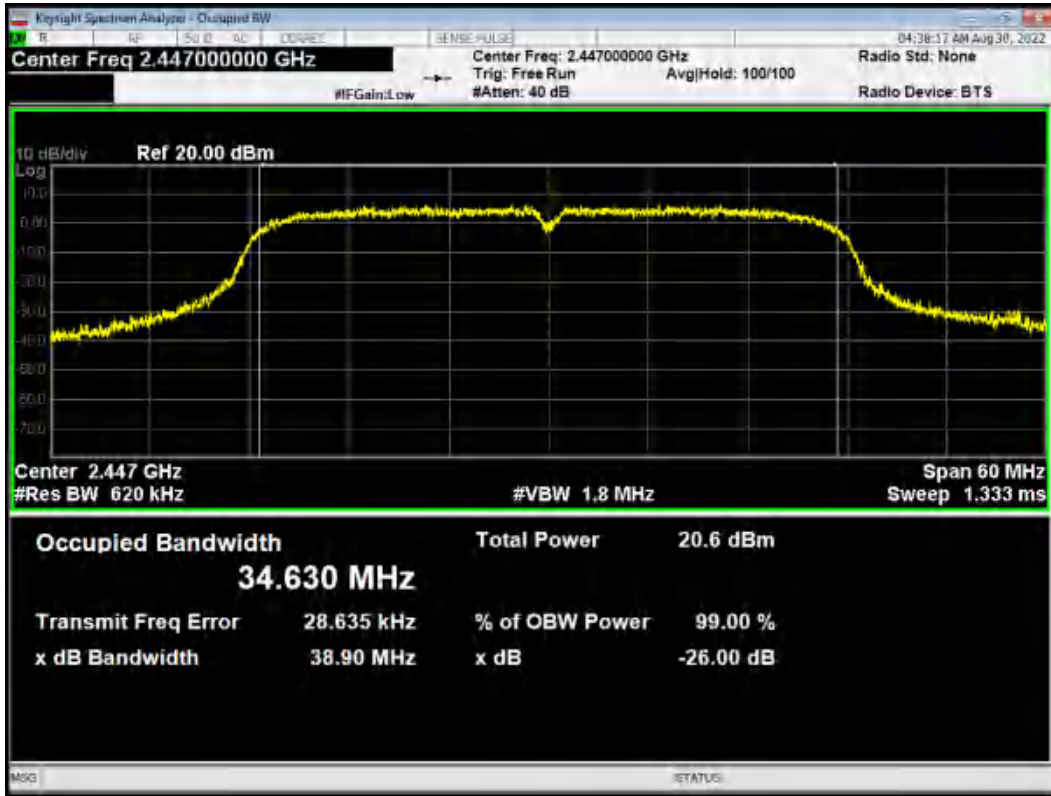

OBW 802.11n(HT40) 2452MHz

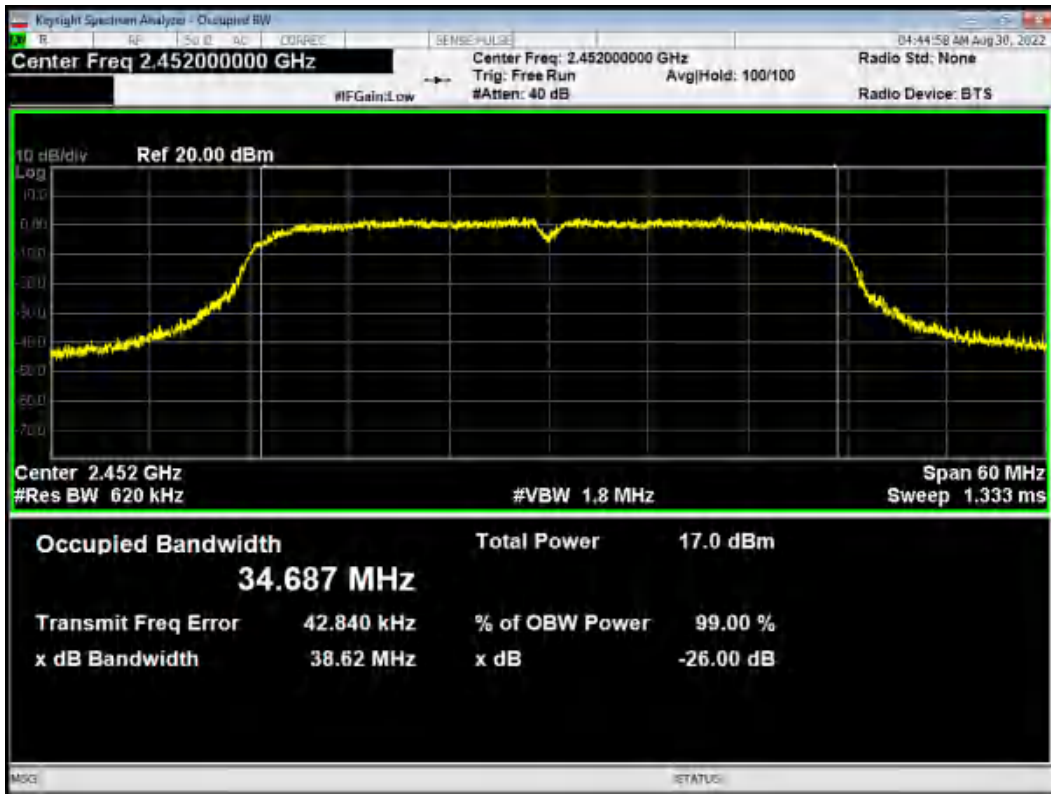



OBW BLE 2402MHz



OBW BLE 2440MHz

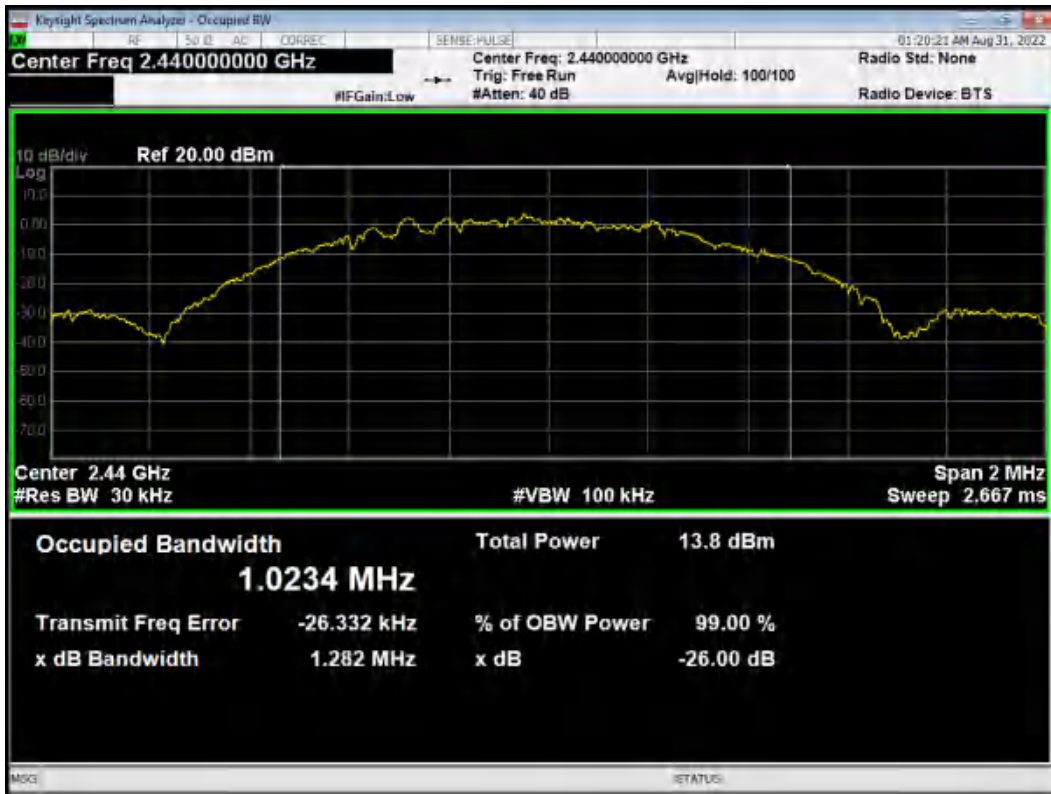



OBW BLE 2480MHz

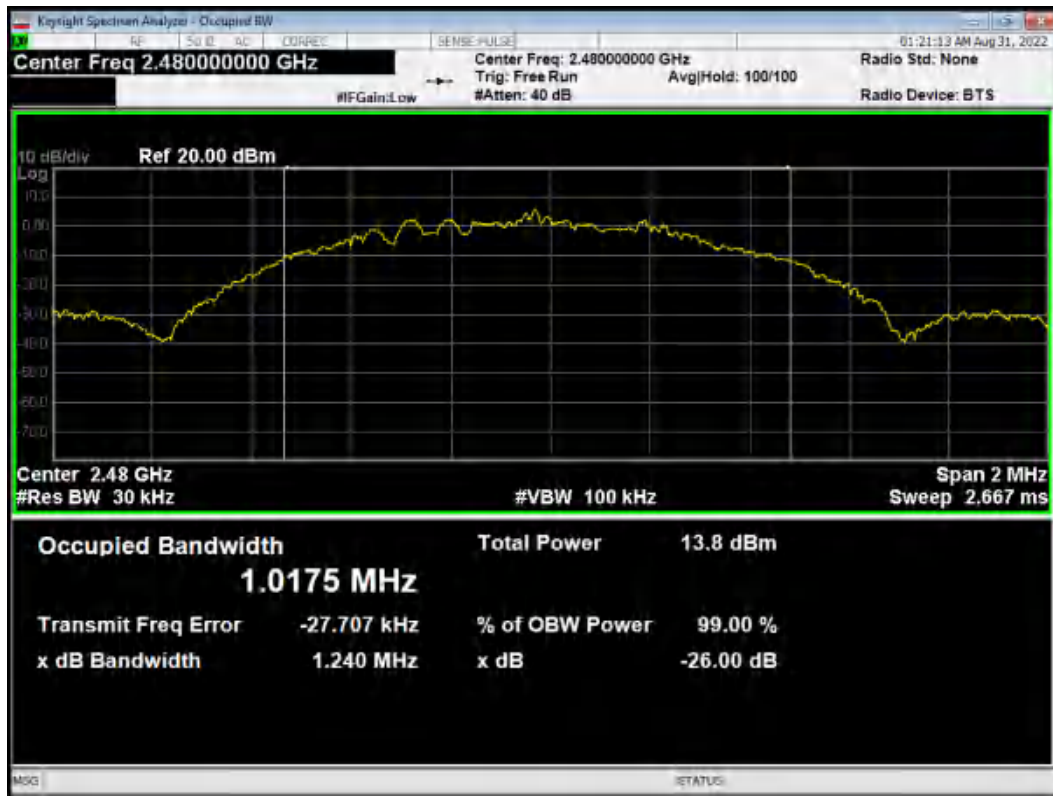



6 dB bandwidth

-6dB Bandwidth 802.11b 2412MHz

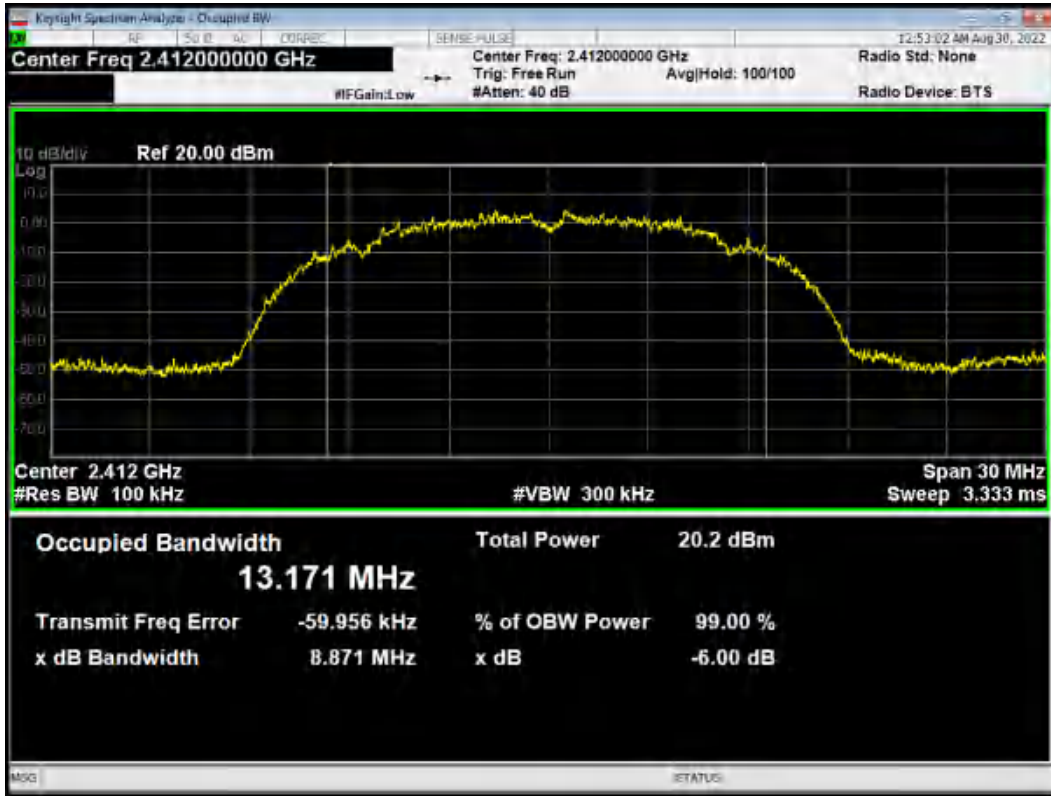

-6dB Bandwidth 802.11b 2437MHz

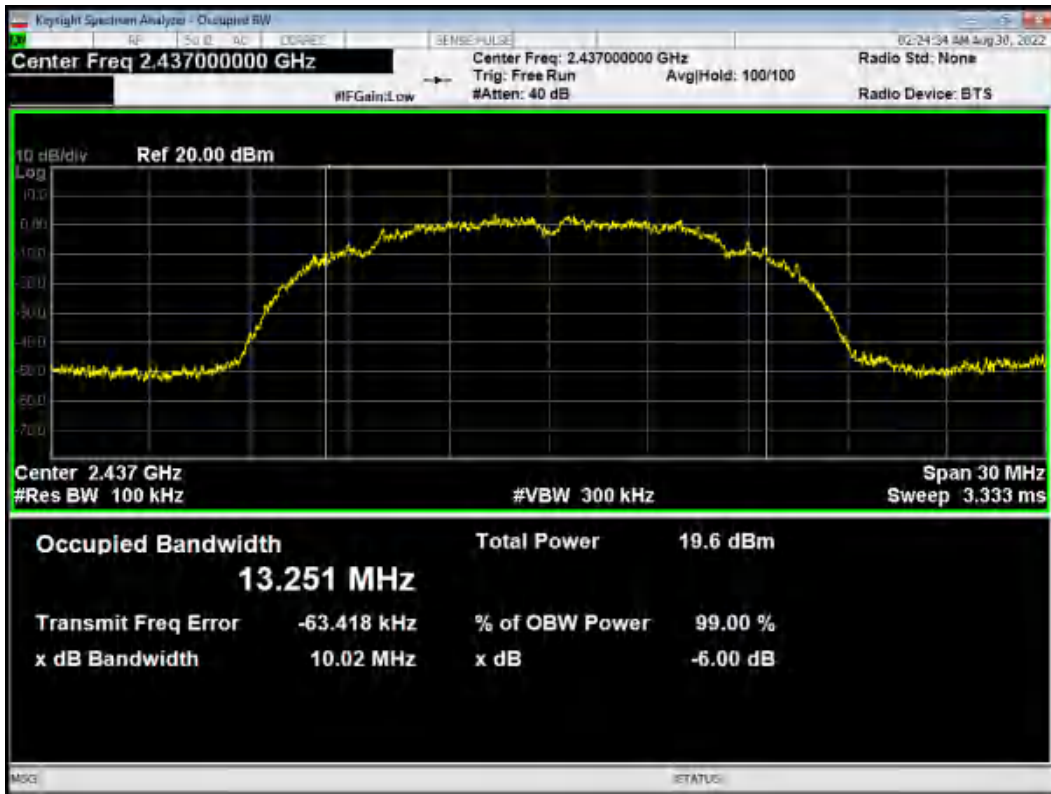



-6dB Bandwidth 802.11b 2462MHz

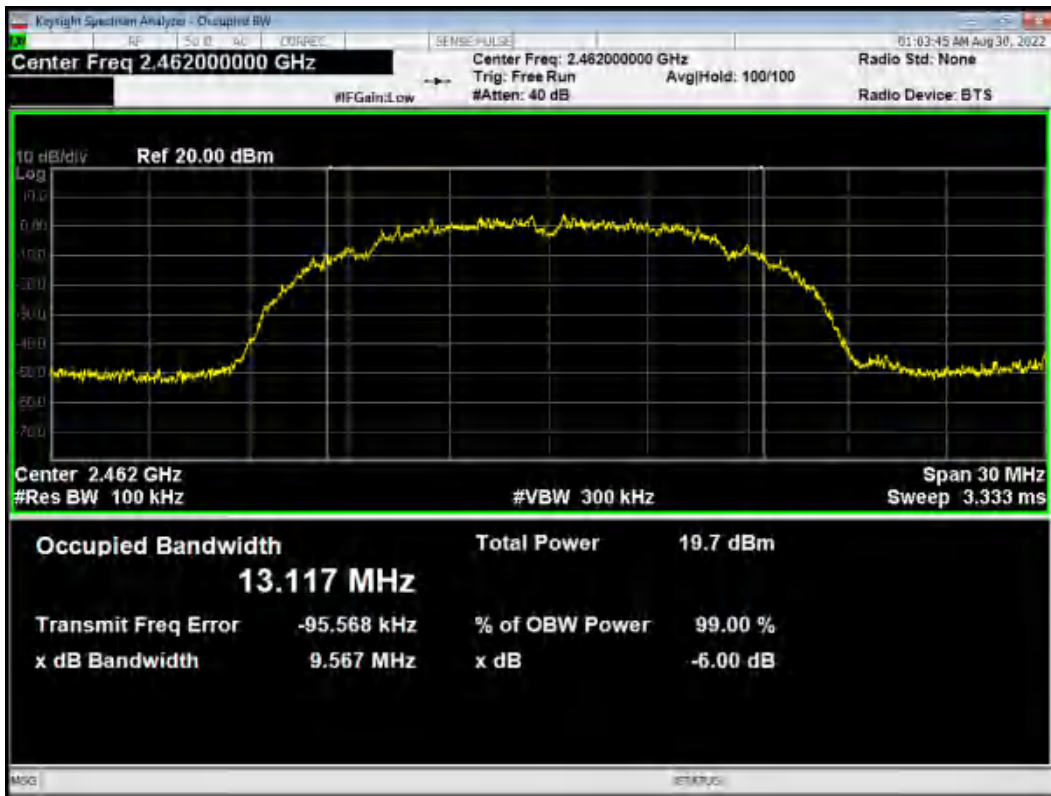

-6dB Bandwidth 802.11g 2412MHz

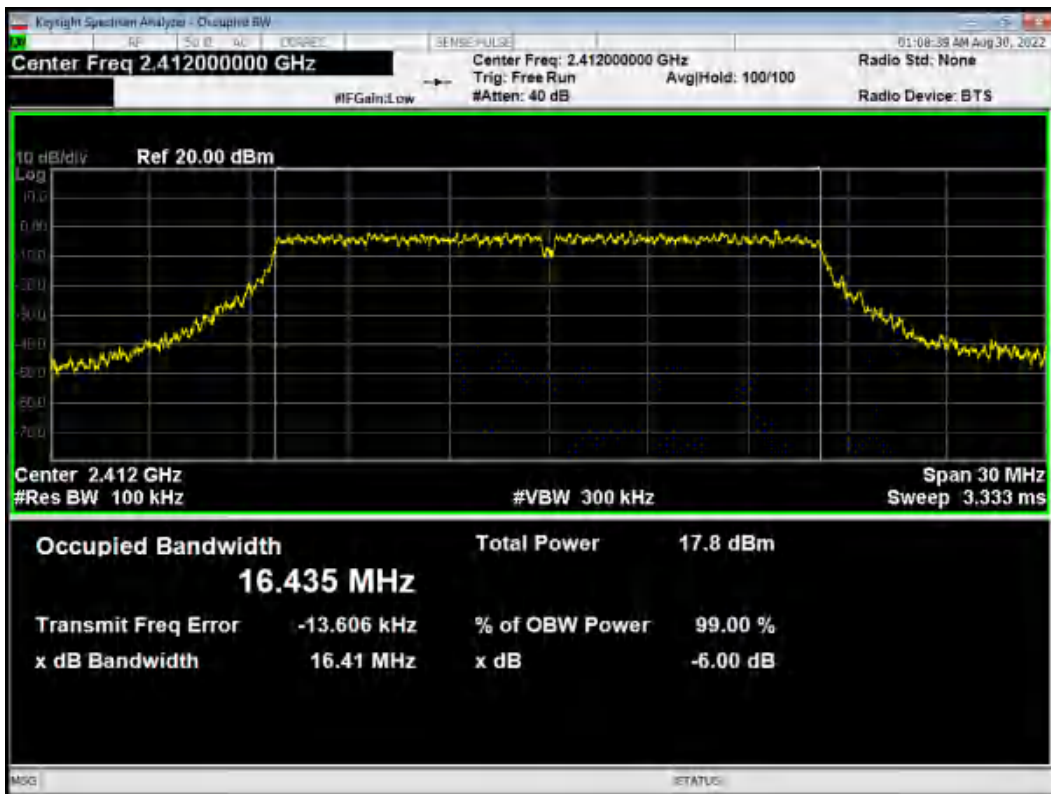



-6dB Bandwidth 802.11g 2417MHz

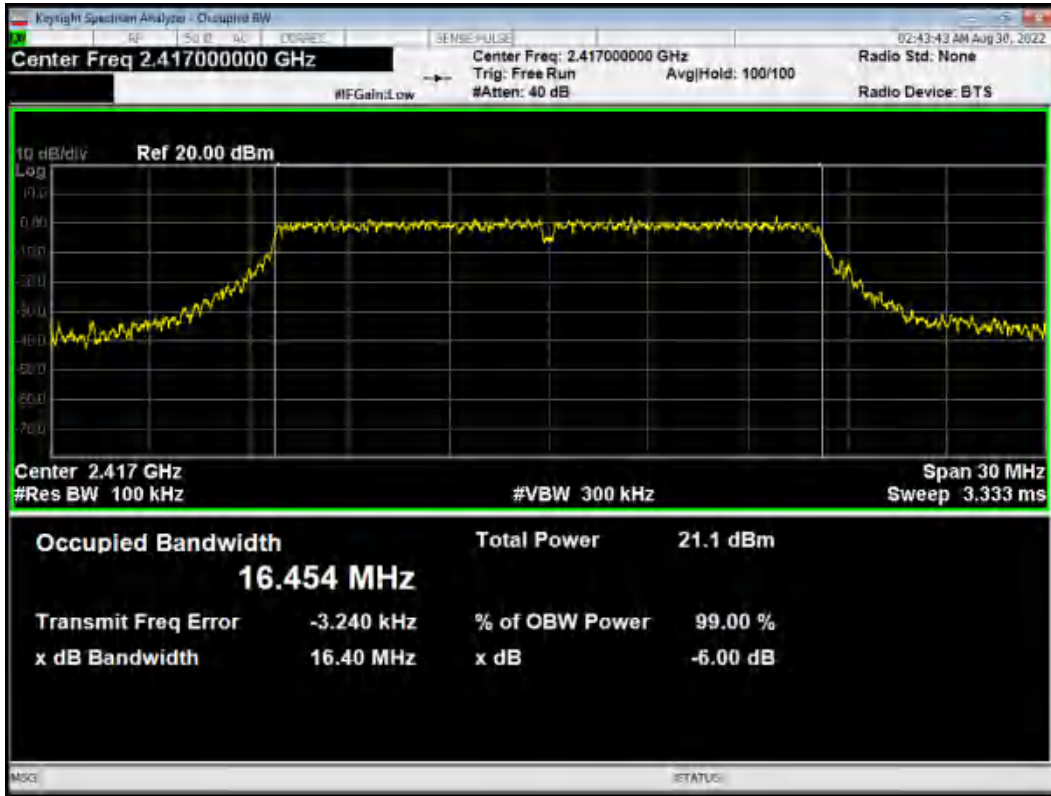

-6dB Bandwidth 802.11g 2437MHz

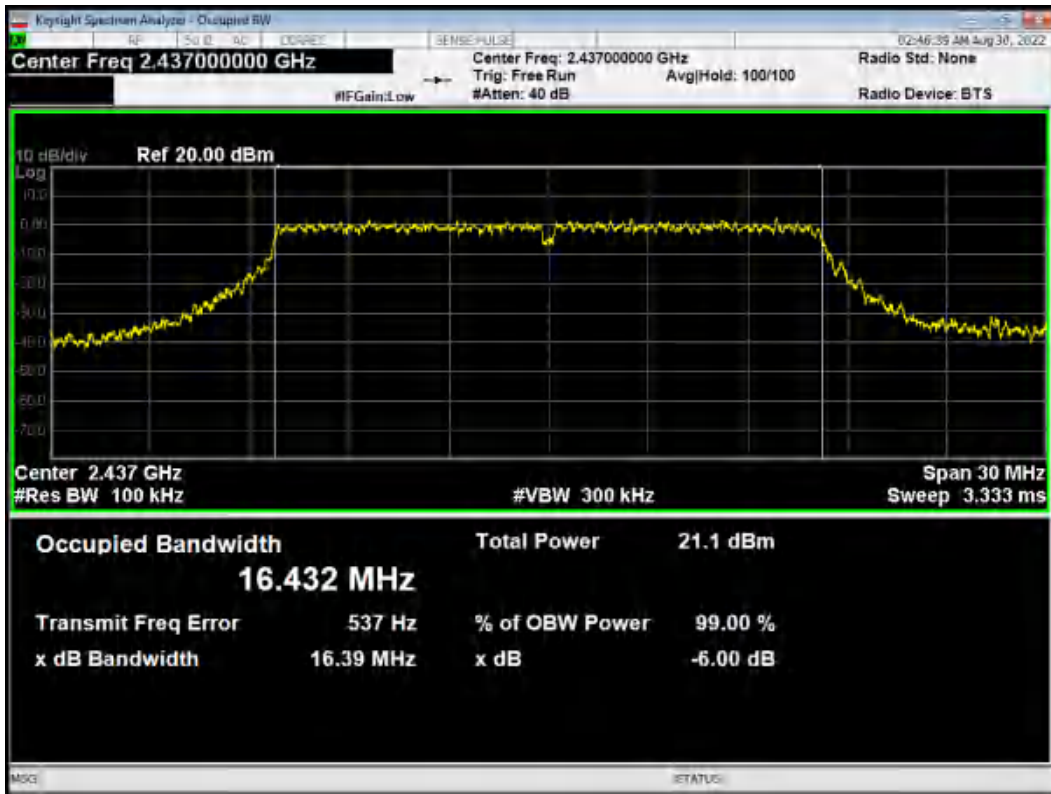



-6dB Bandwidth 802.11g 2457MHz

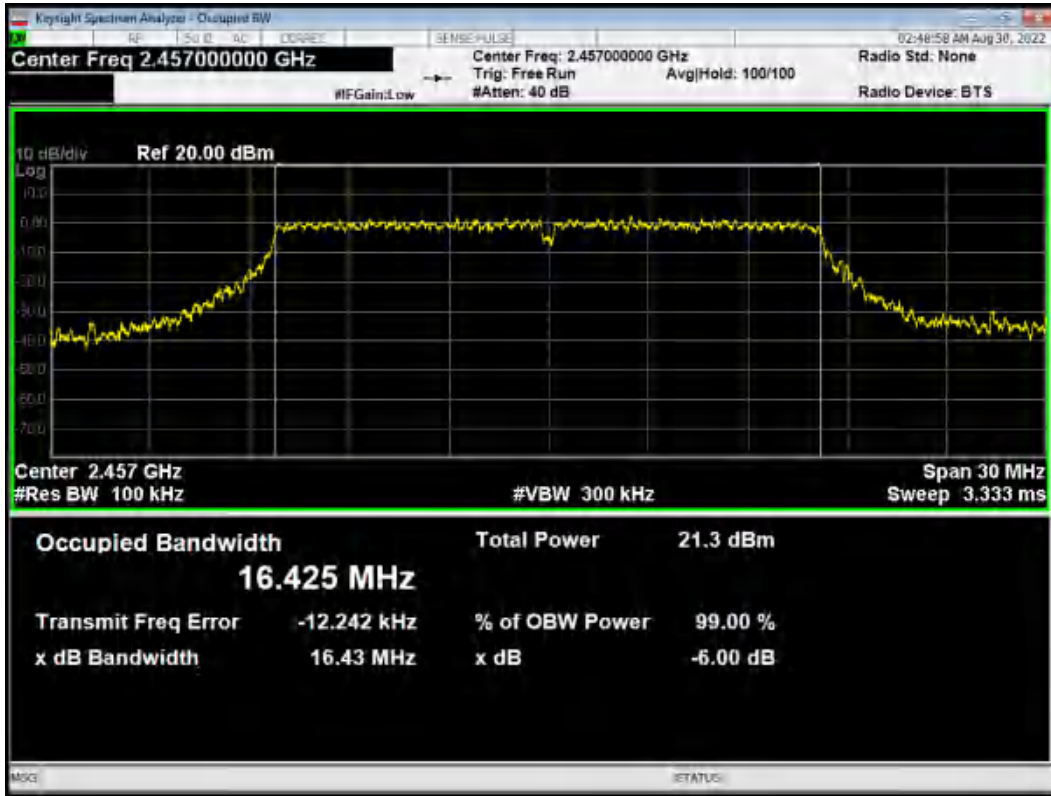

-6dB Bandwidth 802.11g 2462MHz

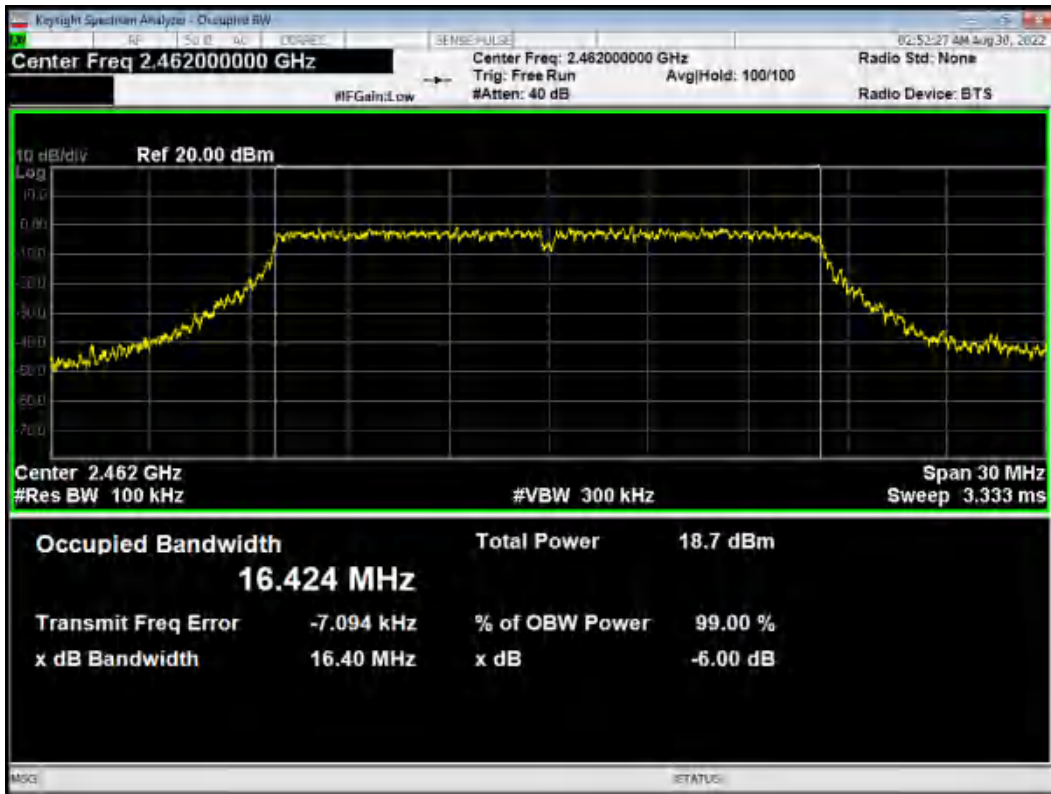



-6dB Bandwidth 802.11n(HT20) 2412MHz

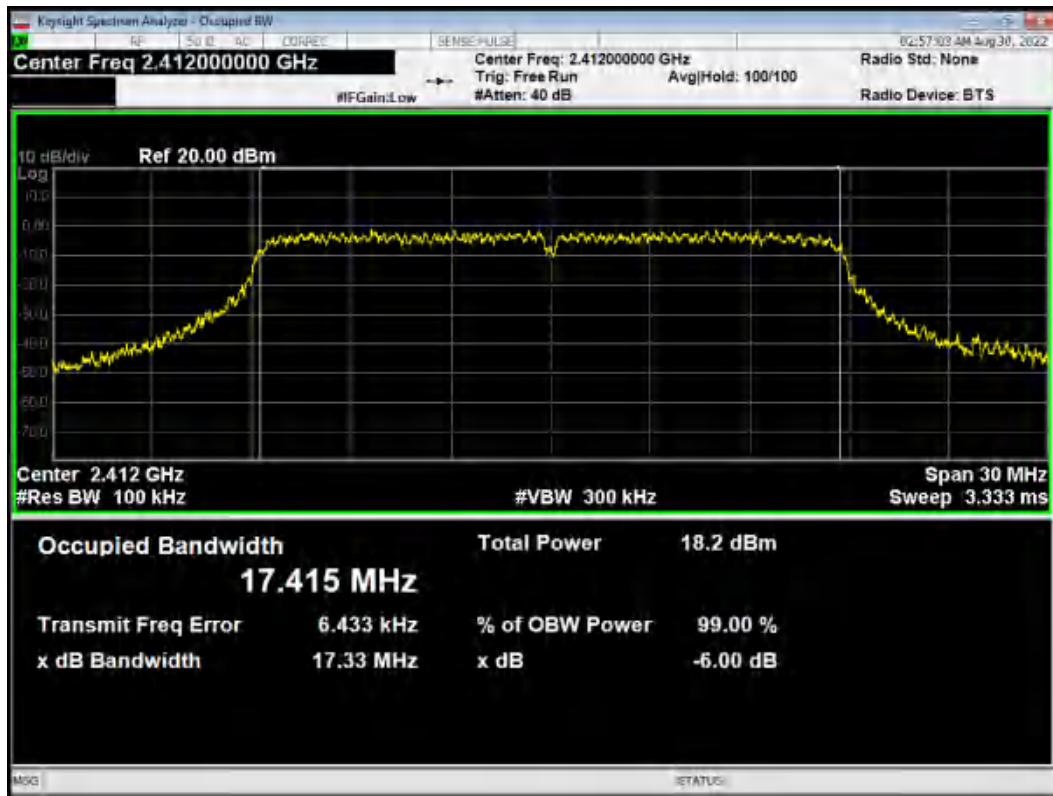

-6dB Bandwidth 802.11n(HT20) 2417MHz

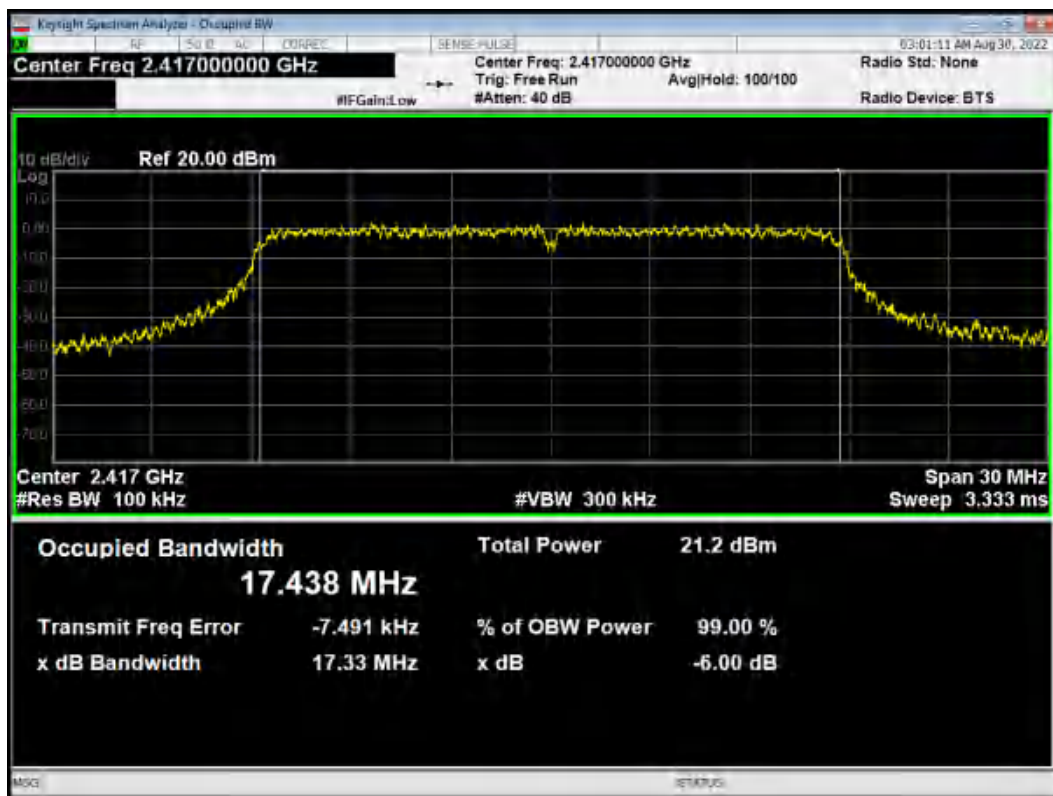



-6dB Bandwidth 802.11n(HT20) 2437MHz

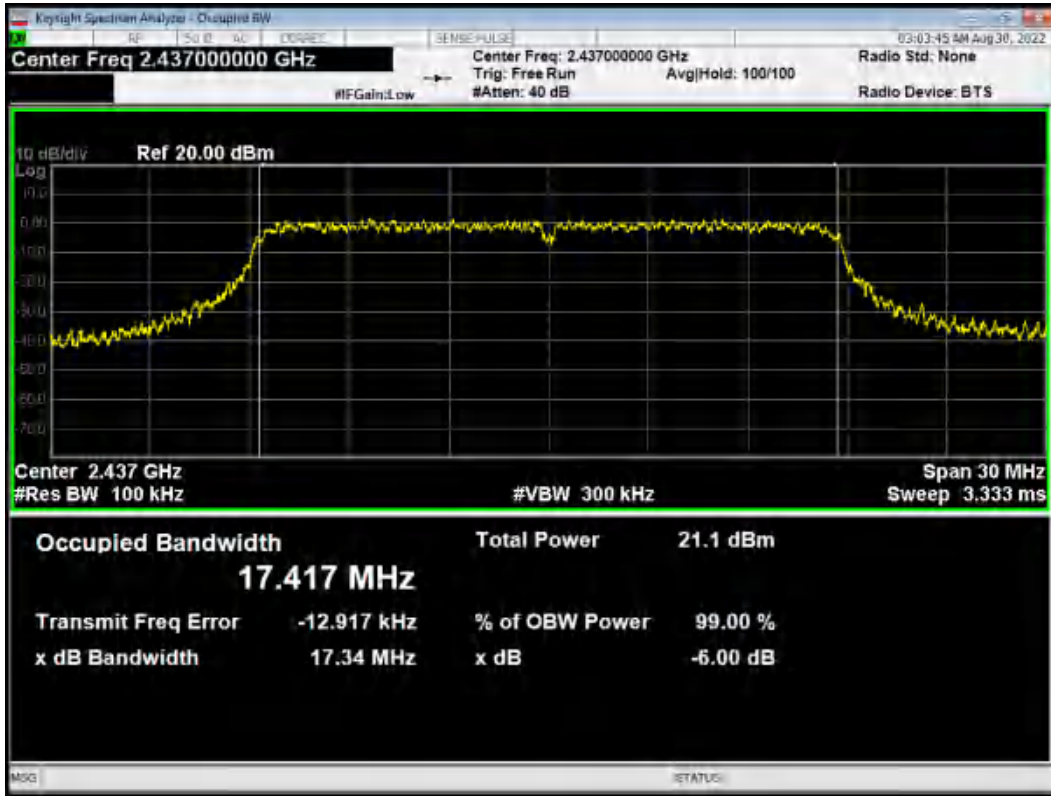

-6dB Bandwidth 802.11n(HT20) 2457MHz

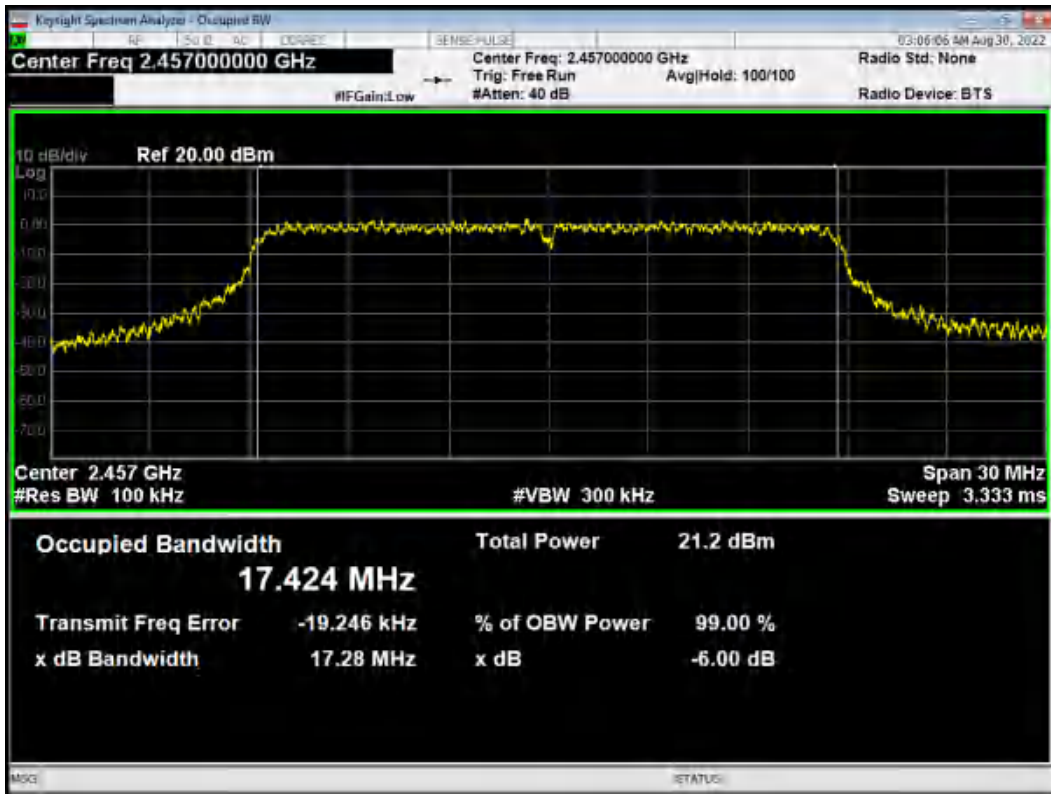



-6dB Bandwidth 802.11n(HT20) 2462MHz



-6dB Bandwidth 802.11n(HT40) 2422MHz

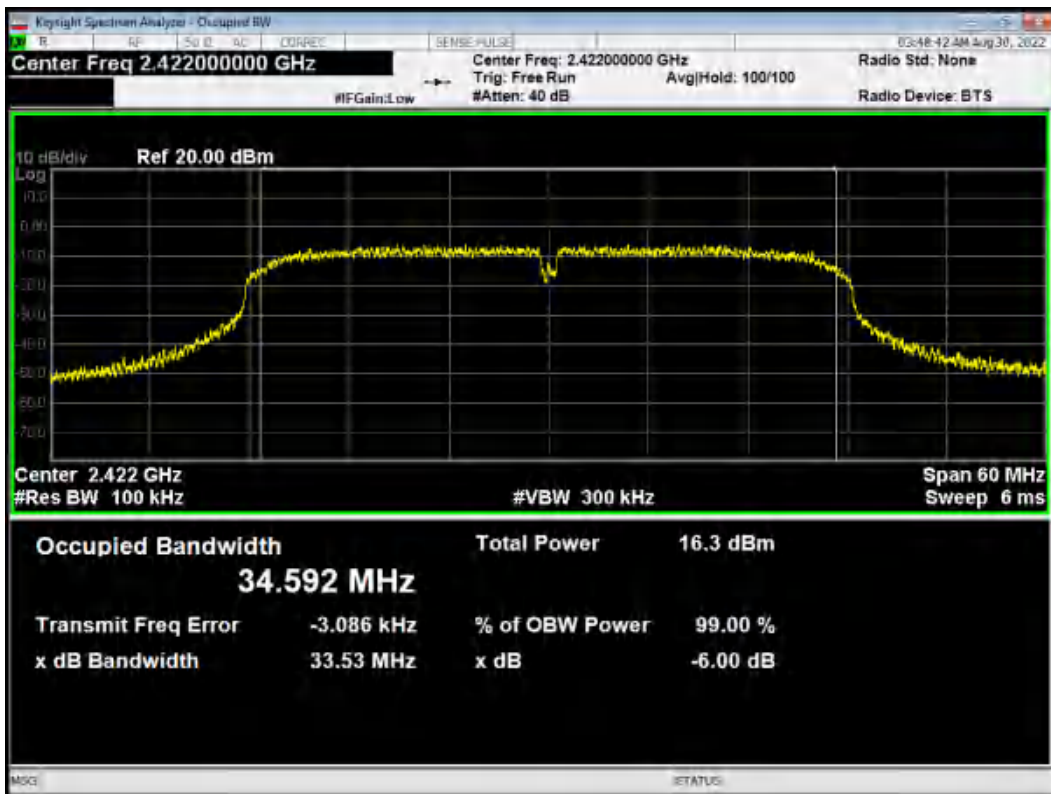



-6dB Bandwidth 802.11n(HT40) 2427MHz

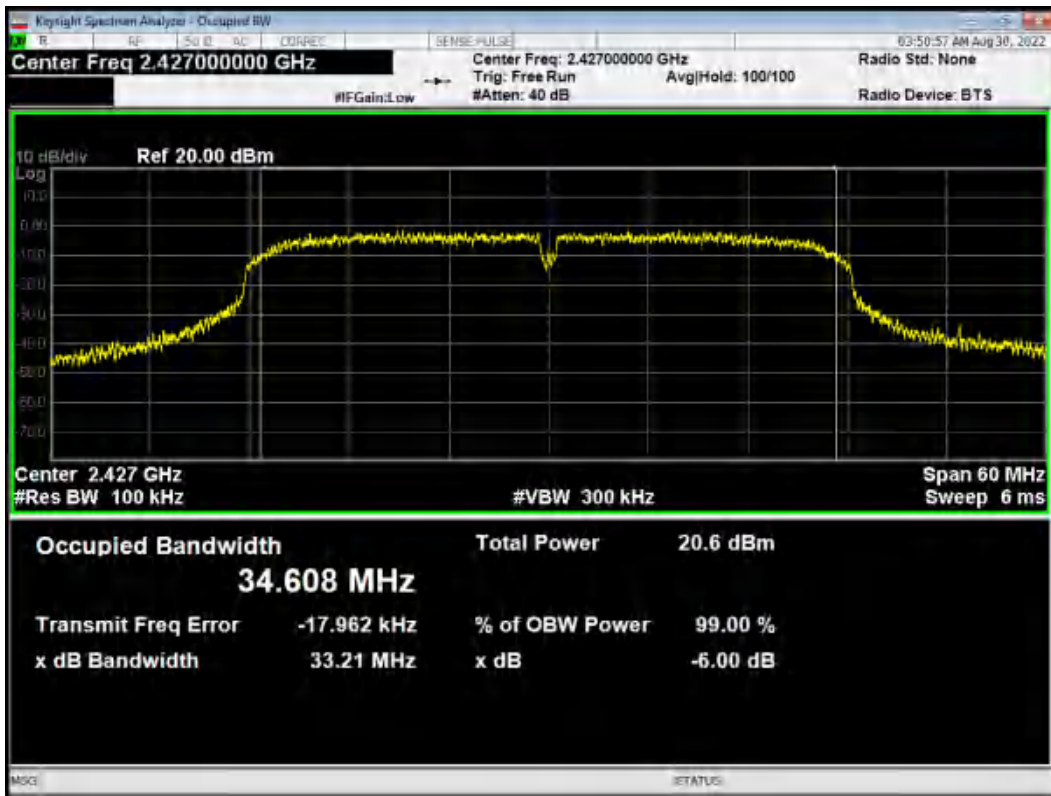

-6dB Bandwidth 802.11n(HT40) 2437MHz

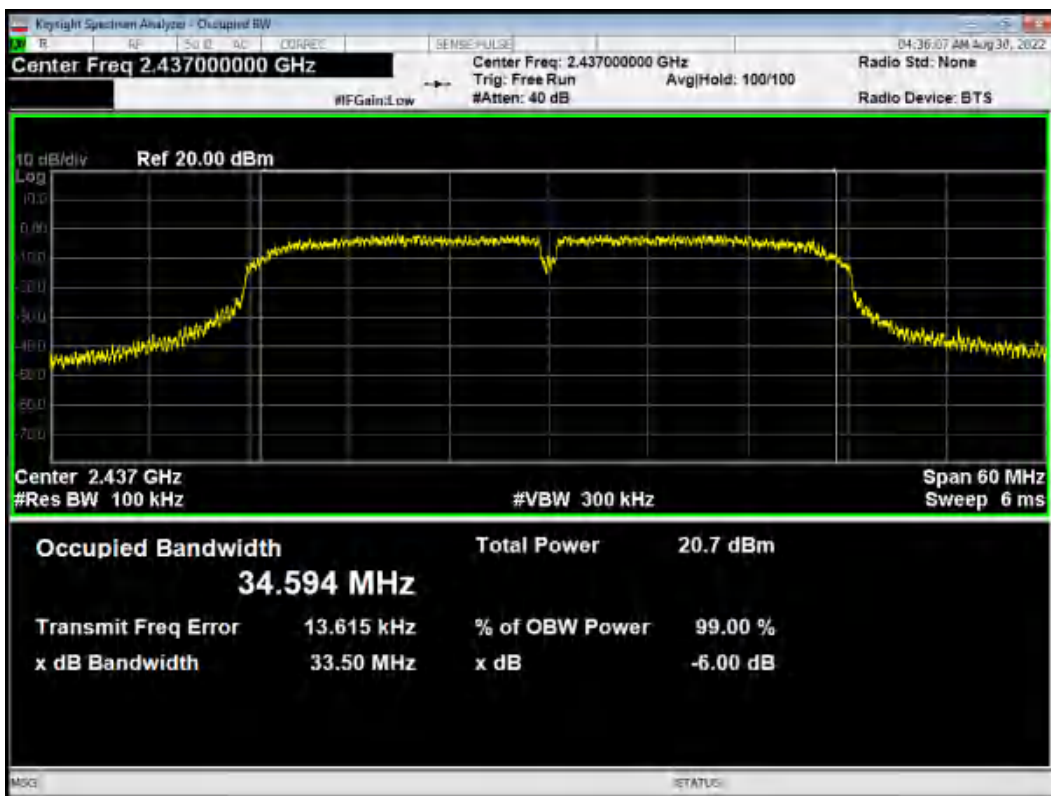



-6dB Bandwidth 802.11n(HT40) 2447MHz

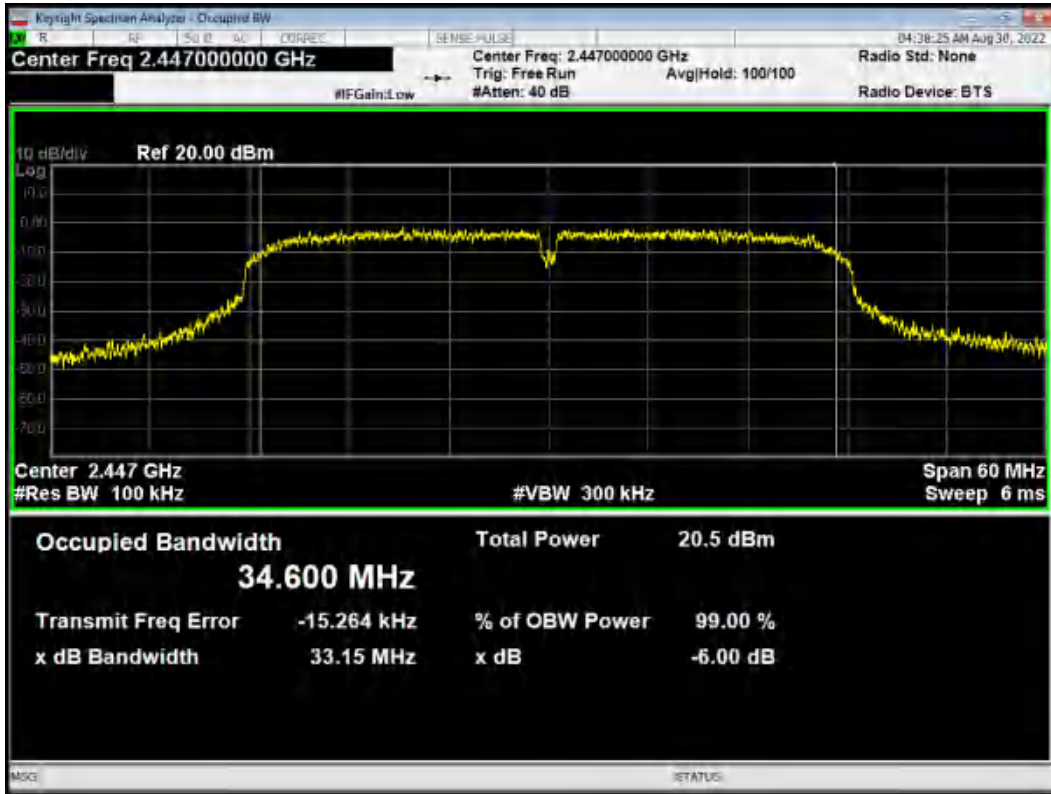

-6dB Bandwidth 802.11n(HT40) 2452MHz

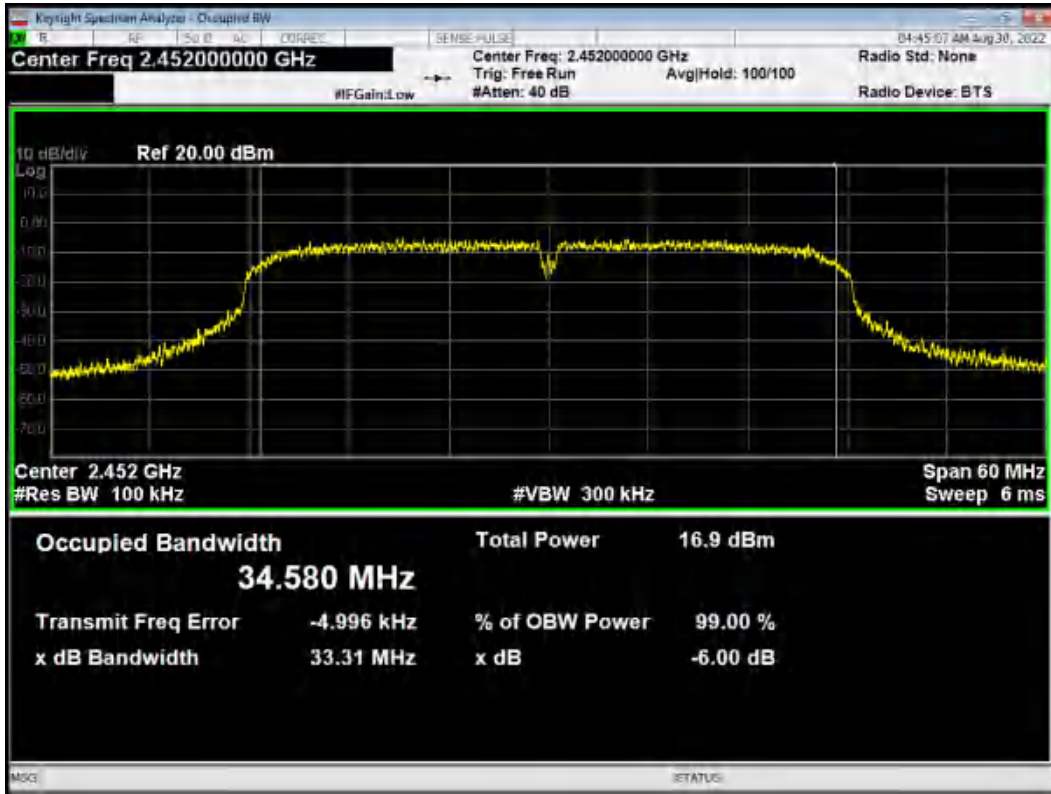



-6dB Bandwidth BLE 2402MHz

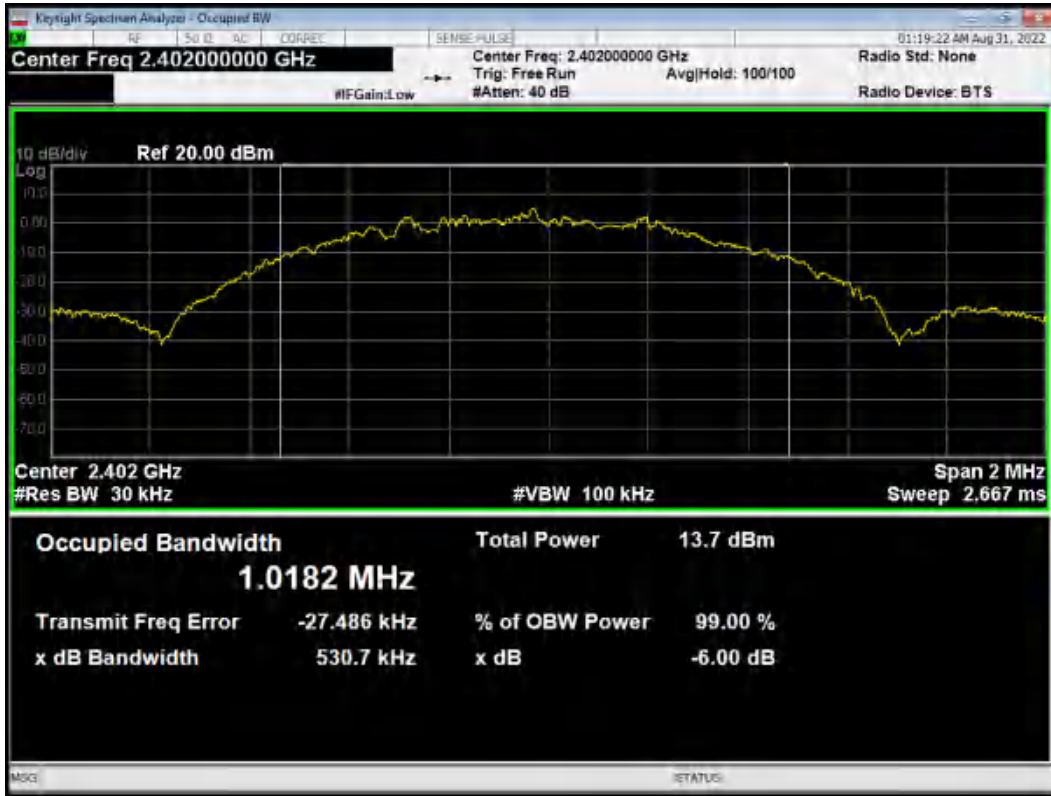

-6dB Bandwidth BLE 2440MHz

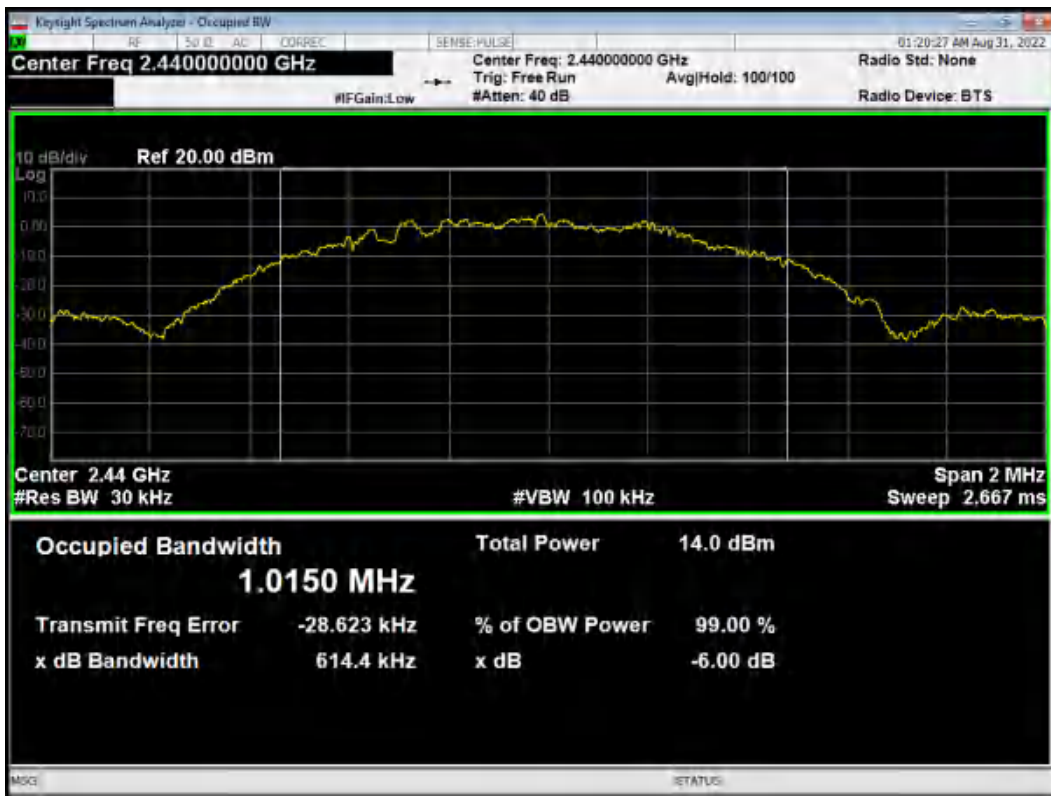



-6dB Bandwidth BLE 2480MHz

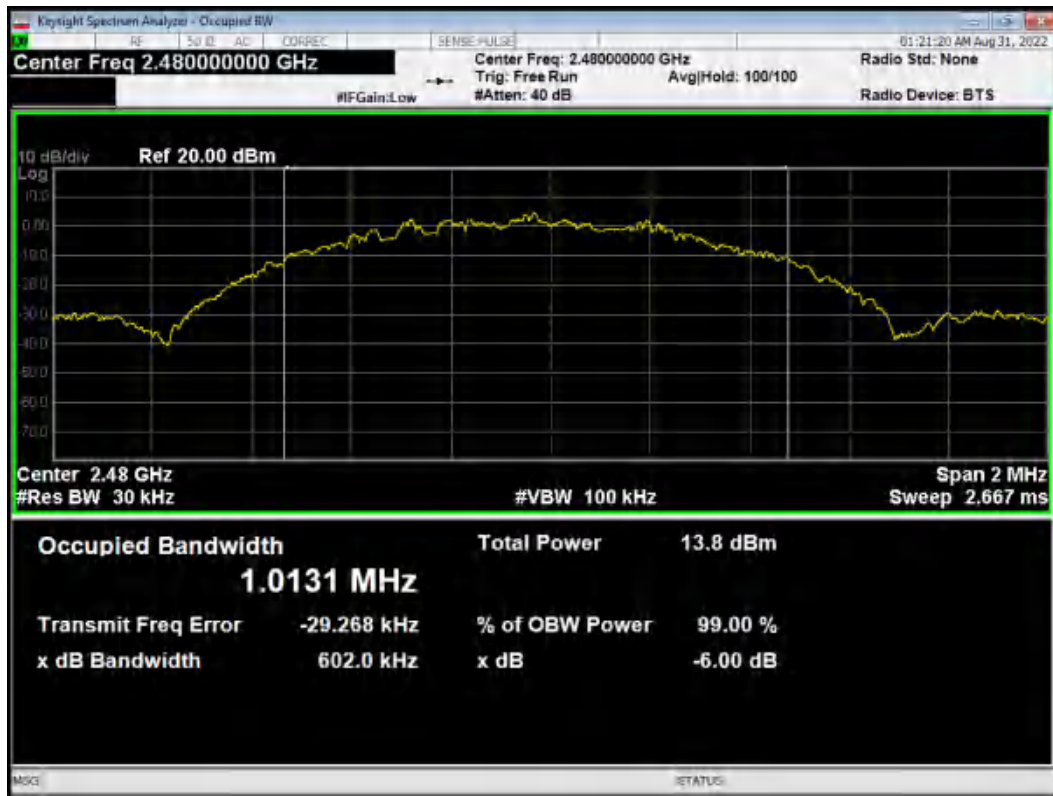

5.3. Band Edge

Ambient condition

Temperature	Relative humidity	Pressure
23°C ~25°C	45%~50%	101.5kPa

Method of Measurement

The EUT was connected to the spectrum analyzer through an external attenuator (20dB) and a known loss cable the band edge of the lowest and highest channels were measured. The peak detector is used and RBW is set to 100 kHz and VBW is set to 300 kHz on spectrum analyzer. Spectrum analyzer plots are included on the following pages.

Test Setup

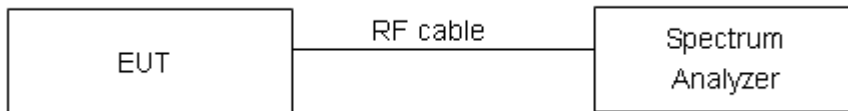

Limits

Rule Part 15.247(d) specifies that “In any 100 kHz bandwidth outside the frequency band in which the spread spectrum or digitally modulated intentional radiator is operating, the radio frequency power that is produced by the intentional radiator shall be at least 20 dB below that in the 100 kHz bandwidth within the band that contains the highest level of the desired power, based on either an RF conducted or a radiated measurement, provided the transmitter demonstrates compliance with the peak conducted power limits.” If the transmitter complies with the conducted power limits based on the use of RMS averaging over a time interval, as permitted under paragraph (b)(3) of this section, the attenuation required under this paragraph shall be 30 dB instead of 20 dB.”

Measurement Uncertainty

The assessed measurement uncertainty to ensure 95% confidence level for the normal distribution is with the coverage factor $k = 1.96$.

Frequency	Uncertainty
2GHz-3GHz	1.407 dB



Test Results: PASS

Band Edge 802.11b 2412MHz



Band Edge 802.11b 2412MHz Emission

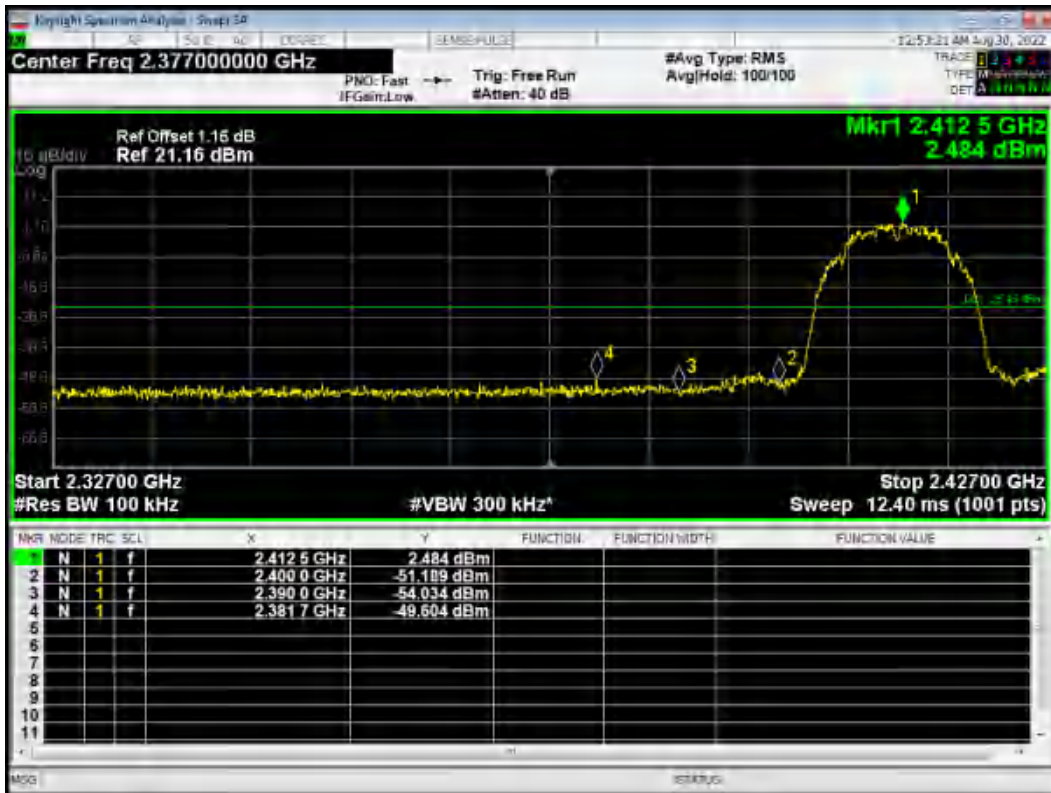



Band Edge 802.11b 2462MHz



Band Edge 802.11b 2462MHz Emission

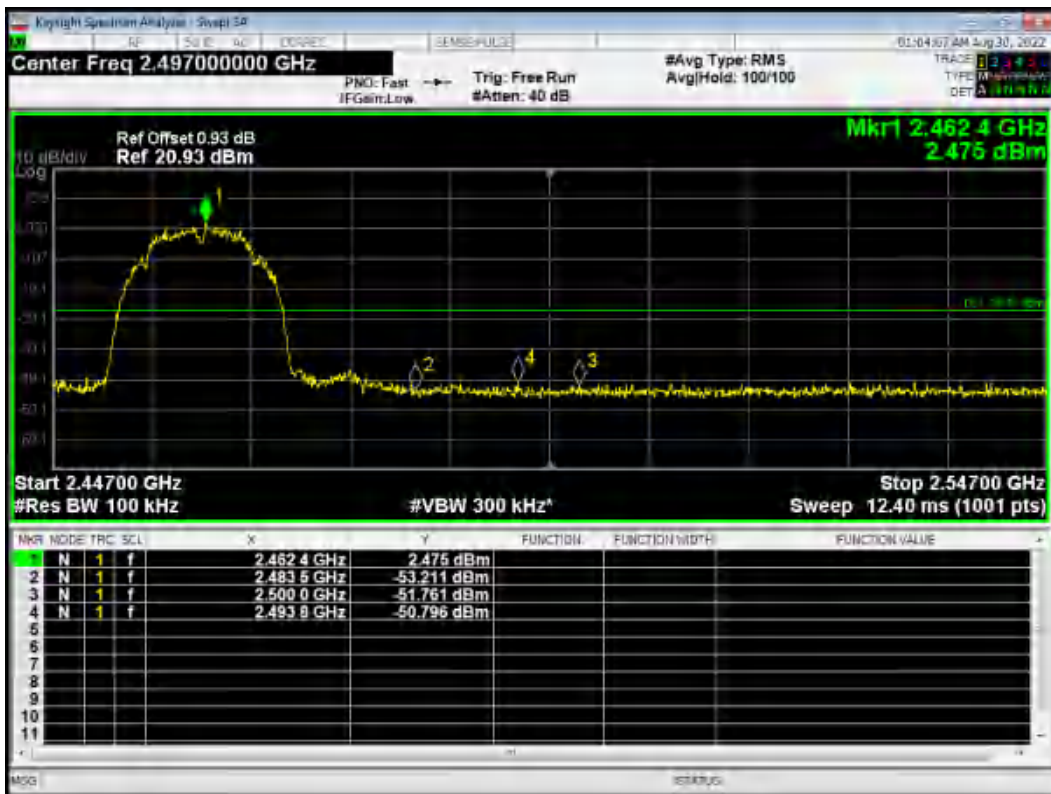



Band Edge 802.11g 2412MHz

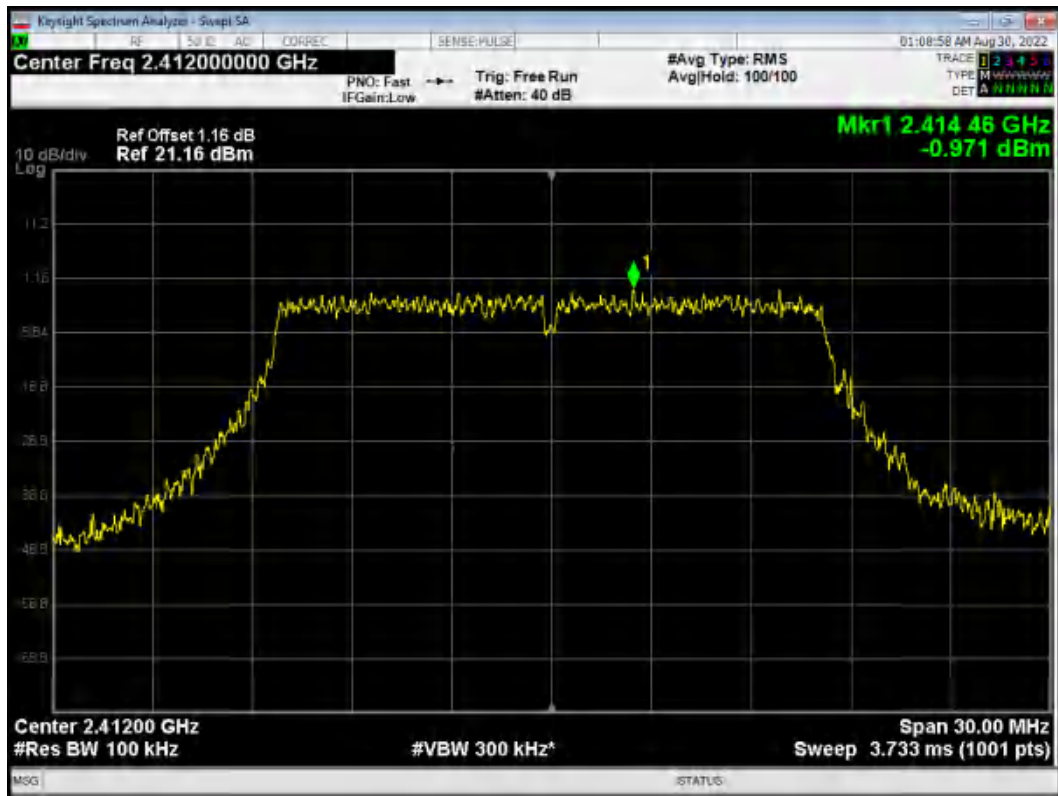

Band Edge 802.11g 2412MHz Emission

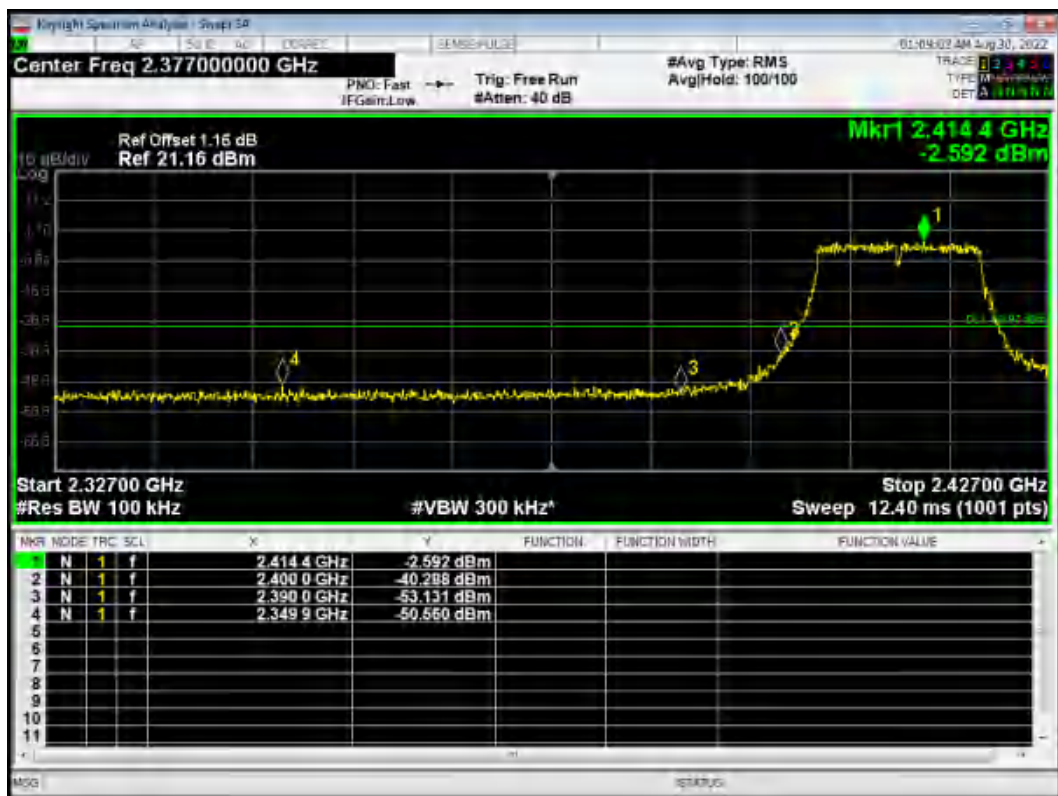



Band Edge 802.11g 2417MHz

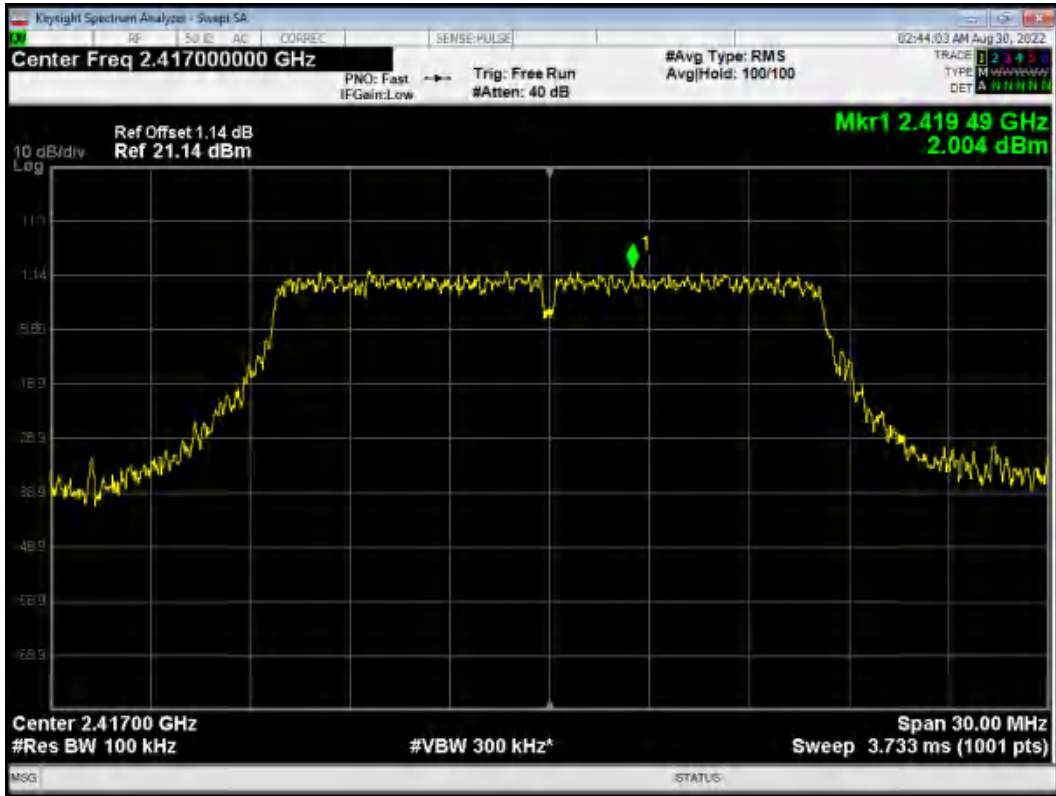

Band Edge 802.11g 2417MHz Emission





Band Edge 802.11g 2457MHz



Band Edge 802.11g 2457MHz Emission





Band Edge 802.11g 2462MHz

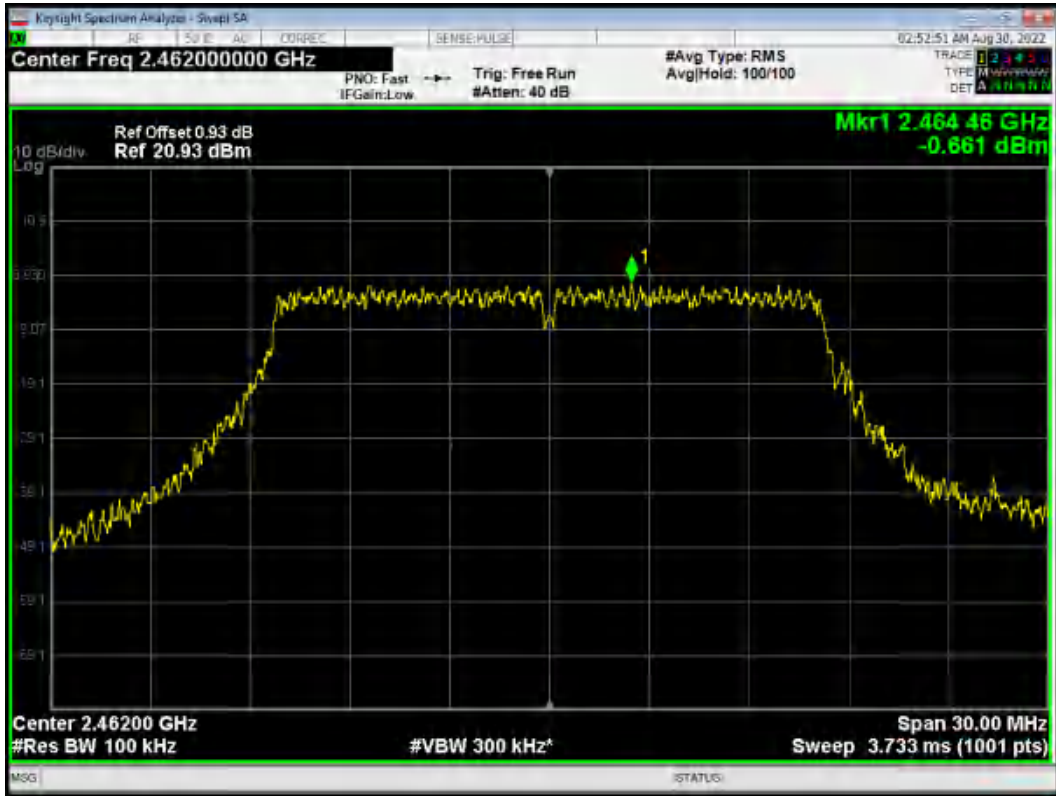

Band Edge 802.11g 2462MHz Emission

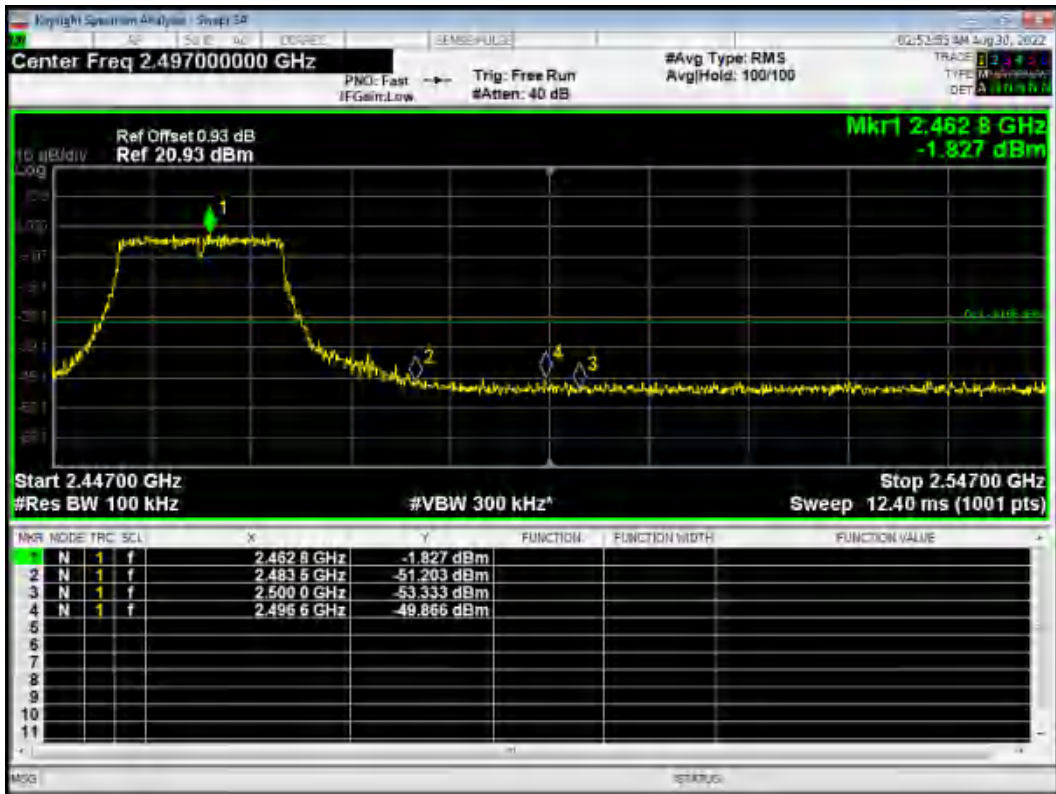



Band Edge 802.11n(HT20) 2412MHz

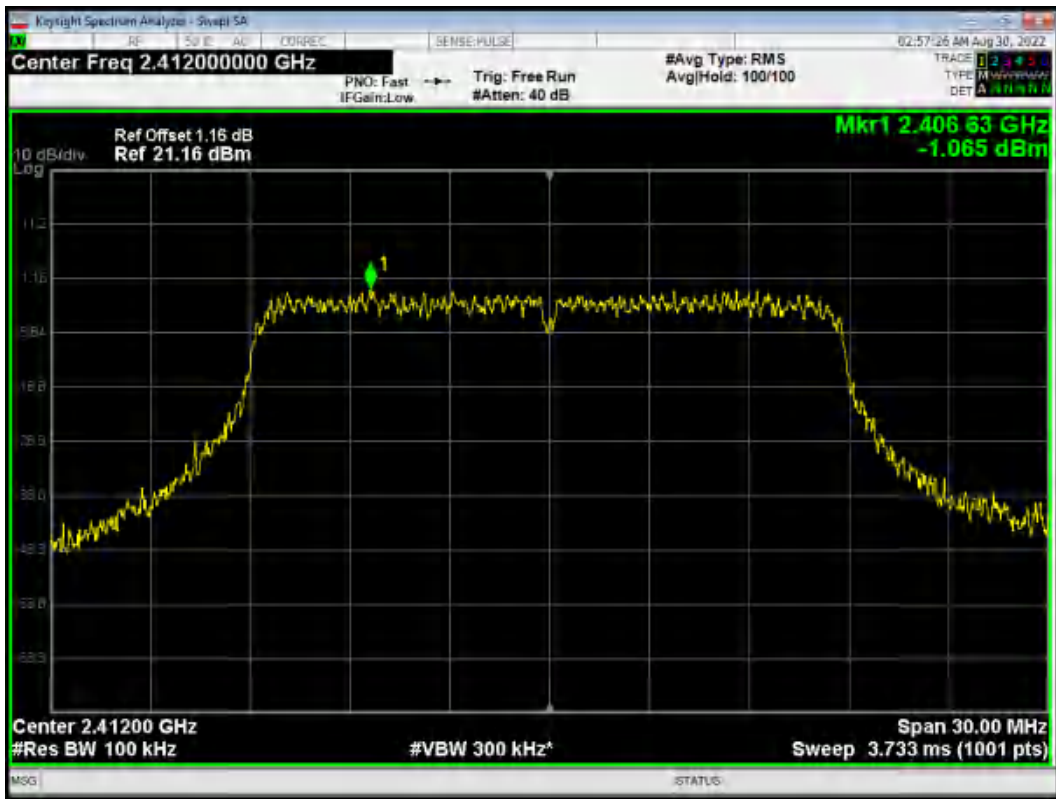

Band Edge 802.11n(HT20) 2412MHz Emission

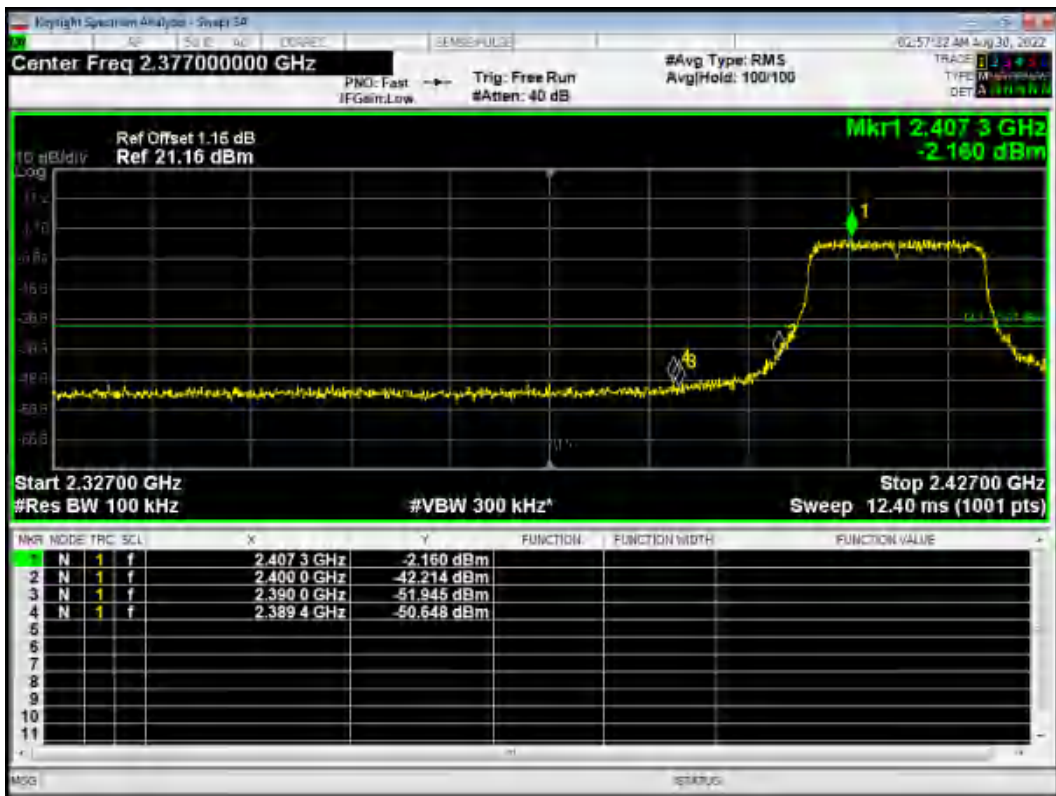



Band Edge 802.11n(HT20) 2417MHz

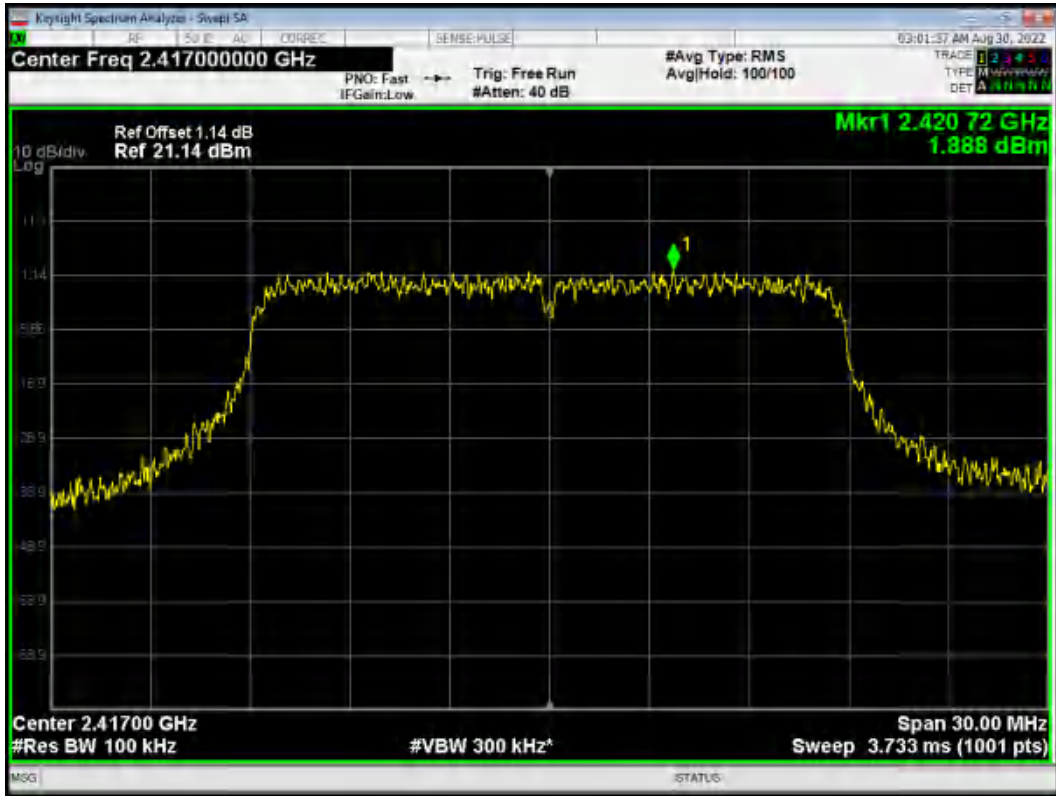

Band Edge 802.11n(HT20) 2417MHz Emission

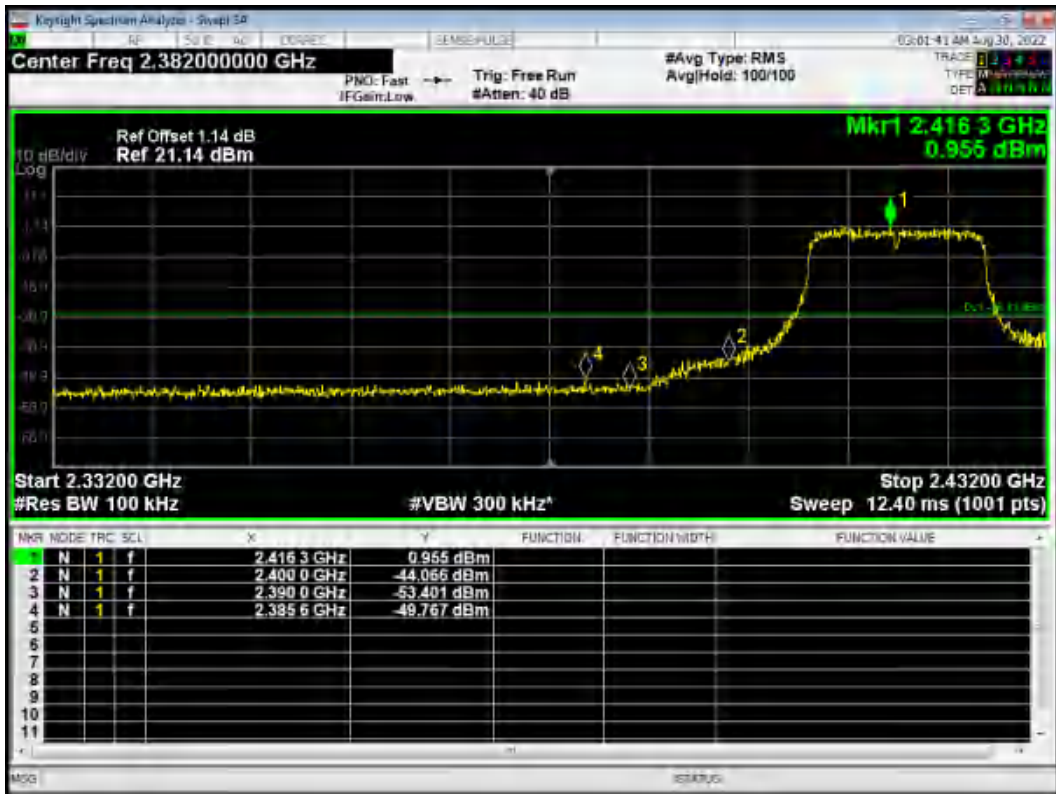



Band Edge 802.11n(HT20) 2457MHz



Band Edge 802.11n(HT20) 2457MHz Emission





Band Edge 802.11n(HT20) 2462MHz

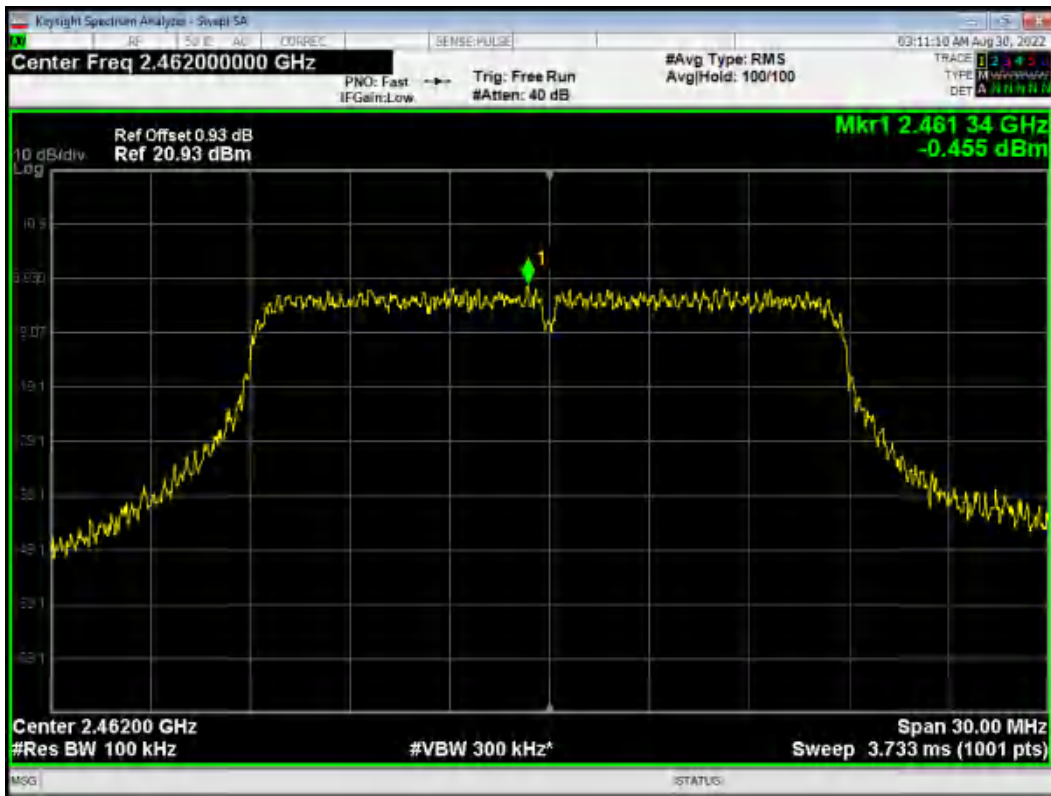

Band Edge 802.11n(HT20) 2462MHz Emission

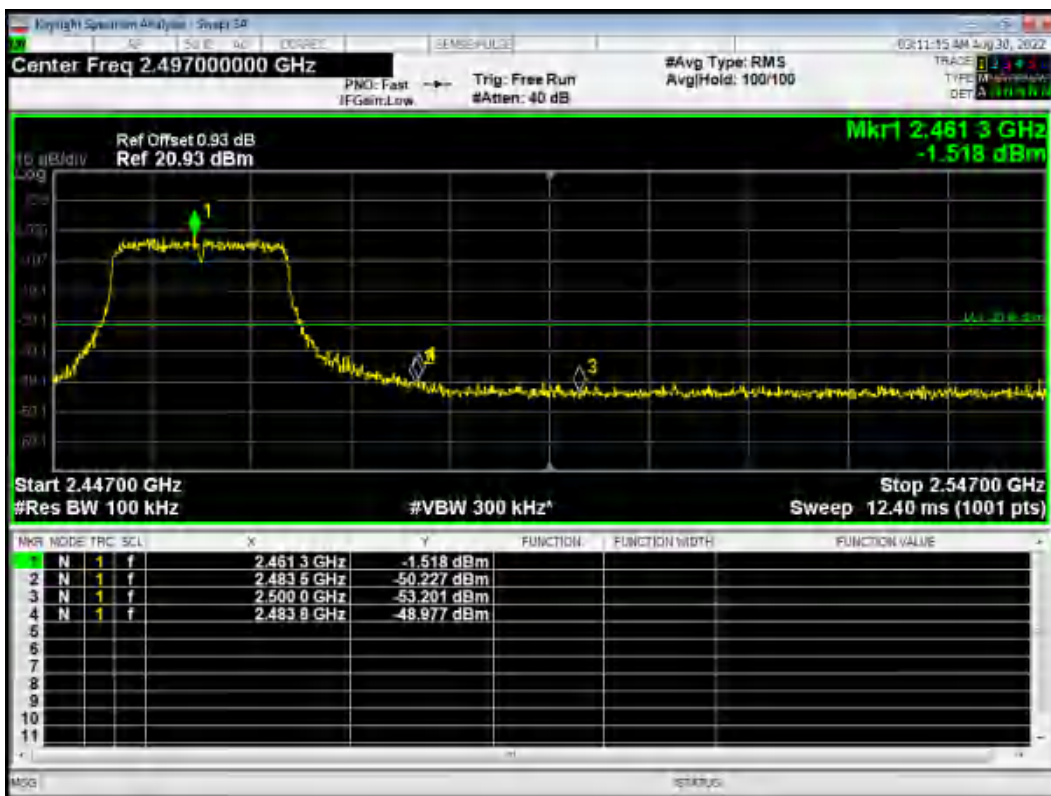



Band Edge 802.11n(HT40) 2422MHz

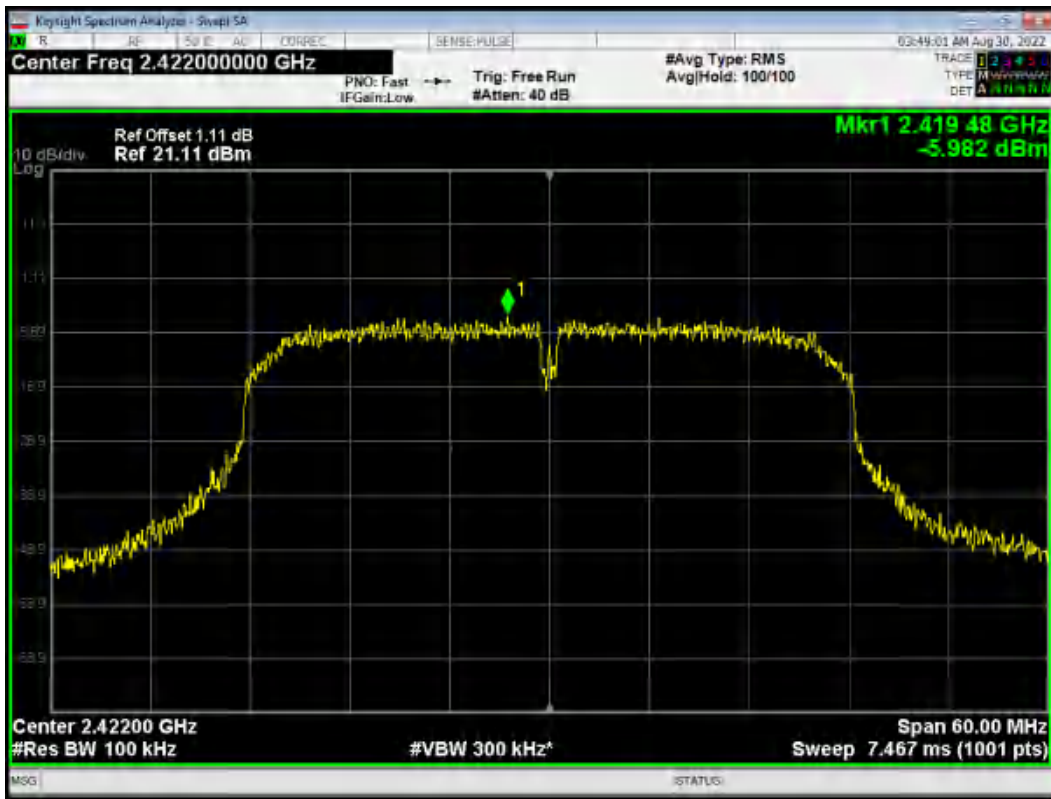

Band Edge 802.11n(HT40) 2422MHz Emission





Band Edge 802.11n(HT40) 2427MHz



Band Edge 802.11n(HT40) 2427MHz Emission





Band Edge 802.11n(HT40) 2447MHz



Band Edge 802.11n(HT40) 2447MHz Emission





Band Edge 802.11n(HT40) 2452MHz



Band Edge 802.11n(HT40) 2452MHz Emission





Band Edge BLE 2402MHz Ref

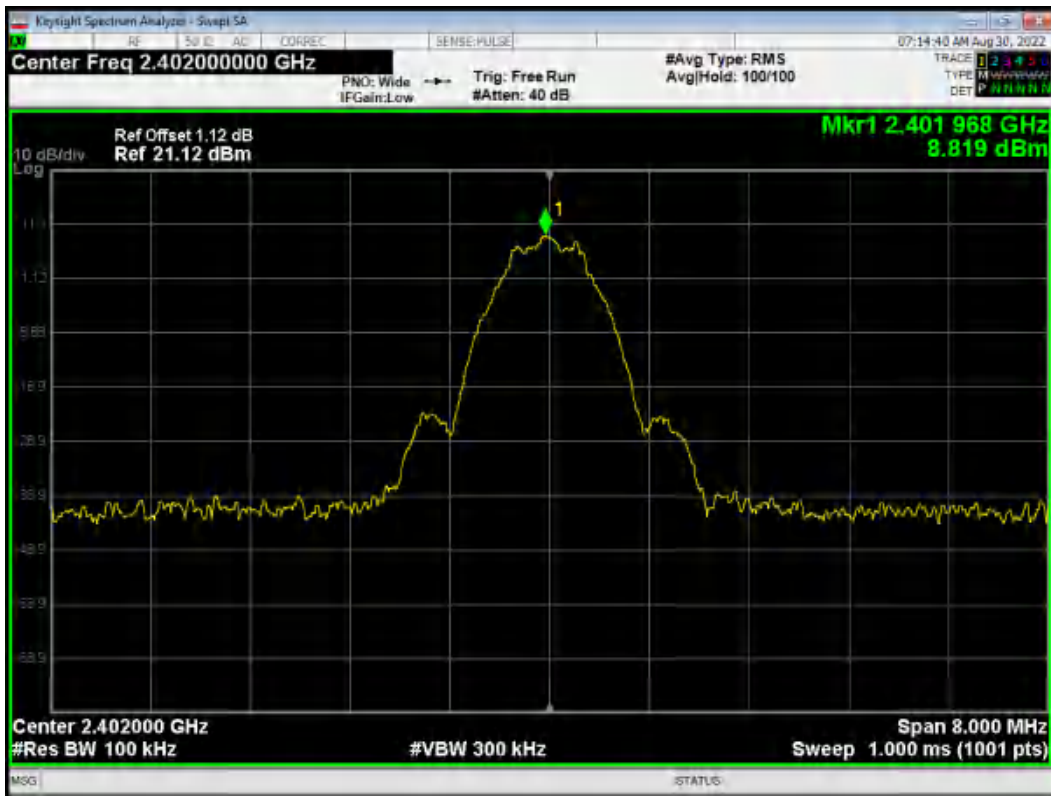

Band Edge BLE 2402MHz Emission

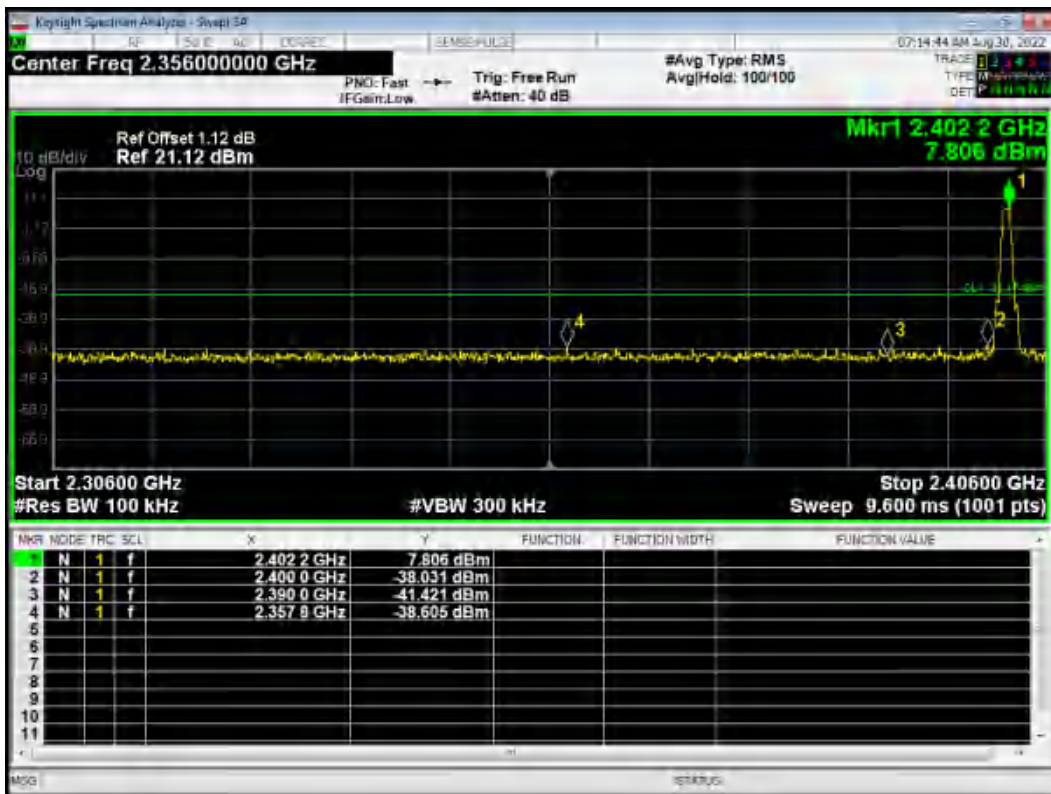



Band Edge BLE 2480MHz Ref

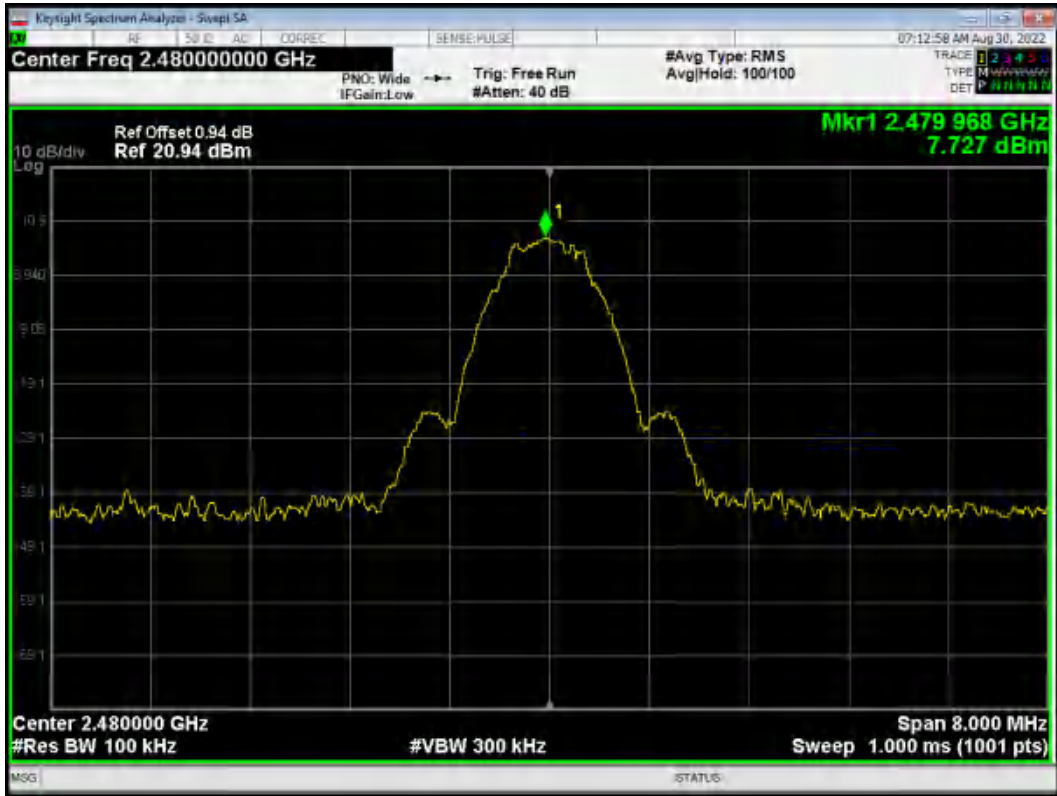

Band Edge BLE 2480MHz Emission

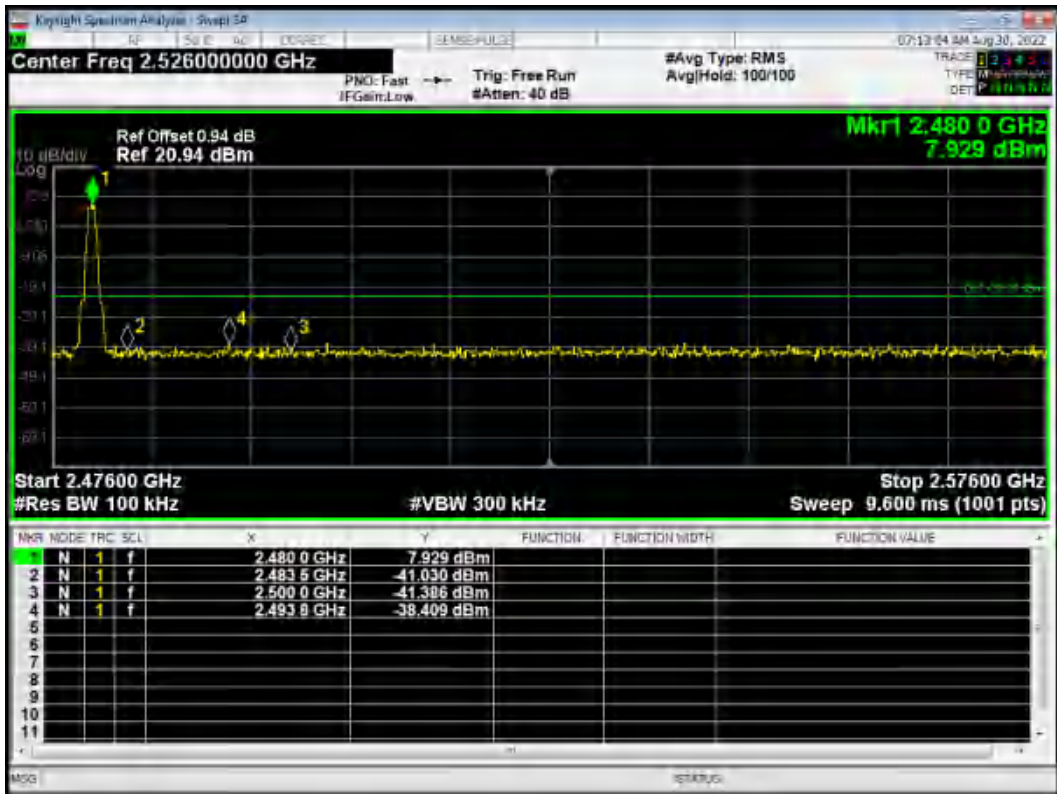



5.4. Power Spectral Density

Ambient condition

Temperature	Relative humidity	Pressure
23°C ~25°C	45%~50%	101.5kPa

Method of Measurement

During the process of the testing, The EUT was connected to Spectrum Analyzer with a known loss. The EUT is max power transmission with proper modulation.

Method AVGPSD-1 was used for this test.

- a) Set instrument center frequency to DTS channel center frequency
- b) Set span to at least 1.5 times the OBW
- c) Set RBW to: $3\text{kHz} \leq \text{RBW} \leq 100\text{kHz}$
- d) Set VBW $\geq [3x \text{RBW}]$
- e) Detector=power averaging (rms) or sample detector (when rms not available)
- f) Ensure that the number of measurement points in the sweep $2[2 X \text{span}/\text{RBWT}]$
- g) Sweep time auto couple
- h) Employ trace averaging (rms) mode over a minimum of 100 traces
- i) Use the peak marker function to determine the maximum amplitude level.
- j) If the measured value exceeds requirement, then reduce RBW (but no less than 3 kHz) and repeat (note that this may require zooming in on the emission of interest and reducing the span to meet the minimum measurement point requirement as the RBW is reduced)

Method AVGPSD-2 was used for this test.

- a) Measure the duty cycle (D)of the transmitter output signal as described in 11.6
- b) Set instrument center frequency to DTS channel center frequency
- c) Set span to at least 1.5 times the OBW
- d) Set RBW to: $3\text{kHz} \leq \text{RBW} \leq 100\text{Kh}$
- e) Set VBW $\geq [3x \text{RBW}]$
- f) Detector= power averaging (rms) or sample detector (when rms not available)
- g) Ensure that the number of measurement points in the sweep $2[2 X \text{span}/\text{RBW}]$
- h) Sweep time =auto couple
- i) Do not use sweep triggering; allow sweep to "free run"
- j) Employ trace averaging (rms) mode over a minimum of 100 traces
- k) Use the peak marker function to determine the maximum amplitude level



l) Add $[10 \log(1/D)]$, where D is the duty cycle measured in step a), to the measured PSD to compute the average PSD during the actual transmission time

m) If measured value exceeds requirement specified by regulatory agency then reduce RBW (but no less than 3 kHz) and repeat (note that this may require zooming in on the emission of interest and reducing the span to meet the minimum measurement point requirement as the RBW is reduced)

Test setup

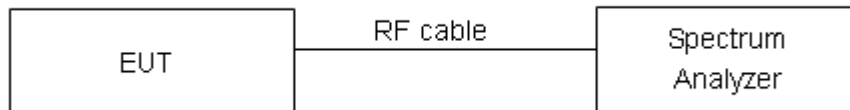

Limits

Rule Part 15.247(e) specifies that " For digitally modulated systems, the power spectral density conducted from the intentional radiator to the antenna shall not be greater than 8 dBm in any 3 kHz band during any time interval of continuous transmission. "

Limits	$\leq 8 \text{ dBm} / 3\text{kHz}$
--------	------------------------------------

Measurement Uncertainty

The assessed measurement uncertainty to ensure 95% confidence level for the normal distribution is with the coverage factor $k = 2$, $U = 0.75\text{dB}$.

**Test Results:**

Test Mode	Carrier frequency (MHz) / Channel	Read Value (dBm / 30kHz)	Power Spectral Density (dBm / 3kHz)	Limit (dBm / 3kHz)	Conclusion
802.11b	2412/CH1	-7.94	-17.94	8	PASS
	2437/CH6	-8.03	-18.03	8	PASS
	2462/CH11	-7.68	-17.68	8	PASS
802.11g	2412/CH1	-10.52	-20.52	8	PASS
	2417/CH2	-8.04	-18.04	8	PASS
	2437/CH6	-8.28	-18.28	8	PASS
	2457/CH10	-8.03	-18.03	8	PASS
	2462/CH11	-10.44	-20.44	8	PASS
802.11n HT20	2412/CH1	-11.37	-21.37	8	PASS
	2417/CH2	-8.24	-18.24	8	PASS
	2437/CH6	-8.28	-18.28	8	PASS
	2457/CH10	-8.18	-18.18	8	PASS
	2462/CH11	-10.5	-20.50	8	PASS
802.11n HT40	2422/CH3	-15.66	-25.66	8	PASS
	2427/CH4	-11.45	-21.45	8	PASS
	2437/CH6	-11.38	-21.38	8	PASS
	2447/CH8	-11.12	-21.12	8	PASS
	2452/CH9	-14.92	-24.92	8	PASS

Note: Power Spectral Density (dBm/3kHz) =Read Value+Duty cycle correction factor + 10*log10(3 / 30)

Test Mode	Carrier frequency (MHz) / Channel	Read Value (dBm / 3kHz)	Power Spectral Density (dBm / 3kHz)	Limit (dBm / 3kHz)	Conclusion
Bluetooth (Low Energy)	2402/CH0	-12.63	-11.86	8	PASS
	2440/CH19	-12.57	-11.80	8	PASS
	2480/CH39	-12.39	-11.63	8	PASS

Note: Power Spectral Density =Read Value+Duty cycle correction factor



PSD 802.11b 2412MHz

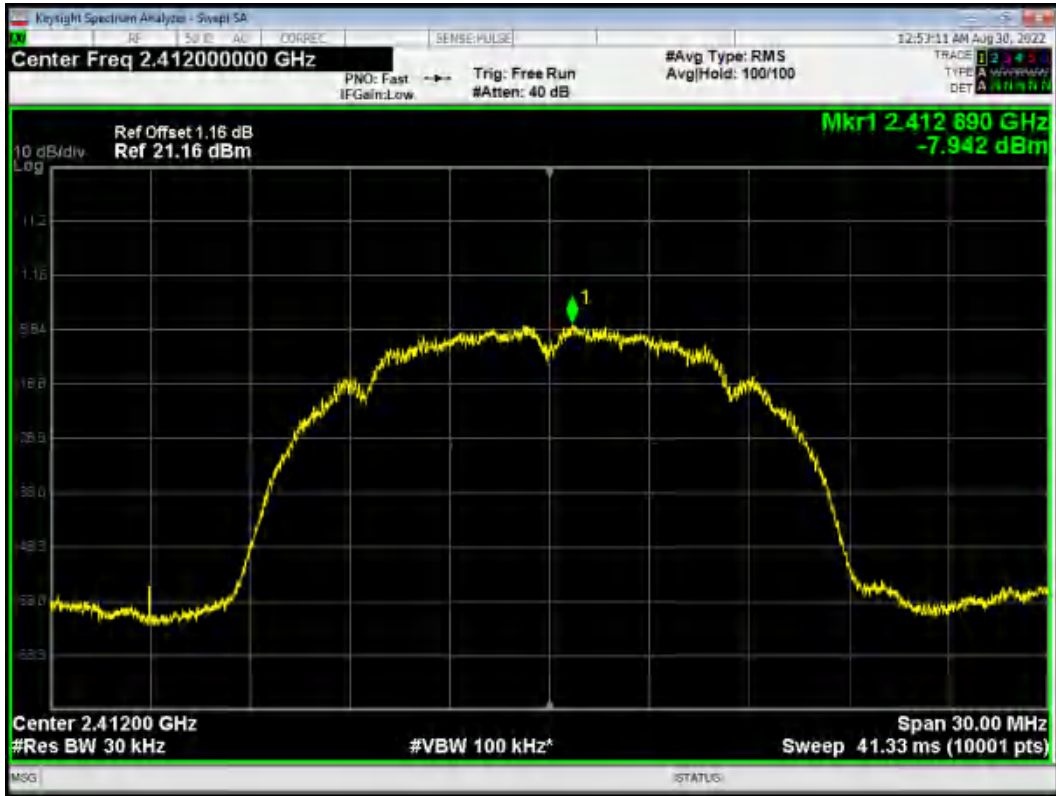

PSD 802.11b 2437MHz





PSD 802.11b 2462MHz

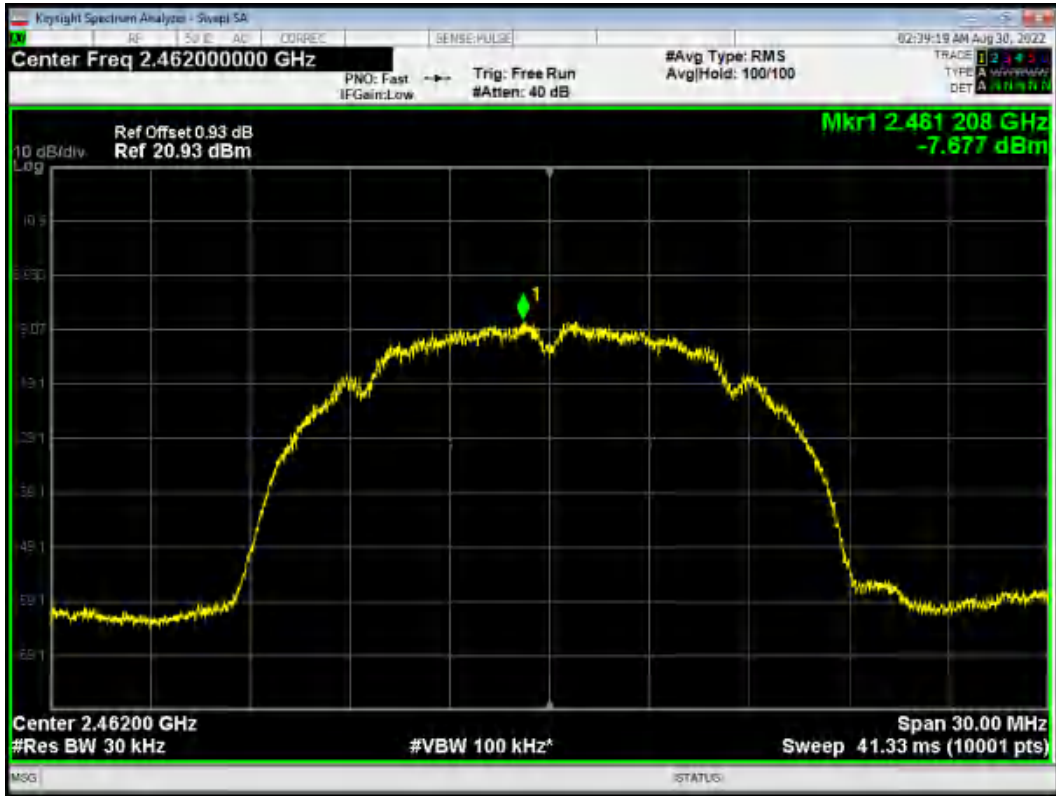

PSD 802.11g 2412MHz

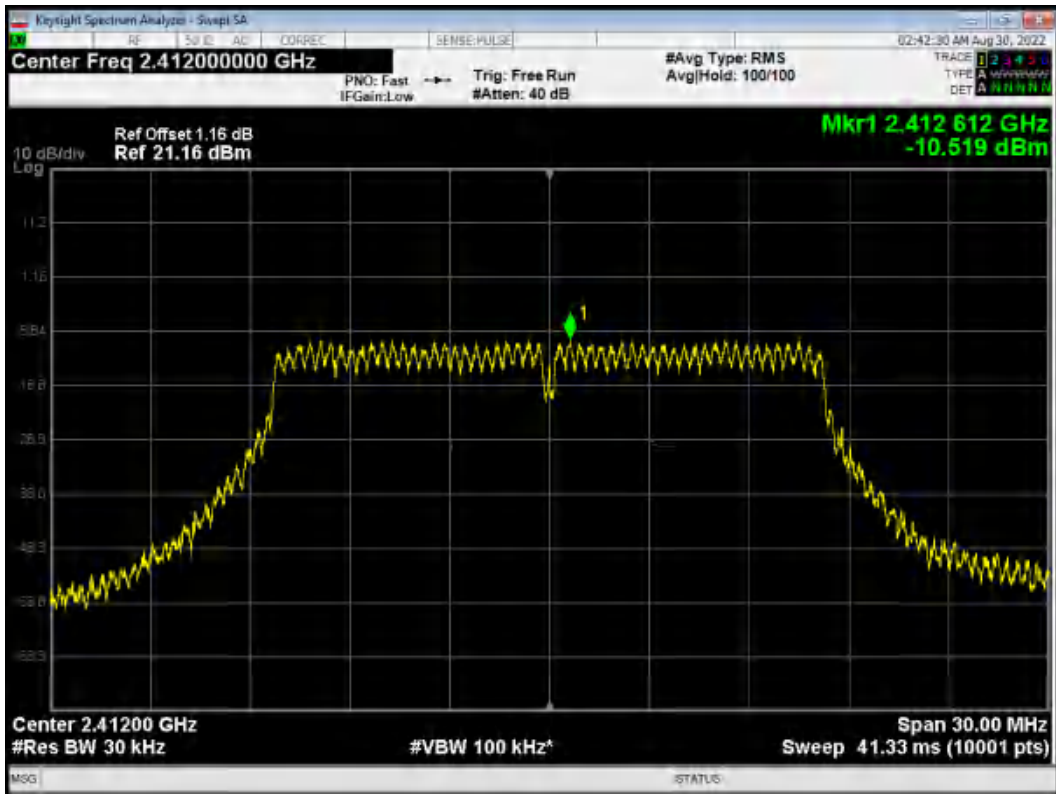



PSD 802.11g 2417MHz

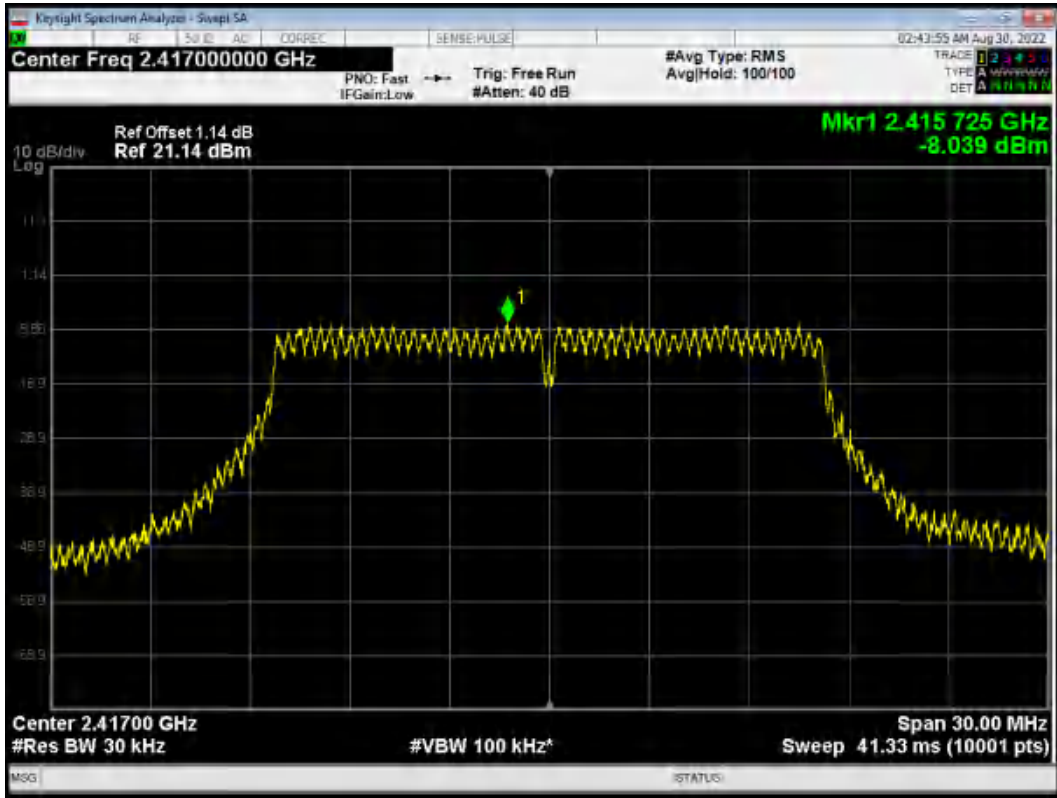

PSD 802.11g 2437MHz





PSD 802.11g 2457MHz

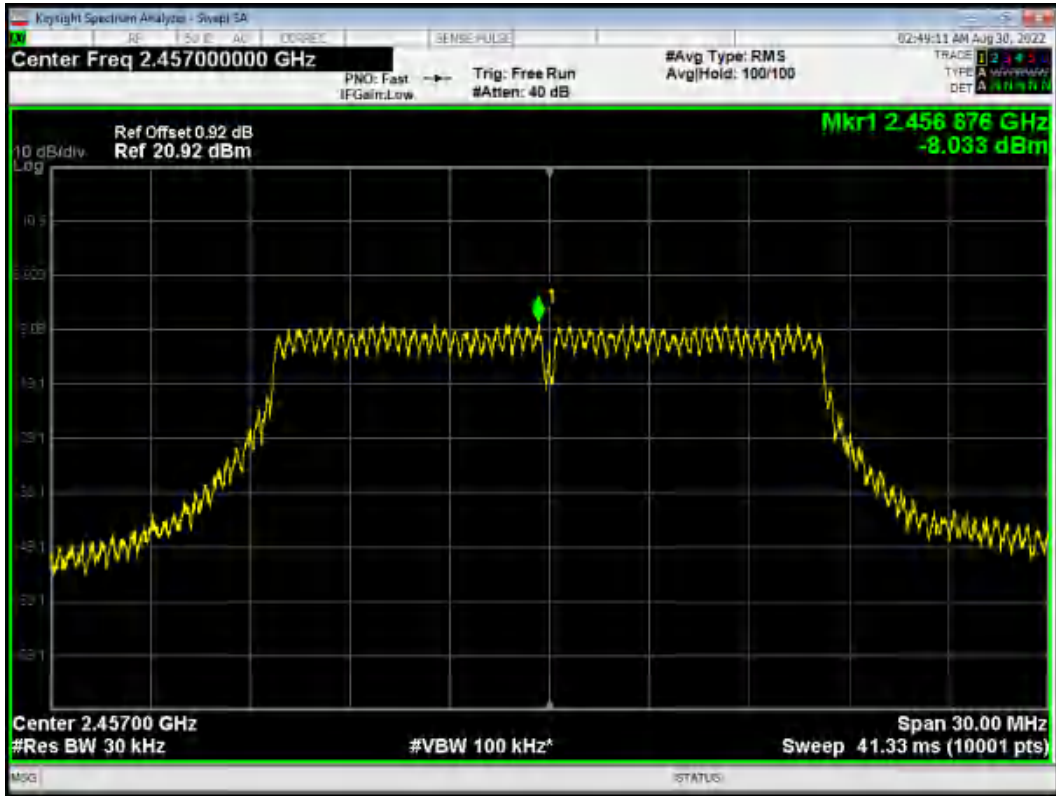

PSD 802.11g 2462MHz

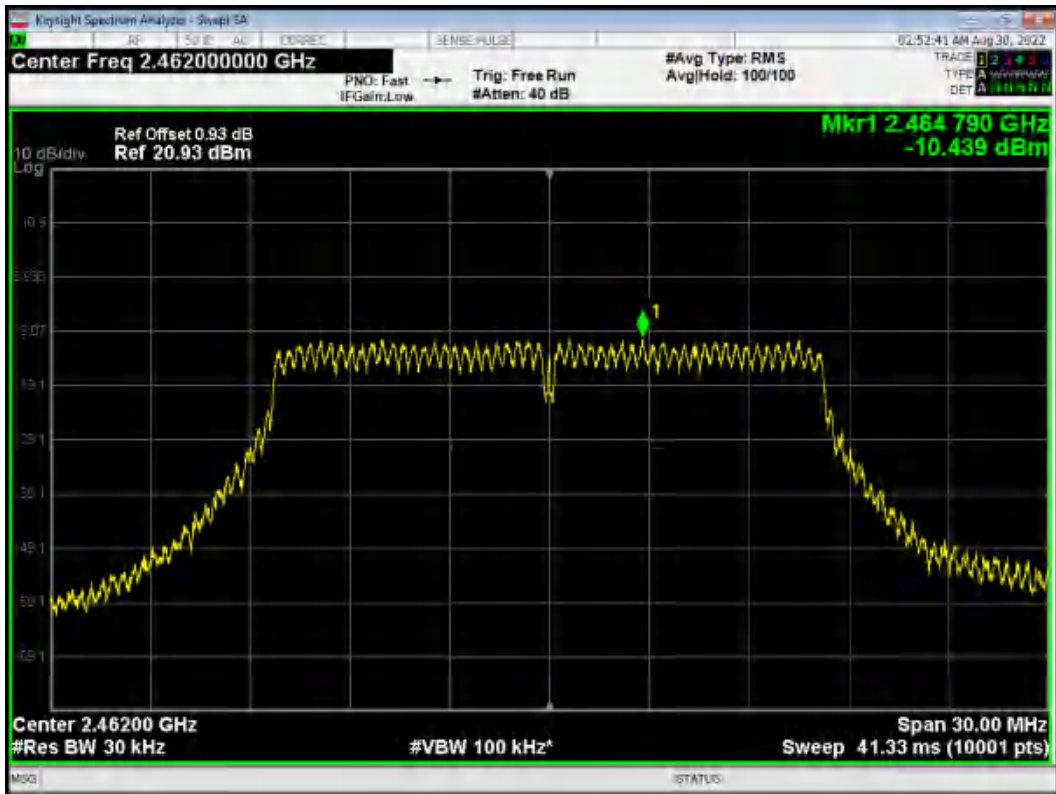



PSD 802.11n(HT20) 2412MHz

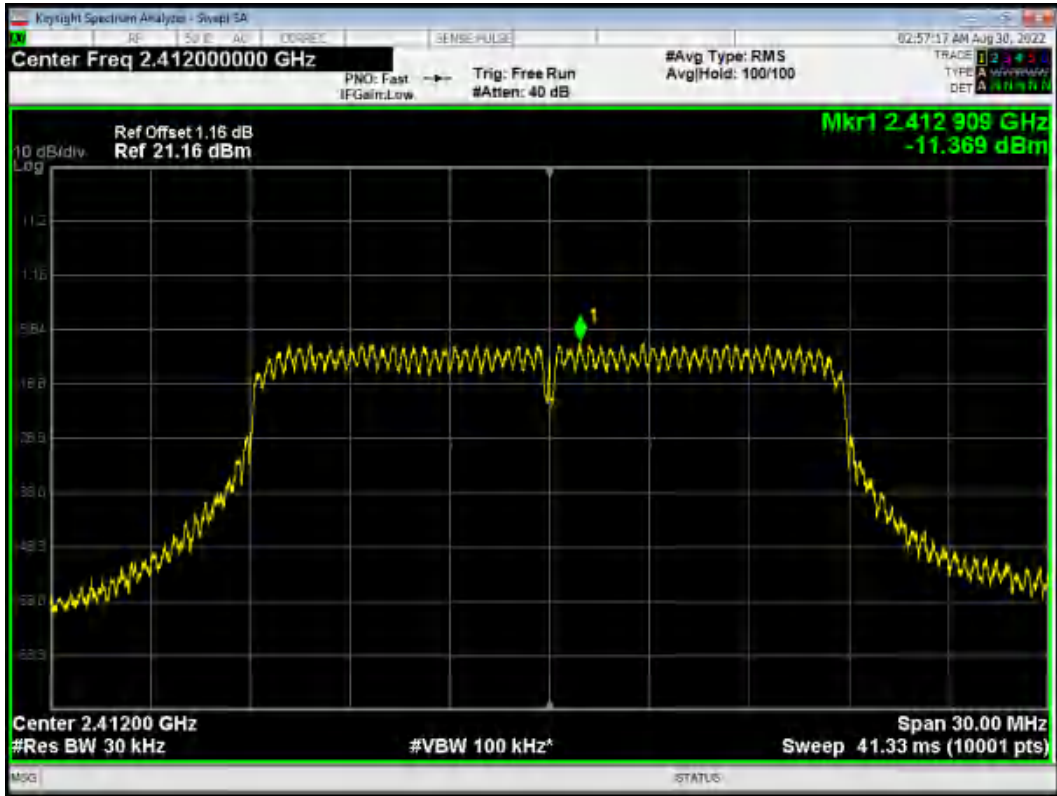

PSD 802.11n(HT20) 2417MHz

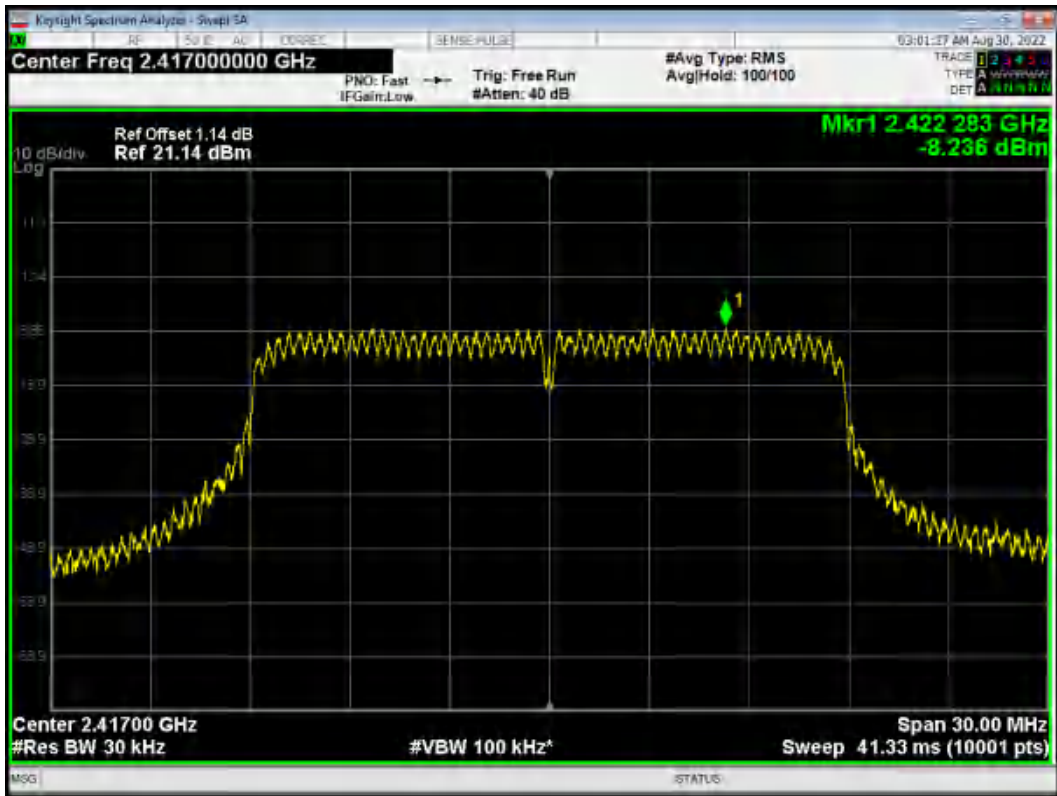



PSD 802.11n(HT20) 2437MHz

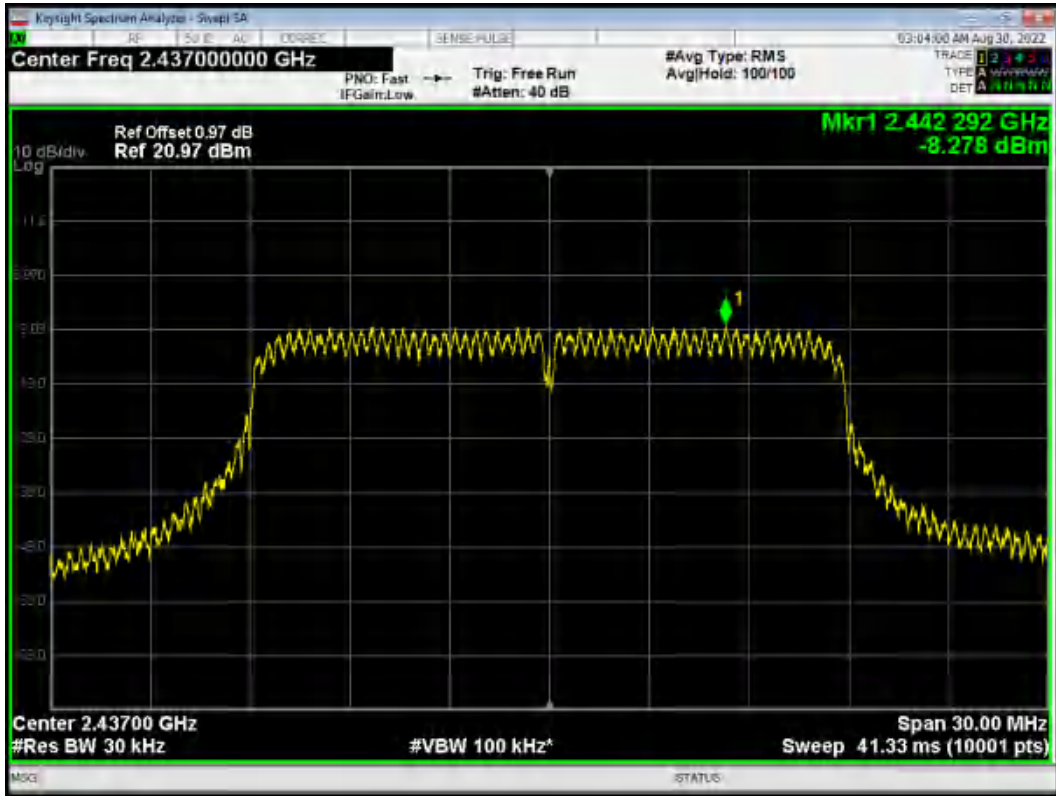

PSD 802.11n(HT20) 2457MHz

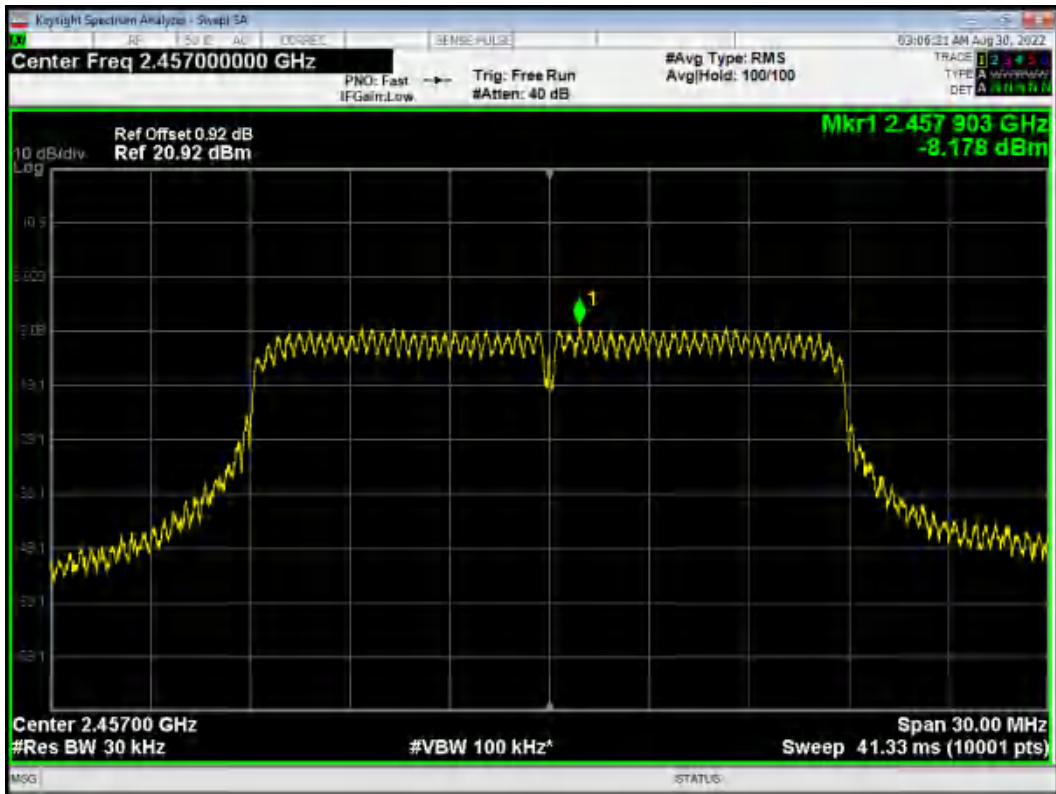



PSD 802.11n(HT20) 2462MHz

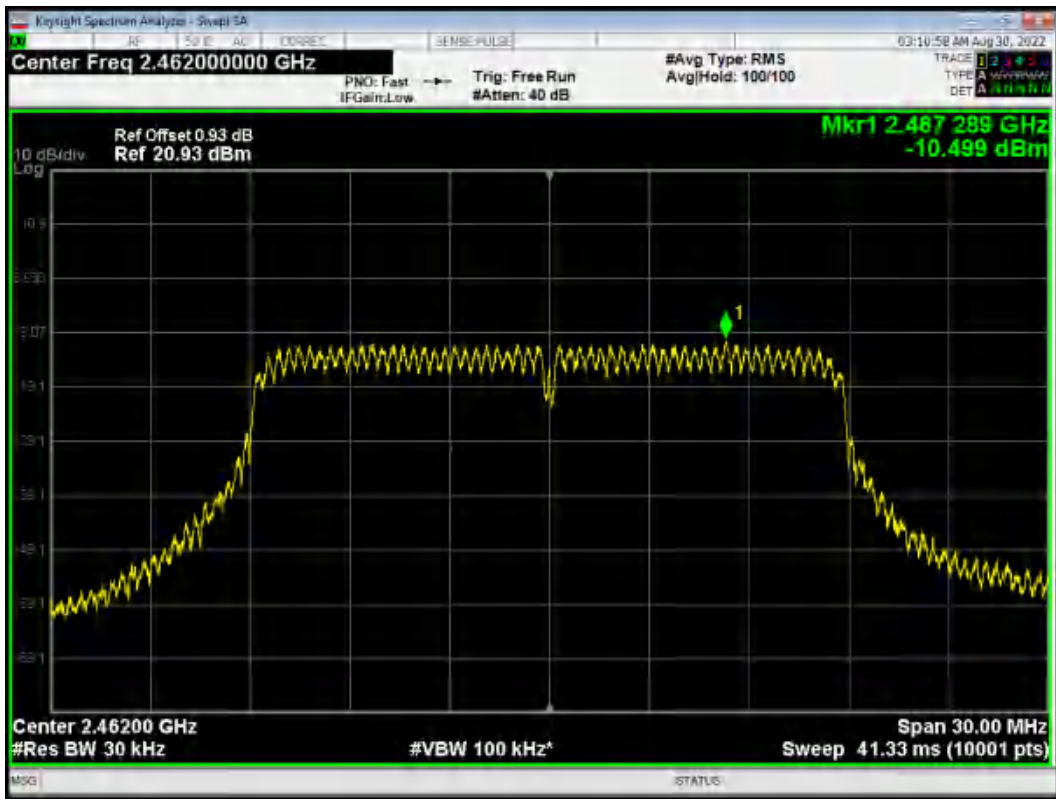

PSD 802.11n(HT40) 2422MHz

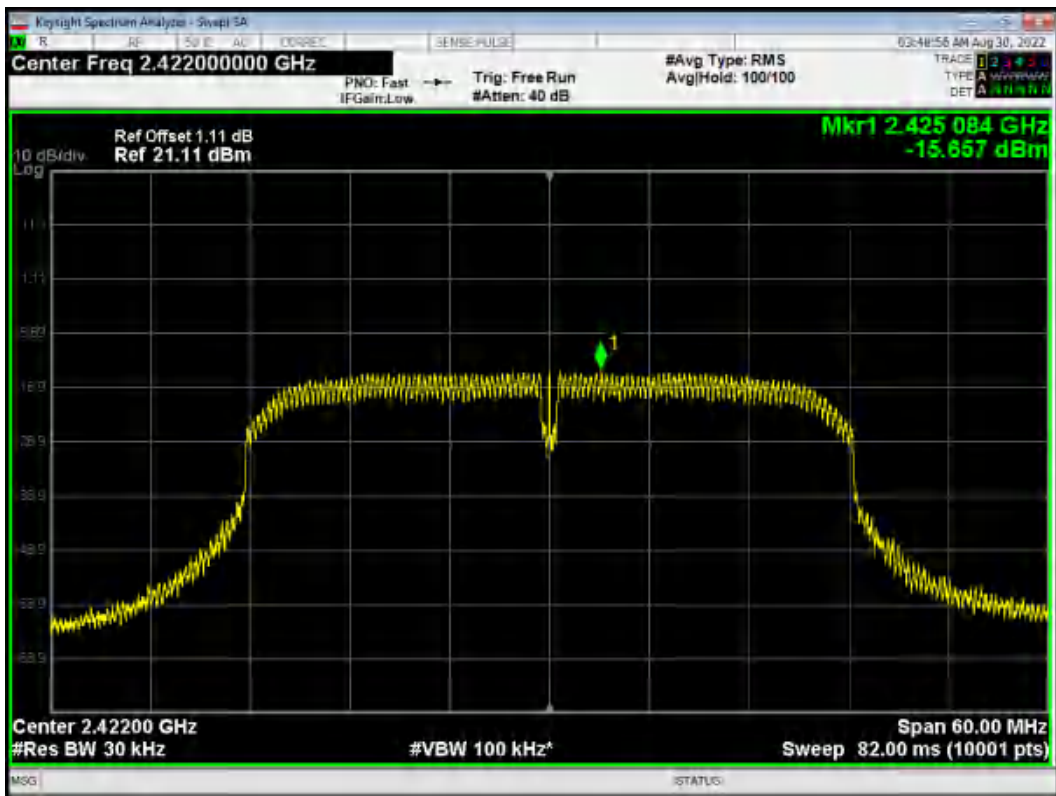



PSD 802.11n(HT40) 2427MHz

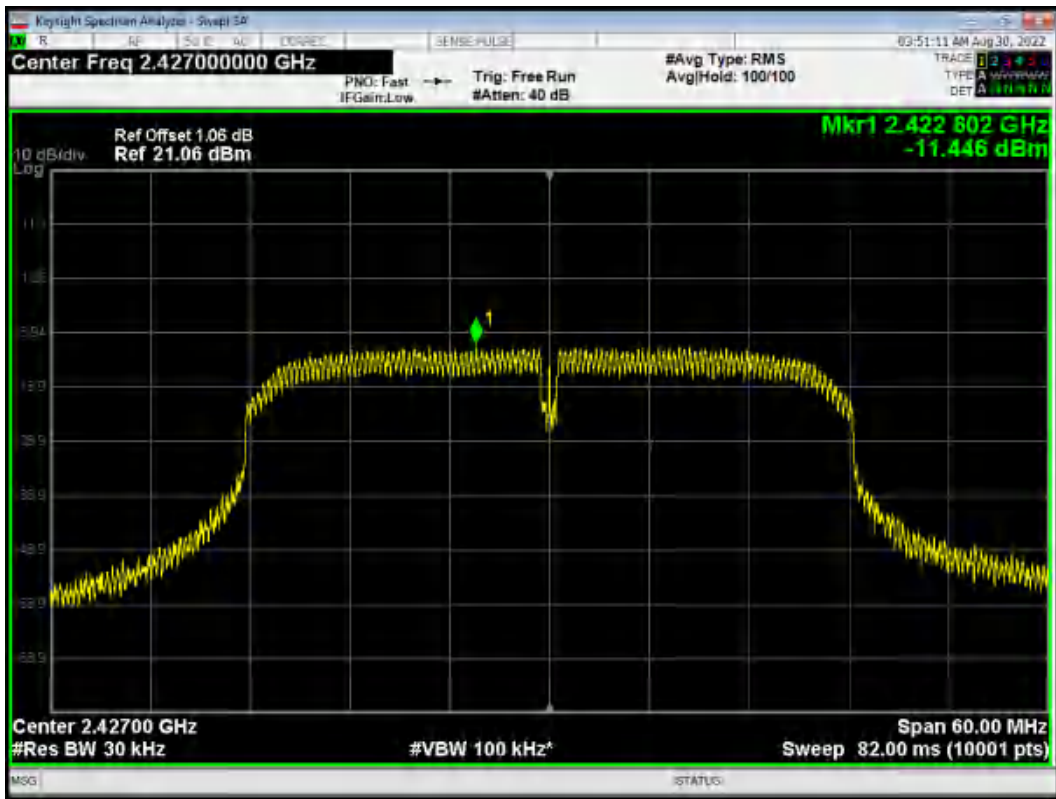

PSD 802.11n(HT40) 2437MHz

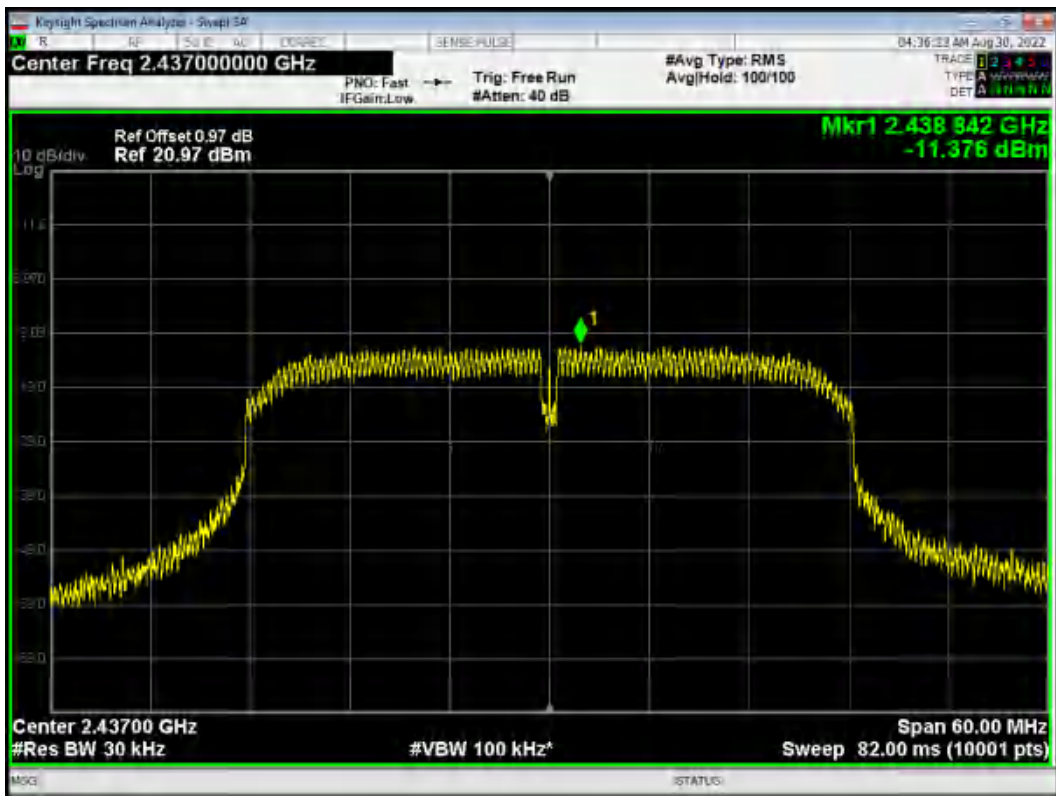



PSD 802.11n(HT40) 2447MHz

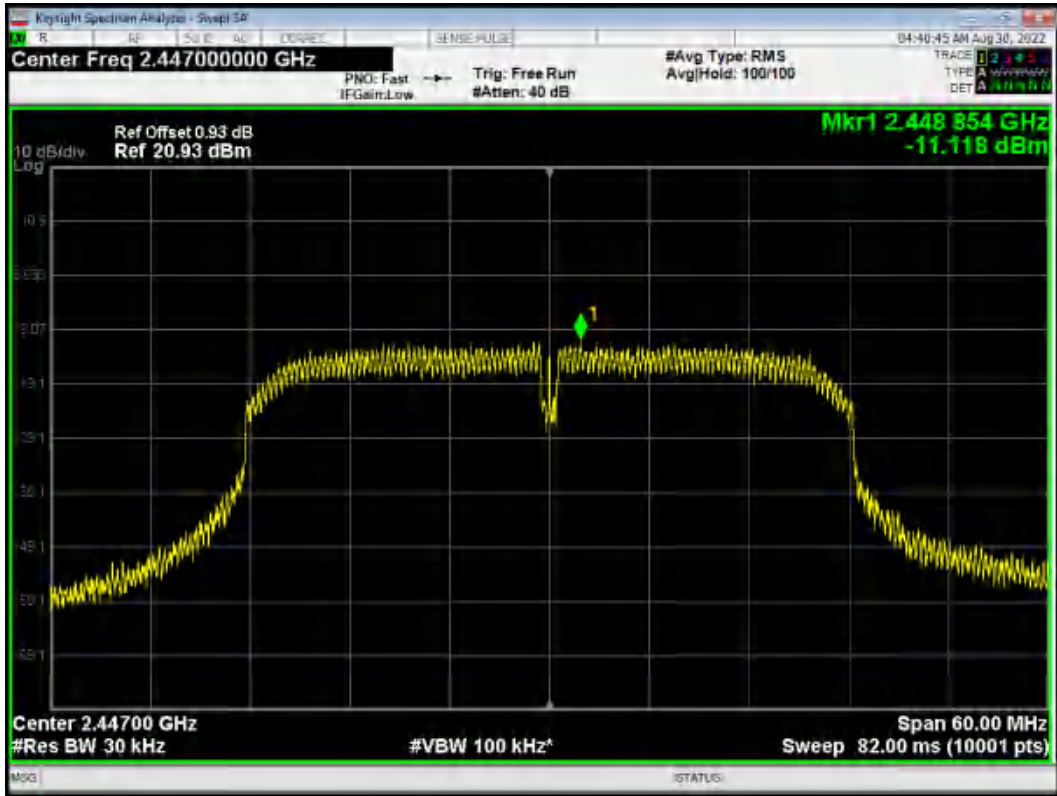

PSD 802.11n(HT40) 2452MHz

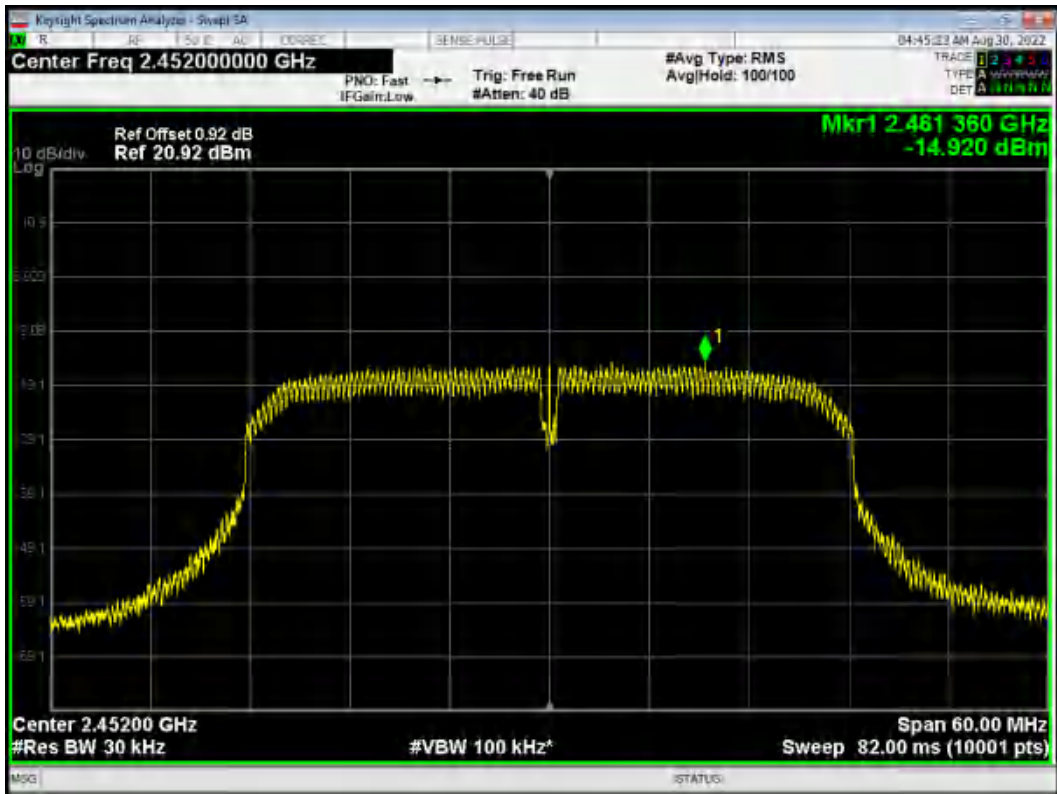



PSD BLE 2402MHz

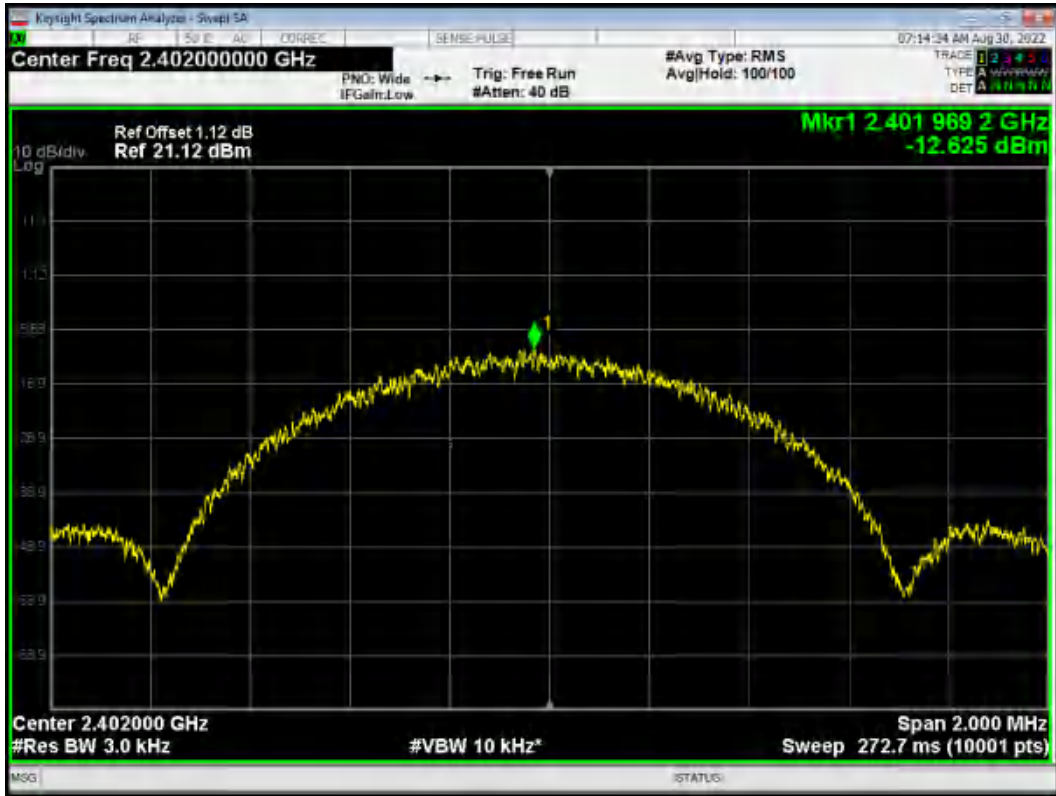

PSD BLE 2440MHz





PSD BLE 2480MHz





5.5. Spurious RF Conducted Emissions

Ambient condition

Temperature	Relative humidity	Pressure
23°C ~25°C	45%~50%	101.5kPa

Method of Measurement

The EUT was connected to the spectrum analyzer with a known loss. The spectrum analyzer scans from 30MHz to the 10th harmonic of the carrier. The peak detector is used. Set RBW to 100 kHz and VBW to 300 kHz, Sweep is set to ATUO.

The test is in transmitting mode.

Test setup



Limits

Rule Part 15.247(d) pacifies that "In any 100 kHz bandwidth outside the frequency band in which the spread spectrum or digitally modulated intentional radiator is operating, the radio frequency power that is produced by the intentional radiator shall be at least 20 dB below that in the 100 kHz bandwidth within the band that contains the highest level of the desired power, based on either an RF conducted or a radiated measurement, provided the transmitter demonstrates compliance with the peak conducted power limits. If the transmitter complies with the conducted power limits based on the use of RMS averaging over a time interval, as permitted under paragraph (b)(3) of this section, the attenuation required under this paragraph shall be 30 dB instead of 20 dB. "

Antenna 1

Test Mode	Carrier frequency (MHz) / Channel	Reference value (dBm)	Limit
802.11b	2412/CH1	4.550	-25.45
	2437/CH6	3.930	-26.07
	2462/CH11	3.660	-26.34
802.11g	2412/CH1	-1.030	-31.03
	2417/CH2	2.080	-27.92
	2437/CH6	2.130	-27.87
	2457/CH10	2.250	-27.75
	2462/CH11	-0.470	-30.47
802.11n HT20	2412/CH1	-0.890	-30.89
	2417/CH2	2.330	-27.67
	2437/CH6	1.990	-28.01



	2457/CH10	1.630	-28.37
	2462/CH11	-0.090	-30.09
802.11n HT40	2422/CH3	-5.910	-35.91
	2427/CH4	-2.020	-32.02
	2437/CH6	-1.980	-31.98
	2447/CH8	-1.930	-31.93
	2452/CH9	-5.690	-35.69
Bluetooth (Low Energy)	2402/CH0	8.690	-21.31
	2440/CH19	9.080	-20.92
	2480/CH39	8.600	-21.40

Measurement Uncertainty

The assessed measurement uncertainty to ensure 95% confidence level for the normal distribution is with the coverage factor $k = 1.96$.

Frequency	Uncertainty
100kHz-2GHz	0.684 dB
2GHz-26GHz	1.407 dB



Test Results:

Tx. Spurious 802.11b 2412MHz



Tx. Spurious 802.11b 2412MHz Emission

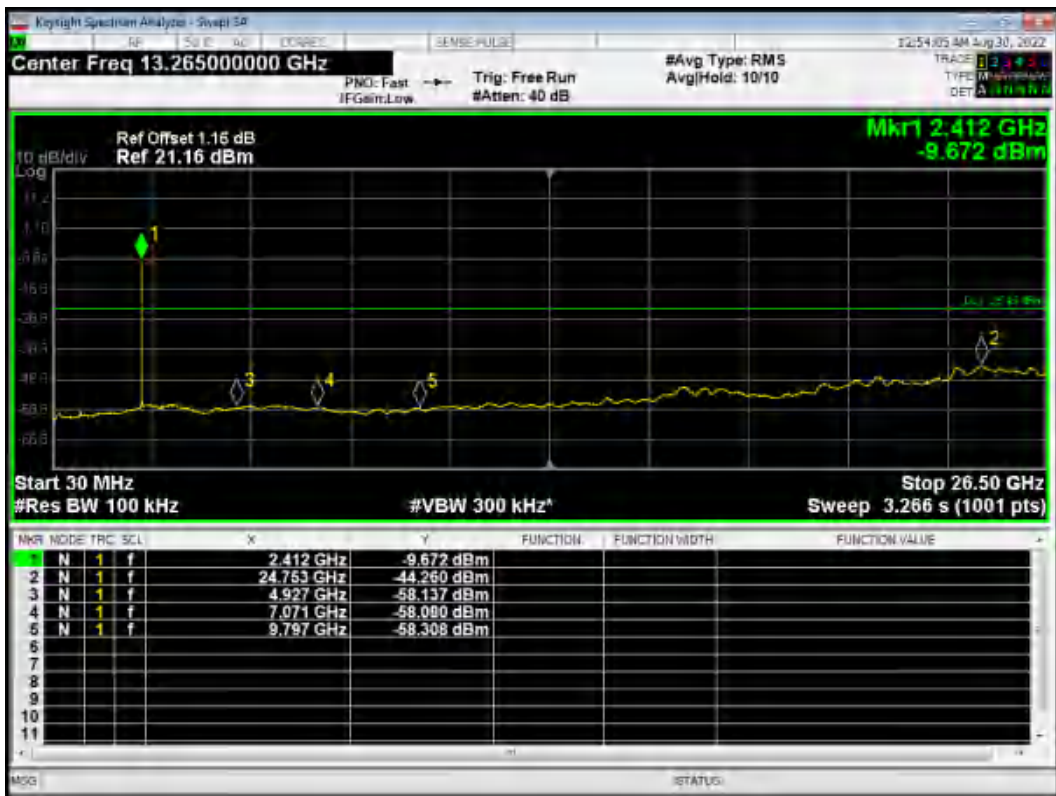



Tx. Spurious 802.11b 2437MHz



Tx. Spurious 802.11b 2437MHz Emission

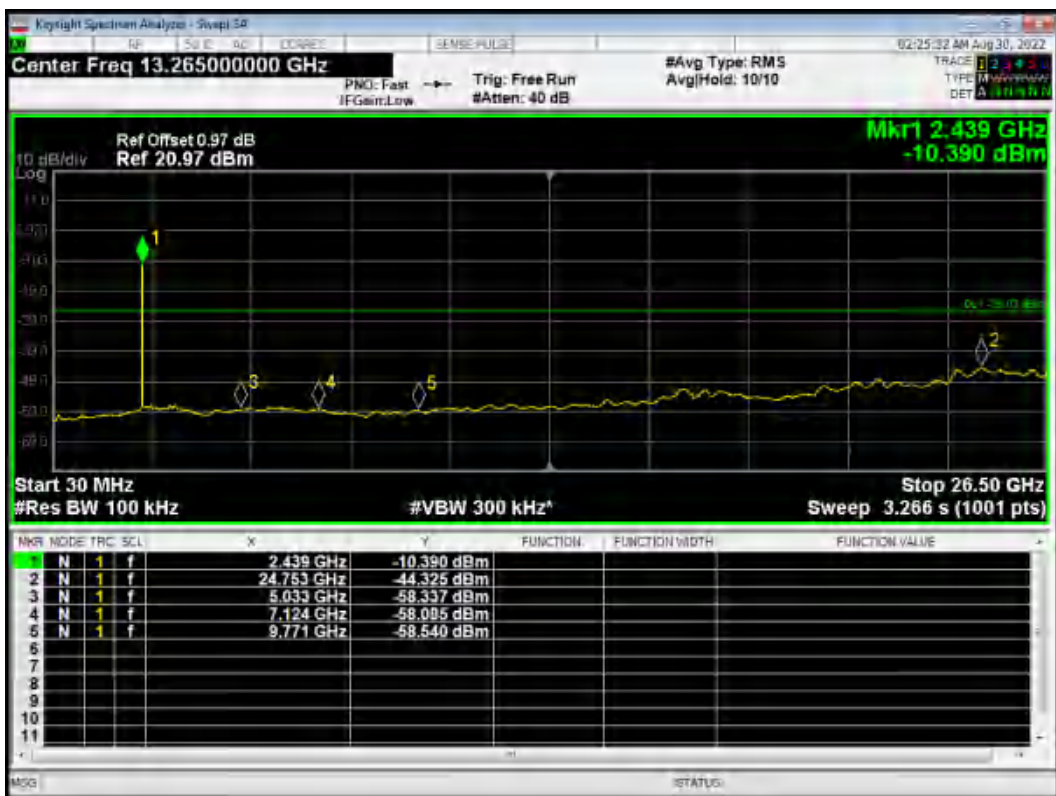



Tx. Spurious 802.11b 2462MHz



Tx. Spurious 802.11b 2462MHz Emission

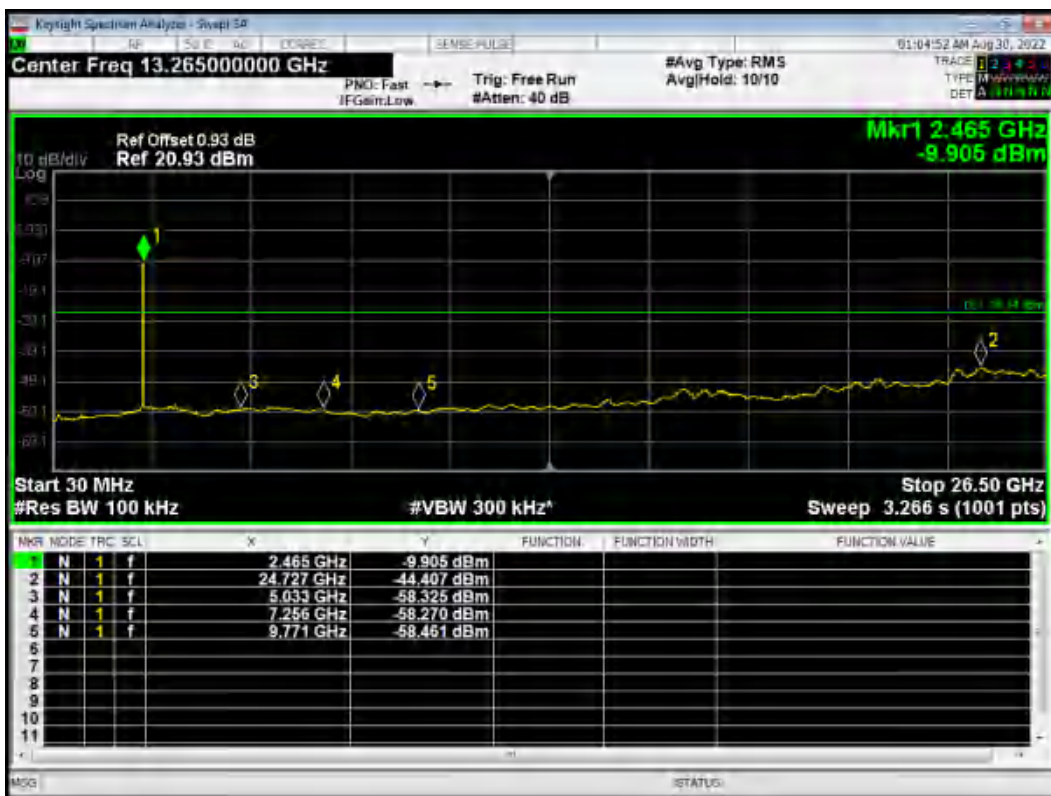



Tx. Spurious 802.11g 2412MHz

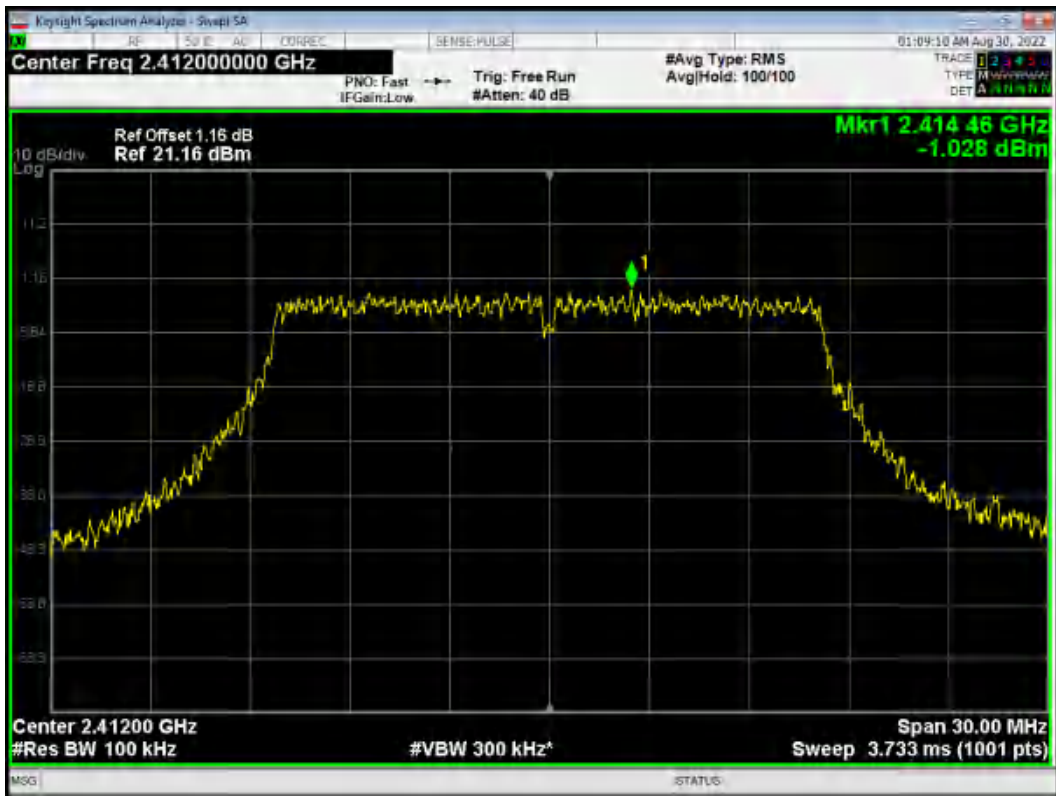

Tx. Spurious 802.11g 2412MHz Emission

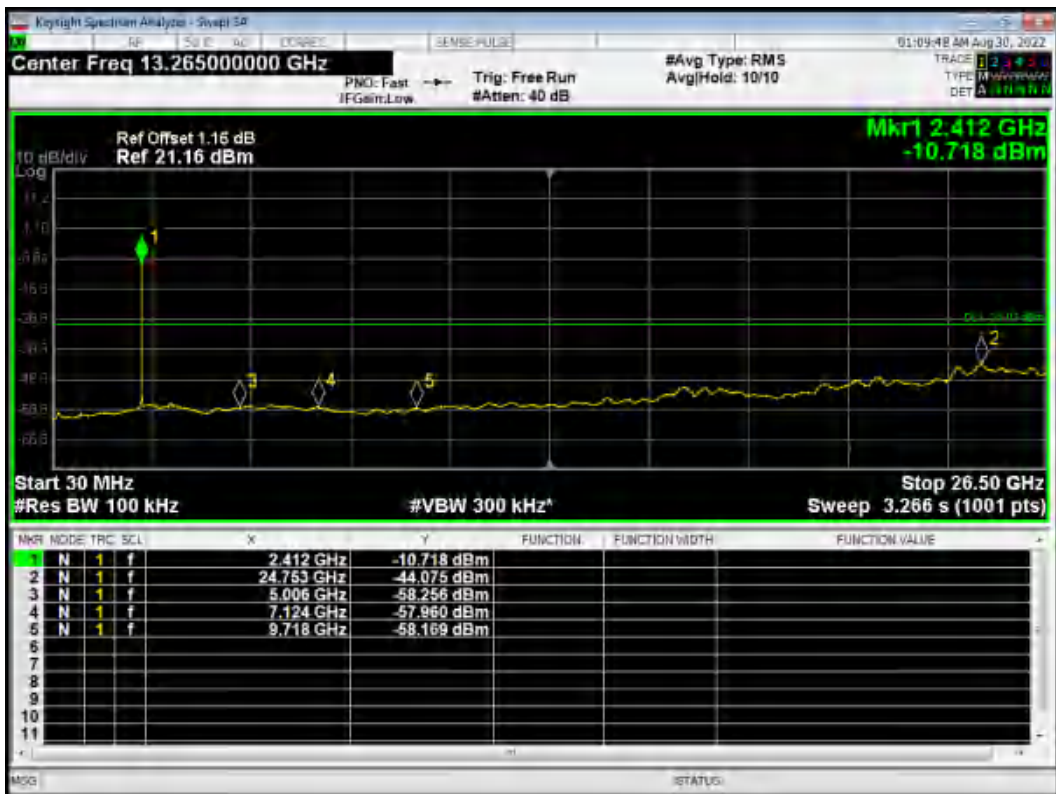



Tx. Spurious 802.11g 2417MHz

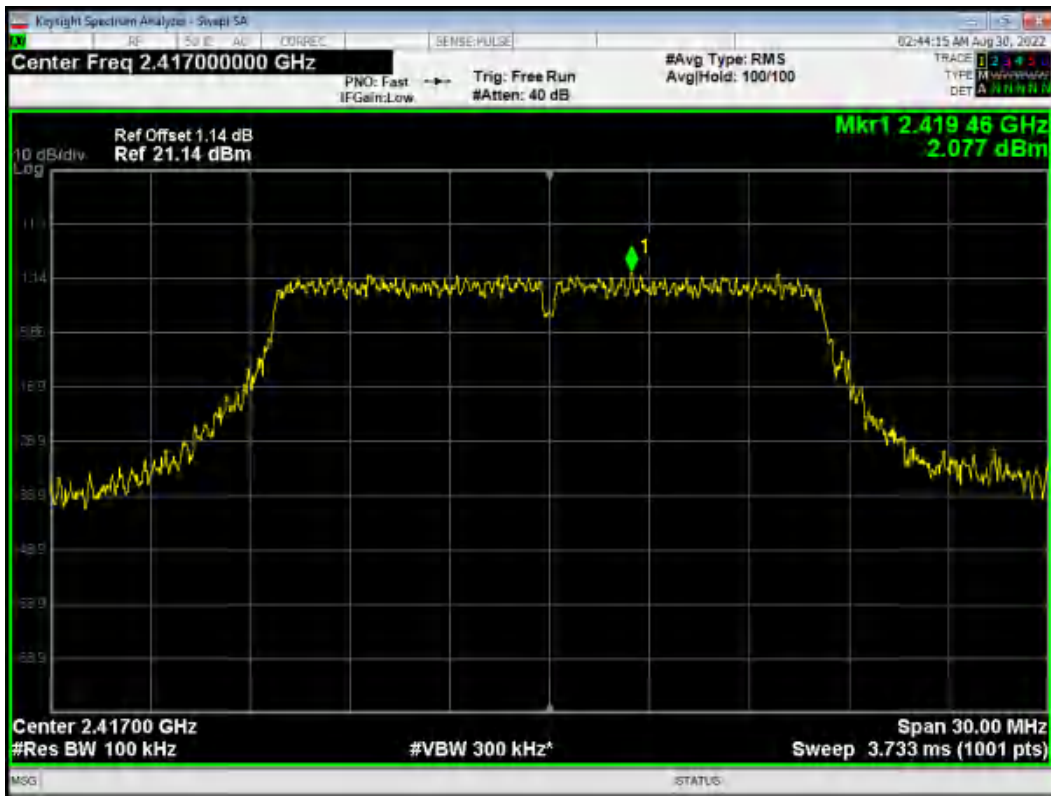

Tx. Spurious 802.11g 2417MHz Emission

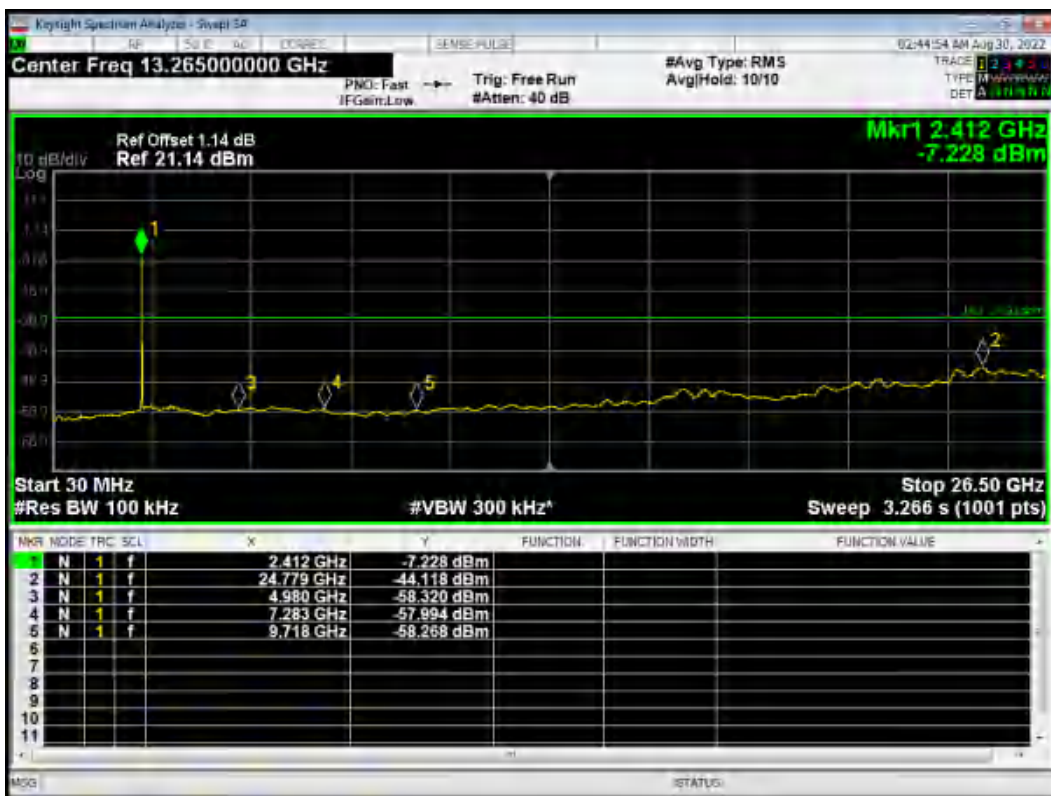



Tx. Spurious 802.11g 2437MHz

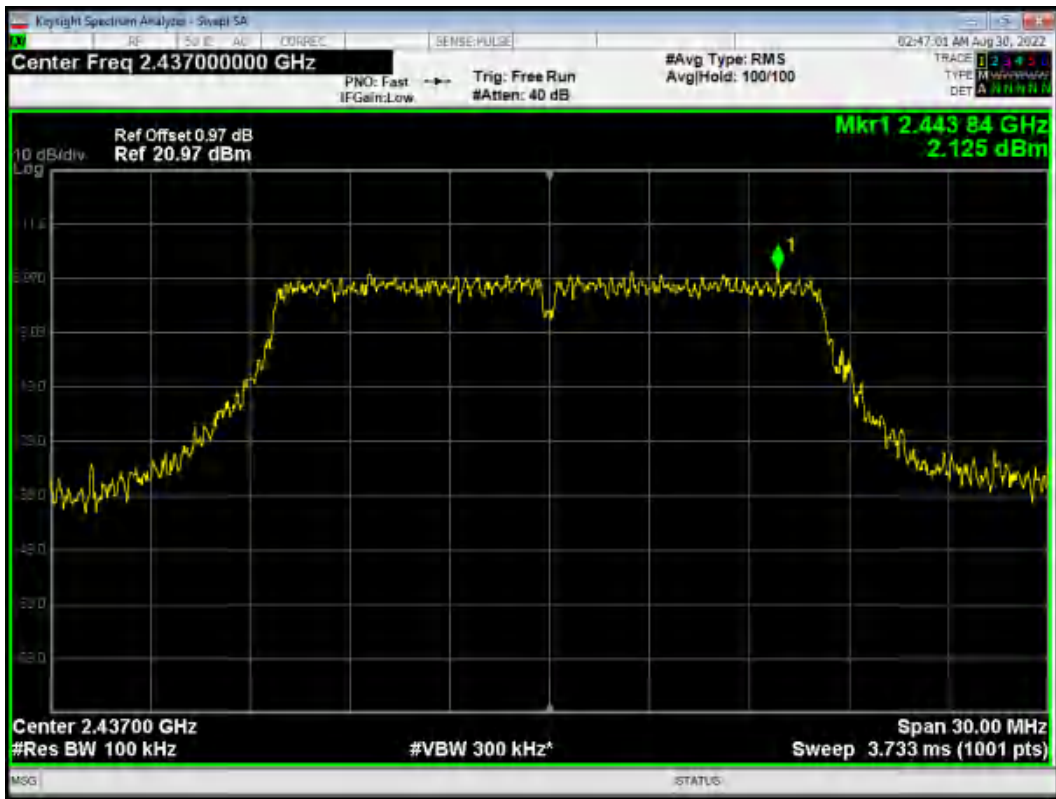

Tx. Spurious 802.11g 2437MHz Emission

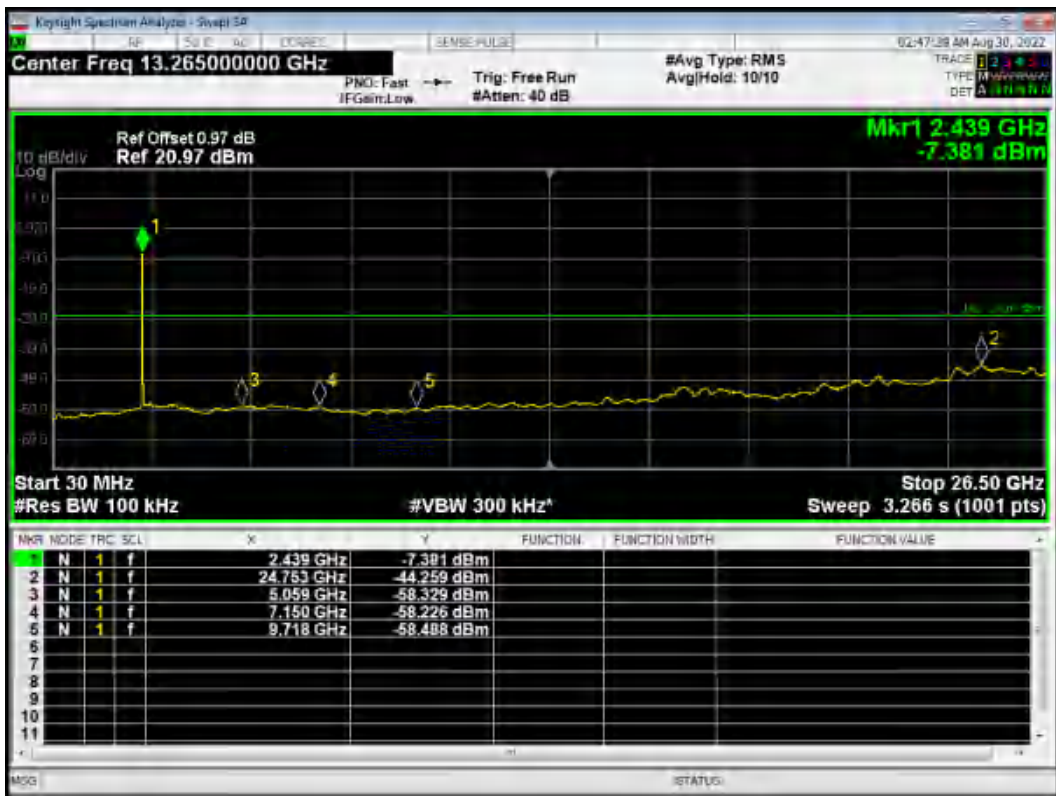



Tx. Spurious 802.11g 2457MHz

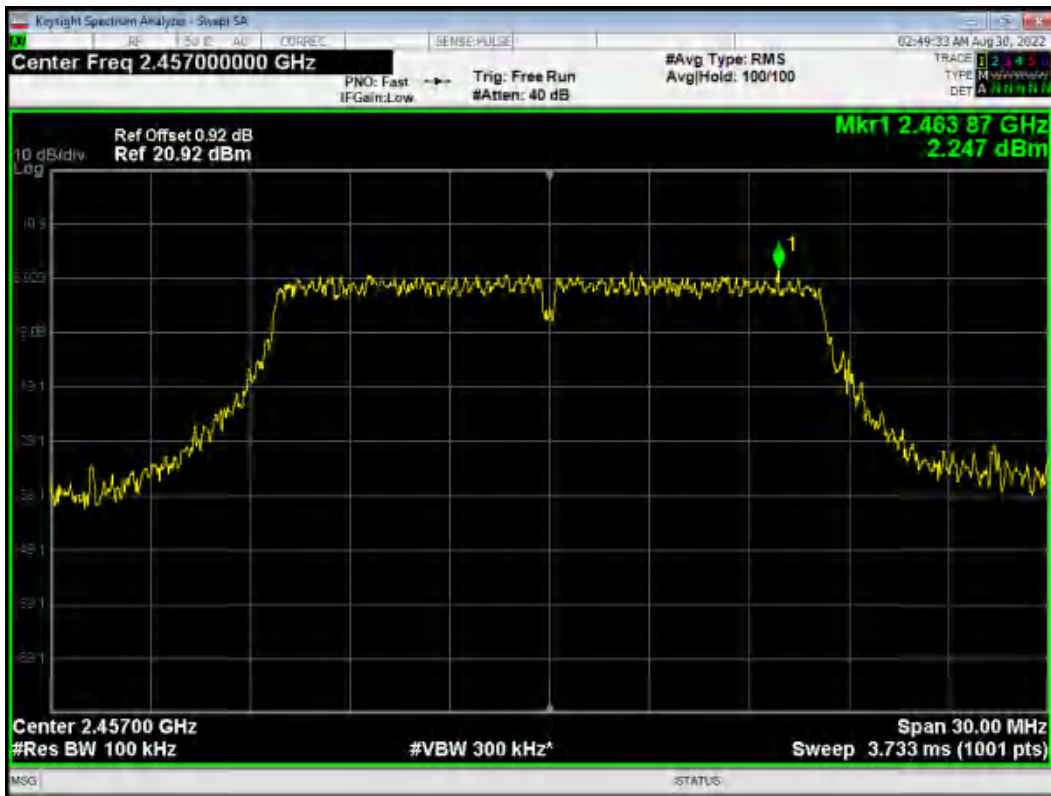

Tx. Spurious 802.11g 2457MHz Emission

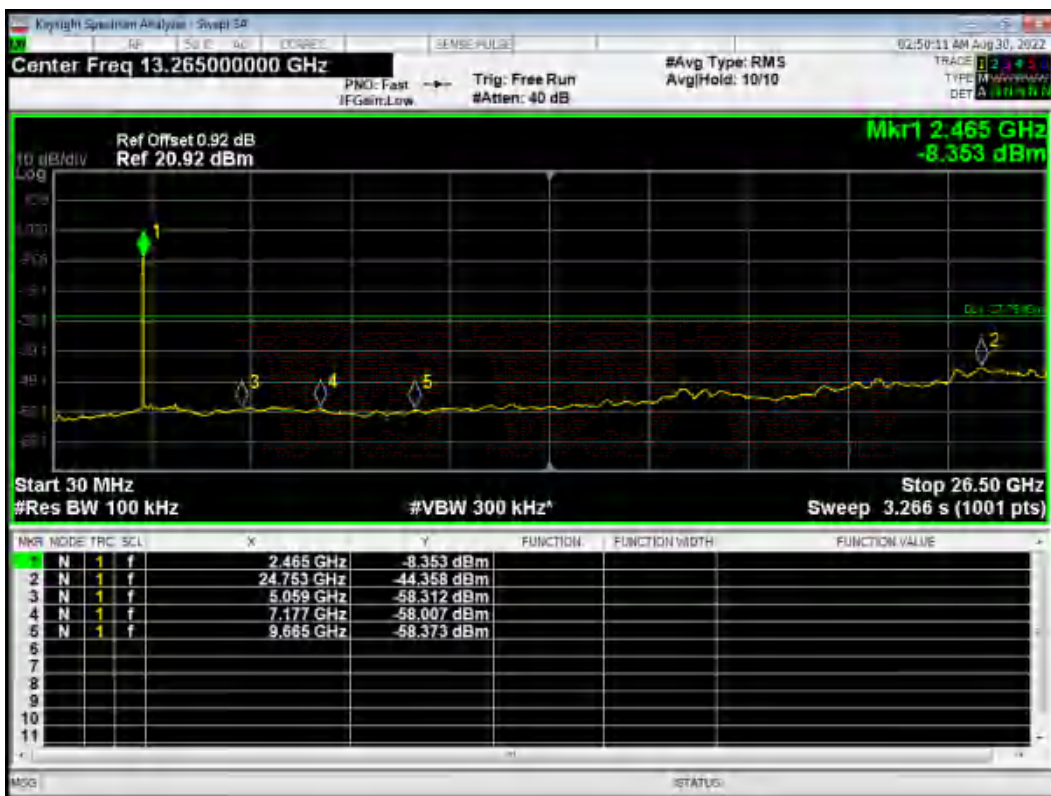



Tx. Spurious 802.11g 2462MHz

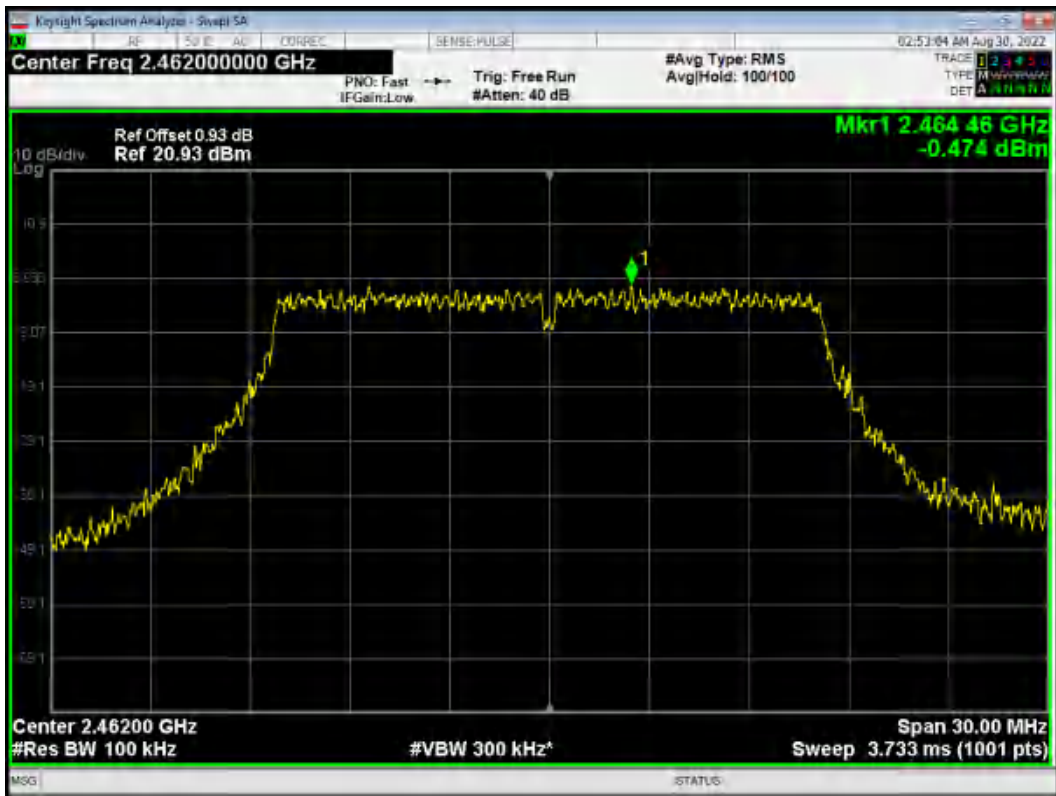

Tx. Spurious 802.11g 2462MHz Emission

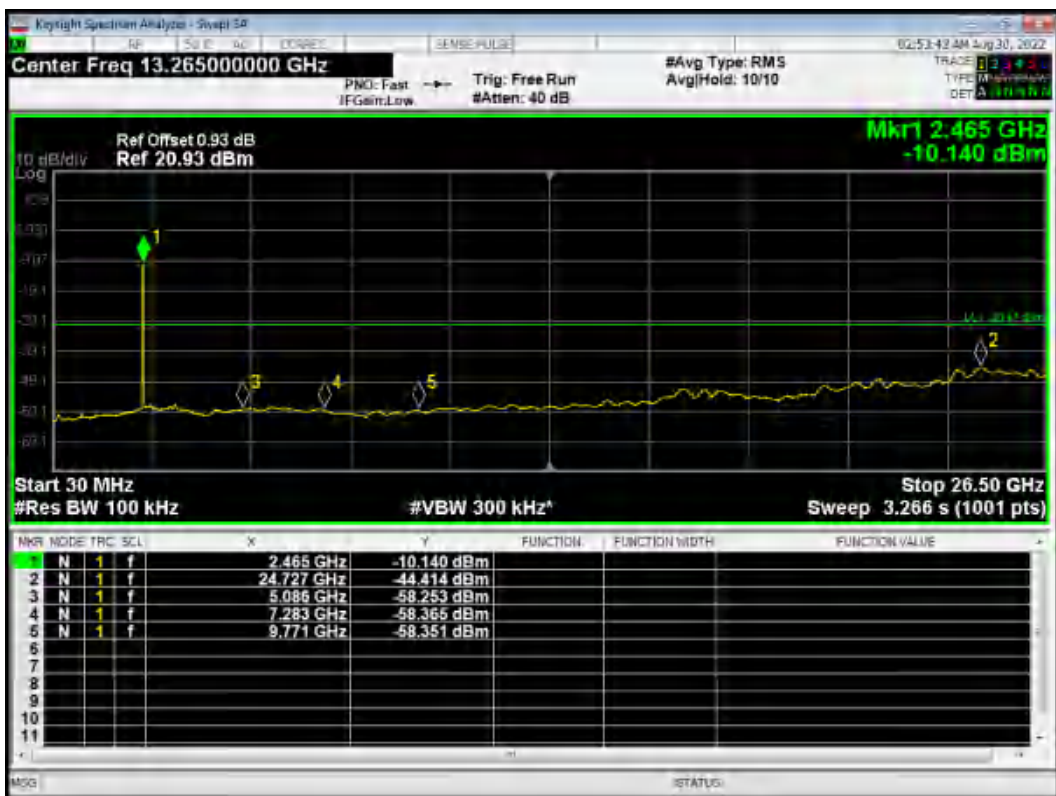



Tx. Spurious 802.11n(HT20) 2412MHz

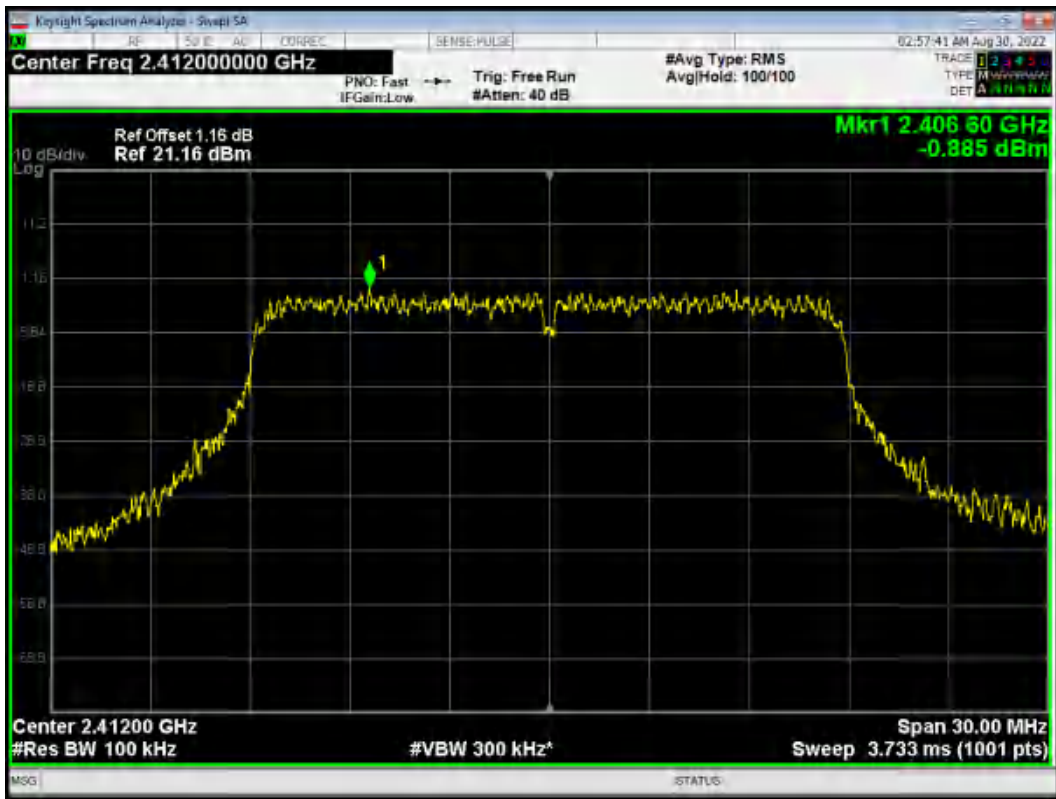

Tx. Spurious 802.11n(HT20) 2412MHz Emission

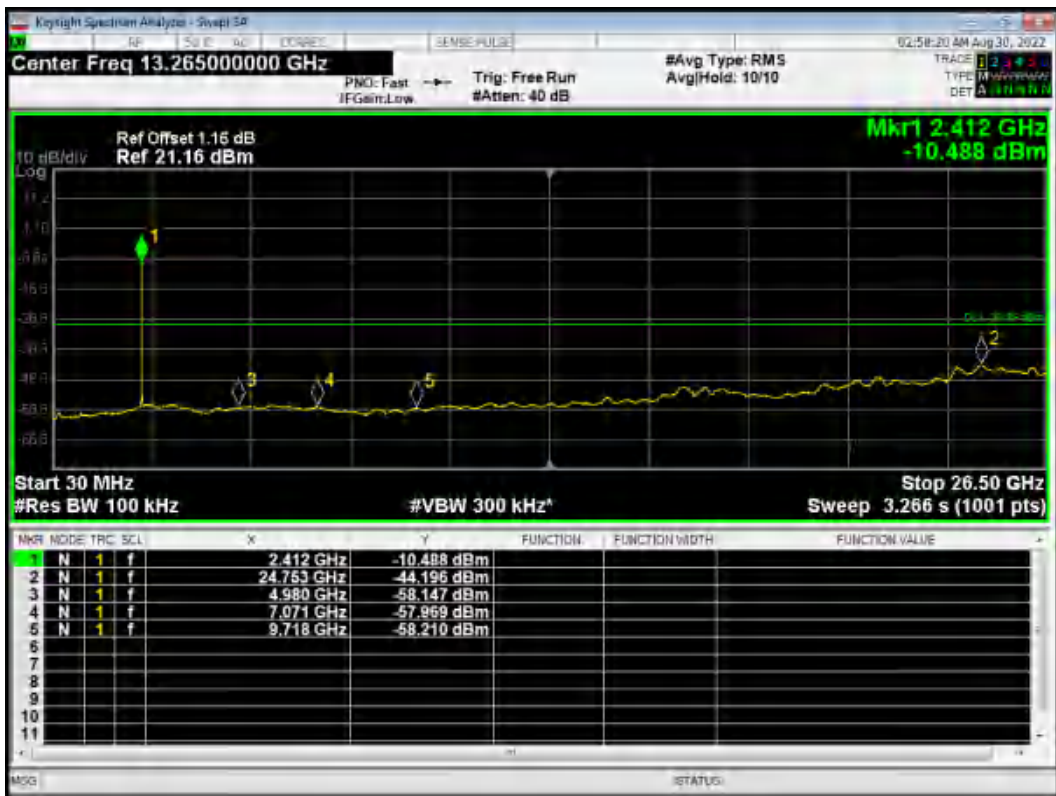



Tx. Spurious 802.11n(HT20) 2417MHz

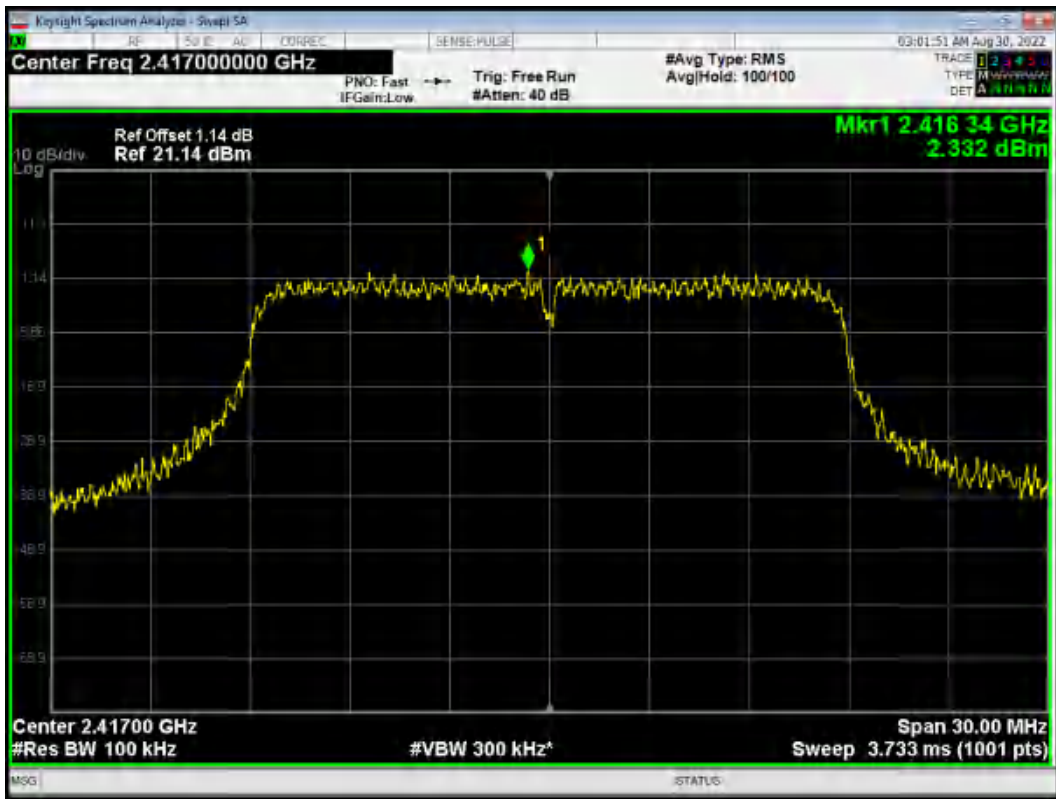

Tx. Spurious 802.11n(HT20) 2417MHz Emission





Tx. Spurious 802.11n(HT20) 2437MHz

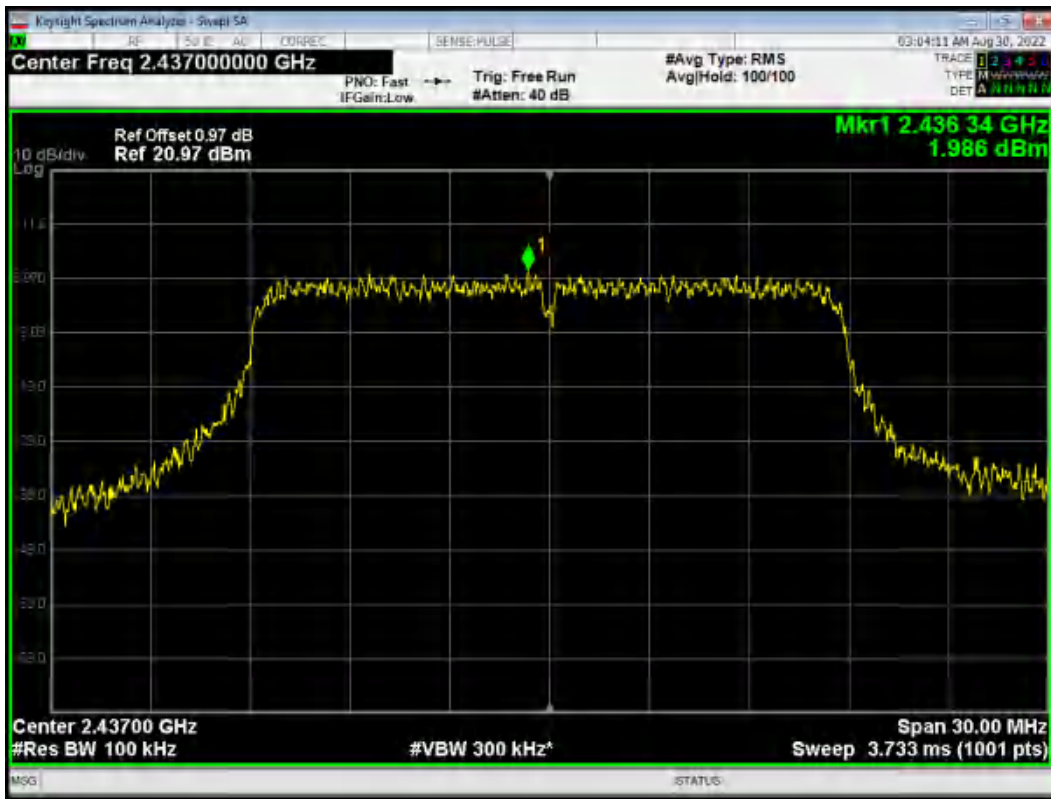

Tx. Spurious 802.11n(HT20) 2437MHz Emission

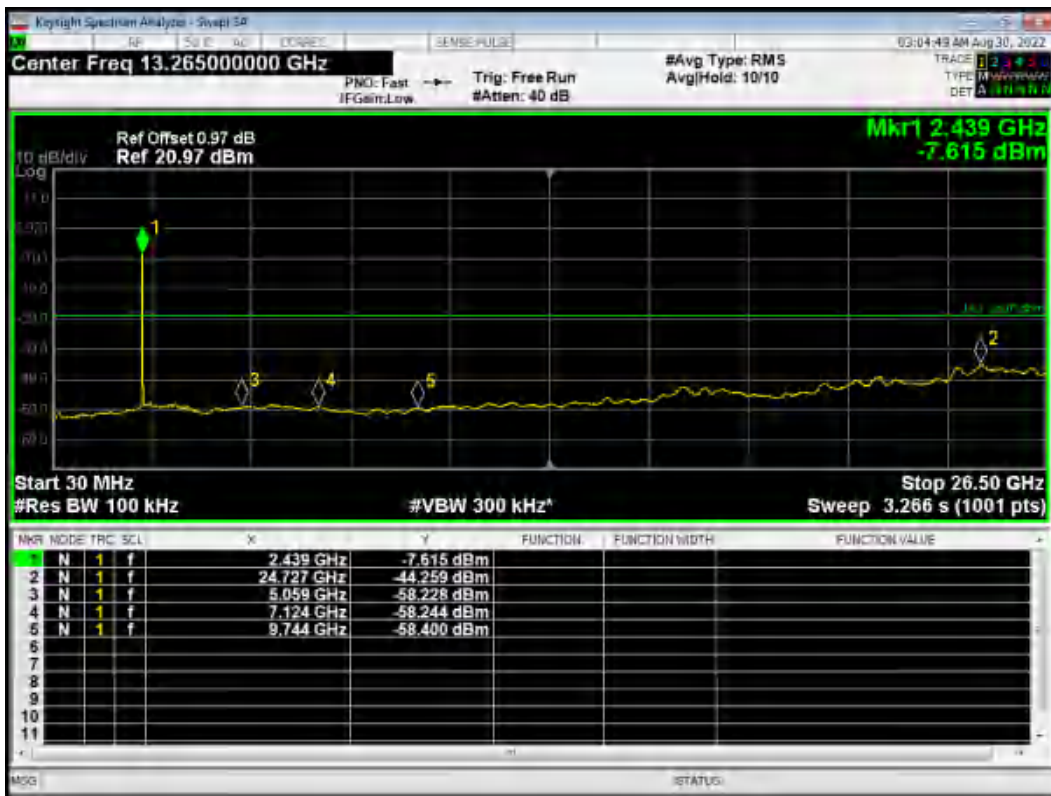



Tx. Spurious 802.11n(HT20) 2457MHz



Tx. Spurious 802.11n(HT20) 2457MHz Emission

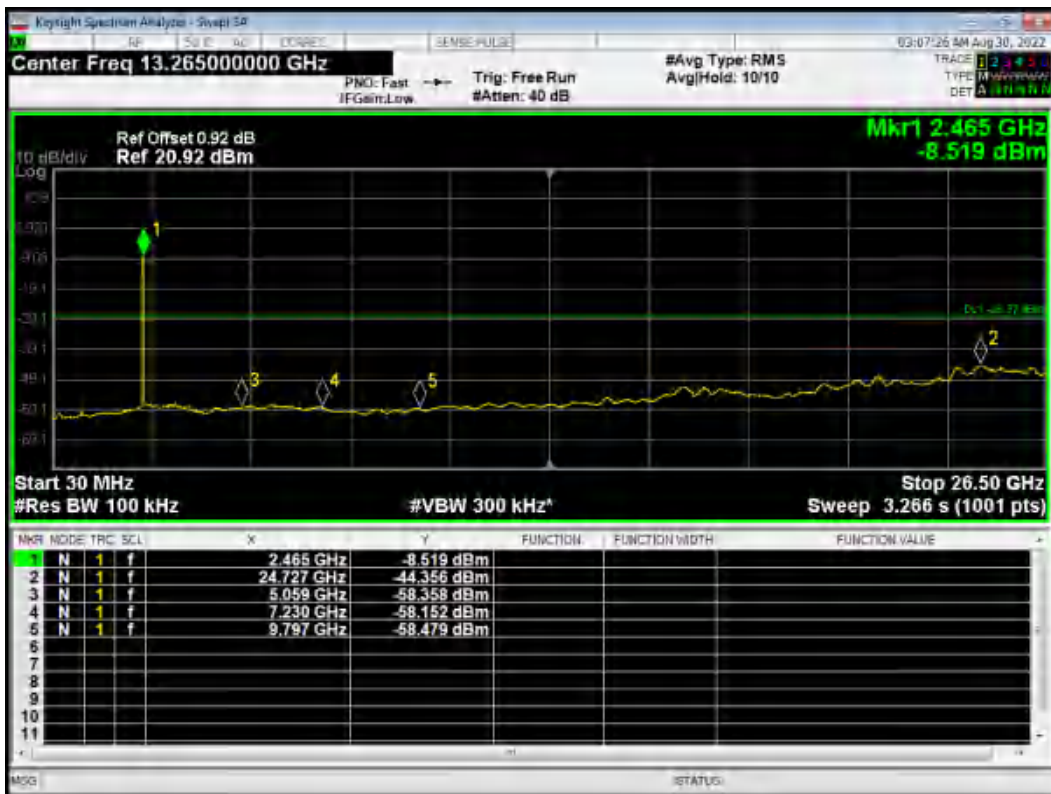



Tx. Spurious 802.11n(HT20) 2462MHz



Tx. Spurious 802.11n(HT20) 2462MHz Emission

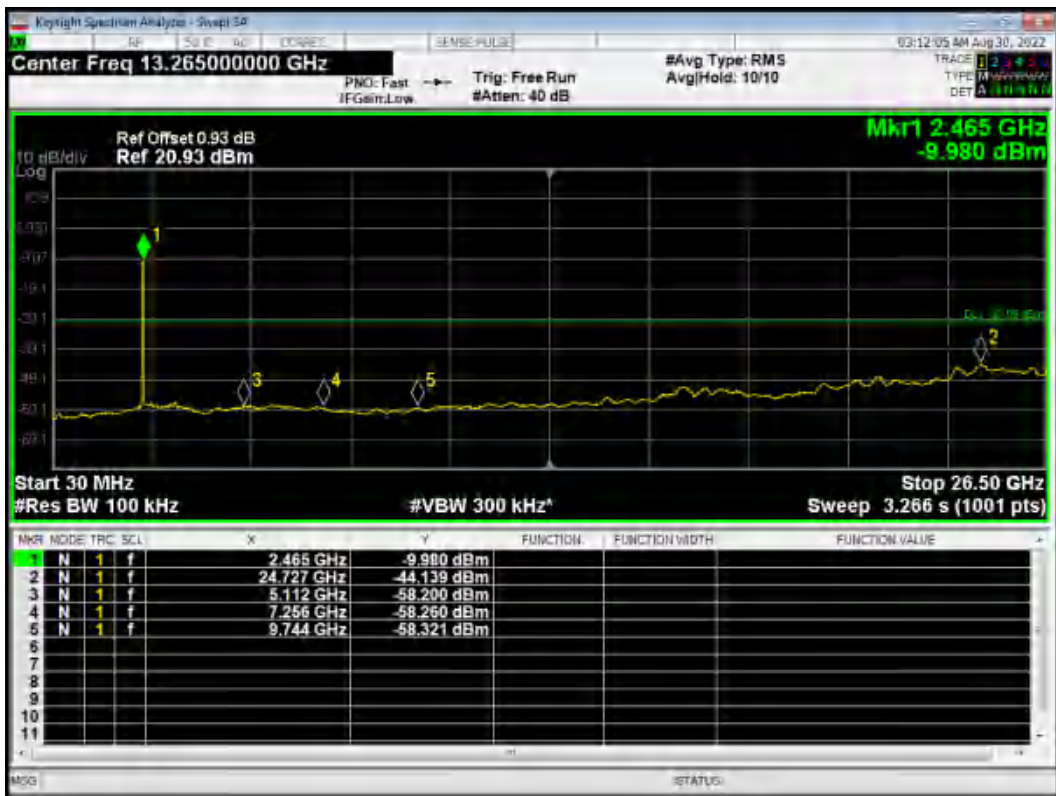



Tx. Spurious 802.11n(HT40) 2422MHz

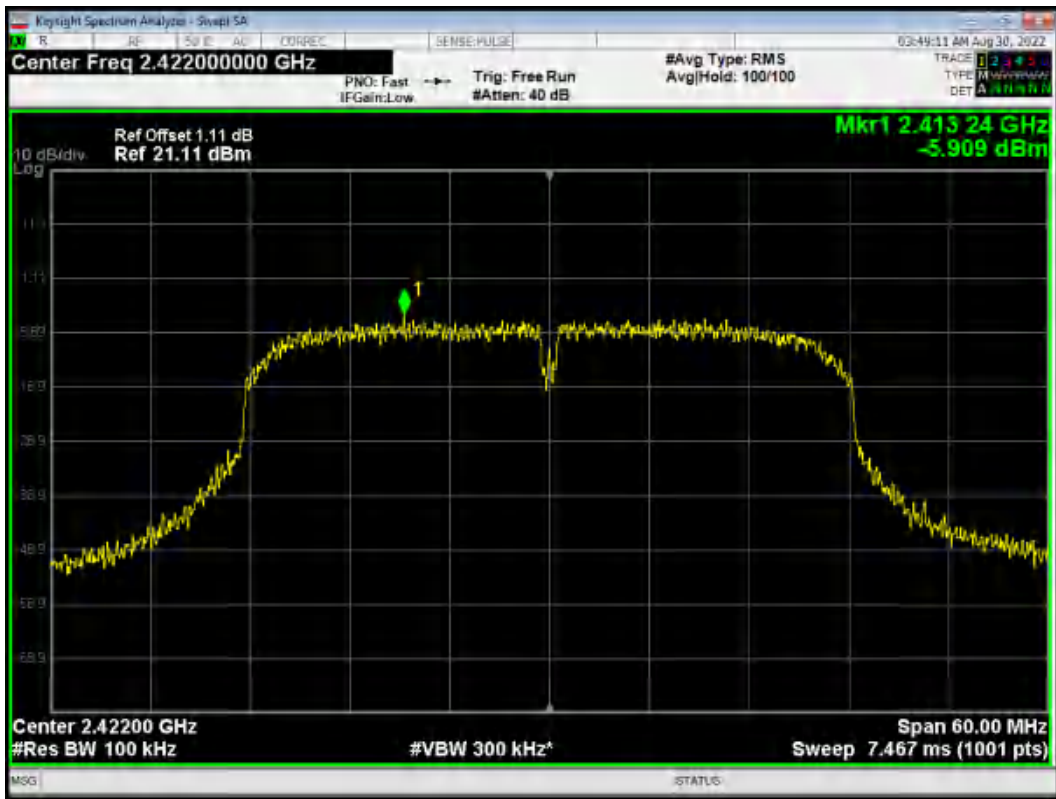

Tx. Spurious 802.11n(HT40) 2422MHz Emission

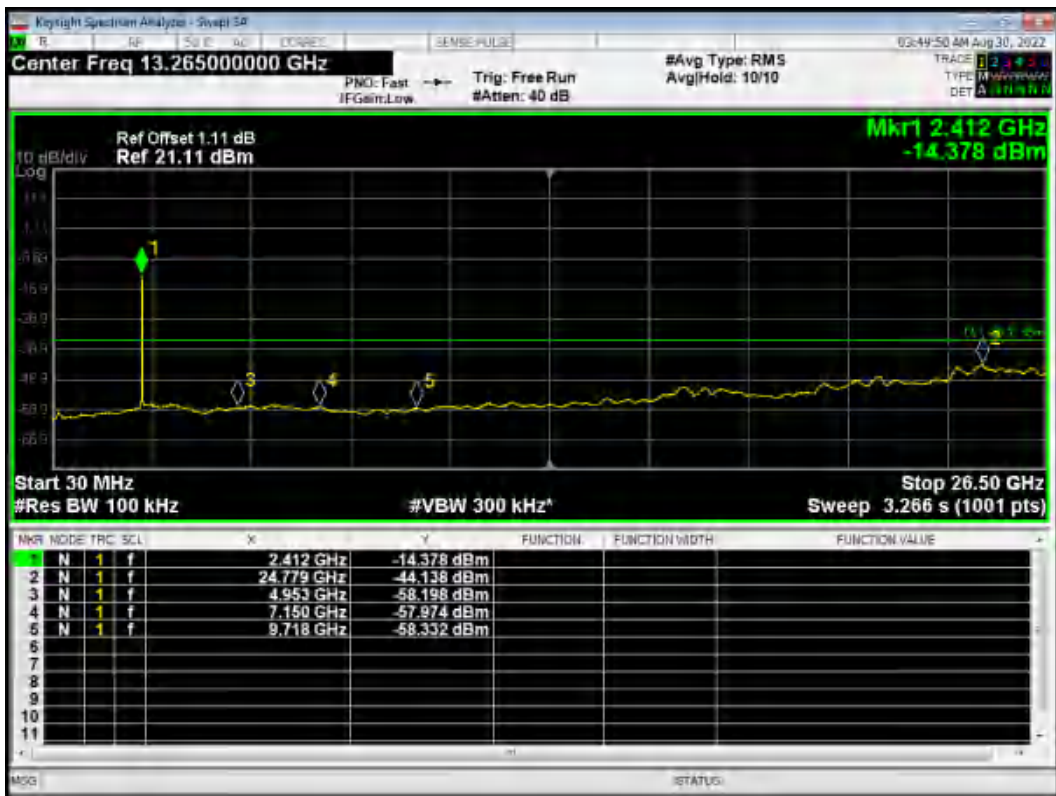



Tx. Spurious 802.11n(HT40) 2427MHz



Tx. Spurious 802.11n(HT40) 2427MHz Emission

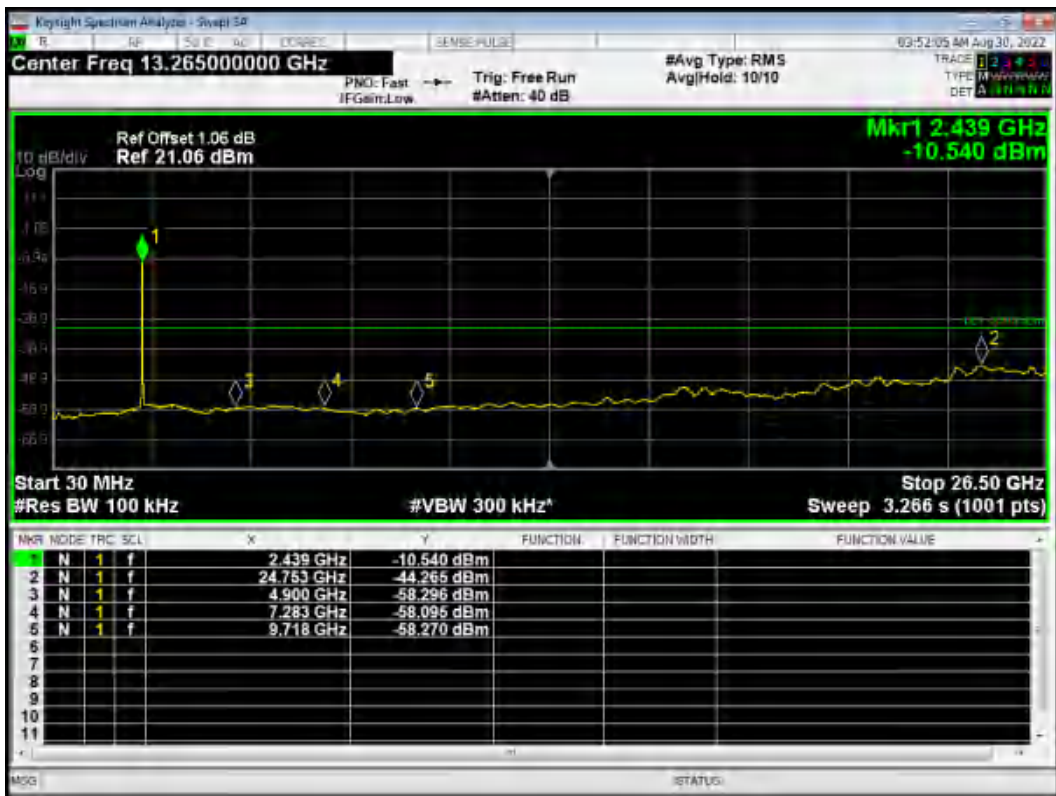



Tx. Spurious 802.11n(HT40) 2437MHz

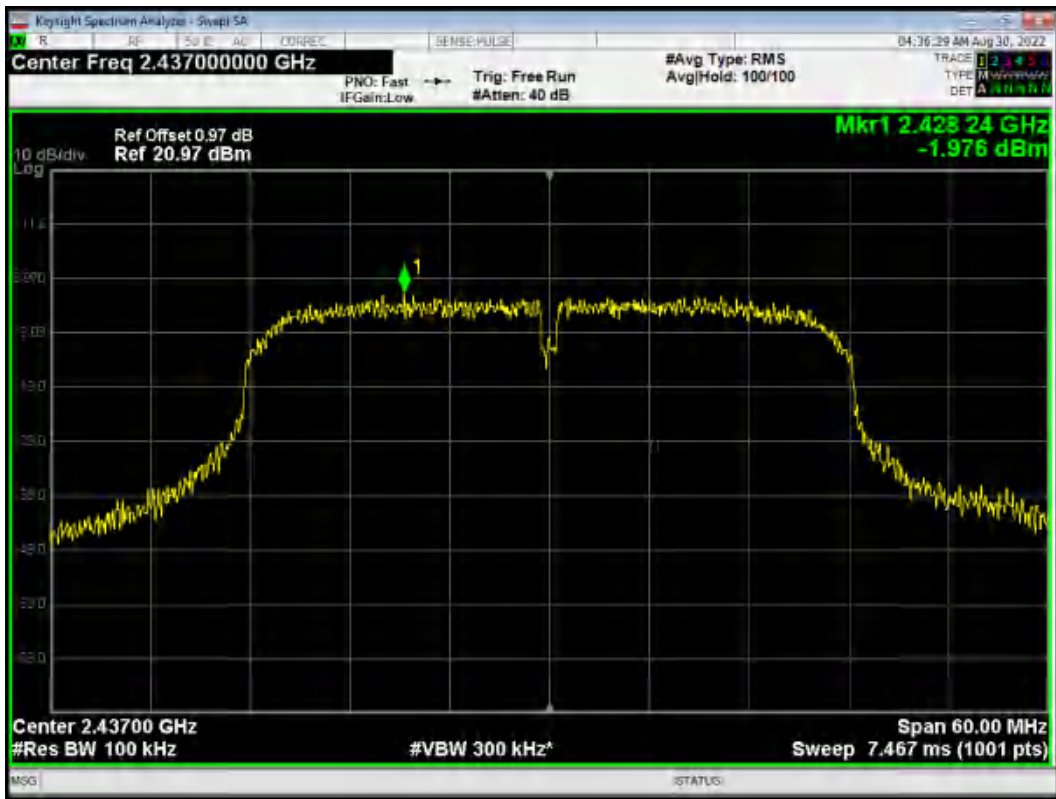

Tx. Spurious 802.11n(HT40) 2437MHz Emission

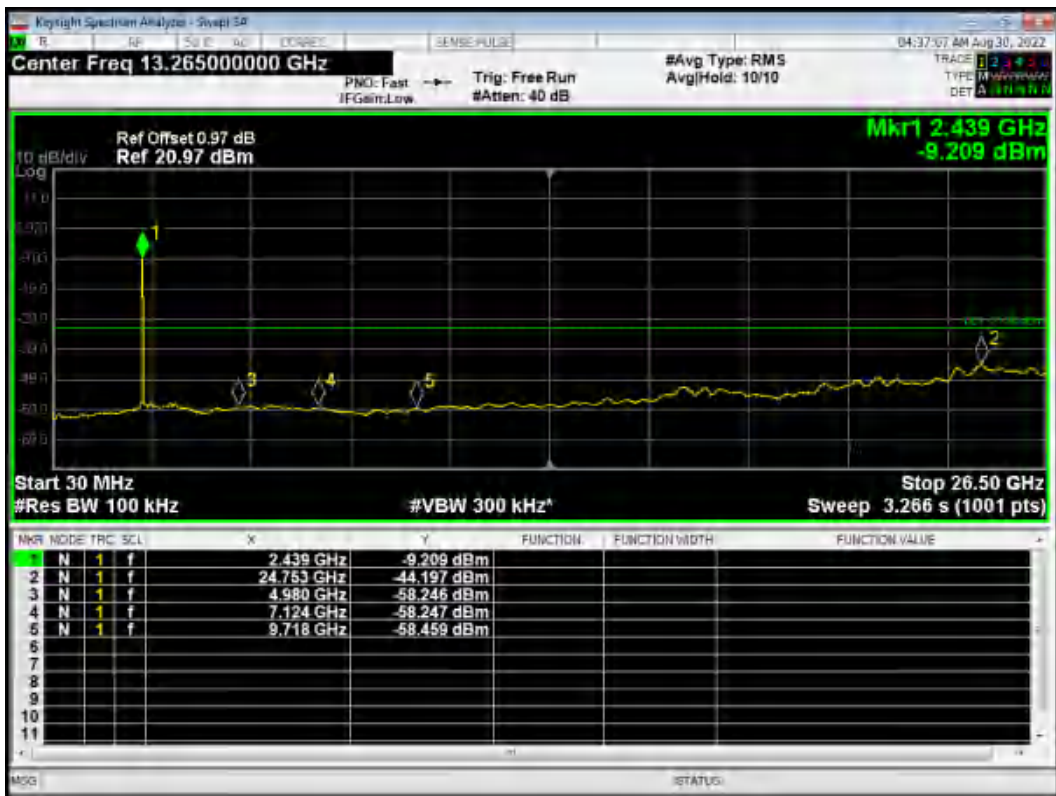



Tx. Spurious 802.11n(HT40) 2447MHz



Tx. Spurious 802.11n(HT40) 2447MHz Emission

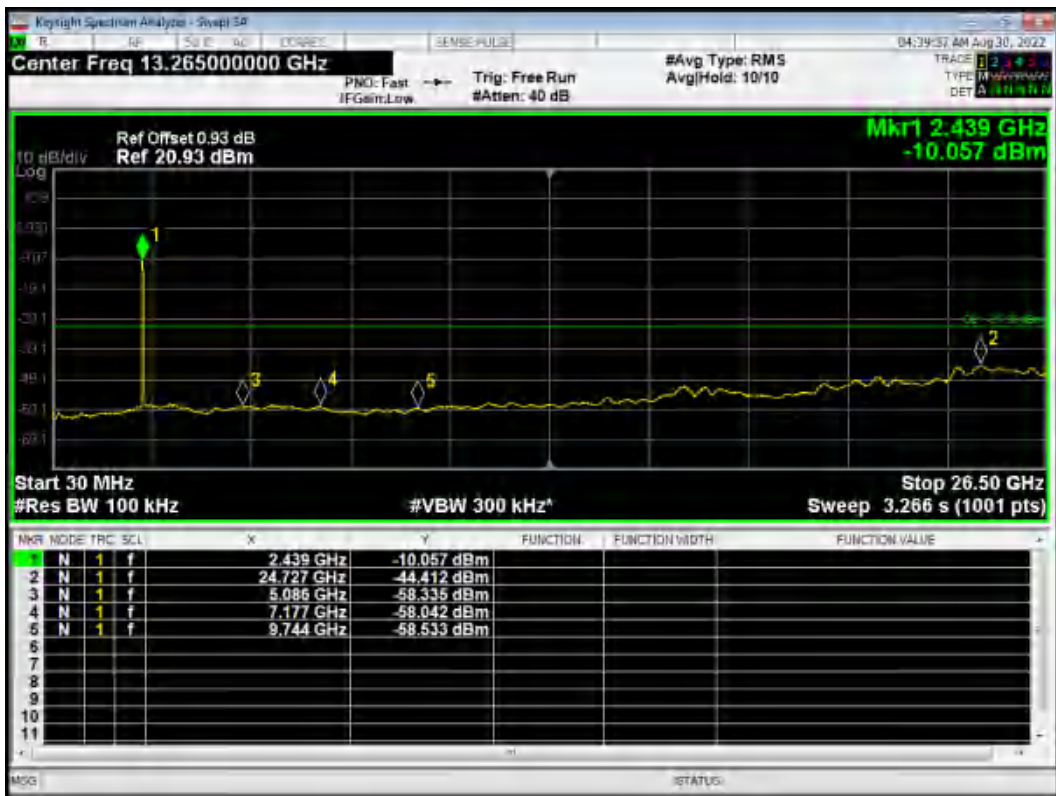



Tx. Spurious 802.11n(HT40) 2452MHz

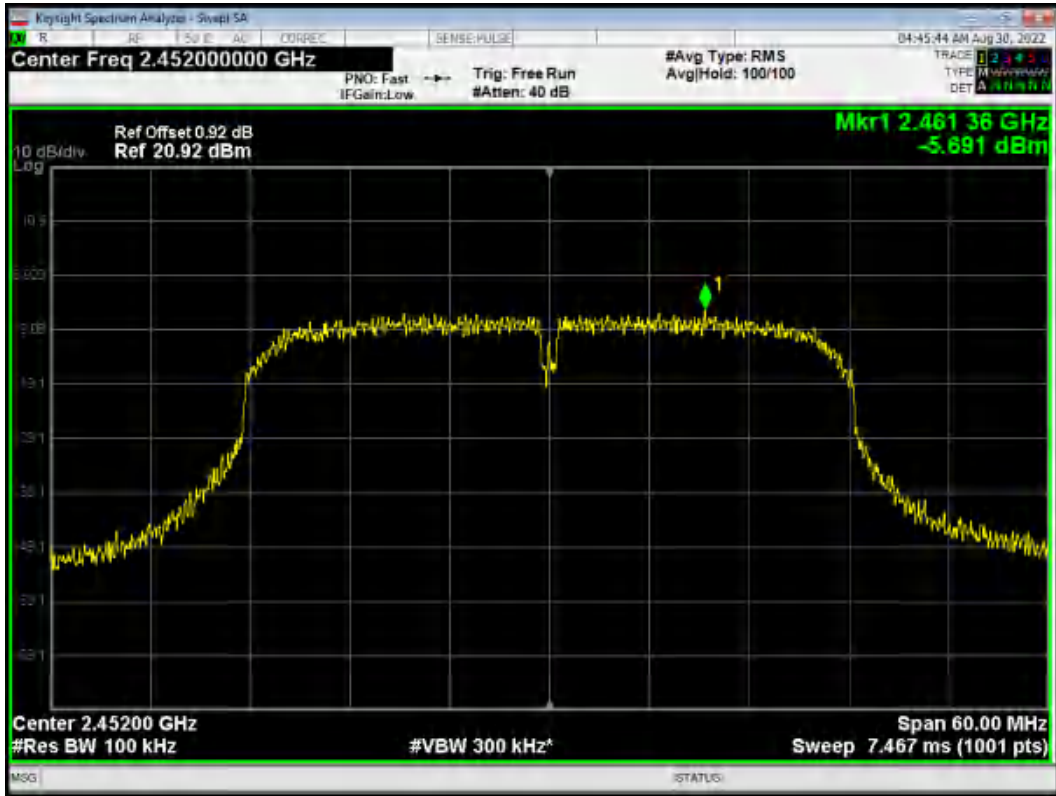

Tx. Spurious 802.11n(HT40) 2452MHz Emission

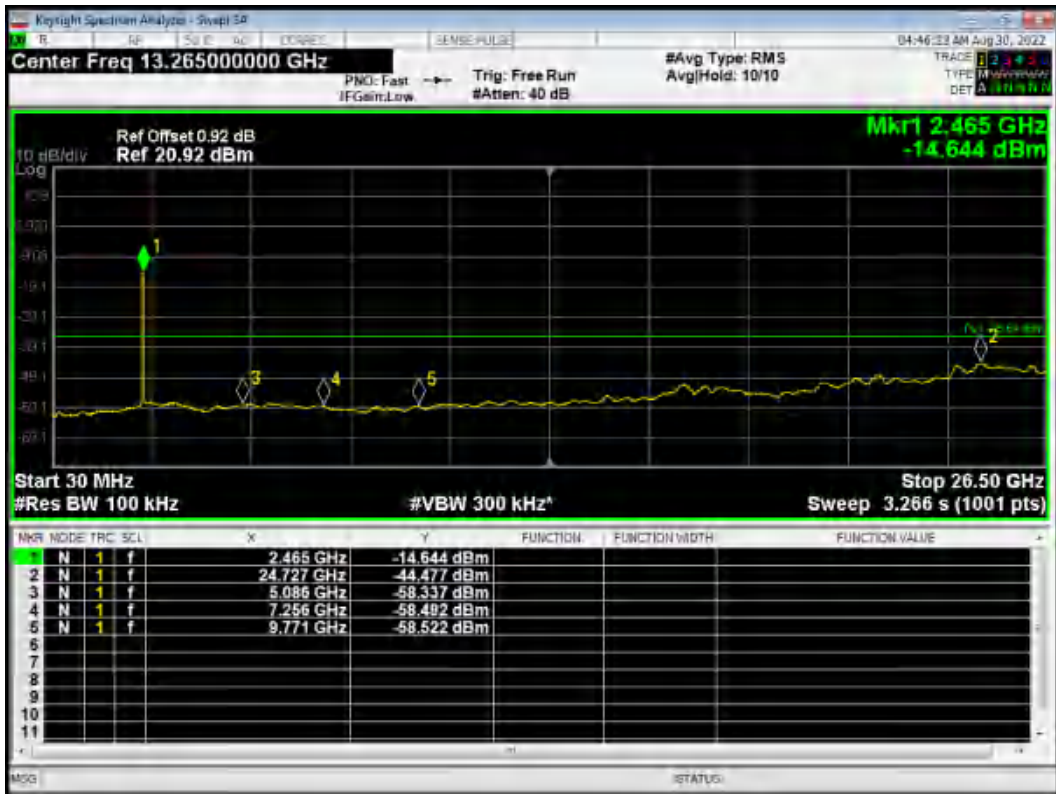



Tx. Spurious BLE 2402MHz Ref



Tx. Spurious BLE 2402MHz Emission

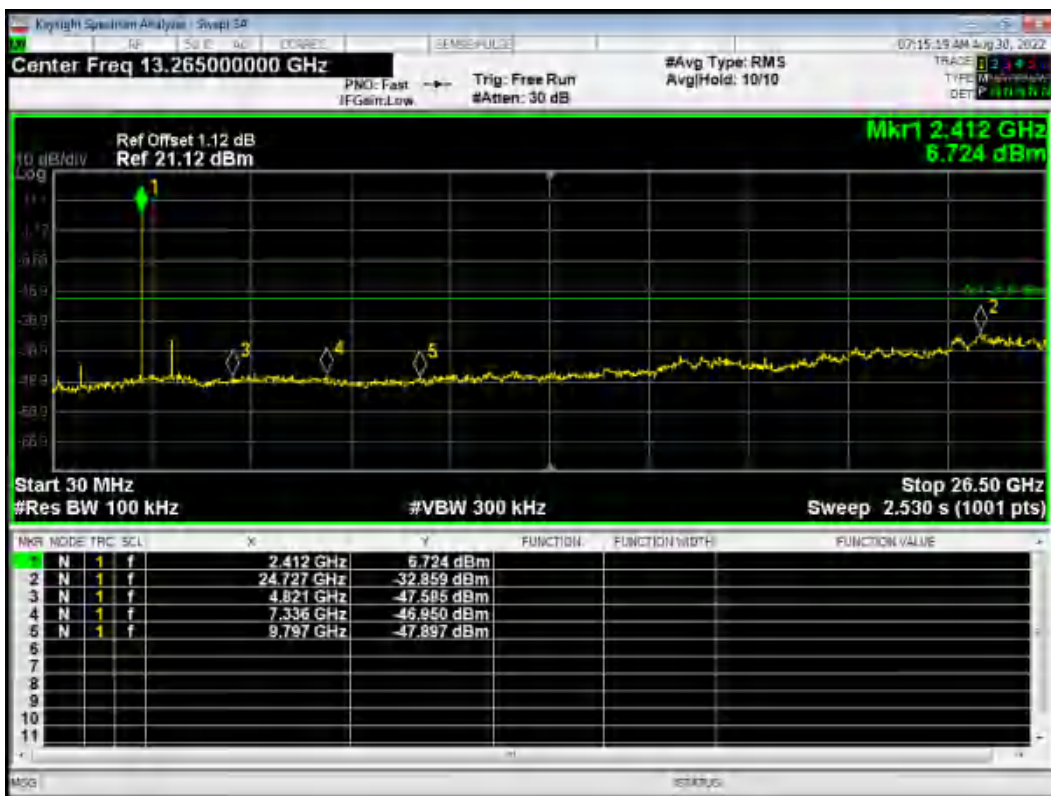



Tx. Spurious BLE 2440MHz Ref



Tx. Spurious BLE 2440MHz Emission

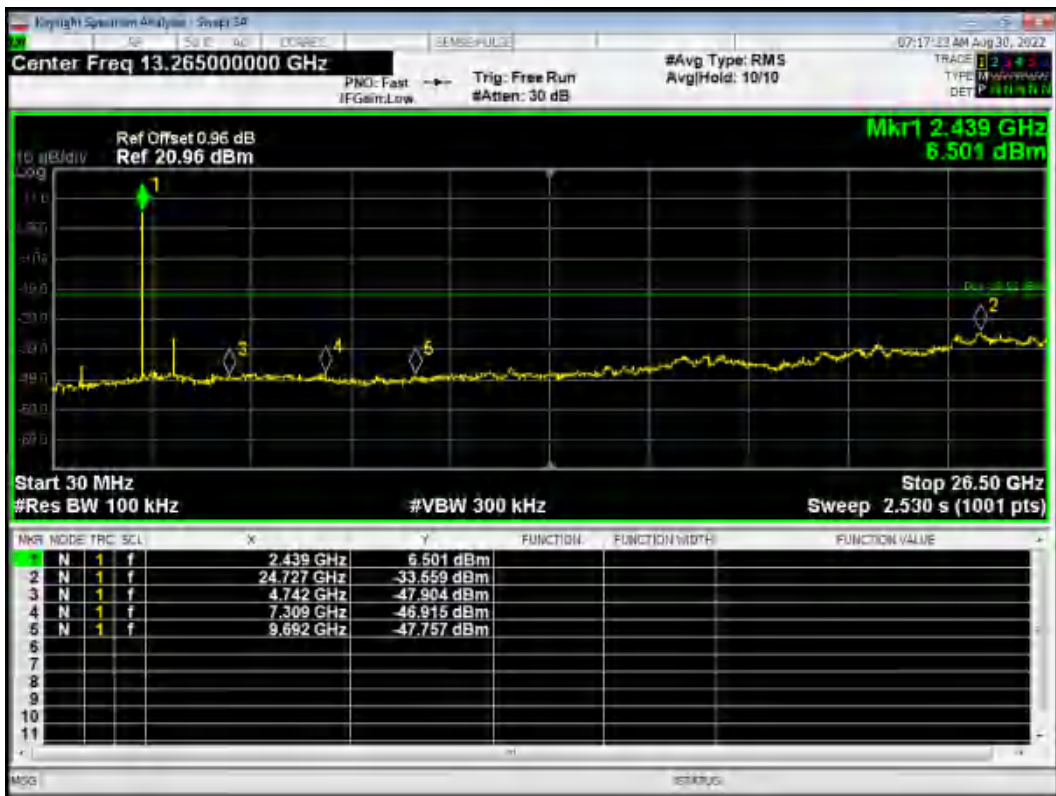



Tx. Spurious BLE 2480MHz Ref



Tx. Spurious BLE 2480MHz Emission

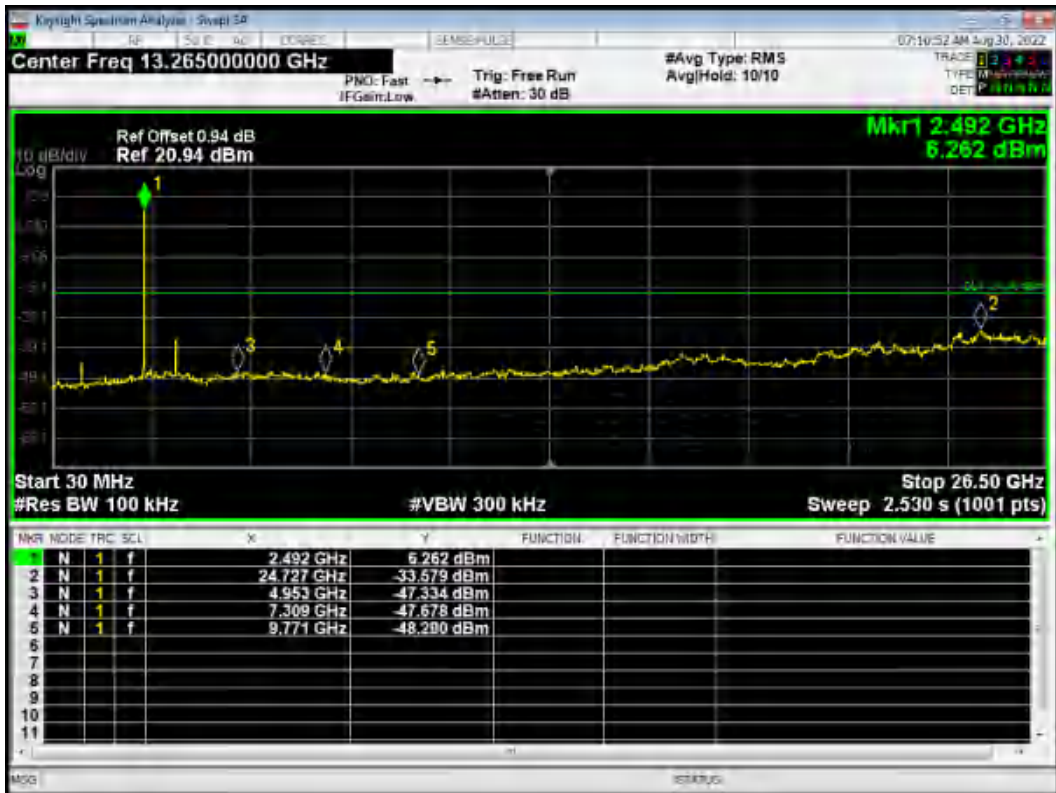



5.6. Unwanted Emission

Ambient condition

Temperature	Relative humidity	Pressure
23°C ~25°C	45%~50%	102.5kPa

Method of Measurement

The test set-up was made in accordance to the general provisions of ANSI C63.10.

The Equipment Under Test (EUT) was set up on a non-conductive table in the semi-anechoic chamber. The test was performed at the distance of 3 m between the EUT and the receiving antenna.

The turntable shall be rotated from 0 to 360 degrees for detecting the maximum of radiated spurious signal level. The measurements shall be repeated with orthogonal polarization of the test antenna. The data of cable loss and antenna factor has been calibrated in full testing frequency range before the testing. Sweep the Restricted Band and the emissions less than 20 dB below the permissible value are reported.

The radiated emissions measurements were made in a typical installation configuration.

Sweep the whole frequency band through the range from 9 kHz to the 10th harmonic of the carrier, and the emissions less than 20 dB below the permissible value are reported.

This method refer to ANSI C63.10.

The procedure for peak unwanted emissions measurements above 1000 MHz is as follows:

Set the spectrum analyzer in the following:

9kHz~150 kHz

RBW=200Hz, VBW=1kHz/ Sweep=AUTO

150 kHz~30MHz

RBW=9KHz, VBW=30KHz,/ Sweep=AUTO

Below 1GHz

RBW=100kHz / VBW=300kHz / Sweep=AUTO

a) Peak emission levels are measured by setting the instrument as follows:

Above 1GHz

PEAK: RBW=1MHz VBW=3MHz/ Sweep=AUTO

b) Average emission levels are measured by setting the instrument as follows:

Above 1GHz

AVERAGE: RBW=1MHz / VBW=3MHz / Sweep=AUTO

c) Detector: The measurements employing a CISPR quasi-peak detector except for the frequency bands 9-90 kHz, 110-490 kHz and above 1000 MHz. Radiated emission limits in these three bands are based on measurements employing an average detector.

d) Averaging type = power (i.e., rms) (As an alternative, the detector and averaging type may be set for linear voltage averaging. Some instruments require linear display mode to use linear voltage



averaging. Log or dB averaging shall not be used.)

e) Sweep time = auto.

f) Perform a trace average of at least 100 traces if the transmission is continuous. If the transmission is not continuous, then the number of traces shall be increased by a factor of $1 / D$, where D is the duty cycle. For example, with 50% duty cycle, at least 200 traces shall be averaged. (If a specific emission is demonstrated to be continuous—i.e., 100% duty cycle—then rather than turning ON and OFF with the transmit cycle, at least 100 traces shall be averaged.)

g) If tests are performed with the EUT transmitting at a duty cycle less than 98%, then a correction factor shall be added to the measurement results prior to comparing with the emission limit, to compute the emission level that would have been measured had the test been performed at 100% duty cycle. The correction factor is computed as follows:

1) If power averaging (rms) mode was used in the preceding step e), then the correction factor is $[10 \log (1 / D)]$, where D is the duty cycle. For example, if the transmit duty cycle was 50%, then 3 dB shall be added to the measured emission levels.

2) If linear voltage averaging mode was used in the preceding step e), then the correction factor is $[20 \log (1 / D)]$, where D is the duty cycle. For example, if the transmit duty cycle was 50%, then 6 dB shall be added to the measured emission levels.

3) If a specific emission is demonstrated to be continuous (100% duty cycle) rather than turning ON and OFF with the transmit cycle, then no duty cycle correction is required for that emission.

The test is in transmitting mode.

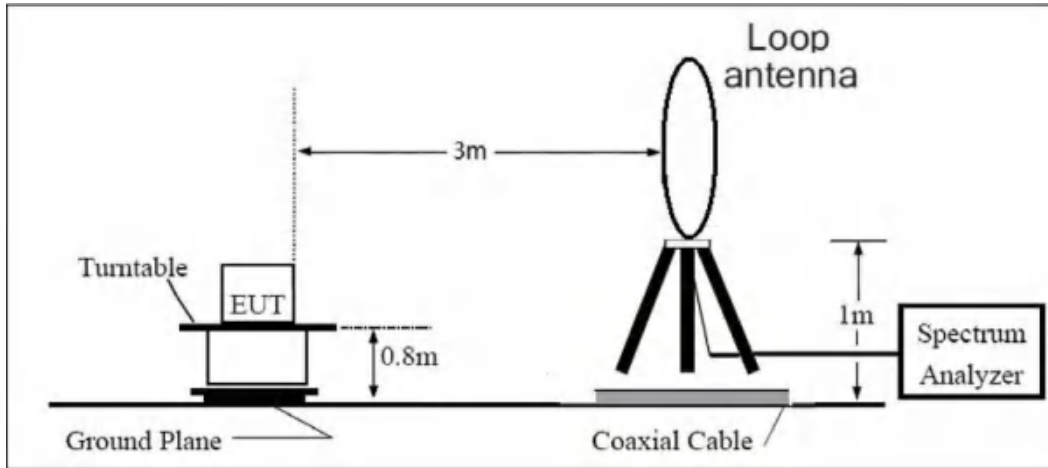
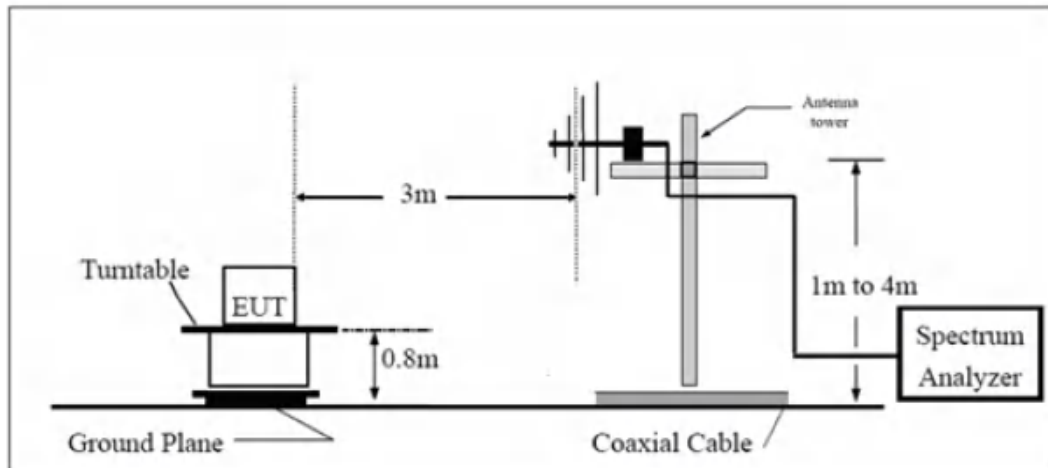
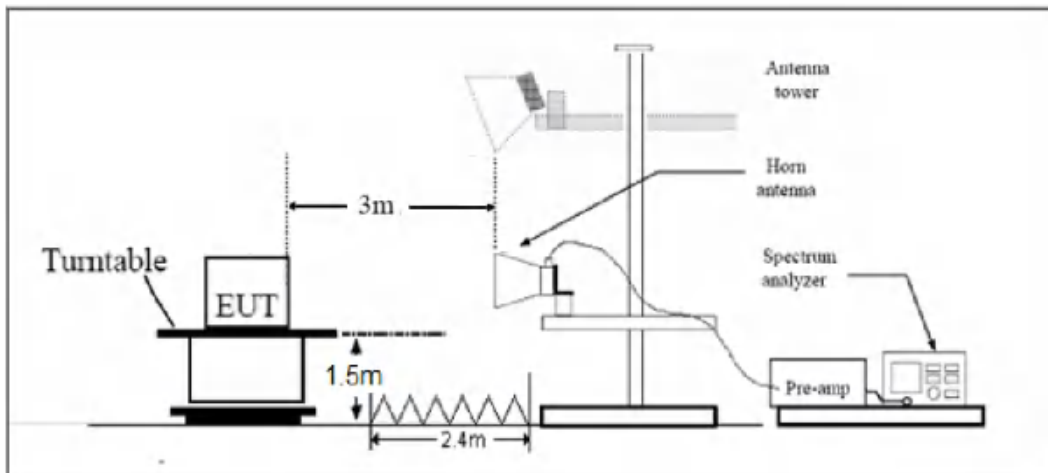
Test setup**9KHz~ 30MHz****30MHz~ 1GHz****Above 1GHz**

Note: Area side:2.4mX3.6m

**Limits**

Rule Part 15.247(d) specifies that “In addition, radiated emissions which fall in the restricted bands, as defined in § 15.205(a), must also comply with the radiated emission limits specified in § 15.209(a) (see § 15.205(c)).”

Limit in restricted band

Frequency of emission (MHz)	Field strength(uV/m)	Field strength(dBuV/m)
0.009–0.490	2400/F(kHz)	/
0.490–1.705	24000/F(kHz)	/
1.705–30.0	30	/
30-88	100	40
88-216	150	43.5
216-960	200	46
Above960	500	54

§15.35(b)

There is also a limit on the radio frequency emissions, as measured using instrumentation with a peak detector function, corresponding to 20 dB above the maximum permitted average limit.

Peak Limit=74 dBuV/m

Average Limit=54 dBuV/m



Spurious Radiated Emissions are permitted in any of the frequency bands listed below:

MHz	MHz	MHz	GHz
0.090-0.110	16.42-16.423	399.9-410	4.5-5.15
¹ 0.495-0.505	16.69475-16.69525	608-614	5.35-5.46
2.1735-2.1905	16.80425-16.80475	960-1240	7.25-7.75
4.125-4.128	25.5-25.67	1300-1427	8.025-8.5
4.17725-4.17775	37.5-38.25	1435-1626.5	9.0-9.2
4.20725-4.20775	73-74.6	1645.5-1646.5	9.3-9.5
6.215-6.218	74.8-75.2	1660-1710	10.6-12.7
6.26775-6.26825	108-121.94	1718.8-1722.2	13.25-13.4
6.31175-6.31225	123-138	2200-2300	14.47-14.5
8.291-8.294	149.9-150.05	2310-2390	15.35-16.2
8.362-8.366	156.52475-156.52525	2483.5-2500	17.7-21.4
8.37625-8.38675	156.7-156.9	2690-2900	22.01-23.12
8.41425-8.41475	162.0125-167.17	3260-3267	23.6-24.0
12.29-12.293	167.72-173.2	3332-3339	31.2-31.8
12.51975-12.52025	240-285	3345.8-3358	36.43-36.5
12.57675-12.57725	322-335.4	3600-4400	(²)
13.36-13.41			

Measurement Uncertainty

The assessed measurement uncertainty to ensure 95% confidence level for the normal distribution is with the coverage factor $k = 1.96$.

Frequency	Uncertainty
9KHz-30MHz	3.55 dB
30MHz-200MHz	4.17 dB
200MHz-1GHz	4.84 dB
1-18GHz	4.35 dB
18-26.5GHz	5.90 dB
26.5GHz~40GHz	5.92 dB



Test Results:

A symbol (dB μ V/m) in the test plot below means (dBuV/m)

A symbol (dB V/) in the test plot below means (dBuV/m)

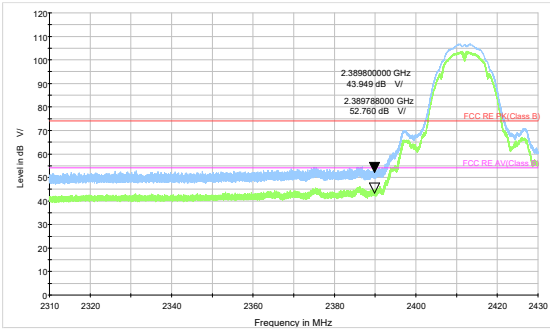

802.11b-Channel 1 Peak & Average

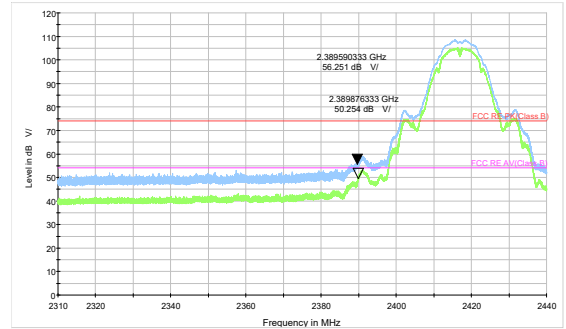

802.11b-Channel 2 Peak & Average

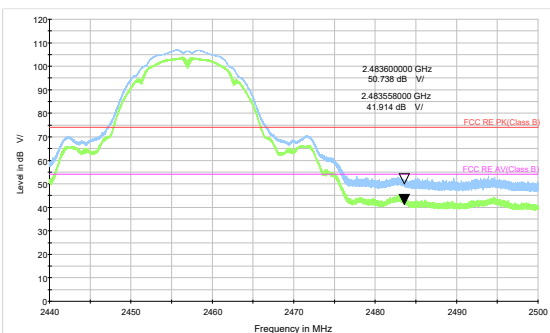

802.11b-Channel 10 Peak & Average

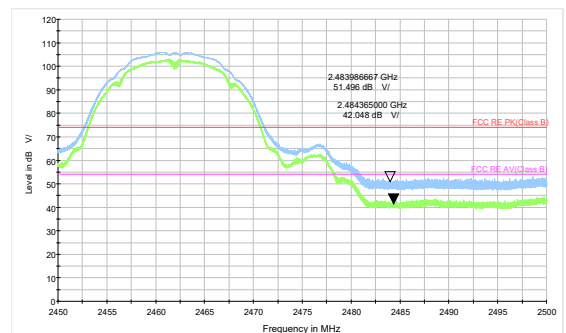

802.11b-Channel 11 Peak & Average

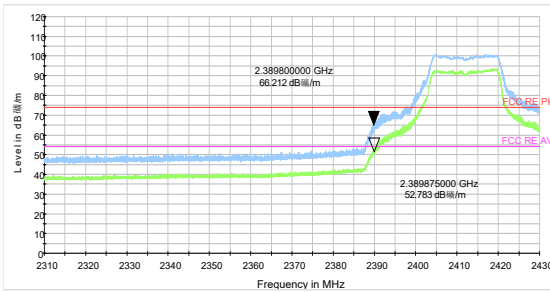

802.11g-Channel 1 Peak & Average

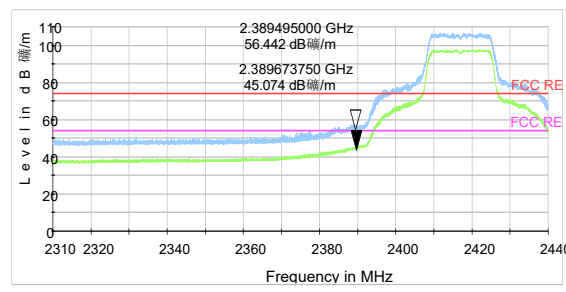

802.11g-Channel 2 Peak & Average

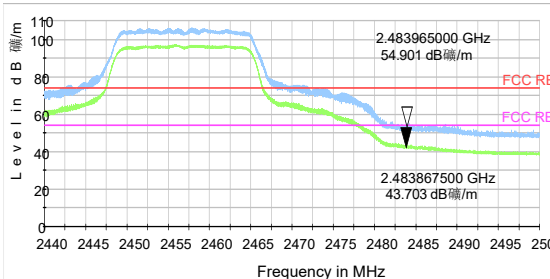

802.11g-Channel 10 Peak & Average

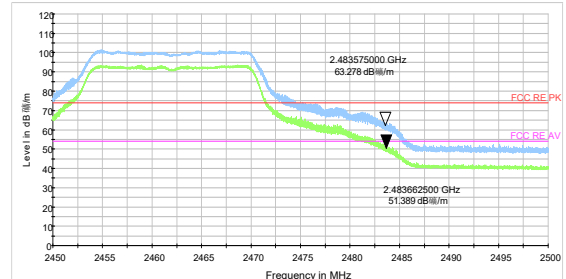

802.11g-Channel 11 Peak & Average

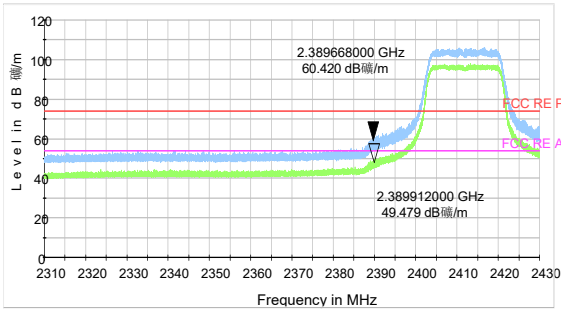

802.11n HT20 -Channel 1 Peak & Average

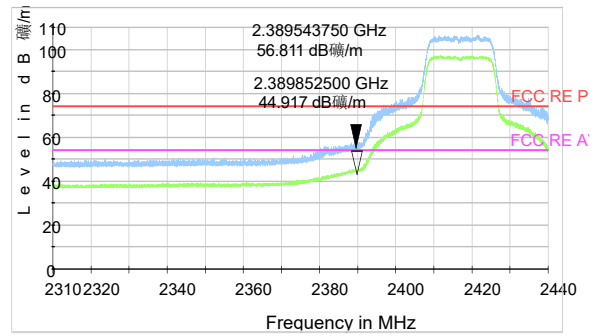

802.11n HT20 -Channel 2 Peak & Average

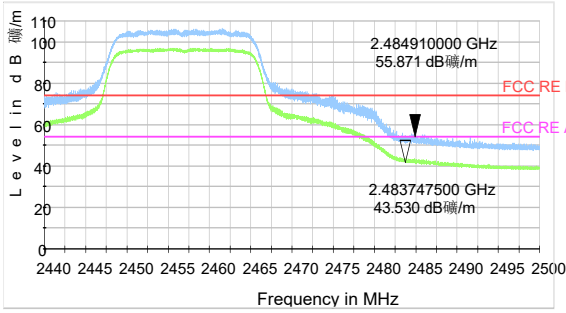

802.11n HT20 -Channel 10 Peak & Average

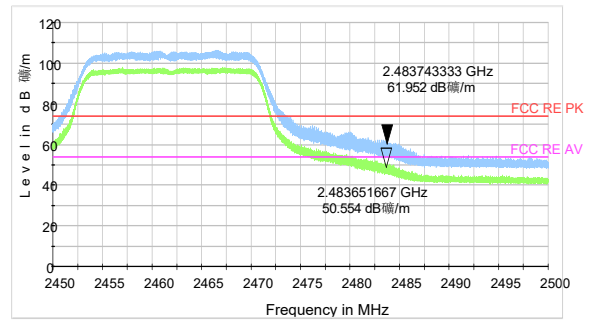

802.11n HT20 -Channel 11 Peak & Average

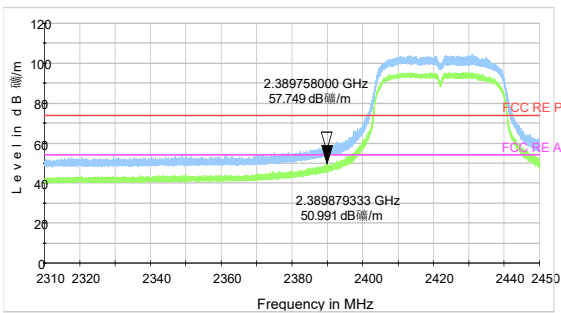

802.11n HT40 -Channel 3 Peak & Average

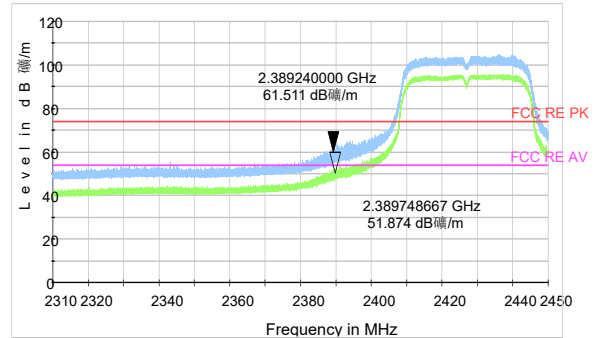

802.11n HT40 -Channel 4 Peak & Average

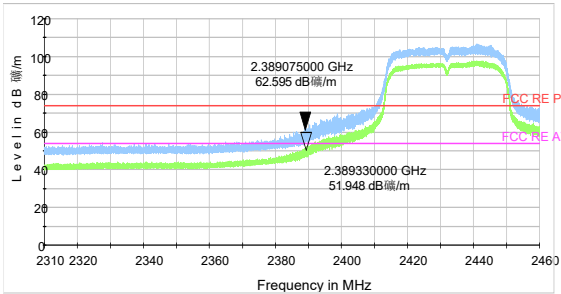

802.11n HT40 -Channel 5 Peak & Average

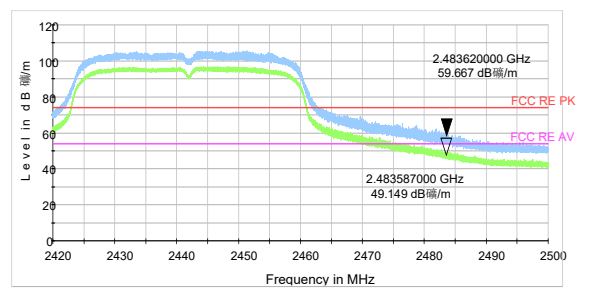

802.11n HT40 -Channel 7 Peak & Average

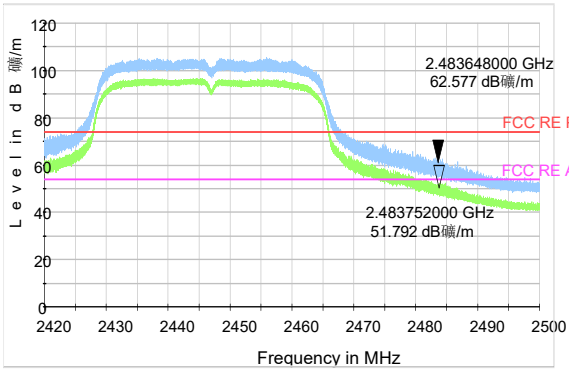

802.11n HT40 -Channel 8 Peak & Average

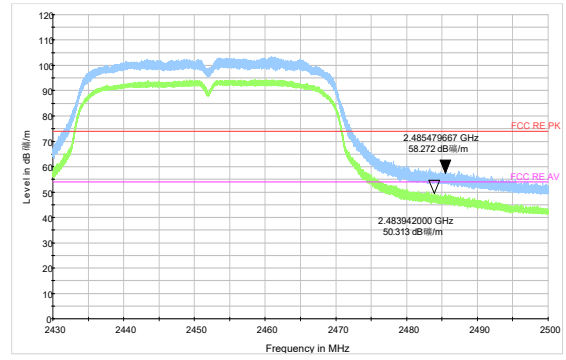

802.11n HT40 -Channel 9 Peak & Average

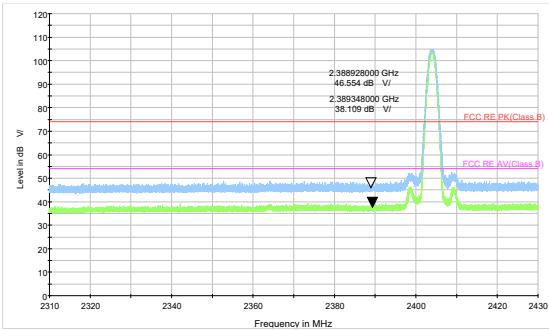

Bluetooth LE Channel 0 Peak & Average

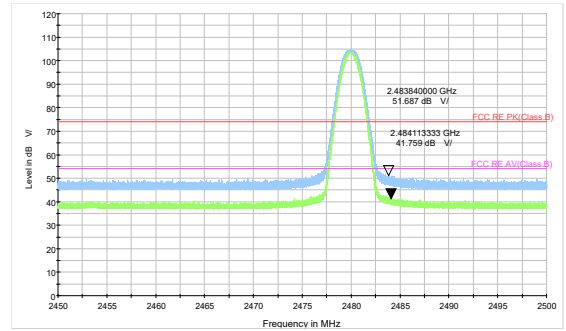

Bluetooth LE Channel 39 Peak & Average

**Result of RE****Test result**

Sweep the whole frequency band through the range from 9kHz to the 10th harmonic of the carrier, the Emissions in the frequency band 9kHz-30MHz and 18GHz-26.5GHz are more than 20dB below the limit are not reported.

The following graphs display the maximum values of horizontal and vertical by software.
For above 1GHz, Blue trace uses the peak detection, Green trace uses the average detection.

During the test, the Radiates Emission from 30MHz to 1GHz was performed in all modes with all channels, 802.11b CH11 are selected as the worst condition. The test data of the worst-case condition was recorded in this report.

A symbol (dB_{磁/m}) in the test plot below means (dBuV/m)

A symbol (dB_{μV/}) in the test plot below means (dBuV/m)

A symbol (dB _{V/}) in the test plot below means (dBuV/m)

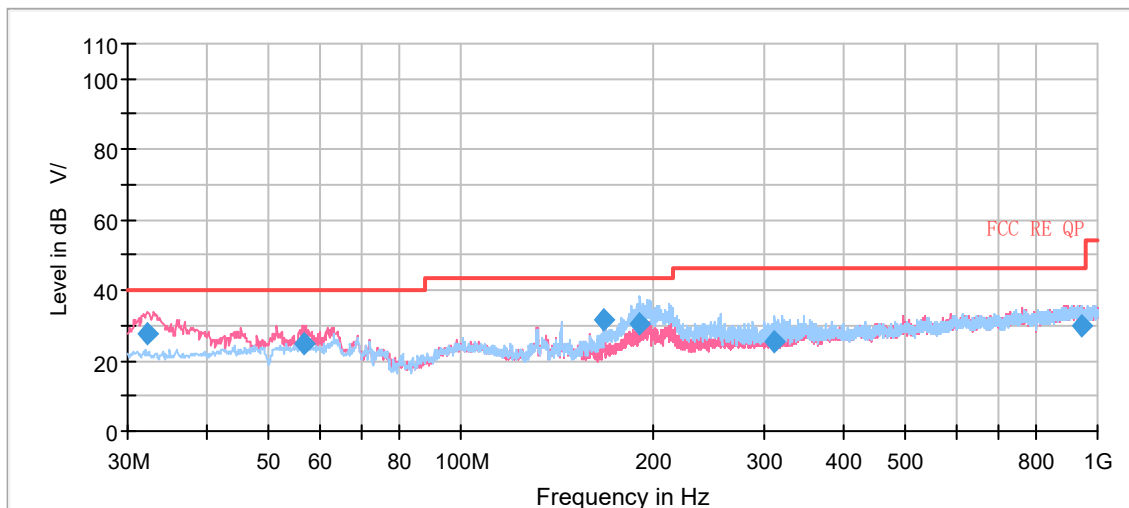
Continuous TX mode:

Radiates Emission from 30MHz to 1GHz

Frequency (MHz)	Quasi-Peak (dBuV/m)	Height (cm)	Polarization	Azimuth (deg)	Correct Factor (dB)	Margin (dB)	Limit (dBuV/m)
32.183750	27.91	100.0	V	307.0	-4.7	12.09	40.00
56.635000	24.99	210.0	V	165.0	-4.8	15.01	40.00
168.021250	31.49	184.0	H	71.0	-8.7	12.01	43.50
191.463750	30.54	100.0	H	250.0	-5.8	12.96	43.50
311.424500	25.52	100.0	H	260.0	-3.8	20.48	46.00
943.469250	29.71	125.0	H	167.0	6.0	16.29	46.00

Remark: 1. Correction Factor = Antenna factor+ Insertion loss(cable loss+amplifier gain)

2. Margin = Limit – Quasi-Peak



802.11b CH1

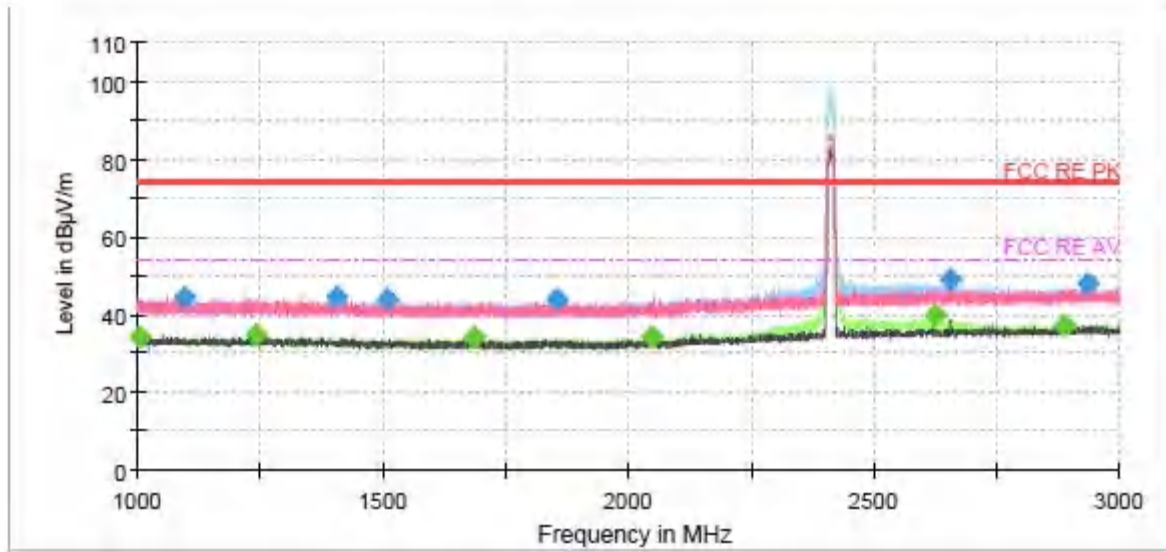

Note: The signal beyond the limit is carrier.

Radiates Emission from 1GHz to 3GHz

Frequency (MHz)	MaxPeak (dB μ V/m)	Average (dB μ V/m)	Limit (dB μ V/m)	Margin (dB)	Height (cm)	Pol	Azimuth (deg)	Corr. (dB/m)
1002.200000	---	34.43	54.00	19.57	100.0	H	350.0	-11.0
1093.200000	44.59	---	74.00	29.41	200.0	V	356.0	-10.7
1242.666667	---	34.56	54.00	19.44	100.0	V	111.0	-10.0
1404.066667	44.29	---	74.00	29.71	200.0	V	319.0	-9.5
1510.200000	44.15	---	74.00	29.85	100.0	H	322.0	-9.1
1687.466667	---	34.10	54.00	19.90	100.0	H	344.0	-8.7
1852.933333	44.24	---	74.00	29.76	100.0	H	344.0	-8.4
2045.533333	---	34.34	54.00	19.66	100.0	H	355.0	-8.0
2626.866667	---	39.90	54.00	14.10	100.0	H	304.0	-6.1
2655.533333	49.16	---	74.00	24.84	100.0	V	20.0	-6.1
2887.333333	---	37.27	54.00	16.73	100.0	H	334.0	-6.0
2937.466667	47.94	---	74.00	26.06	100.0	V	245.0	-5.9

Remark: 1. Correction Factor = Antenna factor+ Insertion loss (cable loss + amplifier gain)

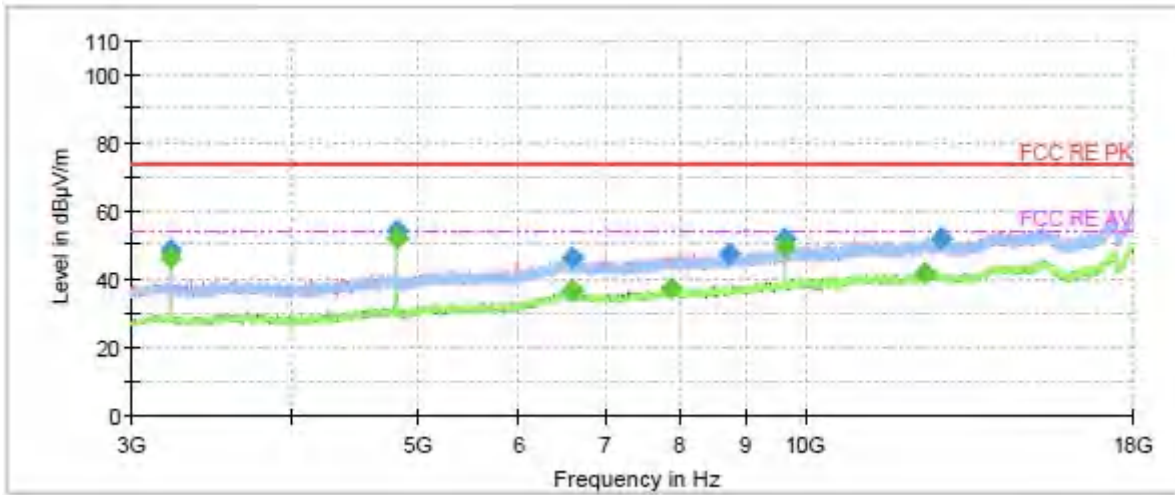

Radiates Emission from 3GHz to 18GHz

Frequency (MHz)	MaxPeak (dB µ V/m)	Average (dB µ V/m)	Limit (dB µ V/m)	Margin (dB)	Height (cm)	Pol	Azimuth (deg)	Corr. (dB/m)
3215.500000	48.53	---	74.00	25.47	200.0	V	59.0	-15.1
3215.500000	---	46.54	54.00	7.46	200.0	V	59.0	-15.1
4823.500000	54.16	---	74.00	19.84	200.0	V	12.0	-10.7
4824.000000	---	51.84	54.00	2.16	200.0	V	12.0	-10.7
6599.500000	46.18	---	74.00	27.82	200.0	V	161.0	-3.6
6612.500000	---	36.59	54.00	17.41	100.0	H	353.0	-3.6
7892.000000	---	37.33	54.00	16.67	100.0	V	302.0	-3.0
8733.500000	47.44	---	74.00	26.56	100.0	V	0.0	-3.4
9647.500000	51.77	---	74.00	22.23	100.0	H	188.0	-2.3
9648.000000	---	49.62	54.00	4.38	100.0	H	188.0	-2.3
12410.000000	---	41.94	54.00	12.06	200.0	V	273.0	1.6
12790.000000	52.04	---	74.00	21.96	200.0	H	2.0	2.1

Remark: 1. Correction Factor = Antenna factor+ Insertion loss (cable loss + amplifier gain)

802.11b CH6

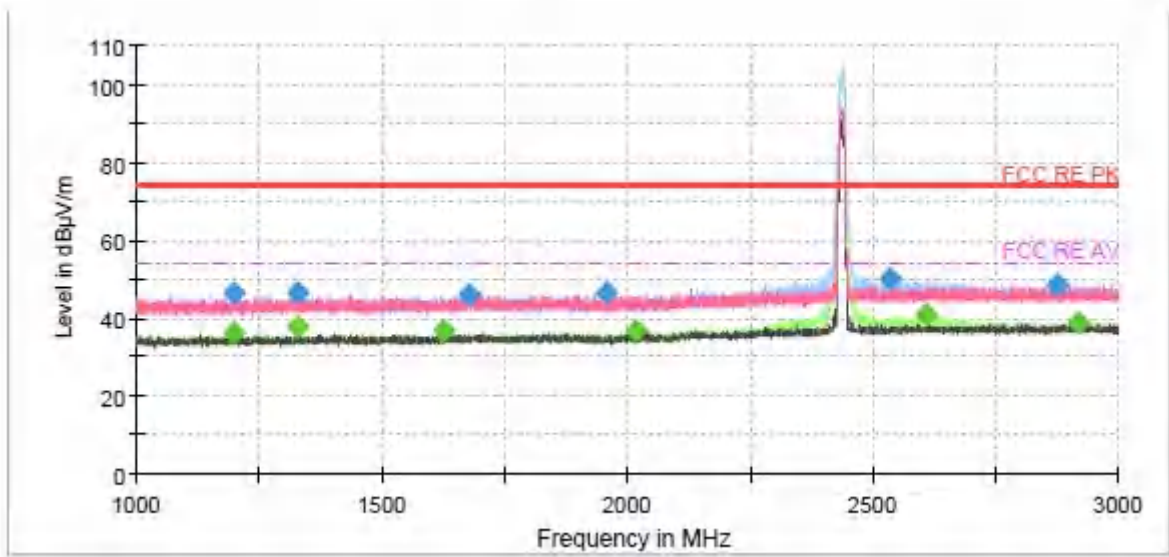

Note: The signal beyond the limit is carrier.
Radiates Emission from 1GHz to 3GHz

Frequency (MHz)	MaxPeak (dB µ V/m)	Average (dB µ V/m)	Limit (dB µ V/m)	Margin (dB)	Height (cm)	Pol	Azimuth (deg)	Corr. (dB/m)
1198.733333	46.49	---	74.00	27.51	200.0	V	86.0	-10.3
1199.400000	---	36.16	54.00	17.84	200.0	V	86.0	-10.3
1327.533333	---	37.81	54.00	16.19	100.0	V	2.0	-9.7
1329.666667	46.56	---	74.00	27.44	100.0	V	352.0	-9.7
1624.533333	---	36.75	54.00	17.25	100.0	H	57.0	-8.8
1678.200000	46.16	---	74.00	27.84	100.0	H	168.0	-8.7
1958.400000	46.48	---	74.00	27.52	200.0	H	1.0	-8.4
2017.466667	---	36.78	54.00	17.22	100.0	H	210.0	-8.2
2534.933333	50.00	---	74.00	24.00	100.0	H	182.0	-6.3
2608.266667	---	40.81	54.00	13.19	100.0	H	57.0	-6.1
2874.600000	48.61	---	74.00	25.39	200.0	H	93.0	-6.0
2919.733333	---	38.70	54.00	15.30	100.0	H	210.0	-6.0

Remark: 1. Correction Factor = Antenna factor+ Insertion loss (cable loss + amplifier gain)

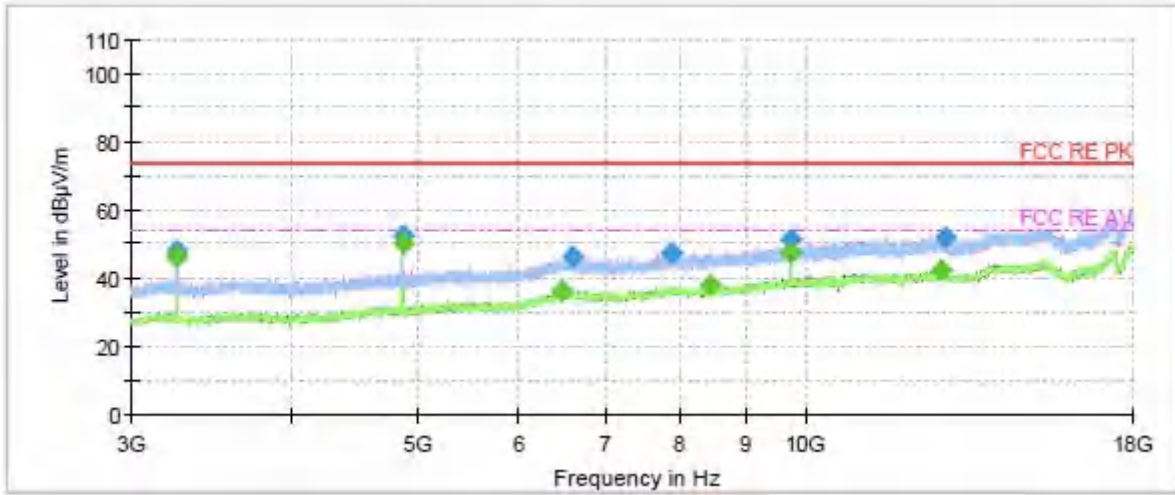

Radiates Emission from 3GHz to 18GHz

Frequency (MHz)	MaxPeak (dB µ V/m)	Average (dB µ V/m)	Limit (dB µ V/m)	Margin (dB)	Height (cm)	Pol	Azimuth (deg)	Corr. (dB/m)
3249.000000	47.87	---	74.00	26.13	200.0	H	4.0	-15.2
3249.000000	---	46.17	54.00	7.83	100.0	V	68.0	-15.2
4874.000000	52.29	---	74.00	21.71	100.0	H	302.0	-10.7
4874.000000	---	49.98	54.00	4.02	100.0	H	302.0	-10.7
6477.000000	---	36.07	54.00	17.93	200.0	V	58.0	-3.9
6592.500000	46.05	---	74.00	27.95	100.0	H	358.0	-3.6
7892.000000	47.37	---	74.00	26.63	100.0	V	3.0	-3.0
8454.500000	---	37.96	54.00	16.04	200.0	V	328.0	-3.3
9748.000000	---	47.12	54.00	6.88	100.0	V	68.0	-2.4
9748.000000	51.06	---	74.00	22.94	100.0	H	190.0	-2.4
12795.500000	---	42.03	54.00	11.97	100.0	V	97.0	2.1
12882.500000	51.65	---	74.00	22.35	200.0	H	184.0	1.9

Remark: 1. Correction Factor = Antenna factor+ Insertion loss (cable loss + amplifier gain)

802.11b CH11

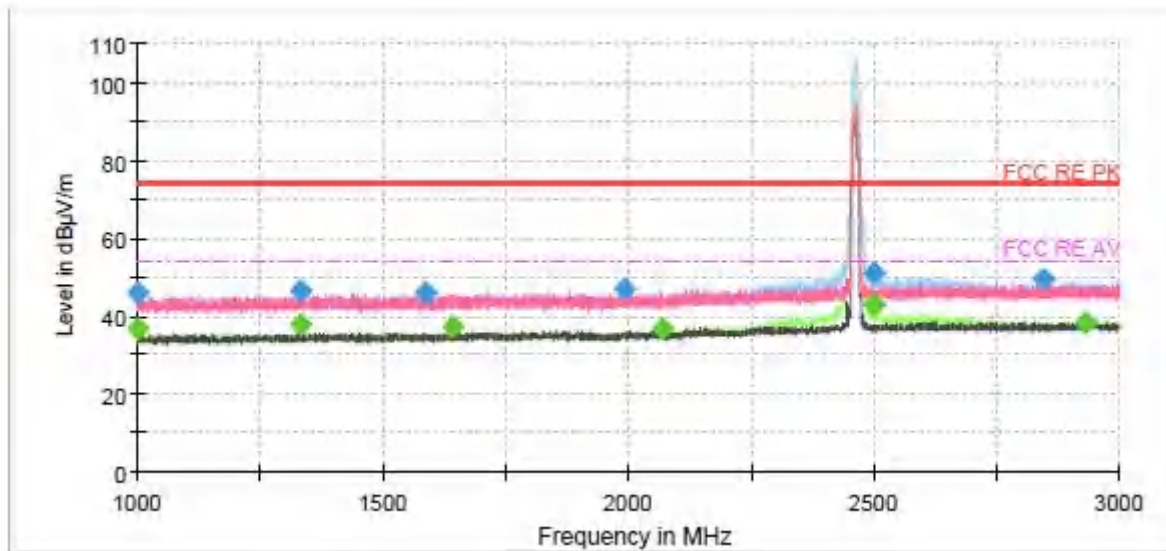

Note: The signal beyond the limit is carrier.

Radiates Emission from 1GHz to 3GHz

Frequency (MHz)	MaxPeak (dB µ V/m)	Average (dB µ V/m)	Limit (dB µ V/m)	Margin (dB)	Height (cm)	Pol	Azimuth (deg)	Corr. (dB/m)
1000.600000	46.00	---	74.00	28.00	200.0	V	8.0	-11.1
1000.600000	---	36.65	54.00	17.35	200.0	V	8.0	-11.1
1331.333333	---	37.78	54.00	16.22	200.0	V	5.0	-9.7
1331.533333	46.46	---	74.00	27.54	100.0	H	58.0	-9.7
1588.333333	46.21	---	74.00	27.79	200.0	H	109.0	-8.9
1641.333333	---	37.56	54.00	16.44	100.0	H	31.0	-8.7
1993.066667	46.95	---	74.00	27.05	100.0	V	309.0	-8.2
2069.533333	---	36.95	54.00	17.05	100.0	V	0.0	-7.9
2500.200000	---	43.03	54.00	10.97	100.0	H	7.0	-6.3
2500.200000	51.33	---	74.00	22.67	100.0	H	7.0	-6.3
2845.466667	49.45	---	74.00	24.55	100.0	H	71.0	-6.1
2929.866667	---	38.46	54.00	15.54	100.0	H	129.0	-6.0

Remark: 1. Correction Factor = Antenna factor+ Insertion loss (cable loss + amplifier gain)

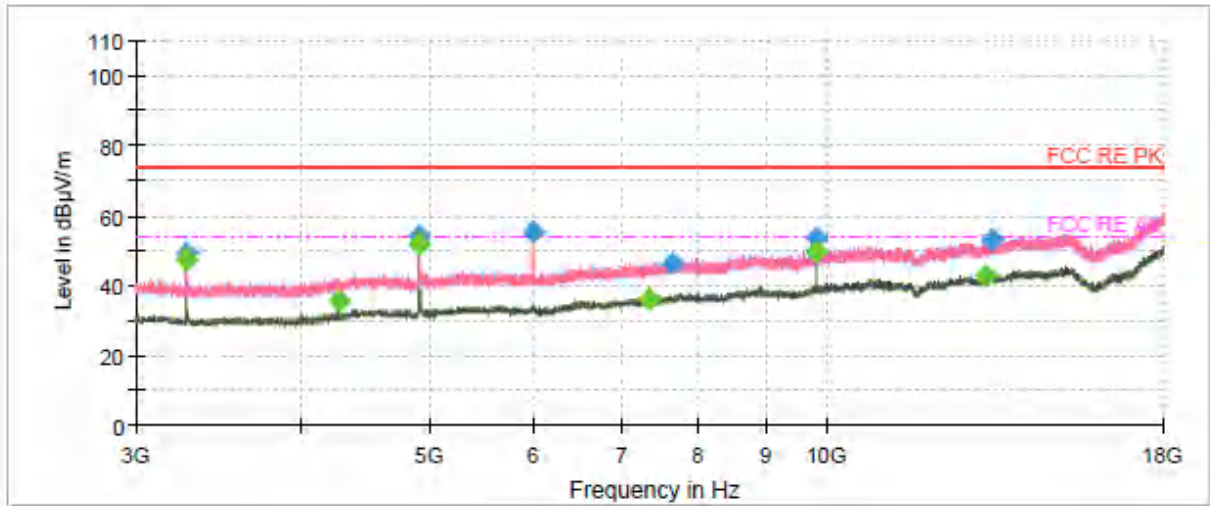

Radiates Emission from 3GHz to 18GHz

Frequency (MHz)	MaxPeak (dB µ V/m)	Average (dB µ V/m)	Limit (dB µ V/m)	Margin (dB)	Height (cm)	Pol	Azimuth (deg)	Corr. (dB/m)
3282.500000	---	47.31	54.00	6.69	200.0	V	24.0	-13
3282.500000	49.24	---	74.00	24.76	200.0	V	24.0	-13
4280.500000	---	35.31	54.00	18.69	200.0	V	206.0	-10
4923.500000	---	51.93	54.00	2.07	200.0	H	59.0	-8
4924.000000	54.38	---	74.00	19.62	200.0	H	59.0	-8
5990.000000	55.15	---	74.00	18.85	100.0	V	254.0	-5
7348.000000	---	36.35	54.00	17.65	100.0	V	265.0	-3
7666.500000	46.36	---	74.00	27.64	100.0	V	308.0	-3
9848.000000	53.67	---	74.00	20.33	100.0	V	356.0	-1
9848.000000	---	49.91	54.00	4.09	100.0	V	356.0	-1
13203.000000	---	42.86	54.00	11.14	200.0	V	195.0	3
13342.000000	53.15	---	74.00	20.85	200.0	H	205.0	3

Remark: 1. Correction Factor = Antenna factor+ Insertion loss (cable loss + amplifier gain)



802.11g CH1

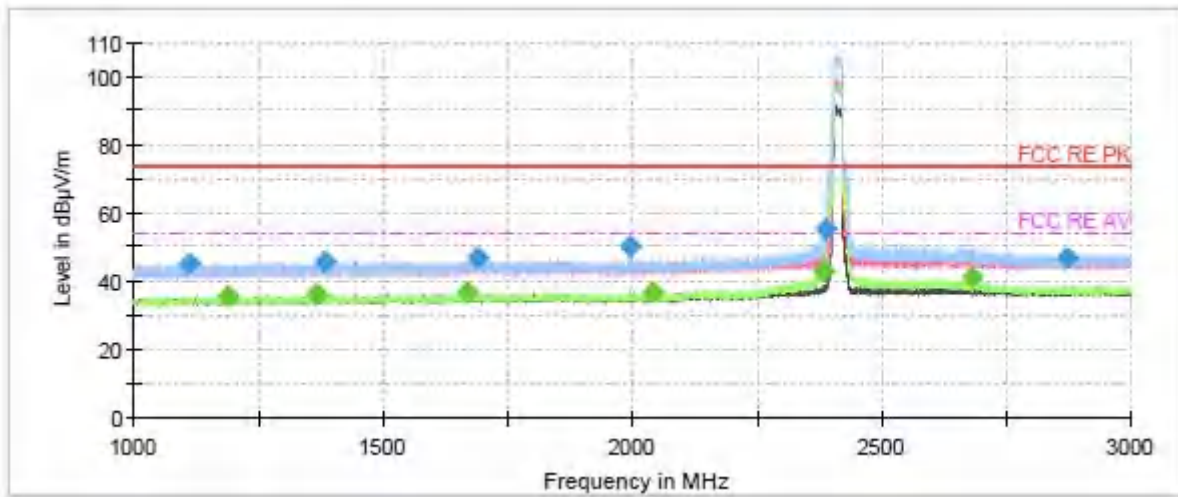

Note: The signal beyond the limit is carrier.

Radiates Emission from 1GHz to 3GHz

Frequency (MHz)	MaxPeak (dB µ V/m)	Average (dB µ V/m)	Limit (dB µ V/m)	Margin (dB)	Height (cm)	Pol	Azimuth (deg)	Corr. (dB/m)
1112.733333	45.28	---	74.00	28.72	200.0	H	25.0	-10.6
1189.400000	---	35.64	54.00	18.36	200.0	V	209.0	-10.4
1367.133333	---	36.17	54.00	17.83	100.0	V	194.0	-9.6
1383.800000	45.88	---	74.00	28.12	100.0	V	129.0	-9.6
1670.733333	---	36.47	54.00	17.53	200.0	H	140.0	-8.8
1691.600000	46.68	---	74.00	27.32	200.0	H	4.0	-8.6
1993.866667	50.46	---	74.00	23.54	200.0	H	127.0	-8.2
2039.666667	---	36.81	54.00	17.19	200.0	H	17.0	-8.0
2384.066667	---	43.08	54.00	10.92	100.0	H	201.0	-6.5
2386.800000	55.15	---	74.00	18.85	200.0	H	219.0	-6.5
2682.733333	---	41.42	54.00	12.58	200.0	H	219.0	-6.0
2870.866667	46.91	---	74.00	27.09	200.0	H	127.0	-6.0

Remark: 1. Correction Factor = Antenna factor+ Insertion loss (cable loss + amplifier gain)

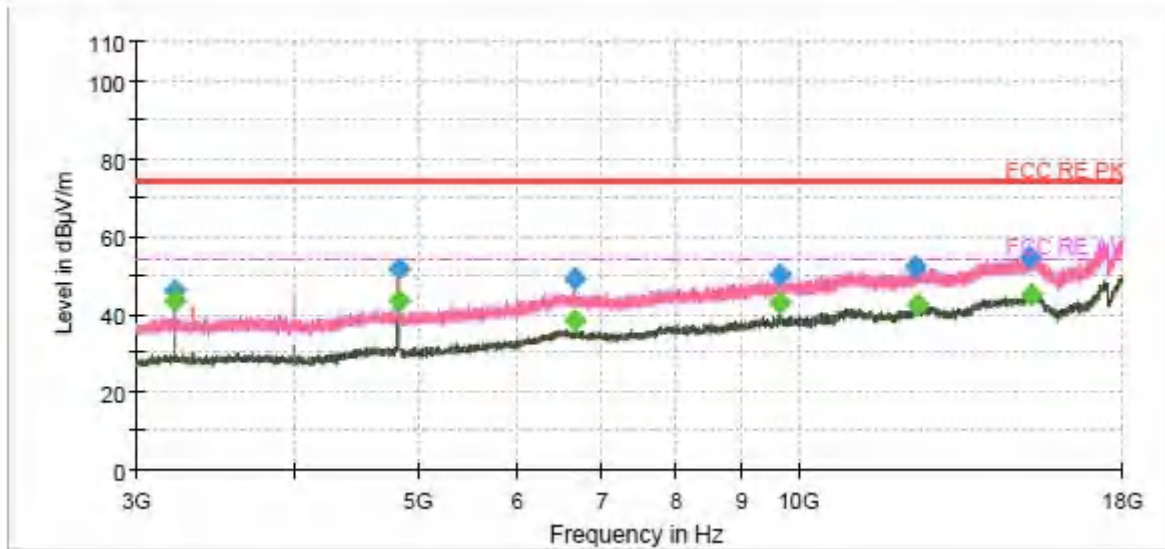

Radiates Emission from 3GHz to 18GHz

Frequency (MHz)	MaxPeak (dB µ V/m)	Average (dB µ V/m)	Limit (dB µ V/m)	Margin (dB)	Height (cm)	Pol	Azimuth (deg)	Corr. (dB/m)
3215.500000	46.30	---	74.00	27.70	200.0	V	259.0	-15.1
3215.500000	---	43.53	54.00	10.47	200.0	V	259.0	-15.1
4826.500000	51.54	---	74.00	22.46	200.0	V	12.0	-10.7
4828.000000	---	43.62	54.00	10.38	200.0	V	12.0	-10.7
6638.500000	49.36	---	74.00	24.64	100.0	V	330.0	-3.5
6640.500000	---	38.56	54.00	15.44	100.0	V	330.0	-3.5
9647.500000	---	43.08	54.00	10.92	100.0	V	17.0	-2.3
9648.000000	49.90	---	74.00	24.10	100.0	V	250.0	-2.3
12358.000000	51.96	---	74.00	22.04	100.0	H	0.0	1.4
12384.500000	---	42.48	54.00	11.52	100.0	V	0.0	1.5
15190.000000	54.84	---	74.00	19.16	100.0	H	152.0	5.2
15239.500000	---	44.87	54.00	9.13	100.0	H	286.0	5.4

Remark: 1. Correction Factor = Antenna factor+ Insertion loss (cable loss + amplifier gain)

802.11g CH6

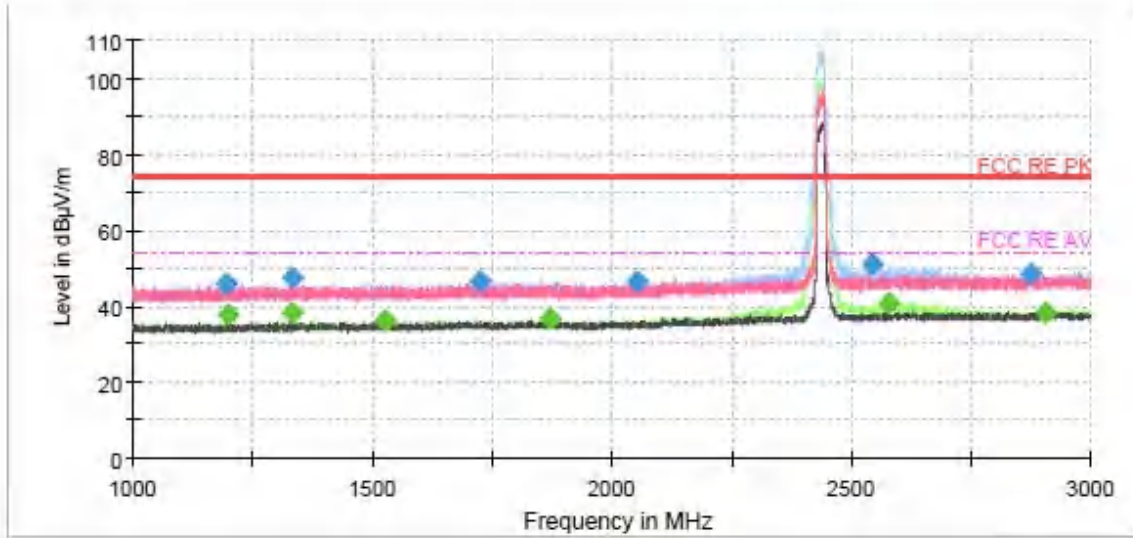

Note: The signal beyond the limit is carrier.
Radiates Emission from 1GHz to 3GHz

Frequency (MHz)	MaxPeak (dB µ V/m)	Average (dB µ V/m)	Limit (dB µ V/m)	Margin (dB)	Height (cm)	Pol	Azimuth (deg)	Corr. (dB/m)
1195.200000	46.17	---	74.00	27.83	100.0	V	203.0	-10.3
1197.333333	---	37.79	54.00	16.21	200.0	H	272.0	-10.3
1333.200000	47.53	---	74.00	26.47	200.0	V	2.0	-9.7
1333.200000	---	38.28	54.00	15.72	200.0	V	2.0	-9.7
1524.400000	---	36.55	54.00	17.45	100.0	H	350.0	-9.0
1724.600000	46.69	---	74.00	27.31	100.0	V	203.0	-8.6
1869.000000	---	36.88	54.00	17.12	200.0	H	312.0	-8.4
2049.800000	46.48	---	74.00	27.52	200.0	H	345.0	-8.0
2543.066667	51.05	---	74.00	22.95	200.0	H	177.0	-6.2
2578.666667	---	41.07	54.00	12.93	100.0	H	66.0	-6.1
2873.400000	48.46	---	74.00	25.54	200.0	V	6.0	-6.0
2905.733333	---	38.42	54.00	15.58	200.0	H	299.0	-6.1

Remark: 1. Correction Factor = Antenna factor+ Insertion loss (cable loss + amplifier gain)

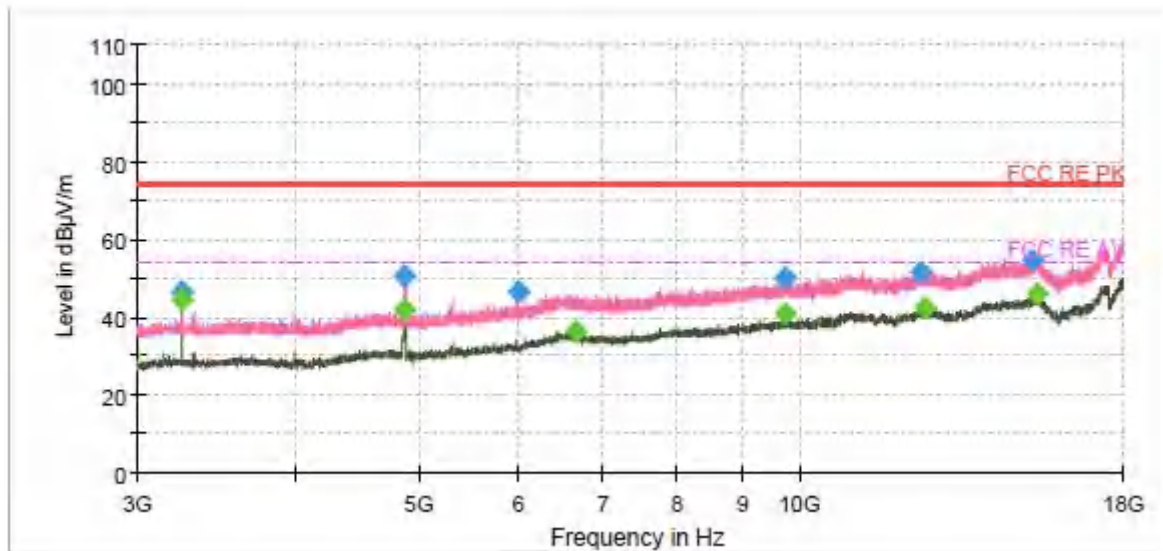

Radiates Emission from 3GHz to 18GHz

Frequency (MHz)	MaxPeak (dB µ V/m)	Average (dB µ V/m)	Limit (dB µ V/m)	Margin (dB)	Height (cm)	Pol	Azimuth (deg)	Corr. (dB/m)
3249.500000	46.33	---	74.00	27.67	100.0	H	278.0	-15.7
3249.000000	---	44.52	54.00	9.48	200.0	V	0.0	-15.2
4874.000000	---	42.16	54.00	11.84	200.0	H	330.0	-10.7
4875.500000	50.60	---	74.00	23.40	200.0	V	12.0	-10.7
5989.000000	46.47	---	74.00	27.53	100.0	V	8.0	-7.0
6656.000000	---	36.16	54.00	17.84	100.0	V	348.0	-3.5
9739.000000	50.00	---	74.00	24.00	100.0	V	15.0	-2.4
9743.000000	---	41.11	54.00	12.89	100.0	V	24.0	-2.4
12433.000000	51.67	---	74.00	22.33	100.0	V	2.0	1.6
12529.500000	---	42.43	54.00	11.57	200.0	V	185.0	2.0
15231.000000	54.57	---	74.00	19.43	200.0	H	0.0	5.4
15358.000000	---	45.94	54.00	8.06	100.0	V	70.0	5.8

Remark: 1. Correction Factor = Antenna factor+ Insertion loss (cable loss + amplifier gain)



802.11g CH11

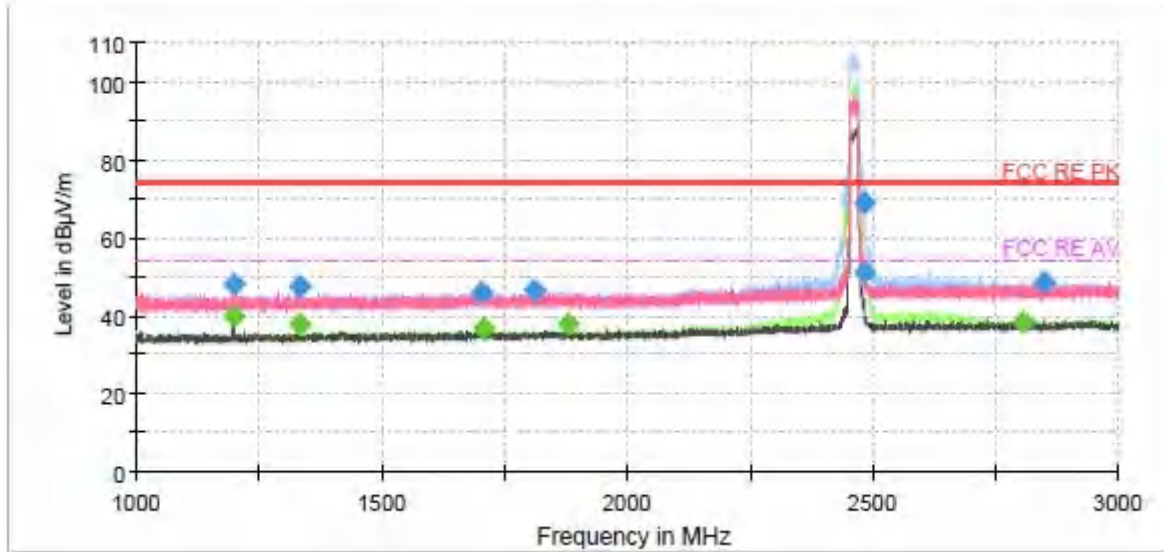

Note: The signal beyond the limit is carrier.

Radiates Emission from 1GHz to 3GHz

Frequency (MHz)	MaxPeak (dB μ V/m)	Average (dB μ V/m)	Limit (dB μ V/m)	Margin (dB)	Height (cm)	Pol	Azimuth (deg)	Corr. (dB/m)
1199.133333	48.32	---	74.00	25.68	100.0	V	351.0	-10.3
1199.600000	---	39.79	54.00	14.21	100.0	V	351.0	-10.3
1332.400000	47.81	---	74.00	26.19	200.0	V	0.0	-9.7
1332.400000	---	38.11	54.00	15.90	200.0	V	0.0	-9.7
1701.533333	46.16	---	74.00	27.84	100.0	H	2.0	-8.6
1704.800000	---	36.79	54.00	17.21	100.0	H	13.0	-8.6
1808.200000	46.65	---	74.00	27.35	200.0	H	235.0	-8.5
1880.400000	---	37.87	54.00	16.13	100.0	H	196.0	-8.4
2483.666667	51.04	---	74.00	22.96	200.0	V	286.0	-6.3
2483.933333	68.88	---	74.00	5.12	100.0	H	46.0	-6.3
2804.333333	---	38.30	54.00	15.70	200.0	H	316.0	-6.0
2849.733333	48.61	---	74.00	25.39	200.0	H	249.0	-6.1

Remark: 1. Correction Factor = Antenna factor+ Insertion loss (cable loss + amplifier gain)

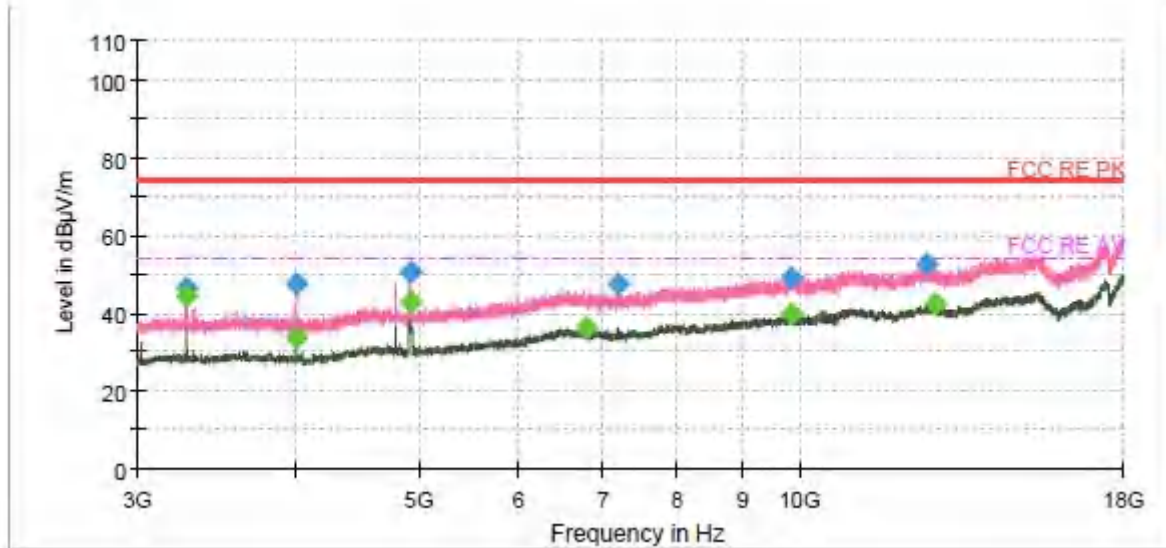

Radiates Emission from 3GHz to 18GHz

Frequency (MHz)	MaxPeak (dB µ V/m)	Average (dB µ V/m)	Limit (dB µ V/m)	Margin (dB)	Height (cm)	Pol	Azimuth (deg)	Corr. (dB/m)
3282.500000	46.47	---	74.00	27.53	200.0	V	359.0	-15.0
3282.500000	---	44.68	54.00	9.32	200.0	V	359.0	-15.0
3999.500000	47.42	---	74.00	26.58	200.0	V	31.0	-13.3
3999.500000	---	33.89	54.00	20.11	200.0	V	31.0	-13.3
4921.500000	---	42.79	54.00	11.21	100.0	H	29.0	-10.6
4922.000000	50.87	---	74.00	23.13	200.0	H	40.0	-10.6
6765.500000	---	36.28	54.00	17.72	200.0	V	111.0	-3.7
7180.000000	47.46	---	74.00	26.54	100.0	V	2.0	-4.4
9848.000000	---	39.92	54.00	14.08	100.0	V	70.0	-1.8
9854.000000	49.32	---	74.00	24.68	200.0	H	5.0	-1.8
12587.500000	52.59	---	74.00	21.41	100.0	V	114.0	2.2
12778.000000	---	42.25	54.00	11.75	200.0	V	14.0	2.2

Remark: 1. Correction Factor = Antenna factor+ Insertion loss (cable loss + amplifier gain)



802.11n (HT20) CH1

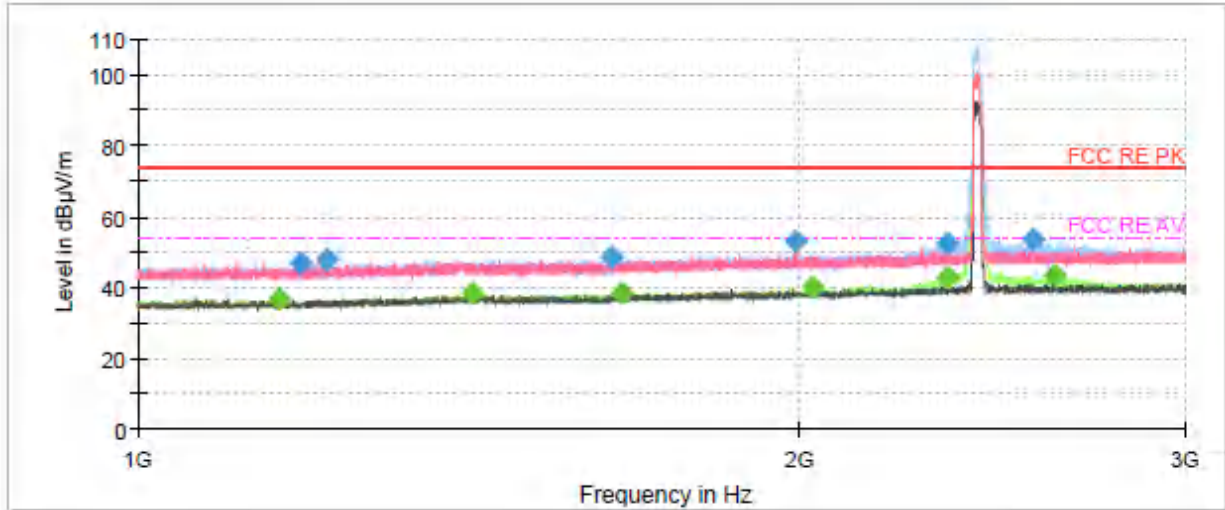

Note: The signal beyond the limit is carrier.

Radiates Emission from 1GHz to 3GHz

Frequency (MHz)	MaxPeak (dB µ V/m)	Average (dB µ V/m)	Limit (dB µ V/m)	Margin (dB)	Height (cm)	Pol	Azimuth (deg)	Corr. (dB/m)
1158.733333	---	36.66	54.00	17.34	200.0	H	4.0	-9
1185.333333	46.73	---	74.00	27.27	200.0	H	4.0	-9
1217.333333	47.73	---	74.00	26.27	200.0	H	60.0	-9
1421.200000	---	38.62	54.00	15.38	100.0	H	350.0	-7
1642.266667	48.58	---	74.00	25.42	200.0	H	234.0	-6
1660.000000	---	38.59	54.00	15.41	200.0	H	265.0	-6
1993.200000	53.21	---	74.00	20.79	200.0	V	157.0	-5
2029.533333	---	39.98	54.00	14.02	100.0	H	32.0	-5
2335.733333	52.58	---	74.00	21.42	200.0	H	289.0	-4
2339.666667	---	43.13	54.00	10.87	200.0	H	60.0	-4
2560.266667	53.61	---	74.00	20.39	100.0	H	276.0	-4
2616.800000	---	43.53	54.00	10.47	100.0	H	297.0	-4

Remark: 1. Correction Factor = Antenna factor+ Insertion loss (cable loss + amplifier gain)

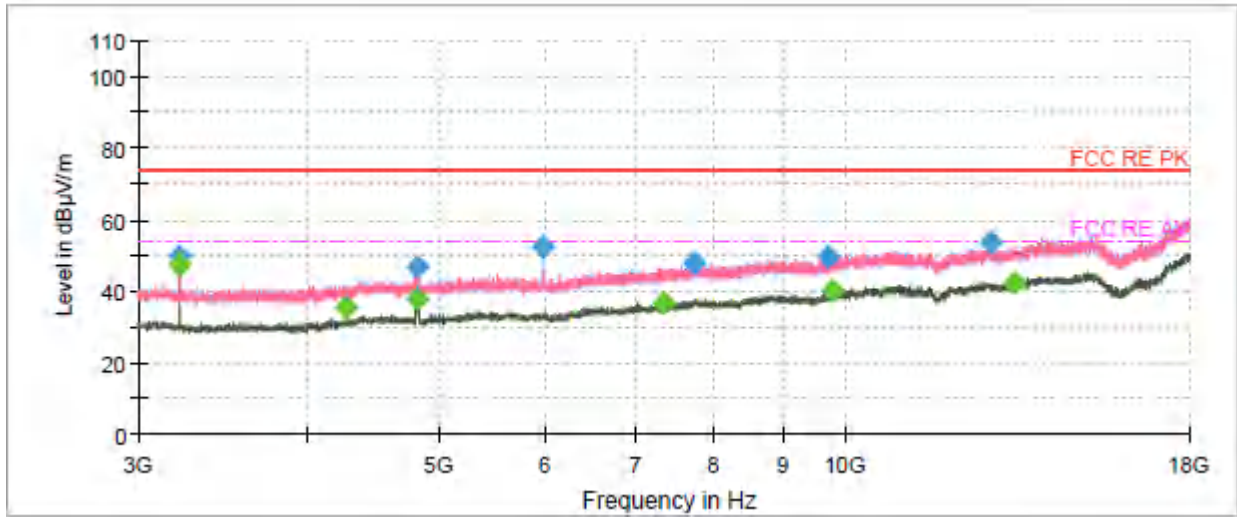

Radiates Emission from 3GHz to 18GHz

Frequency (MHz)	MaxPeak (dB µ V/m)	Average (dB µ V/m)	Limit (dB µ V/m)	Margin (dB)	Height (cm)	Pol	Azimuth (deg)	Corr. (dB/m)
3215.500000	49.55	---	74.00	24.45	200.0	V	255.0	-13
3215.500000	---	47.42	54.00	6.58	200.0	V	255.0	-13
4280.500000	---	35.62	54.00	18.38	200.0	V	210.0	-10
4828.000000	46.62	---	74.00	27.38	200.0	V	337.0	-9
4828.000000	---	37.95	54.00	16.05	200.0	V	337.0	-9
5974.000000	52.41	---	74.00	21.59	100.0	H	0.0	-6
7343.000000	---	36.67	54.00	17.33	100.0	V	159.0	-3
7749.500000	48.15	---	74.00	25.85	100.0	H	176.0	-3
9736.000000	49.51	---	74.00	24.49	200.0	V	221.0	-2
9796.000000	---	39.93	54.00	14.07	200.0	H	359.0	-2
12814.000000	53.54	---	74.00	20.46	100.0	H	266.0	2
13335.500000	---	42.52	54.00	11.48	100.0	V	115.0	3

Remark: 1. Correction Factor = Antenna factor+ Insertion loss (cable loss + amplifier gain)



802.11n (HT20) CH6

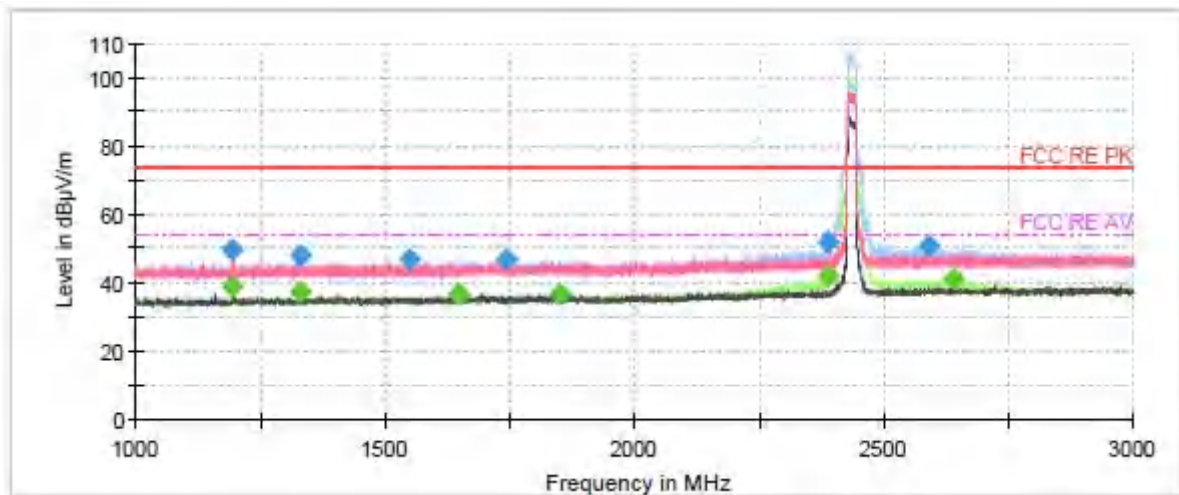

Note: The signal beyond the limit is carrier.

Radiates Emission from 1GHz to 3GHz

Frequency (MHz)	MaxPeak (dB μ V/m)	Average (dB μ V/m)	Limit (dB μ V/m)	Margin (dB)	Height (cm)	Pol	Azimuth (deg)	Corr. (dB/m)
1195.000000	---	39.15	54.00	14.85	200.0	V	358.0	-10.3
1195.266667	49.77	---	74.00	24.23	200.0	V	358.0	-10.3
1330.933333	47.93	---	74.00	26.07	200.0	V	349.0	-9.7
1330.933333	---	37.27	54.00	16.73	200.0	V	349.0	-9.7
1549.800000	46.70	---	74.00	27.30	200.0	V	94.0	-9.0
1650.800000	---	36.53	54.00	17.47	200.0	H	197.0	-8.7
1742.000000	47.00	---	74.00	27.00	200.0	H	81.0	-8.6
1849.266667	---	36.68	54.00	17.32	100.0	H	5.0	-8.4
2388.200000	---	41.60	54.00	12.40	200.0	H	0.0	-6.5
2388.400000	51.83	---	74.00	22.17	200.0	H	0.0	-6.5
2590.533333	50.93	---	74.00	23.07	100.0	H	1.0	-6.1
2639.733333	---	41.00	54.00	13.00	100.0	H	16.0	-6.1

Remark: 1. Correction Factor = Antenna factor+ Insertion loss (cable loss + amplifier gain)

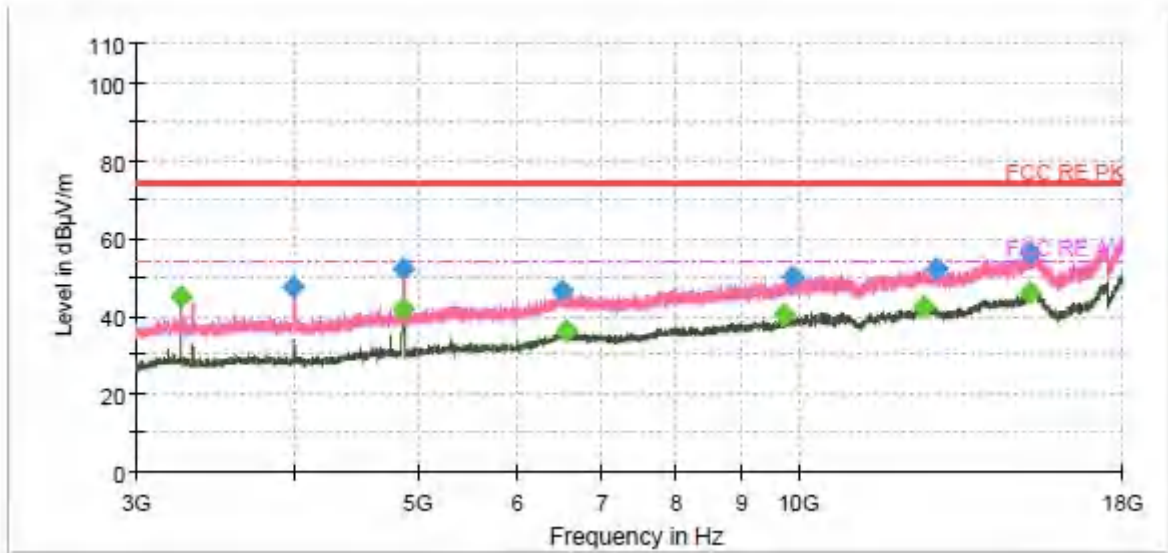

Radiates Emission from 3GHz to 18GHz

Frequency (MHz)	MaxPeak (dB µ V/m)	Average (dB µ V/m)	Limit (dB µ V/m)	Margin (dB)	Height (cm)	Pol	Azimuth (deg)	Corr. (dB/m)
3249.000000	---	45.18	54.00	8.82	200.0	V	0.0	-15.2
3991.000000	47.55	---	74.00	26.45	200.0	V	11.0	-13.4
4871.500000	52.35	---	74.00	21.65	200.0	V	296.0	-10.7
4877.000000	---	42.16	54.00	11.84	200.0	V	296.0	-10.7
6505.500000	46.65	---	74.00	27.35	100.0	H	111.0	-3.7
6535.500000	---	36.31	54.00	17.69	200.0	V	55.0	-3.7
9742.000000	---	40.23	54.00	13.77	100.0	V	131.0	-2.4
9894.500000	50.08	---	74.00	23.92	200.0	V	166.0	-1.7
12529.500000	---	42.54	54.00	11.46	200.0	V	28.0	2.0
12822.000000	52.27	---	74.00	21.73	100.0	H	168.0	2.1
15178.500000	---	46.22	54.00	7.78	100.0	V	346.0	5.2
15207.500000	56.10	---	74.00	17.90	200.0	H	346.0	5.3

Remark: 1. Correction Factor = Antenna factor+ Insertion loss (cable loss + amplifier gain)

802.11n (HT20) CH11

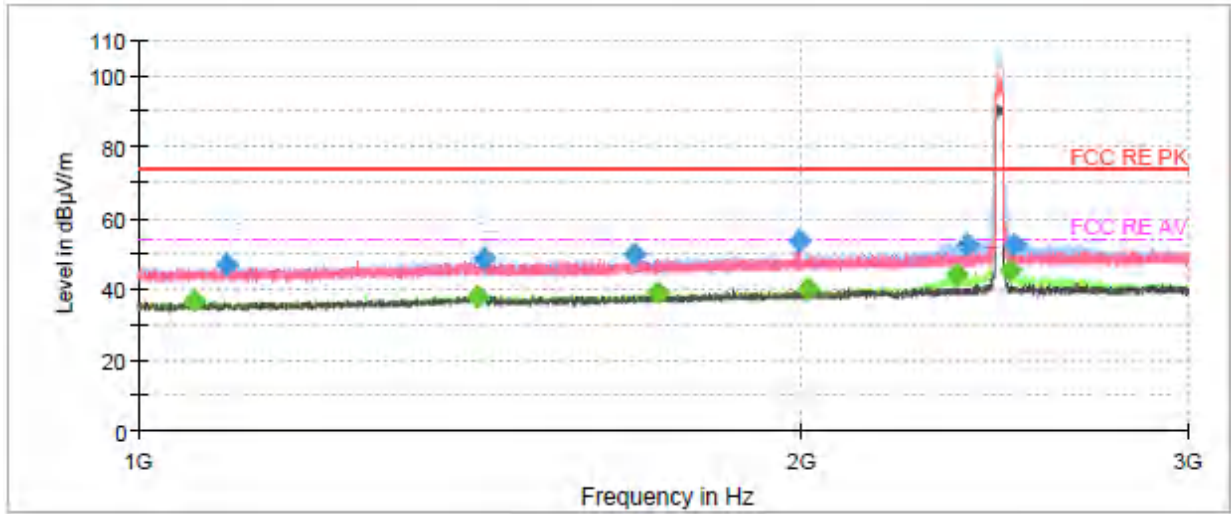

Note: The signal beyond the limit is carrier.

Radiates Emission from 1GHz to 3GHz

Frequency (MHz)	MaxPeak (dB µ V/m)	Average (dB µ V/m)	Limit (dB µ V/m)	Margin (dB)	Height (cm)	Pol	Azimuth (deg)	Corr. (dB/m)
1059.000000	---	36.67	54.00	17.33	100.0	H	298.0	-9
1097.533333	46.70	---	74.00	27.30	200.0	V	330.0	-9
1425.266667	---	37.97	54.00	16.03	200.0	V	270.0	-7
1434.333333	48.39	---	74.00	25.61	200.0	V	356.0	-7
1678.533333	49.68	---	74.00	24.32	100.0	H	228.0	-6
1723.333333	---	38.80	54.00	15.20	200.0	H	0.0	-6
1995.466667	53.51	---	74.00	20.49	200.0	V	160.0	-5
2015.600000	---	40.04	54.00	13.96	200.0	H	146.0	-5
2355.000000	---	43.81	54.00	10.19	100.0	H	278.0	-4
2379.933333	52.55	---	74.00	21.45	200.0	H	86.0	-4
2490.533333	---	45.11	54.00	8.89	100.0	H	288.0	-4
2499.866667	52.61	---	74.00	21.39	200.0	H	306.0	-4

Remark: 1. Correction Factor = Antenna factor+ Insertion loss (cable loss + amplifier gain)

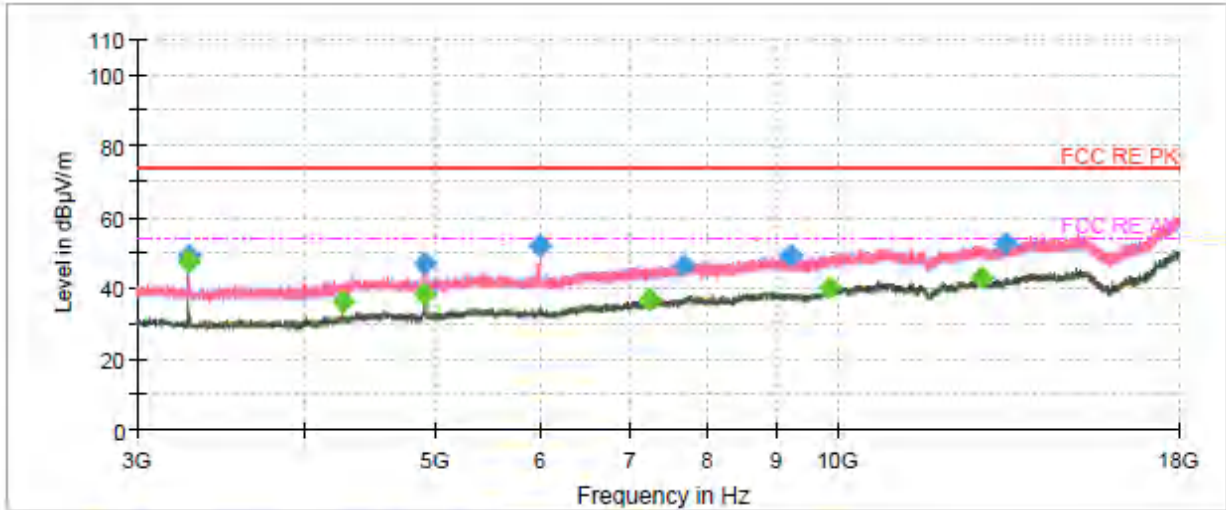

Radiates Emission from 3GHz to 18GHz

Frequency (MHz)	MaxPeak (dB µ V/m)	Average (dB µ V/m)	Limit (dB µ V/m)	Margin (dB)	Height (cm)	Pol	Azimuth (deg)	Corr. (dB/m)
3282.500000	---	47.66	54.00	6.34	200.0	V	67.0	-13
3282.500000	49.10	---	74.00	24.90	200.0	V	67.0	-13
4280.500000	---	36.08	54.00	17.92	200.0	V	210.0	-10
4919.000000	46.98	---	74.00	27.02	200.0	H	58.0	-8
4920.500000	---	38.37	54.00	15.63	200.0	V	222.0	-8
5999.000000	51.69	---	74.00	22.31	200.0	V	88.0	-5
7248.000000	---	36.64	54.00	17.36	100.0	H	14.0	-4
7668.500000	46.51	---	74.00	27.49	200.0	H	306.0	-3
9241.000000	49.18	---	74.00	24.82	200.0	V	188.0	-2
9857.500000	---	40.05	54.00	13.95	100.0	V	0.0	-1
12800.000000	---	42.95	54.00	11.05	100.0	V	35.0	2
13344.000000	52.54	---	74.00	21.46	200.0	H	356.0	3

Remark: 1. Correction Factor = Antenna factor+ Insertion loss (cable loss + amplifier gain)



802.11n (HT40) CH3

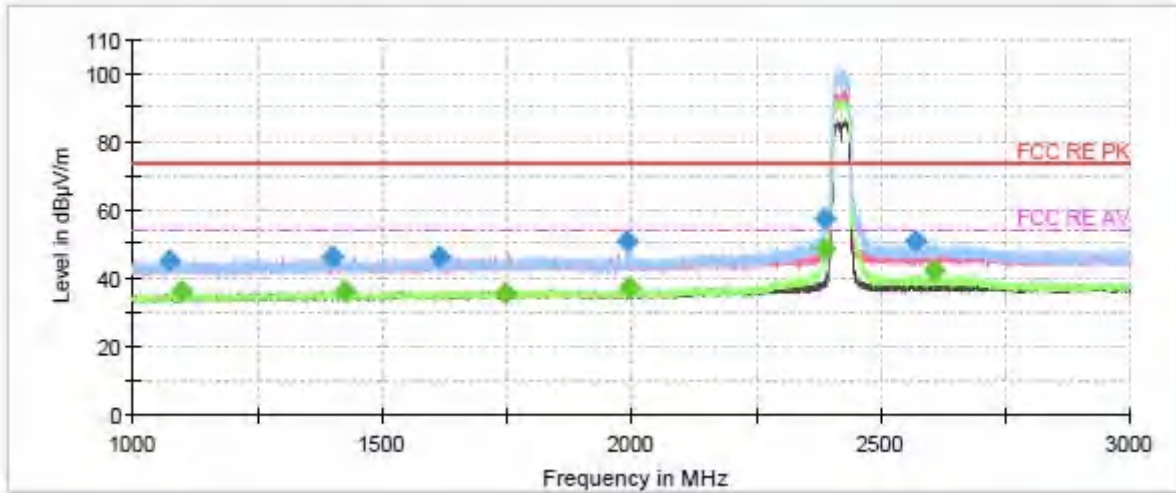

Note: The signal beyond the limit is carrier.

Radiates Emission from 1GHz to 3GHz

Frequency (MHz)	MaxPeak (dB µ V/m)	Average (dB µ V/m)	Limit (dB µ V/m)	Margin (dB)	Height (cm)	Pol	Azimuth (deg)	Corr. (dB/m)
1074.666667	45.33	---	74.00	28.67	100.0	V	198.0	-10.8
1098.400000	---	35.98	54.00	18.02	200.0	H	0.0	-10.6
1402.866667	46.46	---	74.00	27.54	200.0	H	0.0	-9.5
1425.200000	---	36.29	54.00	17.71	100.0	H	0.0	-9.3
1614.933333	46.51	---	74.00	27.49	200.0	H	114.0	-8.9
1749.866667	---	35.79	54.00	18.21	200.0	V	339.0	-8.6
1991.466667	50.89	---	74.00	23.11	200.0	V	161.0	-8.2
1997.466667	---	37.35	54.00	16.65	200.0	H	129.0	-8.2
2388.000000	---	48.77	54.00	5.23	100.0	H	199.0	-6.5
2388.000000	57.66	---	74.00	16.34	100.0	H	199.0	-6.5
2572.000000	50.50	---	74.00	23.50	200.0	H	211.0	-6.2
2608.733333	---	42.23	54.00	11.77	200.0	H	211.0	-6.1

Remark: 1. Correction Factor = Antenna factor+ Insertion loss (cable loss + amplifier gain)

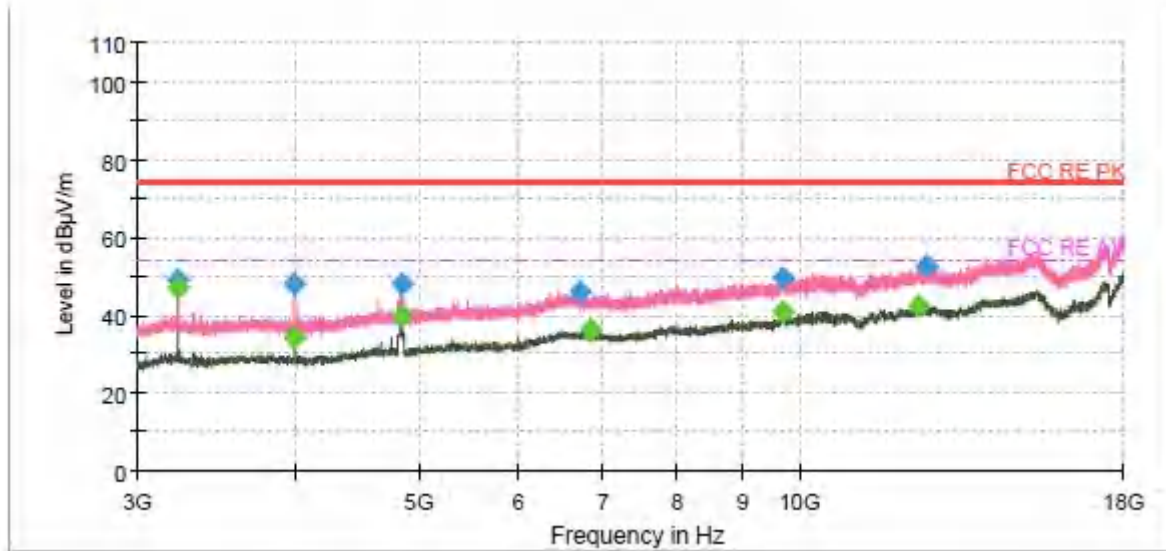

Radiates Emission from 3GHz to 18GHz

Frequency (MHz)	MaxPeak (dB µ V/m)	Average (dB µ V/m)	Limit (dB µ V/m)	Margin (dB)	Height (cm)	Pol	Azimuth (deg)	Corr. (dB/m)
3229.000000	49.02	---	74.00	24.98	200.0	V	272.0	-15.1
3229.000000	---	47.26	54.00	6.74	200.0	V	272.0	-15.1
3986.500000	---	34.47	54.00	19.53	200.0	V	12.0	-13.4
3987.000000	48.01	---	74.00	25.99	200.0	V	12.0	-13.4
4843.500000	---	40.04	54.00	13.96	200.0	H	186.0	-10.7
4851.500000	48.30	---	74.00	25.70	200.0	V	302.0	-10.7
6699.000000	46.22	---	74.00	27.78	100.0	H	46.0	-3.5
6837.500000	---	36.31	54.00	17.69	100.0	H	8.0	-3.8
9680.000000	---	40.88	54.00	13.12	100.0	H	73.0	-2.4
9682.500000	49.57	---	74.00	24.43	100.0	H	2.0	-2.4
12387.000000	---	42.60	54.00	11.40	200.0	H	346.0	1.5
12586.000000	52.71	---	74.00	21.29	100.0	V	0.0	2.2

Remark: 1. Correction Factor = Antenna factor+ Insertion loss (cable loss + amplifier gain)



802.11n (HT40) CH4

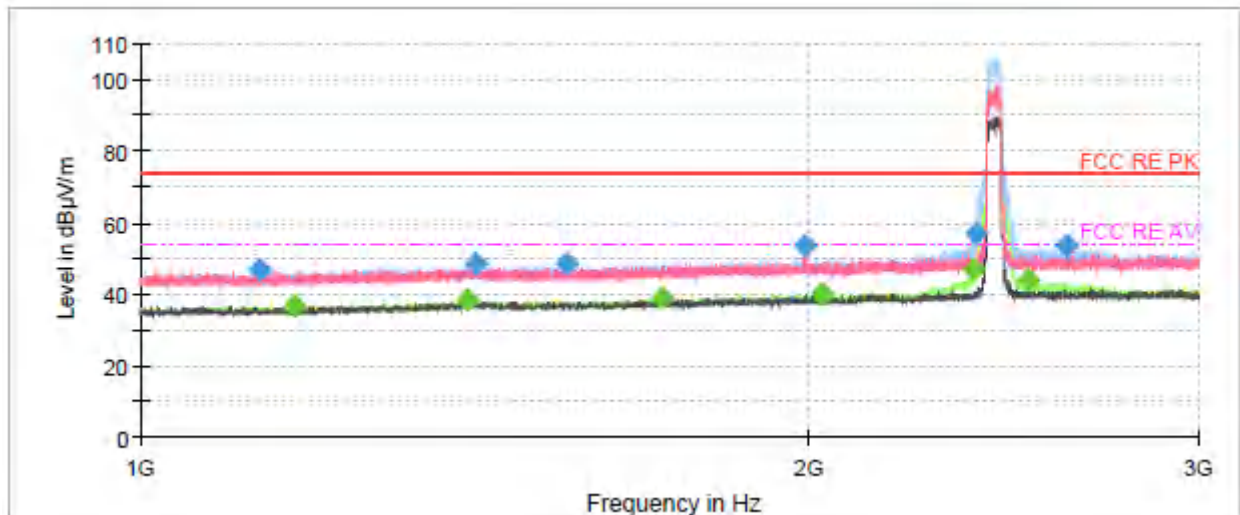

Note: The signal beyond the limit is carrier.

Radiates Emission from 1GHz to 3GHz

Frequency (MHz)	MaxPeak (dB μ V/m)	Average (dB μ V/m)	Limit (dB μ V/m)	Margin (dB)	Height (cm)	Pol	Azimuth (deg)	Corr. (dB/m)
1131.400000	46.77	---	74.00	27.23	100.0	V	203.0	-9
1172.933333	---	36.93	54.00	17.07	200.0	H	175.0	-9
1405.333333	---	38.44	54.00	15.56	100.0	H	134.0	-7
1417.200000	48.37	---	74.00	25.63	100.0	H	102.0	-7
1556.800000	48.45	---	74.00	25.55	200.0	H	268.0	-7
1719.066667	---	38.93	54.00	15.07	200.0	H	155.0	-6
1994.333333	53.73	---	74.00	20.27	200.0	V	163.0	-5
2027.066667	---	40.13	54.00	13.87	100.0	H	214.0	-5
2376.466667	---	46.84	54.00	7.16	200.0	H	61.0	-4
2378.133333	56.79	---	74.00	17.21	200.0	H	61.0	-4
2513.000000	---	43.80	54.00	10.20	100.0	H	286.0	-4
2615.200000	53.45	---	74.00	20.55	200.0	H	61.0	-4

Remark: 1. Correction Factor = Antenna factor+ Insertion loss (cable loss + amplifier gain)

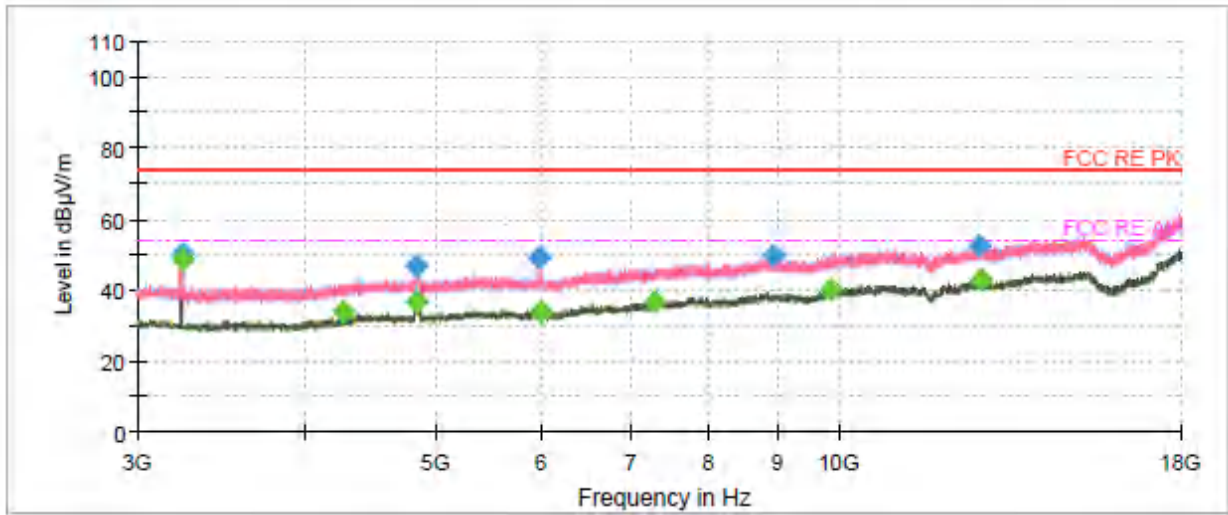

Radiates Emission from 3GHz to 18GHz

Frequency (MHz)	MaxPeak (dB µ V/m)	Average (dB µ V/m)	Limit (dB µ V/m)	Margin (dB)	Height (cm)	Pol	Azimuth (deg)	Corr. (dB/m)
3236.000000	50.37	---	74.00	23.63	200.0	V	28.0	-13
3236.000000	---	48.33	54.00	5.67	200.0	V	28.0	-13
4280.000000	---	34.10	54.00	19.90	200.0	V	211.0	-10
4846.500000	46.67	---	74.00	27.33	200.0	V	244.0	-9
4850.000000	---	36.43	54.00	17.57	100.0	V	293.0	-9
5974.500000	48.83	---	74.00	25.17	100.0	V	92.0	-6
5998.000000	---	34.01	54.00	19.99	100.0	H	0.0	-5
7282.000000	---	36.61	54.00	17.39	200.0	H	220.0	-4
8931.500000	49.58	---	74.00	24.42	200.0	H	0.0	-2
9871.500000	---	40.05	54.00	13.95	100.0	H	4.0	-1
12721.500000	52.71	---	74.00	21.29	100.0	V	282.0	3
12798.500000	---	42.64	54.00	11.36	200.0	H	318.0	2

Remark: 1. Correction Factor = Antenna factor+ Insertion loss (cable loss + amplifier gain)



802.11n (HT40) CH5

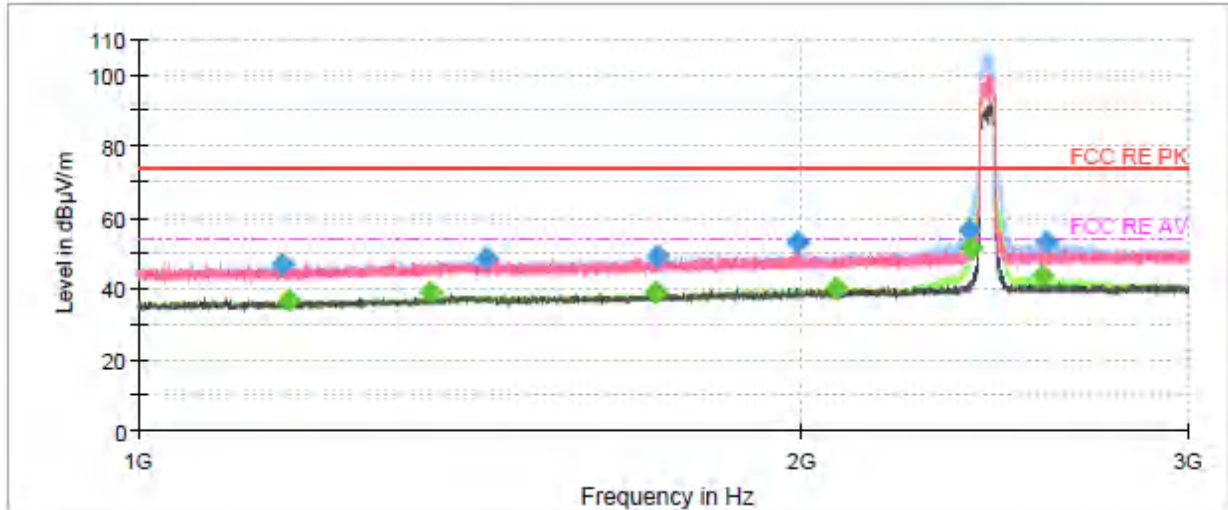

Note: The signal beyond the limit is carrier.

Radiates Emission from 1GHz to 3GHz

Frequency (MHz)	MaxPeak (dB μ V/m)	Average (dB μ V/m)	Limit (dB μ V/m)	Margin (dB)	Height (cm)	Pol	Azimuth (deg)	Corr. (dB/m)
1162.266667	46.68	---	74.00	27.32	200.0	H	242.0	-9
1171.133333	---	36.92	54.00	17.08	200.0	V	270.0	-9
1356.000000	---	38.73	54.00	15.27	100.0	H	1.0	-7
1437.600000	48.38	---	74.00	25.62	100.0	H	143.0	-7
1719.800000	---	39.06	54.00	14.94	200.0	H	333.0	-6
1722.400000	48.89	---	74.00	25.11	200.0	H	349.0	-6
1995.200000	52.84	---	74.00	21.16	200.0	V	176.0	-5
2077.333333	---	40.00	54.00	14.00	200.0	H	70.0	-5
2385.133333	56.64	---	74.00	17.36	100.0	H	91.0	-4
2388.933333	---	51.13	54.00	2.87	200.0	H	58.0	-4
2575.400000	---	43.58	54.00	10.42	200.0	H	58.0	-4
2588.133333	53.15	---	74.00	20.85	200.0	H	282.0	-4

Remark: 1. Correction Factor = Antenna factor+ Insertion loss (cable loss + amplifier gain)

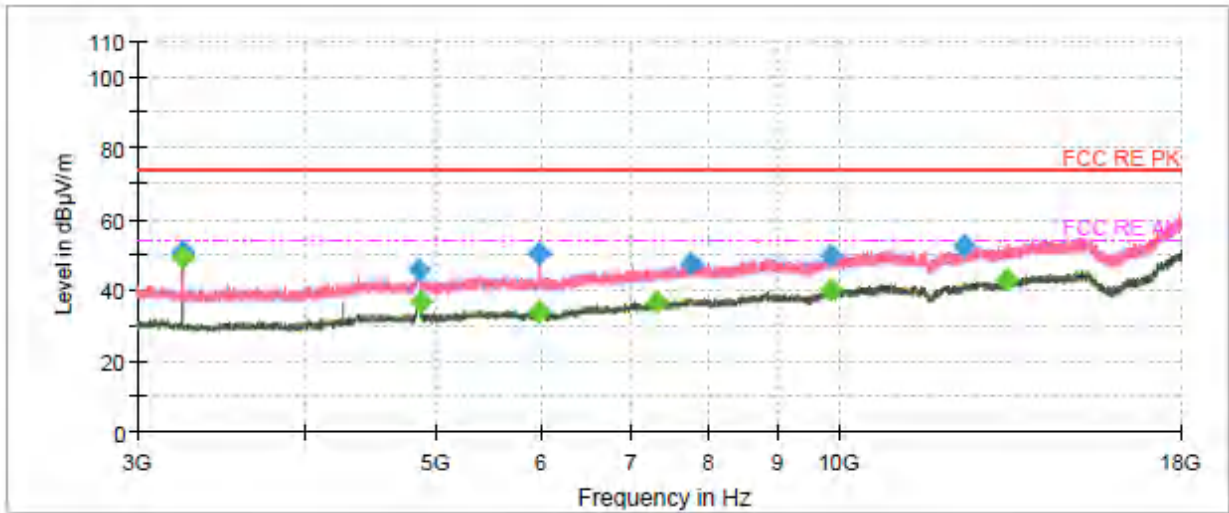

Radiates Emission from 3GHz to 18GHz

Frequency (MHz)	MaxPeak (dB µ V/m)	Average (dB µ V/m)	Limit (dB µ V/m)	Margin (dB)	Height (cm)	Pol	Azimuth (deg)	Corr. (dB/m)
3242.000000	50.71	---	74.00	23.29	200.0	V	65.0	-13
3242.500000	---	49.29	54.00	4.71	200.0	V	65.0	-13
4871.000000	45.82	---	74.00	28.18	200.0	H	163.0	-9
4878.000000	---	36.82	54.00	17.18	200.0	V	337.0	-9
5974.000000	50.17	---	74.00	23.83	100.0	H	290.0	-6
5986.500000	---	34.03	54.00	19.97	200.0	V	4.0	-5
7328.000000	---	36.59	54.00	17.41	200.0	V	289.0	-3
7757.500000	47.23	---	74.00	26.77	100.0	V	265.0	-3
9852.500000	---	39.94	54.00	14.06	100.0	V	329.0	-1
9883.000000	49.88	---	74.00	24.12	100.0	H	324.0	-1
12403.000000	52.64	---	74.00	21.36	100.0	H	23.0	2
13350.500000	---	42.79	54.00	11.21	200.0	V	13.0	3

Remark: 1. Correction Factor = Antenna factor+ Insertion loss (cable loss + amplifier gain)

802.11n (HT40) CH6

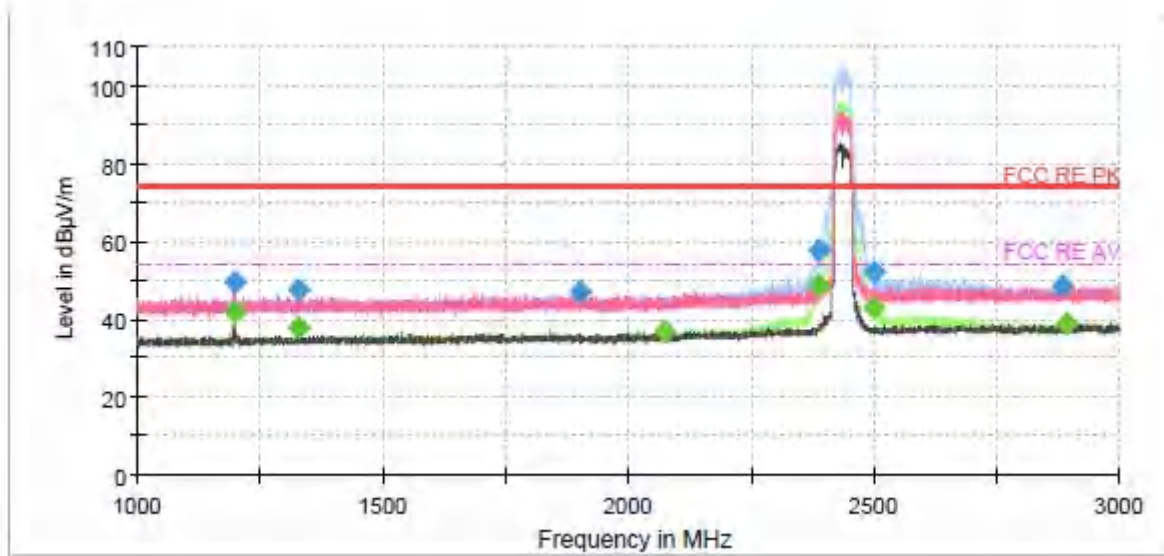

Note: The signal beyond the limit is carrier.
Radiates Emission from 1GHz to 3GHz

Frequency (MHz)	MaxPeak (dB µ V/m)	Average (dB µ V/m)	Limit (dB µ V/m)	Margin (dB)	Height (cm)	Pol	Azimuth (deg)	Corr. (dB/m)
1196.733333	49.44	---	74.00	24.56	200.0	V	0.0	-10.3
1196.733333	---	41.99	54.00	12.01	200.0	V	0.0	-10.3
1327.400000	---	37.84	54.00	16.16	200.0	V	0.0	-9.7
1328.133333	47.82	---	74.00	26.18	200.0	V	0.0	-9.7
1899.800000	46.93	---	74.00	27.07	200.0	H	208.0	-8.4
2071.133333	---	36.78	54.00	17.23	100.0	H	75.0	-7.9
2389.266667	57.59	---	74.00	16.41	100.0	H	0.0	-6.5
2389.800000	---	48.46	54.00	5.54	100.0	H	5.0	-6.5
2498.533333	52.35	---	74.00	21.65	100.0	H	14.0	-6.3
2500.066667	---	42.72	54.00	11.28	100.0	H	14.0	-6.3
2881.466667	48.76	---	74.00	25.24	200.0	H	0.0	-6.0
2893.466667	---	38.84	54.00	15.16	200.0	H	277.0	-6.0

Remark: 1. Correction Factor = Antenna factor+ Insertion loss (cable loss + amplifier gain)

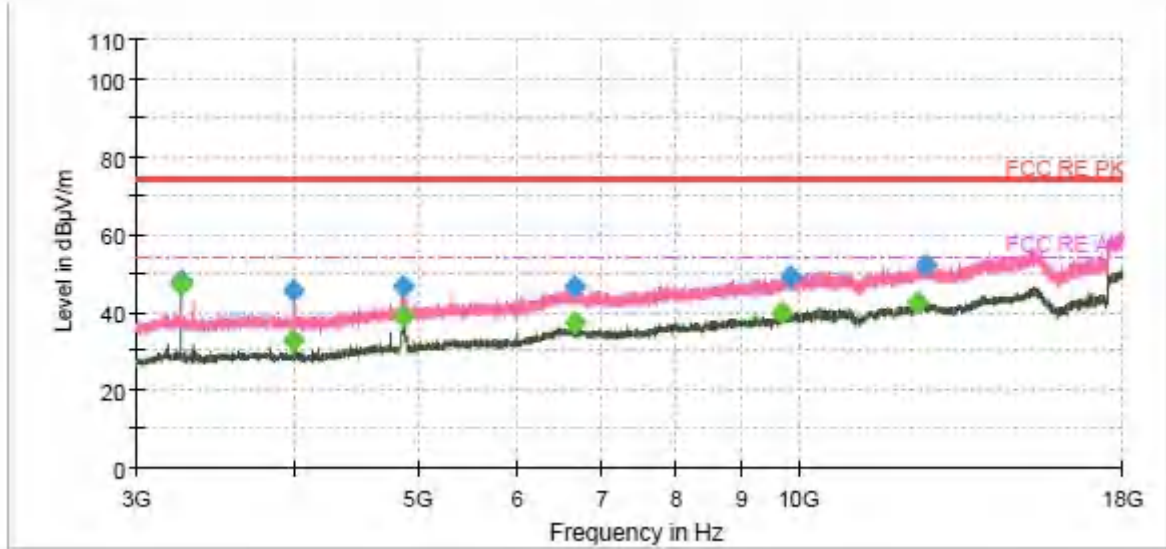

Radiates Emission from 3GHz to 18GHz

Frequency (MHz)	MaxPeak (dB µ V/m)	Average (dB µ V/m)	Limit (dB µ V/m)	Margin (dB)	Height (cm)	Pol	Azimuth (deg)	Corr. (dB/m)
3249.000000	---	46.84	54.00	7.16	200.0	V	271.0	-15.2
3249.500000	48.16	---	74.00	25.84	200.0	V	271.0	-15.2
3988.000000	---	32.64	54.00	21.36	100.0	H	211.0	-13.4
3988.500000	45.49	---	74.00	28.51	100.0	H	211.0	-13.4
4873.000000	46.40	---	74.00	27.60	200.0	V	301.0	-10.7
4874.000000	---	39.02	54.00	14.98	200.0	V	286.0	-10.7
6656.500000	---	37.34	54.00	16.66	100.0	V	58.0	-3.5
6657.500000	46.58	---	74.00	27.42	100.0	V	58.0	-3.5
9703.500000	---	39.76	54.00	14.24	100.0	H	298.0	-2.5
9839.500000	49.06	---	74.00	24.94	200.0	H	202.0	-1.8
12385.500000	---	42.54	54.00	11.46	200.0	V	21.0	1.5
12564.500000	52.06	---	74.00	21.94	200.0	V	4.0	2.1

Remark: 1. Correction Factor = Antenna factor+ Insertion loss (cable loss + amplifier gain)



802.11n (HT40) CH7

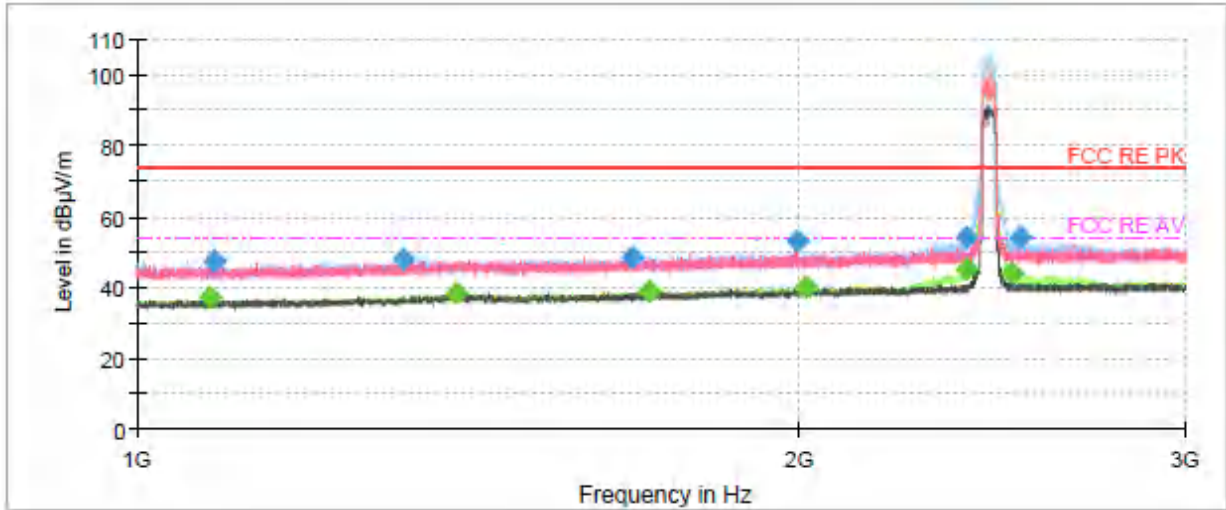

Note: The signal beyond the limit is carrier.

Radiates Emission from 1GHz to 3GHz

Frequency (MHz)	MaxPeak (dB µ V/m)	Average (dB µ V/m)	Limit (dB µ V/m)	Margin (dB)	Height (cm)	Pol	Azimuth (deg)	Corr. (dB/m)
1078.733333	---	37.00	54.00	17.00	100.0	H	4.0	-9
1084.866667	47.28	---	74.00	26.72	200.0	H	88.0	-9
1322.333333	47.97	---	74.00	26.03	100.0	H	2.0	-8
1399.133333	---	38.12	54.00	15.88	100.0	H	100.0	-7
1681.866667	48.53	---	74.00	25.47	100.0	H	6.0	-6
1710.733333	---	38.82	54.00	15.18	100.0	H	130.0	-6
1997.266667	52.88	---	74.00	21.12	200.0	V	103.0	-5
2013.600000	---	40.00	54.00	14.00	200.0	H	247.0	-5
2383.333333	54.28	---	74.00	19.72	100.0	H	60.0	-4
2385.133333	---	44.89	54.00	9.11	200.0	H	76.0	-4
2499.133333	---	44.26	54.00	9.74	100.0	H	291.0	-4
2522.333333	53.90	---	74.00	20.10	100.0	H	70.0	-4

Remark: 1. Correction Factor = Antenna factor+ Insertion loss (cable loss + amplifier gain)

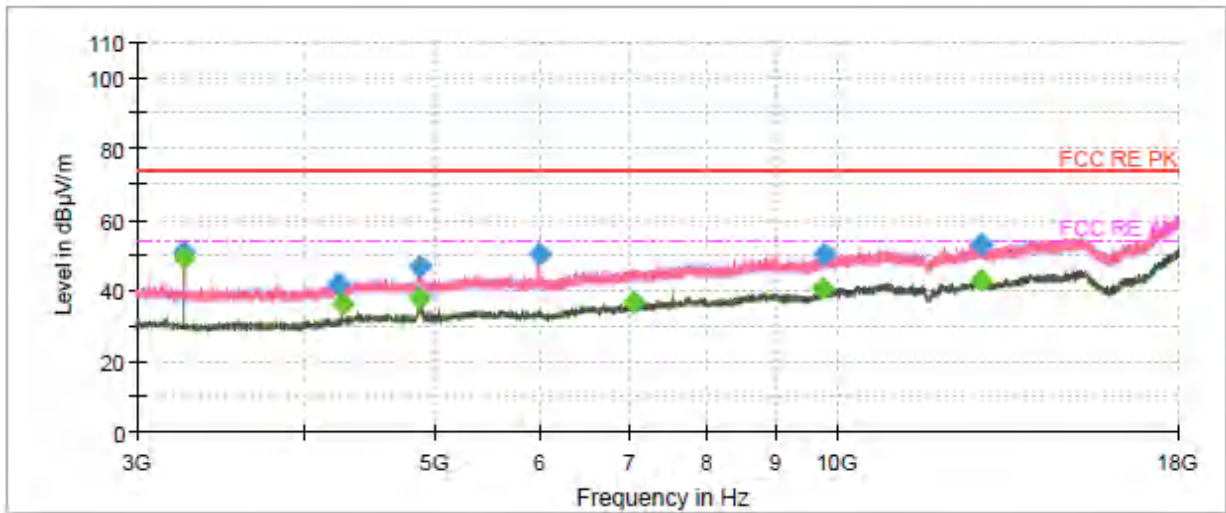

Radiates Emission from 3GHz to 18GHz

Frequency (MHz)	MaxPeak (dB µ V/m)	Average (dB µ V/m)	Limit (dB µ V/m)	Margin (dB)	Height (cm)	Pol	Azimuth (deg)	Corr. (dB/m)
3255.500000	50.77	---	74.00	23.23	200.0	V	257.0	-13
3255.500000	---	48.90	54.00	5.10	200.0	V	257.0	-13
4242.500000	41.59	---	74.00	32.41	200.0	V	189.0	-11
4281.000000	---	35.85	54.00	18.15	200.0	V	212.0	-10
4879.500000	46.56	---	74.00	27.44	200.0	V	338.0	-9
4883.500000	---	37.93	54.00	16.07	200.0	V	338.0	-9
5999.500000	50.26	---	74.00	23.74	100.0	H	0.0	-5
7069.000000	---	36.76	54.00	17.24	200.0	V	100.0	-3
9768.000000	---	40.34	54.00	13.66	100.0	V	0.0	-2
9810.500000	50.23	---	74.00	23.77	200.0	V	325.0	-1
12804.500000	52.92	---	74.00	21.08	200.0	V	110.0	2
12823.500000	---	43.06	54.00	10.94	100.0	V	0.0	2

Remark: 1. Correction Factor = Antenna factor+ Insertion loss (cable loss + amplifier gain)



802.11n (HT40) CH8

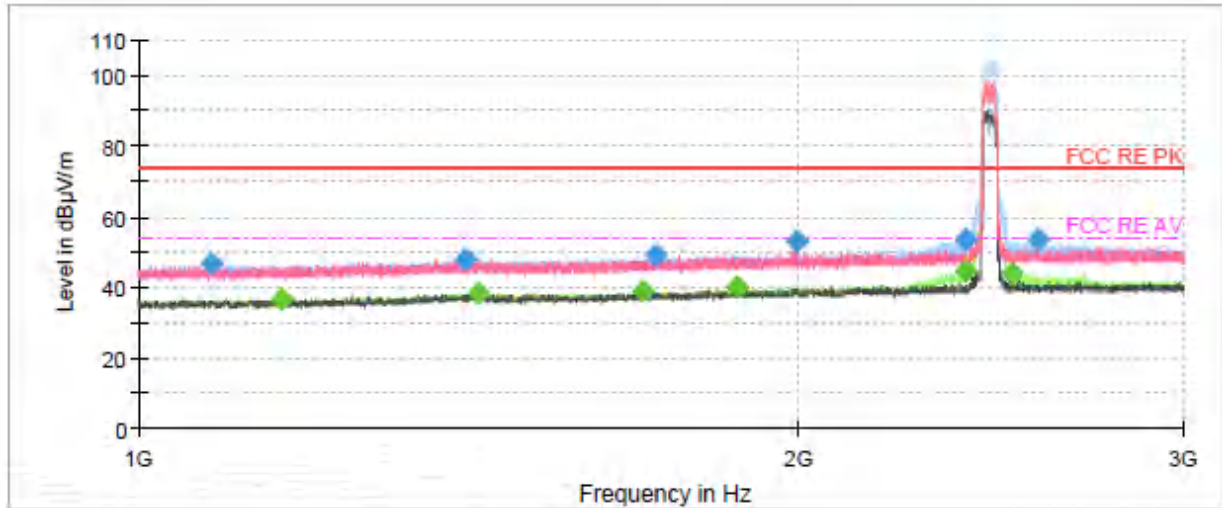

Note: The signal beyond the limit is carrier.

Radiates Emission from 1GHz to 3GHz

Frequency (MHz)	MaxPeak (dB µ V/m)	Average (dB µ V/m)	Limit (dB µ V/m)	Margin (dB)	Height (cm)	Pol	Azimuth (deg)	Corr. (dB/m)
1080.000000	46.87	---	74.00	27.13	100.0	H	5.0	-9
1162.600000	---	36.89	54.00	17.11	200.0	H	358.0	-9
1410.466667	48.14	---	74.00	25.86	200.0	H	247.0	-7
1430.133333	---	38.20	54.00	15.80	100.0	H	152.0	-7
1699.733333	---	38.90	54.00	15.10	200.0	H	227.0	-6
1723.533333	49.07	---	74.00	24.93	200.0	H	348.0	-6
1877.266667	---	40.17	54.00	13.83	200.0	H	358.0	-5
1997.733333	53.06	---	74.00	20.94	200.0	V	172.0	-5
2383.800000	53.52	---	74.00	20.48	100.0	H	92.0	-4
2384.266667	---	44.53	54.00	9.47	100.0	H	61.0	-4
2504.133333	---	43.75	54.00	10.25	100.0	H	112.0	-4
2575.266667	53.37	---	74.00	20.63	200.0	H	289.0	-4

Remark: 1. Correction Factor = Antenna factor+ Insertion loss (cable loss + amplifier gain)

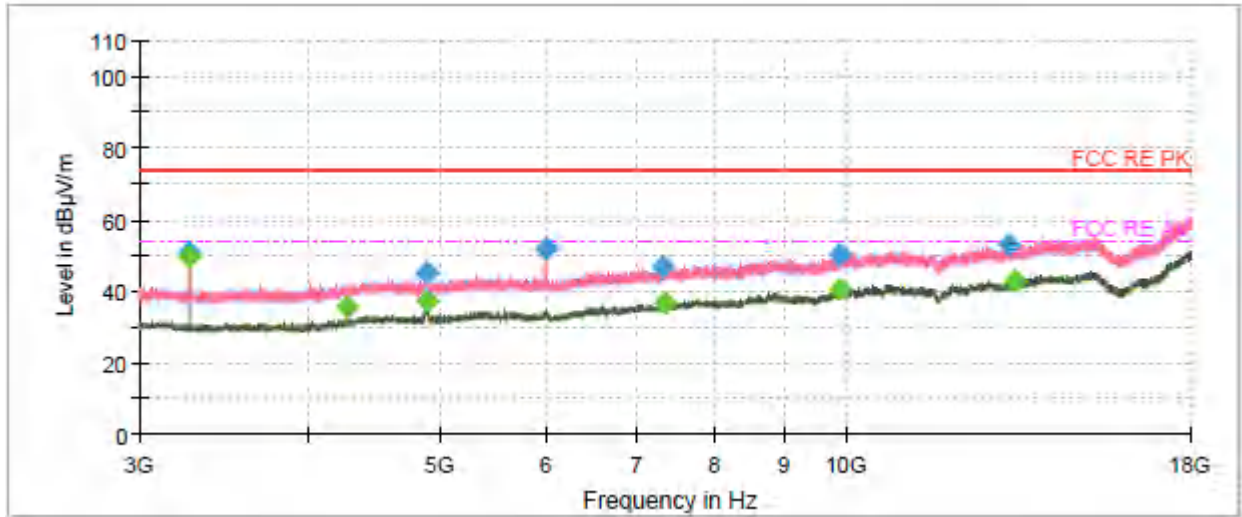

Radiates Emission from 3GHz to 18GHz

Frequency (MHz)	MaxPeak (dB µ V/m)	Average (dB µ V/m)	Limit (dB µ V/m)	Margin (dB)	Height (cm)	Pol	Azimuth (deg)	Corr. (dB/m)
3262.500000	50.79	---	74.00	23.21	200.0	V	255.0	-13
3262.500000	---	49.68	54.00	4.32	200.0	V	255.0	-13
4280.500000	---	35.73	54.00	18.27	200.0	V	211.0	-10
4893.000000	---	37.05	54.00	16.95	100.0	H	134.0	-9
4901.000000	45.02	---	74.00	28.98	200.0	H	57.0	-9
6000.500000	52.13	---	74.00	21.87	200.0	V	244.0	-5
7333.000000	46.66	---	74.00	27.34	200.0	V	9.0	-3
7346.500000	---	36.76	54.00	17.24	100.0	H	77.0	-3
9889.000000	---	40.43	54.00	13.57	200.0	V	255.0	-1
9889.000000	50.23	---	74.00	23.77	200.0	V	255.0	-1
13212.500000	52.75	---	74.00	21.25	200.0	V	3.0	3
13344.000000	---	42.88	54.00	11.12	100.0	H	8.0	3

Remark: 1. Correction Factor = Antenna factor+ Insertion loss (cable loss + amplifier gain)

802.11n (HT40) CH9

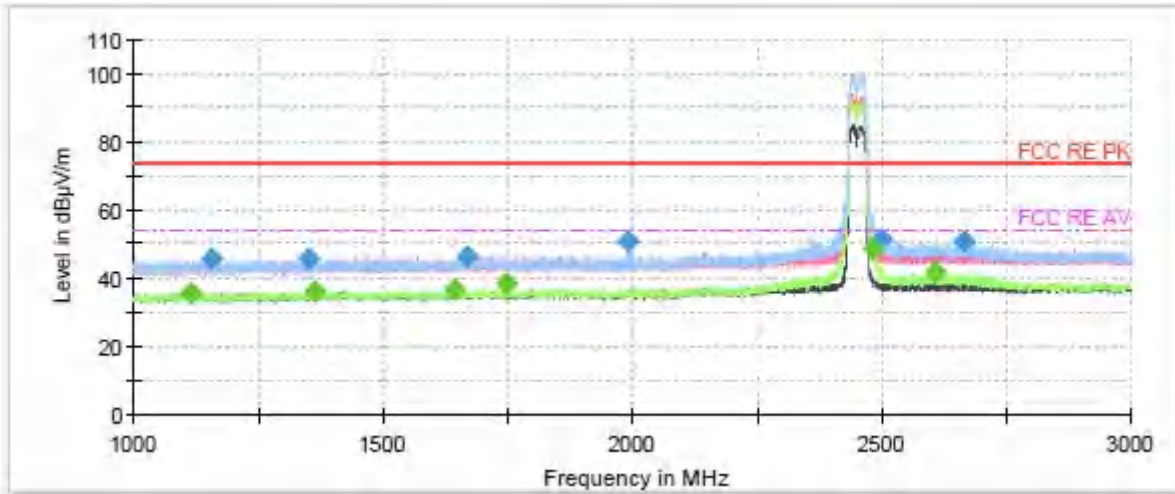

Note: The signal beyond the limit is carrier.

Radiates Emission from 1GHz to 3GHz

Frequency (MHz)	MaxPeak (dB µ V/m)	Average (dB µ V/m)	Limit (dB µ V/m)	Margin (dB)	Height (cm)	Pol	Azimuth (deg)	Corr. (dB/m)
1113.733333	---	35.73	54.00	18.27	100.0	H	266.0	-10.6
1158.200000	45.73	---	74.00	28.27	100.0	V	19.0	-10.4
1349.200000	45.97	---	74.00	28.03	200.0	V	176.0	-9.6
1363.000000	---	36.17	54.00	17.83	200.0	V	110.0	-9.6
1645.800000	---	36.58	54.00	17.42	200.0	H	155.0	-8.7
1671.466667	46.37	---	74.00	27.63	200.0	H	26.0	-8.8
1749.600000	---	38.33	54.00	15.67	100.0	H	53.0	-8.6
1990.866667	50.73	---	74.00	23.27	200.0	V	285.0	-8.2
2484.400000	---	48.71	54.00	5.29	200.0	H	212.0	-6.3
2498.733333	51.31	---	74.00	22.69	100.0	H	213.0	-6.3
2608.333333	---	42.00	54.00	12.00	200.0	H	195.0	-6.1
2666.466667	50.64	---	74.00	23.36	100.0	H	213.0	-6.0

Remark: 1. Correction Factor = Antenna factor+ Insertion loss (cable loss + amplifier gain)

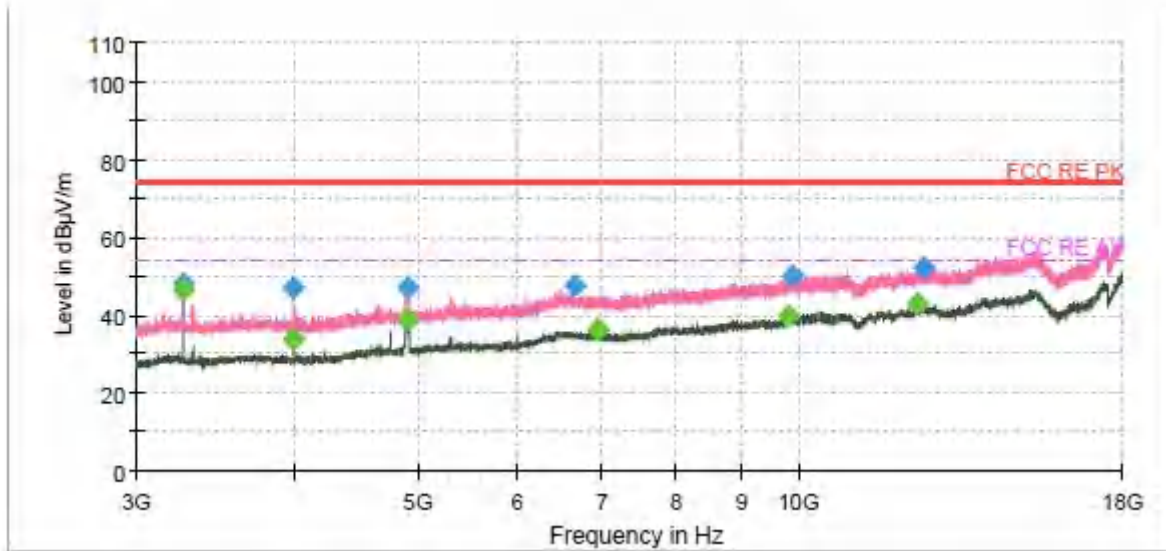

Radiates Emission from 3GHz to 18GHz

Frequency (MHz)	MaxPeak (dB µ V/m)	Average (dB µ V/m)	Limit (dB µ V/m)	Margin (dB)	Height (cm)	Pol	Azimuth (deg)	Corr. (dB/m)
3269.000000	48.29	---	74.00	25.71	200.0	V	273.0	-15.1
3269.000000	---	46.63	54.00	7.37	200.0	V	273.0	-15.1
3988.000000	47.27	---	74.00	26.73	100.0	V	58.0	-13.4
3988.000000	---	33.62	54.00	20.38	100.0	V	58.0	-13.4
4901.000000	---	39.02	54.00	14.98	200.0	H	186.0	-10.7
4908.000000	47.03	---	74.00	26.97	200.0	V	288.0	-10.6
6637.500000	47.55	---	74.00	26.45	100.0	V	58.0	-3.5
6935.000000	---	36.25	54.00	17.75	200.0	V	203.0	-3.8
9797.500000	---	40.03	54.00	13.97	100.0	H	0.0	-2.0
9887.500000	49.97	---	74.00	24.03	200.0	V	118.0	-1.7
12399.000000	---	42.73	54.00	11.27	100.0	H	132.0	1.6
12536.500000	52.00	---	74.00	22.00	100.0	H	0.0	2.0

Remark: 1. Correction Factor = Antenna factor+ Insertion loss (cable loss + amplifier gain)



Bluetooth LE-Channel 0

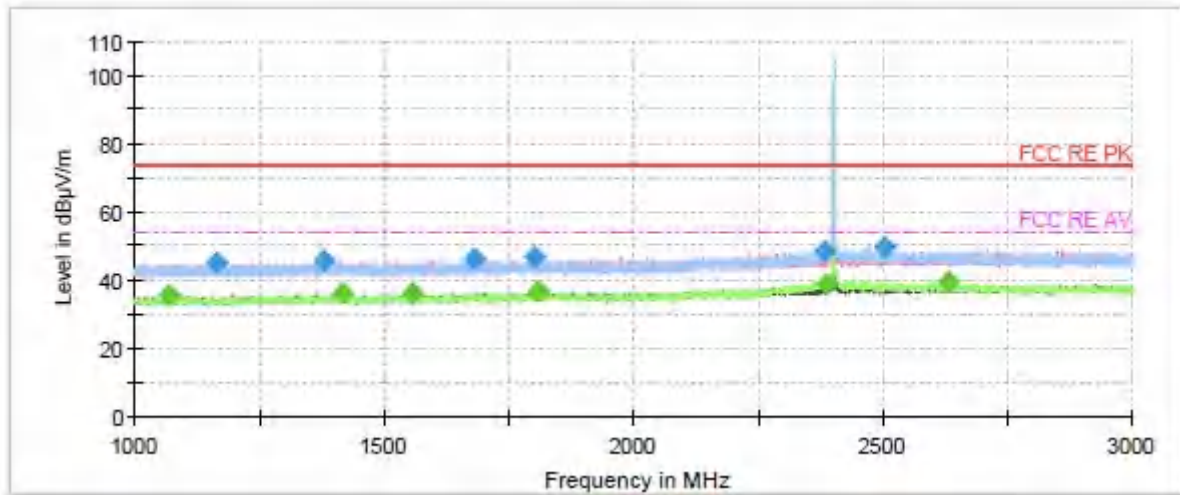

Note: The signal beyond the limit is carrier.

Radiates Emission from 1GHz to 3GHz

Frequency (MHz)	MaxPeak (dB μ V/m)	Average (dB μ V/m)	Limit (dB μ V/m)	Margin (dB)	Height (cm)	Pol	Azimuth (deg)	Corr. (dB/m)
1068.800000	---	35.72	54.00	18.28	200.0	V	318.0	-10.8
1163.266667	44.88	---	74.00	29.12	200.0	V	0.0	-10.4
1380.466667	45.52	---	74.00	28.48	100.0	V	55.0	-9.6
1415.800000	---	36.01	54.00	17.99	100.0	V	67.0	-9.3
1556.333333	---	36.29	54.00	17.71	200.0	H	64.0	-8.9
1681.200000	46.43	---	74.00	27.57	200.0	H	262.0	-8.7
1800.666667	46.76	---	74.00	27.24	100.0	V	5.0	-8.5
1809.866667	---	36.67	54.00	17.33	100.0	V	319.0	-8.5
2386.266667	48.69	---	74.00	25.31	100.0	H	55.0	-6.5
2387.200000	---	38.93	54.00	15.07	200.0	H	4.0	-6.5
2502.333333	49.48	---	74.00	24.52	200.0	V	0.0	-6.3
2630.200000	---	39.72	54.00	14.28	200.0	H	2.0	-6.1

Remark: 1. Correction Factor = Antenna factor+ Insertion loss (cable loss + amplifier gain)

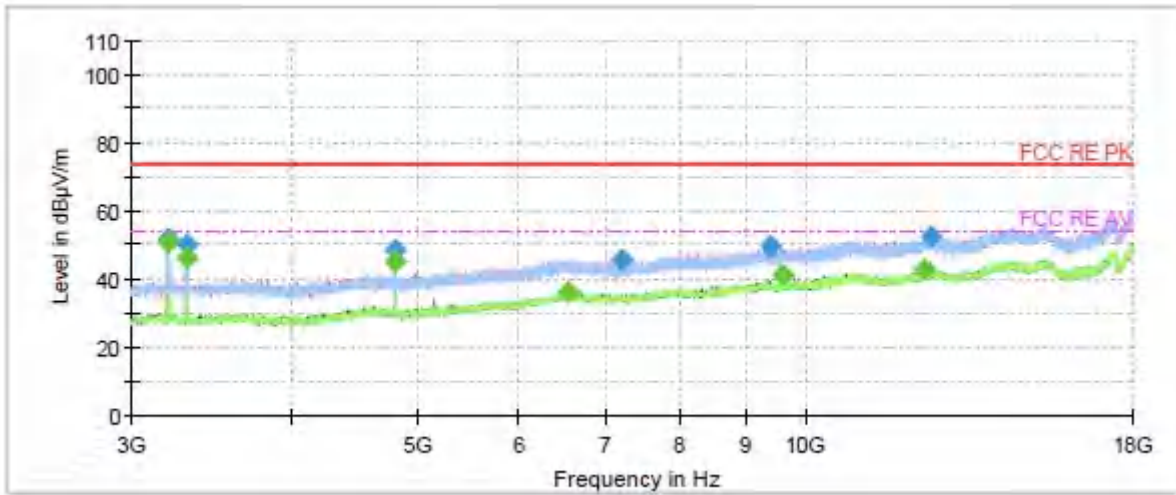

Radiates Emission from 3GHz to 18GHz

Frequency (MHz)	MaxPeak (dB µ V/m)	Average (dB µ V/m)	Limit (dB µ V/m)	Margin (dB)	Height (cm)	Pol	Azimuth (deg)	Corr. (dB/m)
3205.000000	51.85	---	74.00	22.15	200.0	H	41.0	-15.2
3205.000000	---	50.68	54.00	3.32	200.0	H	41.0	-15.2
3311.500000	---	46.19	54.00	7.81	100.0	H	144.0	-15.1
3312.000000	50.34	---	74.00	23.66	100.0	V	182.0	-15.1
4807.500000	48.52	---	74.00	25.48	100.0	H	336.0	-10.6
4807.500000	---	45.23	54.00	8.77	100.0	H	336.0	-10.6
6546.000000	---	36.11	54.00	17.89	200.0	H	6.0	-3.7
7217.500000	45.76	---	74.00	28.24	200.0	V	161.0	-4.5
9390.500000	49.59	---	74.00	24.41	200.0	V	230.0	-2.7
9616.500000	---	41.22	54.00	12.78	100.0	V	69.0	-2.3
12409.500000	---	42.82	54.00	11.18	200.0	H	155.0	1.6
12552.000000	52.68	---	74.00	21.32	200.0	H	0.0	2.1

Remark: 1. Correction Factor = Antenna factor+ Insertion loss (cable loss + amplifier gain)



Bluetooth LE-Channel 19

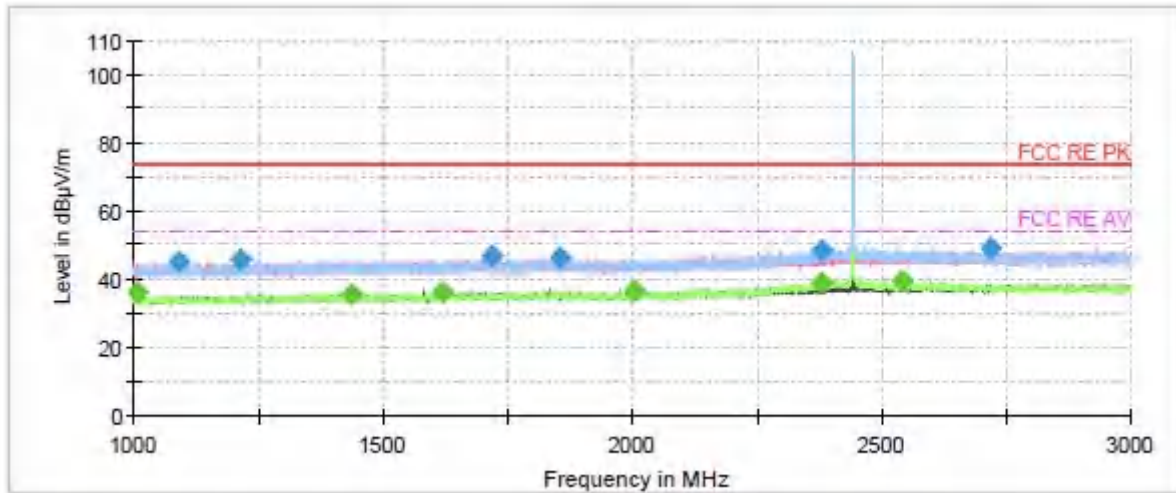

Note: The signal beyond the limit is carrier.

Radiates Emission from 1GHz to 3GHz

Frequency (MHz)	MaxPeak (dB μ V/m)	Average (dB μ V/m)	Limit (dB μ V/m)	Margin (dB)	Height (cm)	Pol	Azimuth (deg)	Corr. (dB/m)
1007.000000	---	35.95	54.00	18.05	200.0	H	157.0	-11.0
1089.733333	45.38	---	74.00	28.62	200.0	H	222.0	-10.7
1215.533333	45.88	---	74.00	28.12	100.0	H	239.0	-10.2
1438.933333	---	35.82	54.00	18.18	100.0	V	6.0	-9.3
1620.266667	---	36.25	54.00	17.75	100.0	H	226.0	-8.8
1717.200000	46.60	---	74.00	27.40	100.0	H	252.0	-8.6
1854.466667	46.43	---	74.00	27.57	100.0	V	4.0	-8.4
2002.333333	---	36.59	54.00	17.41	200.0	V	58.0	-8.2
2379.200000	48.68	---	74.00	25.32	200.0	H	1.0	-6.6
2381.933333	---	39.13	54.00	14.87	200.0	H	7.0	-6.5
2542.066667	---	39.48	54.00	14.52	200.0	H	4.0	-6.2
2717.000000	48.89	---	74.00	25.11	100.0	H	316.0	-6.1

Remark: 1. Correction Factor = Antenna factor+ Insertion loss (cable loss + amplifier gain)

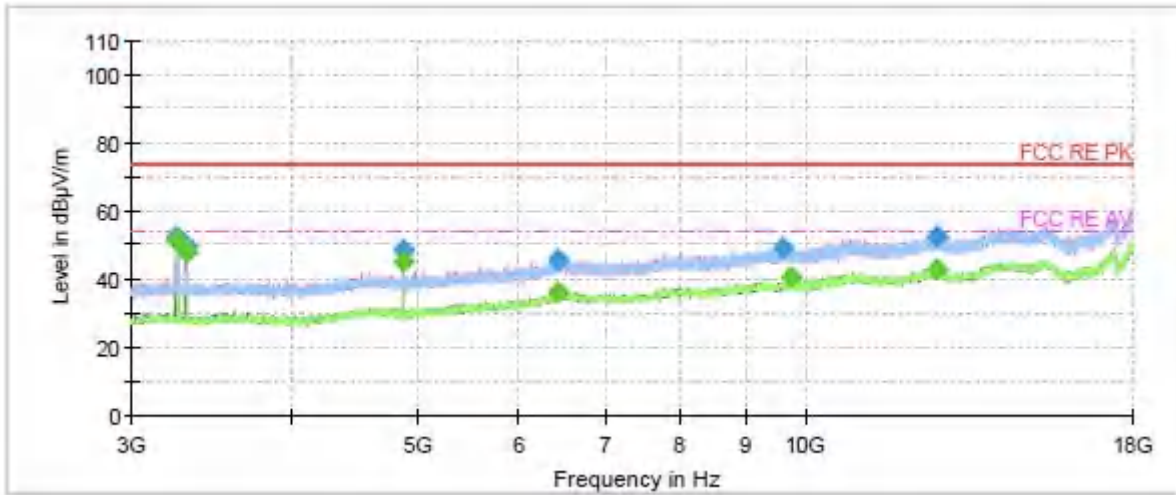

Radiates Emission from 3GHz to 18GHz

Frequency (MHz)	MaxPeak (dB µ V/m)	Average (dB µ V/m)	Limit (dB µ V/m)	Margin (dB)	Height (cm)	Pol	Azimuth (deg)	Corr. (dB/m)
3258.500000	52.18	---	74.00	21.82	200.0	V	194.0	-15.2
3258.500000	---	51.09	54.00	2.91	200.0	V	194.0	-15.2
3311.500000	---	47.96	54.00	6.04	200.0	V	151.0	-15.1
3312.000000	49.85	---	74.00	24.15	200.0	V	151.0	-15.1
4887.500000	48.30	---	74.00	25.70	200.0	H	332.0	-10.7
4887.500000	---	44.89	54.00	9.11	100.0	H	328.0	-10.7
6429.500000	45.65	---	74.00	28.35	100.0	H	160.0	-4.3
6445.000000	---	36.32	54.00	17.68	100.0	H	301.0	-4.2
9610.500000	49.15	---	74.00	24.85	200.0	V	350.0	-2.3
9775.000000	---	40.56	54.00	13.44	100.0	V	74.0	-2.2
12673.000000	52.55	---	74.00	21.45	100.0	V	317.0	2.3
12700.500000	---	42.73	54.00	11.27	100.0	H	245.0	2.3

Remark: 1. Correction Factor = Antenna factor+ Insertion loss (cable loss + amplifier gain)



Bluetooth LE-Channel 39

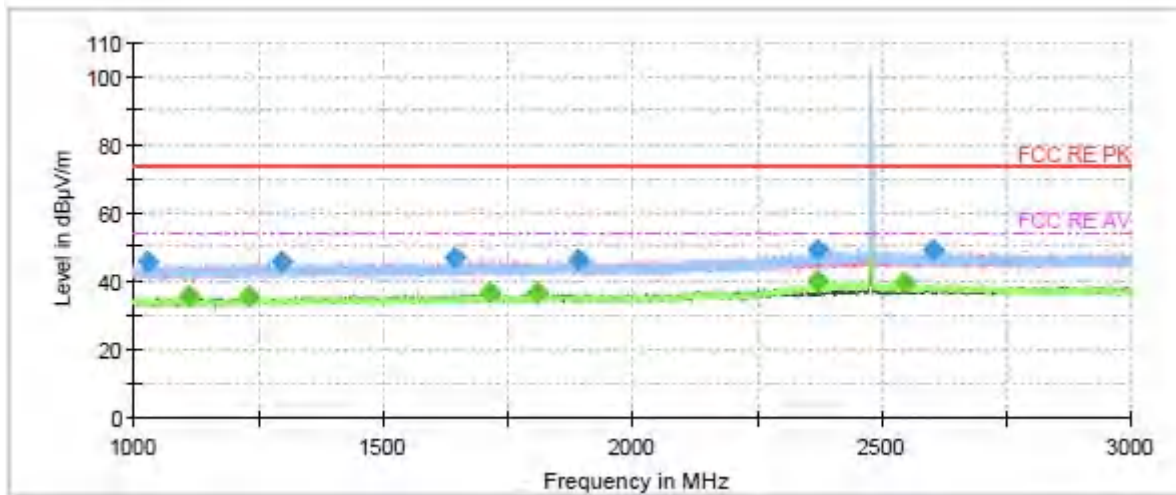

Note: The signal beyond the limit is carrier.

Radiates Emission from 1GHz to 3GHz

Frequency (MHz)	MaxPeak (dB μ V/m)	Average (dB μ V/m)	Limit (dB μ V/m)	Margin (dB)	Height (cm)	Pol	Azimuth (deg)	Corr. (dB/m)
1027.333333	45.52	---	74.00	28.48	100.0	H	202.0	-11.0
1111.466667	---	35.30	54.00	18.70	100.0	V	250.0	-10.6
1229.533333	---	35.63	54.00	18.37	200.0	H	358.0	-10.1
1298.133333	45.89	---	74.00	28.11	100.0	V	8.0	-9.8
1646.666667	46.61	---	74.00	27.39	100.0	H	216.0	-8.7
1715.733333	---	36.64	54.00	17.36	200.0	H	131.0	-8.6
1809.933333	---	36.47	54.00	17.53	100.0	V	82.0	-8.5
1891.933333	46.42	---	74.00	27.58	100.0	H	216.0	-8.4
2371.200000	49.19	---	74.00	24.81	100.0	H	359.0	-6.6
2372.066667	---	39.81	54.00	14.19	200.0	H	2.0	-6.6
2547.466667	---	39.72	54.00	14.28	100.0	H	56.0	-6.2
2603.333333	49.01	---	74.00	24.99	200.0	H	42.0	-6.1

Remark: 1. Correction Factor = Antenna factor+ Insertion loss (cable loss + amplifier gain)

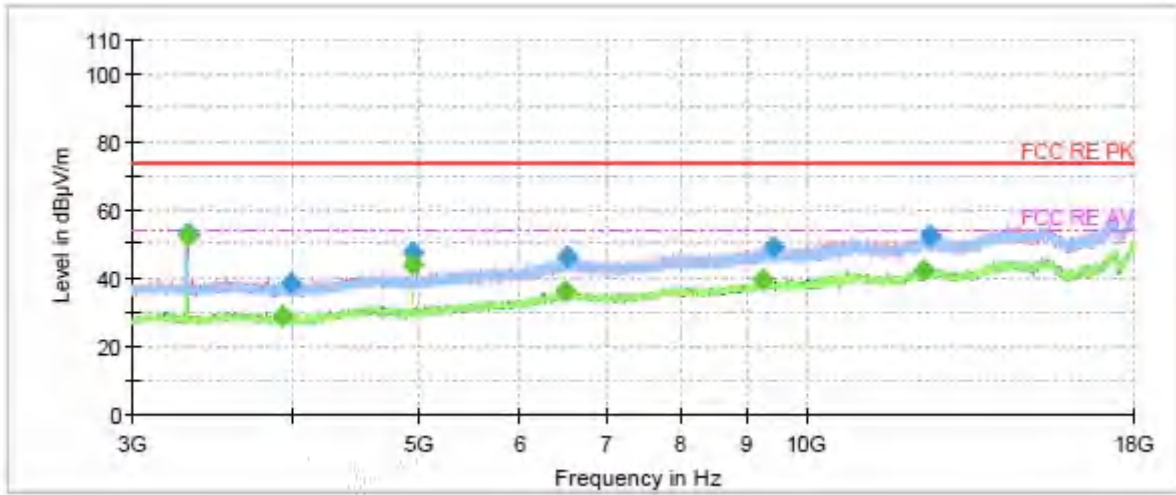

Radiates Emission from 3GHz to 18GHz

Frequency (MHz)	MaxPeak (dB µ V/m)	Average (dB µ V/m)	Limit (dB µ V/m)	Margin (dB)	Height (cm)	Pol	Azimuth (deg)	Corr. (dB/m)
3311.500000	---	52.25	54.00	1.75	200.0	V	191.0	-15.1
3312.000000	53.20	---	74.00	20.80	200.0	V	191.0	-15.1
3922.000000	---	28.85	54.00	25.15	100.0	V	213.0	-13.6
3987.500000	38.62	---	74.00	35.38	100.0	V	301.0	-13.4
4959.500000	---	43.92	54.00	10.08	100.0	H	63.0	-10.5
4959.500000	47.44	---	74.00	26.56	100.0	H	63.0	-10.5
6516.500000	---	35.99	54.00	18.01	200.0	V	90.0	-3.7
6520.000000	46.21	---	74.00	27.79	100.0	V	6.0	-3.7
9256.000000	---	39.54	54.00	14.46	200.0	V	274.0	-2.9
9431.500000	48.80	---	74.00	25.20	200.0	V	316.0	-2.7
12373.000000	---	42.38	54.00	11.62	100.0	H	342.0	1.5
12495.000000	52.58	---	74.00	21.42	200.0	H	358.0	1.9

Remark: 1. Correction Factor = Antenna factor+ Insertion loss (cable loss + amplifier gain)



During the test, the Radiates Emission from 18GHz to 26GHz was performed in all modes with all channels, 802.11b CH11 are selected as the worst condition. The test data of the worst-case condition was recorded in this report.

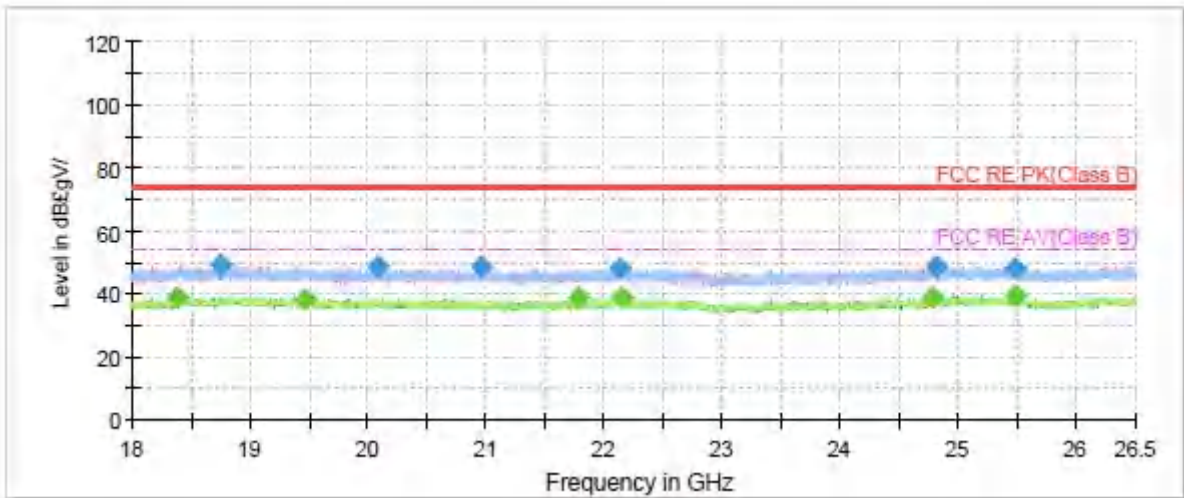

Radiates Emission from 18GHz to 26GHz

5.7. Conducted Emission

Ambient condition

Temperature	Relative humidity	Pressure
23°C ~25°C	45%~50%	101.5kPa

Methods of Measurement

The EUT is placed on a non-metallic table of 80cm height above the horizontal metal reference ground plane. During the test, the EUT was operating in its typical mode. The test method is according to ANSI C63.10. Connect the AC power line of the EUT to the L.I.S.N. Use EMI receiver to detect the average and Quasi-peak value. RBW is set to 9 kHz, VBW is set to 30kHz.

The measurement result should include both L line and N line.

The test is in transmitting mode.

Test Setup

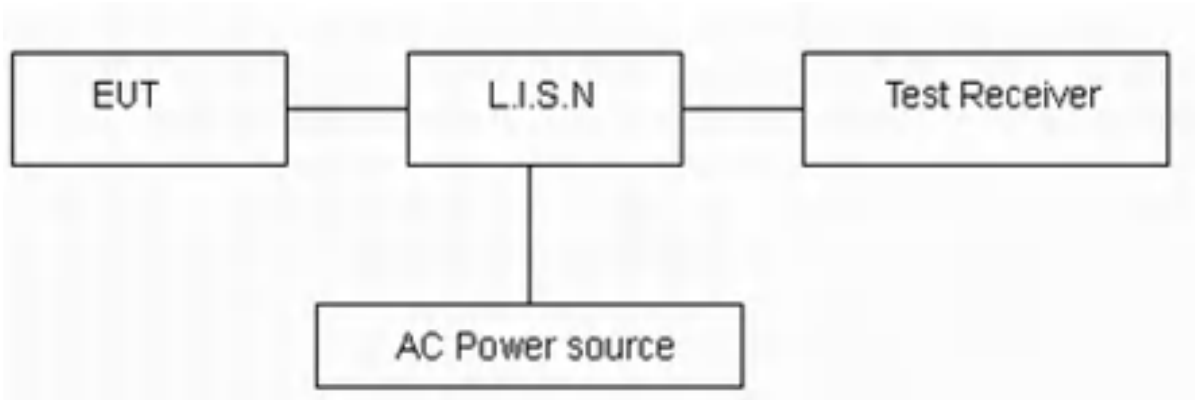

Note: AC Power source is used to change the voltage 110V/60Hz.

Limits

Frequency (MHz)	Conducted Limits(dBμV)	
	Quasi-peak	Average
0.15 - 0.5	66 to 56 *	56 to 46 *
0.5 - 5	56	46
5 - 30	60	50

*: Decreases with the logarithm of the frequency.

Measurement Uncertainty

The assessed measurement uncertainty to ensure 95% confidence level for the normal distribution is with the coverage factor $k = 1.96$, $U = 2.69$ dB.



Test Results:

Following plots, Blue trace uses the peak detection and Green trace uses the average detection. During the test, the Conducted Emission was performed in all modes (WIFI 2.4G /Bluetooth LE) with all channels, 802.11b CH11 are selected as the worst condition. The test data of the worst-case condition was recorded in this report.

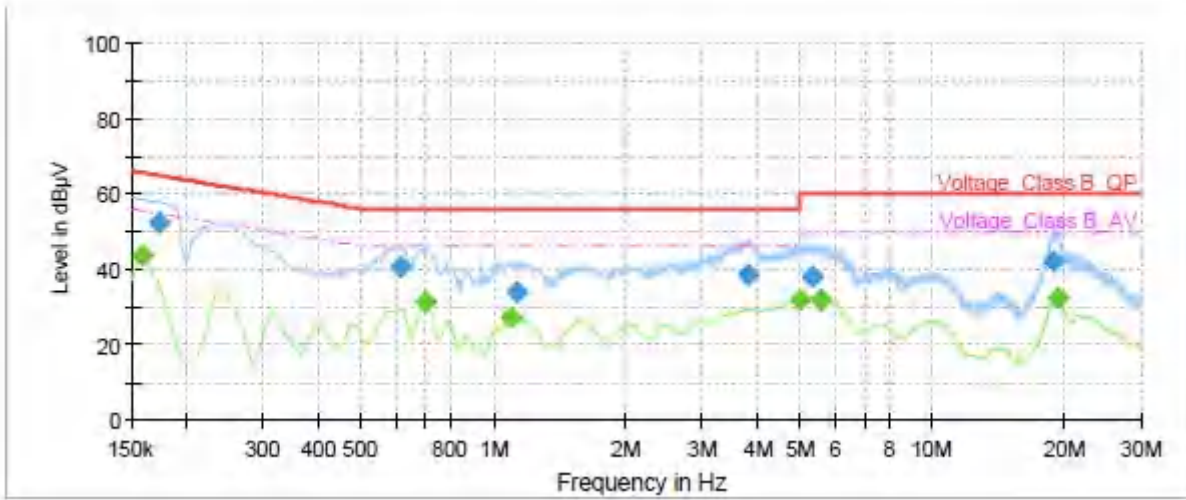

Frequency (MHz)	QuasiPeak (dBµV)	Average (dBµV)	Limit (dBµV)	Margin (dB)	Meas. Time (ms)	Bandwidth (kHz)	Line	Filter	Corr. (dB)
0.16	---	43.51	55.52	12.01	70.0	9.000	L1	ON	21
0.17	52.26	---	64.84	12.58	70.0	9.000	L1	ON	21
0.61	40.63	---	56.00	15.37	70.0	9.000	L1	ON	20
0.70	---	31.03	46.00	14.97	70.0	9.000	L1	ON	20
1.10	---	26.93	46.00	19.07	70.0	9.000	L1	ON	20
1.13	33.99	---	56.00	22.01	70.0	9.000	L1	ON	20
3.80	38.61	---	56.00	17.39	70.0	9.000	L1	ON	19
5.00	---	31.71	46.00	14.29	70.0	9.000	L1	ON	19
5.31	37.95	---	60.00	22.05	70.0	9.000	L1	ON	19
5.55	---	32.02	50.00	17.98	70.0	9.000	L1	ON	19
19.03	42.20	---	60.00	17.80	70.0	9.000	L1	ON	20
19.30	---	32.51	50.00	17.49	70.0	9.000	L1	ON	20

Remark: Correct factor=cable loss + LISN factor

L line Conducted Emission from 150 KHz to 30 MHz

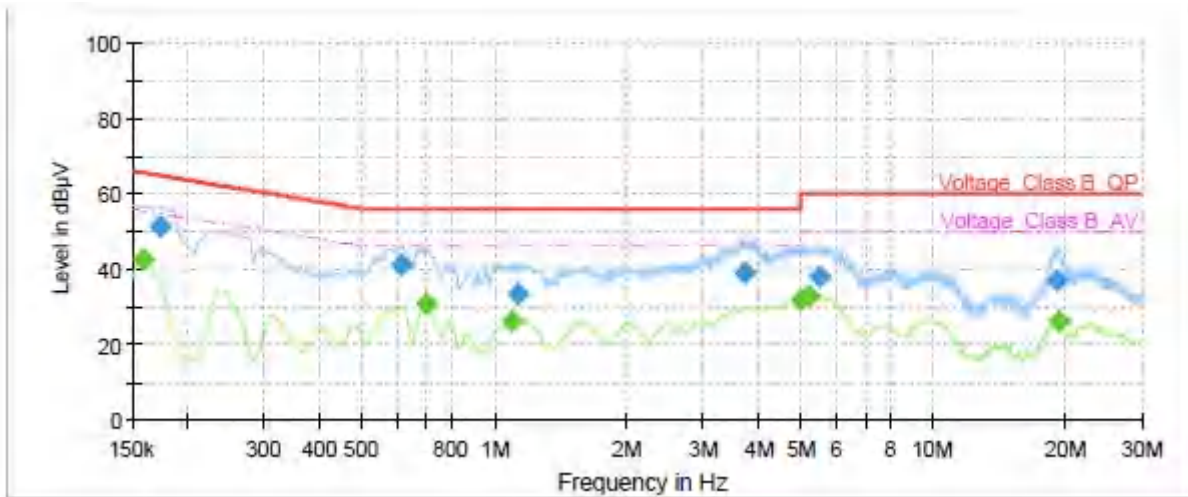

Frequency (MHz)	QuasiPeak (dBµV)	Average (dBµV)	Limit (dBµV)	Margin (dB)	Meas. Time (ms)	Bandwidth (kHz)	Line	Filter	Corr. (dB)
0.16	---	42.78	55.52	12.74	70.0	9.000	N	ON	21
0.17	51.28	---	64.84	13.56	70.0	9.000	N	ON	21
0.61	40.80	---	56.00	15.20	70.0	9.000	N	ON	20
0.70	---	30.73	46.00	15.27	70.0	9.000	N	ON	20
1.10	---	26.30	46.00	19.70	70.0	9.000	N	ON	20
1.14	33.26	---	56.00	22.74	70.0	9.000	N	ON	20
3.73	38.73	---	56.00	17.27	70.0	9.000	N	ON	19
5.00	---	31.99	46.00	14.01	70.0	9.000	N	ON	19
5.21	---	32.65	50.00	17.35	70.0	9.000	N	ON	19
5.49	38.09	---	60.00	21.91	70.0	9.000	N	ON	19
19.13	36.80	---	60.00	23.20	70.0	9.000	N	ON	20
19.30	---	26.11	50.00	23.89	70.0	9.000	N	ON	20

Remark: Correct factor=cable loss + LISN factor

N line Conducted Emission from 150 KHz to 30 MHz



6. Main Test Instruments

Date of Testing: June 2, 2021~ September 17, 2021

Name	Manufacturer	Type	Serial Number	Calibration Date	Expiration Date
Spectrum Analyzer	R&S	FSV30	100815	2020-12-13	2021-12-12
EMI Test Receiver	R&S	ESCI	100948	2021-05-15	2022-05-14
Loop Antenna	SCHWARZBECK	FMZB1519	1519-047	2020-04-02	2023-04-01
TRILOG Broadband Antenna	Schwarzbeck	VULB 9163	9163-201	2019-12-16	2022-12-15
Double Ridged Waveguide Horn Antenna	R&S	HF907	100126	2018-08-11	2021-08-10
				2018-08-11	2023-08-10
Standard Gain Horn	ETS-Lindgren	3160-09	00102643	2018-06-20	2023-06-19
EMI Test Receiver	R&S	ESR	101667	2021-05-16	2022-05-15
LISN	R&S	ENV216	101171	2018-12-15	2021-12-14
Spectrum Analyzer	Agilent	N9010A	MY47191109	2021-05-15	2022-05-14
Power Meter	R&S	NRP	104306	2021-05-15	2022-05-14
Power Sensor	R&S	NRP-Z21	104799	2021-05-15	2022-05-14
RF Cable	Agilent	SMA 15cm	0001	2021-06-12	2021-12-13
Software	R&S	EMC32	9.26.0	/	/

Date of Testing: August 29, 2022 ~ September 1, 2022

Name	Manufacturer	Type	Serial Number	Calibration Date	Expiration Date
Power sensor	R&S	OSP-B157W8	100924	2021-12-12	2022-12-11
Spectrum Analyzer	KEYSIGHT	N9020A	MY51330870	2022-05-14	2023-05-13

*****END OF REPORT *****



ANNEX A: The EUT Appearance

The EUT Appearance are submitted separately.



ANNEX B: Test Setup Photos

The Test Setup Photos are submitted separately.