

TEST REPORT

Reference No..... : WTS15S1138143-3E
FCC ID : 2AC7J-MAJESTY
Applicant..... : iDROID Inc.
Address..... : 1715 Mission Springs Dr.KATy. TEXAS 77450 USA
Manufacturer : The same as above
Address..... : The same as above
Product Name..... : Mobile Phone
Model No. : Majesty
Brand..... : iDROID
Standards..... : FCC CFR47 Part 22 Subpart H:2014
FCC CFR47 Part 24 Subpart E:2014
FCC CFR47 Part 27 Subpart L:2014
Date of Receipt sample : Nov. 25, 2015
Date of Test : Nov. 26, 2015 - Dec. 28, 2015
Date of Issue..... : Dec. 28, 2015
Test Result..... : **Pass**

Remarks:

The results shown in this test report refer only to the sample(s) tested, this test report cannot be reproduced, except in full, without prior written permission of the company. The report would be invalid without specific stamp of test institute and the signatures of compiler and approver.

Prepared By:

Waltek Services (Shenzhen) Co., Ltd.

Address: 1/F., Fukangtai Building, West Baima Road, Songgang Street, Baoan District, Shenzhen, Guangdong, China

Tel :+86-755-83551033

Fax:+86-755-83552400

Compiled by:



Zero Zhou / Test Engineer

Approved by:



Philo Zhong / Manager

2 Test Summary

Test Items	Test Requirement	Result
RF Output Power	2.1046 22.913 (a) 24.232 (c) 27.50(c) 27.50(d)	PASS
Peak-to-Average Ratio	24.232 (d)	PASS
Bandwidth	2.1049 22.905 22.917 24.238 27.53(a)	PASS
Spurious Emissions at Antenna Terminal	2.1051 22.917 (a) 24.238 (a) 27.53(h)	PASS
Field Strength of Spurious Radiation	2.1053 22.917 (a) 24.238 (a) 27.53(h)	PASS
Out of band emission, Band Edge	22.917 (a) 24.238 (a) 27.53(h)	PASS
Frequency Stability	2.1055 22.355 24.235 27.5(h) 27.54	PASS
Maximum Permissible Exposure (SAR)	1.1307 2.1093	PASS

3 Contents

	Page
1 COVER PAGE.....	1
2 TEST SUMMARY	2
3 CONTENTS	3
4 GENERAL INFORMATION.....	4
4.1 GENERAL DESCRIPTION OF E.U.T.	4
4.2 DETAILS OF E.U.T.	4
4.3 TEST MODE	6
4.4 TEST FACILITY.....	6
5 EQUIPMENT USED DURING TEST	7
5.1 EQUIPMENTS LIST	7
5.2 MEASUREMENT UNCERTAINTY	8
5.3 TEST EQUIPMENT CALIBRATION	8
6 RF OUTPUT POWER	9
6.1 EUT OPERATION.....	9
6.2 TEST PROCEDURE	9
6.3 TEST RESULT	10
7 PEAK-TO-AVERAGE RATIO.....	16
7.1 EUT OPERATION.....	16
7.2 TEST PROCEDURE	16
7.3 TEST RESULT	17
8 BANDWIDTH.....	19
8.1 EUT OPERATION.....	19
8.2 TEST PROCEDURE	19
8.3 TEST RESULT	20
9 SPURIOUS EMISSIONS AT ANTENNA TERMINALS	29
9.1 EUT OPERATION.....	29
9.2 TEST PROCEDURE	29
9.3 TEST RESULT	30
10 SPURIOUS RADIATED EMISSIONS.....	35
10.1 EUT OPERATION	35
10.2 TEST SETUP	35
10.3 SPECTRUM ANALYZER SETUP	36
10.4 TEST PROCEDURE.....	37
10.5 SUMMARY OF TEST RESULTS	38
11 BAND EDGE MEASUREMENT	40
11.1 EUT OPERATION.....	40
11.2 TEST PROCEDURE.....	40
11.3 TEST RESULT	41
12 FREQUENCY STABILITY.....	48
12.1 EUT OPERATION.....	48
12.2 TEST PROCEDURE.....	48
12.3 TEST RESULT	49
13 RF EXPOSURE.....	53

4 General Information

4.1 General Description of E.U.T.

Product Name	: Mobile Phone
Model No.	: Majesty
Model Description	: N/A
GSM Band(s)	: GSM 850/900/1800/1900MHz
GPRS Class	: 12
WCDMA Band(s)	: FDD Band II/IV/V
Wi-Fi Specification	: 2.4G: 802.11b/g/n HT20/n HT40
Bluetooth Version	: Bluetooth v4.0 with BLE
GPS	: Support
NFC	: N/A
Hardware Version	: MX1081_MMI_V01
Software Version	: Majesty_V01

4.2 Details of E.U.T.

Operation Frequency	: GSM/GPRS 850: 824~849MHz PCS/GPRS1900: 1850~1910MHz WCDMA Band II: 1850~1910MHz WCDMA Band IV:1710~1755MHz WCDMA Band V: 824~849MHz WiFi: 802.11b/g/n HT20: 2412~2462MHz 802.11n HT40: 2422-2452MHz Bluetooth: 2402~2480MHz
Max. RF output power	: GSM 850: 32.91dBm PCS1900:29.74dBm WCDMA Band II: 22.45dBm WCDMA Band IV: 22.48dBm WCDMA Band V: 22.46dBm WiFi(2.4G): 9.49dBm Bluetooth: 6.23dBm
Type of Modulation	: GSM,GPRS: GMSK WCDMA: BPSK WiFi: CCK, OFDM Bluetooth: GFSK, Pi/4 DQPSK,8DPSK
Antenna installation	: GSM/WCDMA: internal permanent antenna WiFi/Bluetooth: internal permanent antenna

Antenna Gain	: GSM 850: 0.7dBi PCS1900: 1.3dBi WCDMA Band II: 1.3dBi WCDMA Band IV: 1.1dBi WCDMA Band V: 0.7dBi WiFi: 1.4dBi Bluetooth: 1.4dBi
Technical Data	: Battery DC 3.7V, 2200mAh DC 5V,1000mA, Charging form adapter (Adapter Input:100-240V~50/60Hz, 0.2A)
Adapter	: Manufacturer: SHENZHEN,THE SO JRCE PRECISINO TECHNOLOGY CO..LTD Model No.: M-100
Type of Emission	: GSM850: 248KGXW, PCS1900: 244KGXW WCDMA850: 4M21F9W, WCDMA1900: 4M19F9W WCDMA1700: 4M18F9W

4.3 Test Mode

All test mode(s) and condition(s) mentioned were considered and evaluated respectively by performing full tests, the worst data were recorded and reported.

Support Band	Test Mode	Channel Frequency	Channel Number
GSM 850	GSM/GPRS	824.2 MHz	128
		836.6 MHz	190
		848.8 MHz	251
PCS 1900	GSM/GPRS	1850.2 MHz	512
		1880.0 MHz	661
		1909.8 MHz	810
WCDMA Band V	WCDMA/HSUPA/HSDPA	826.4 MHz	4132
		836.6 MHz	4183
		846.6 MHz	4233
WCDMA Band II	WCDMA/HSUPA/HSDPA	1852.4MHz	9262
		1880.0MHz	9400
		1907.6MHz	9538
WCDMA Band IV	WCDMA/HSUPA/HSDPA	1712.4MHz	1313
		1732.6MHz	1413
		1752.6MHz	1512
Remark: All mode(s) were tested and the worst data was recorded.			

4.4 Test Facility

The test facility has a test site registered with the following organizations:

- IC – Registration No.: 7760A**
 Waltek Services(Shenzhen) Co., Ltd. Has been registered and fully described in a report filed with the Industry Canada. The acceptance letter from the Industry Canada is maintained in our files. Registration number 7760A, October 15, 2015.
- FCC Test Site 1#– Registration No.: 880581**
 Waltek Services(Shenzhen) Co., Ltd. EMC Laboratory `has been registered and fully described in a report filed with the (FCC) Federal Communications Commission. The acceptance letter from the FCC is maintained in our files. Registration 880581, April 29, 2014.
- FCC Test Site 2#– Registration No.: 328995**
 Waltek Services(Shenzhen) Co., Ltd. EMC Laboratory `has been registered and fully described in a report filed with the (FCC) Federal Communications Commission. The acceptance letter from the FCC is maintained in our files. Registration 328995, December 3, 2014.

5 Equipment Used during Test

5.1 Equipments List

RF Conducted Test						
Item	Equipment	Manufacturer	Model No.	Serial No.	Last Calibration Date	Calibration Due Date
1.	EMC Analyzer (9k~26.5GHz)	Agilent	E7405A	MY45114943	Aug.15,2015	Aug.14,2016
2.	Spectrum Analyzer (9k-6GHz)	R&S	FSL6	100959	Aug.15,2015	Aug.14,2016
3.	Humidity Chamber	GF	GTH-225-40-1P	IAA061213	Aug.15,2015	Aug.14,2016
4.	Universal Radio Communication Tester	R&S	CMU 200	112461	Apr.10,2015	Apr.09,2016
3m Semi-anechoic Chamber for Radiated Emissions						
Item	Equipment	Manufacturer	Model No.	Serial No.	Last Calibration Date	Calibration Due Date
1	EMC Analyzer	Agilent	E7405A	MY45114943	Sep.15,2015	Sep.14,2016
2	Active Loop Antenna	Beijing Dazhi	ZN30900A	-	Sep.15,2015	Sep.14,2016
3	Trilog Broadband Antenna	SCHWARZBECK	VULB9163	336	Apr.18,2015	Apr.17,2016
4	Coaxial Cable (below 1GHz)	Top	TYPE16(13M)	-	Sep.15,2015	Sep.14,2016
5	Broad-band Horn Antenna	SCHWARZBECK	BBHA 9120 D	667	Apr.18,2015	Apr.17,2016
6	Broad-band Horn Antenna	SCHWARZBECK	BBHA 9120 D	669	Apr.18,2015	Apr.17,2016
7	Broadband Preamplifier	COMPLIANCE DIRECTION	PAP-1G18	2004	Mar.17,2015	Mar.16,2016
8	Coaxial Cable (above 1GHz)	Top	1000MHz- 25GHz	EW02014-7	Apr.09,2015	Apr.08,2016
9	Broad-band Horn Antenna	SCHWARZBECK	BBHA 9170	335	Sep.15,2015	Sep.14,2016
10	Universal Radio Communication Tester	R&S	CMU 200	112461	Apr.10,2015	Apr.09,2016
11	Signal Generator	R&S	SMR20	100046	Sep.15,2015	Sep.14,2016

5.2 Measurement Uncertainty

Parameter	Uncertainty
Radio Frequency	$\pm 1 \times 10^{-6}$
RF Power	± 1.0 dB
RF Power Density	± 2.2 dB
Radiated Spurious Emissions test	± 5.03 dB (Bilog antenna 30M~1000MHz)
	± 5.47 dB (Horn antenna 1000M~25000MHz)
Conducted Spurious Emissions test	± 3.64 dB (AC mains 150KHz~30MHz)

5.3 Test Equipment Calibration

All the test equipments used are valid and calibrated by CEPREI Certification Body that address is No.110 Dongguan Zhuang RD. Guangzhou, P.R.China.

6 RF OUTPUT POWER

Test Requirement:	FCC Part 2.1046,22.913 (a),24.232 (c), 27.50(c.10); 27.50(d.4)
Test Method:	ANSI C63.4:2009, TIA/EIA-603-D:2010 KDB971168 D01 v02r02
Test Mode:	Transmitting

6.1 EUT Operation

Operating Environment :

Temperature:	22.5 °C
Humidity:	52.1 % RH
Atmospheric Pressure:	101.2kPa

6.2 Test Procedure

Conducted method:

The RF output of the transmitter was connected to the wireless test set and the spectrum analyzer through sufficient attenuation.

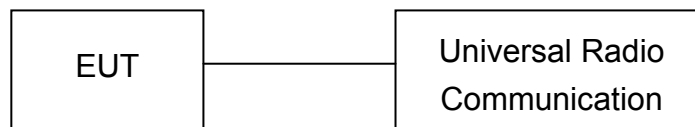

Radiated method:

1. The setup of EUT is according with per TIA/EIA Standard 603D and ANSI C63.4 measurement procedure.
2. The measurement antenna was placed at a distance of 3 meters from the EUT. During the tests, the antenna height and polarization as well as EUT azimuth were varied in order to identify the maximum level of emissions from the EUT. The test was performed by placing the EUT on 3-orthogonal axis.
3. The frequency range up to tenth harmonic of the fundamental frequency was investigated.
4. Remove the EUT and replace it with substitution antenna. A signal generator was connected to the substitution antenna by a non-radiating cable. The absolute levels of the spurious emissions were measured by the substitution.

6.3 Test Result

Conducted Power						
GSM - Burst Average Power (dBm)						
Band	GSM850			PCS1900		
Channel	128	190	251	512	661	810
Frequency (MHz)	824.2	836.6	848.8	1850.2	1880	1909.8
GSM	32.53	32.72	32.91	29.74	29.65	29.36
GPRS (1 slot)	32.49	32.70	32.91	29.73	29.65	29.39
GPRS (2 slots)	31.62	31.81	32.03	29.20	29.15	28.83
GPRS (3 slots)	29.72	29.91	30.11	27.59	27.56	27.27
GPRS (4 slots)	28.59	28.79	28.96	26.33	26.27	25.99

WCDMA - Average Power (dBm)									
Band	WCDMA Band II			WCDMA Band V			WCDMA Band IV		
Channel	9262	9400	9538	4132	4183	4233	1313	1413	1512
Frequency (MHz)	1852.4	1880	1907.6	826.4	836.6	846.6	1712.4	1732.6	1752.6
RMC 12.2k	22.33	22.44	22.45	22.32	22.46	22.27	22.26	22.48	22.28
HSDPA Subtest-1	21.84	21.85	21.38	21.22	21.34	21.14	21.27	21.43	21.23
HSDPA Subtest-2	21.61	21.43	21.25	21.54	21.29	21.80	21.52	21.33	21.78
HSDPA Subtest-3	21.74	21.68	21.32	21.24	21.61	21.20	21.26	21.60	21.33
HSDPA Subtest-4	21.13	21.16	21.12	21.19	21.33	21.09	21.20	21.42	21.10
HSUPA Subtest-1	21.80	21.84	21.43	21.18	21.37	21.15	21.30	21.42	21.23
HSUPA Subtest-2	21.11	21.09	21.82	21.09	21.30	21.42	21.23	21.32	21.50
HSUPA Subtest-3	21.86	21.21	21.54	21.08	21.24	21.47	21.18	21.28	21.46
HSUPA Subtest-4	21.44	21.18	21.18	21.14	21.16	21.11	21.22	21.14	21.12
HSUPA Subtest-5	21.79	21.32	21.41	21.31	21.26	21.19	21.36	21.25	21.23

Radiated Power(Measured at max. conducted power channel)

ERP and EIRP

Cellular Band (Part 22H)

Frequency	Receiver Reading	Turn table Angle	RX Antenna		Substituted			Absolute Level	Part 22H	
			Height	Polar	SG Level	Cable	Antenna Gain		Limit	Margin
(MHz)	(dB μ V)	Degree	(m)	(H/V)	(dBm)	(dB)	(dB)	(dBm)	(dBm)	(dB)
GSM 850 Channel 128										
824.20	91.77	185	1.1	H	24.74	0.20	0.00	24.54	38.45	-13.91
824.20	97.93	203	1.4	V	30.83	0.20	0.00	30.63	38.45	-7.82
GSM 850 Channel 190										
836.60	93.75	171	2.4	H	26.72	0.20	0.00	26.52	38.45	-11.93
836.60	97.15	94	1.3	V	30.05	0.20	0.00	29.85	38.45	-8.60
GSM 850 Channel 251										
848.80	91.47	166	1.4	H	24.44	0.20	0.00	24.24	38.45	-14.21
848.80	98.47	261	1.5	V	31.37	0.20	0.00	31.17	38.45	-7.28
GPRS 850 Channel 128										
824.20	91.84	37	2.1	H	24.81	0.20	0.00	24.61	38.45	-13.84
824.20	97.12	277	1.4	V	30.02	0.20	0.00	29.82	38.45	-8.63
GPRS 850 Channel 190										
836.60	92.73	305	1.9	H	25.70	0.20	0.00	25.50	38.45	-12.95
836.60	97.86	283	1.5	V	30.76	0.20	0.00	30.56	38.45	-7.89
GPRS 850 Channel 251										
848.80	93.73	95	2.1	H	26.70	0.20	0.00	26.50	38.45	-11.95
848.80	98.86	191	1.3	V	31.76	0.20	0.00	31.56	38.45	-6.89

Frequency	Receiver Reading	Turn table Angle	RX Antenna		Substituted			Absolute Level	Part 22H	
			Height	Polar	SG Level	Cable	Antenna Gain		Limit	Margin
(MHz)	(dBμV)	Degree	(m)	(H/V)	(dBm)	(dB)	(dB)	(dBm)	(dBm)	(dB)
WCDMA Band V Voice Channel 4132										
826.40	78.63	189	1.2	H	11.60	0.20	0.00	11.40	38.45	-27.05
826.40	84.36	87	1.3	V	17.26	0.20	0.00	17.06	38.45	-21.39
WCDMA Band V Voice Channel 4183										
836.60	78.30	107	1.2	H	11.27	0.20	0.00	11.07	38.45	-27.38
836.60	85.89	102	2.5	V	18.79	0.20	0.00	18.59	38.45	-19.86
WCDMA Band V Voice Channel 4233										
846.60	77.50	240	2.2	H	10.47	0.20	0.00	10.27	38.45	-28.18
846.60	84.33	221	1.7	V	17.23	0.20	0.00	17.03	38.45	-21.42
WCDMA Band V HSDPA Channel 4132										
826.40	78.03	287	1.7	H	11.00	0.20	0.00	10.80	38.45	-27.65
826.40	84.62	79	1.6	V	17.52	0.20	0.00	17.32	38.45	-21.13
WCDMA Band V HSDPA Channel 4183										
836.60	76.13	192	2.2	H	9.10	0.20	0.00	8.90	38.45	-29.55
836.60	84.07	102	1.3	V	16.97	0.20	0.00	16.77	38.45	-21.68
WCDMA Band V HSDPA Channel 4233										
846.60	81.24	132	1.7	H	14.21	0.20	0.00	14.01	38.45	-24.44
846.60	85.73	44	1.9	V	18.63	0.20	0.00	18.43	38.45	-20.02
WCDMA Band V HSUPA Channel 4132										
826.40	79.24	191	1.9	H	12.21	0.20	0.00	12.01	38.45	-26.44
826.40	84.56	72	1.4	V	17.46	0.20	0.00	17.26	38.45	-21.19
WCDMA Band V HSUPA Channel 4183										
836.60	78.27	347	1.5	H	11.24	0.20	0.00	11.04	38.45	-27.41
836.60	84.21	308	1.5	V	17.11	0.20	0.00	16.91	38.45	-21.54
WCDMA Band V HSUPA Channel 4233										
846.60	80.12	138	1.8	H	13.09	0.20	0.00	12.89	38.45	-25.56
846.60	86.27	136	1.5	V	19.17	0.20	0.00	18.97	38.45	-19.48

Cellular Band (Part 24E)

Frequency	Receiver Reading	Turn table Angle	RX Antenna		Substituted			Absolute Level	Part 24E	
			Height	Polar	SG Level	Cable	Antenna Gain		Limit	Margin
(MHz)	(dB μ V)	Degree	(m)	(H/V)	(dBm)	(dB)	(dB)	(dBm)	(dBm)	(dB)
PCS 1900 Channel 512										
1850.20	89.25	58	2.2	H	15.28	0.31	10.40	25.37	33	-7.63
1850.20	94.05	56	1.8	V	20.77	0.31	10.40	30.86	33	-2.14
PCS 1900 Channel 661										
1880.00	86.71	206	1.6	H	12.86	0.31	10.40	22.95	33	-10.05
1880.00	92.67	49	1.2	V	19.55	0.31	10.40	29.64	33	-3.36
PCS 1900 Channel 810										
1909.80	85.27	352	1.6	H	11.54	0.32	10.40	21.62	33	-11.38
1909.80	92.11	100	1.8	V	19.15	0.32	10.40	29.23	33	-3.77
GPRS 1900 Channel 512										
1850.20	87.58	252	1.8	H	13.61	0.31	10.40	23.70	33	-9.30
1850.20	94.24	241	2.2	V	20.96	0.31	10.40	31.05	33	-1.95
GPRS 1900 Channel 661										
1880.00	85.25	261	2.0	H	11.40	0.31	10.40	21.49	33	-11.51
1880.00	92.48	45	2.1	V	19.36	0.31	10.40	29.45	33	-3.55
GPRS 1900 Channel 810										
1909.80	86.57	134	1.4	H	12.84	0.32	10.40	22.92	33	-10.08
1909.80	92.41	53	1.0	V	19.45	0.32	10.40	29.53	33	-3.47

Frequency	Receiver Reading	Turn table Angle	RX Antenna		Substituted			Absolute Level	Part 24E	
			Height	Polar	SG Level	Cable	Antenna Gain		Limit	Margin
(MHz)	(dB μ V)	Degree	(m)	(H/V)	(dBm)	(dB)	(dB)	(dBm)	(dBm)	(dB)
WCDMA Band II Voice Channel 9262										
1852.40	77.50	114	2.2	H	3.53	0.31	10.40	13.62	33	-19.38
1852.40	85.67	5	1.9	V	12.39	0.31	10.40	22.48	33	-10.52
WCDMA Band II Voice Channel 9400										
1880.00	79.72	159	1.1	H	5.87	0.31	10.40	15.96	33	-17.04
1880.00	84.88	117	2.4	V	11.76	0.31	10.40	21.85	33	-11.15
WCDMA Band II Voice Channel 9538										
1907.60	77.50	299	1.3	H	3.77	0.32	10.40	13.85	33	-19.15
1907.60	84.15	89	2.2	V	11.19	0.32	10.40	21.27	33	-11.73
WCDMA Band II HSDPA Channel 9262										
1852.40	78.34	57	1.2	H	4.37	0.31	10.40	14.46	33	-18.54
1852.40	84.59	50	1.8	V	11.31	0.31	10.40	21.40	33	-11.60
WCDMA Band II HSDPA Channel 9400										
1880.00	78.41	18	1.2	H	4.56	0.31	10.40	14.65	33	-18.35
1880.00	86.30	153	1.6	V	13.18	0.31	10.40	23.27	33	-9.73
WCDMA Band II HSDPA Channel 9538										
1907.60	78.57	143	1.9	H	4.84	0.32	10.40	14.92	33	-18.08
1907.60	84.92	215	2.0	V	11.96	0.32	10.40	22.04	33	-10.96
WCDMA Band II HSUPA Channel 9262										
1852.40	77.29	244	1.8	H	3.32	0.31	10.40	13.41	33	-19.59
1852.40	84.21	48	1.6	V	10.93	0.31	10.40	21.02	33	-11.98
WCDMA Band II HSUPA Channel 9400										
1880.00	76.28	101	2.4	H	2.43	0.31	10.40	12.52	33	-20.48
1880.00	84.48	227	1.9	V	11.36	0.31	10.40	21.45	33	-11.55
WCDMA Band II HSUPA Channel 9538										
1907.60	81.04	157	2.5	H	7.31	0.32	10.40	17.39	33	-15.61
1907.60	85.58	285	1.8	V	12.62	0.32	10.40	22.70	33	-10.30

Frequency	Receiver Reading	Turn table Angle	RX Antenna		Substituted			Absolute Level	Part 27	
			Height	Polar	SG Level	Cable	Antenna Gain		Limit	Margin
(MHz)	(dB μ V)	Degree	(m)	(H/V)	(dBm)	(dB)	(dB)	(dBm)	(dBm)	(dB)
WCDMA Band IV Voice Channel 1313										
1712.40	76.51	132	1.9	H	2.98	0.30	9.40	12.08	30	-17.92
1712.40	84.22	87	1.6	V	10.74	0.30	9.40	19.84	30	-10.16
WCDMA Band IV Voice Channel 1413										
1732.60	78.54	307	1.7	H	5.04	0.30	9.40	14.14	30	-15.86
1732.60	84.18	213	1.4	V	10.72	0.30	9.40	19.82	30	-10.18
WCDMA Band IV Voice Channel 1512										
1752.60	77.34	25	2.2	H	3.85	0.30	9.40	12.95	30	-17.05
1752.60	84.29	128	1.1	V	10.84	0.30	9.40	19.94	30	-10.06
WCDMA Band IV HSDPA Channel 1313										
1712.40	77.59	309	1.4	H	4.06	0.30	9.40	13.16	30	-16.84
1712.40	84.52	20	2.1	V	11.04	0.30	9.40	20.14	30	-9.86
WCDMA Band IV HSDPA Channel 1413										
1732.60	76.30	126	1.1	H	2.80	0.30	9.40	11.90	30	-18.10
1732.60	84.18	32	2.0	V	10.72	0.30	9.40	19.82	30	-10.18
WCDMA Band IV HSDPA Channel 1512										
1752.60	77.43	51	1.1	H	3.94	0.30	9.40	13.04	30	-16.96
1752.60	84.73	6	1.2	V	11.28	0.30	9.40	20.38	30	-9.62
WCDMA Band IV HSUPA Channel 1313										
1712.40	79.37	320	1.9	H	5.84	0.30	9.40	14.94	30	-15.06
1712.40	84.07	251	1.3	V	10.59	0.30	9.40	19.69	30	-10.31
WCDMA Band IV HSUPA Channel 1413										
1732.60	78.47	352	1.8	H	4.97	0.30	9.40	14.07	30	-15.93
1732.60	84.01	180	2.3	V	10.55	0.30	9.40	19.65	30	-10.35
WCDMA Band IV HSUPA Channel 1512										
1752.60	79.20	201	1.8	H	5.71	0.30	9.40	14.81	30	-15.19
1752.60	84.39	332	2.3	V	10.94	0.30	9.40	20.04	30	-9.96

7 Peak-to-Average Ratio

Test Requirement:	24.232 (d)
Test Method:	N/A
Test Mode:	Transmitting

7.1 EUT Operation

Operating Environment :

Temperature:	22.5 °C
Humidity:	52.3% RH
Atmospheric Pressure:	101.2kPa

7.2 Test Procedure

1. The EUT was connected to spectrum analyzer and system simulator via a power divider.
2. Set EUT to transmit at maximum output power.
3. When the duty cycle is less than 98%, then signal gating will be implemented on the spectrum analyzer by triggering from the system simulator.
4. Set the CCDF (Complementary Cumulative Distribution Function) option of the spectrum analyzer. Record the maximum PAPR level associated with a probability of 0.1%.

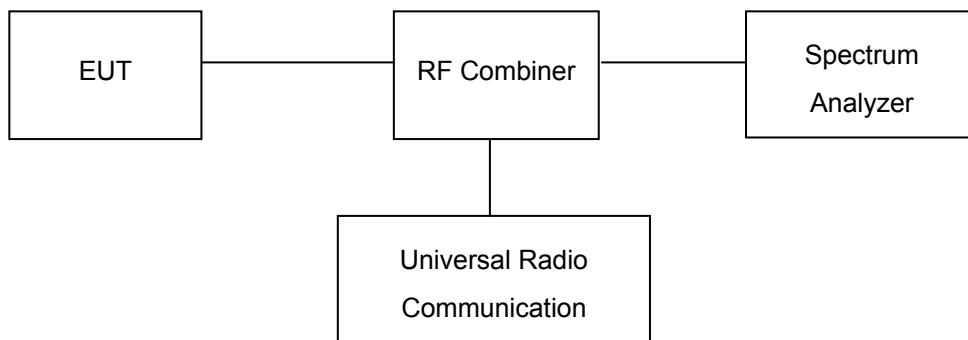

7.3 Test Result

Cellular Band (Part 24E)

Mode	PCS 1900			WCDMA Band II			WCDMA Band IV			Limit (dB)
Channel	512	661	810	9262	9400	9538	1313	1413	1512	
Frequency (MHz)	1850.2	1880.0	1909.8	1852.4	1880.0	1907.6	1712.4	1732.6	1752.6	
Peak-to-Average Ratio (dB)	10.14	10.12	10.07	3.05	3.07	3.06	3.06	3.10	3.14	13

Test Plots (Part 24E)

PCS1900 Middle Channel

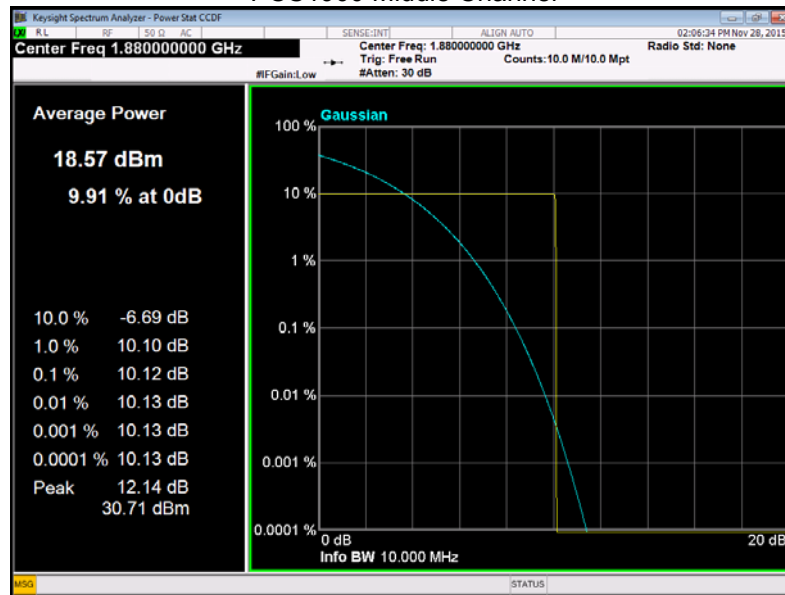

WCDMA Band II Middle Channel

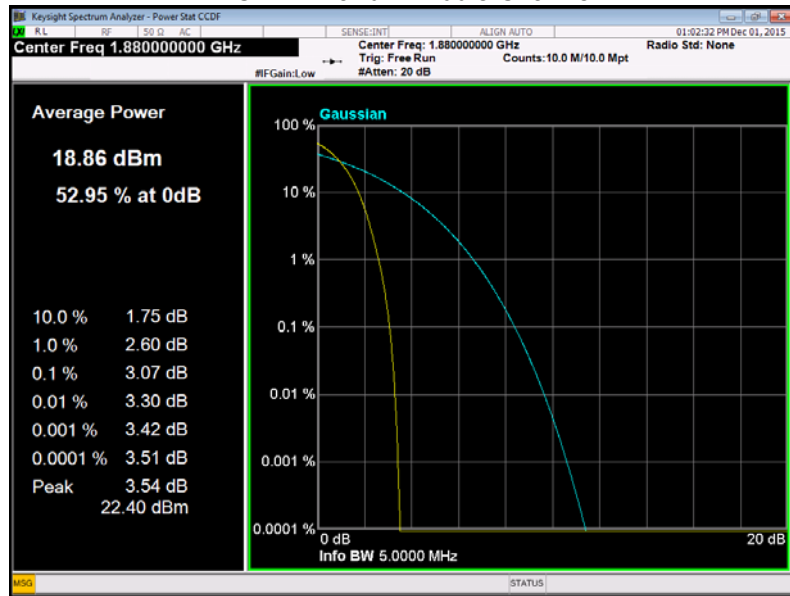

WCDMA Band IV Middle Channel

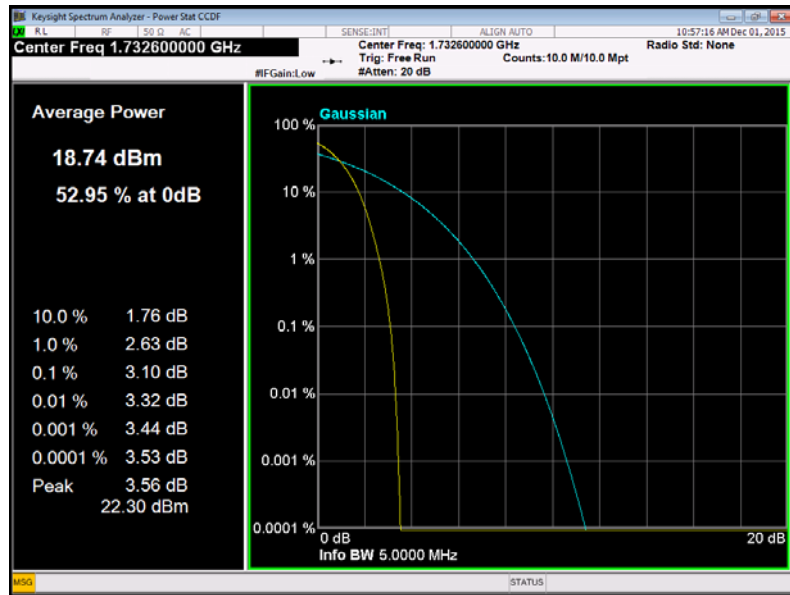

8 BANDWIDTH

Test Requirement: FCC Part 2.1049,22.917,22.905,24.238,27.53(a)

Test Method: ANSI C63.4:2009, TIA/EIA-603-D:2010

KDB971168 D01 v02r02

Test Mode: Transmitting

8.1 EUT Operation

Operating Environment :

Temperature: 22.5 °C

Humidity: 52.3% RH

Atmospheric Pressure: 101.2kPa

8.2 Test Procedure

The RF output of the transmitter was connected to the wireless test set and the spectrum analyzer through sufficient attenuation.

The resolution bandwidth of the spectrum analyzer was set at 3 kHz (Cellular /PCS) and the 26 dB & 99%bandwidth was recorded.

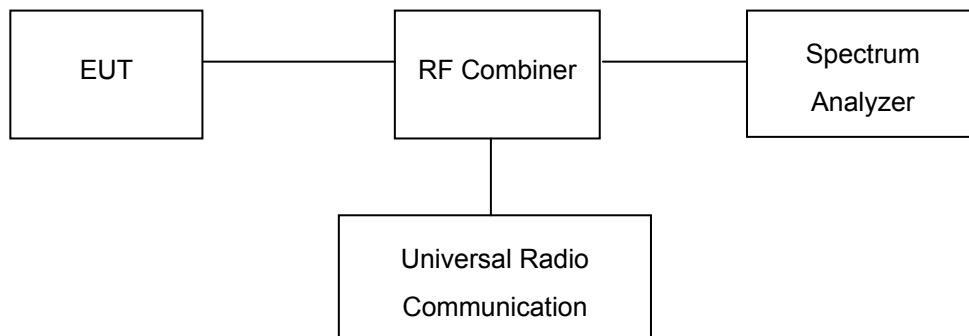

8.3 Test Result

Cellular Band (Part 22H)

Test Mode	Channel	Frequency (MHz)	99% Occupied Bandwidth(kHz)	26 dB Emission Bandwidth(kHz)
GSM 850	128	824.2	245.13	317.60
	190	836.6	245.07	317.60
	251	848.8	245.15	317.59
GPRS 850	128	824.2	247.76	317.31
	190	836.6	247.79	317.30
	251	848.8	247.85	317.35

Test Mode	Channel	Frequency (MHz)	99% Occupied Bandwidth(MHz)	26 dB Emission Bandwidth(MHz)	
WCDMA Band V	RMC12.2k	4132	826.4	4.18	4.58
		4183	836.6	4.17	4.63
		4233	846.6	4.18	4.60
	HSDPA(16QAM)	4132	826.4	4.09	4.59
		4183	836.6	4.15	4.64
		4233	846.6	4.16	4.71
	HSUPA(BPSK)	4132	826.4	4.11	4.61
		4183	836.6	4.15	4.64
		4233	846.6	4.21	4.65

Cellular Band (Part 24E)

Test Mode	Channel	Frequency (MHz)	99% Occupied Bandwidth(kHz)	26 dB Emission Bandwidth(kHz)
PCS 1900	512	1850.20	243.53	307.63
	661	1880.00	243.58	307.70
	810	1909.80	243.54	307.66
GPRS 1900	512	1850.20	243.95	303.79
	661	1880.00	243.87	303.80
	810	1909.80	243.94	303.73

Test Mode	Channel	Frequency (MHz)	99% Occupied Bandwidth(MHz)	26 dB Emission Bandwidth(MHz)	
WCDMA Band II	RMC12.2k	9262	1852.40	4.19	4.60
		9400	1880.00	4.16	4.61
		9538	1907.60	4.09	4.62
	HSDPA(16QAM)	9262	1852.40	4.16	4.68
		9400	1880.00	4.17	4.64
		9538	1907.60	4.12	4.70
	HSUPA(BPSK)	9262	1852.40	4.11	4.69
		9400	1880.00	4.16	4.63
		9538	1907.60	4.13	4.60

Test Mode	Channel	Frequency (MHz)	99% Occupied Bandwidth(MHz)	26 dB Emission Bandwidth(MHz)	
WCDMA Band IV	RMC12.2k	1313	1712.6	4.10	4.72
		1413	1732.6	4.16	4.64
		1512	1752.4	4.16	4.59
	HSDPA	1313	1712.6	4.09	4.65
		1413	1732.6	4.16	4.66
		1512	1752.4	4.13	4.65
	HSUPA	1313	1712.6	4.14	4.68
		1413	1732.6	4.16	4.65
		1512	1752.4	4.18	4.64

Test Plots
 Cellular Band (Part 22H)
 GSM 850

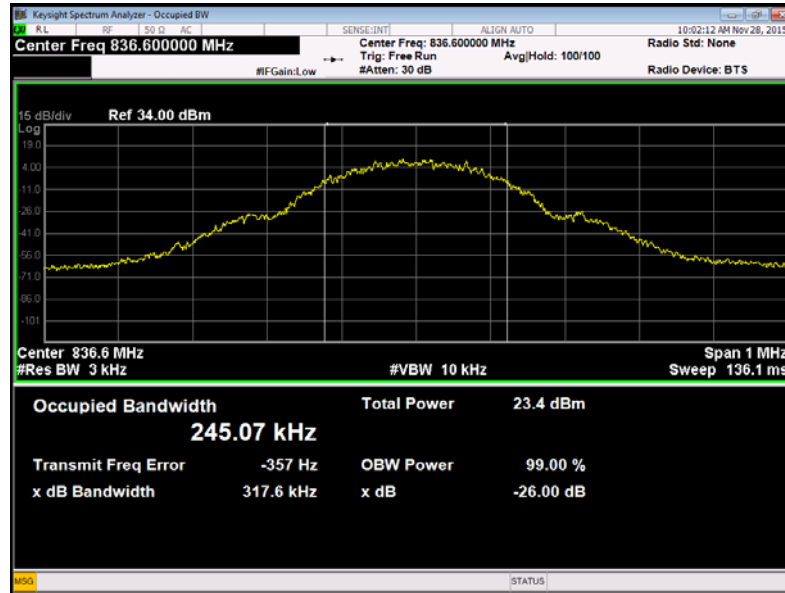

GPRS 850

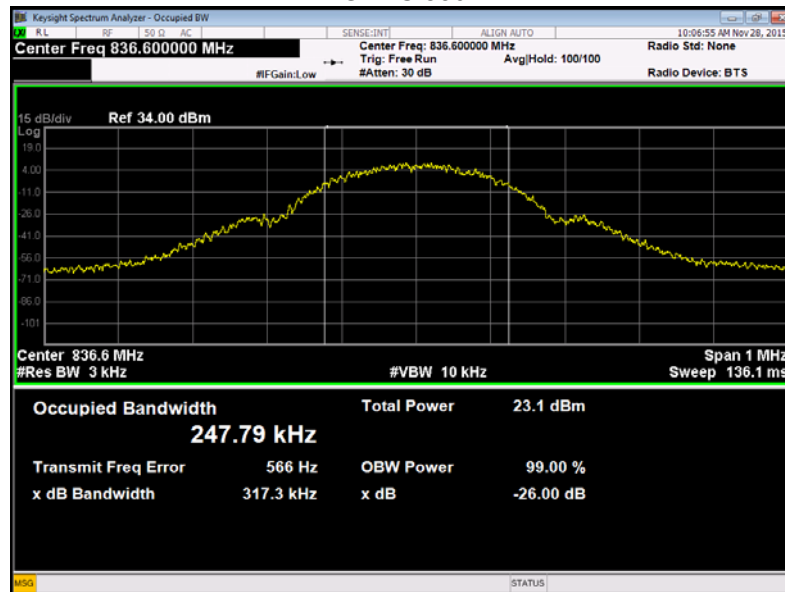

WCDMA band V

RMC12.2k

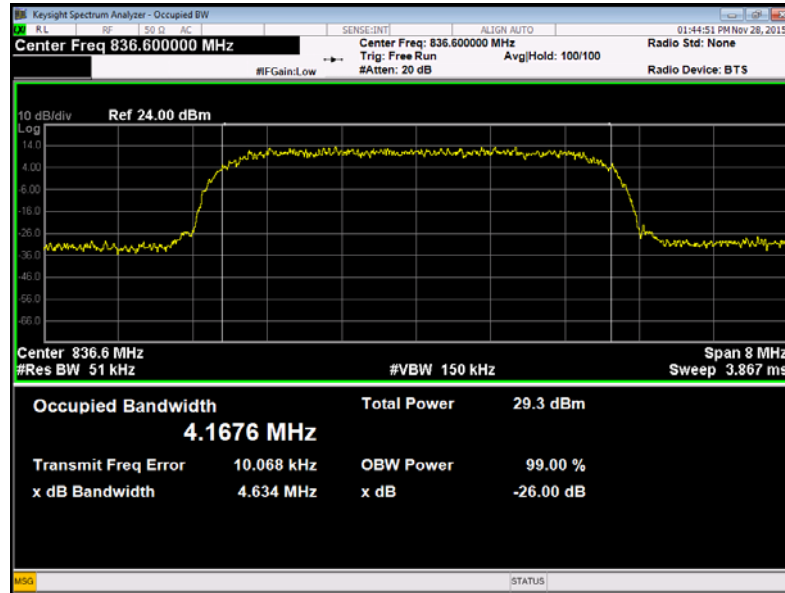

HSDPA

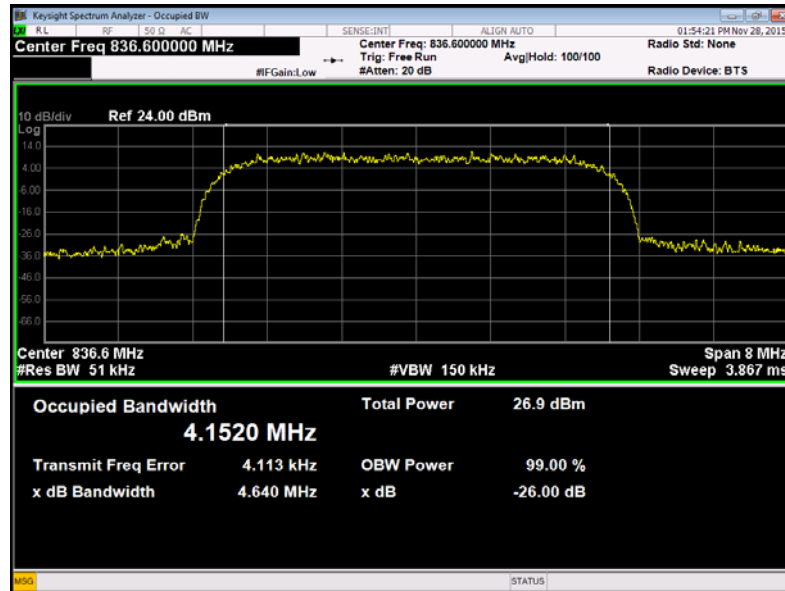

HSUPA

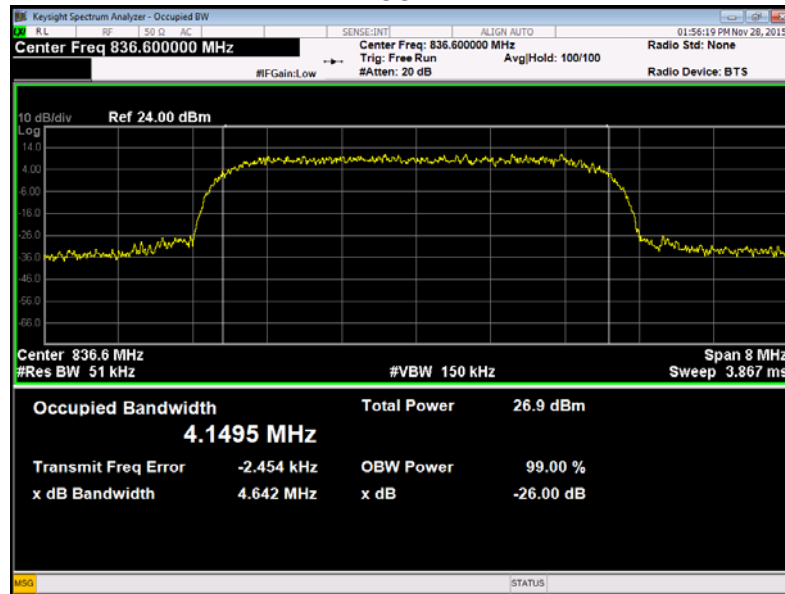

Cellular Band (Part 24E)

PCS 1900

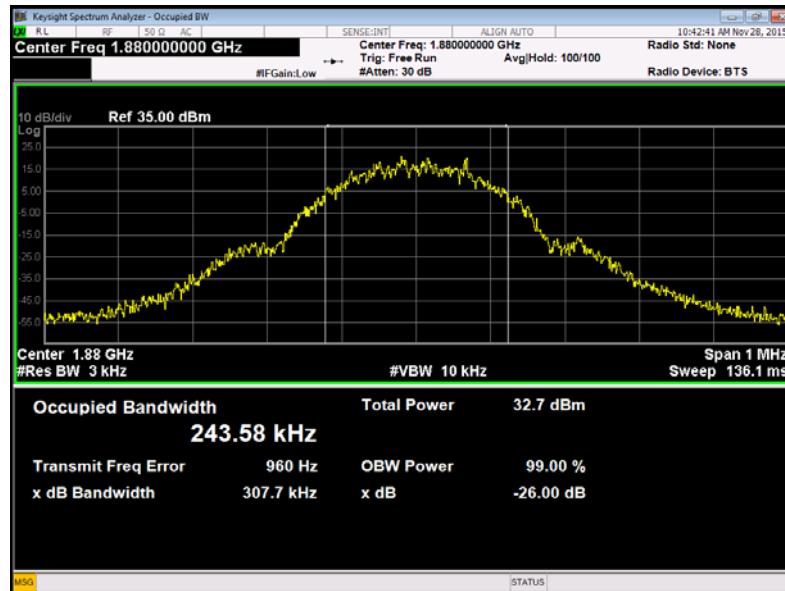

GPRS 1900

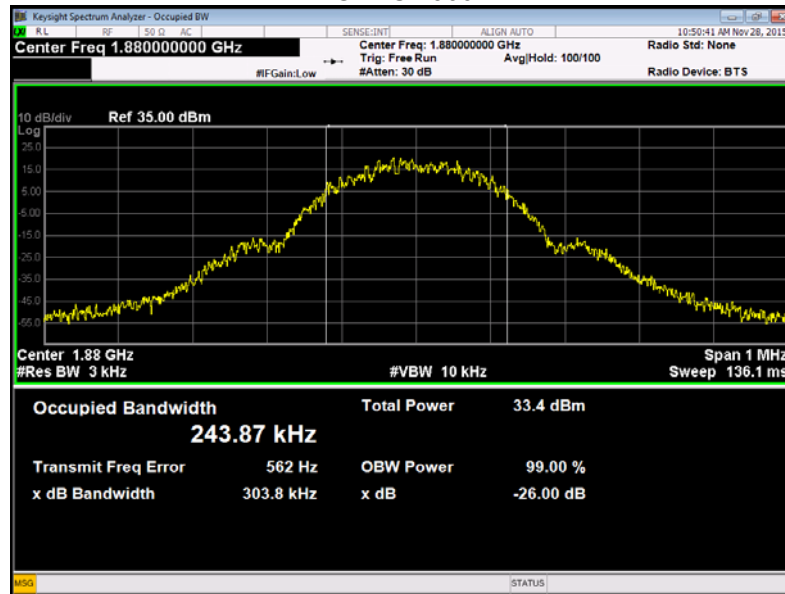

WCDMA band II

RMC12.2k

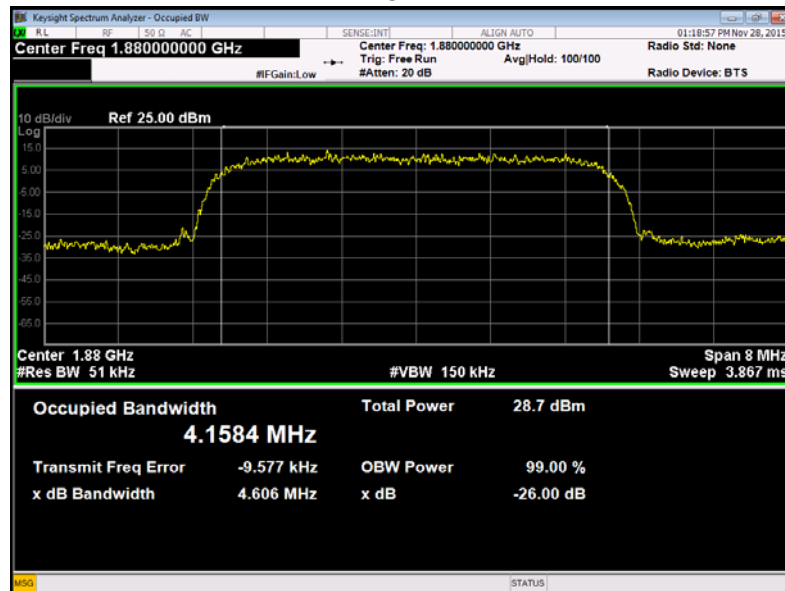

HSDPA

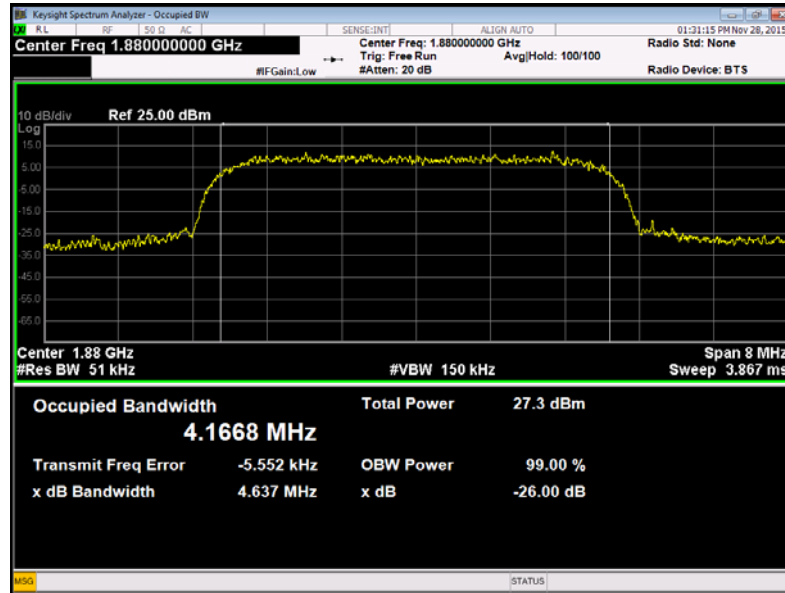

HSUPA

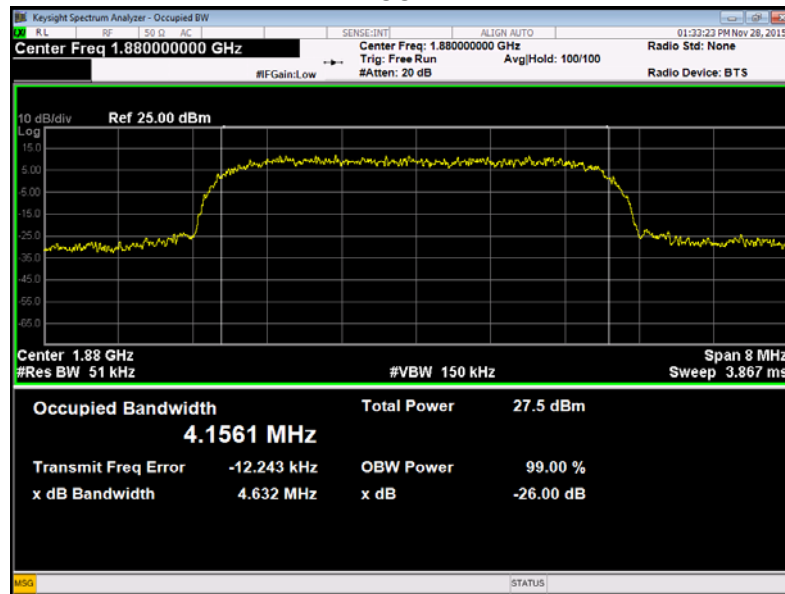

(Part 27)
 WCDMA band IV
 RMC12.2k

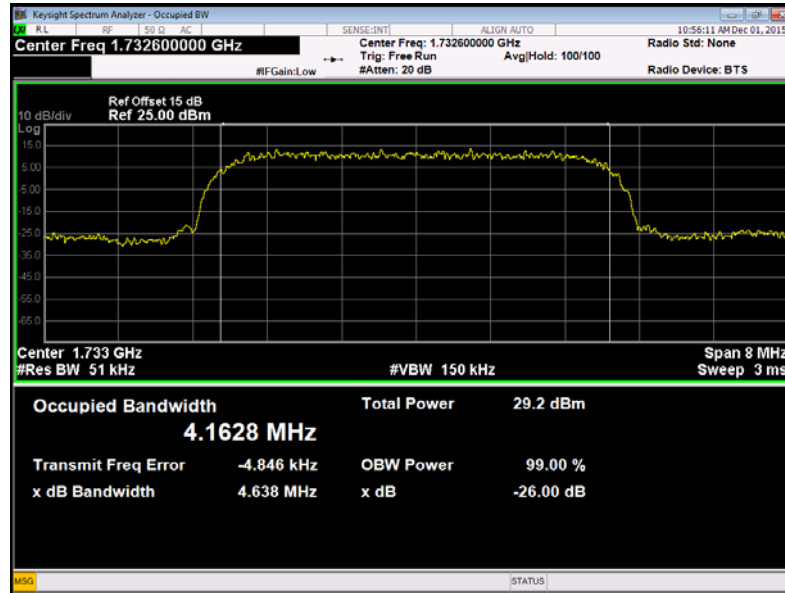

HSDPA

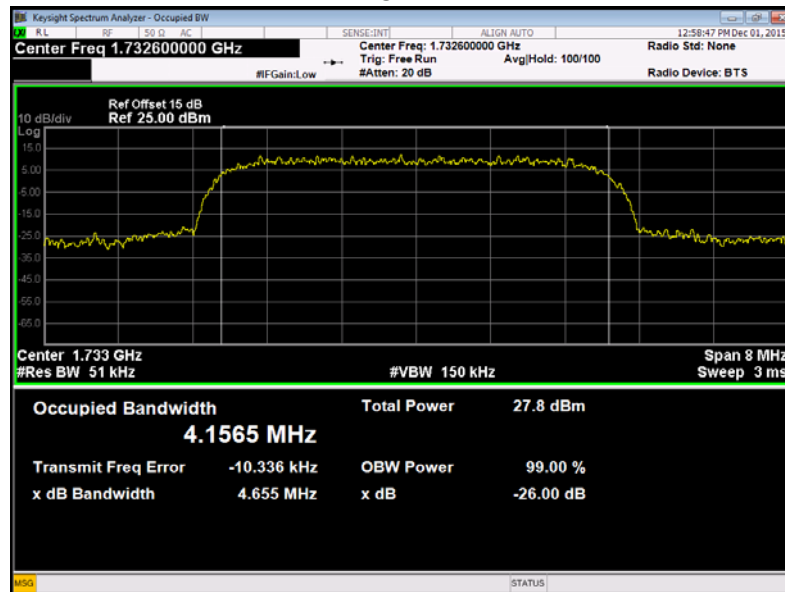

HSUPA

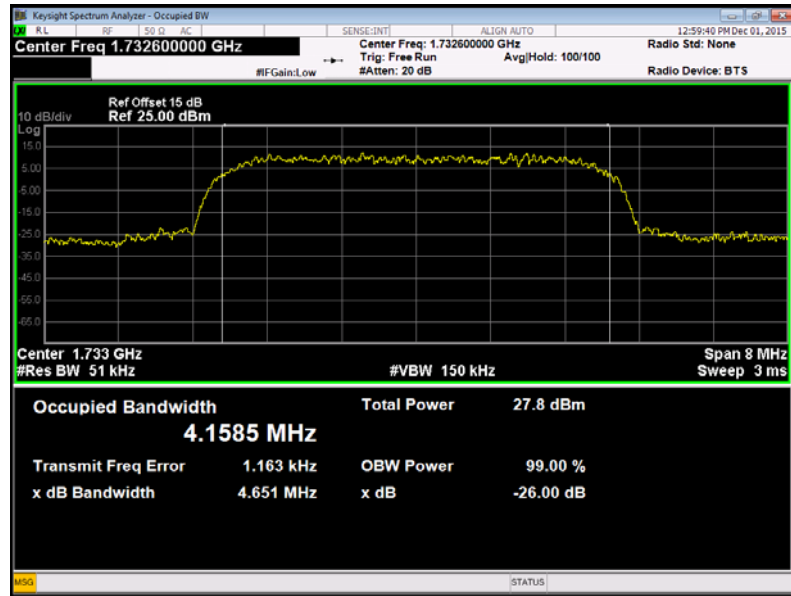

9 SPURIOUS EMISSIONS AT ANTENNA TERMINALS

Test Requirement: FCC Part 2.1051,22.917(a),24.238(a), 27.53(h)

Test Method: ANSI C63.4:2009, TIA/EIA-603-D:2010
KDB971168 D01 v02r02

Test Mode: Transmitting

9.1 EUT Operation

Operating Environment :

Temperature: 23.5 °C

Humidity: 52.1 % RH

Atmospheric Pressure: 101.3kPa

9.2 Test Procedure

The RF output of the transceiver was connected to a spectrum analyzer and simulator through appropriate attenuation. The resolution bandwidth of the spectrum analyzer was set at 1MHz. Sufficient scans were taken to show any out of band emissions up to 10th harmonics.

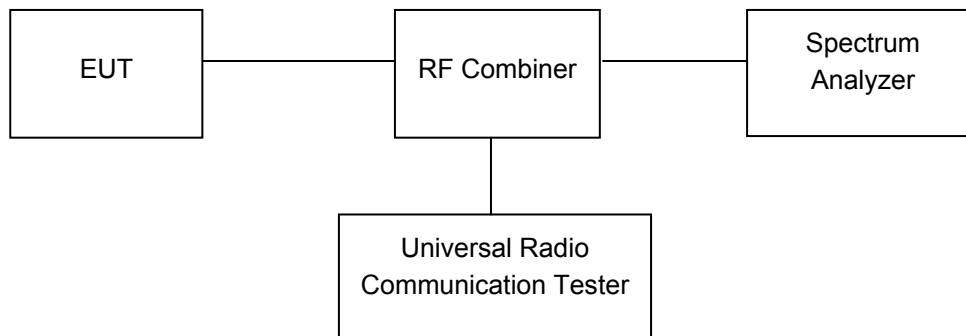

9.3 Test Result

Remark: only the worst data were recorded.

Cellular Band (Part 22H)

GSM 850 - channel 128

30MHz-1GHz

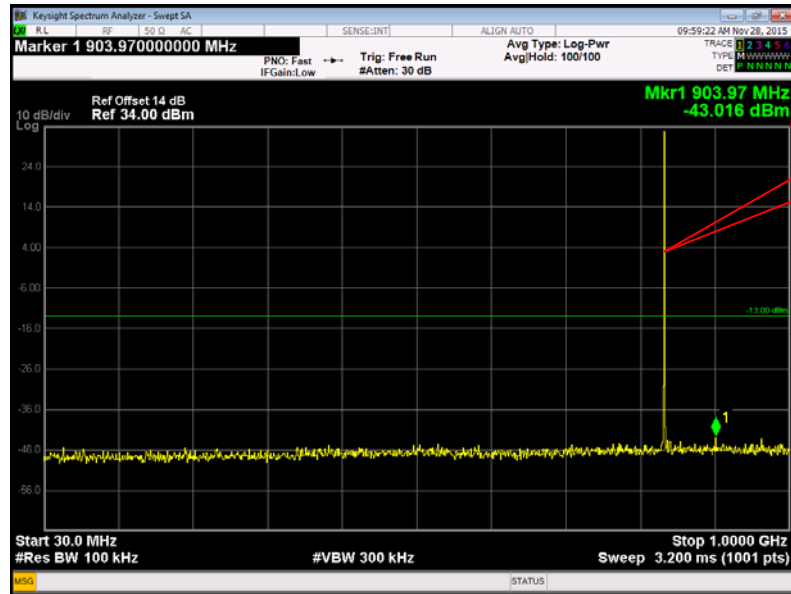

Above 1GHz

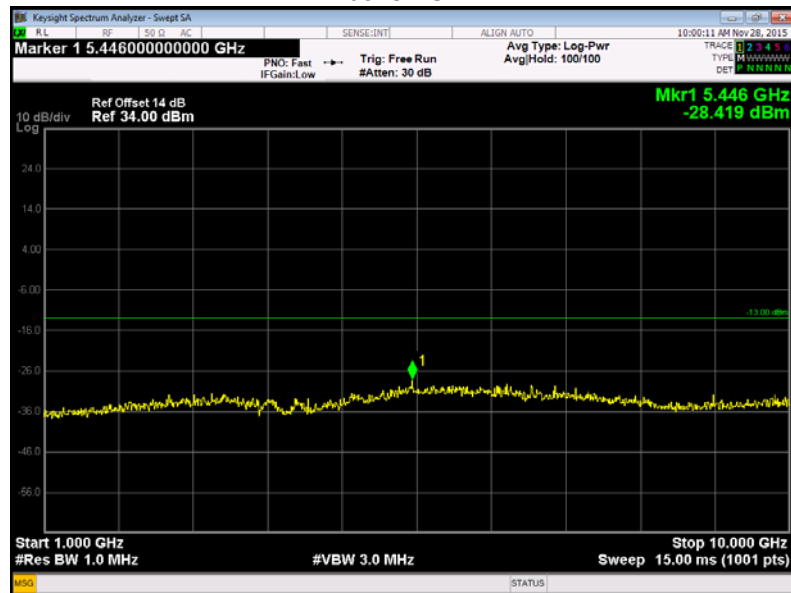

WCDMA band V - channel 4233
30MHz-1GHz

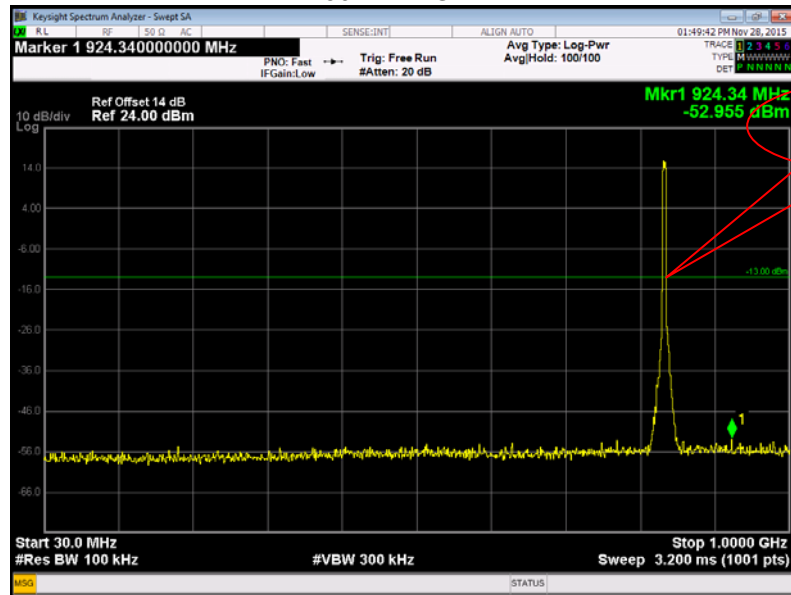

Fundamental

Above 1GHz

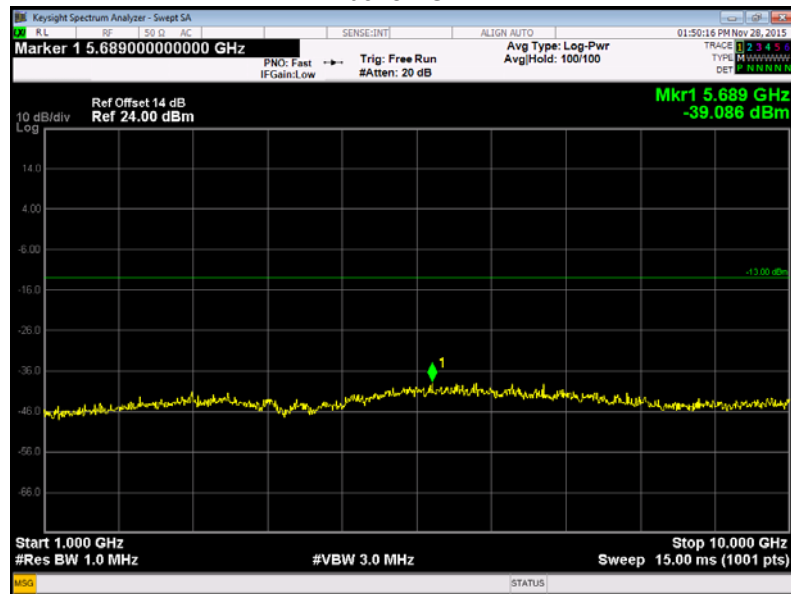

Cellular Band (Part 24E)
PCS 1900 - channel 512
30MHz-1GHz

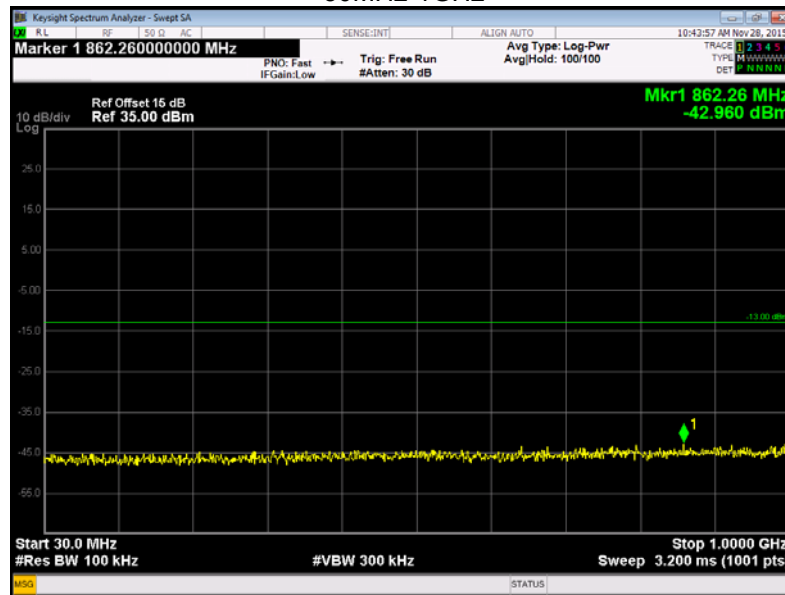

Above 1GHz

Fundamental



WCDMA band II - channel 9400
30MHz-1GHz

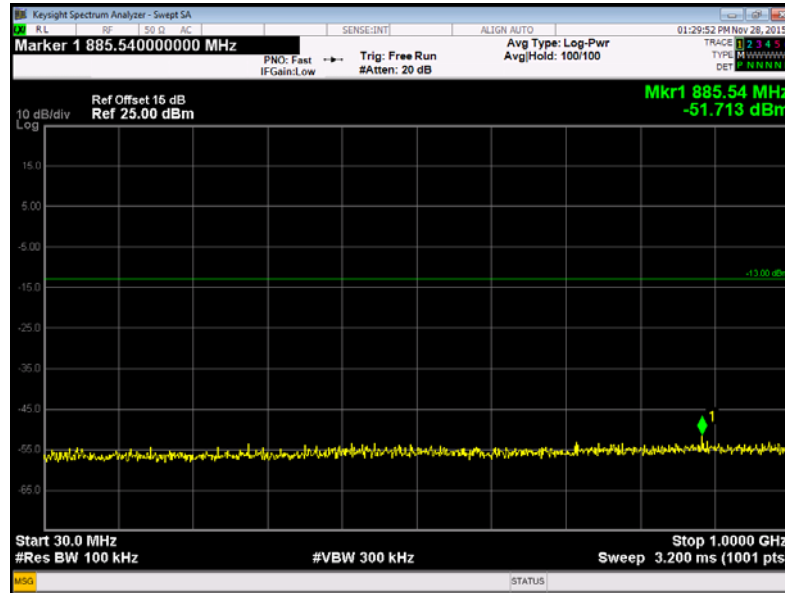

Above 1GHz

Fundamental



(Part 27)

WCDMA band IV - channel 1313

30MHz-1GHz

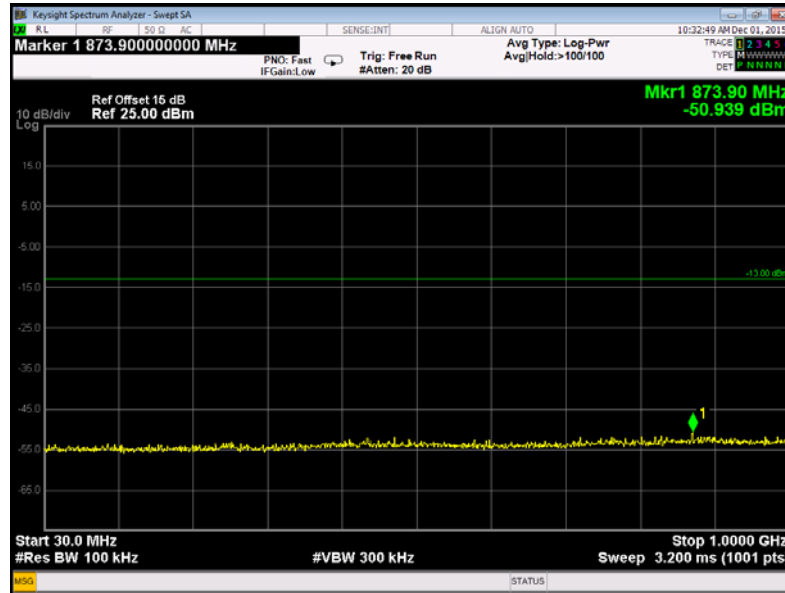

Above 1GHz

Fundamental



10 SPURIOUS RADIATED EMISSIONS

Test Requirement: FCC Part 2.1053,22.917,24.238,27.53(h)

Test Method: ANSI C63.4:2009, TIA/EIA-603-D:2010

KDB971168 D01 v02r02

Test Mode: Transmitting

10.1 EUT Operation

Operating Environment :

Temperature: 23.5 °C

Humidity: 52.1 % RH

Atmospheric Pressure: 101.2kPa

10.2 Test Setup

The radiated emission tests were performed in the 3m Semi- Anechoic Chamber test site, using the setup accordance with the ANSI C63.4.

The test setup for emission measurement from 30 MHz to 1 GHz.

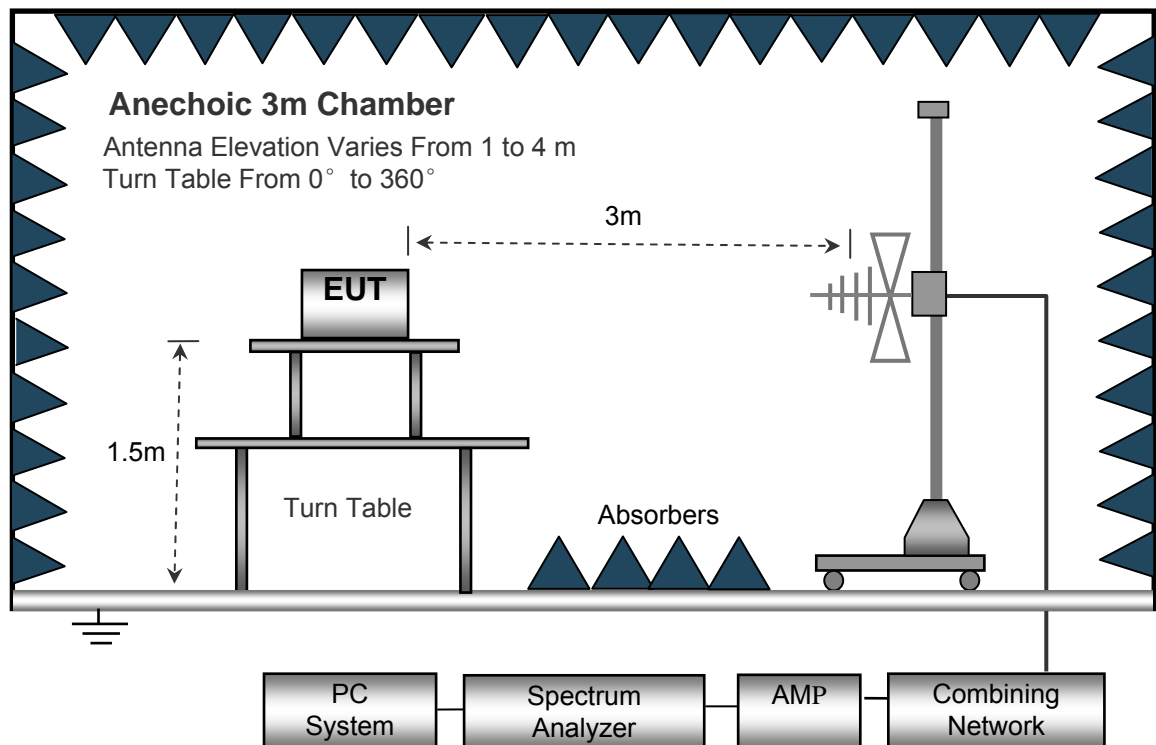

The test setup for emission measurement above 1 GHz.

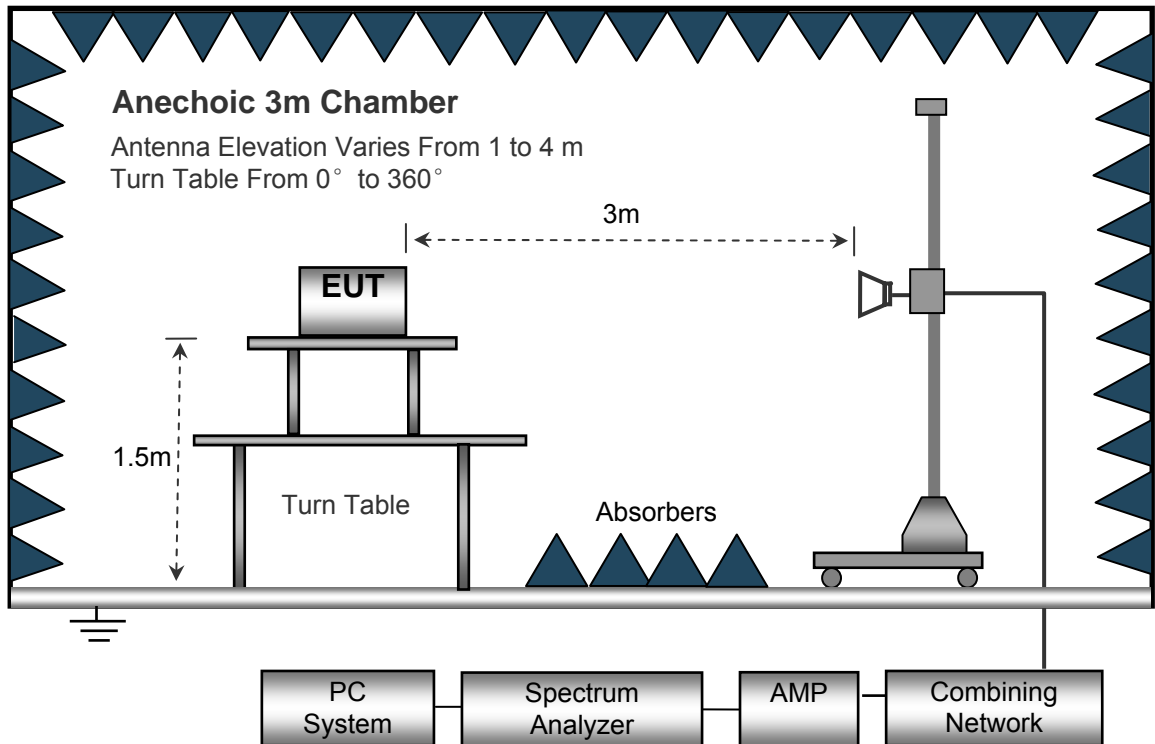

10.3 Spectrum Analyzer Setup

30MHz ~ 1GHz

Sweep Speed Auto
 Detector PK
 Resolution Bandwidth..... 100kHz
 Video Bandwidth..... 300kHz

Above 1GHz

Sweep Speed Auto
 Detector PK
 Resolution Bandwidth..... 1MHz
 Video Bandwidth..... 3MHz
 Detector Ave.
 Resolution Bandwidth..... 1MHz
 Video Bandwidth..... 10Hz

10.4 Test Procedure

1. The EUT is placed on a turntable, which is 1.5m above ground plane.
2. The turntable shall be rotated for 360 degrees to determine the position of maximum emission level.
3. EUT is set 3m away from the receiving antenna, which is moved from 1m to 4m to find out the maximum emissions. The spectrum was investigated from 30MHz up to the tenth harmonic of the highest fundamental frequency.
4. Maximum procedure was performed on the six highest emissions to ensure EUT compliance.
5. And also, each emission was to be maximized by changing the polarization of receiving antenna both horizontal and vertical.
6. The radiation measurements are tested under 3-axes(X,Y,Z) position(X denotes lying on the table, Y denotes side stand and Z denotes vertical stand), After pre-test, It was found that the worse radiation emission was get at the X position. So the data shown was the X position only.
7. Remove the EUT and replace it with substitution antenna. A signal generator was connected to the substitution antenna by a non-radiating cable. The absolute levels of the spurious emissions were measured by the substitution.
Spurious emissions in dB = $10 \lg(\text{TXpwr in Watts}/0.001)$ – the absolute level
Spurious attenuation limit in dB = $43 + 10 \text{Log}_{10}(\text{power out in Watts})$
8. Repeat above procedures until the measurements for all frequencies are completed.

10.5 Summary of Test Results

For 26MHz~30MHz,

The measurements were more than 20 dB below the limit and not reported.

Remark: Test performed from 30MHz to 10th harmonics with low/middle/high channels, only the worst data were recorded.

Cellular Band (Part 22H)

Frequency	Receiver Reading	Turn table Angle	RX Antenna		Substituted			Absolute Level	Result	
			Height	Polar	SG Level	Cable	Antenna Gain		Limit	Margin
(MHz)	(dBμV)	Degree	(m)	(H/V)	(dBm)	(dB)	(dB)	(dBm)	(dBm)	(dB)
GSM 850 Channel 128										
201.36	41.47	117	1.5	H	-69.04	0.15	0.00	-69.19	-13.00	-56.19
201.36	45.65	36	1.8	V	-61.94	0.15	0.00	-62.09	-13.00	-49.09
1648.40	65.43	167	1.2	H	-48.54	0.30	9.40	-39.44	-13.00	-26.44
1648.40	58.32	90	1.9	V	-55.21	0.30	9.40	-46.11	-13.00	-33.11
2472.60	55.36	133	2.1	H	-58.64	0.43	10.60	-48.47	-13.00	-35.47
2472.60	49.35	251	1.0	V	-60.93	0.43	10.60	-50.76	-13.00	-37.76
WCDMA Band V Channel 4233										
201.36	40.95	238	1.4	H	-69.56	0.15	0.00	-69.71	-13.00	-56.71
201.36	45.85	314	1.6	V	-61.74	0.15	0.00	-61.89	-13.00	-48.89
1673.20	57.21	239	1.9	H	-56.76	0.30	9.40	-47.66	-13.00	-34.66
1673.20	49.90	153	1.7	V	-63.63	0.30	9.40	-54.53	-13.00	-41.53
2509.80	47.07	227	1.5	H	-66.93	0.43	10.60	-56.76	-13.00	-43.76
2509.80	40.02	251	1.9	V	-70.26	0.43	10.60	-60.09	-13.00	-47.09

Cellular Band (Part 24E/27)

Frequency	Receiver Reading	Turn table Angle	RX Antenna		Substituted			Absolute Level	Result	
			Height	Polar	SG Level	Cable	Antenna Gain		Limit	Margin
(MHz)	(dBμV)	Degree	(m)	(H/V)	(dBm)	(dB)	(dB)	(dBm)	(dBm)	(dB)
PCS 1900 Channel 512										
201.36	47.76	294	1.0	H	-62.75	0.15	0.00	-62.90	-13.00	-49.90
201.36	39.88	175	1.6	V	-67.71	0.15	0.00	-67.86	-13.00	-54.86
3760.00	65.95	352	2.0	H	-45.59	2.37	12.50	-35.46	-13.00	-22.46
3760.00	59.98	293	2.0	V	-49.83	2.37	12.50	-39.70	-13.00	-26.70
5640.00	53.58	245	1.5	H	-56.03	2.86	12.90	-45.99	-13.00	-32.99
5640.00	44.73	291	1.9	V	-64.15	2.86	12.90	-54.11	-13.00	-41.11
WCDMA Band II Channel 9400										
201.36	46.99	185	1.1	H	-63.52	0.15	0.00	-63.67	-13.00	-50.67
201.36	39.84	211	1.5	V	-67.75	0.15	0.00	-67.90	-13.00	-54.90
3815.20	59.80	168	1.5	H	-51.74	2.37	12.50	-41.61	-13.00	-28.61
3815.20	53.39	170	1.6	V	-56.42	2.37	12.50	-46.29	-13.00	-33.29
5722.80	47.54	252	1.2	H	-62.07	2.86	12.90	-52.03	-13.00	-39.03
5722.80	38.02	310	1.7	V	-70.86	2.86	12.90	-60.82	-13.00	-47.82
WCDMA Band IV Channel 1313										
201.36	46.92	48	2.1	H	-63.59	0.15	0.00	-63.74	-13.00	-50.74
201.36	41.07	82	1.9	V	-66.52	0.15	0.00	-66.67	-13.00	-53.67
3424.80	58.66	8	1.7	H	-52.88	2.34	12.40	-42.82	-13.00	-29.82
3424.80	53.57	249	1.8	V	-56.24	2.34	12.40	-46.18	-13.00	-33.18
5137.20	47.56	312	1.7	H	-62.05	2.79	12.70	-52.14	-13.00	-39.14
5137.20	37.38	51	1.6	V	-71.50	2.79	12.70	-61.59	-13.00	-48.59

Note: 1) Absolute Level = SG Level - Cable loss + Antenna Gain

2) Margin = Limit- Absolute Level

11 Band Edge Measurement

Test Requirement:	FCC Part 2.1051,22.917(a),24.238(a), 27.53(h)
Test Method:	ANSI C63.4:2009, TIA/EIA-603-D:2010 KDB971168 D01 v02r02
Test Mode:	Transmitting

11.1 EUT Operation

Operating Environment :

Temperature:	23.5 °C
Humidity:	52.3 % RH
Atmospheric Pressure:	101.3kPa

11.2 Test Procedure

The RF output of the transmitter was connected to the input of the spectrum analyzer through sufficient attenuation.

According to FCC Part 22.917(a), the power of any emissions outside of the authorized operating frequency ranges must be attenuated below the transmitting power (P) by a factor of at least $43 + 10 \log(P)$ dB.

According to FCC Part 24.238(a), the power of any emissions outside of the authorized operating frequency ranges must be attenuated below the transmitting power (P) by a factor of at least $43 + 10 \log(P)$ dB.

The center of the spectrum analyzer was set to block edge frequency

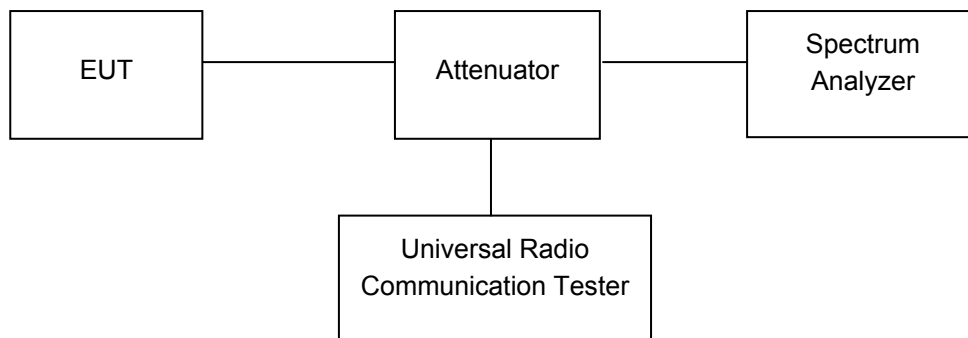

11.3 Test Result

Test plots
Cellular Band (Part 22H)
GSM 850 band edge-left side

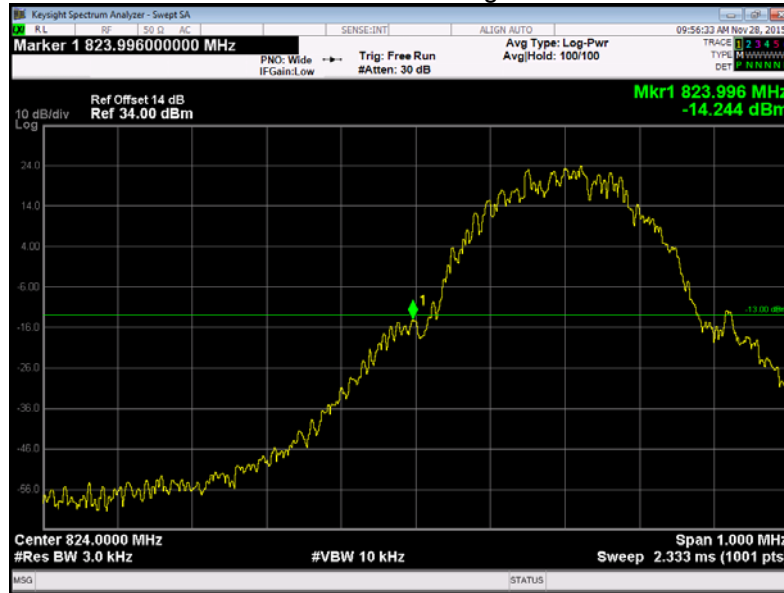

GSM 850 band edge-right side



GPRS 850 band edge-left side

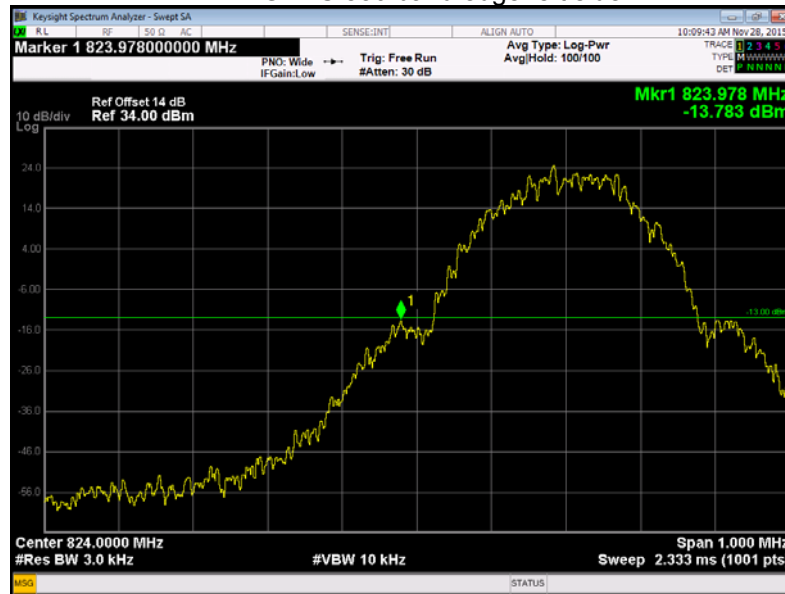

GPRS 850 band edge-right side



WCDMA band V band edge-left side

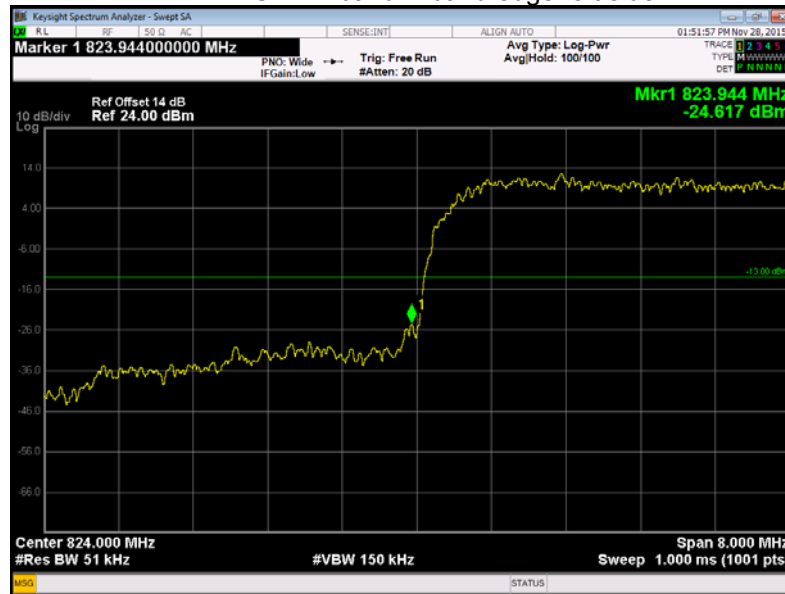

WCDMA band V band edge-right side

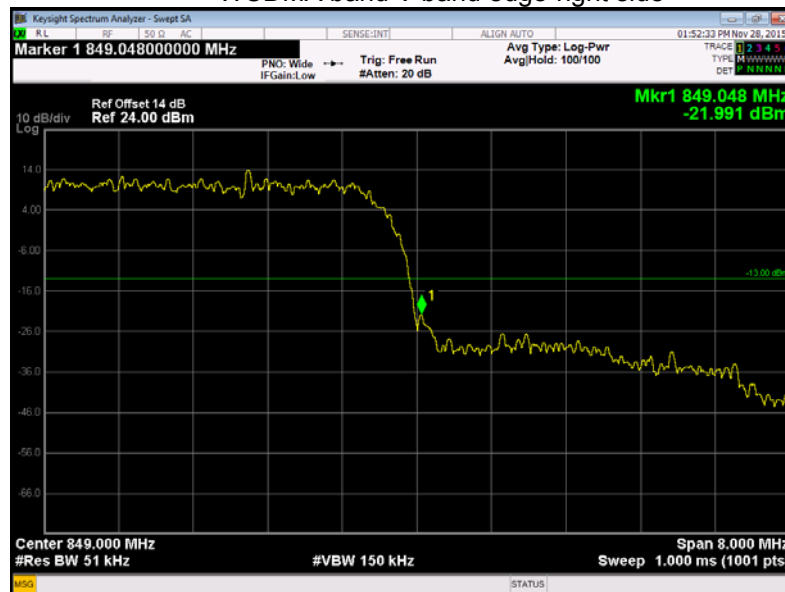

Cellular Band (Part 24E)

PCS 1900 band edge-left side

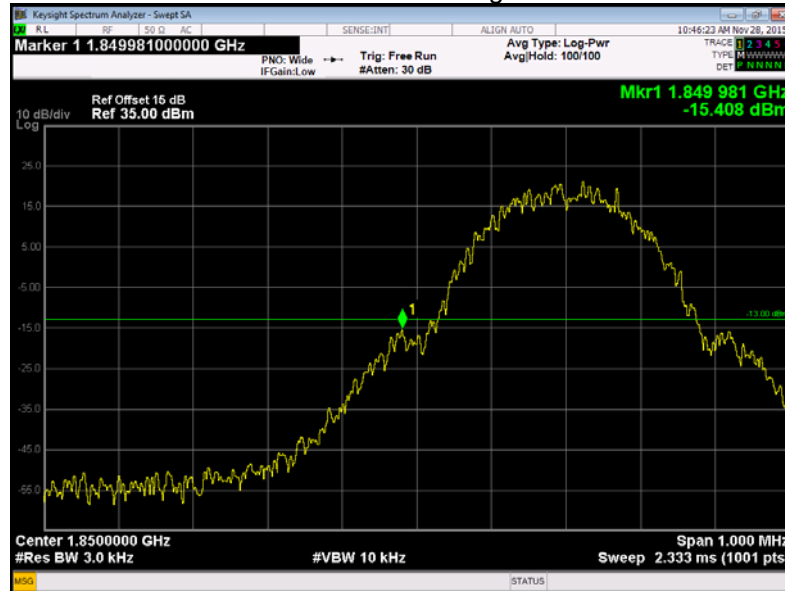

PCS 1900 band edge-right side



GPRS 1900 band edge-left side

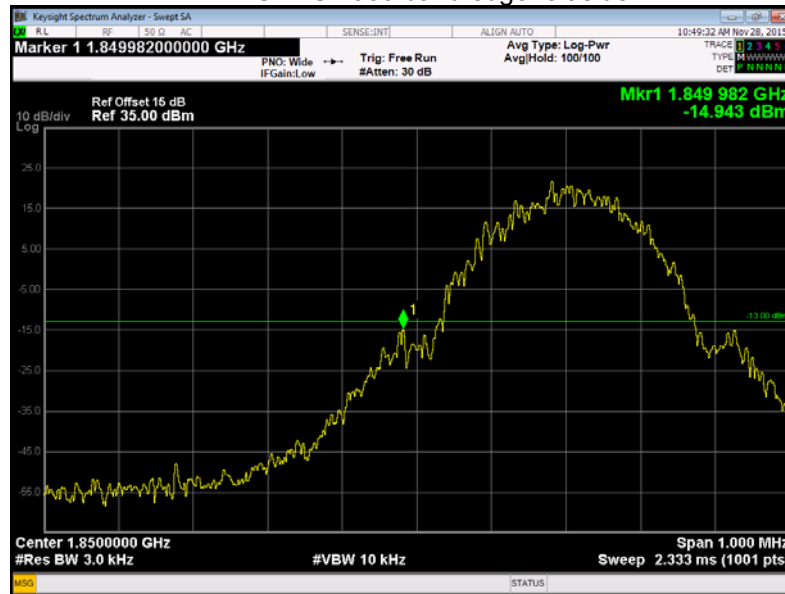

GPRS 1900 band edge-right side



WCDMA band II band edge-left side

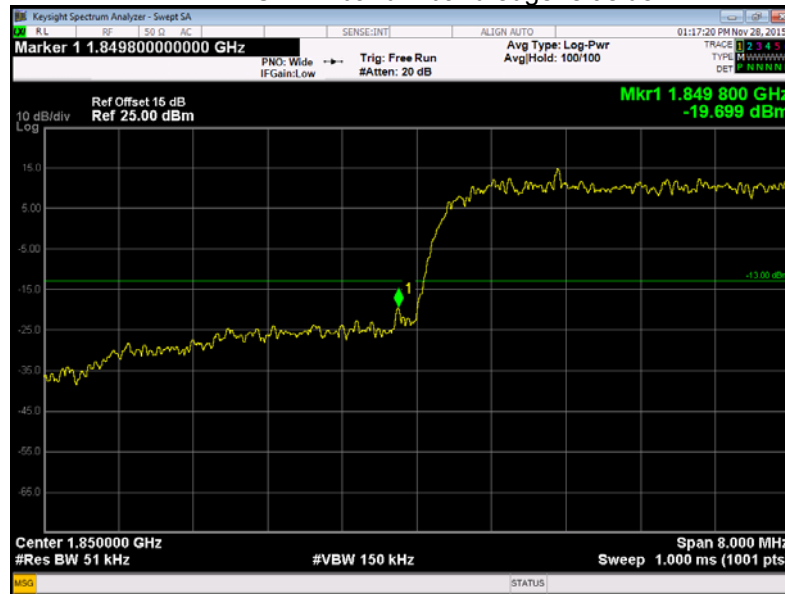

WCDMA band II band edge-right side



Part 27

WCDMA band IV band edge-left side

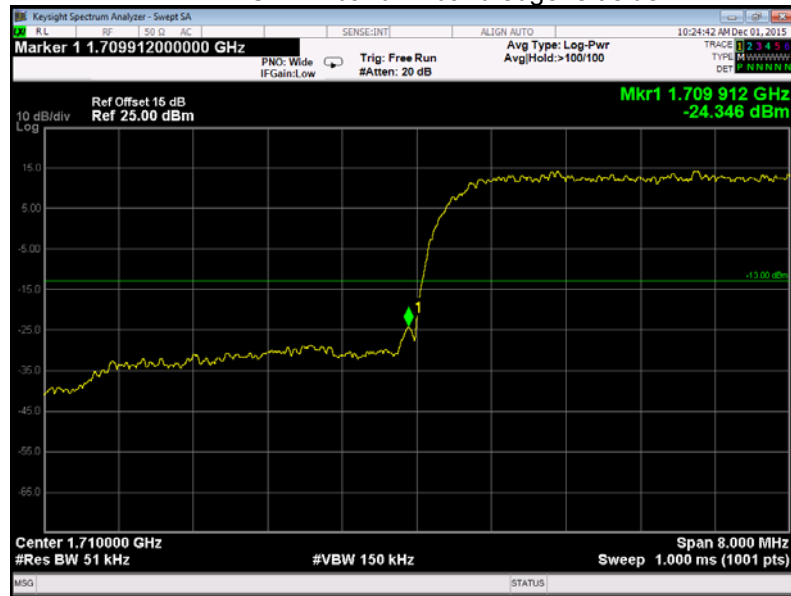

WCDMA band IV band edge-right side

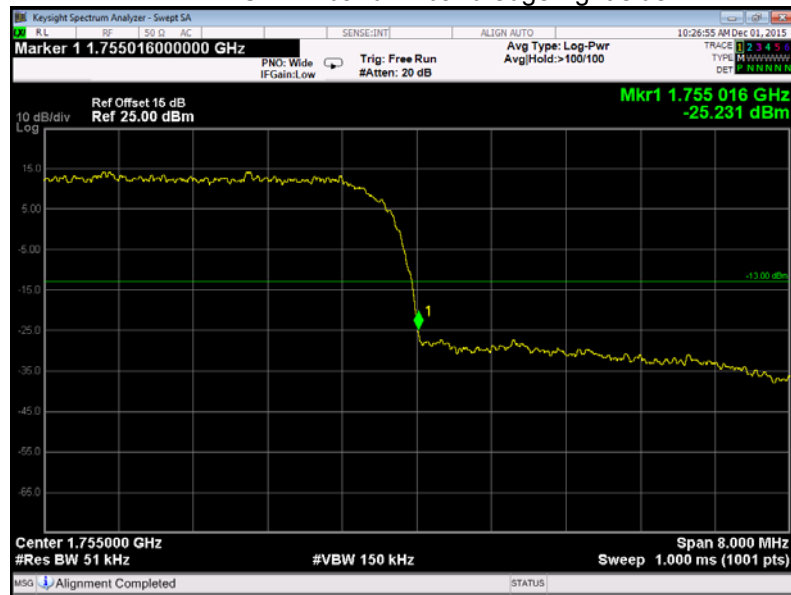

12 FREQUENCY STABILITY

Test Requirement:	FCC Part 2.1055,22.355,24.235,27.5(h),27.54
Test Method:	ANSI C63.4:2009, TIA/EIA-603-D:2010 KDB971168 D01 v02r02
Test Mode:	Transmitting

12.1 EUT Operation

Operating Environment :	
Temperature:	22.9 °C
Humidity:	52.0 % RH
Atmospheric Pressure:	101.3kPa

12.2 Test Procedure

Frequency Stability vs. Temperature: The equipment under test was connected to an external DC power supply and the RF output was connected to communication test set via feed-through attenuators. The EUT was placed inside the temperature chamber. The DC leads and RF output cable exited the chamber through an opening made for the purpose.

After the temperature stabilized for approximately 20 minutes, the frequency output was recorded from the communication test set.

Frequency Stability vs. Voltage: For hand carried, battery powered equipment; reduce primary supply voltage to the battery operating end point which shall be specified by the manufacturer.

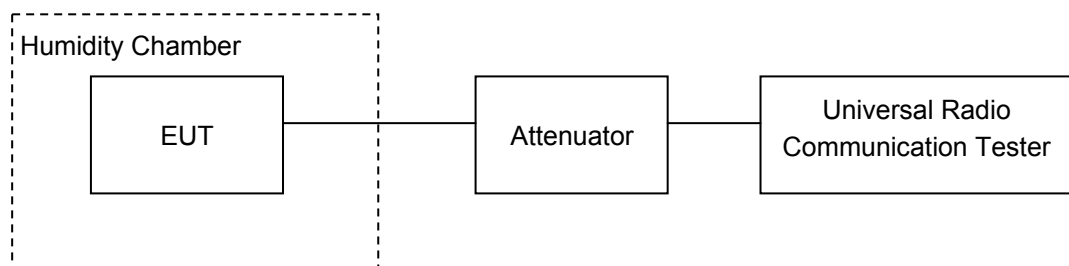

12.3 Test Result

Cellular Band (Part 22H)

GSM 850 Test Frequency:836.6MHz				
Temperature (°C)	Power Supply (VDC)	Frequency Error (Hz)	Frequency Error (ppm)	Limit (ppm)
50	3.7	-12	-0.0143	2.5
40		-16	-0.0191	2.5
30		-10	-0.0120	2.5
20		-13	-0.0155	2.5
10		-7	-0.0084	2.5
0		-15	-0.0179	2.5
-10		-4	-0.0048	2.5
-20		-16	-0.0191	2.5
-30		-15	-0.0179	2.5
20		3.3	-8	-0.0096
20	4.2	-17	-0.0203	2.5

GPRS 850 Test Frequency:836.6MHz				
Temperature (°C)	Power Supply (VDC)	Frequency Error (Hz)	Frequency Error (ppm)	Limit (ppm)
50	3.7	-13	-0.0155	2.5
40		-19	-0.0227	2.5
30		-8	-0.0096	2.5
20		-15	-0.0179	2.5
10		-17	-0.0203	2.5
0		-14	-0.0167	2.5
-10		-15	-0.0179	2.5
-20		-23	-0.0275	2.5
-30		-21	-0.0251	2.5
20		3.3	-18	-0.0215
20	4.2	-13	-0.0155	2.5

WCDMA Band V Test Frequency:836.6MHz				
Temperature (°C)	Power Supply (VDC)	Frequency Error (Hz)	Frequency Error (ppm)	Limit (ppm)
50	3.7	1	0.0012	2.5
40		2	0.0024	2.5
30		-10	-0.0120	2.5
20		-4	-0.0048	2.5
10		-6	-0.0072	2.5
0		-10	-0.0120	2.5
-10		-13	-0.0155	2.5
-20		-3	-0.0036	2.5
-30		-1	-0.0012	2.5
20		3.3	2	0.0024
20	4.2	-5	-0.0060	2.5

PCS Band (Part 24E)				
PCS 1900 Test Frequency:1880.0MHz				
Temperature (°C)	Power Supply (VDC)	Frequency Error (Hz)	Frequency Error (ppm)	Limit (ppm)
50	3.7	-24	-0.0128	2.5
40		-9	-0.0048	2.5
30		-14	-0.0074	2.5
20		-16	-0.0085	2.5
10		-22	-0.0117	2.5
0		-14	-0.0074	2.5
-10		-17	-0.0090	2.5
-20		-8	-0.0043	2.5
-30		-7	-0.0037	2.5
20		3.3	-23	-0.0122
20	4.2	-13	-0.0069	2.5

GPRS 1900 Test Frequency:1880.0MHz				
Temperature (°C)	Power Supply (VDC)	Frequency Error (Hz)	Frequency Error (ppm)	Limit (ppm)
50	3.7	-25	-0.0133	2.5
40		-21	-0.0112	2.5
30		-23	-0.0122	2.5
20		-19	-0.0101	2.5
10		-24	-0.0128	2.5
0		-20	-0.0106	2.5
-10		-21	-0.0112	2.5
-20		-24	-0.0128	2.5
-30		-20	-0.0106	2.5
20		3.3	-22	-0.0117
20	4.2	-14	-0.0074	2.5

WCDMA Band II Test Frequency:1880.0MHz				
Temperature (°C)	Power Supply (VDC)	Frequency Error (Hz)	Frequency Error (ppm)	Limit (ppm)
50	3.7	11	0.0059	2.5
40		6	0.0032	2.5
30		1	0.0005	2.5
20		4	0.0021	2.5
10		-1	-0.0005	2.5
0		-4	-0.0021	2.5
-10		12	0.0064	2.5
-20		7	0.0037	2.5
-30		4	0.0021	2.5
20		3.3	9	0.0048
20	4.2	3	0.0016	2.5

WCDMA Band IV Test Frequency:1732.6MHz				
Temperature (°C)	Power Supply (VDC)	Frequency Error (Hz)	Frequency Error (ppm)	Limit (ppm)
50	3.7	4	0.0023	2.5
40		-5	-0.0029	2.5
30		9	0.0052	2.5
20		3	0.0017	2.5
10		6	0.0035	2.5
0		3	0.0017	2.5
-10		5	0.0029	2.5
-20		7	0.0040	2.5
-30		9	0.0052	2.5
20		3.3	10	0.0058
20	4.2	11	0.0063	2.5

13 RF Exposure

Remark: refer to SAR test report: WTS15S1138142E.

===== End of Report =====