

TEST REPORT

Reference No...... : WTS17S1194671-3E
FCC ID : 2AC7IEKOOQ60
Applicant..... : Interglobe Connection Corp
Address..... : 8228 NW 30th Terrace, Doral, Florida, United States
Manufacturer : The same as above
Address..... : The same as above
Product..... : Smart Phone
Model(s) : Omega LTE Q60
Brand Name..... : EKO
Standards..... : FCC CFR47 Part 22 Subpart H: 2016
: FCC CFR47 Part 24 Subpart E: 2016
: FCC CFR47 Part 27 Subpart L: 2016
Date of Receipt sample : 2017-11-10
Date of Test : 2017-11-12 to 2017-12-04
Date of Issue..... : 2017-12-05
Test Result..... : **Pass**

Remarks:

The results shown in this test report refer only to the sample(s) tested, this test report cannot be reproduced, except in full, without prior written permission of the company. The report would be invalid without specific stamp of test institute and the signatures of compiler and approver.

Prepared By:

Waltek Services (Shenzhen) Co., Ltd.

Address: 1/F., Fukangtai Building, West Baima Road, Songgang Street, Baoan District, Shenzhen, Guangdong, China

Tel :+86-755-83551033

Fax:+86-755-83552400

Compiled by:

Ford Wang

Ford Wang / Project Engineer

Approved by:



Philo Zhong

Philo Zhong / Manager

2 Laboratories Introduction

Waltek Services Test Group Ltd. is one of the largest and the most comprehensive third party testing organizations in China, our headquarter located in Shenzhen (CNAS Registration No. L3110, A2LA Certificate Number: 4243.01) and have branches in Foshan (CNAS Registration No. L6478), Dongguan (CNAS Registration No. L9950), Zhongshan, Suzhou (CNAS Registration No. L7754), Ningbo and Hong Kong, Our test capability covered four large fields: safety test. Electronic Magnetic Compatibility(EMC), reliability and energy performance, Chemical test. Meanwhile, Waltek has got recognition as registration and accreditation laboratory from EMSD (Electrical and Mechanical Services Department), and American Energy star, FCC(The Federal Communications Commission), CPSC(Consumer Product Safety Commission), CEC(California energy efficiency), IC(Industry Canada) and ELI(Efficient Lighting Initiative). It's the strategic partner and data recognition laboratory of international authoritative organizations, such as UL, Intertek(ETL-SEMKO), CSA, TÜV Rheinland, TÜV SÜD, etc. As a professional, comprehensive, justice international test organization, we still keep the scientific and rigorous work attitude to help each client satisfy the international standards and assist their product enter into globe market smoothly.

Waltek Services (Shenzhen) Co., Ltd.

A. Accreditations for Conformity Assessment (International)

Country/Region	Accreditation Body	Scope	Note
USA	CNAS (Registration No.: L3110) A2LA (Certificate No.: 4243.01)	FCC ID \ DOC \ VOC	1
Canada		IC ID \ VOC	2
Japan		MIC-T \ MIC-R	-
Europe		EMCD \ RED	-
Taiwan		NCC	-
Hong Kong		OFCA	-
Australia		RCM	-
India	International Services	WPC	-
Thailand		NTC	-
Singapore		IDA	-
Note:			
1. FCC Designation No.: CN1201. Test Firm Registration No.: 523476.			
2. IC Canada Registration No.: 7760A			

B. TCBs and Notify Bodies Recognized Testing Laboratory.

Recognized Testing Laboratory of ...	Notify body number
--------------------------------------	--------------------

TUV Rheinland	Optional.
Intertek	
TUV SUD	
SGS	
Phoenix Testlab GmbH	0700
Element Materials Technology Warwick Ltd	0891
Timco Engineering, Inc.	1177
Eurofins Product Service GmbH	0681

3 Contents

	Page
1 COVER PAGE	1
2 LABORATORIES INTRODUCTION	2
3 CONTENTS	4
4 REVISION HISTORY	6
5 GENERAL INFORMATION	7
5.1 GENERAL DESCRIPTION OF E.U.T.	7
5.2 DETAILS OF E.U.T.	7
5.3 TEST MODE.....	9
6 TEST SUMMARY	10
7 EQUIPMENT USED DURING TEST	11
7.1 EQUIPMENTS LIST.....	11
7.2 MEASUREMENT UNCERTAINTY.....	12
7.3 TEST EQUIPMENT CALIBRATION.....	12
8 RF OUTPUT POWER	13
8.1 EUT OPERATION.....	13
8.2 TEST PROCEDURE.....	13
8.3 TEST RESULT.....	14
9 PEAK-TO-AVERAGE RATIO	20
9.1 EUT OPERATION.....	20
9.2 TEST PROCEDURE.....	20
9.3 TEST RESULT.....	21
10 BANDWIDTH	24
10.1 EUT OPERATION.....	24
10.2 TEST PROCEDURE.....	24
10.3 TEST RESULT.....	25
11 SPURIOUS EMISSIONS AT ANTENNA TERMINALS	36
11.1 EUT OPERATION.....	36
11.2 TEST PROCEDURE.....	36
11.3 TEST RESULT.....	37
12 SPURIOUS RADIATED EMISSIONS	52
12.1 EUT OPERATION.....	52
12.2 TEST SETUP.....	52
12.3 SPECTRUM ANALYZER SETUP.....	53
12.4 TEST PROCEDURE.....	54
12.5 SUMMARY OF TEST RESULTS.....	55
13 BAND EDGE MEASUREMENT	57
13.1 EUT OPERATION.....	57
13.2 TEST PROCEDURE.....	57
13.3 TEST RESULT.....	58
14 FREQUENCY STABILITY	73
14.1 EUT OPERATION.....	73
14.2 TEST PROCEDURE.....	73
14.3 TEST RESULT.....	74

15	RF EXPOSURE.....	82
16	PHOTOGRAPHS OF TEST SETUP AND EUT.....	83

4 Revision History

Test report No.	Date of Receipt sample	Date of Test	Date of Issue	Purpose	Comment	Approved
WTS17S11946 71-3E	2017-11-10	2017-11-12 to 2017-12- 04	2017-12-05	original	-	Valid

5 General Information

5.1 General Description of E.U.T.

Product:	Smart Phone
Model(s):	Omega LTE Q60
Model Description:	N/A
GSM Band(s):	GSM 850/900/1800/1900MHz
GPRS/EGPRS Class:	12
WCDMA Band(s):	FDD Band II/IV/V
LTE Band(s):	FDD Band 4/7
Wi-Fi Specification:	2.4G-802.11b/g/n HT20/n HT40
Bluetooth Version:	Bluetooth v4.0 with BLE
GPS:	Support
NFC:	N/A
Hardware Version:	D6S_03_C00SEA
Software Version:	EKO OMEGA LTE Q60_CA_V1.0
Highest frequency (Exclude Radio):	1.25G
Storage Location:	Internal Storage

Note: This EUT has two SIM card slots, and use same one RF module. We found that RF parameters are the same, when we insert the card 1 and card 2. So we usually performed the test under main card slot 1.

5.2 Details of E.U.T.

Operation Frequency:	GSM/GPRS/EDGE 850: 824~849MHz
	PCS/GPRS/EDGE 1900: 1850~1910MHz
	WCDMA Band II: 1850~1910MHz
	WCDMA Band V: 824~849MHz
	WCDMA Band IV: 1710~1755MHz
	LTE Band 4: 1710~1755MHz
	LTE Band 7: 2500-2570MHz
	WiFi:
	802.11b/g/n HT20: 2412~2462MHz
	802.11n HT40: 2422~2452MHz
	Bluetooth: 2402~2480MHz
Max. RF output power:	GSM 850: 32.71dBm
	PCS1900: 29.82dBm
	WCDMA Band II: 22.88dBm
	WCDMA Band V: 22.55dBm
	WCDMA Band IV: 22.68dBm

Type of Modulation:	LTE Band 4: 21.87dBm LTE Band 7: 21.92dBm WiFi(2.4G): 9.43dBm Bluetooth: 3.06dBm GSM,GPRS: GMSK EDGE: GMSK, 8PSK WCDMA: BPSK, 16QAM LTE: QPSK, 16QAM WiFi: CCK, OFDM Bluetooth: GFSK, Pi/4 DQPSK, 8DPSK
Antenna installation:	GSM/WCDMA/LTE: internal permanent antenna WiFi/Bluetooth: internal permanent antenna
Antenna Gain:	GSM 850: -3.5dBi PCS1900: -1.0dBi WCDMA Band II: -1.0dBi WCDMA Band V: -3.5dBi CDMA Band IV: -1.2dBi LTE Band 4: -1.2dBi LTE Band 7: 1.5dBi WiFi(2.4G): 2.0dBi Bluetooth: 2.0dBi
Ratings:	Battery DC 3.8V, 2900mAh DC 5V, 1.0A, charging from adapter (Adapter Input: 100-240V~50/60Hz 0.15A)
Adapter:	Manufacture: Shenzhen GuangYuanSheng Technology Co.,Ltd. Model No.: 853-5010
Type of Emission:	GSM850: 250KGXW, GPRS850: 247KGXW, EGPRS850: 242KG7W PCS1900: 246KGXW, GPRS1900: 244KGXW, EGPRS1900: 242KG7W WCDMA850: 4M21F9W, WCDMA1900: 4M22F9W, WCDMA1700: 4M17F9W

5.3 Test Mode

All test mode(s) and condition(s) mentioned were considered and evaluated respectively by performing full tests, the worst data were recorded and reported.

Support Band	Test Mode	Channel Frequency	Channel Number
GSM 850	GSM/GPRS/EDGE	824.2 MHz	128
		836.6 MHz	190
		848.8 MHz	251
PCS 1900	GSM/GPRS/EDGE	1850.2 MHz	512
		1880.0 MHz	661
		1909.8 MHz	810
WCDMA Band V	WCDMA/HSUPA/HSDPA	826.4 MHz	4132
		836.6 MHz	4183
		846.6 MHz	4233
WCDMA Band II	WCDMA/HSUPA/HSDPA	1852.4MHz	9262
		1880.0MHz	9400
		1907.6MHz	9538
WCDMA Band IV	WCDMA/HSUPA/HSDPA	1712.4MHz	1313
		1732.6MHz	1413
		1752.6MHz	1512
Remark: All mode(s) were tested and the worst data was recorded.			

6 Test Summary

Test Items	Test Requirement	Result
RF Output Power	2.1046 22.913 (a) 24.232 (c) 27.50(c) 27.50(d)	PASS
Peak-to-Average Ratio	24.232 (d) 27.50(d)	PASS
Bandwidth	2.1049 22.905 22.917 24.238 27.53(a)	PASS
Spurious Emissions at Antenna Terminal	2.1051 22.917 (a) 24.238 (a) 27.53(h)	PASS
Field Strength of Spurious Radiation	2.1053 22.917 (a) 24.238 (a) 27.53(h)	PASS
Out of band emission, Band Edge	22.917 (a) 24.238 (a) 27.53(h)	PASS
Frequency Stability	2.1055 22.355 24.235 27.5(h) 27.54	PASS
Maximum Permissible Exposure (SAR)	1.1307 2.1093	PASS

7 Equipment Used during Test

7.1 Equipments List

Conducted Emissions Test Site 1#						
Item	Equipment	Manufacturer	Model No.	Serial No.	Last Calibration Date	Calibration Due Date
1.	EMI Test Receiver	R&S	ESCI	100947	2017-09-12	2018-09-11
2.	LISN	R&S	ENV216	101215	2017-09-12	2018-09-11
3.	Cable	Top	TYPE16(3.5M)	-	2017-09-12	2018-09-11
Conducted Emissions Test Site 2#						
Item	Equipment	Manufacturer	Model No.	Serial No.	Last Calibration Date	Calibration Due Date
1.	EMI Test Receiver	R&S	ESCI	101155	2017-09-12	2018-09-11
2.	LISN	SCHWARZBECK	NSLK 8128	8128-289	2017-09-12	2018-09-11
3.	Limiter	York	MTS-IMP-136	261115-001-0024	2017-09-12	2018-09-11
4.	Cable	LARGE	RF300	-	2017-09-12	2018-09-11
3m Semi-anechoic Chamber for Radiation Emissions Test site 1#						
Item	Equipment	Manufacturer	Model No.	Serial No.	Last Calibration Date	Calibration Due Date
1	Spectrum Analyzer	R&S	FSP	100091	2017-04-29	2018-04-28
2	Active Loop Antenna	Beijing Dazhi	ZN30900A	-	2017-04-09	2018-04-08
3	Trilog Broadband Antenna	SCHWARZBECK	VULB9163	336	2017-04-09	2018-04-08
4	Coaxial Cable (below 1GHz)	Top	TYPE16(13M)	-	2017-09-12	2018-09-11
5	Broad-band Horn Antenna	SCHWARZBECK	BBHA 9120 D	667	2017-04-09	2018-04-08
6	Broad-band Horn Antenna	SCHWARZBECK	BBHA 9170	335	2017-04-09	2018-04-08
7	Broadband Preamplifier	COMPLIANCE DIRECTION	PAP-1G18	2004	2017-04-13	2018-04-12
8	Coaxial Cable (above 1GHz)	Top	1GHz-25GHz	EW02014-7	2017-04-13	2018-04-12
9	Universal Radio Communication Tester	R&S	CMU 200	112461	2017-04-13	2018-04-12
10	Signal Generator	R&S	SMR20	100046	2017-09-12	2018-09-11
11	Smart Antenna	SCHWARZBECK	HA08	-	2017-04-09	2018-04-08
3m Semi-anechoic Chamber for Radiation Emissions Test site 2#						
Item	Equipment	Manufacturer	Model No.	Serial No	Last Calibration Date	Calibration Due Date

1	Test Receiver	R&S	ESCI	101296	2017-04-13	2018-04-12
2	Trilog Broadband Antenna	SCHWARZBECK	VULB9160	9160-3325	2017-04-09	2018-04-08
3	Amplifier	Compliance pirection systems inc	PAP-0203	22024	2017-04-13	2018-04-12
4	Cable	HUBER+SUHNER	CBL2	525178	2017-04-13	2018-04-12
RF Conducted Testing						
Item	Equipment	Manufacturer	Model No.	Serial No.	Last Calibration Date	Calibration Due Date
1.	EMC Analyzer (9k~26.5GHz)	Agilent	E7405A	MY45114943	2017-09-12	2018-09-11
2.	Spectrum Analyzer (9k-6GHz)	R&S	FSL6	100959	2017-09-12	2018-09-11
3.	Universal Radio Communication Tester	R&S	CMU 200	112461	2017-04-13	2018-04-12
4	Signal Analyzer (9k~26.5GHz)	Agilent	N9010A	MY50520207	2017-09-12	2018-09-11

7.2 Measurement Uncertainty

Parameter	Uncertainty
Conducted Emission	± 3.64 dB(AC mains 150KHz~30MHz)
Radiated Spurious Emissions	± 5.08 dB (Bilog antenna 30M~1000MHz)
	± 5.47 dB (Horn antenna 1000M~25000MHz)
Radio Frequency	± 1 x 10 ⁻⁷ Hz
RF Power	± 0.42 dB
RF Power Density	± 0.7dB
Conducted Spurious Emissions	± 2.76 dB (9kHz~26500MHz)
Confidence interval: 95%. Confidence factor:k=2	

7.3 Test Equipment Calibration

All the test equipments used are valid and calibrated by CEPREI Certification Body that address is No.110 Dongguan Zhuang RD. Guangzhou, P.R.China.

8 RF OUTPUT POWER

Test Requirement:	FCC Part 2.1046, 22.913 (a), 24.232 (c), 27.50(c.10); 27.50(d.4)
Test Method:	TIA/EIA-603-D:2010 KDB971168 D01 v02r02
Test Mode:	TX transmitting

8.1 EUT Operation

Operating Environment :

Temperature:	22.5 °C
Humidity:	52.1 % RH
Atmospheric Pressure:	101.2kPa

8.2 Test Procedure

Conducted method:

The RF output of the transmitter was connected to the wireless test set and the spectrum analyzer through sufficient attenuation.

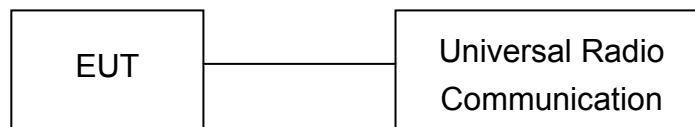

Radiated method:

1. The setup of EUT is according with per TIA/EIA Standard 603D measurement procedure.
2. The measurement antenna was placed at a distance of 3 meters from the EUT. During the tests, the antenna height and polarization as well as EUT azimuth were varied in order to identify the maximum level of emissions from the EUT. The test was performed by placing the EUT on 3-orthogonal axis.
3. The frequency range up to tenth harmonic of the fundamental frequency was investigated.
4. Remove the EUT and replace it with substitution antenna. A signal generator was connected to the substitution antenna by a non-radiating cable. The absolute levels of the spurious emissions were measured by the substitution.

8.3 Test Result

Conducted Power

GSM - Burst Average Power (dBm)						
Band	GSM850			PCS1900		
Channel	128	190	251	512	661	810
Frequency (MHz)	824.2	836.6	848.8	1850.2	1880	1909.8
GSM	32.69	32.55	32.43	29.81	29.79	29.43
GPRS (1 slot)	32.71	32.58	32.48	29.82	29.80	29.43
GPRS (2 slots)	31.28	31.48	31.33	28.69	28.78	28.45
GPRS (3 slots)	30.55	30.56	30.45	27.68	27.69	27.51
GPRS (4 slots)	29.65	29.49	29.66	26.59	26.77	26.64
EGPRS (1 slot)	26.80	26.89	26.83	25.44	25.03	24.96
EGPRS (2 slots)	26.23	26.21	26.22	24.56	24.11	24.21
EGPRS (3 slots)	25.32	25.31	25.35	23.65	23.29	23.69
EGPRS (4 slots)	24.68	24.77	24.68	22.89	22.87	22.89

WCDMA - Average Power (dBm)									
Band	WCDMA Band II			WCDMA Band V			WCDMA Band IV		
Channel	9262	9400	9538	4132	4183	4233	1313	1413	1512
Frequency (MHz)	1852.4	1880	1907.6	826.4	836.6	846.6	1712.4	1732.6	1752.6
RMC 12.2k	22.88	22.72	22.68	22.54	22.37	22.55	22.41	22.68	22.61
HSDPA Subtest-1	21.53	21.44	21.60	21.42	21.20	21.57	21.23	21.46	21.46
HSDPA Subtest-2	21.44	21.35	21.22	21.40	21.12	21.38	21.11	21.35	21.40
HSDPA Subtest-3	21.22	21.33	21.39	21.38	21.11	21.33	21.19	21.28	21.28
HSDPA Subtest-4	21.18	21.30	21.45	21.35	21.17	21.28	21.15	21.39	21.20
HSUPA Subtest-1	21.56	21.68	21.60	21.39	21.21	21.57	21.17	21.20	21.38
HSUPA Subtest-2	21.38	21.58	21.53	21.29	21.11	21.39	21.13	21.11	21.30
HSUPA Subtest-3	21.39	21.59	21.55	21.38	21.18	21.50	21.12	21.19	21.23
HSUPA Subtest-4	21.44	21.30	21.47	21.36	21.21	21.38	21.15	21.20	21.32
HSUPA Subtest-5	21.36	21.65	21.46	21.30	21.18	21.39	21.10	21.14	21.28

Radiated Powe

ERP and EIRP

Cellular Band 850 (Part 22H)

Frequency	Receiver Reading	Turn table Angle	RX Antenna		Substituted			Absolute Level	Part 22H	
			Height	Polar	SG Level	Cable	Antenna Gain		Limit	Margin
(MHz)	(dBμV)	Degree	(m)	(H/V)	(dBm)	(dB)	(dB)	(dBm)	(dBm)	(dB)
GSM 850 Channel 128										
824.20	92.68	346	1.1	H	25.65	0.20	0.00	25.45	38.45	-13.00
824.20	97.27	127	1.6	V	30.17	0.20	0.00	29.97	38.45	-8.48
GSM 850 Channel 190										
836.60	90.51	174	2.0	H	23.48	0.20	0.00	23.28	38.45	-15.17
836.60	97.68	346	1.3	V	30.58	0.20	0.00	30.38	38.45	-8.07
GSM 850 Channel 251										
848.80	93.96	61	2.1	H	26.93	0.20	0.00	26.73	38.45	-11.72
848.80	97.35	339	2.0	V	30.25	0.20	0.00	30.05	38.45	-8.40
GPRS 850 Channel 128										
824.20	92.04	285	1.1	H	25.01	0.20	0.00	24.81	38.45	-13.64
824.20	97.88	151	1.0	V	30.78	0.20	0.00	30.58	38.45	-7.87
GPRS 850 Channel 190										
836.60	90.32	213	1.1	H	23.29	0.20	0.00	23.09	38.45	-15.36
836.60	97.85	183	1.5	V	30.75	0.20	0.00	30.55	38.45	-7.90
GPRS 850 Channel 251										
848.80	91.98	242	2.3	H	24.95	0.20	0.00	24.75	38.45	-13.70
848.80	97.71	114	2.2	V	30.61	0.20	0.00	30.41	38.45	-8.04
EGPRS 850 Channel 128										
824.20	88.50	184	2.0	H	21.47	0.20	0.00	21.27	38.45	-17.18
824.20	92.96	143	1.3	V	25.86	0.20	0.00	25.66	38.45	-12.79
EGPRS 850 Channel 190										
836.60	88.01	55	1.2	H	20.98	0.20	0.00	20.78	38.45	-17.67
836.60	92.61	288	1.9	V	25.51	0.20	0.00	25.31	38.45	-13.14
EGPRS 850 Channel 251										
848.80	86.66	7	1.7	H	19.63	0.20	0.00	19.43	38.45	-19.02
848.80	92.99	69	1.4	V	25.89	0.20	0.00	25.69	38.45	-12.76

Cellular Band 1900 (Part 24E)

Frequency	Receiver Reading	Turn table Angle	RX Antenna		Substituted			Absolute Level	Part 24E	
			Height	Polar	SG Level	Cable	Antenna Gain		Limit	Margin
(MHz)	(dBμV)	Degree	(m)	(H/V)	(dBm)	(dB)	(dB)	(dBm)	(dBm)	(dB)
PCS 1900 Channel 512										
1850.20	85.51	87	1.3	H	11.54	0.31	10.40	21.63	33	-11.37
1850.20	92.00	127	1.9	V	18.72	0.31	10.40	28.81	33	-4.19
PCS 1900 Channel 661										
1880.00	87.30	125	1.2	H	13.45	0.31	10.40	23.54	33	-9.46
1880.00	92.82	221	2.2	V	19.70	0.31	10.40	29.79	33	-3.21
PCS 1900 Channel 810										
1909.80	84.63	355	2.2	H	10.90	0.32	10.40	20.98	33	-12.02
1909.80	92.28	83	1.7	V	19.32	0.32	10.40	29.40	33	-3.60
GPRS 1900 Channel 512										
1850.20	87.07	274	1.4	H	13.10	0.31	10.40	23.19	33	-9.81
1850.20	92.13	285	2.0	V	18.85	0.31	10.40	28.94	33	-4.06
GPRS 1900 Channel 661										
1880.00	85.84	146	2.1	H	11.99	0.31	10.40	22.08	33	-10.92
1880.00	92.50	122	2.4	V	19.38	0.31	10.40	29.47	33	-3.53
GPRS 1900 Channel 810										
1909.80	86.47	217	2.4	H	12.74	0.32	10.40	22.82	33	-10.18
1909.80	92.91	216	2.4	V	19.95	0.32	10.40	30.03	33	-2.97
EGPRS 1900 Channel 512										
1850.20	85.48	95	1.5	H	11.51	0.31	10.40	21.60	33	-11.40
1850.20	88.47	324	1.6	V	15.19	0.31	10.40	25.28	33	-7.72
EGPRS 1900 Channel 661										
1880.00	82.01	148	1.1	H	8.16	0.31	10.40	18.25	33	-14.75
1880.00	88.90	297	2.5	V	15.78	0.31	10.40	25.87	33	-7.13
EGPRS 1900 Channel 810										
1909.80	82.11	315	1.5	H	8.38	0.32	10.40	18.46	33	-14.54
1909.80	88.65	221	1.4	V	15.69	0.32	10.40	25.77	33	-7.23

WCDMA Band V (Part 22H)

Frequency (MHz)	Receiver Reading (dBμV)	Turn table Angle Degree	RX Antenna		Substituted			Absolute Level (dBm)	Part 22H	
			Height (m)	Polar (H/V)	SG Level (dBm)	Cable (dB)	Antenna Gain (dB)		Limit (dBm)	Margin (dB)
WCDMA Band V Voice Channel 4132										
826.40	78.52	214	2.5	H	11.49	0.20	0.00	11.29	38.45	-27.16
826.40	84.05	302	1.3	V	16.95	0.20	0.00	16.75	38.45	-21.70
WCDMA Band V Voice Channel 4183										
836.60	79.90	70	1.8	H	12.87	0.20	0.00	12.67	38.45	-25.78
836.60	84.54	98	1.4	V	17.44	0.20	0.00	17.24	38.45	-21.21
WCDMA Band V Voice Channel 4233										
846.60	79.22	312	1.8	H	12.19	0.20	0.00	11.99	38.45	-26.46
846.60	84.59	308	1.4	V	17.49	0.20	0.00	17.29	38.45	-21.16
WCDMA Band V HSDPA Channel 4132										
826.40	76.06	284	2.0	H	9.03	0.20	0.00	8.83	38.45	-29.62
826.40	84.15	92	1.6	V	17.05	0.20	0.00	16.85	38.45	-21.60
WCDMA Band V HSDPA Channel 4183										
836.60	79.61	79	2.2	H	12.58	0.20	0.00	12.38	38.45	-26.07
836.60	84.85	97	2.3	V	17.75	0.20	0.00	17.55	38.45	-20.90
WCDMA Band V HSDPA Channel 4233										
846.60	77.77	143	2.1	H	10.74	0.20	0.00	10.54	38.45	-27.91
846.60	84.47	14	1.5	V	17.37	0.20	0.00	17.17	38.45	-21.28
WCDMA Band V HSUPA Channel 4132										
826.40	77.60	212	1.4	H	10.57	0.20	0.00	10.37	38.45	-28.08
826.40	84.10	283	1.3	V	17.00	0.20	0.00	16.80	38.45	-21.65
WCDMA Band V HSUPA Channel 4183										
836.60	79.71	134	1.4	H	12.68	0.20	0.00	12.48	38.45	-25.97
836.60	84.30	265	1.1	V	17.20	0.20	0.00	17.00	38.45	-21.45
WCDMA Band V HSUPA Channel 4233										
846.60	78.24	231	2.0	H	11.21	0.20	0.00	11.01	38.45	-27.44
846.60	84.92	57	1.1	V	17.82	0.20	0.00	17.62	38.45	-20.83

WCDMA Band II (Part 24E)

Frequency	Receiver Reading	Turn table Angle	RX Antenna		Substituted			Absolute Level	Part 24E	
			Height	Polar	SG Level	Cable	Antenna Gain		Limit	Margin
(MHz)	(dBμV)	Degree	(m)	(H/V)	(dBm)	(dB)	(dB)	(dBm)	(dBm)	(dB)
WCDMA Band II Voice Channel 9262										
1852.40	76.03	311	1.8	H	2.06	0.31	10.40	12.15	33	-20.85
1852.40	84.15	136	1.1	V	10.87	0.31	10.40	20.96	33	-12.04
WCDMA Band II Voice Channel 9400										
1880.00	79.86	78	2.1	H	6.01	0.31	10.40	16.10	33	-16.90
1880.00	84.96	72	2.1	V	11.84	0.31	10.40	21.93	33	-11.07
WCDMA Band II Voice Channel 9538										
1907.60	76.70	12	2.1	H	2.97	0.32	10.40	13.05	33	-19.95
1907.60	84.58	259	1.9	V	11.62	0.32	10.40	21.70	33	-11.30
WCDMA Band II HSDPA Channel 9262										
1852.40	78.61	242	2.1	H	4.64	0.31	10.40	14.73	33	-18.27
1852.40	84.31	99	1.2	V	11.03	0.31	10.40	21.12	33	-11.88
WCDMA Band II HSDPA Channel 9400										
1880.00	76.24	41	2.4	H	2.39	0.31	10.40	12.48	33	-20.52
1880.00	84.49	163	2.0	V	11.37	0.31	10.40	21.46	33	-11.54
WCDMA Band II HSDPA Channel 9538										
1907.60	79.38	84	1.3	H	5.65	0.32	10.40	15.73	33	-17.27
1907.60	84.38	295	1.5	V	11.42	0.32	10.40	21.50	33	-11.50
WCDMA Band II HSUPA Channel 9262										
1852.40	76.94	134	1.4	H	2.97	0.31	10.40	13.06	33	-19.94
1852.40	84.78	50	2.1	V	11.50	0.31	10.40	21.59	33	-11.41
WCDMA Band II HSUPA Channel 9400										
1880.00	78.12	14	2.2	H	4.27	0.31	10.40	14.36	33	-18.64
1880.00	84.56	355	2.5	V	11.44	0.31	10.40	21.53	33	-11.47
WCDMA Band II HSUPA Channel 9538										
1907.60	79.62	195	1.2	H	5.89	0.32	10.40	15.97	33	-17.03
1907.60	84.57	296	1.4	V	11.61	0.32	10.40	21.69	33	-11.31

WCDMA Band IV (Part 27)

Frequency	Receiver Reading	Turn table Angle	RX Antenna		Substituted			Absolute Level	Part 27	
			Height	Polar	SG Level	Cable	Antenna Gain		Limit	Margin
(MHz)	(dBμV)	Degree	(m)	(H/V)	(dBm)	(dB)	(dB)	(dBm)	(dBm)	(dB)
WCDMA Band IV Voice Channel 1313										
1712.40	78.48	205	1.4	H	4.51	0.30	9.40	13.61	30	-16.39
1712.40	84.76	136	2.2	V	10.48	0.30	9.40	19.58	30	-10.42
WCDMA Band IV Voice Channel 1413										
1732.60	76.86	50	2.4	H	3.01	0.30	9.40	12.11	30	-17.89
1732.60	84.91	283	1.3	V	10.79	0.30	9.40	19.89	30	-10.11
WCDMA Band IV Voice Channel 1512										
1752.60	79.38	306	1.3	H	5.65	0.30	9.40	14.75	30	-15.25
1752.60	84.43	106	2.5	V	9.47	0.30	9.40	18.57	30	-11.43
WCDMA Band IV HSDPA Channel 1313										
1712.40	77.46	261	2.0	H	3.49	0.30	9.40	12.59	30	-17.41
1712.40	84.58	169	1.9	V	10.30	0.30	9.40	19.40	30	-10.60
WCDMA Band IV HSDPA Channel 1413										
1732.60	79.27	284	1.9	H	5.42	0.30	9.40	14.52	30	-15.48
1732.60	84.25	268	1.0	V	10.13	0.30	9.40	19.23	30	-10.77
WCDMA Band IV HSDPA Channel 1512										
1752.60	76.01	74	2.0	H	2.28	0.30	9.40	11.38	30	-18.62
1752.60	84.13	69	2.1	V	9.17	0.30	9.40	18.27	30	-11.73
WCDMA Band IV HSUPA Channel 1313										
1712.40	78.84	250	2.0	H	4.87	0.30	9.40	13.97	30	-16.03
1712.40	84.29	203	2.3	V	10.01	0.30	9.40	19.11	30	-10.89
WCDMA Band IV HSUPA Channel 1413										
1732.60	77.10	73	2.5	H	3.25	0.30	9.40	12.35	30	-17.65
1732.60	84.87	227	1.1	V	10.75	0.30	9.40	19.85	30	-10.15
WCDMA Band IV HSUPA Channel 1512										
1752.60	76.59	119	1.6	H	2.86	0.30	9.40	11.96	30	-18.04
1752.60	84.89	96	2.4	V	9.93	0.30	9.40	19.03	30	-10.97

9 Peak-to-Average Ratio

Test Requirement:	24.232 (d), 27.50(d)
Test Method:	N/A
Test Mode:	TX transmitting

9.1 EUT Operation

Operating Environment :

Temperature:	22.5 °C
Humidity:	52.3% RH
Atmospheric Pressure:	101.2kPa

9.2 Test Procedure

1. The EUT was connected to spectrum analyzer and system simulator via a power divider.
2. Set EUT to transmit at maximum output power.
3. When the duty cycle is less than 98%, then signal gating will be implemented on the spectrum analyzer by triggering from the system simulator.
4. Set the CCDF (Complementary Cumulative Distribution Function) option of the spectrum analyzer. Record the maximum PAPR level associated with a probability of 0.1%.

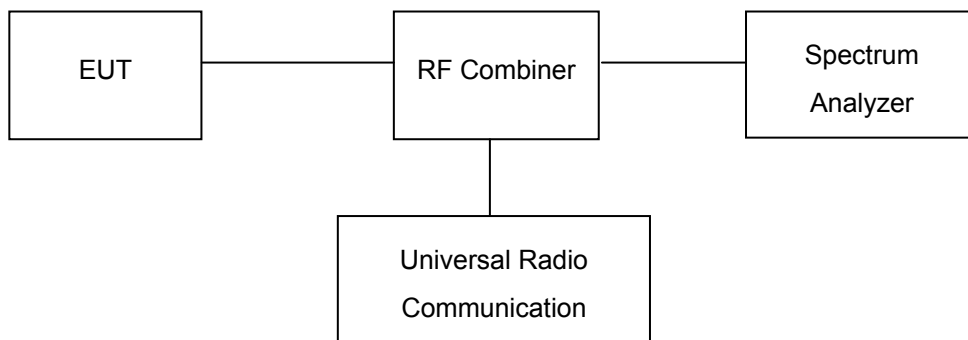

9.3 Test Result

Remark: All test data were reported and only the worst case (middle channel mode) test graphs were showed in test report.

Cellular Band (Part 24E)

Mode	PCS 1900			GPRS 1900			EDGE 1900			Limit (dB)
Channel	512	661	810	512	661	810	512	661	810	
Frequency (MHz)	1850.2	1880.0	1909.8	1850.2	1880.0	1909.8	1850.2	1880.0	1909.8	
Peak-to-Average Ratio (dB)	9.15	9.20	9.18	10.12	10.20	10.14	12.13	12.26	12.18	13

Mode	WCDMA Band II			WCDMA Band IV			Limit (dB)
Channel	9262	9400	9538	1313	1413	1512	
Frequency (MHz)	1852.4	1880.0	1907.6	1712.4	1732.6	1752.6	
Peak-to-Average Ratio (dB)	2.71	2.76	2.73	3.13	3.18	3.14	13

Test Plots (Part 24E)

PCS1900 Middle Channel

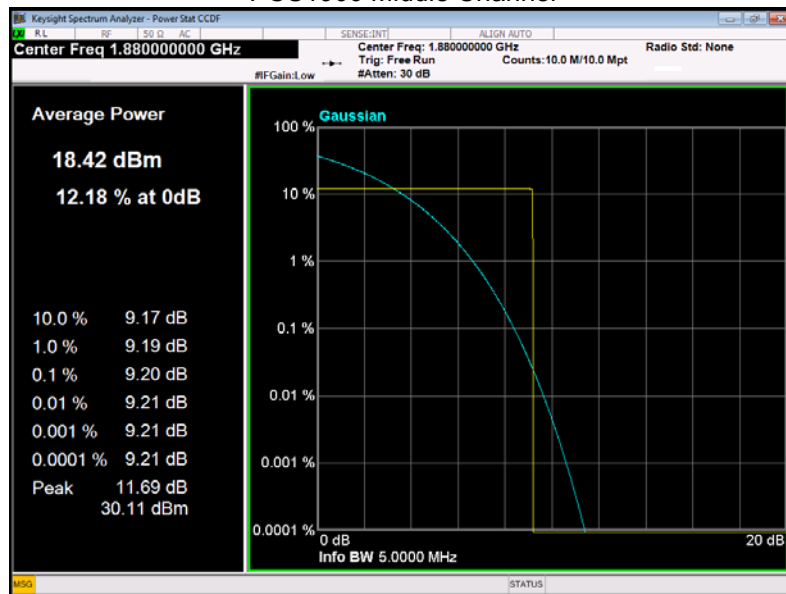

GPRS 1900 Middle Channel

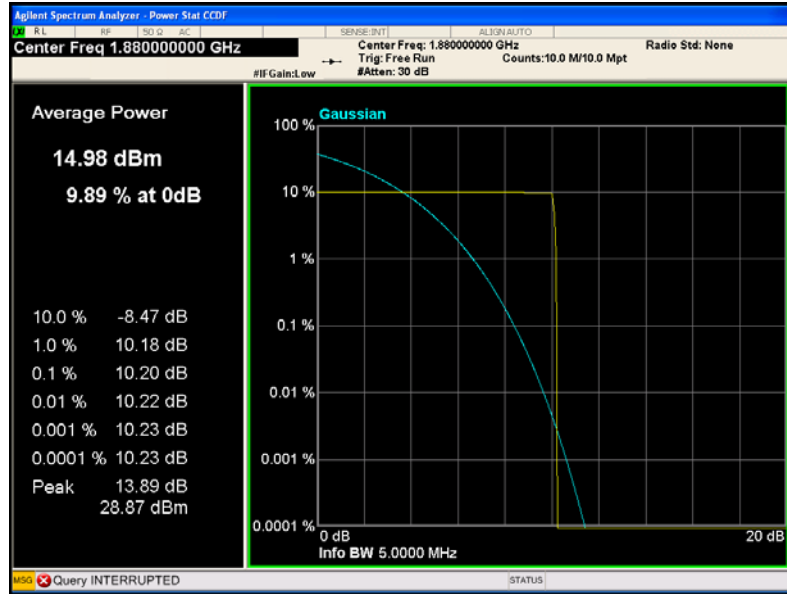

EDGE 1900 Middle Channel

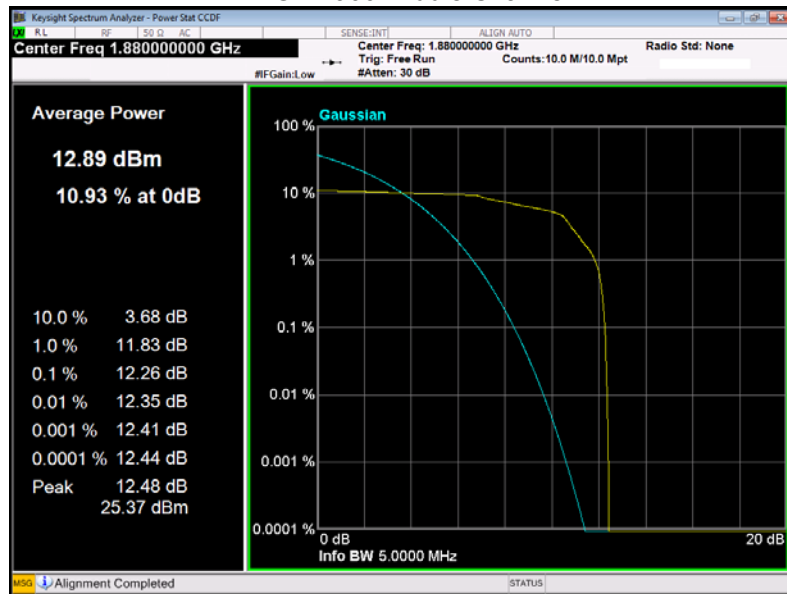

WCDMA Band II Middle Channel

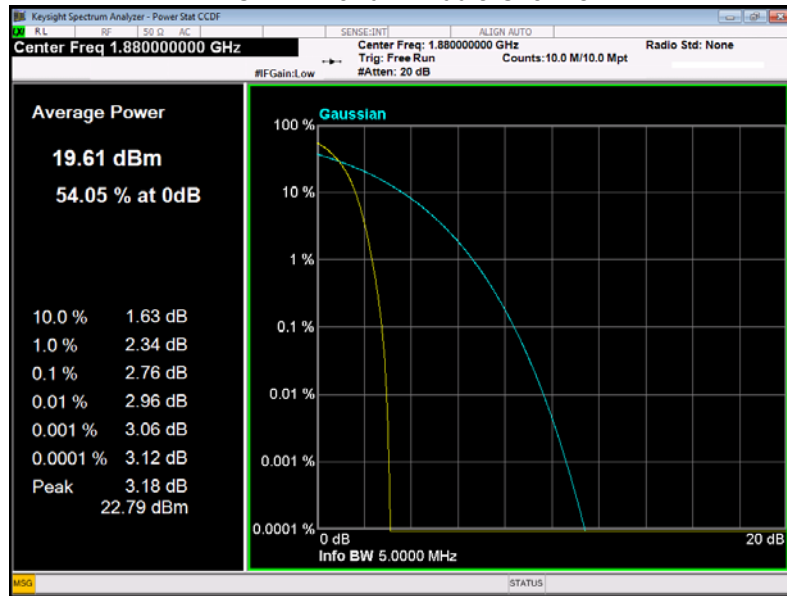

WCDMA Band IV Middle Channel

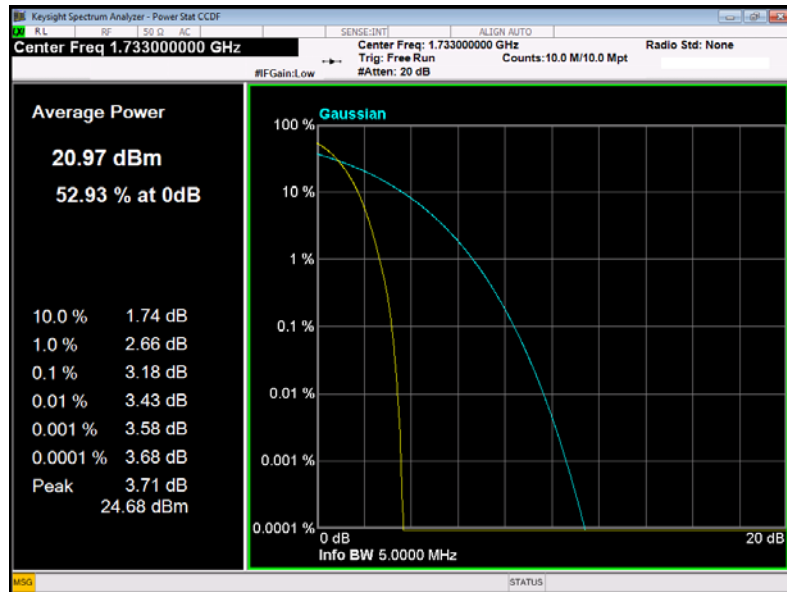

10 BANDWIDTH

Test Requirement:	FCC Part 2.1049, 22.917, 22.905, 24.238, 27.53(a)
Test Method:	TIA/EIA-603-D:2010 KDB971168 D01 v02r02
Test Mode:	TX transmitting

10.1 EUT Operation

Operating Environment :

Temperature:	22.5 °C
Humidity:	52.3% RH
Atmospheric Pressure:	101.2kPa

10.2 Test Procedure

The RF output of the transmitter was connected to the wireless test set and the spectrum analyzer through sufficient attenuation.

The resolution bandwidth of the spectrum analyzer was set in the range of 1 to 5 % of the anticipated OBW (Cellular /PCS) and the 26 dB & 99%bandwidth was recorded.

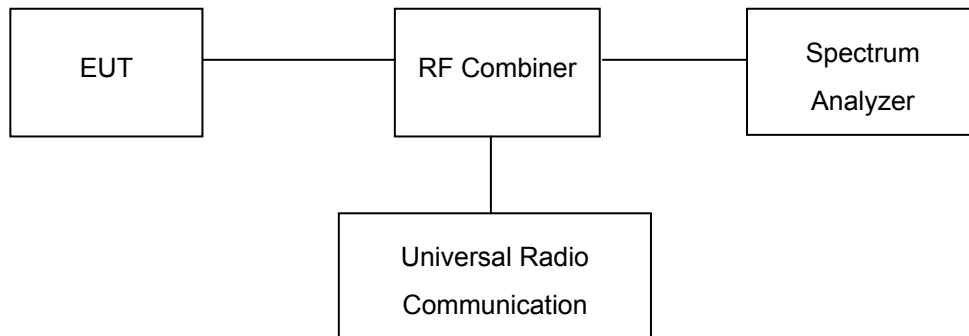

10.3 Test Result

Remark: All test data were reported and only the worst case (middle channel mode) test graphs were showed in test report.

Cellular Band (Part 22H)

Test Mode	Channel	Frequency (MHz)	99% Occupied Bandwidth(kHz)	26 dB Emission Bandwidth(kHz)
GSM 850	128	824.2	249.78	314.19
	190	836.6	249.79	314.20
	251	848.8	249.78	314.19
GPRS 850	128	824.2	247.43	318.20
	190	836.6	247.44	318.20
	251	848.8	247.44	318.19
EGPRS 850	128	824.2	241.69	307.29
	190	836.6	241.70	307.30
	251	848.8	241.69	307.29

Test Mode		Channel	Frequency (MHz)	99% Occupied Bandwidth(MHz)	26 dB Emission Bandwidth(MHz)
WCDMA Band V	RMC12.2k	4132	826.4	4.19	4.83
		4183	836.6	4.19	4.84
		4233	846.6	4.18	4.82
	HSDPA(16QAM)	4132	826.4	4.19	4.85
		4183	836.6	4.20	4.86
		4233	846.6	4.18	4.84
	HSUPA(BPSK)	4132	826.4	4.21	4.86
		4183	836.6	4.21	4.86
		4233	846.6	4.21	4.85

Cellular Band (Part 24E)

Test Mode	Channel	Frequency (MHz)	99% Occupied Bandwidth(kHz)	26 dB Emission Bandwidth(kHz)
PCS 1900	512	1850.2	246.10	315.50
	661	1880.0	246.11	315.50
	810	1909.8	246.10	315.49
GPRS 1900	512	1850.2	243.50	308.09
	661	1880.0	243.50	308.10
	810	1909.8	243.49	308.10
EGPRS 1900	512	1850.2	241.69	307.29
	661	1880.0	241.70	307.30
	810	1909.8	241.70	307.30

Test Mode	Channel	Frequency (MHz)	99% Occupied Bandwidth(MHz)	26 dB Emission Bandwidth(MHz)	
WCDMA Band II	RMC12.2k	9262	1852.4	4.20	4.90
		9400	1880.0	4.21	4.91
		9538	1907.6	4.20	4.89
	HSDPA(16QAM)	9262	1852.4	4.22	4.87
		9400	1880.0	4.22	4.88
		9538	1907.6	4.21	4.87
	HSUPA(BPSK)	9262	1852.4	4.21	4.86
		9400	1880.0	4.22	4.87
		9538	1907.6	4.22	4.86

Cellular Band (Part 27)

Test Mode		Channel	Frequency (MHz)	99% Occupied Bandwidth(MHz)	26 dB Emission Bandwidth(MHz)
WCDMA Band IV	RMC12.2k	1313	1712.6	4.13	4.65
		1413	1732.6	4.16	4.72
		1512	1752.4	4.08	4.56
	HSDPA	1313	1712.6	4.15	4.63
		1413	1732.6	4.17	4.72
		1512	1752.4	4.12	4.70
	HSUPA	1313	1712.6	4.07	4.63
		1413	1732.6	4.17	4.72
		1512	1752.4	4.07	4.59

Test Plots (worst case)
 Cellular Band (Part 22H)
 GSM 850

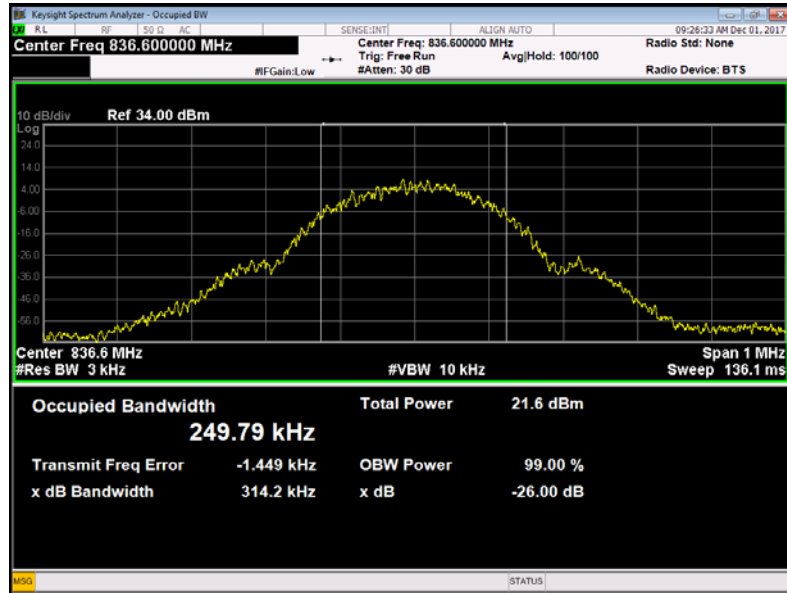

GPRS 850

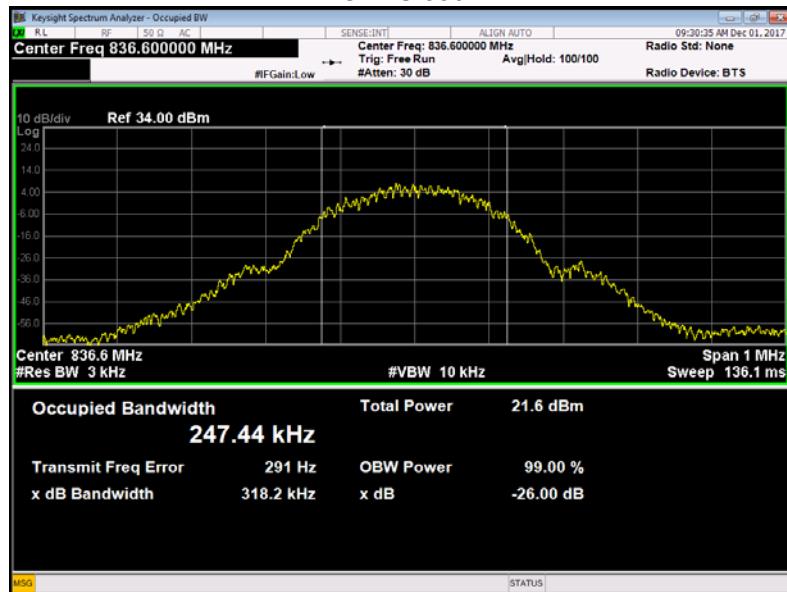

EGPRS 850

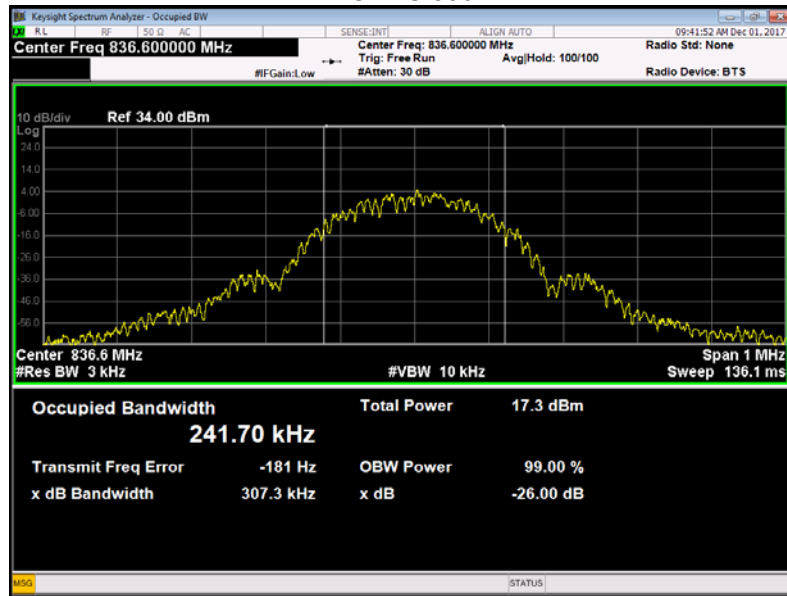

WCDMA band V

RMC12.2k

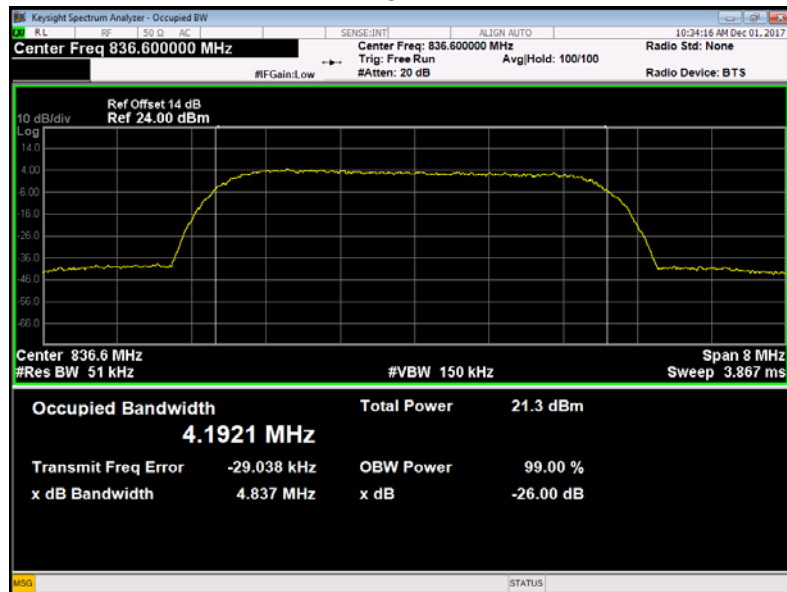

HSDPA

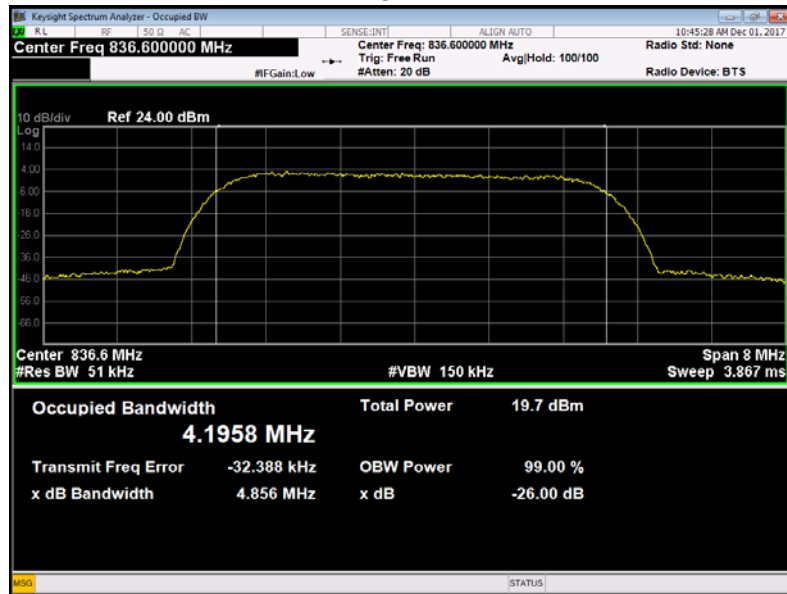

HSUPA

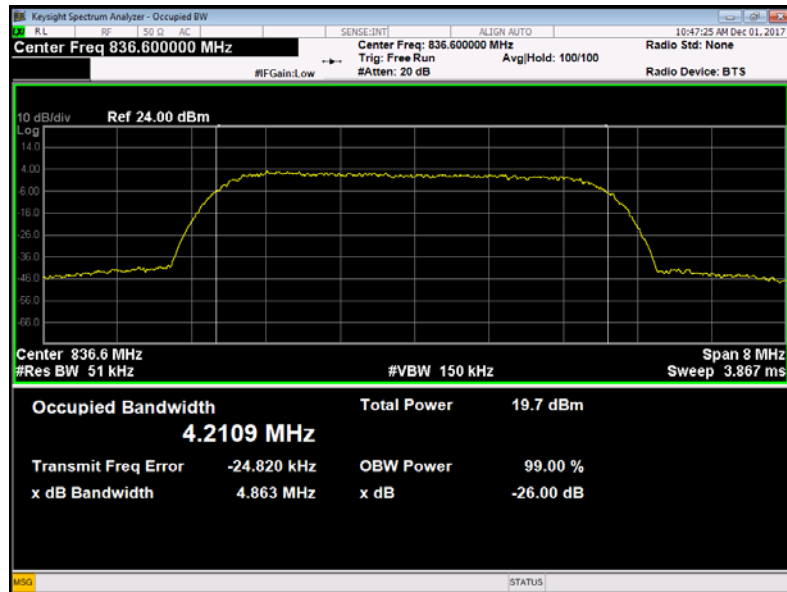

Cellular Band (Part 24E)

PCS 1900

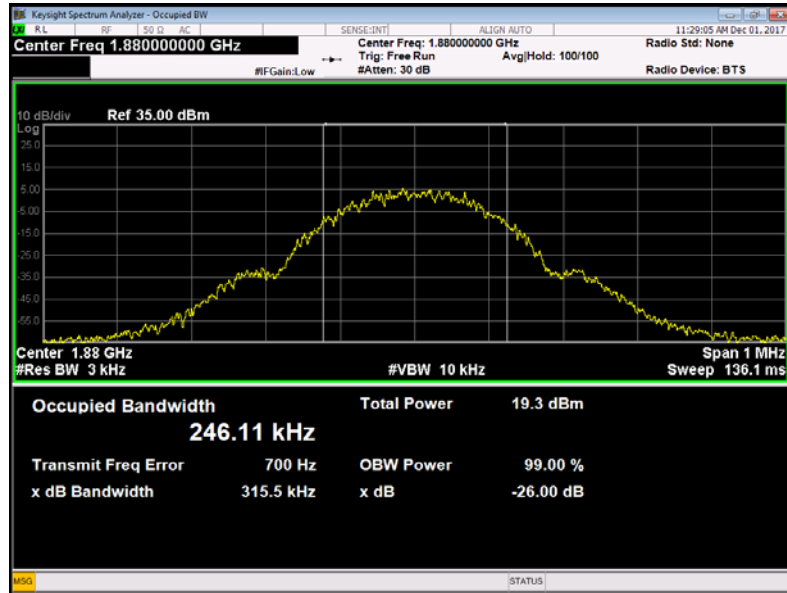

GPRS 1900

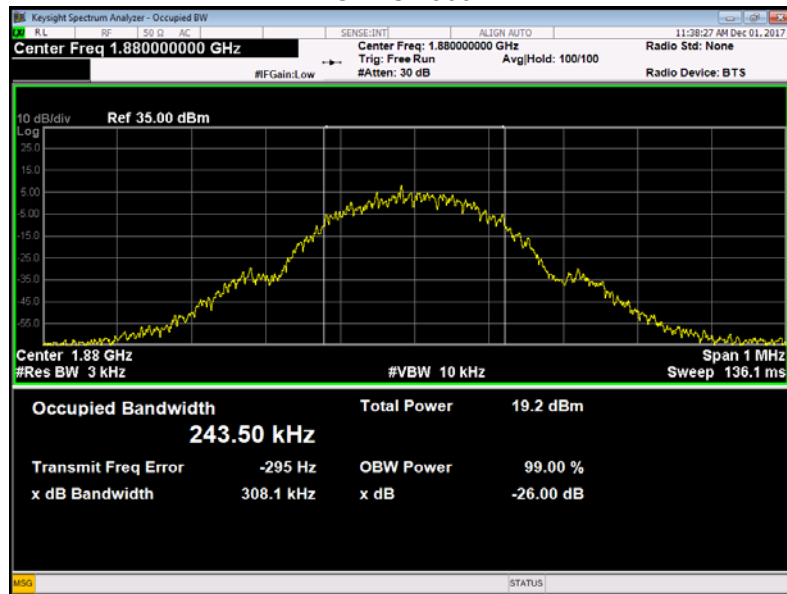

EGPRS 1900

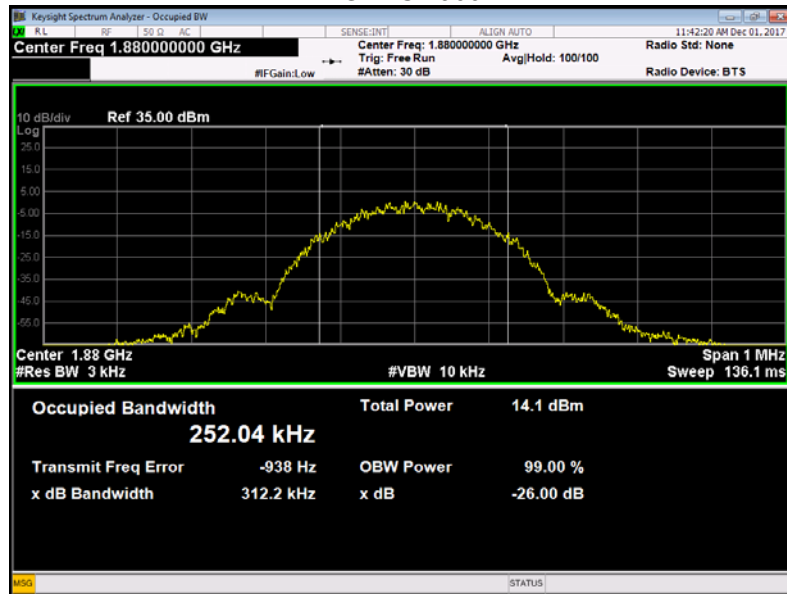

WCDMA band II

RMC12.2k

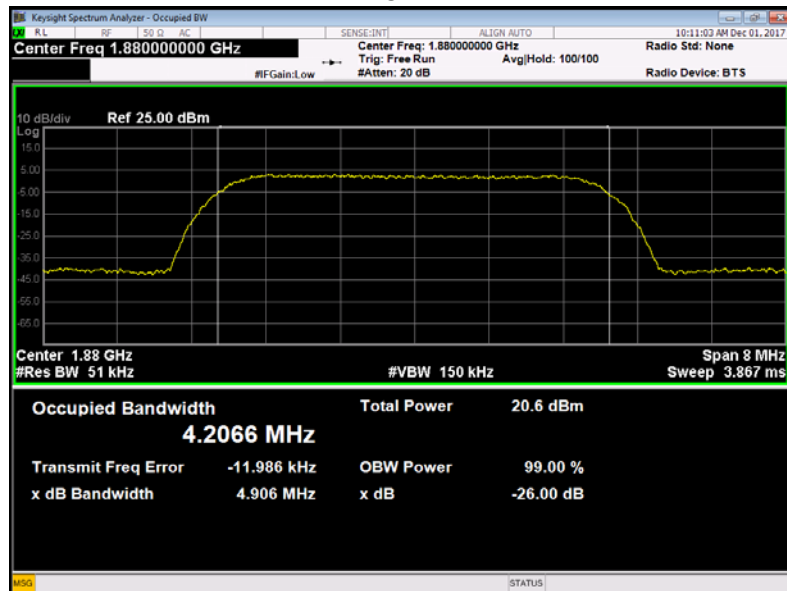

HSDPA

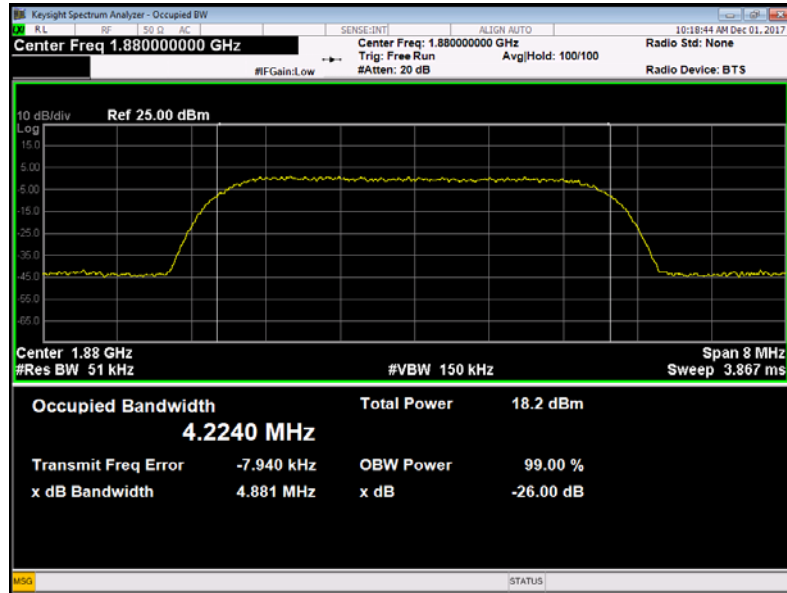

HSUPA

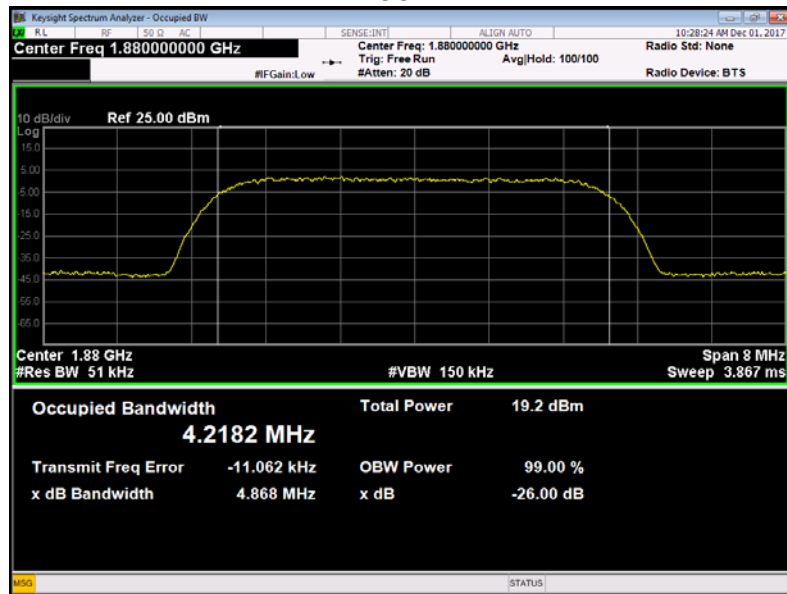

(Part 27)
 WCDMA band IV
 RMC12.2k

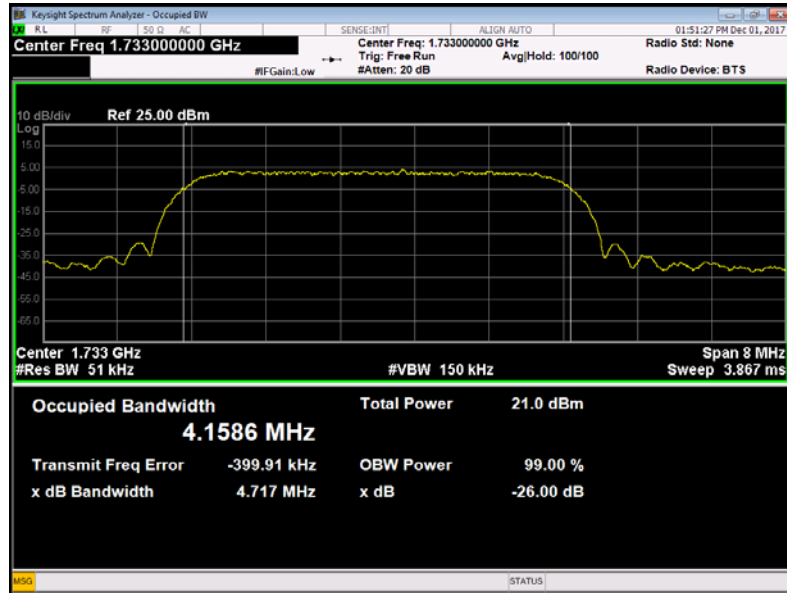

HSDPA

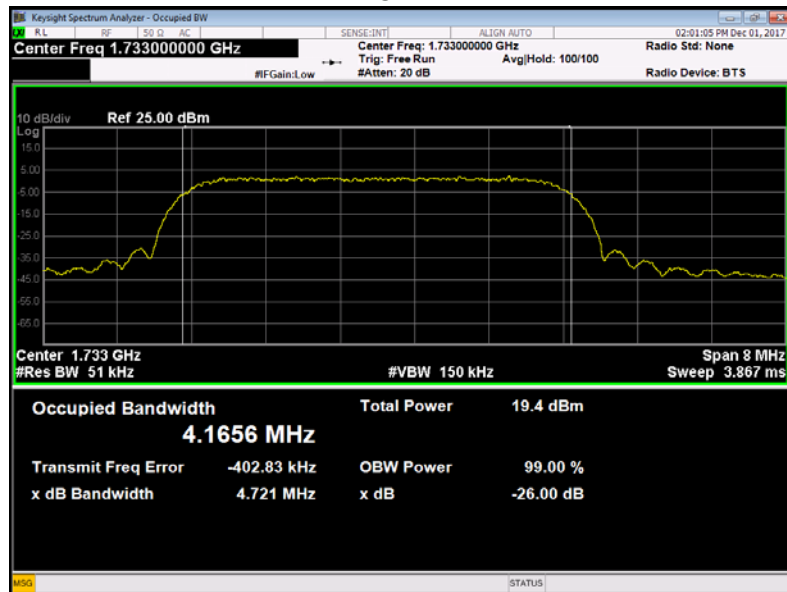

HSUPA

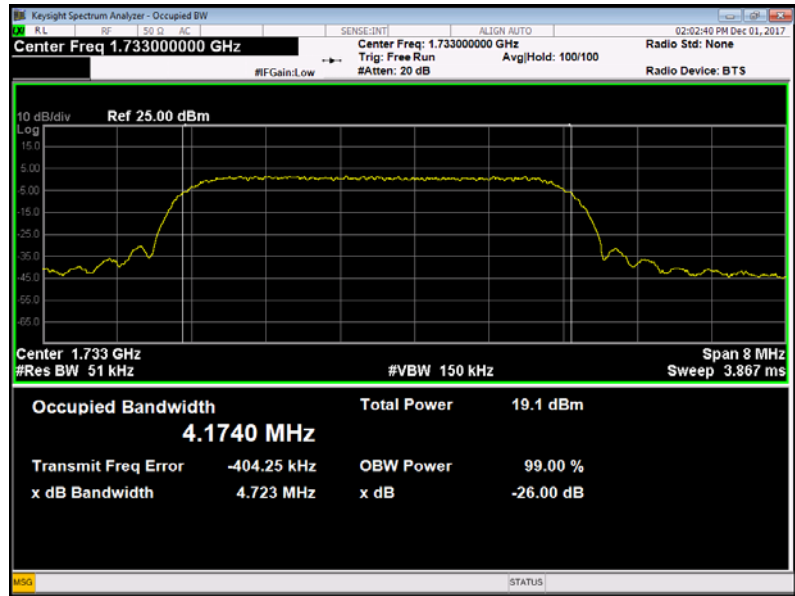

11 SPURIOUS EMISSIONS AT ANTENNA TERMINALS

Test Requirement:	FCC Part 2.1051, 22.917(a), 24.238(a), 27.53(h)
Test Method:	TIA/EIA-603-D:2010 KDB971168 D01 v02r02
Test Mode:	TX transmitting

11.1 EUT Operation

Operating Environment :

Temperature:	23.5 °C
Humidity:	52.1 % RH
Atmospheric Pressure:	101.3kPa

11.2 Test Procedure

The RF output of the transceiver was connected to a spectrum analyzer and simulator through appropriate attenuation. The resolution bandwidth of the spectrum analyzer was set at 1MHz. Sufficient scans were taken to show any out of band emissions up to 10th harmonics.

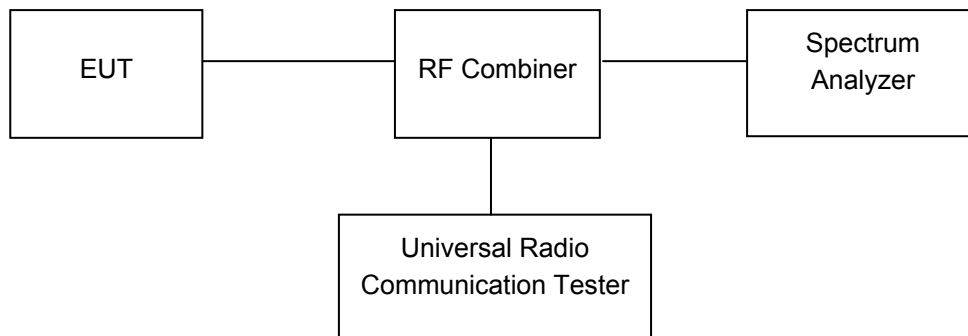

11.3 Test Result

Remark: All test data were reported and only the worst case (middle channel mode) test graphs were showed in test report.

Cellular Band (Part 22H)

GSM 850 - channel 190

30MHz-1GHz

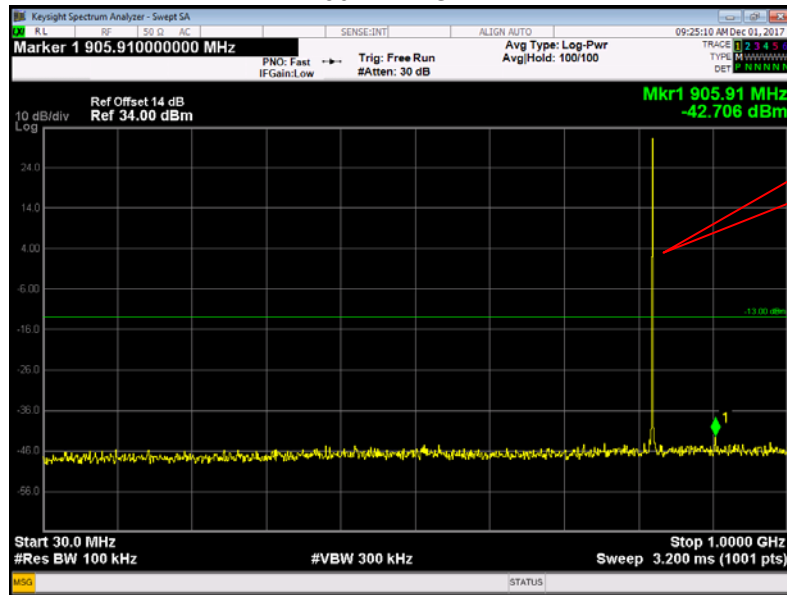

Above 1GHz

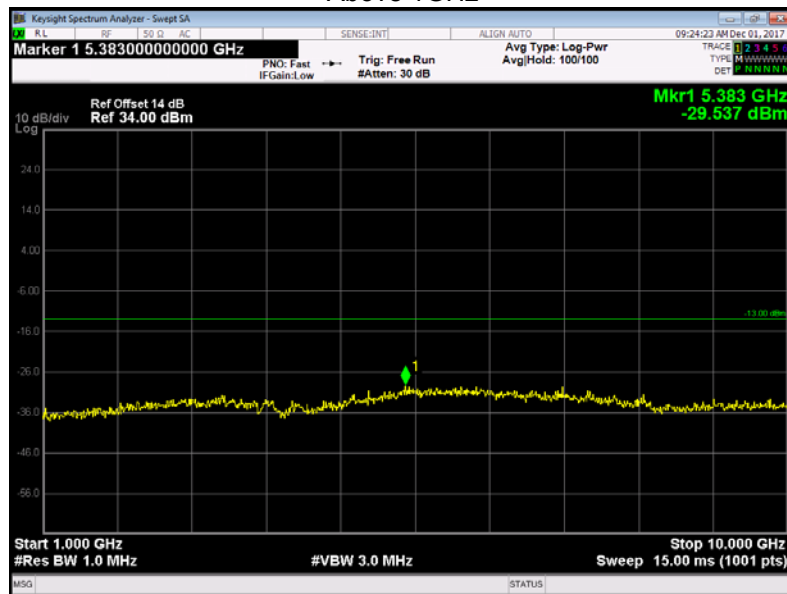

Cellular Band (Part 22H)

GPRS 850 - channel 190

30MHz-1GHz

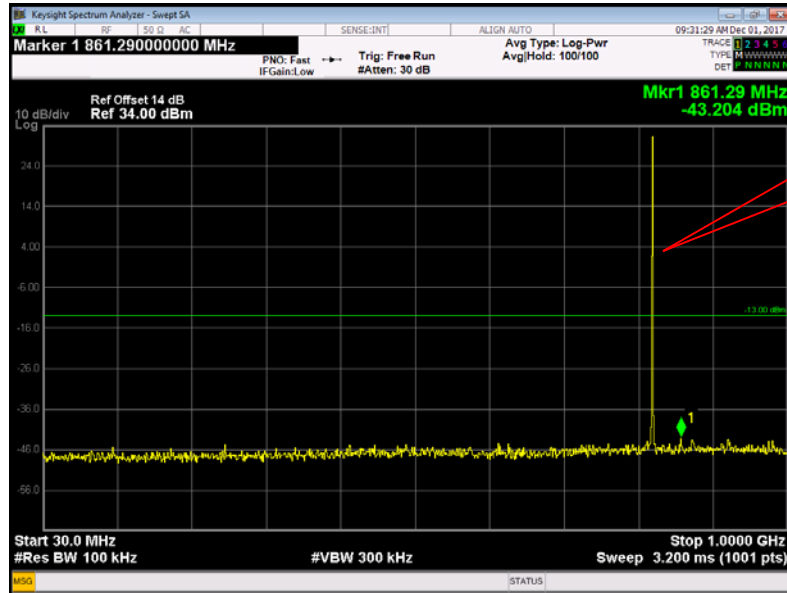

Above 1GHz

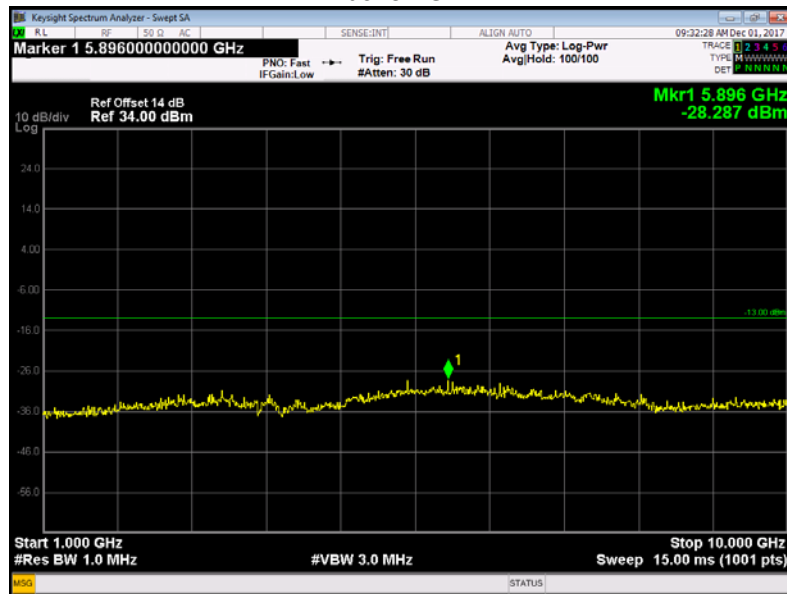

Cellular Band (Part 22H)
EGPRS 850 - channel 190
30MHz-1GHz

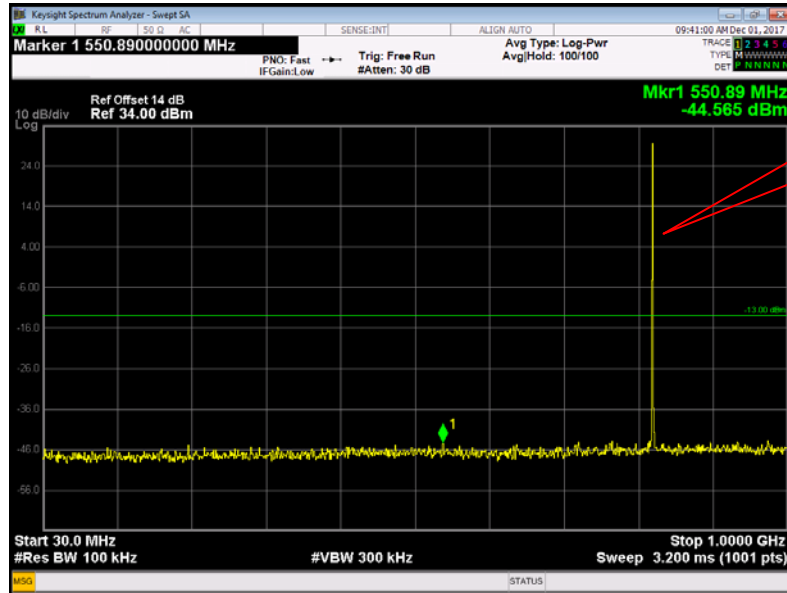

Fundamental

Above 1GHz

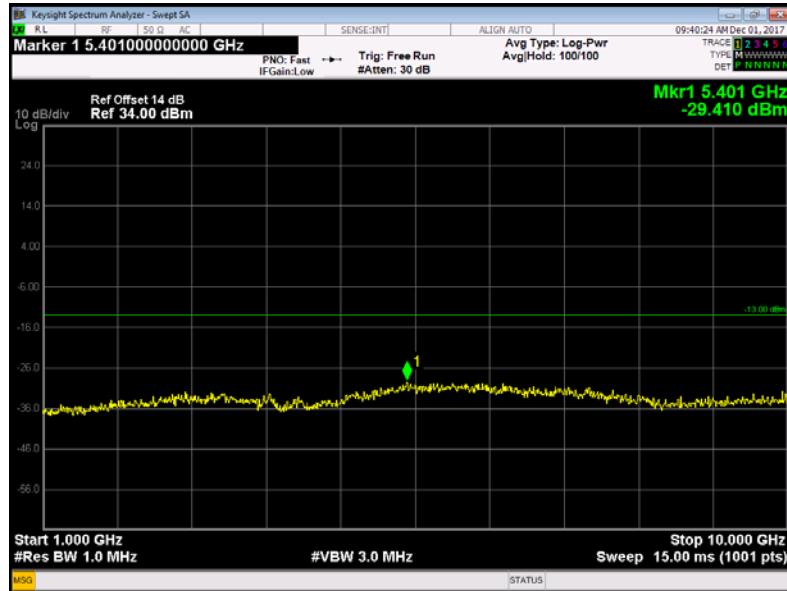

WCDMA band V - channel 4183

30MHz-1GHz

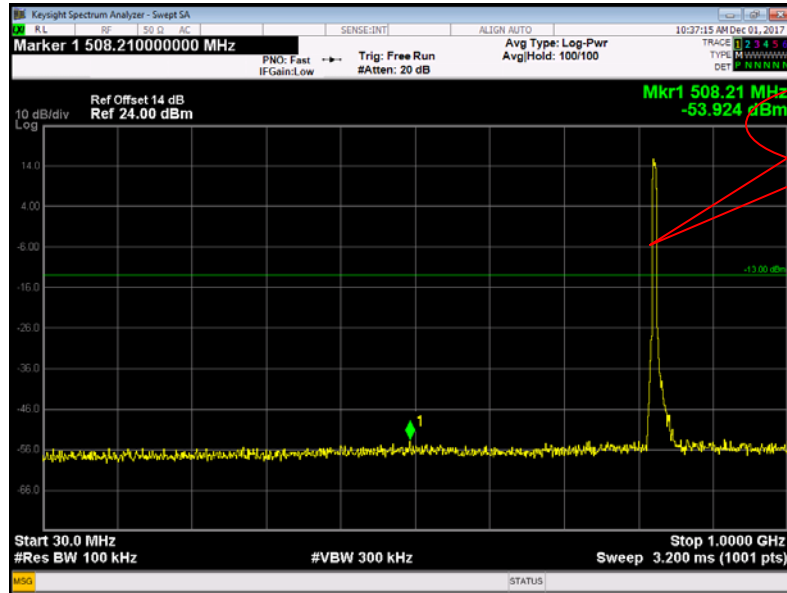

Fundamental

Above 1GHz

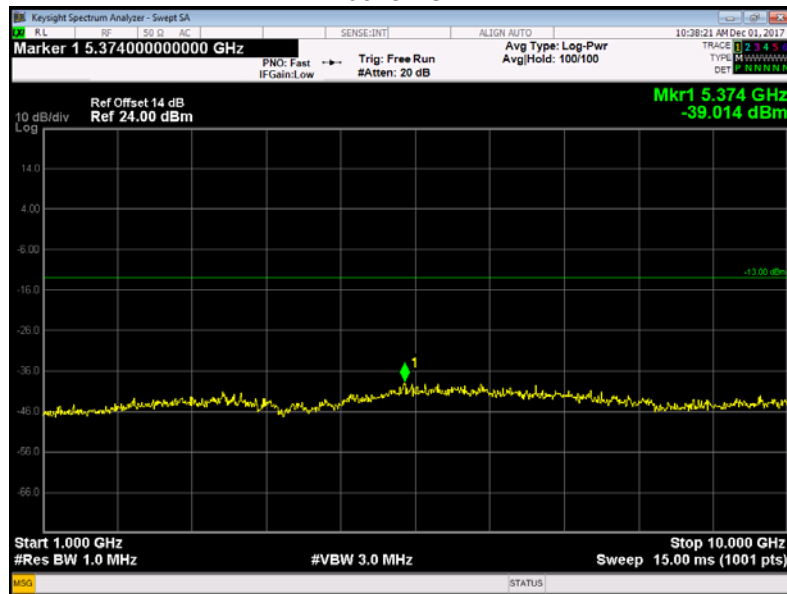

WCDMA band V - channel 4183 (HSDPA)

30MHz-1GHz

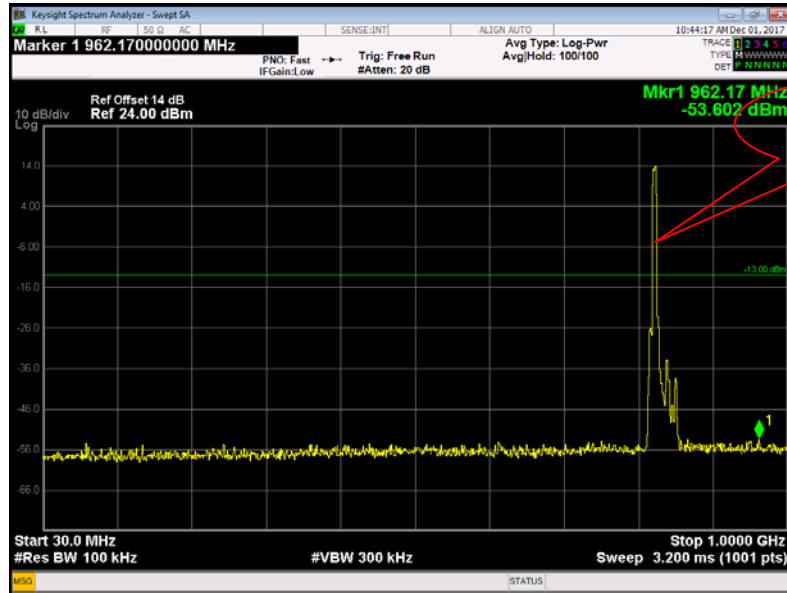

Above 1GHz

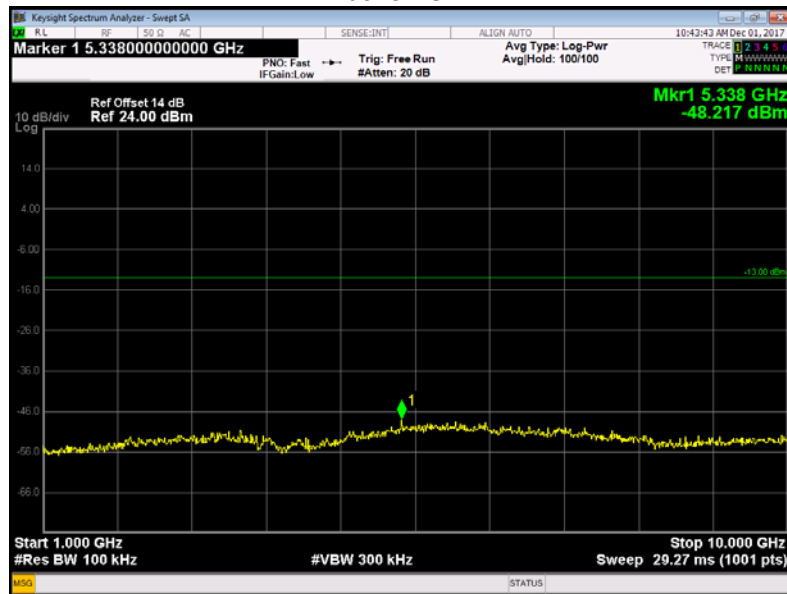

WCDMA band V - channel 4183 (HSUPA)

30MHz-1GHz

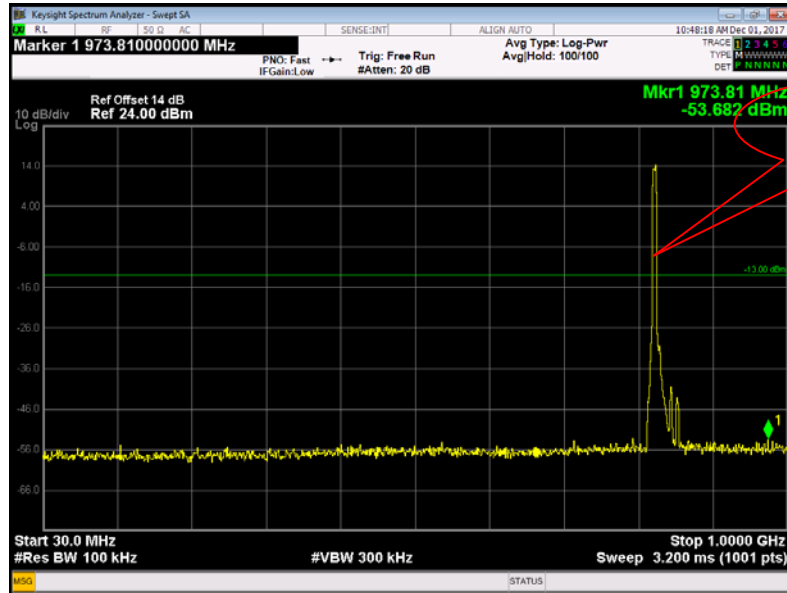

Above 1GHz

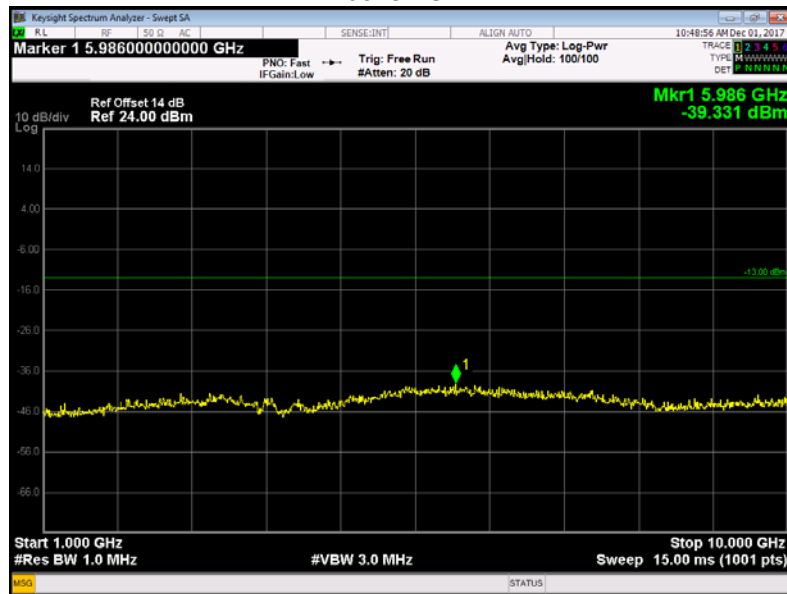

Cellular Band (Part 24E)

PCS 1900 - channel 661

30MHz-1GHz

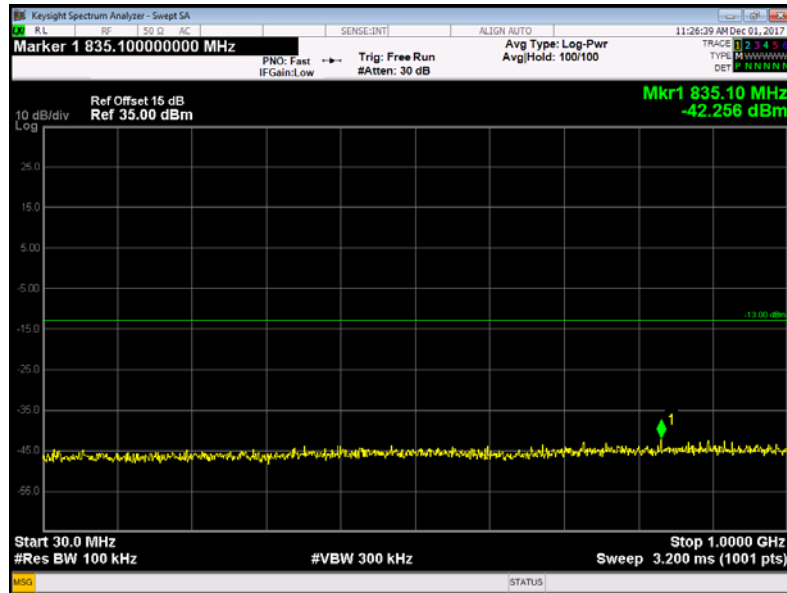

Above 1GHz

Fundamental



Cellular Band (Part 24E)
GPRS 1900 - channel 661
30MHz-1GHz

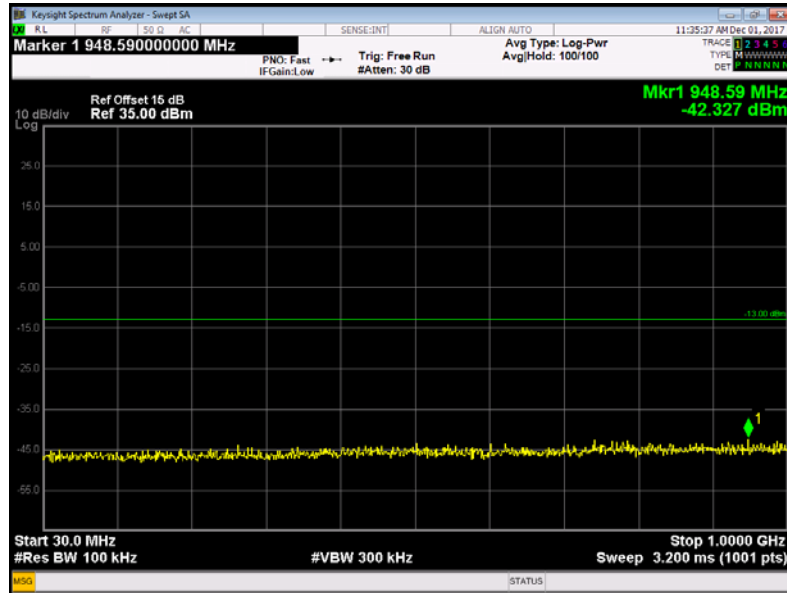

Above 1GHz

Fundamental

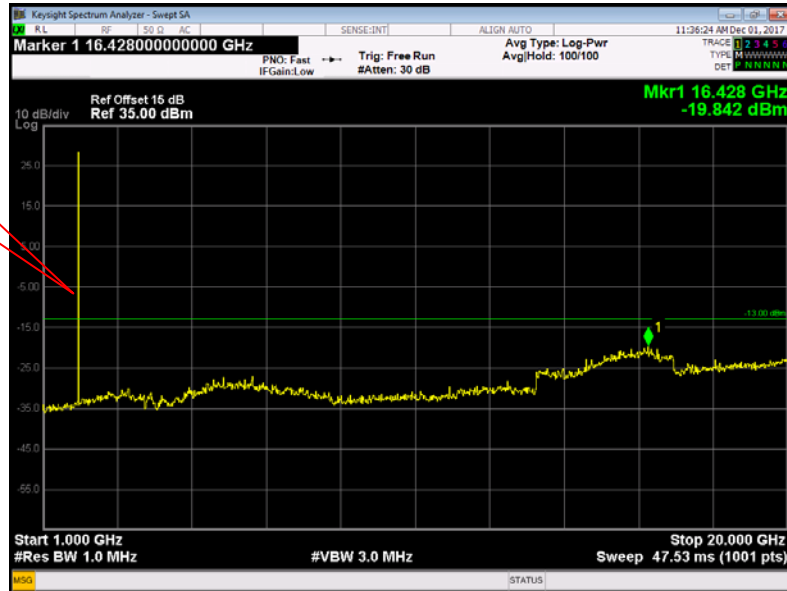

Cellular Band (Part 24E)
EGPRS 1900 - channel 661
30MHz-1GHz

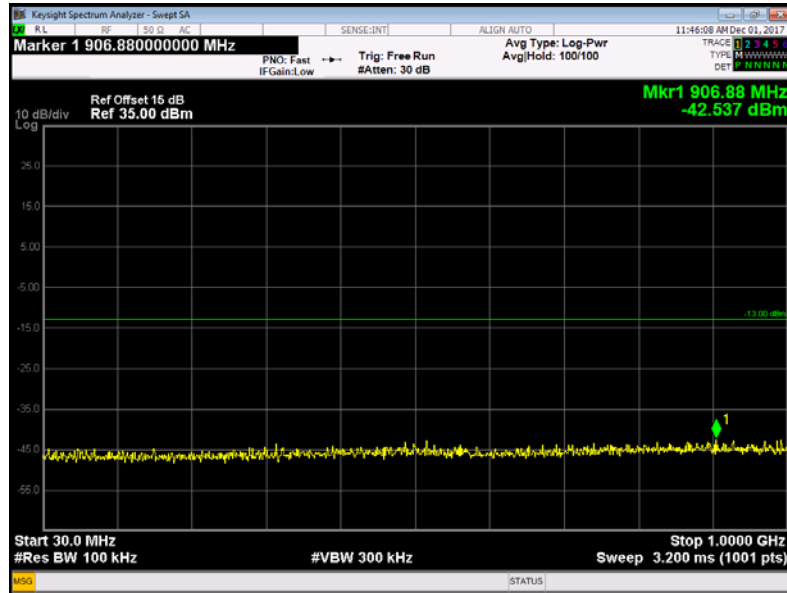

Above 1GHz

Fundamental



WCDMA band II - channel 9400

30MHz-1GHz

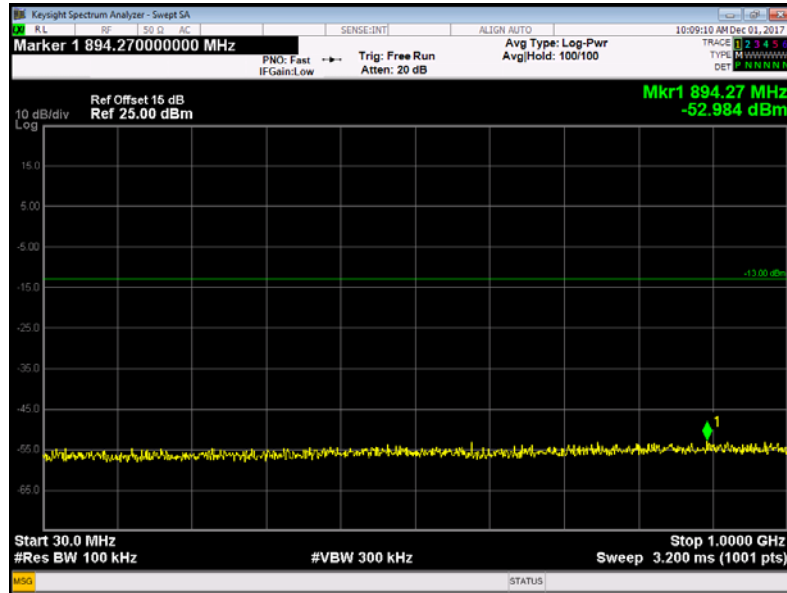

Above 1GHz

Fundamental

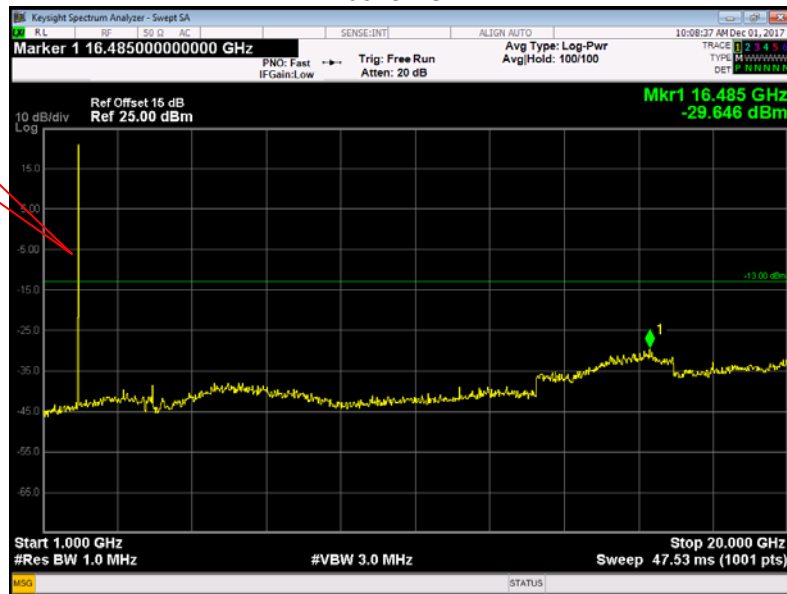

WCDMA band II - channel 9400 (HSDPA)

30MHz-1GHz

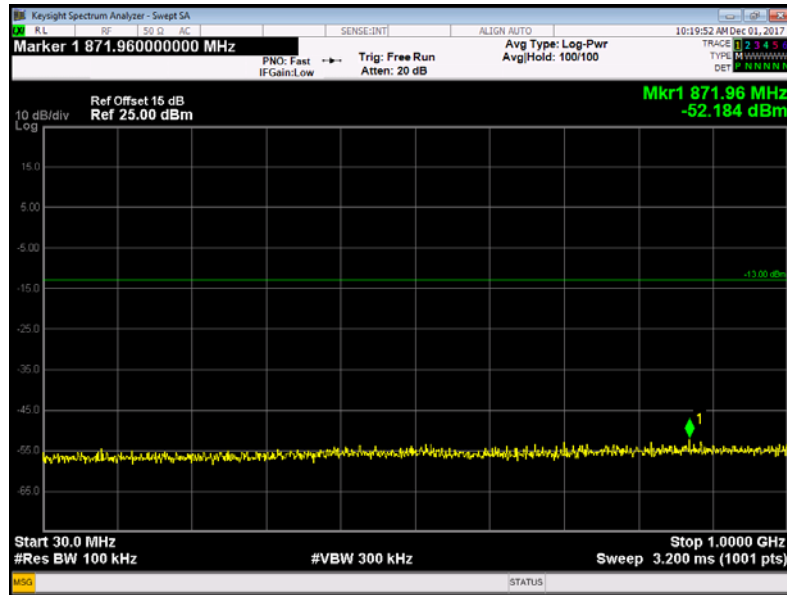

Above 1GHz

Fundamental



WCDMA band II - channel 9400 (HSUPA)

30MHz-1GHz

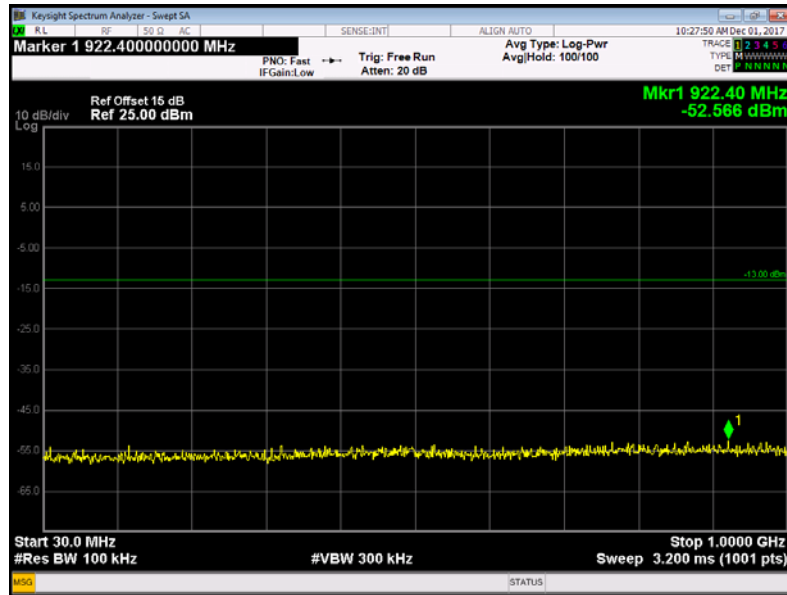

Above 1GHz

Fundamental

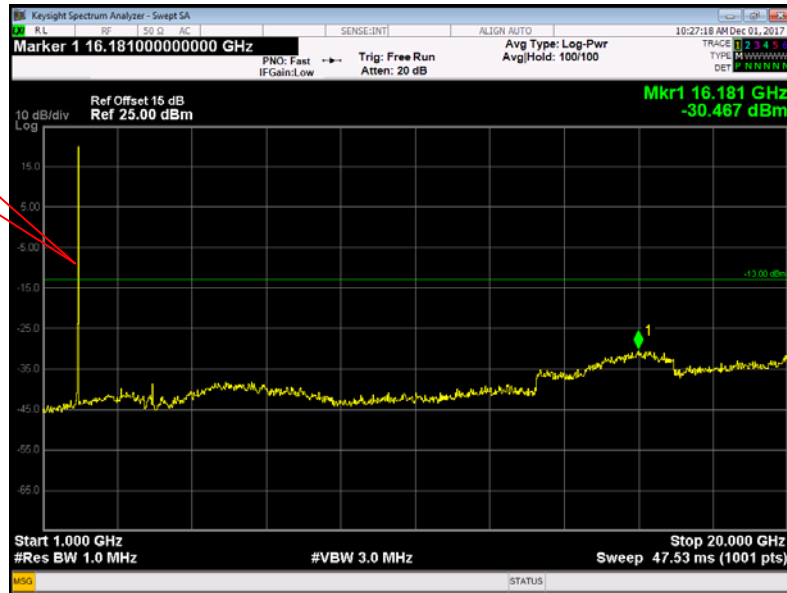

(Part 27)

WCDMA band IV - channel 1413

30MHz-1GHz

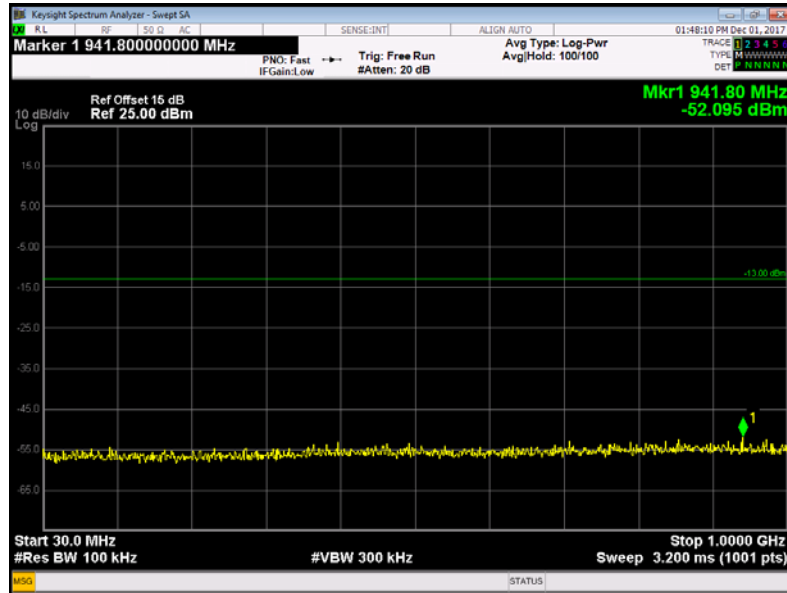

Above 1GHz

Fundamental



WCDMA band IV - channel 1413 (HSDPA)

30MHz-1GHz

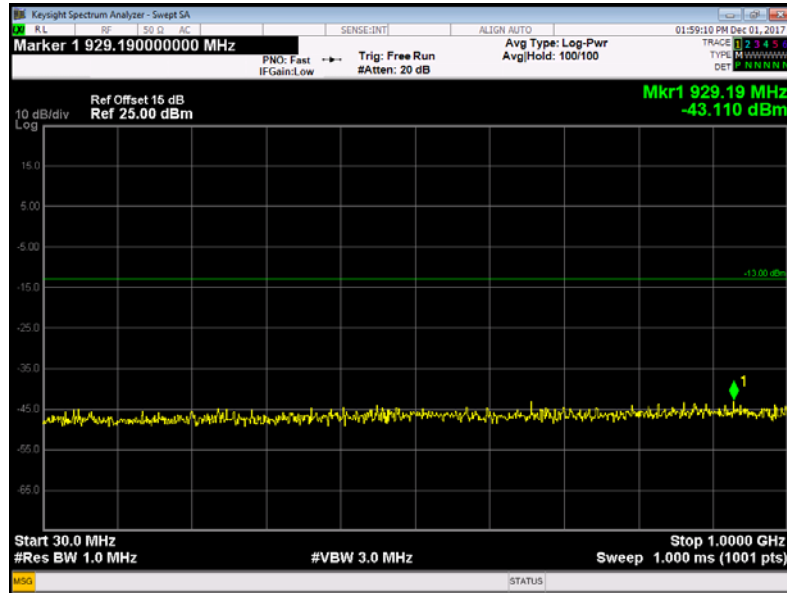

Above 1GHz

Fundamental

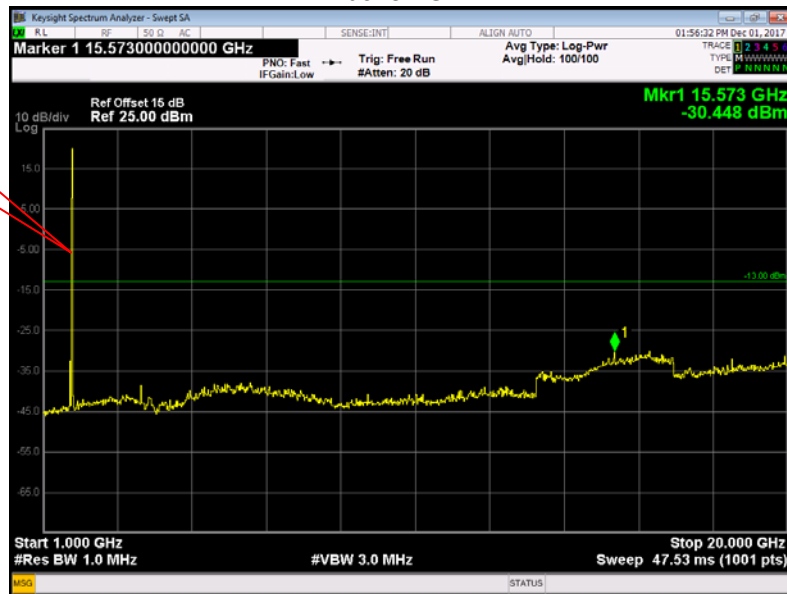

WCDMA band IV - channel 1413 (HSUPA)

30MHz-1GHz

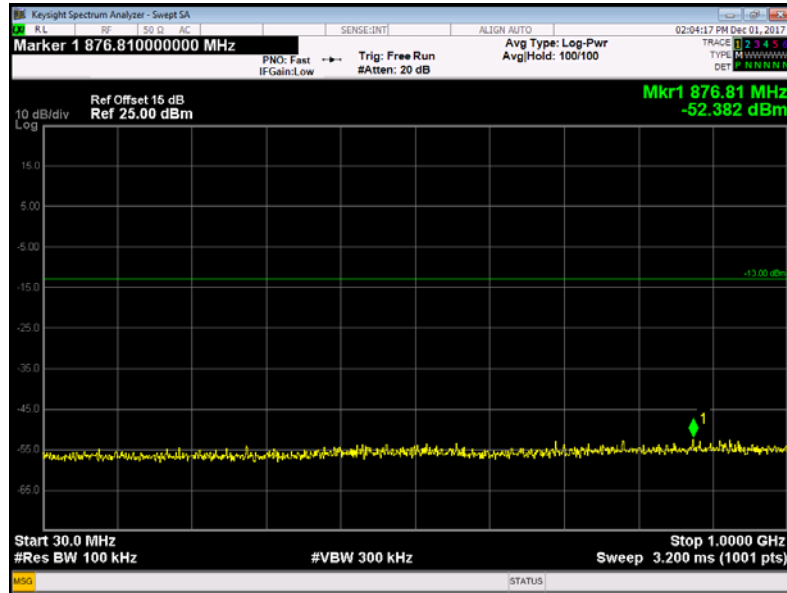

Above 1GHz

Fundamental

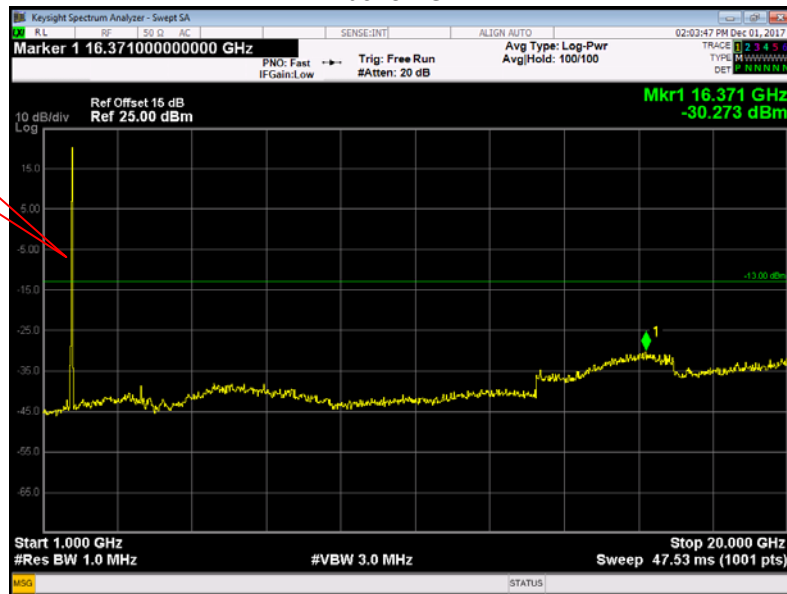

12 SPURIOUS RADIATED EMISSIONS

Test Requirement: FCC Part 2.1053, 22.917, 24.238, 27.53(h)

Test Method: TIA/EIA-603-D:2010
KDB971168 D01 v02r02

Test Mode: TX transmitting

12.1 EUT Operation

Operating Environment :

Temperature: 23.5 °C

Humidity: 52.1 % RH

Atmospheric Pressure: 101.2kPa

12.2 Test Setup

The radiated emission tests were performed in the 3m Semi- Anechoic Chamber test site, using the setup accordance with the test setup for emission measurement from 30 MHz to 1 GHz.

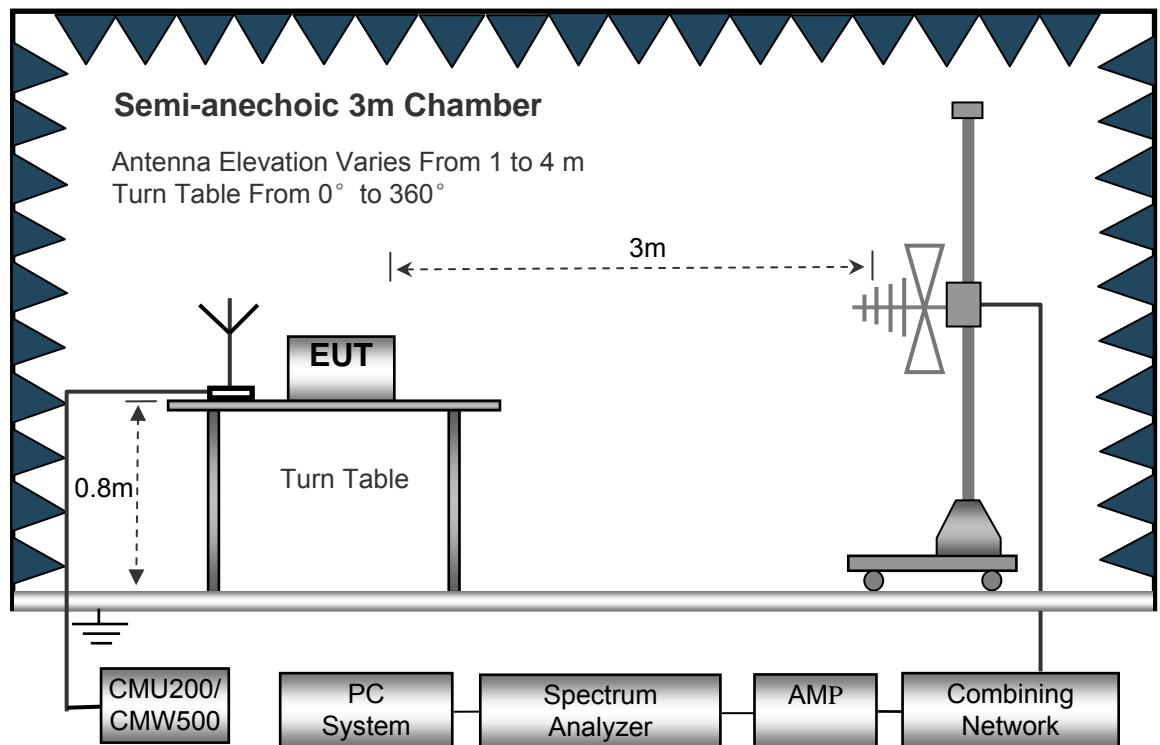

The test setup for emission measurement above 1 GHz.

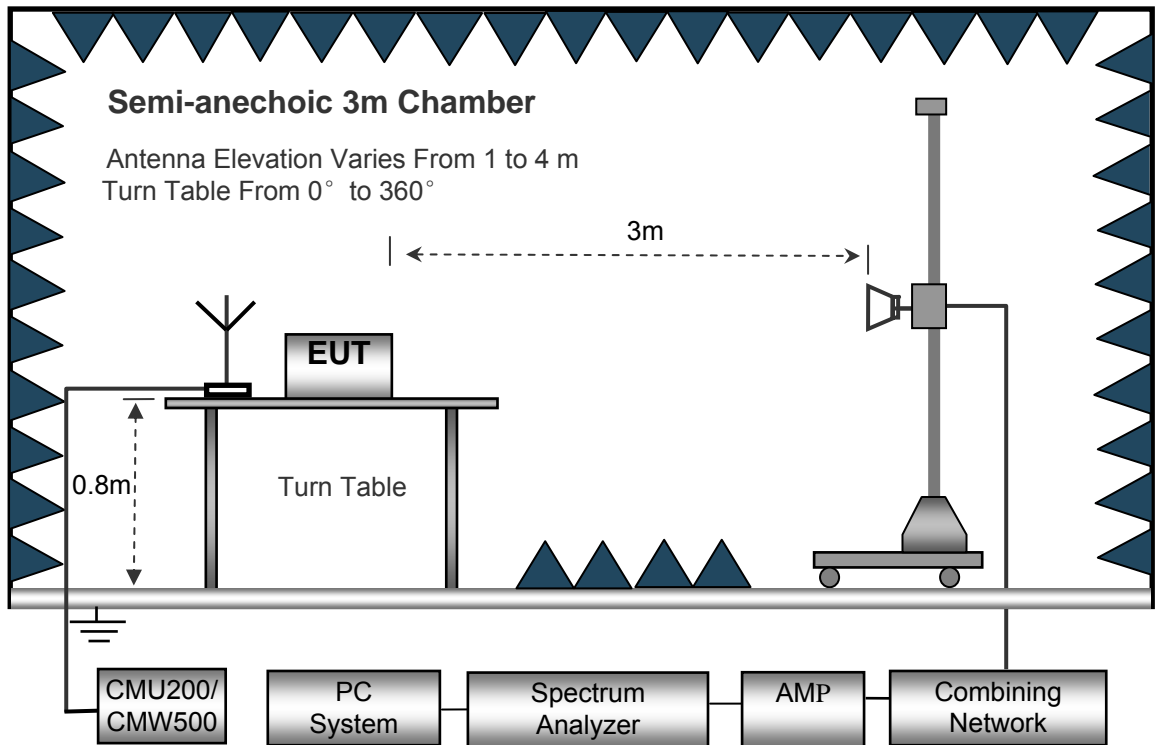

12.3 Spectrum Analyzer Setup

30MHz ~ 1GHz

Sweep Speed Auto
 Detector PK
 Resolution Bandwidth..... 100kHz
 Video Bandwidth..... 300kHz

Above 1GHz

Sweep Speed Auto
 Detector PK
 Resolution Bandwidth..... 1MHz
 Video Bandwidth..... 3MHz
 Detector Ave.
 Resolution Bandwidth..... 1MHz
 Video Bandwidth..... 10Hz

12.4 Test Procedure

1. The EUT is placed on a turntable, which is 0.8m above ground plane.
2. The turntable shall be rotated for 360 degrees to determine the position of maximum emission level.
3. EUT is set 3m away from the receiving antenna, which is moved from 1m to 4m to find out the maximum emissions. The spectrum was investigated from 30MHz up to the tenth harmonic of the highest fundamental frequency.
4. Maximum procedure was performed on the six highest emissions to ensure EUT compliance.
5. And also, each emission was to be maximized by changing the polarization of receiving antenna both horizontal and vertical.
6. The radiation measurements are tested under 3-axes(X,Y,Z) position(X denotes lying on the table, Y denotes side stand and Z denotes vertical stand), After pre-test, It was found that the worse radiation emission was get at the Z position. So the data shown was the Z position only.
7. Remove the EUT and replace it with substitution antenna. A signal generator was connected to the substitution antenna by a non-radiating cable. The absolute levels of the spurious emissions were measured by the substitution.

Spurious emissions in dB = $10 \lg (\text{TXpwr in Watts}/0.001)$ – the absolute level

Spurious attenuation limit in dB = $43 + 10 \text{Log}_{10} (\text{power out in Watts})$

8. Repeat above procedures until the measurements for all frequencies are completed.

12.5 Summary of Test Results

For 26MHz~30MHz,

The measurements were more than 20 dB below the limit and not reported.

Remark: Test performed from 30MHz to 10th harmonics with low/middle/high channels, only the worst data were recorded.

Cellular Band (Part 22H)

Frequency	Receiver Reading	Turn table Angle	RX Antenna		Substituted			Absolute Level	Result	
			Height	Polar	SG Level	Cable	Antenna Gain		Limit	Margin
(MHz)	(dBμV)	Degree	(m)	(H/V)	(dBm)	(dB)	(dB)	(dBm)	(dBm)	(dB)
GSM 850 Channel 128										
199.38	41.43	172	1.3	H	-69.08	0.15	0.00	-69.23	-13.00	-56.23
199.38	45.65	101	1.4	V	-61.94	0.15	0.00	-62.09	-13.00	-49.09
1648.40	67.84	11	1.3	H	-46.13	0.30	9.40	-37.03	-13.00	-24.03
1648.40	58.32	212	1.0	V	-55.21	0.30	9.40	-46.11	-13.00	-33.11
2472.60	57.83	318	1.9	H	-56.17	0.43	10.60	-46.00	-13.00	-33.00
2472.60	48.14	249	1.0	V	-62.14	0.43	10.60	-51.97	-13.00	-38.97
WCDMA Band V Channel 4233										
199.38	41.92	352	1.0	H	-68.59	0.15	0.00	-68.74	-13.00	-55.74
199.38	46.11	309	1.1	V	-61.48	0.15	0.00	-61.63	-13.00	-48.63
1652.80	58.20	10	1.6	H	-55.77	0.30	9.40	-46.67	-13.00	-33.67
1652.80	49.68	59	1.1	V	-63.85	0.30	9.40	-54.75	-13.00	-41.75
2479.20	48.58	204	1.3	H	-65.42	0.43	10.60	-55.25	-13.00	-42.25
2479.20	38.92	86	1.4	V	-71.36	0.43	10.60	-61.19	-13.00	-48.19

Cellular Band (Part 24E/27)

Frequency	Receiver Reading	Turn table Angle	RX Antenna		Substituted			Absolute Level	Result	
			Height	Polar	SG Level	Cable	Antenna Gain		Limit	Margin
(MHz)	(dB μ V)	Degree	(m)	(H/V)	(dBm)	(dB)	(dB)	(dBm)	(dBm)	(dB)
PCS 1900 Channel 512										
199.38	48.94	211	2.2	H	-61.57	0.15	0.00	-61.72	-13.00	-48.72
199.38	38.21	147	1.9	V	-69.38	0.15	0.00	-69.53	-13.00	-56.53
3700.40	65.95	33	1.3	H	-45.59	2.37	12.50	-35.46	-13.00	-22.46
3700.40	59.98	109	1.8	V	-49.83	2.37	12.50	-39.70	-13.00	-26.70
5550.60	53.58	337	2.1	H	-56.03	2.86	12.90	-45.99	-13.00	-32.99
5550.60	44.73	307	1.4	V	-64.15	2.86	12.90	-54.11	-13.00	-41.11
WCDMA Band II Channel 9400										
199.38	48.27	249	1.7	H	-62.24	0.15	0.00	-62.39	-13.00	-49.39
199.38	39.40	173	2.1	V	-68.19	0.15	0.00	-68.34	-13.00	-55.34
3760.00	58.41	301	2.2	H	-53.13	2.37	12.50	-43.00	-13.00	-30.00
3760.00	53.65	4	1.5	V	-56.16	2.37	12.50	-46.03	-13.00	-33.03
5640.00	47.34	185	1.0	H	-62.27	2.86	12.90	-52.23	-13.00	-39.23
5640.00	38.72	124	1.7	V	-70.16	2.86	12.90	-60.12	-13.00	-47.12
WCDMA Band IV Channel 1313										
199.38	48.45	289	1.8	H	-62.06	0.15	0.00	-62.21	-13.00	-49.21
199.38	39.94	110	1.5	V	-67.65	0.15	0.00	-67.80	-13.00	-54.80
3424.80	53.13	170	1.3	H	-58.41	2.37	12.50	-48.28	-13.00	-35.28
3424.80	46.88	310	1.6	V	-62.93	2.37	12.50	-52.80	-13.00	-39.80
5137.20	39.84	177	1.8	H	-69.77	2.86	12.90	-59.73	-13.00	-46.73
5137.20	31.69	239	1.5	V	-77.19	2.86	12.90	-67.15	-13.00	-54.15

Note: 1) Absolute Level = SG Level - Cable loss + Antenna Gain

2) Margin = Absolute Level - Limit

13 Band Edge Measurement

Test Requirement:	FCC Part 2.1051, 22.917(a), 24.238(a), 27.53(h)
Test Method:	TIA/EIA-603-D:2010 KDB971168 D01 v02r02
Test Mode:	TX transmitting

13.1 EUT Operation

Operating Environment :

Temperature:	23.5 °C
Humidity:	52.3 % RH
Atmospheric Pressure:	101.3kPa

13.2 Test Procedure

The RF output of the transmitter was connected to the input of the spectrum analyzer through sufficient attenuation.

According to FCC Part 22.917(a), the power of any emissions outside of the authorized operating frequency ranges must be attenuated below the transmitting power (P) by a factor of at least $43 + 10 \log(P)$ dB.

According to FCC Part 24.238(a), the power of any emissions outside of the authorized operating frequency ranges must be attenuated below the transmitting power (P) by a factor of at least $43 + 10 \log(P)$ dB.

According to FCC Part 27.53(h), Except as otherwise specified below, for operations in the 1695-1710 MHz, 1710-1755 MHz, 1755-1780 MHz, 1915-1920 MHz, 1995-2000 MHz, 2000-2020 MHz, 2110-2155 MHz, 2155-2180 MHz, and 2180-2200 bands, the power of any emission outside a licensee's frequency block shall be attenuated below the transmitter power (P) in watts by at least $43 + 10 \log_{10}(P)$ dB.

The center of the spectrum analyzer was set to block edge frequency

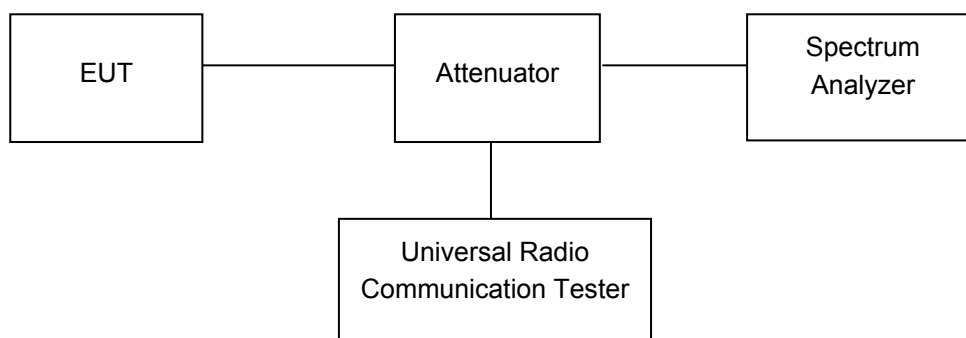

13.3 Test Result

Test plots

Cellular Band (Part 22H)

GSM 850 band edge-left side

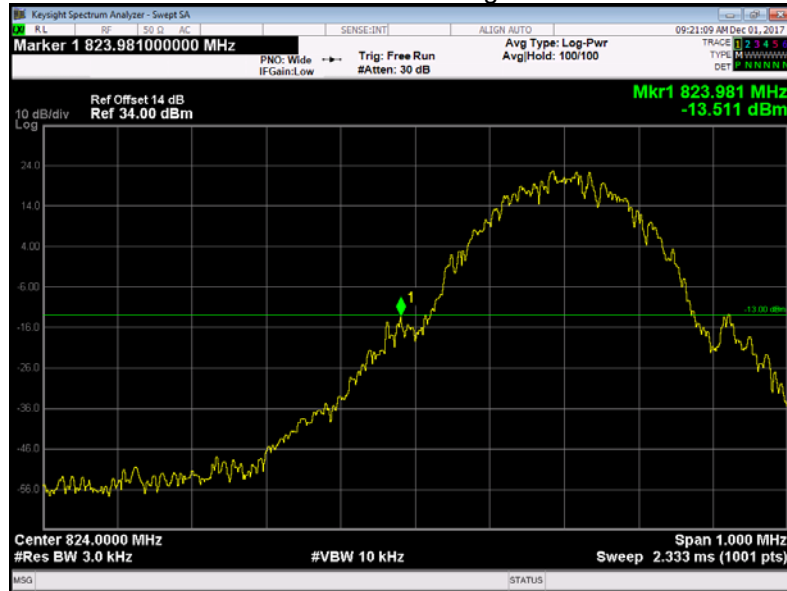

GSM 850 band edge-right side



GPRS 850 band edge-left side

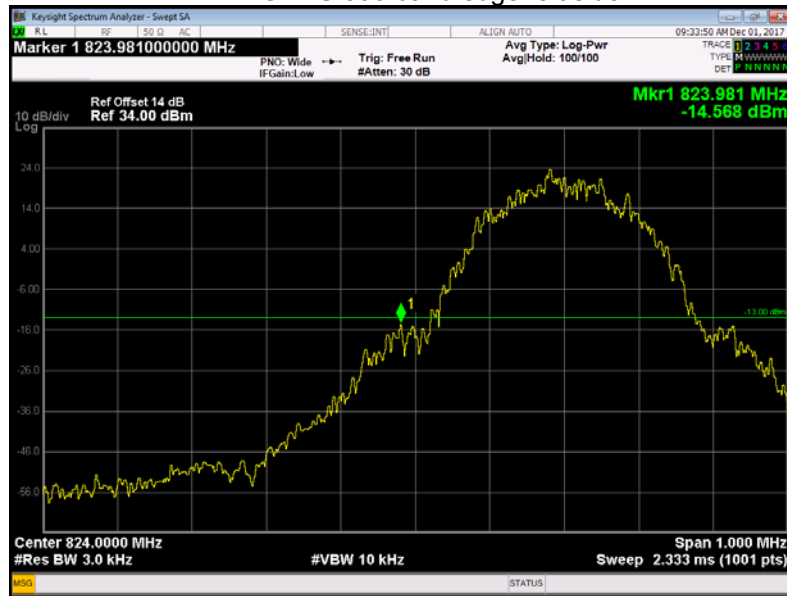

GPRS 850 band edge-right side



EGPRS 850 band edge-left side

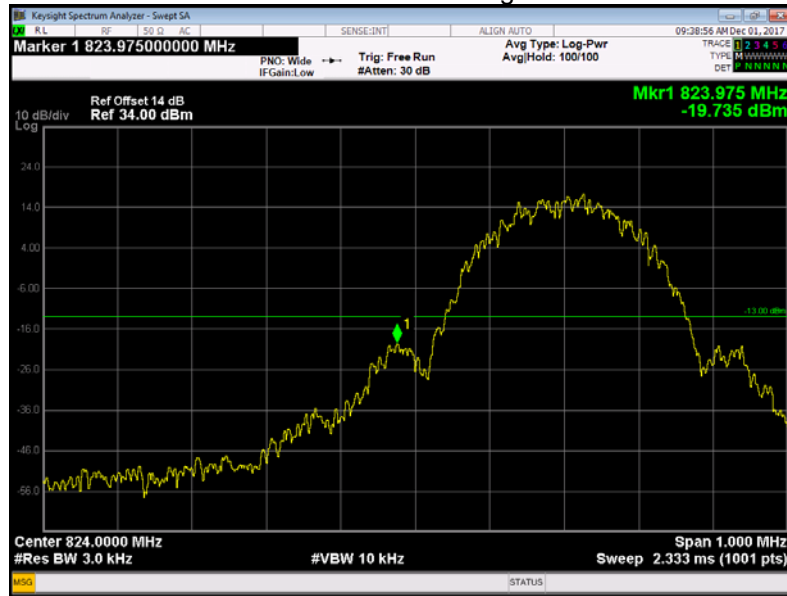

EGPRS 850 band edge-right side



WCDMA band V band edge-left side

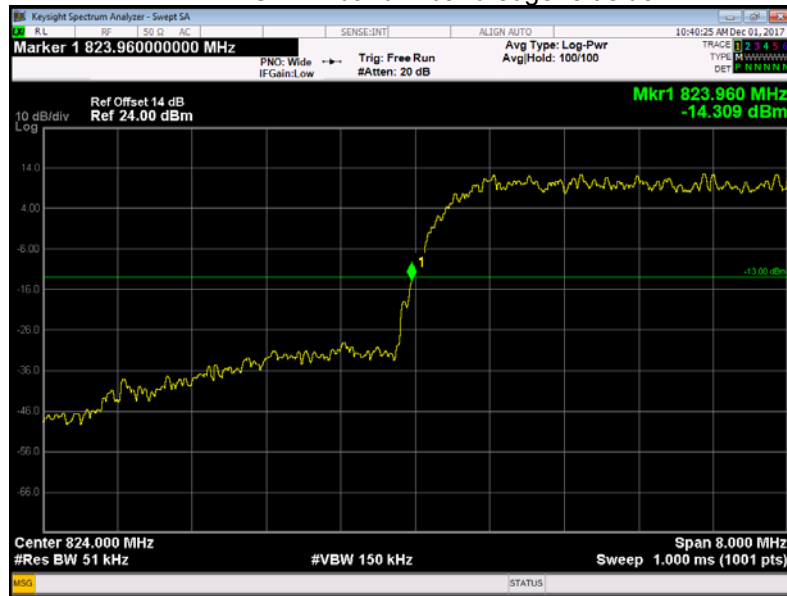

WCDMA band V band edge-right side

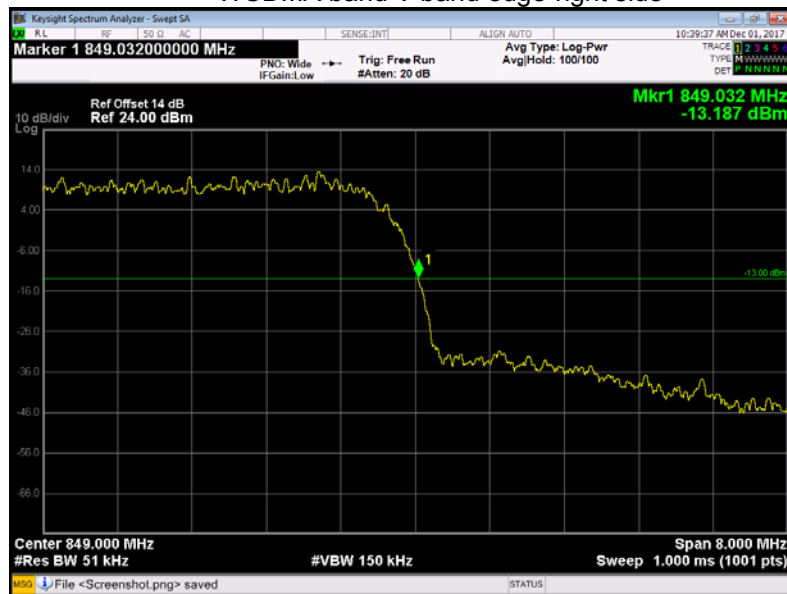

WCDMA band V band edge-left side (HSDPA)

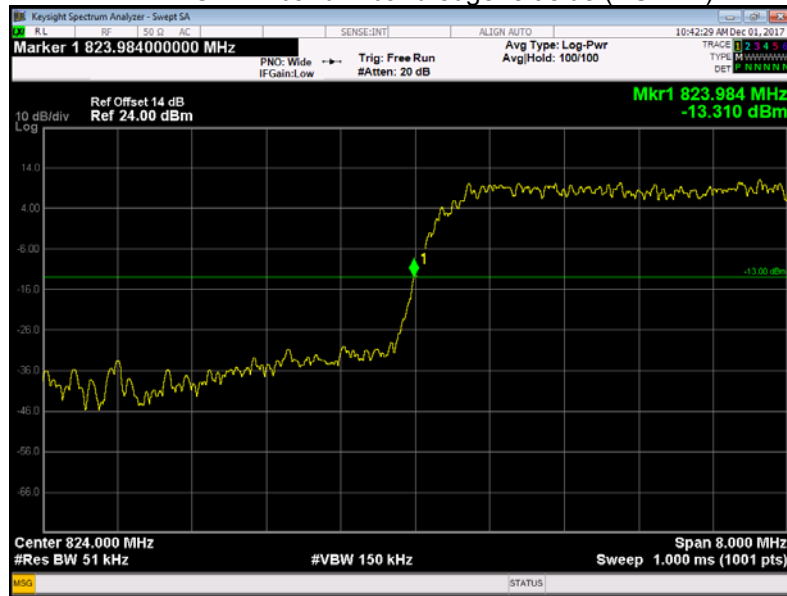

WCDMA band V band edge-right side (HSDPA)

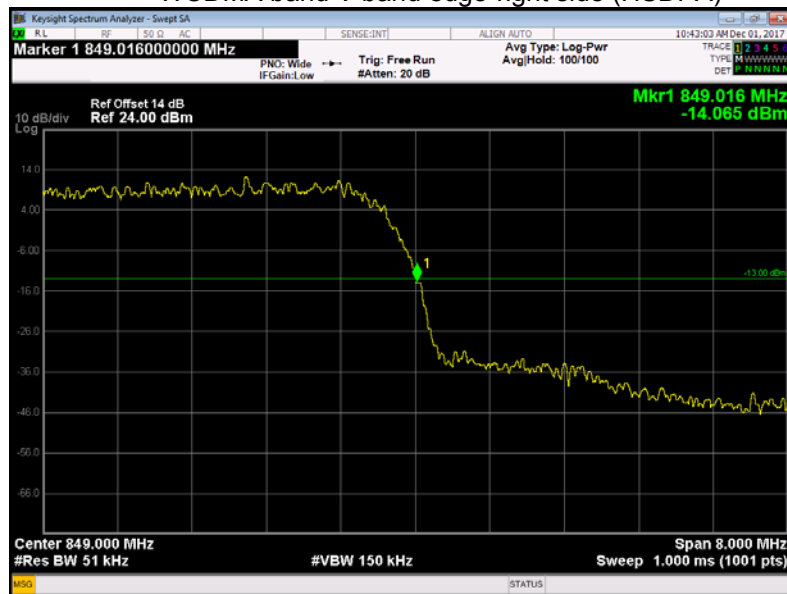

WCDMA band V band edge-left side (HSUPA)

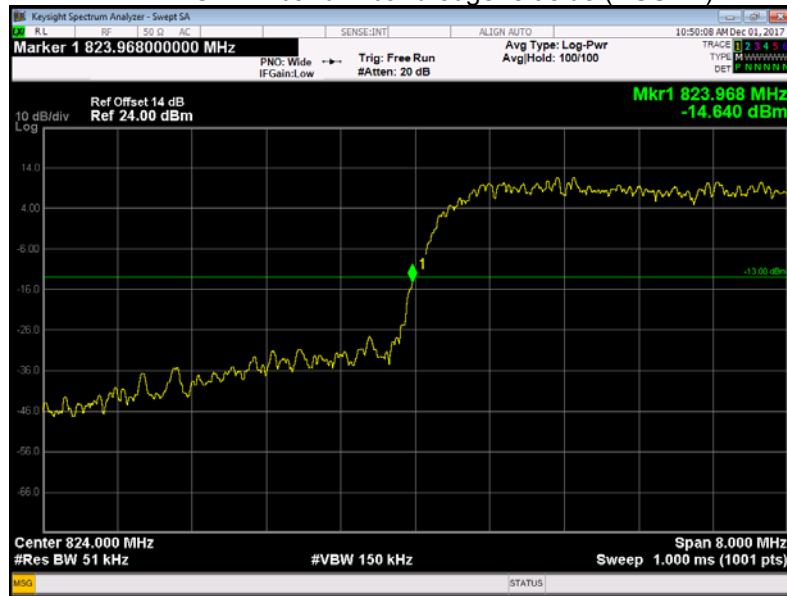

WCDMA band V band edge-right side (HSUPA)

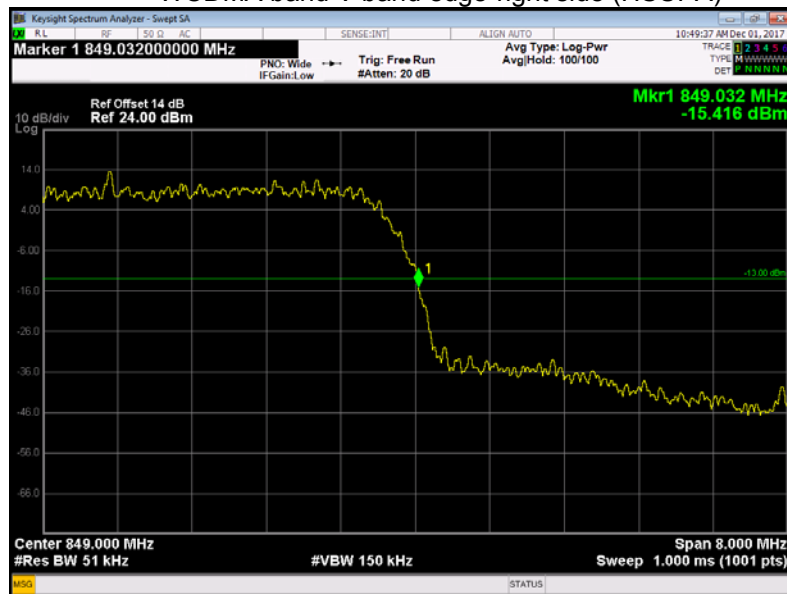

Cellular Band (Part 24E)

PCS 1900 band edge-left side

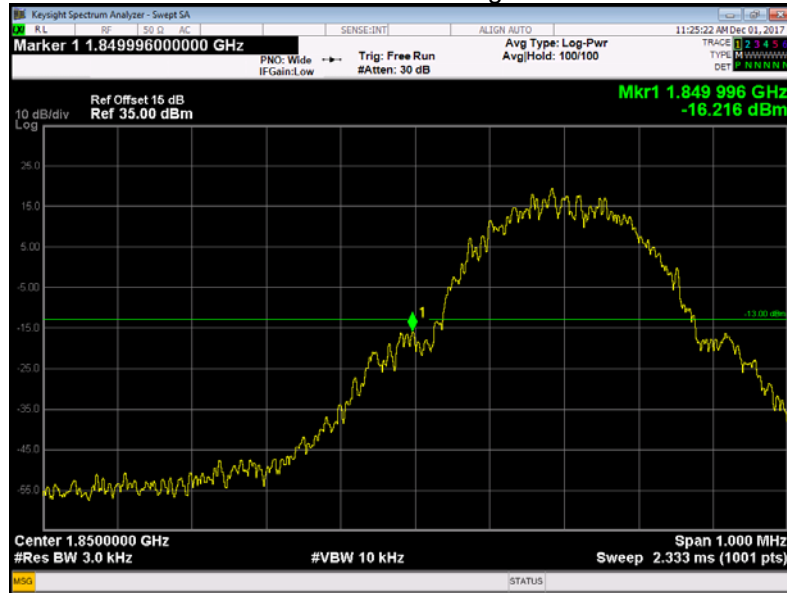

PCS 1900 band edge-right side



GPRS 1900 band edge-left side

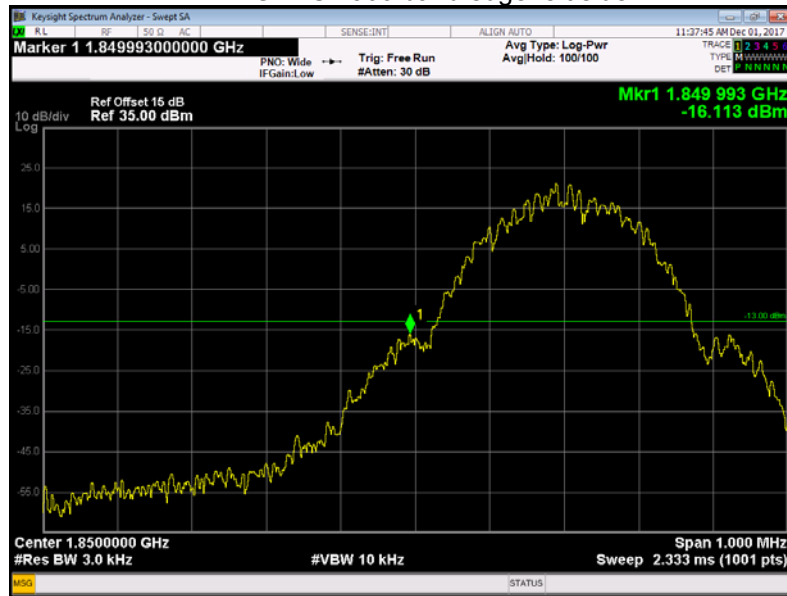

GPRS 1900 band edge-right side

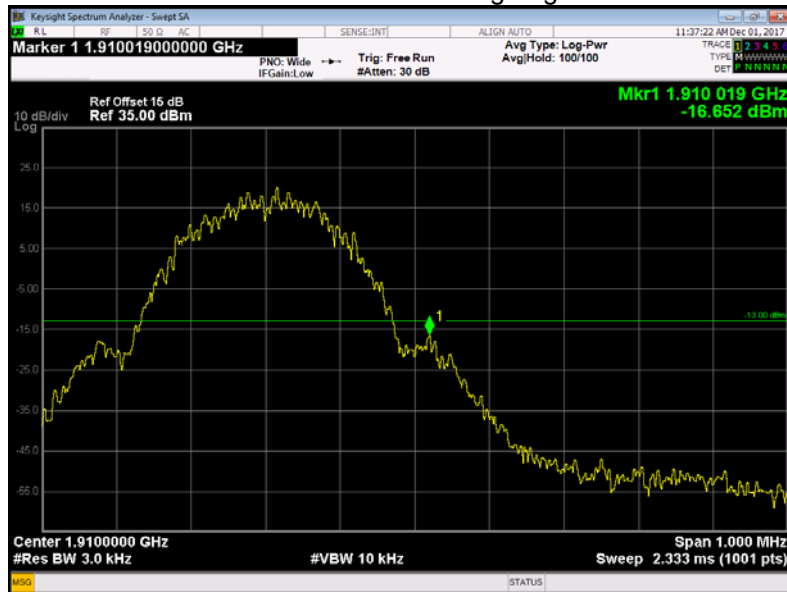

EGPRS 1900 band edge-left side

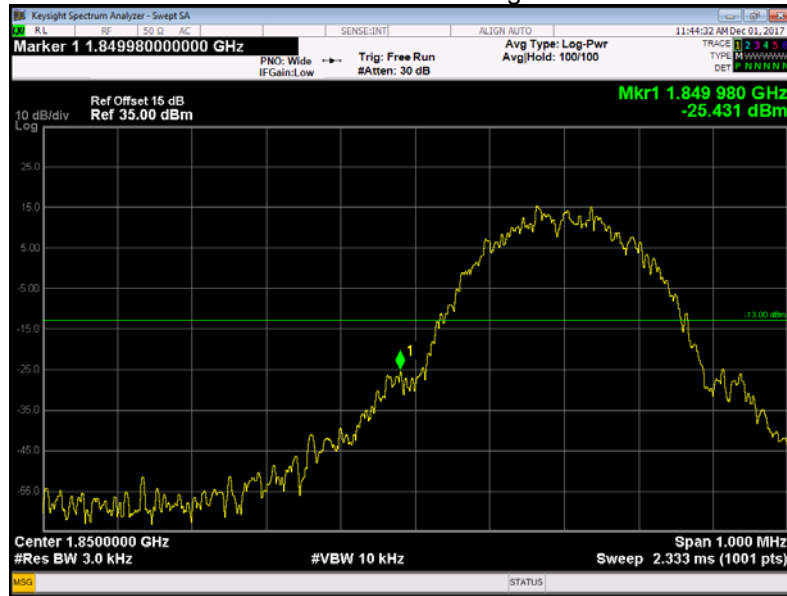

EGPRS 1900 band edge-right side



WCDMA band II band edge-left side

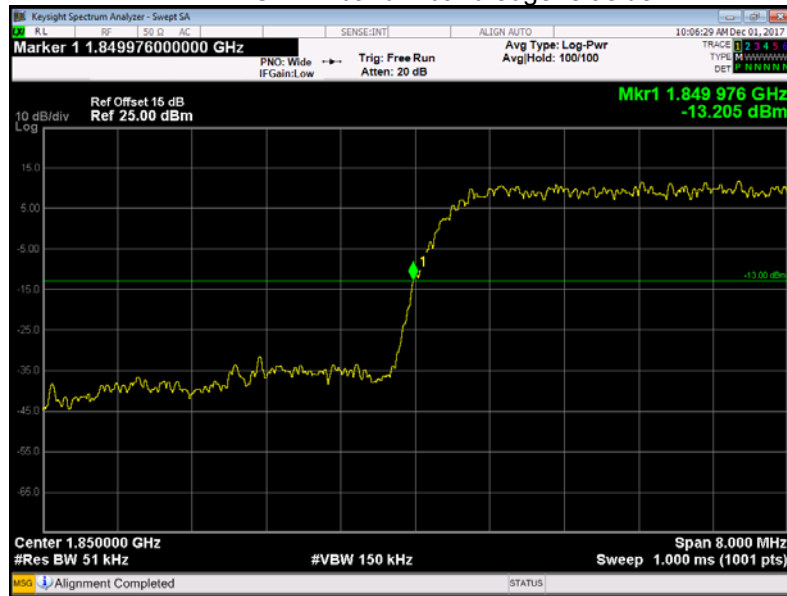

WCDMA band II band edge-right side

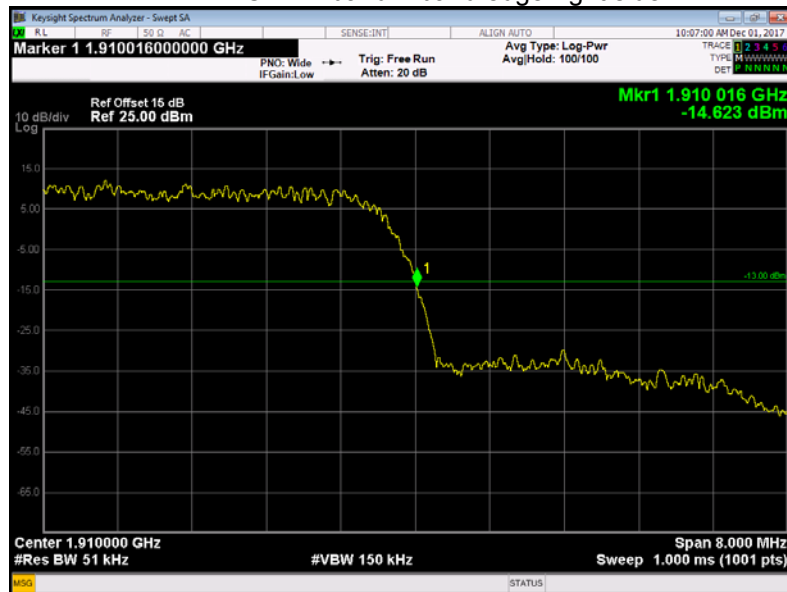

WCDMA band II band edge-left side (HSDPA)

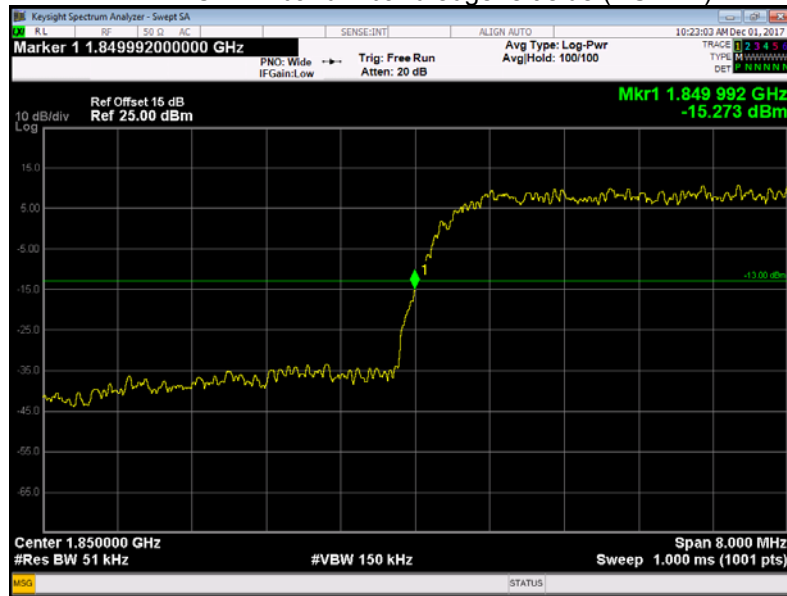

WCDMA band II band edge-right side (HSDPA)

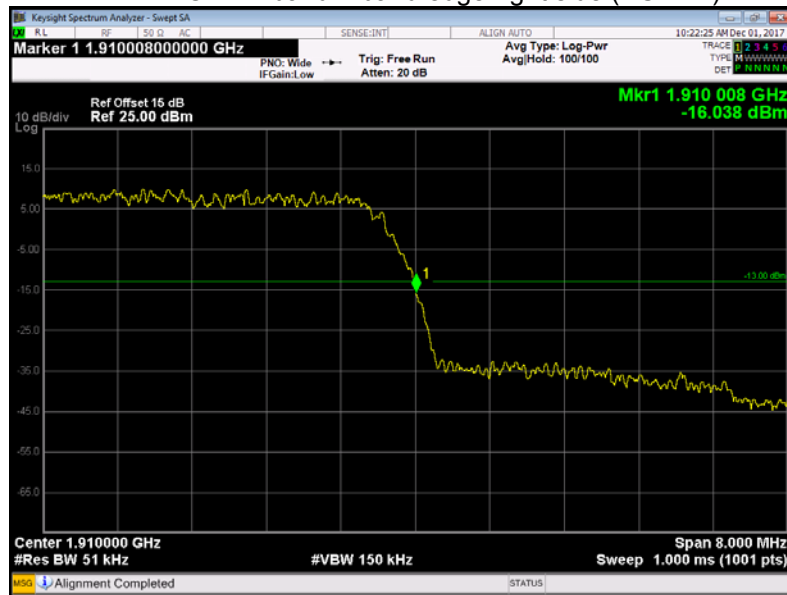

WCDMA band II band edge-left side (HSUPA)

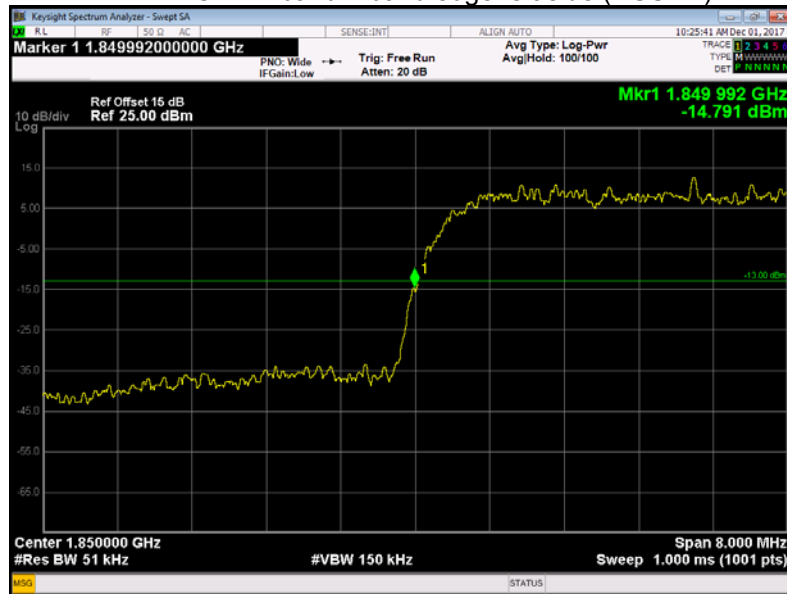

WCDMA band II band edge-right side (HSUPA)

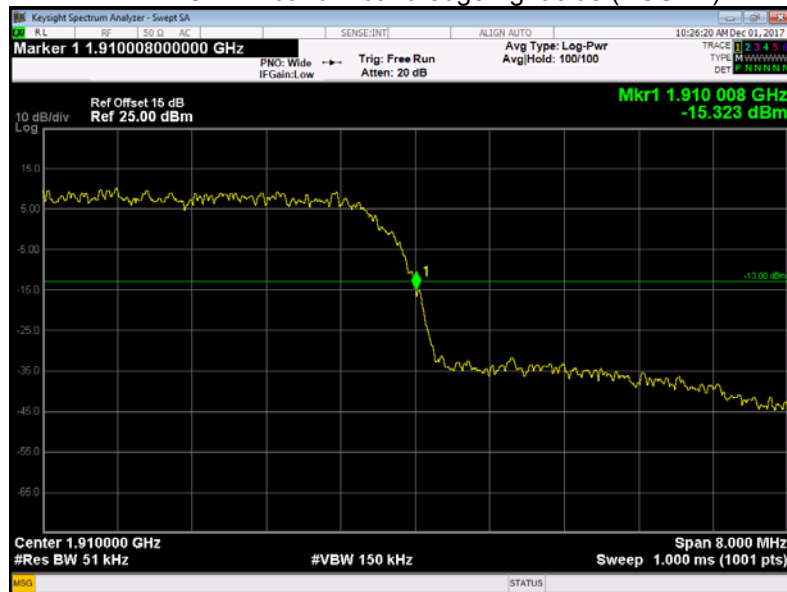

Part 27

WCDMA band IV band edge-left side



WCDMA band IV band edge-right side

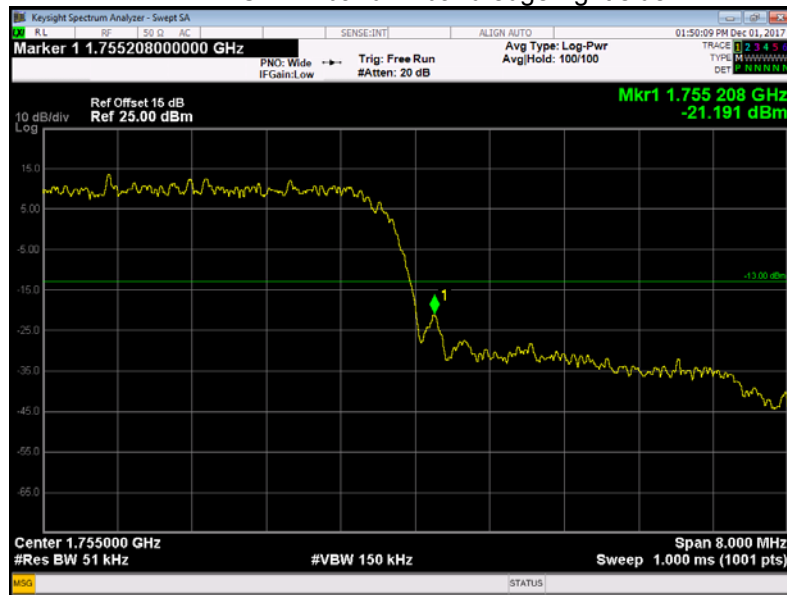

WCDMA band IV band edge-left side (HSDPA)

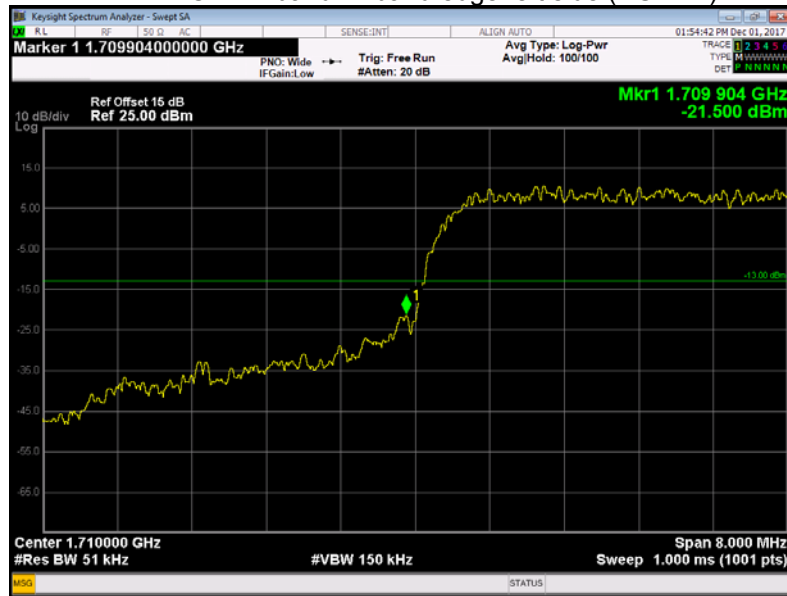

WCDMA band IV band edge-right side (HSDPA)

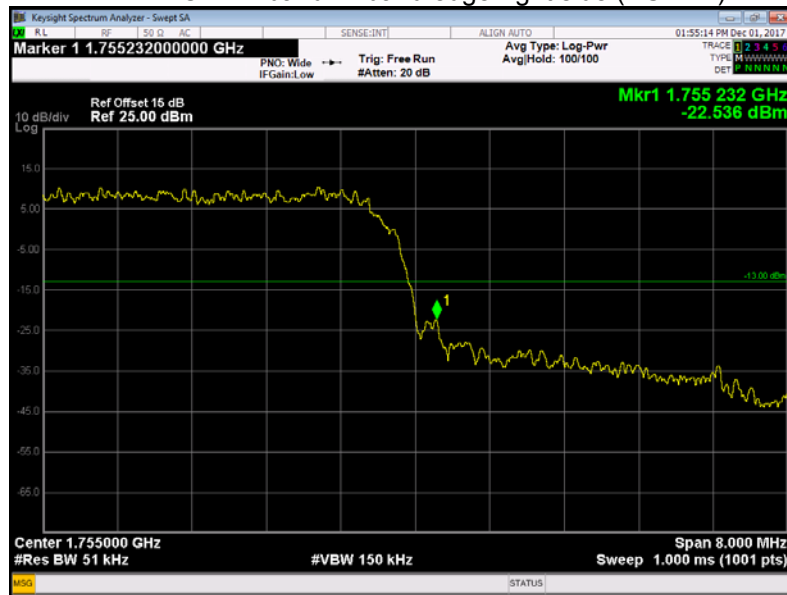

WCDMA band IV band edge-left side (HSUPA)

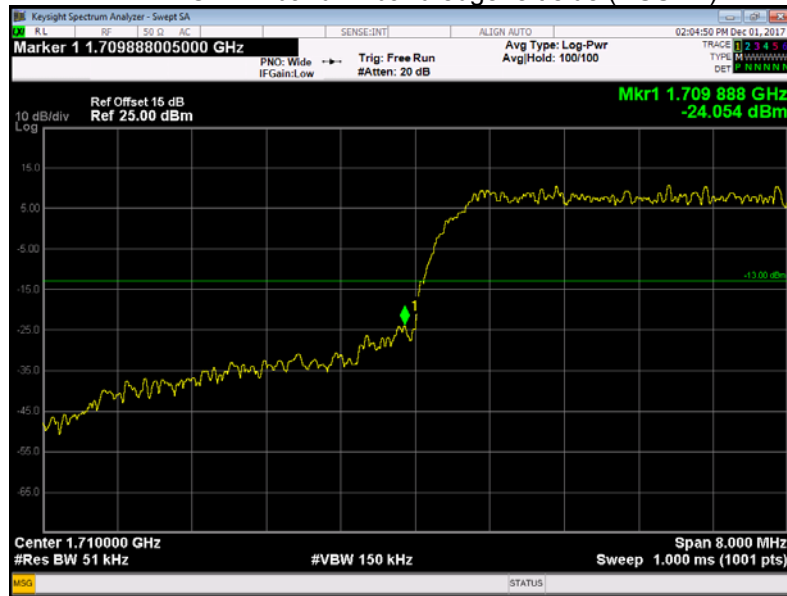

WCDMA band IV band edge-right side (HSUPA)

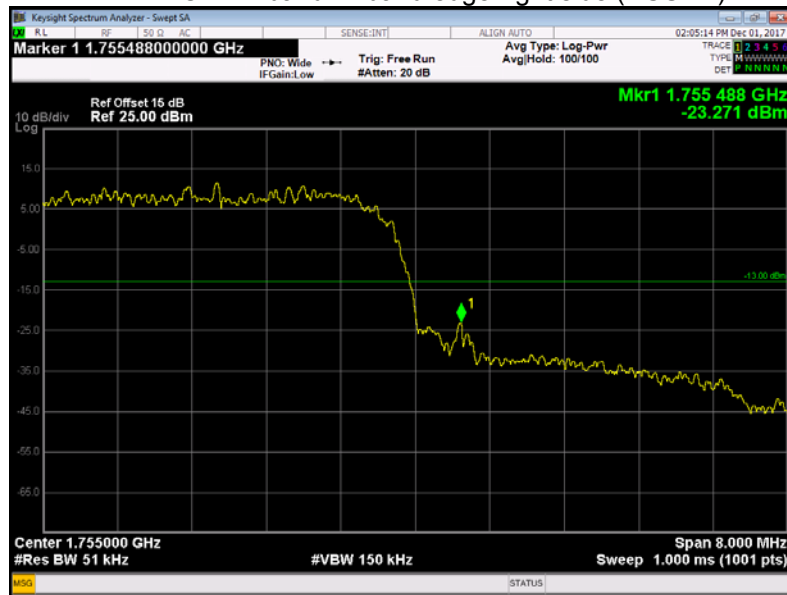

14 FREQUENCY STABILITY

Test Requirement:	FCC Part 2.1055, 22.355, 24.235, 27.5(h),27.54
Test Method:	TIA/EIA-603-D:2010 KDB971168 D01 v02r02
Test Mode:	TX transmitting

14.1 EUT Operation

Operating Environment :	
Temperature:	22.9 °C
Humidity:	52.0 % RH
Atmospheric Pressure:	101.3kPa

14.2 Test Procedure

Frequency Stability vs. Temperature: The equipment under test was connected to an external DC power supply and the RF output was connected to communication test set via feed-through attenuators. The EUT was placed inside the temperature chamber. The DC leads and RF output cable exited the chamber through an opening made for the purpose.

After the temperature stabilized for approximately 20 minutes, the frequency output was recorded from the communication test set.

Frequency Stability vs. Voltage: For hand carried, battery powered equipment; reduce primary supply voltage to the battery operating end point which shall be specified by the manufacturer.

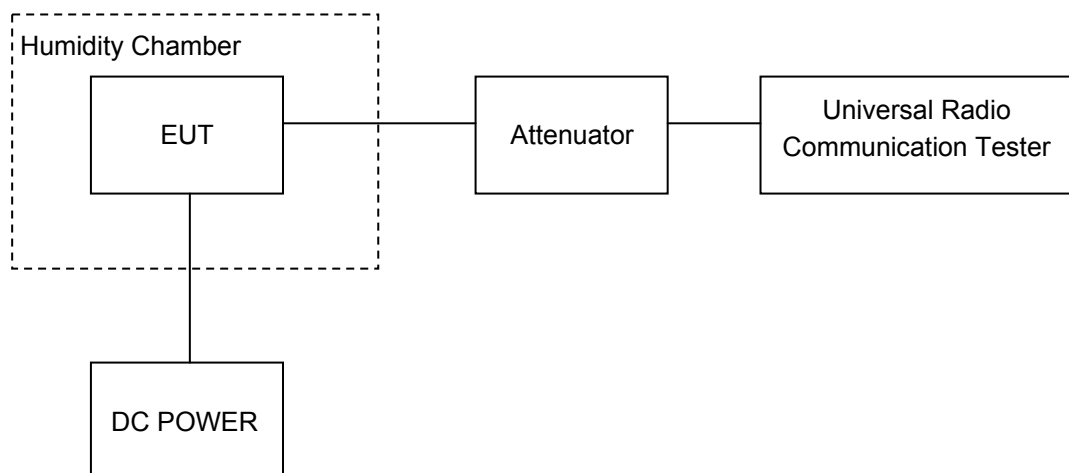

14.3 Test Result

Cellular Band (Part 22H)

GSM 850 Test Frequency:836.6MHz				
Temperature (°C)	Power Supply (VDC)	Frequency Error (Hz)	Frequency Error (ppm)	Limit (ppm)
50	3.8	-5	-0.0060	2.5
40		-2	-0.0024	2.5
30		0	0.0000	2.5
20		0	0.0000	2.5
10		6	0.0072	2.5
0		6	0.0072	2.5
-10		-1	-0.0012	2.5
-20		4	0.0048	2.5
-30		-3	-0.0036	2.5
20		3.3	-1	-0.0012
20	4.2	-6	-0.0072	2.5

GPRS 850 Test Frequency:836.6MHz				
Temperature (°C)	Power Supply (VDC)	Frequency Error (Hz)	Frequency Error (ppm)	Limit (ppm)
50	3.8	-11	-0.0131	2.5
40		2	0.0024	2.5
30		-6	-0.0072	2.5
20		-3	-0.0036	2.5
10		1	0.0012	2.5
0		6	0.0072	2.5
-10		4	0.0048	2.5
-20		2	0.0024	2.5
-30		-6	-0.0072	2.5
20		3.3	1	0.0012
20	4.2	-2	-0.0024	2.5

EGPRS 850 Test Frequency:836.6MHz				
Temperature (°C)	Power Supply (VDC)	Frequency Error (Hz)	Frequency Error (ppm)	Limit (ppm)
50	3.8	-1	-0.0012	2.5
40		5	0.0060	2.5
30		9	0.0108	2.5
20		2	0.0024	2.5
10		5	0.0060	2.5
0		-3	-0.0036	2.5
-10		6	0.0072	2.5
-20		-3	-0.0036	2.5
-30		6	0.0072	2.5
20	3.3	-2	-0.0024	2.5
20	4.2	5	0.0060	2.5

WCDMA Band V Test Frequency:836.6MHz				
Temperature (°C)	Power Supply (VDC)	Frequency Error (Hz)	Frequency Error (ppm)	Limit (ppm)
50	3.8	-7	-0.0037	2.5
40		1	0.0005	2.5
30		3	0.0016	2.5
20		-2	-0.0011	2.5
10		-5	-0.0027	2.5
0		4	0.0021	2.5
-10		-6	-0.0032	2.5
-20		2	0.0011	2.5
-30		-4	-0.0021	2.5
20	3.3	-5	-0.0027	2.5
20	4.2	-3	-0.0016	2.5

WCDMA Band V Test Frequency:836.6MHz(HSDPA)				
Temperature (°C)	Power Supply (VDC)	Frequency Error (Hz)	Frequency Error (ppm)	Limit (ppm)
50	3.8	-7	-0.0084	2.5
40		-8	-0.0096	2.5
30		-10	-0.0120	2.5
20		-2	-0.0024	2.5
10		6	0.0072	2.5
0		-7	-0.0084	2.5
-10		-9	-0.0108	2.5
-20		-4	-0.0048	2.5
-30		7	0.0084	2.5
20		3.3	-1	-0.0012
20	4.2	-9	-0.0108	2.5

WCDMA Band V Test Frequency:836.6MHz(HSUPA)				
Temperature (°C)	Power Supply (VDC)	Frequency Error (Hz)	Frequency Error (ppm)	Limit (ppm)
50	3.8	-2	-0.0024	2.5
40		-11	-0.0132	2.5
30		-2	-0.0024	2.5
20		-4	-0.0048	2.5
10		-4	-0.0048	2.5
0		-6	-0.0072	2.5
-10		-11	-0.0132	2.5
-20		3	0.0036	2.5
-30		-9	-0.0108	2.5
20		3.3	-5	-0.0060
20	4.2	3	0.0036	2.5

PCS Band (Part 24E)

PCS 1900 Test Frequency:1880.0MHz				
Temperature (°C)	Power Supply (VDC)	Frequency Error (Hz)	Frequency Error (ppm)	Limit (ppm)
50	3.8	9	0.0048	2.5
40		7	0.0037	2.5
30		-1	-0.0005	2.5
20		1	0.0005	2.5
10		-2	-0.0011	2.5
0		-4	-0.0021	2.5
-10		-5	-0.0027	2.5
-20		-7	-0.0037	2.5
-30		-8	-0.0043	2.5
20		3.3	-4	-0.0021
20	4.2	-3	-0.0016	2.5

GPRS 1900 Test Frequency:1880.0MHz				
Temperature (°C)	Power Supply (VDC)	Frequency Error (Hz)	Frequency Error (ppm)	Limit (ppm)
50	3.8	-3	-0.0016	2.5
40		-2	-0.0011	2.5
30		6	0.0032	2.5
20		-2	-0.0011	2.5
10		-8	-0.0043	2.5
0		-4	-0.0021	2.5
-10		-1	-0.0005	2.5
-20		-11	-0.0059	2.5
-30		-11	-0.0059	2.5
20		3.3	-4	-0.0021
20	4.2	-1	-0.0005	2.5

EGPRS 1900 Test Frequency:1880.0MHz				
Temperature (°C)	Power Supply (VDC)	Frequency Error (Hz)	Frequency Error (ppm)	Limit (ppm)
50	3.8	23	0.0122	2.5
40		29	0.0154	2.5
30		19	0.0101	2.5
20		20	0.0106	2.5
10		13	0.0069	2.5
0		15	0.0080	2.5
-10		15	0.0080	2.5
-20		20	0.0106	2.5
-30		22	0.0117	2.5
20		3.3	20	0.0106
20	4.2	22	0.0117	2.5

WCDMA Band II Test Frequency:1880.0MHz				
Temperature (°C)	Power Supply (VDC)	Frequency Error (Hz)	Frequency Error (ppm)	Limit (ppm)
50	3.8	7	0.0037	2.5
40		-4	-0.0021	2.5
30		-8	-0.0043	2.5
20		1	0.0005	2.5
10		7	0.0037	2.5
0		-7	-0.0037	2.5
-10		-1	-0.0005	2.5
-20		10	0.0053	2.5
-30		-2	-0.0011	2.5
20		3.3	-7	-0.0037
20	4.2	4	0.0021	2.5

WCDMA Band II Test Frequency:1880.0MHz(HSDPA)				
Temperature (°C)	Power Supply (VDC)	Frequency Error (Hz)	Frequency Error (ppm)	Limit (ppm)
50	3.8	-1	-0.0005	2.5
40		5	0.0027	2.5
30		-3	-0.0016	2.5
20		-3	-0.0016	2.5
10		3	0.0016	2.5
0		-5	-0.0027	2.5
-10		1	0.0005	2.5
-20		-3	-0.0016	2.5
-30		2	0.0011	2.5
20		3.3	3	0.0016
20	4.2	-11	-0.0059	2.5

WCDMA Band II Test Frequency:1880.0MHz(HSUPA)				
Temperature (°C)	Power Supply (VDC)	Frequency Error (Hz)	Frequency Error (ppm)	Limit (ppm)
50	3.8	5	0.0027	2.5
40		-7	-0.0037	2.5
30		3	0.0016	2.5
20		-2	-0.0011	2.5
10		-9	-0.0048	2.5
0		-6	-0.0032	2.5
-10		-2	-0.0011	2.5
-20		-3	-0.0016	2.5
-30		1	0.0005	2.5
20		3.3	-8	-0.0043
20	4.2	4	0.0021	2.5

Part 27

WCDMA Band IV Test Frequency:1732.6MHz				
Temperature (°C)	Power Supply (VDC)	Frequency Error (Hz)	Frequency Error (ppm)	Limit (ppm)
50	3.8	4	0.0023	2.5
40		-5	-0.0029	2.5
30		9	0.0052	2.5
20		3	0.0017	2.5
10		6	0.0035	2.5
0		3	0.0017	2.5
-10		5	0.0029	2.5
-20		7	0.0040	2.5
-30		9	0.0052	2.5
20		3.3	10	0.0058
20	4.2	11	0.0063	2.5

WCDMA Band IV Test Frequency:1732.6MHz (HSDPA)				
Temperature (°C)	Power Supply (VDC)	Frequency Error (Hz)	Frequency Error (ppm)	Limit (ppm)
50	3.8	4	0.0023	2.5
40		-5	-0.0029	2.5
30		9	0.0052	2.5
20		3	0.0017	2.5
10		6	0.0035	2.5
0		3	0.0017	2.5
-10		5	0.0029	2.5
-20		7	0.0040	2.5
-30		9	0.0052	2.5
20		3.3	10	0.0058
20	4.2	11	0.0063	2.5

WCDMA Band IV Test Frequency:1732.6MHz (HSUPA)				
Temperature (°C)	Power Supply (VDC)	Frequency Error (Hz)	Frequency Error (ppm)	Limit (ppm)
50	3.8	4	0.0023	2.5
40		-5	-0.0029	2.5
30		9	0.0052	2.5
20		3	0.0017	2.5
10		6	0.0035	2.5
0		3	0.0017	2.5
-10		5	0.0029	2.5
-20		7	0.0040	2.5
-30		9	0.0052	2.5
20		3.3	10	0.0058
20	4.2	11	0.0063	2.5

15 RF Exposure

Remark: refer to SAR test report: WTS17S1194670E.

16 Photographs of test setup and EUT.

Note: Please refer to appendix: WTS17S1194671E_Photo.

===== End of Report =====