

SHENZHEN CHAINWAY INFORMATION TECHNOLOGY CO., LTD

Fixed Android UHF Reader

URA4 User Manual



Statement

2013 by ShenZhen Chainway Information Technology Co., Ltd. All rights reserved.

No part of this publication may be reproduced or used in any form, or by any electrical or mechanical means, without permission written from Chainway. This includes electronic or mechanical means, such as photocopying, recording, or information storage and retrieval systems. The material in this manual is subject to change without notice. The software is provided strictly on an “as is” basis. All software, including firmware, furnished to the user is on a licensed basis. Chainway grants to the user a non-transferable and non-exclusive license to use each software or firmware program delivered hereunder (licensed program). Except as noted below, such license may not be assigned, sublicensed, or otherwise transferred by the user without prior written consent of Chainway. No right to copy a licensed program in whole or in part is granted, except as permitted under copyright law. The user shall not modify, merge, or incorporate any form or portion of a licensed program with other program material, create a derivative work from a licensed program, or use a licensed program in a network without written permission from Chainway. Chainway reserves the right to make changes to any software or product to improve reliability, function, or design. Chainway does not assume any product liability arising out of, or in connection with, the application or use of any product, circuit, or application described herein.

No license is granted, either expressly or by implication, estoppel, or otherwise under any Chainway intellectual property rights. An implied license only exists for equipment, circuits, and subsystems contained in Chainway products.

Statement.....	1
Chapter 1 Product Intro	4
1.1 Intro.....	4
1.2 Interface	5
1.3 Necessary Parts List.....	6
1.4 Device installation	7
Chapter 2 UHF demo	8
2.1 Operating Interface	8
Chapter 3 UHF tag scanning.....	10
3.1 Auto Scanning	10
3.2 Single Scanning.....	12
3.3 Read UHF Tag.....	13
3.4 Write Tag	15
3.5 Lock Tag.....	16
3.6 Kill Tag.....	18
3.7 UHF Module Version	19
3.8 Module Temperature	20
Chapter 4 Config.....	21
4.1 Working mode.....	21
4.2 Output Power.....	22
4.3 R2000 settings.....	23
4.4 Protocol	24
4.5 RF link	25
4.6 QT Tag	26
4.7 Open tagFocus	27
4.8 Open FastID	27
4.9 Open EPC and TID	27

4.10 WWAN Specification.....	27
Chapter 5 SIMPLIFIED EU DECLARATION OF CONFORMITY	28
Chapter 6 Warning	29

Chapter 1 Product Intro

1.1 Intro

Chainway URA4 is a 4-channel fixed RFID reader, based on Android 9.0. Integrated with Impinj R2000 RFID chip, it supports RS232, RJ45 and HDMI, and can be compatible with various types of antennas. With high stability and outstanding performance, URA4 can be ideally applied to warehouse management, archives and library management, bank, clothing and footwear retail, jewelry monitoring, watch industry, laundry, production line management, medical instrument cabinet and vending machines.

1.2 Interface

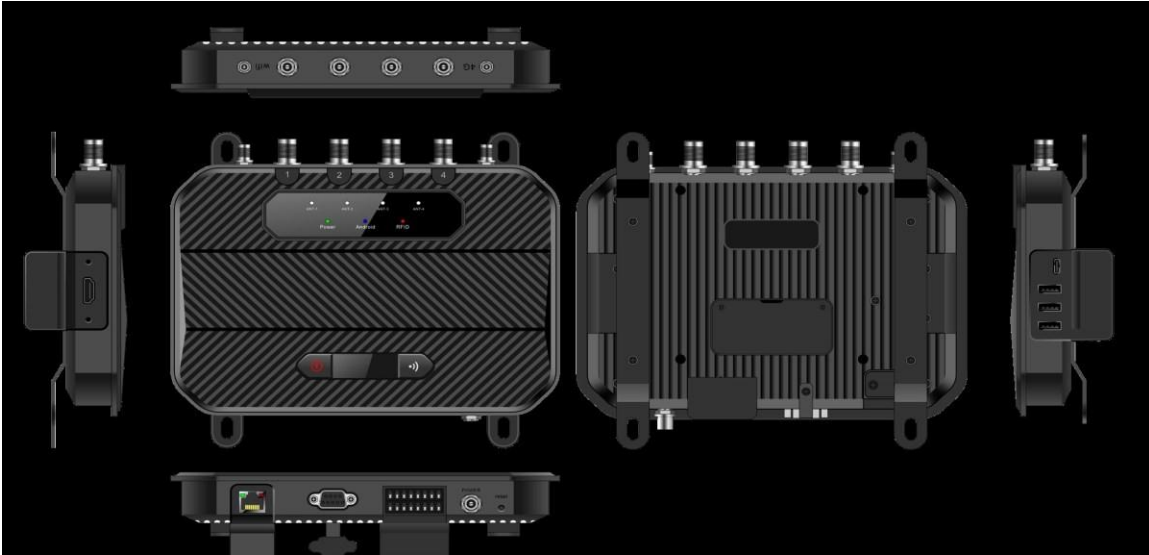

Pic.1-1

1.3 Necessary Parts List

1	URA4 reader, 12V power adaptor
2	UHF antenna, 9dBi etc.
3	Feeder line, SMA male side connects with device, interface on other side needs match with antenna.
4	RJ45 Ethernet cable
5	HDMI cable
6	4G external antenna
7	WIFI external antenna

1.4 Device installation

URA4 reader adopts Android operating system, it can be connected with Internet through RJ45, WIFI and 4G etc. And connect with monitor through HDMI cable.

Developer could use USB cable to connect device with PC for developing application, device could also be connected with PC through serial port cable.

The UHF antenna should install with the professionals, the end-user cannot change the antenna without authorization

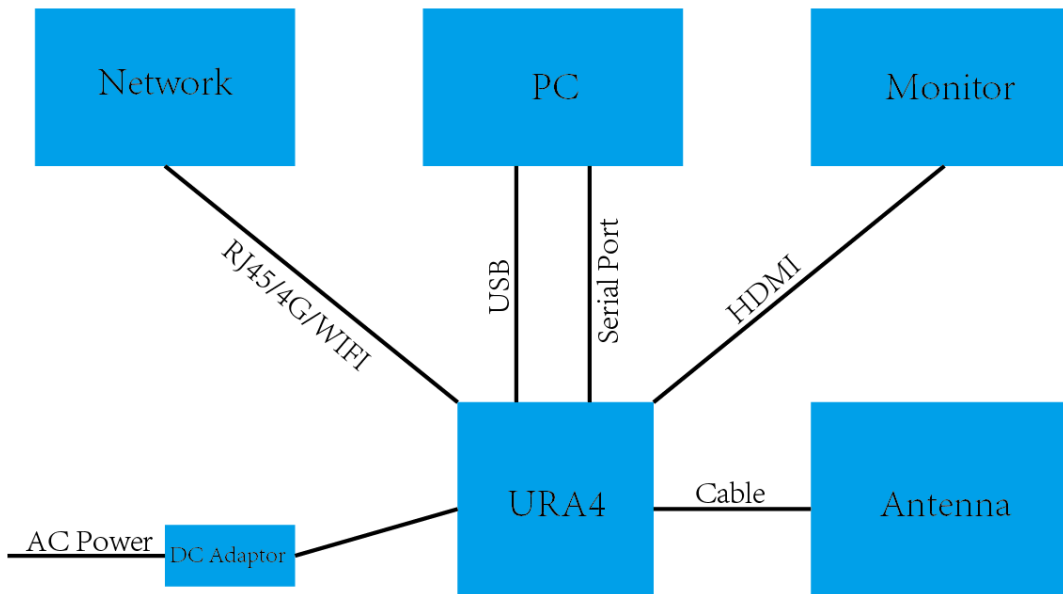

Pic.3-1

Chapter 2 UHF demo

2.1 Operating Interface

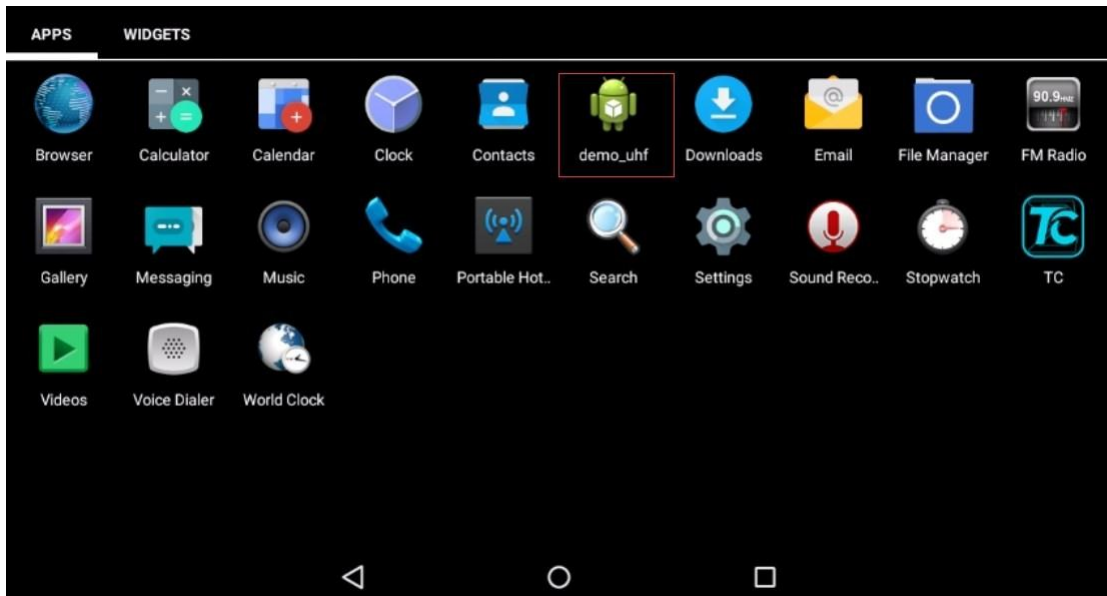

Pic.4-1

Connect monitor through HDMI cable and long-press power button for 3 seconds to switch on device. Click demo_uhf icon to enter demo as Pic.4-1, UHF module will initiate as Pic.4-2, if there is no error messages show up, then initiation process has been successfully finished. "init. fail" means UHF module failed to initiate, need to exit application and repeat operation. If initiation cannot successfully finished, need to contact tech support for further.

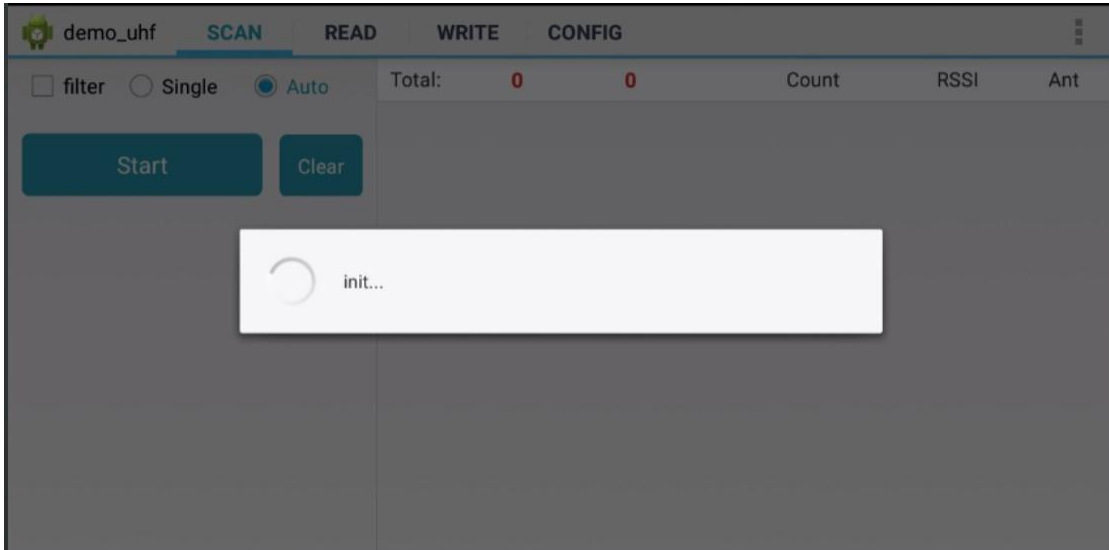

Pic.4-2

Chapter 3 UHF tag scanning

Click SCAN on top of navigation bar to enter tags reading page.

3.1 Auto Scanning

Select “Auto”, then click “Start” button to start tags scanning circularly, the information such as EPC or TID, Count, RSSI and Ant. number. As Pic.5-1.

“filter” button can be used to setup tag which has been filtered, user could setup address, data length to filter tags. EPC, TID and USER areas can be selected, setup data length to 0 and clear EPC list, then click “Setup” to confirm in Pic.5-2.

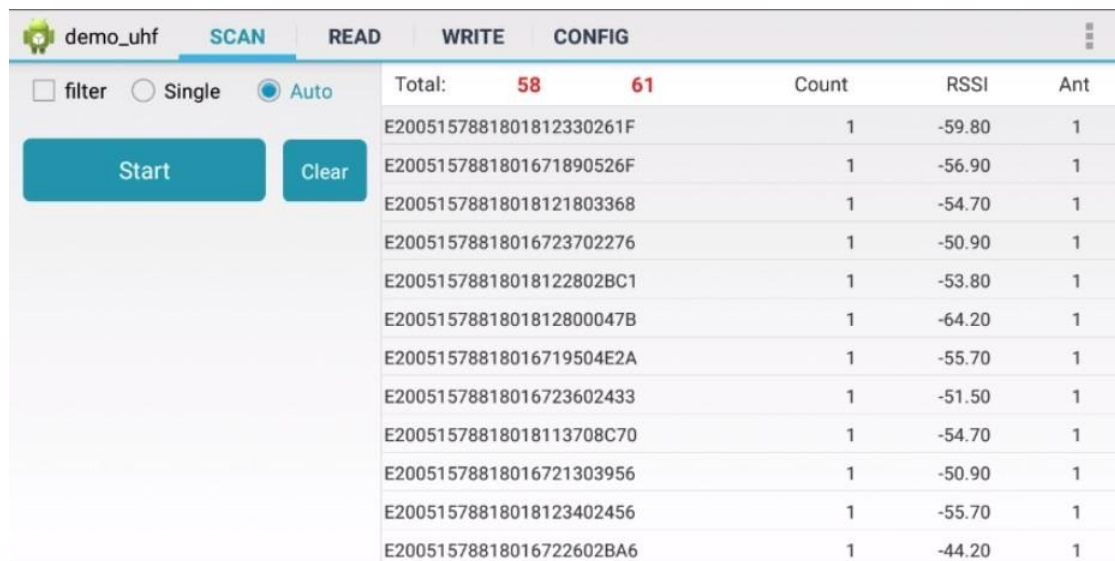

Total:	58	61	Count	RSSI	Ant
E2005157881801812330261F	1		1	-59.80	1
E2005157881801671890526F	1		1	-56.90	1
E20051578818018121803368	1		1	-54.70	1
E20051578818016723702276	1		1	-50.90	1
E20051578818018122802BC1	1		1	-53.80	1
E2005157881801812800047B	1		1	-64.20	1
E20051578818016719504E2A	1		1	-55.70	1
E20051578818016723602433	1		1	-51.50	1
E20051578818018113708C70	1		1	-54.70	1
E20051578818016721303956	1		1	-50.90	1
E20051578818018123402456	1		1	-55.70	1
E20051578818016722602BA6	1		1	-44.20	1

Pic.5-1

demo_uhf **SCAN** READ WRITE CONFIG

filter Single Auto

Ptr : 32 (bit) Len 0 (bit)

Data :

EPC TID USER

R2000 module only Setup

Start Clear

Total:	57	57	Count	RSSI	Ant
E20051578818016724301EE9	1	-55.70	1		
E20051578818018114708374	1	-50.30	1		
E20051578818018113708C70	1	-55.70	1		
E20051578818018124201D57	1	-52.90	1		
E20051578818018122802BC1	1	-50.90	1		
E200515788180181252016B4	1	-55.70	1		
E20051578818016721303956	1	-48.70	1		
E20051578818016722602BA6	1	-39.50	1		
E2005157881801671890526F	1	-57.50	1		
E20051578818016723702276	1	-47.80	1		
E20051578818018115507A74	1	-65.00	1		
E20051578818018121803368	1	-52.90	1		

Pic.5-2

3.2 Single Scanning

Select “Single” button and click “Start” to start scanning tag, EPC or TID, Count, RSSI and Ant.number will display on right side, as Pic.5-3.

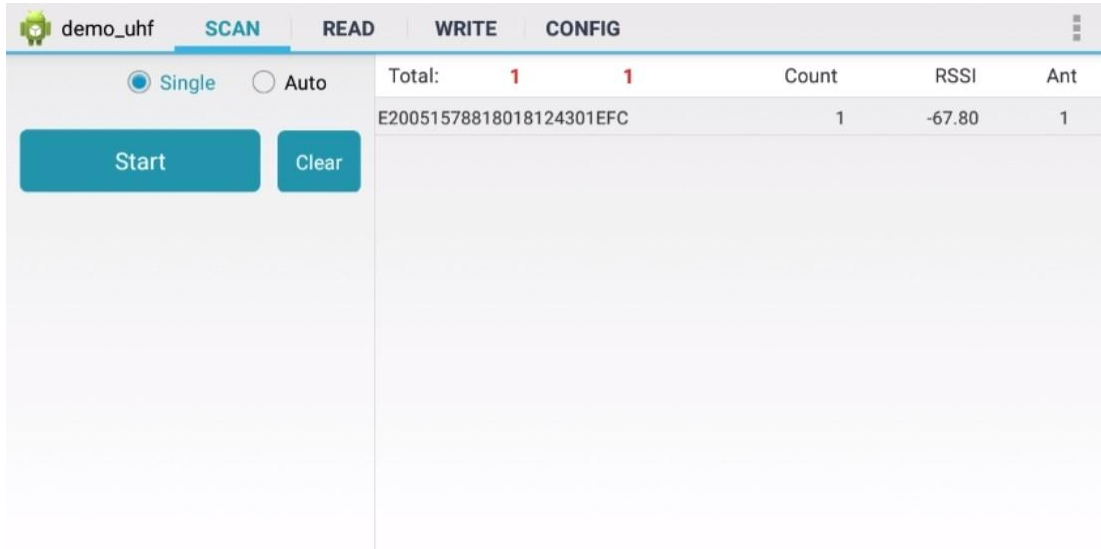

Pic.5-3

3.3 Read UHF Tag

Click “READ” on top of navigation bar to enter page of tag reading.

User could read data of 4 areas, RESERVED, EPC, TID and USER, setup address and data length, default password is “00000000”, click “Read” to read tags in Pic.6-1.

The screenshot shows a web interface for UHF tag reading. At the top, there is a navigation bar with tabs: "demo_uhf" (with a robot icon), "SCAN", "READ" (highlighted in blue), "WRITE", and "CONFIG". Below the navigation bar, there are two sets of input fields. The first set has "Ptr : 32" (with "(bit)" next to it) and "长度: 0" (with "(bit)" next to it). Below these is a "Data :" label and an empty input field. The second set has "Ptr : 0" (with "(word)" next to it) and "Len : 4" (with "(word)" next to it). Below these is an "Access Pwd : 00000000" label and an empty input field. At the bottom, there is a "Data :" label and an empty input field. In the middle of the interface, there are three buttons: "EPC" (highlighted in blue), "TID", and "USER". At the very bottom, there is a large blue button labeled "Read".

Pic.6-1

Comment: user could filter tags by setup address, data length and data in EPC, TID and USER areas, select “Enable” button to switch on filter function in Pic.6-2.

demo_uhf SCAN **READ** WRITE CONFIG

filter

Enable

Ptr : 32 (bit) 长度: 0 (bit)

Data :

EPC TID USER

Bank : RESERVED

Ptr : 0 (word) Len : 4 (word)

Access Pwd : 00000000

Data :

Pic.6-2

3.4 Write Tag

Click “WRITE” on top of navigation bar to enter tag writing page.

User could write data in RESERVED, EPC, TID and USER areas, setup start address and data length, input access password and data(hex), click “Write Data” to write data in Pic.7-1.

Comment: user could filter tags by setup address, data length and data in EPC, TID and USER areas, select “Enable” button to switch on filter function.

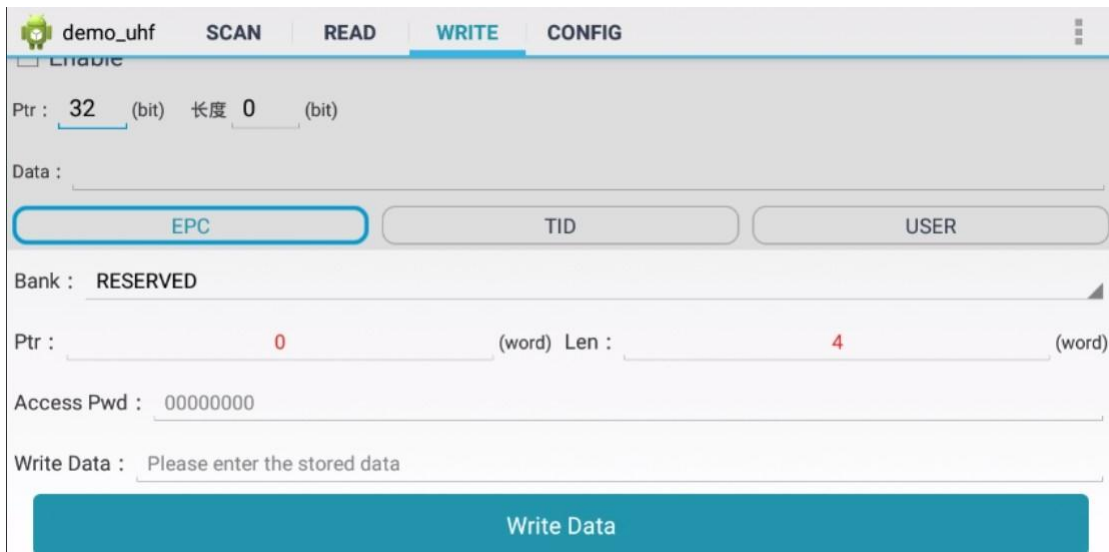

Pic.7-1

3.5 Lock Tag

Click “LOCK” on top of navigation bar to enter tag locking page.

Input access password(DONOT input default password.), then click column of “Lock Code”, it will display window for selecting different methods of locking, click “OK” to generate lock code automatically, then click “Lock” to lock tags in Pic.8-1 and Pic.8-2.

Comment: user could filter tags by setup address, data length and data in EPC, TID and USER areas, select “Enable” button to switch on filter function.

NOTE: If permanent mask has been locked, then it cannot be unlocked. Vice versa.

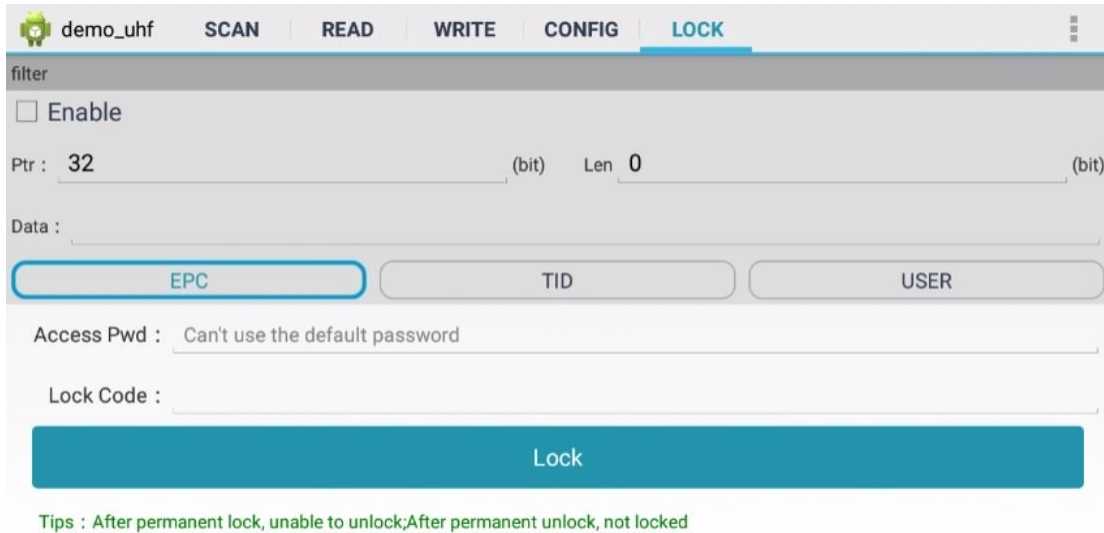

Pic. 8-1

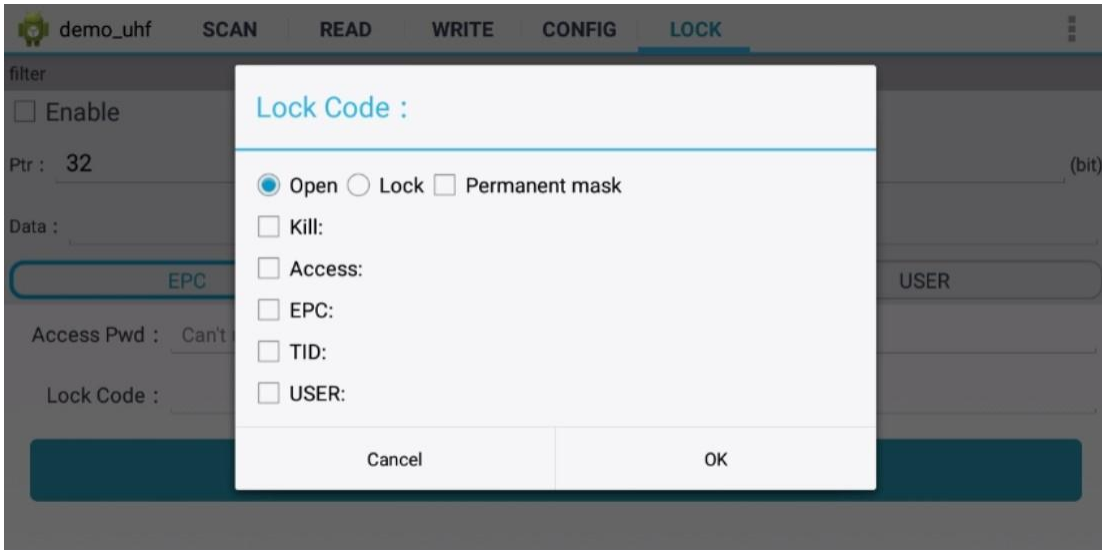

Pic.8-2

3.6 Kill Tag

Click “KILL” on top of navigation bar to enter operating page.

Input access password (DONOT input default password.), click “Kill” button to destroy tags in Pic.9-1.

Comment: user could filter tag by setup address, data length and data for selecting EPC, TID or USER area.

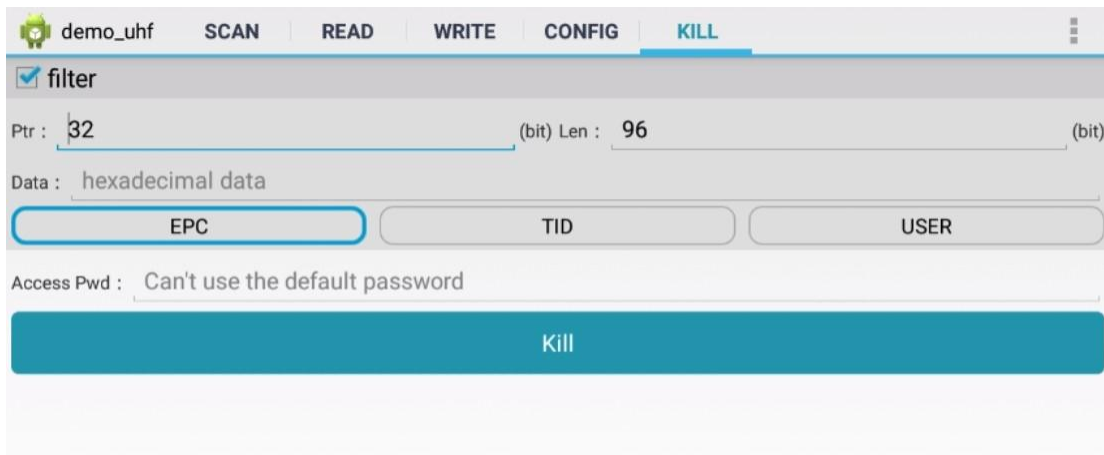

Pic.9-1

3.7 UHF Module Version

Click 3 dots on top right of application and click “About” in list to check version of UHF module in Pic.10-1.

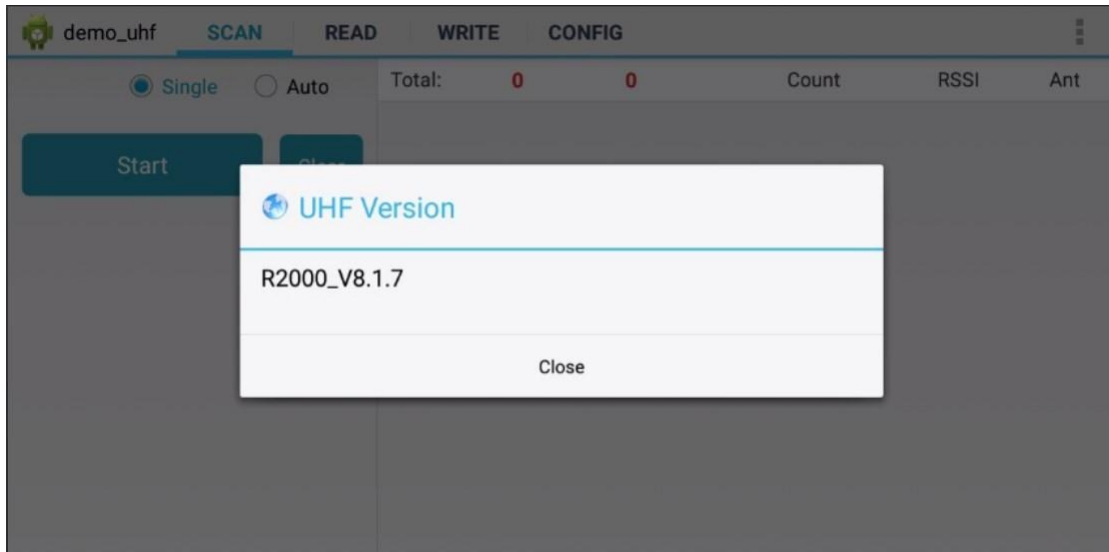

Pic.10-1

3.8 Module Temperature

Click 3 dots on top right of application, click “Module temperature” in list to check UHF module temperature in Pic.11-1.

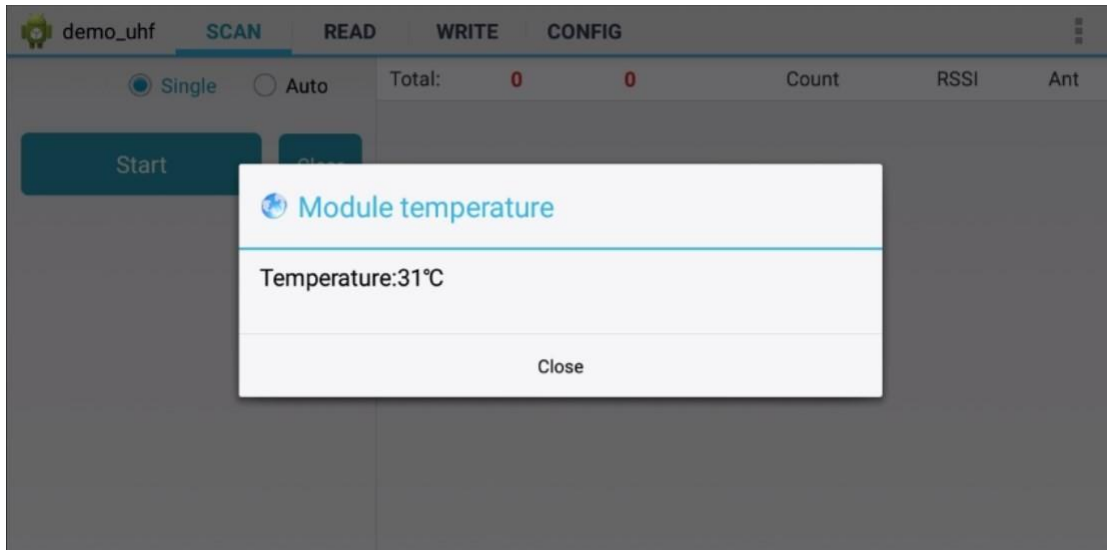

Pic.11-1

Chapter 4 Config

Click “CONFIG” on top of navigation bar to enter setup page.

4.1 Working mode

User could setup different frequency band for different countries, as Pic.12-1, click “Set Frequency” to confirm frequency band. Click “Get Frequency” to check current frequency band.

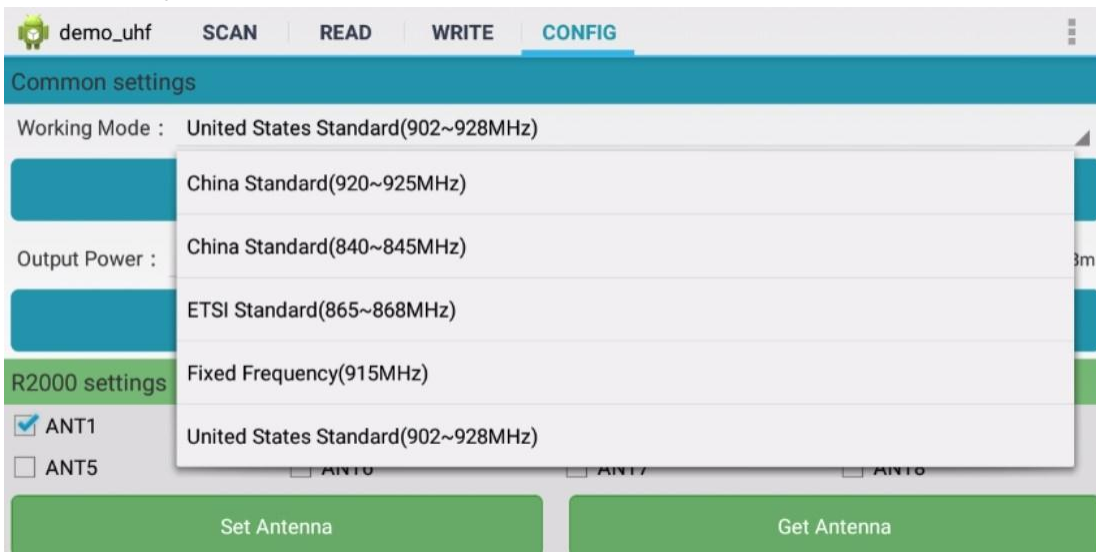

Pic.12-1

4.2 Output Power

User could select different output power from 5 to 30dBm in Pic.12-2, click “Set Power” to confirm setup. Click “Get Power” to get current output power.

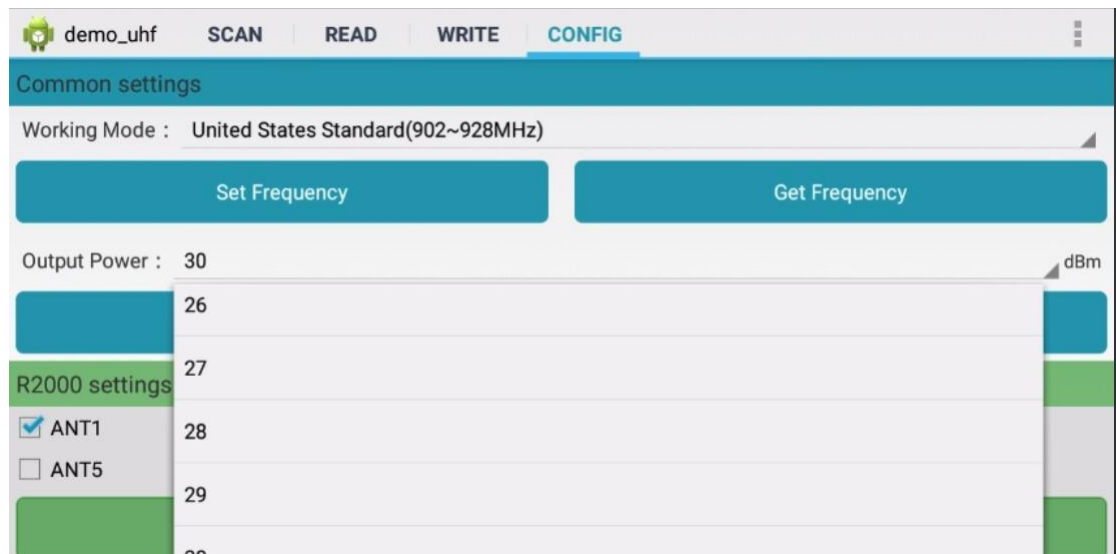

Pic.12-2

4.3 R2000 settings

Select ANT1-ANT8 to setup antenna, selected antenna will start functioning, unselected antenna will in OFF in Pic.12-3.

Click “Set Antenna” to confirm setup, “Get Antenna” to check current antenna status.

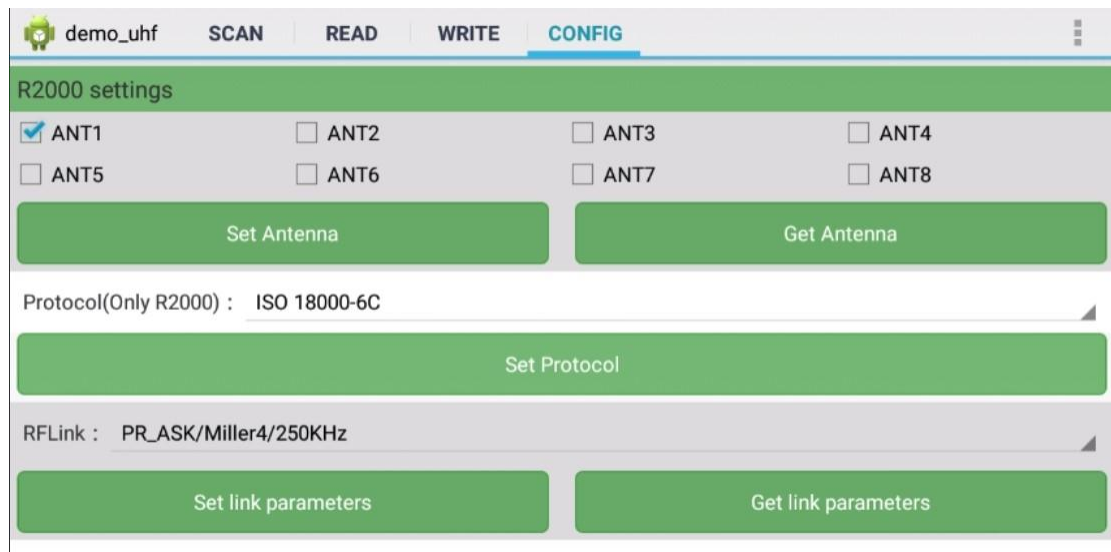

Pic.12-3

4.4 Protocol

There are two protocols can be selected in Pic.12-4, click “Set Protocol” to confirm.

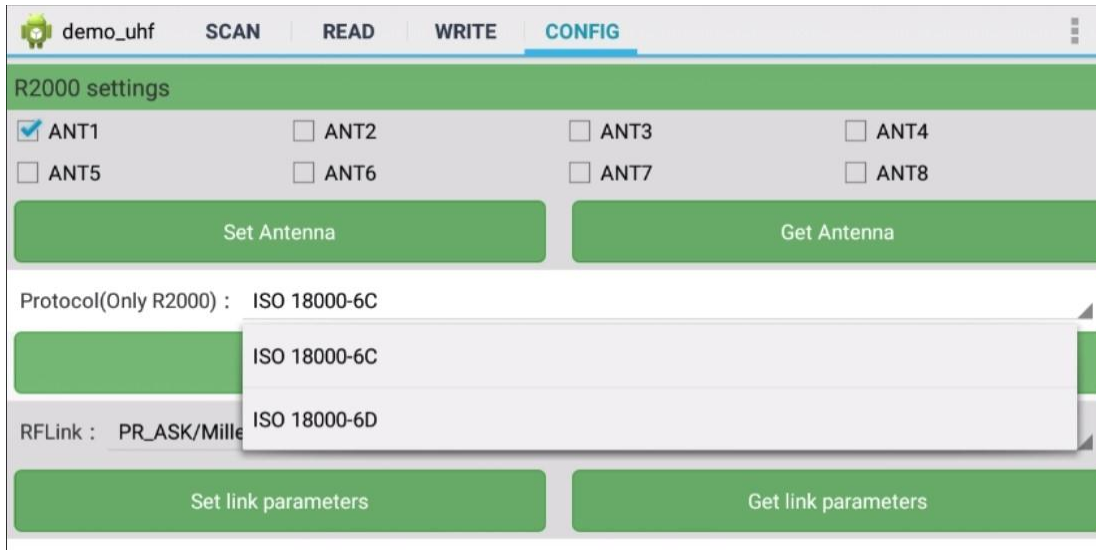

Pic.12-4

4.5 RF link

There are four parameters can be selected in this parameter, as Pic.12-5. Click “Set link parameter” to confirm, click “Get link parameters” to check current RF link parameters.

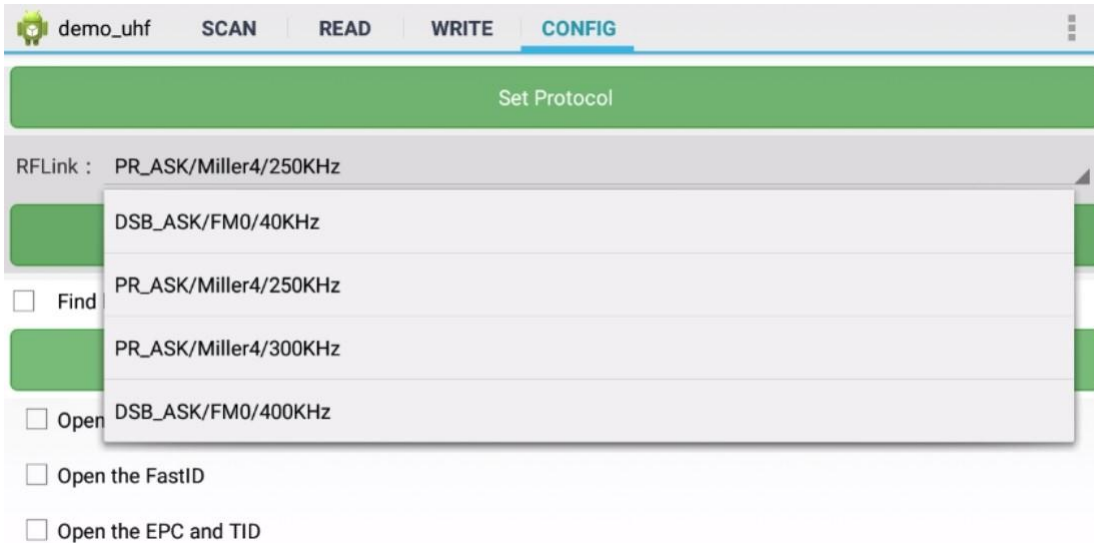

Pic.12-5

4.6 QT Tag

Select “Set QTPara” to switch ON and OFF hidden areas of QT tag, click “Get QTPara” to check current status.

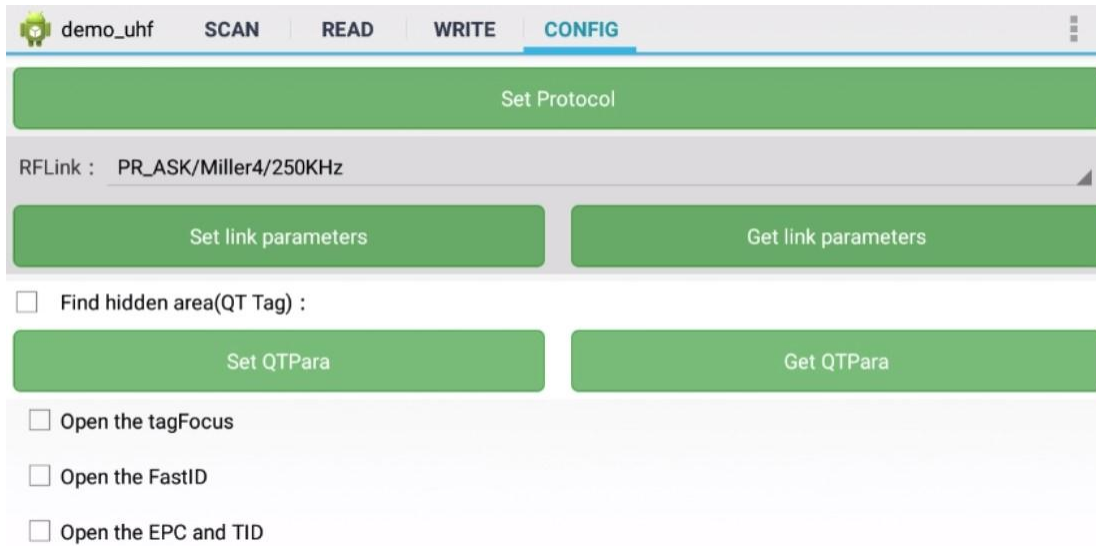

Pic.12-6

4.7 Open tagFocus

Select ON/OFF of tagFocus in Pic.12-6.

4.8 Open FastID

Select ON/OFF of “Open the EPC and TID” in Pic.12-6.

4.9 Open EPC and TID

Select ON/OFF of “Open the EPC and TID” in Pic.12-6.

4.10 WWAN Specification

WWAN		
Frequency Band	output power(dBm)	
GSM 900	33±2	
GSM 1800	30±2	
UMTS B1/B8	23±2	
LTEB1/B3/B7/B8/B20/28/34/38/40	23±2	
WLAN		
Standard	Frequency	EIRP Power(dBm)
2.4G WIFI	2.412GHz~2.472GHz	<16
BT	2.402GHz~2.480GHz	<4
5G WIFI	5.15GHz~5.35GHz	<18
5.8G WIFI	5.725 GHz -5.850 GHz	<13
RFID		
RFID		ERP Power(dBm)
865MHz~868MHz		<32

Chapter 5 SIMPLIFIED EU DECLARATION OF CONFORMITY

Hereby, Shenzhen Chainway Information Technology Co.,Ltd. declares that the radio equipment type Fixed Android UHF Reader is in compliance with Directive 2014/53/EU. The full text of the EU declaration of conformity is available at the following internet address:(www.chainway.net)

The device is restricted to indoor use only when operating in the 5150 to 5350 MHz frequency range.

	AT	BE	BG	HR	CY	CZ	DK
	EE	FI	FR	DE	EL	HU	IE
	IT	LV	LT	LU	MT	NL	PL
	PT	RO	SK	SI	ES	SE	UK(NI)

ShuRong Chen

Chapter 6 Warning

CE:

RF exposure information: The Maximum Permissible Exposure (MPE) level has been calculated based on a distance of $d=20$ cm between the device and the human body. To maintain compliance with RF exposure requirement, use product that maintain a 20cm distance between the device and human body.

FCC:

Federal Communication Commission (FCC) Radiation Exposure Statement. When using the product, maintain a distance of 20cm from the body to ensure compliance with RF exposure requirements.

FCC statements:

This device complies with part 15 of the FCC rules. Operation is subject to the following two conditions: (1) this device may not cause harmful interference, and (2) this device must accept any interference received, including interference that may cause undesired operation.

NOTE: The manufacturer is not responsible for any radio or TV interference caused by unauthorized modifications or changes to this equipment. Such modifications or changes could void the user's authority to operate the equipment.

NOTE: This equipment has been tested and found to comply with the limits for a Class B digital device, pursuant to part 15 of the FCC Rules. These limits are designed to provide reasonable protection against harmful interference in a residential installation. This equipment generates uses and can radiate radio frequency energy and, if not installed and used in accordance with the instructions, may cause harmful interference to radio communications. However, there is no guarantee that interference will not occur in a particular installation. If this equipment does cause harmful interference to radio

or television reception, which can be determined by turning the equipment off and on, the user is encouraged to try to correct the interference by one or more of the following measures:

- Reorient or relocate the receiving antenna.
- Increase the separation between the equipment and receiver.
- Connect the equipment into an outlet on a circuit different from that to which the receiver is connected.
- Consult the dealer or an experienced radio/TV technician for help.