



RF TEST REPORT

Report No.: SET2018-12664

Product: Industrial tablet

FCC ID: 2AC6AP80

Model No.: P80

Applicant: Shenzhen Chainway Information Technology Co.,Ltd.

Address: 9/F, Building 2, Daqian Industrial Park, Longchang Rd., District 67,
Bao'an, Shenzhen

Dates of Testing: 09/20/2018 — 10/19/2018

Issued by: CCIC Southern Electronic Product Testing (Shenzhen) Co., Ltd.

Lab Location: Building 28/29, East of Shigu Xili Industrial Zone, Nanshan District
Shenzhen, Guangdong 518055, China

Tel: 86 755 26627338 **Fax:** 86 755 26627238

This test report consists of 30 pages in total. It may be duplicated completely for legal use with the approval of the applicant. It should not be reproduced except in full, without the written approval of our laboratory. The client should not use it to claim product endorsement by CCIC-SET. The test results in the report only apply to the tested sample. The test report shall be invalid without all the signatures of testing engineers, reviewer and approver. Any objections must be raised to CCIC-SET within 15 days since the date when the report is received. It will not be taken into consideration beyond this limit.



Test Report

Product.....: Industrial tablet

Brand Name.....: CHAINWAY

Trade Name.....: CHAINWAY

Applicant.....: Shenzhen Chainway Information Technology Co.,Ltd.

Applicant Address.....: 9/F, Building 2, Daqian Industrial Park, Longchang Rd.,
District 67, Bao'an, Shenzhen

Manufacturer.....: Shenzhen Chainway Information Technology Co.,Ltd.

Manufacturer Address.....: 9/F, Building 2, Daqian Industrial Park, Longchang Rd.,
District 67, Bao'an, Shenzhen

Test Standards.....: 47 CFR FCC Part 22(H)
47 CFR FCC Part 24(E)

Test Result.....: PASS

Tested by.....: 
2018.10.19

Shallwe Yang, Test Engineer

Reviewed by.....: 
2018.10.19

Zhu Qi, Senior EGINEER

Approved by.....: 
2018.10.19

Smart Li, Manager



Table of Contents

- 1. GENERAL INFORMATION4**
- 1.1 EUT Description4**
- 1.2 Maximum ERP/EIRP Power, Frequency Tolerance, and Emission Designator5**
- 1.3 Test Standards and Results5**
- 1.4 Test Configuration of Equipment under Test.....6**
- 1.5 Measurement Results Explanation Example6**
- 1.6 Facilities and Accreditations7**
- 2. 47 CFR PART 2, PART 22H & 24E REQUIREMENTS8**
- 2.1 Conducted RF Output Power8**
- 2.2 99% Occupied Bandwidth and 26dB Bandwidth Measurement10**
- 2.3 Frequency Stability14**
- 2.4 Conducted Out of Band Emissions16**
- 2.5 Band Edge21**
- 2.6 Transmitter Radiated Power (EIRP/ERP)23**
- 2.7 Radiated Spurious Emissions26**
- 3. LIST OF MEASURING EQUIPMENT30**

Change History		
Issue	Date	Reason for change
1.0	2018.10.19	First edition



1. GENERAL INFORMATION

1.1 EUT Description

EUT Type	Industrial tablet
EUT supports Radios application	CDMA2000 BC0
Frequency Range	CDMA2000 BC0: Tx: 824.70 – 848.31MHz; Rx: 869.70 – 893.31MHz
Maximum Output Power to Antenna	CDMA2000 BC0: 23.48dBm
Type of Modulation	CDMA2000:QPSK CDMA2000 1x EV-DO:QPSK / 8PSK
Antenna Type	Internal Antenna
Antenna Gain	CDMA2000 BC0:-1.24dBi
Power supply	DC 3.8V from battery DC 5V from adapter



1.2 Maximum ERP/EIRP Power, Frequency Tolerance, and Emission Designator

System	Type of Modulation	Emission Designator	Frequency Tolerance (ppm)	Maximum ERP/EIRP(W)
CDMA200 BC0	QPSK	1M30F9W	0.06	0.136

1.3 Test Standards and Results

1. 47 CFR Part 2, 22(H) 24(E)
2. ANSI& TIA-603-D-2010
3. FCC KDB 971168 D01 Power Meas. License Digital Systems v03r01

Remark:

1. All test items were verified and recorded according to the standards and without any deviation during the test.
2. This EUT has also been tested and complied with the requirements of FCC Part 15, Subpart B, recorded in a separate test report.

Test detailed items/section required by FCC rules and results are as below:

No.	Section	Description	Limit	Result
	FCC			
1	2.1046	Conducted Output Power	Reporting Only ≤ 100 Watts for BC10	PASS
2	2.1049 22.917(b)	Occupied Bandwidth	Reporting Only	PASS
3	2.1055 22.355	Frequency Stability	$\leq \pm 2.5$ ppm	PASS
4	2.1051 22.917	Conducted Out of Band Emissions	$< 43+10\log_{10}$ (P[Watts])	PASS
5	2.1051 22.917	Band Edge	$< 43+10\log_{10}$ (P[Watts])	PASS
6	22.913	Effective Radiated Power	< 7 Watts < 2 Watts	PASS
7	2.1053 22.917	Radiated Spurious Emissions	$< 43+10\log_{10}$ (P[Watts])	PASS

1.4 Test Configuration of Equipment under Test

Antenna port conducted and radiated test items were performed according to KDB 971168 D01 Power Meas. License Digital Systems v03r01 with maximum output power.

Radiated measurements were performed with rotating EUT in different three orthogonal test planes to find the maximum emission.

Radiated emissions were investigated as following frequency range:

1. 30 MHz to 9GHz for CDMA2000 BC0/BC10.
2. 30MHz to 20GHz for CDMA2000 BC1

All modes and data rates and positions were investigated.

Test modes are chosen to be reported as the worst case configuration below:

Test Modes		
Band	Radiated TCs	Conducted TCs
CDMA2000 BC0	1xRTT Link Mode	1xRTT Link Mode

Note: The maximum power levels are chosen to test as the worst case configuration as follows: CDMA2000 BC0 for QPSK modulation and 1xRTT Link Mode, only these modes were used for all tests.

1.5 Measurement Results Explanation Example

For all conducted test items:

The offset level is set in the spectrum analyzer to compensate the RF cable loss and attenuator factor between EUT conducted output port and spectrum analyzer. With the offset compensation, the spectrum analyzer reading level is exactly the EUT RF output level.

The spectrum analyzer offset is derived from RF cable loss and attenuator factor.

Offset = RF cable loss + attenuator factor.

Following shows an offset computation example with cable loss 7dB and 10dB attenuator.

Example:

$$\begin{aligned}\text{Offset (dB)} &= \text{RF cable loss(dB)} + \text{attenuator factor(dB)} \\ &= 7 + 10 = 17 \text{ (dB)}\end{aligned}$$



1.6 Facilities and Accreditations

1.6.1 Test Facilities

NVLAP Lab Code: 201008-0

CCIC-SET is a third party testing organization accredited by NVLAP according to ISO/IEC 17025. The accreditation certificate number is 201008-0.

FCC- Designation Number: CN5031

CCIC Southern Electronic Product Testing (Shenzhen) Co., Ltd. EMC Laboratory has been registered and fully described in a report filed with the FCC (Federal Communications Commission). The acceptance letter from the FCC is maintained in our files. Designation Number: CN5031, valid time is until December 31, 2018.

ISED Registration: 11185A-1

CCIC Southern Electronic Product Testing (Shenzhen) Co., Ltd. EMC Laboratory has been registered by Certification and Engineering Bureau of Industry Canada for the performance of radiated measurements with Registration No. 11185A-1 on Aug. 04, 2016, valid time is until Aug. 03, 2019

1.6.2 Test Environment Conditions

During the measurement, the environmental conditions were within the listed ranges:

Temperature (°C):	15°C - 35°C
Relative Humidity (%):	30% - 60%
Atmospheric Pressure (kPa):	86KPa-106KPa

2. 47 CFR PART 2, PART 22H & 24E REQUIREMENTS

2.1 Conducted RF Output Power

2.1.1 Definition

A system simulator was used to establish communication with the EUT. Its parameters were set to enforce EUT transmitting at the maximum power. The measured power in the radio frequency on the transmitter output terminals shall be reported.

2.1.2 Measuring Instruments

The measuring equipment is listed in the section 3 of this test report.

2.1.3 Test Procedures

1. The transmitter output port was connected to the system simulator.
2. Set EUT at maximum power through system simulator.
3. Select lowest, middle, and highest channels for each band and different modulation.
4. Measure and record the power level from the system simulator.

2.1.4 Test Setup

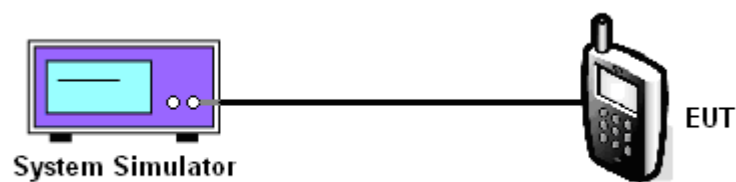



2.1.5 Test Results of Conducted Output Power

Conducted Power (Unit:dBm)			
Band	CDMA2000 BC0		
Channel	1013	384	777
Frequency(MHz)	824.7	836.52	848.31
1xRTT RC1 + SO55	23.35	23.47	23.48
1xRTT RC3 + SO55	23.26	23.39	23.27
1xRTT RC3 + SO32(+ F-SCH)	23.24	23.19	23.26
1xRTT RC3 + SO32(+SCH)	23.31	23.32	23.27
1xEVDO Rev A RETAP	22.76	22.65	22.49

2.2 99% Occupied Bandwidth and 26dB Bandwidth Measurement

2.2.1 Definition

The 99% occupied bandwidth is the width of a frequency band such that, below the lower and above the upper frequency limits, the mean powers emitted are each equal to a specified percentage 0.5% of the total mean transmitted power.

The emission bandwidth is defined as the width of the signal between two points, located at the 2 sides of the carrier frequency, outside of which all emissions are attenuated at least 26 dB below the transmitter power.

2.2.2 Measuring Instruments

The measuring equipment is listed in the section 3 of this test report.

2.2.3 Test Procedures

1. The testing follows FCC KDB 971168 v03r01 Section 4.2.
2. The EUT was connected to the spectrum analyzer and system simulator via a power divider.
3. The RF output of the EUT was connected to the spectrum analyzer by RF cable and attenuator.

The path loss was compensated to the results for each measurement.

4. The 99% occupied bandwidth were measured, set RBW= 1% of span, VBW= 3*RBW, sample detector, trace maximum hold.

5. The 26dB bandwidth were measured, set RBW= 1% of EBW, VBW= 3*RBW, peak detector, trace maximum hold.

2.2.4 Test Setup

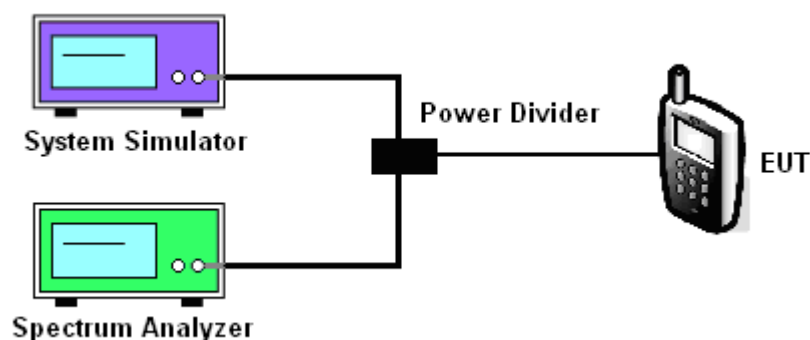

**2.2.5 Test Results of 99% Occupied Bandwidth and 26dB Bandwidth**

CDMA2000 BC0			
Test Mode	CDMA2000 1xRTT		
Channel	1013	384	777
Frequency(MHz)	824.7	836.52	848.31
99% OBW(MHz)	1.2990	1.2919	1.2859
26dB BW(MHz)	1.6550	1.6520	1.6590

2.2.6 Test Results (Plots) of 99% Occupied Bandwidth and 26dB Bandwidth

CDMA BC0:

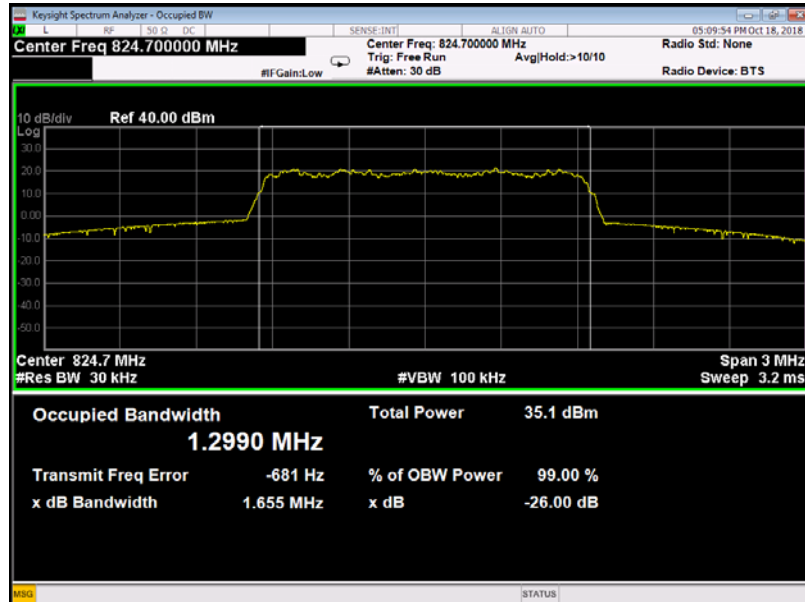

99% & 26dB Occupied Bandwidth Channel 1013

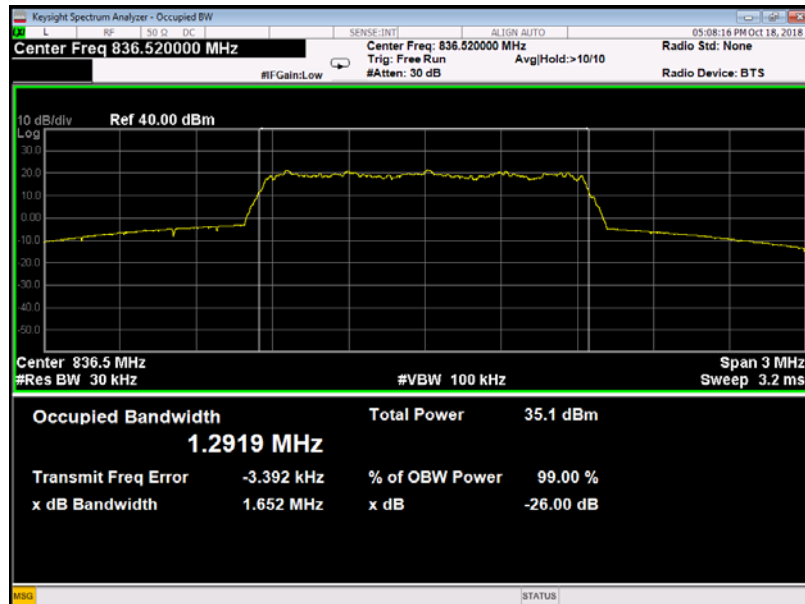

99% & 26dB Occupied Bandwidth Plot on Channel 384

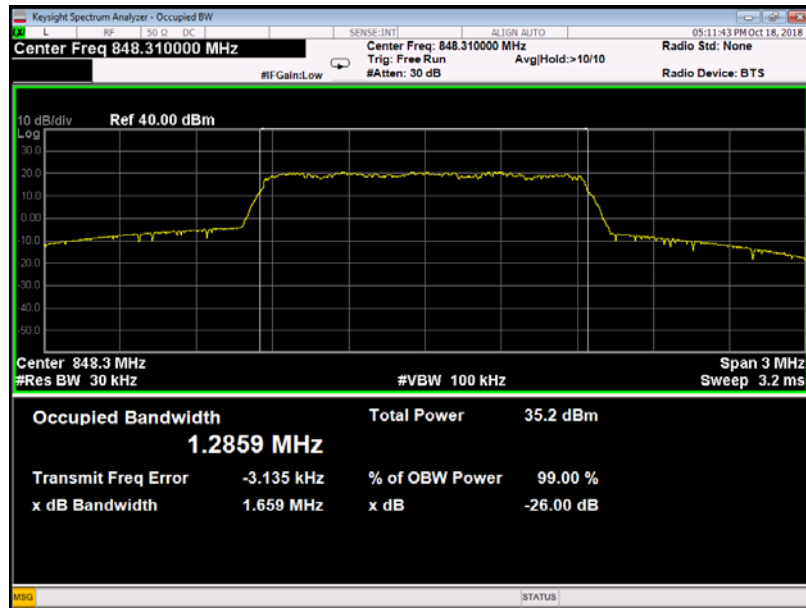

99% & 26dB Occupied Bandwidth Plot on Channel 777

2.3 Frequency Stability

2.3.1 Requirement

The frequency stability shall be measured by variation of ambient temperature and variation of primary supply voltage to ensure that the fundamental emission stays within the authorized frequency block. The frequency stability of the transmitter shall be maintained within $\pm 0.00025\%$ ($\pm 2.5\text{ppm}$) of the center frequency.

2.3.2 Measuring Instruments

The measuring equipment is listed in the section 3 of this test report.

2.3.3 Test Procedures for Temperature Variation

1. The testing follows FCC KDB 971168 v03r01 Section 9.0.
2. The EUT was set up in the thermal chamber and connected with the system simulator.
3. With power OFF, the temperature was decreased to -30°C and the EUT was stabilized before testing. Power was applied and the maximum change in frequency was recorded within one minute.
4. With power OFF, the temperature was raised in 10°C steps up to 50°C . The EUT was stabilized at each step for at least half an hour. Power was applied and the maximum frequency change was recorded within one minute.

2.3.4 Test Procedures for Voltage Variation

1. The testing follows FCC KDB 971168 v03r01 Section 9.0.
2. The EUT was placed in a temperature chamber at $25\pm 5^{\circ}\text{C}$ and connected with the system simulator.
3. The power supply voltage to the EUT was varied from BEP to 115% of the nominal value measured at the input to the EUT.
4. The variation in frequency was measured for the worst case.

2.3.5 Test Setup

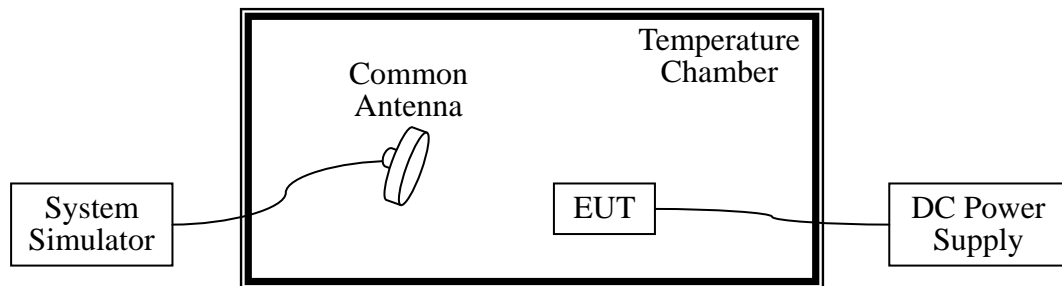

2.3.6 Test Results of Frequency Stability

Band	CDMA2000 BC0 1xRTT_RC3+SO55	Channel	384	
Limit(ppm)	2.5	Frequency	836.52MHz	
Power (VDC)	Temperature (°C)	GSM		Result
		Freq. Dev. (Hz)	Deviation (ppm)	
3.8	-30	16	0.02	PASS
	-20	25	0.03	
	-10	37	0.04	
	0	48	0.06	
	+10	37	0.04	
	+20	47	0.06	
	+30	51	0.06	
	+40	38	0.05	
+50	46	0.05		
4.2	+25	35	0.04	
3.5	+25	32	0.04	

Note: The frequency fundamental emissions stay within the authorized frequency block based on the frequency deviation measured is small.

2.4 Conducted Out of Band Emissions

2.4.1 Requirement

The power of any emission outside of the authorized operating frequency ranges must be lower than the transmitter power (P) by a factor of at least $43 + 10 \log (P)$ dB.

It is measured by means of a calibrated spectrum analyzer and scanned from 30 MHz up to a frequency including its 10th harmonic.

2.4.2 Measuring Instruments

The measuring equipment is listed in the section 3 of this test report.

2.4.3 Test Procedures

1. The testing follows FCC KDB 971168 v03r01 Section 6.0.
2. The EUT was connected to the spectrum analyzer and system simulator via a power divider.
3. The RF output of EUT was connected to the spectrum analyzer by an RF cable and attenuator. The path loss was compensated to the results for each measurement.
4. The middle channel for the highest RF power within the transmitting frequency was measured.
5. The conducted spurious emission for the whole frequency range was taken.
6. The RF fundamental frequency should be excluded against the limit line in the operating frequency band.
7. The limit line is derived from $43 + 10\log(P)$ dB below the transmitter power P(Watts)
 $= P(W) - [43 + 10\log(P)]$ (dB)
 $= [30 + 10\log(P)]$ (dBm) - $[43 + 10\log(P)]$ (dB)
 $= -13\text{dBm}$.

2.4.4 Test Setup

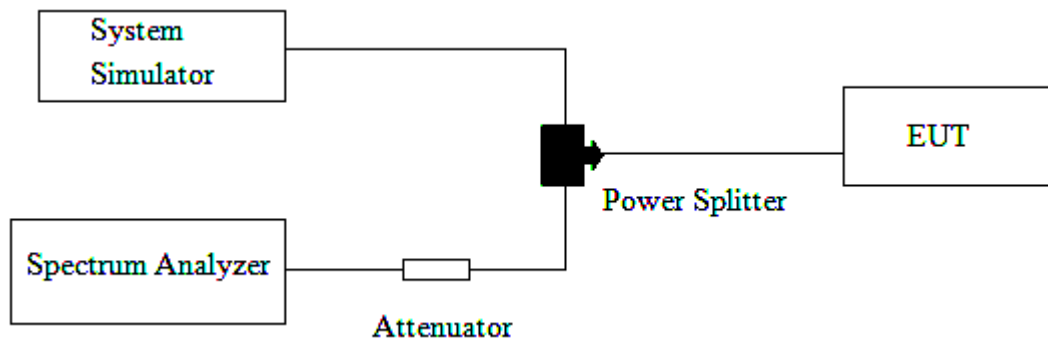

2.4.5 Test Result (Plots) of Conducted Spurious Emission

Note: For 9 KHz to 30MHz: the amplitude of spurious emissions is attenuated by more than 20dB below the permissible value, so we not provide the test result here.



Band	CDMA2000 BC0	Channel	1013
Test Mode	1xRTT_RC3+SO55(QPSK)	Frequency	824.7MHz

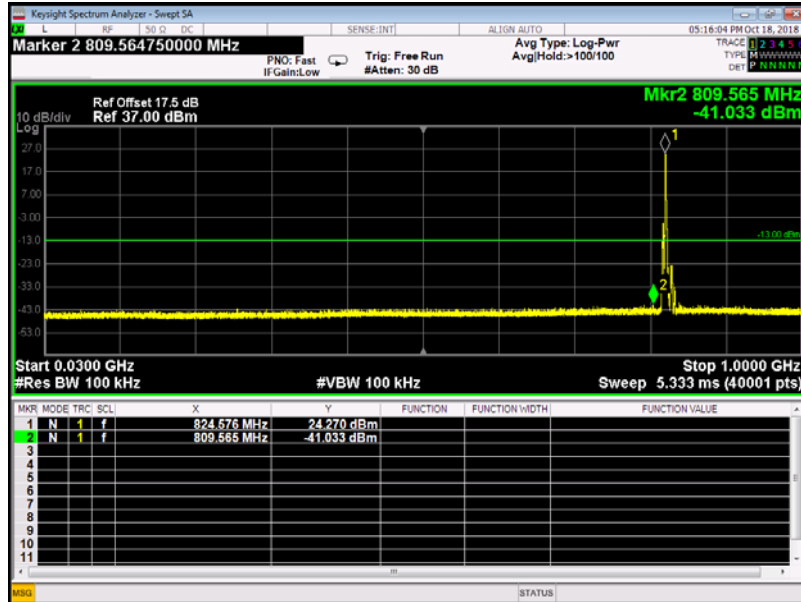

30MHz~1GHz

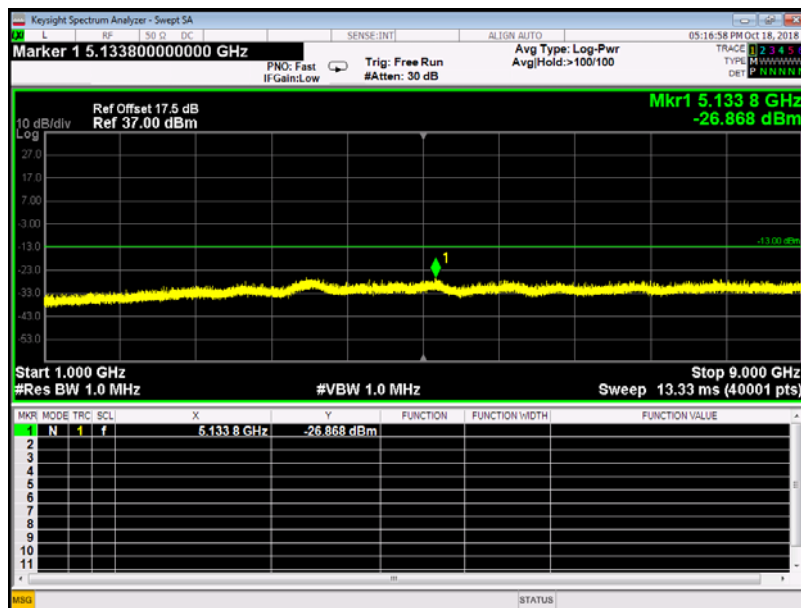

1GHz~9GHz



Band	CDMA2000 BC0	Channel	384
Test Mode	1xRTT_RC3+SO55(QPSK)	Frequency	836.52MHz

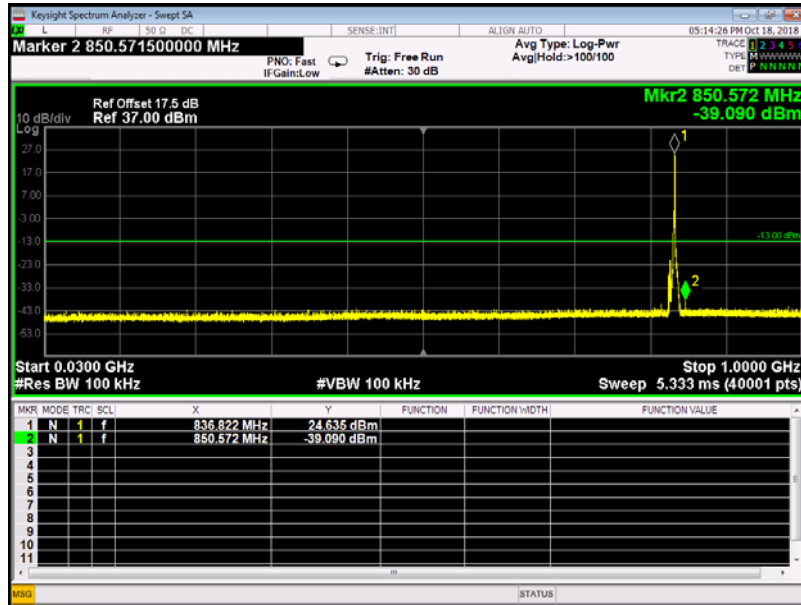

30MHz~1GHz

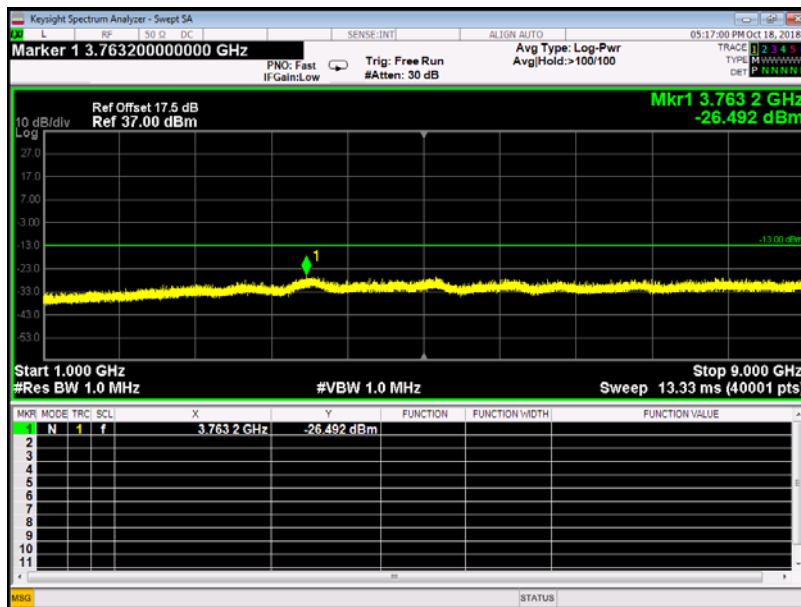

1GHz~9GHz



Band	CDMA2000 BC0	Channel	777
Test Mode	1xRTT_RC3+SO55(QPSK)	Frequency	848.31MHz

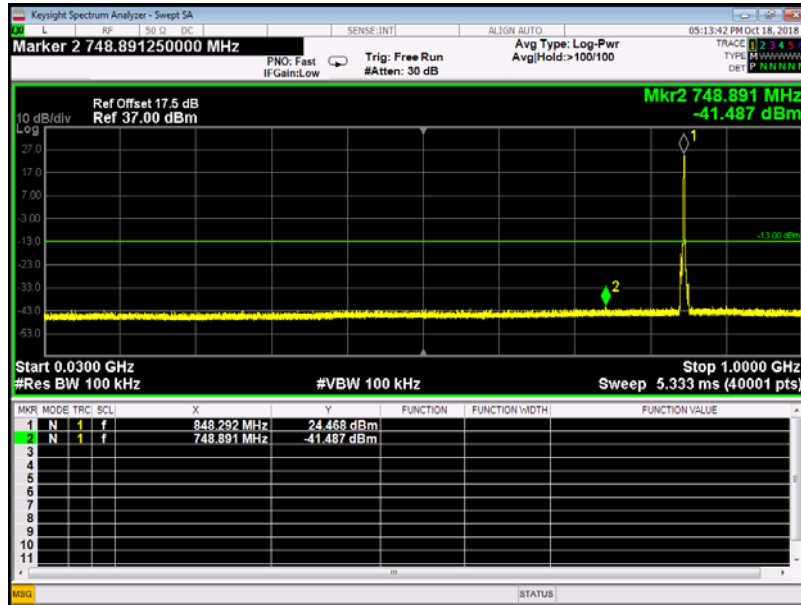

30MHz~1GHz

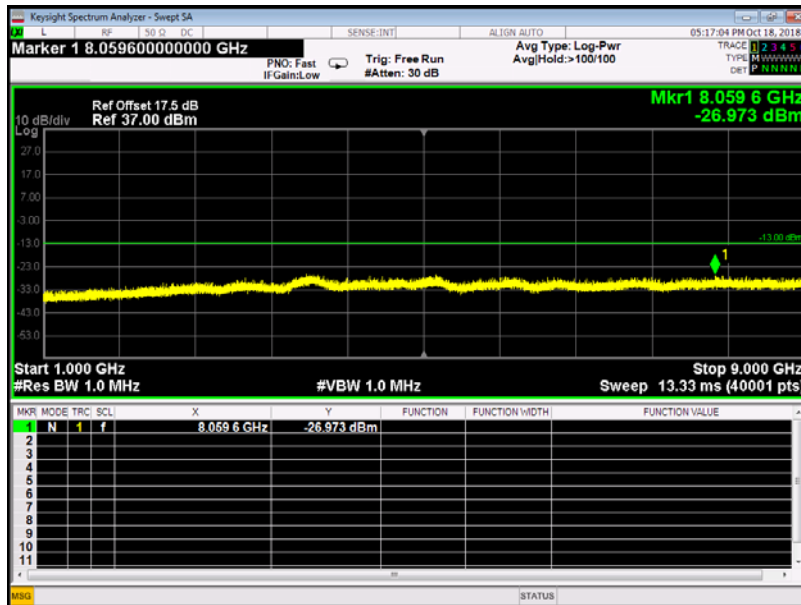

1GHz~9GHz

2.5 Band Edge

2.5.1 Requirement

The power of any emission outside of the authorized operating frequency ranges must be lower than the transmitter power (P) by a factor of at least $43 + 10 \log (P)$ dB.

2.5.2 Measuring Instruments

The measuring equipment is listed in the section 3 of this test report.

2.5.3 Test Procedures

1. The testing follows FCC KDB 971168 v03r01 Section 6.0.
2. The EUT was connected to the spectrum analyzer and system simulator via a power divider.
3. The RF output of EUT was connected to the spectrum analyzer by an RF cable and attenuator. The path loss was compensated to the results for each measurement.
4. The band edges of low and high channels for the highest RF powers were measured.
5. The RF fundamental frequency should be excluded against the limit line in the operating frequency band.
6. Set RBW=10KHz, VBW=30KHz
7. The limit line is derived from $43 + 10\log(P)$ dB below the transmitter power P(Watts)
 $= P(W) - [43 + 10\log(P)]$ (dB)
 $= [30 + 10\log(P)]$ (dBm) - $[43 + 10\log(P)]$ (dB)
 $= -13\text{dBm}$.

2.5.4 Test Setup

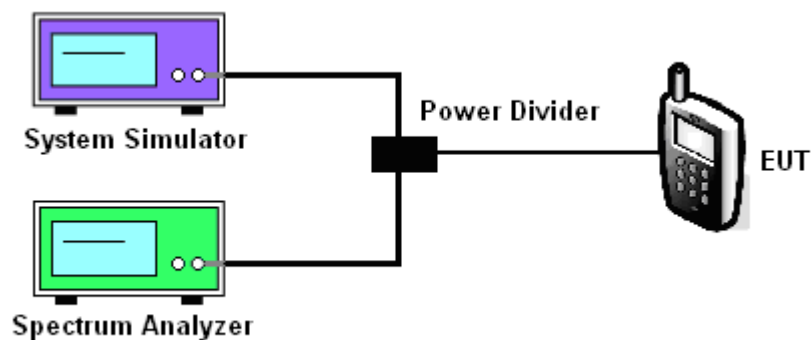



2.5.5 Test Result of Conducted Band Edge

Band	CDMA2000 BC0	Channel	1013
Test Mode	1xRTT_RC3+SO55(QPSK)	Frequency	824.7MHz

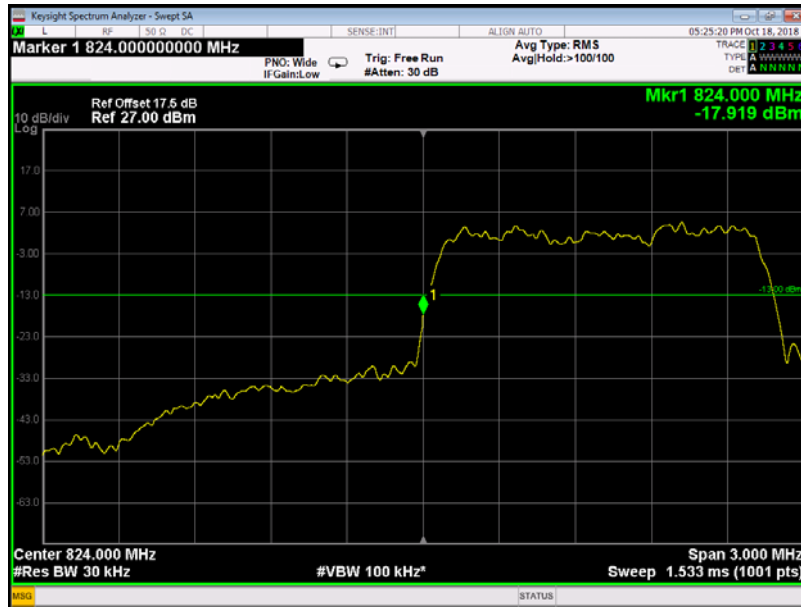

Band	CDMA2000 BC0	Channel	777
Test Mode	1xRTT_RC3+SO55(QPSK)	Frequency	848.31MHz



2.6 Transmitter Radiated Power (EIRP/ERP)

2.6.1 Requirement

The substitution method, in ANSI / TIA / EIA-603-E-2016, was used for ERP/EIRP measurement, and the spectrum analyzer configuration follows KDB 971168 D01 Power Meas. License Digital Systems v03r01. The ERP of mobile transmitters must not exceed 7 Watts (Cellular Band) and the EIRP of mobile transmitters are limited to 2 Watts (PCS Band) and 1 Watts (AWS Band).

2.6.2 Measuring Instruments

The measuring equipment is listed in the section 3 of this test report.

2.6.3 Test Procedures

1. The EUT was placed on a turntable with 1.5 meter height on a wooden turntable in a fully anechoic chamber.
2. The EUT was set at 3 meters from the receiving antenna, which was mounted on the antenna tower.
3. The radiated emission at the fundamental frequency was measured at 3 m with a test antenna and a spectrum analyzer which used a channel power option across EUT's signal bandwidth per section 4.0 of KDB 971168 D01v03r01.
4. The table was rotated 360 degrees and Both Horizontal & Vertical antenna polarities were tested and performed pretest to three orthogonal axis. The worst case emissions were reported.
5. The height of the receiving antenna is adjusted to look for the maximum value.
6. Taking the record of maximum value on spectrum analyzer.
7. Remove the EUT and replace it with substitution antenna. A signal generator was connected to the substitution antenna by a non-radiating cable. The absolute levels of the spurious emissions were measured by the substitution.
8. A Broadband antenna (for below 1GHz) and horn antenna (for above 1GHz) was substituted in place of the EUT and was driven by a signal generator.
9. The conducted power at the terminal of the antenna is measured.
10. Repeat step 3 to step 9 to get the maximum ERP/EIRP of the substitution antenna.

$$11. \text{ERP/EIRP} = P_s + E_t - E_s + G_s = P_s + R_t - R_s + G_s$$

P_s (dBm): Input power to substitution antenna.

G_s (dBi or dBd): Substitution antenna Gain.

$$E_t = R_t + \text{AF} \quad E_s = R_s + \text{AF}$$

AF (dB/m): Receive antenna factor

R_t : The highest received signal in spectrum analyzer for EUT.

R_s : The highest received signal in spectrum analyzer for substitution antenna.

2.6.4 Test Setup

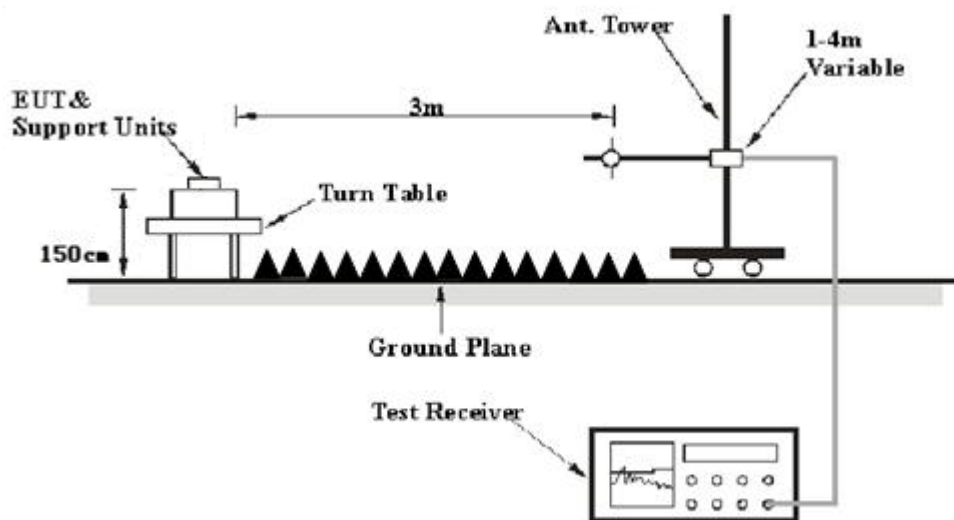



2.6.5 Test Result of Transmitter Radiated Power

Note: The worst case test configuration was found in the vertical positioning where the EUT is laying on its side. The data reported in the tables below were measured in this test setup.

Band	Channel	Frequency (MHz)	Antenna Pol (H/V)	Measured ERP dBm	Limit dBm	Verdict
CDMA2000 BC0 1xRTT	1013	824.70	V	21.25	38.5	PASS
			H	19.09		
	384	836.52	V	21.21		PASS
			H	19.10		
	777	848.31	V	21.32		PASS
			H	19.07		

2.7 Radiated Spurious Emissions

2.7.1 Requirement

The power of any emission outside of the authorized operating frequency ranges must be attenuated below the transmitter power (P) by a factor of at least $43 + 10 \log (P)$ dB. The spectrum is scanned from 30 MHz up to a frequency including its 10th harmonic.

2.7.2 Measuring Instruments

The measuring equipment is listed in the section 3 of this test report.

2.7.3 Test Procedures

1. The EUT was placed on a rotatable wooden table with 0.8 meter above ground for below 1GHz, and 1.5meter for above 1GHz.
2. The EUT was set 3 meters from the receiving antenna, which was mounted on the antenna tower.
3. The table was rotated 360 degrees and 3-orthogonal axis to determine the position of the highest spurious emission.
4. The height of the receiving antenna is varied between one meter and four meters to search the maximum spurious emission for both horizontal and vertical polarizations.
5. Make the measurement with the spectrum analyzer's RBW = 1MHz, VBW = 3MHz, taking the record the maximum spurious emission.
6. Remove the EUT and replace it with substitution antenna. A signal generator was connected to the substitution antenna by a non-radiating cable. The absolute levels of the spurious emissions were measured by the substitution.
7. A Broadband antenna (for below 1GHz) and horn antenna (for above 1GHz) was substituted in place of the EUT and was driven by a signal generator.
8. Tune the output power of signal generator to the same emission level with EUT maximum spurious emission.
9. Taking the record of output power at antenna port.
10. Repeat step 3 to step 9 for another polarization.
11. The RF fundamental frequency should be excluded against the limit line in the operating frequency band.

The limit line is derived from $43 + 10\log(P)$ dB below the transmitter power P(Watts)



$$\begin{aligned} &= P(W) - [43 + 10\log(P)] \text{ (dB)} \\ &= [30 + 10\log(P)] \text{ (dBm)} - [43 + 10\log(P)] \text{ (dB)} \\ &= -13\text{dBm}. \end{aligned}$$

12. The spectrum is measured from 9 KHz to the 10th harmonic of the fundamental frequency of the transmitter using CISPR quasi peak detector below 1GHz. The worst case emissions are reported however emissions whose levels were not within 20dB of the respective limits were not reported.
13. For 9KHz to 30MHz: the amplitude of spurious emissions which are attenuated by more than 20dB below the permissible value has no need to be reported.
14. All Spurious Emission tests were performed in X, Y, Z axis direction and low, middle, high channel. And only the worst axis test condition was recorded in this test report.

2.7.4 Test Setup

For radiated emissions from 30MHz to 1GHz

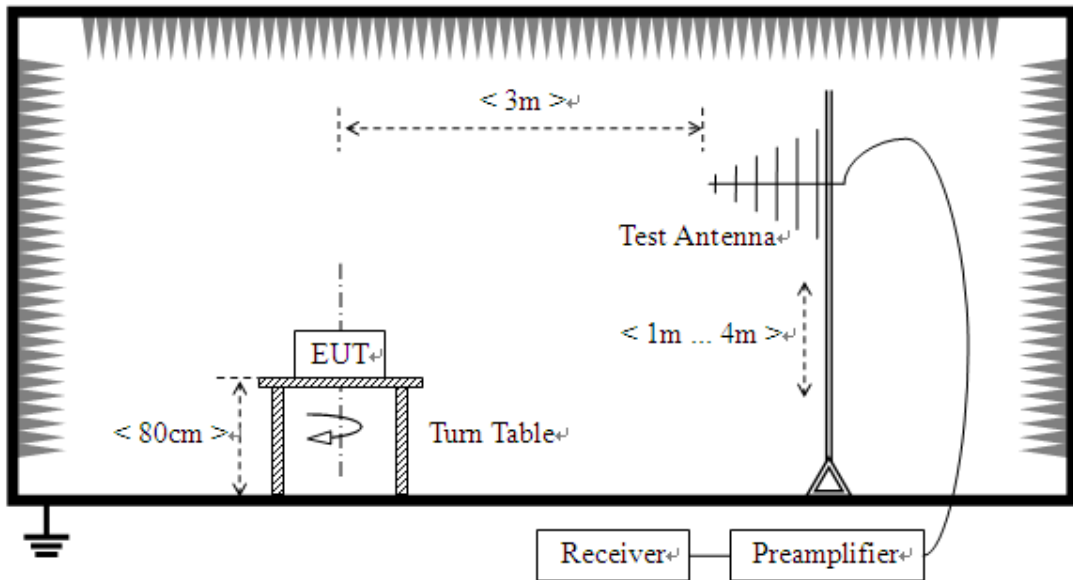

For radiated emissions above 1GHz

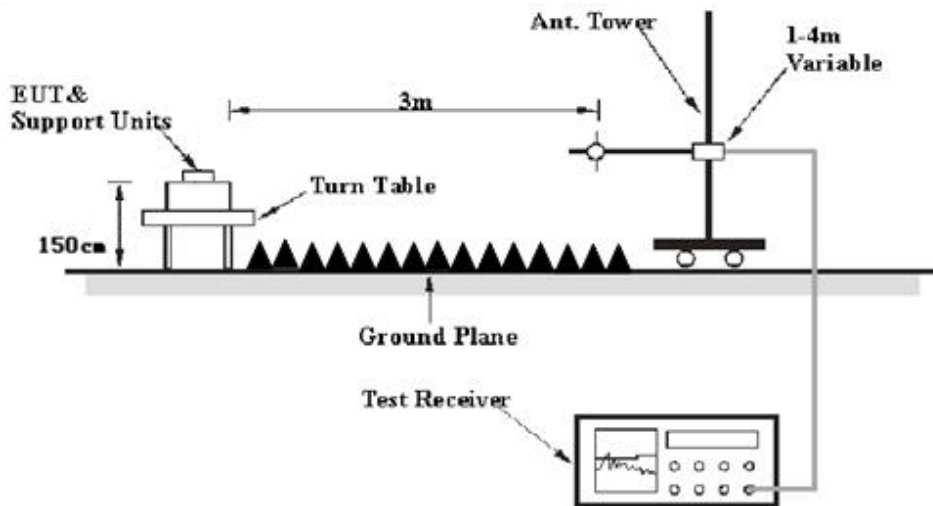

2.7.5 Test Results of Radiated Spurious Emissions

Note: All test modes of the Radiated Spurious Emission (RSE) were tested; only the test worse data in bold of these modes were reported.

CMDA2000 BCO Middle Channel

NO.	Freq. [MHz]	Reading Level [dBm]	Absolute Level [dBm]	Limit [dBm]	Margin [dB]	Factor [dB]	Polarity
1	1726.36	-77.20	-57.87	-13.00	44.87	19.33	Horizont
2	2643.82	-78.03	-52.68	-13.00	39.68	25.35	Horizont
3	3525.26	-75.86	-47.25	-13.00	34.25	28.61	Horizont
4	4406.20	-77.14	-48.23	-13.00	35.23	28.91	Horizont
5	5287.14	-76.95	-44.74	-13.00	31.74	32.21	Horizont

Remark: Spurious emission within 30MHz-1GHz were found more than 20dB below limit line.

NO.	Freq. [MHz]	Reading Level [dBm]	Absolute Level [dBm]	Limit [dBm]	Margin [dB]	Factor [dB]	Polarity
1	1762.38	-76.31	-56.31	-13.00	43.31	20.00	Vertical
2	2641.82	-79.04	-53.24	-13.00	40.24	25.80	Vertical
3	3525.26	-79.14	-50.40	-13.00	37.40	28.74	Vertical
4	4406.20	-76.98	-47.36	-13.00	34.36	29.62	Vertical
5	5287.14	-77.89	-45.23	-13.00	32.23	32.66	Vertical

Remark: Spurious emission within 30MHz-1GHz were found more than 20dB below limit line.

Note: Absolute Level=Reading level + Factor



3. LIST OF MEASURING EQUIPMENT

Description	Manufacturer	Model	Serial No.	Test Date	Due Date	Remark
EMI Test Receiver	R&S	ESIB26	A0304218	2018.05.25	2019.05.24	Radiation
Loop Antenna	Schwarz beck	HFH2-Z2	100047	2018.05.25	2019.05.24	Radiation
Bilog Antenna	Schwarzbeck	VULB 9163	9163-274	2018.05.25	2019.05.24	Radiation
Broadband antenna (30MHz~1GHz)	R&S	HL562	101341	2018.05.25	2019.05.24	Radiation
Broadband antenna (30MHz~1GHz)	R&S	HL562	101339	2018.05.25	2019.05.24	Radiation
Double ridge horn antenna (1GHz~18GHz)	R&S	HF906	100150	2018.05.25	2019.05.24	Radiation
Double ridge horn antenna (1GHz~18GHz)	R&S	HF906	100148	2018.05.25	2019.05.24	Radiation
Horn antenna (18GHz~26.5GHz)	R&S	HM118	101286	2018.05.25	2019.05.24	Radiation
Horn antenna (18GHz~26.5GHz)	R&S	HM118	101284	2018.05.25	2019.05.24	Radiation
Amplifier 20M~3GHz	R&S	PAP-0203H	22018	2018.05.25	2019.05.24	Radiation
Ampilier 1G~18GHz	R&S	MITEQ AFS42-0010180 0	25-S-42	2018.05.25	2019.05.24	Radiation
Ampilier 18G~40GHz	R&S	JS42-18002600- 28-5A	12111.0980.00	2018.05.25	2019.05.24	Radiation
Spectrum Analyzer	Keysight	N9030A	ATO-67098	2018.05.25	2019.05.24	Conducted
LISN	ROHDE&SCH WARZ	ESH2-Z5	A0304221	2018.05.25	2019.05.24	Conducted
Test Receiver	R&S	ESCS30	A0304260	2018.05.25	2019.05.24	Conducted
Cable	SUNHNER	SUCOFLEX 100	/	2018.05.25	2019.05.24	Radiation
Cable	SUNHNER	SUCOFLEX 104	/	2018.05.25	2019.05.24	Radiation

** END OF REPORT **