



RF TEST REPORT

Report No.: SET2019-07971

Product Name: Mobile Data Terminal

FCC ID: 2AC6AC71B

Model No. : C71

Applicant: Shenzhen Chainway Information Technology Co.,Ltd.

Address: 9/F, Building 2, Daqian Industrial Park, Longchang Rd., District
67, Bao'an, Shenzhen, China.

Dates of Testing: 07/21/2019 — 08/05/2019

Issued by: CCIC Southern Electronic Product Testing (Shenzhen) Co., Ltd.

Lab Location: Building 28/29, East of Shigu, Xili Industrial Zone, Xili Road,
Nanshan District, Shenzhen, Guangdong, China.

Tel: 86 755 26627338 **Fax:** 86 755 26627238

This test report consists of 25 pages in total. It may be duplicated completely for legal use with the approval of the applicant. It should not be reproduced except in full, without the written approval of our laboratory. The client should not use it to claim product endorsement by CCIC-SET. The test results in the report only apply to the tested sample. The test report shall be invalid without all the signatures of testing engineers, reviewer and approver. Any objections must be raised to CCIC-SET within 15 days since the date when the report is received. It will not be taken into consideration beyond this limit.



Test Report

Product Name : Mobile Data Terminal

Brand Name : CHAINWAY

Trade Name : CHAINWAY

Applicant : Shenzhen Chainway Information Technology Co.,Ltd.

Applicant Address : 9/F, Building 2, Daqian Industrial Park, Longchang Rd.,
District 67, Bao'an, Shenzhen China.

Manufacturer : Shenzhen Chainway Information Technology Co.,Ltd.

Manufacturer Address : 9/F, Building 2, Daqian Industrial Park, Longchang Rd.,
District 67, Bao'an, Shenzhen China.

Test Standards : 47 CFR Part 15 Subpart E 15.407

Test Result : PASS

Tested by : Robin Luo 2019.08.05
Robin Luo, Test Engineer

Reviewed by : Chris You 2019.08.05
Chris You, Senior Engineer

Approved by : Shuangwen Zhang 2019.08.05
Shuangwen Zhang, Manager



TABLE OF CONTENTS

RF TEST REPORT 1

1. GENERAL INFORMATION 4

1.1. EUT Description 4

1.2. Test Standards and Results 5

1.3. Test Facility 5

2. U-NII DFS RULE REQUIREMENTS 6

2.1. Working modes and required test items 6

2.2. Test limits and radar signal parameters 7

3. TEST PROCEDURE 10

3.1. DFS Test Setup configuration 10

3.2. BVADT DFS Measurement system: 11

4. TEST RESULTS 21

5. LIST OF MEASURING EQUIPMENT 25

Change History		
Issue	Date	Reason for change
1.0	2019.08.05	First edition



1. General Information

1.1. EUT Description

EUT Type	Mobile Data Terminal
EUT supports Radios application	WLAN5.0GHz 802.11a/n (HT20/40)/ac(VHT20/40/80)
Operation	<input type="checkbox"/> Master device
	<input type="checkbox"/> Slaver device with radar detection function
	<input checked="" type="checkbox"/> Slaver device without radar detection function
Hotspot Mode	Not support
TPC Mode	Not support
Modulation Type	CCK, DQPSK, DBPSK for DSSS 256QAM, 64QAM, 16QAM, QPSK, BPSK for OFDM 256QAM for OFDM in 11ac mode only
Transfer Rate	802.11a: 54/48/36/24/18/12/9/6 Mbps 802.11n : up to 135 Mbps 802.11ac: up to V9
Frequency Range	Band UNII-1: 5150 ~ 5250MHz Band UNII-2a: 5250 ~ 5350MHz Band UNII-2c: 5500 ~ 5700MHz Band UNII-3: 5725 ~ 5850MHz
Channel Bandwidth	802.11a: 20MHz 802.11n: 20MHz/40MHz 802.11ac: 20MHz/40MHz/80MHz
Channel Number	5150 MHz ~ 5250MHz/5725 MHz ~ 5850MHz:4/5 for 802.11a, 802.11n (HT20), 802.11ac (VHT20), 2 for 802.11n (HT40), 802.11ac(VHT40), 1 for 802.11ac (VHT80)
Antenna Type	Internal Antenna
Antenna Gain	0.57dBi ;



1.2. Test Standards and Results

The objective of the report is to perform testing according to 47 CFR Part 15 Subpart E for the EUT FCC Certification:

No.	Identity	Document Title
1	47 CFR Part 15 Subpart E § 15.407	Radio Frequency Devices
2	KDB Publication 905462 D02v02	UNII DFS Compliance Procedures New Rules
3	KDB Publication 905462 D03v01	UNII Clients Without Radar Detection New Rules

Test detailed items/section required by FCC rules results are as below:

No.	FCC Rule	Description	Result
1	15.407	Channel Move Time	PASS
2	15.407	Channel Closing Transmission Time	PASS
3	15.407	Non- Occupancy Period	PASS

1.3. Test Facility

NVLAP Lab Code: 201008-0

CCIC-SET is a third party testing organization accredited by NVLAP according to ISO/IEC 17025. The accreditation certificate number is 201008-0.

FCC- Designation Number: CN5031

CCIC Southern Electronic Product Testing (Shenzhen) Co., Ltd. EMC Laboratory has been registered and fully described in a report filed with the FCC (Federal Communications Commission). The acceptance letter from the FCC is maintained in our files. Designation Number: CN5031, valid time is until December 31, 2018.

ISED Registration: 11185A-1

CAB identifier:CN0064

CCIC Southern Electronic Product Testing (Shenzhen) Co., Ltd. EMC Laboratory has been registered by Certification and Engineering Bureau of Industry Canada for the performance of radiated measurements with Registration No. 11185A-1 on Aug. 04, 2016, valid time is until Dec. 31, 2019

2. U-NII DFS Rule Requirements

2.1. Working modes and required test items

The manufacturer shall state whether the UUT is capable of operating as a Master and/or a Client. If the UUT is capable of operating in more than one operating mode then each operating mode shall be tested separately. See tables 1 and 2 for the applicability of DFS requirements for each of the operational modes.

Table 1: Applicability of DFS Requirements prior to use a channel

Requirement	Operational Mode		
	Master	Client without radar detection	Client with radar detection
Non-Occupancy Period	✓	Not required	✓
DFS Detection Threshold	✓	Not required	✓
Channel Availability Check Time	✓	Not required	Not required
Uniform Spreading	✓	Not required	Not required
U-NII Detection Bandwidth	✓	Not required	✓

Table 2: Applicability of DFS Requirements during normal operation

Requirement	Operational Mode		
	Master	Client without radar detection	Client with radar detection
DFS Detection Threshold	✓	Not required	✓
Channel Closing Transmission Time	✓	✓	✓
Channel Move Time	✓	✓	✓
U-NII Detection Bandwidth	✓	Not required	✓



2.2. Test limits and radar signal parameters

DFS Detection thresholds for Master Devices and Client Devices with Radar Detection

Maximum Transmit Power	Value (See Note 1 and 2)
≥ 200 millwatt	-64 dBm
< 200 millwatt	-62 dBm

Note 1: This is the level at the input of the receiver assuming a 0 dBi receive antenna.

Note 2: Throughout these test procedures an additional 1 dB has been added to the amplitude of the test transmission waveforms to account for variations in measurement equipment. This will ensure that the test signal is at or above the detection threshold level to trigger a DFS response.

DFS Response requirement values

Parameter	Value
Non-occupancy period	Minimum 30 minutes
Channel Availability Check Time	60 seconds
Channel Move Time	10 seconds See Note 1.
Channel Closing Transmission Time	200 milliseconds + an aggregate of 60 milliseconds over remaining 10 second period. See Notes 1 and 2.
U-NII Detection Bandwidth	100% of the UNII transmission power bandwidth. See Note 3.

Note 1: The instant that the Channel Move Time and the Channel Closing Transmission Time begins is as follows:

- For the Short Pulse Radar Test Signals this instant is the end of the Burst.
- For the Frequency Hopping radar Test Signal, this instant is the end of the last radar Burst generated.
- For the Long Pulse Radar Test Signal this instant is the end of the 12 second period defining the Radar Waveform.

Note 2: The Channel Closing Transmission Time is comprised of 200 milliseconds starting at the beginning of the Channel Move Time plus any additional intermittent control signals required to facilitate a Channel move (an aggregate of 60 milliseconds) during the remainder of the 10 second period. The aggregate duration of control signals will not count quiet periods in between transmissions.

Note 3: During the U-NII Detection Bandwidth detection test, radar type 1 is used and for each frequency step the minimum percentage of detection is 90 percent. Measurements are performed with no data traffic.



Parameters of DFS test signals

Step intervals of 0.1 microsecond for Pulse Width, 1 microsecond for PRI, 1 MHz for chirp width and 1 for the number of pulses will be utilized for the random determination of specific test waveforms.

Short pluse radar test waveforms

Radar Type	Pulse width (μsec)	PRI (μsec)	Number of Pulses	Minimum Percentage of Successful Detection	Minimum Number of Trials
0	1	1428	18	See Note 1	See Note 1
1	1	Test A:15 unique PRI values randomly selected from the list of 23 PRI values in Table 5a Test B:15 unique PRI values randomly selected within the range of 518-3066 μsec, with a minimum increment of 1μsec, excluding PRI values selected in Test A	Roundup $\left\{ \left(\frac{1}{360} \right) \cdot \left(\frac{19 \cdot 10^6}{PRI_{\mu sec}} \right) \right\}$	60%	30
2	1-5	150-230	23-29	60%	30
3	6-10	200-500	16-18	60%	30
4	11-20	200-500	12-16	60%	30
Aggregate (Radar Types 1-4)				80%	120
Note 1: Short Pulse Radar Type 0 should be used for the detection bandwidth test, channel move time, and channel closing time tests.					



Long pulse radar test waveform

Radar Type	Pulse Width (μ sec)	Chirp Width (MHz)	PRI (μ sec)	Number of Pulses per Burst	Number of Bursts	Minimum Percentage of Successful Detection	Minimum Number of Trials
5	50-100	5-20	1000-2000	1-3	8-20	80%	30

Frequency hopping radar test waveform

Radar Type	Pulse Width (μ sec)	PRI (μ sec)	Pulses per Hop	Hopping Rate (kHz)	Hopping Sequence Length (msec)	Minimum Percentage of Successful Detection	Minimum Number of Trials
6	1	333	9	0.333	300	70%	30

3. Test Procedure

3.1. DFS Test Setup configuration

Client without Radar Detection Mode

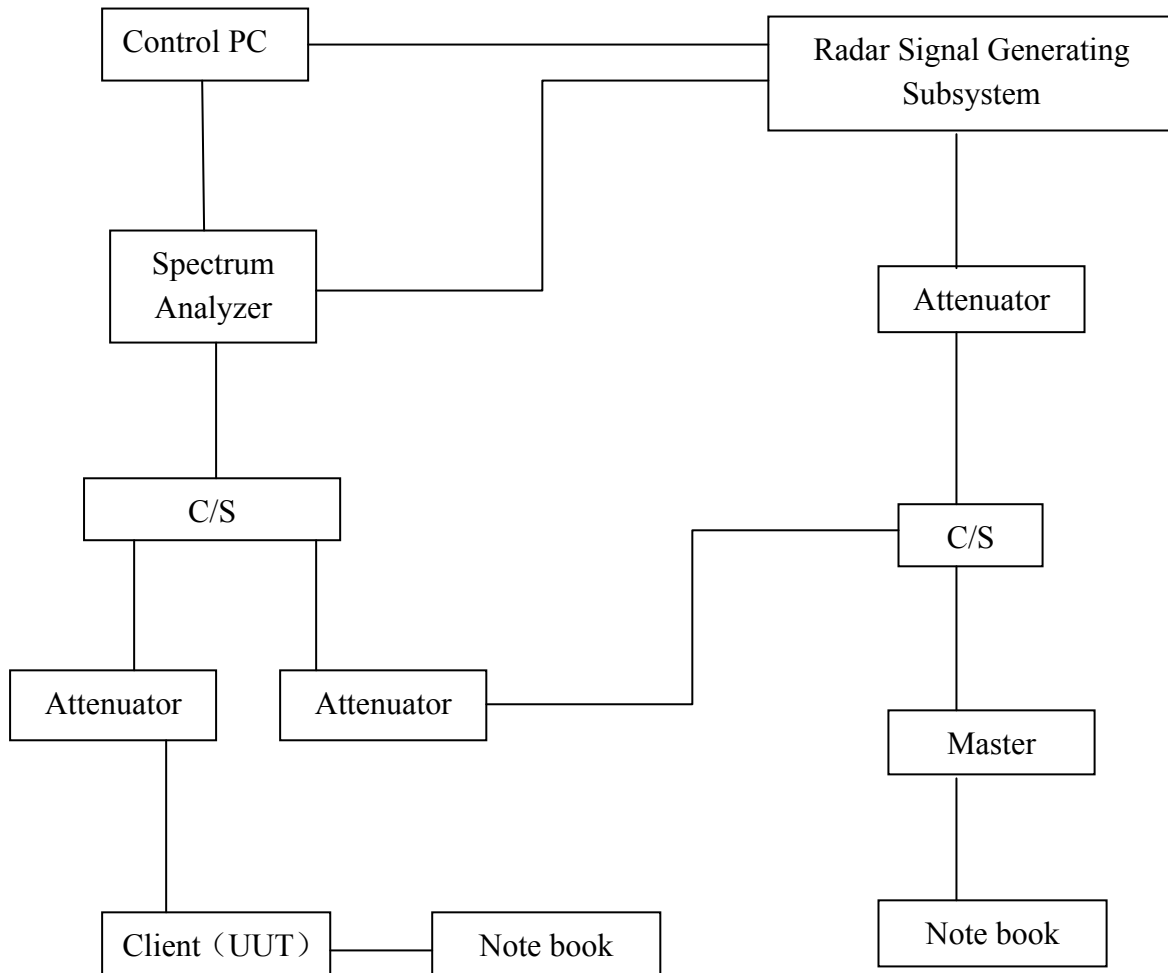

The UUT is a UNII device operating in client mode without radar detection. The radar test signals are injected into the master device.

3.2. BVADT DFS Measurement system:

A complete BVADT DFS Measurement System consists of two subsystems: (1) the Radar Signal Generating Subsystem and (2) the Traffic Monitoring Subsystem. The control PC is necessary for generating the Radar waveforms in Table 1, 2. The traffic monitoring subsystem is specified to the type of unit under test (UUT).

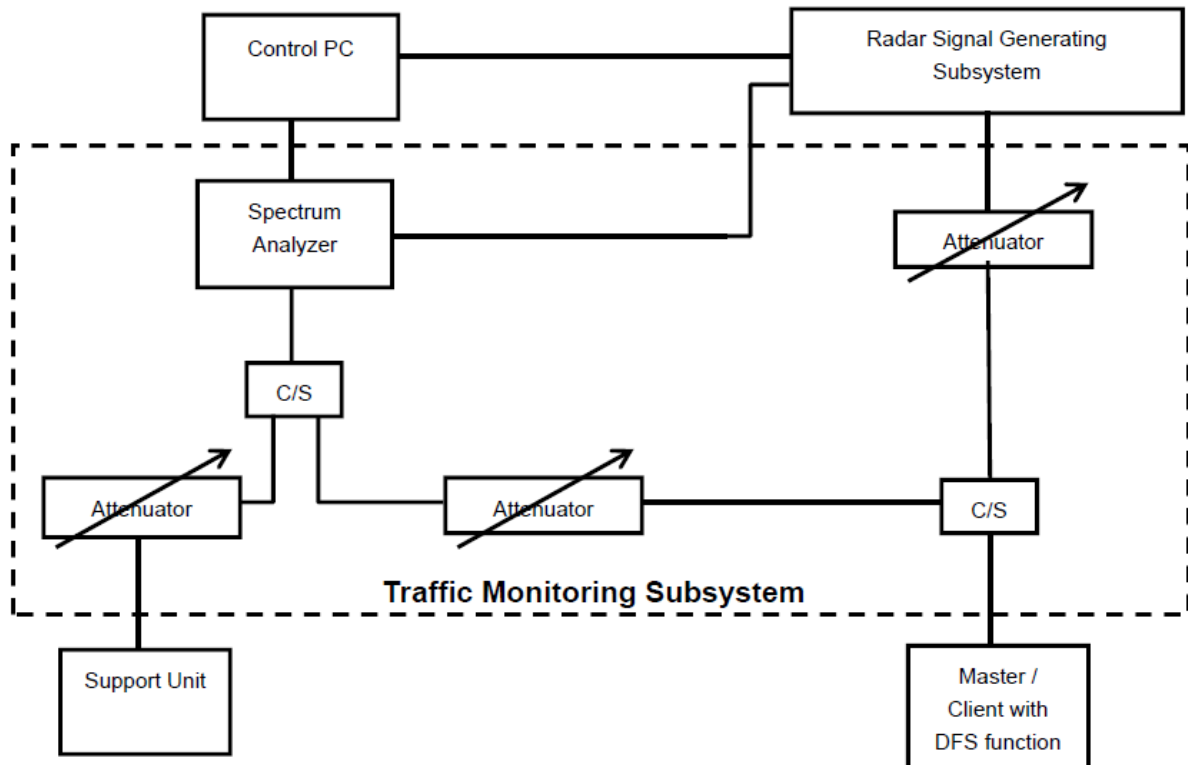

The test transmission will always be from the Master Device to the Client Device. While the Client device is set up to associate with the Master device and play the MPEG file (6 1/2 Magic Hours) from Master device, the designated MPEG test file and instructions are located at:

<http://ntiacsd.ntia.doc.gov/dfs/>.

Calibration of DFS detection threshold level:

The measured channel is 5290 MHz and 5530MHz in 80MHz Bandwidth. The radar signal was the same as transmitted channels, and injected into the antenna port of AP (master) or Client Device with Radar Detection, measured the channel closing transmission time and channel move time.

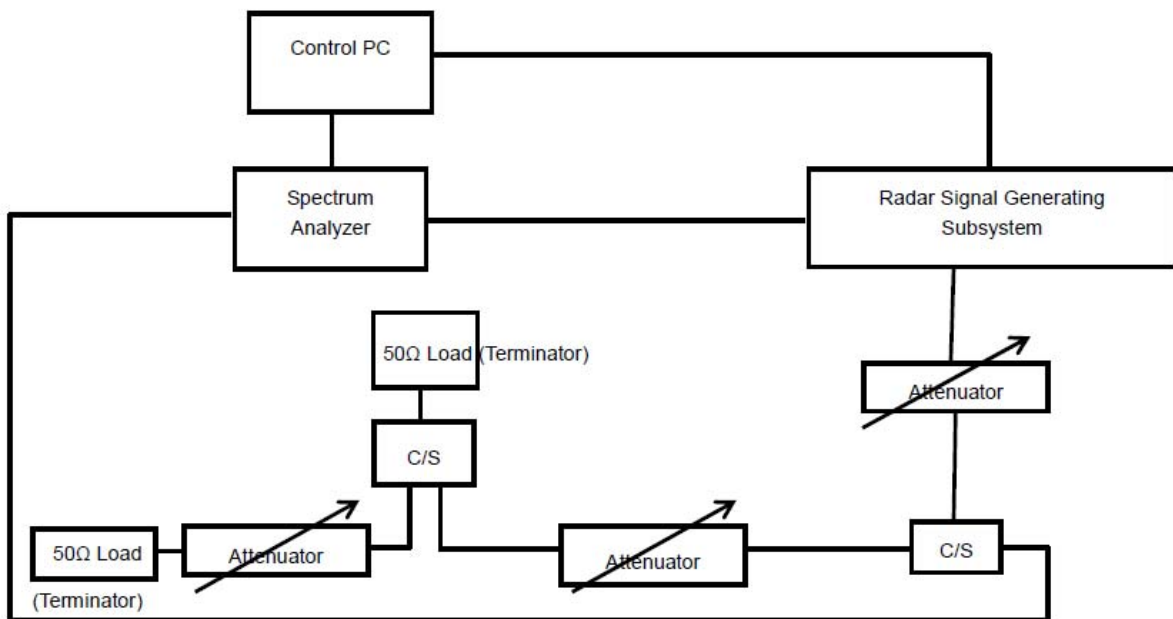
Conducted setup configuration of calibration of DFS detection threshold level

Calibration plots for each of the required radar waveforms

Radar type 0

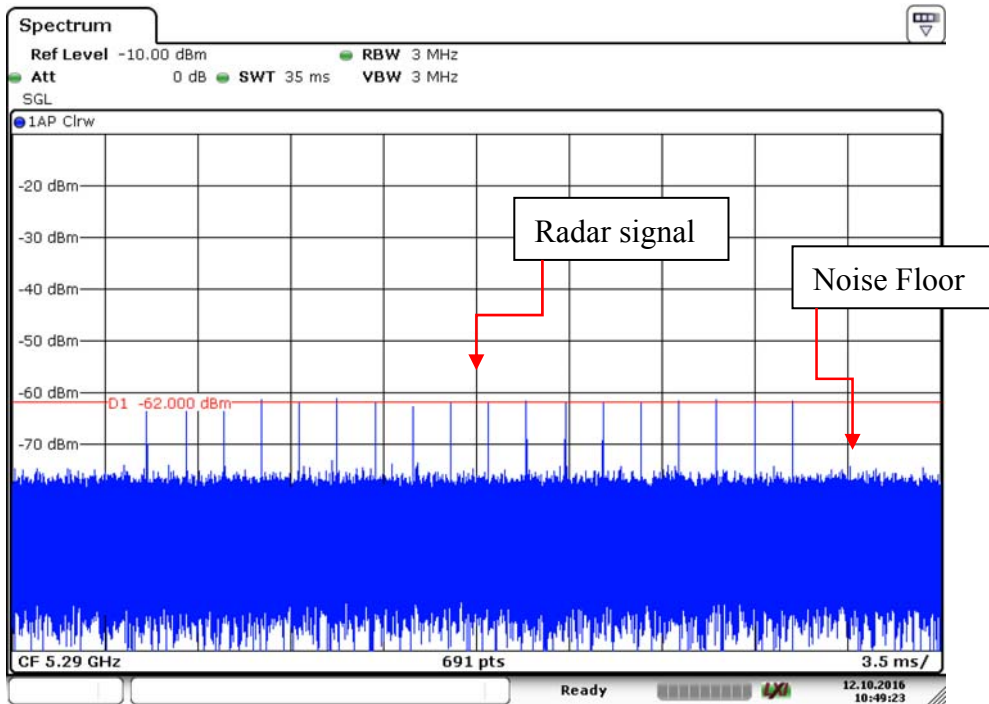

Radar Type 0 – 5290MHz

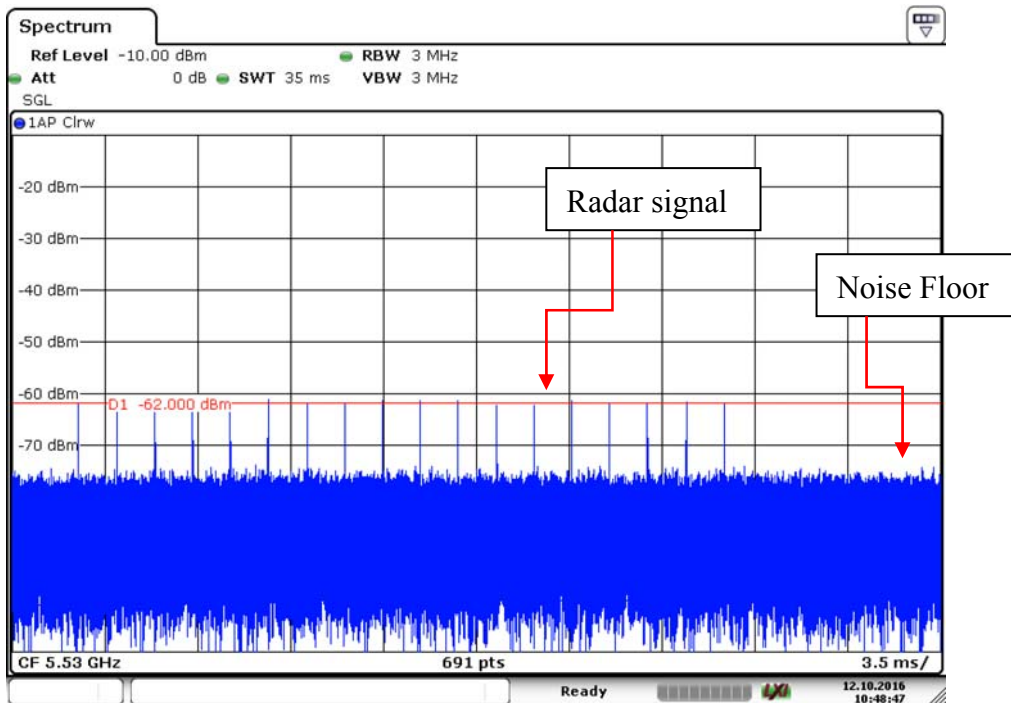

Radar Type 0 – 5530MHz

Radar type 1-A

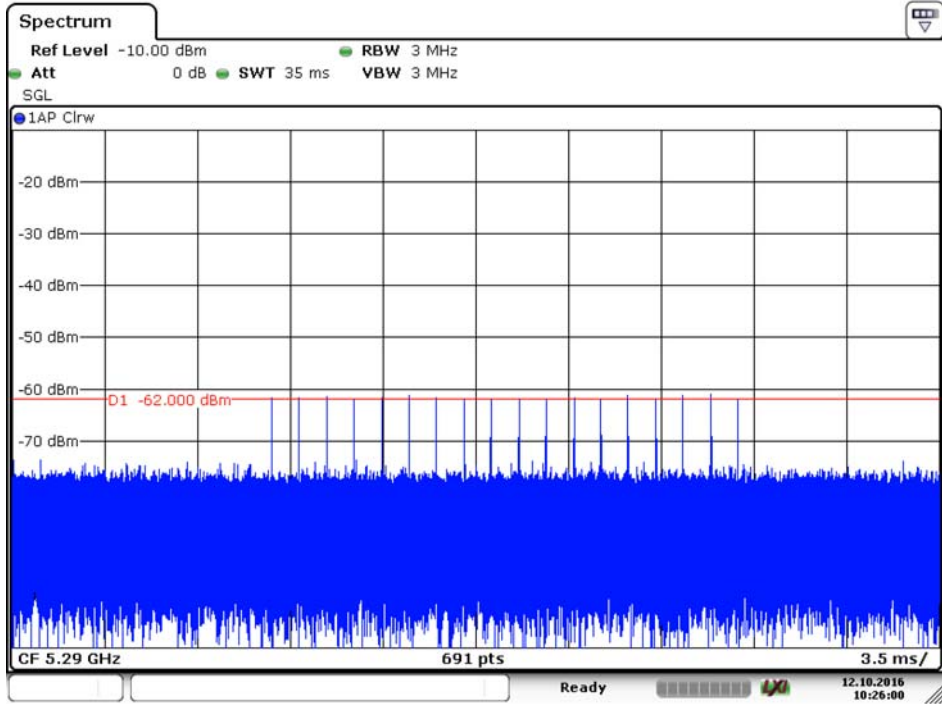

Radar Type 1A – 5290MHz

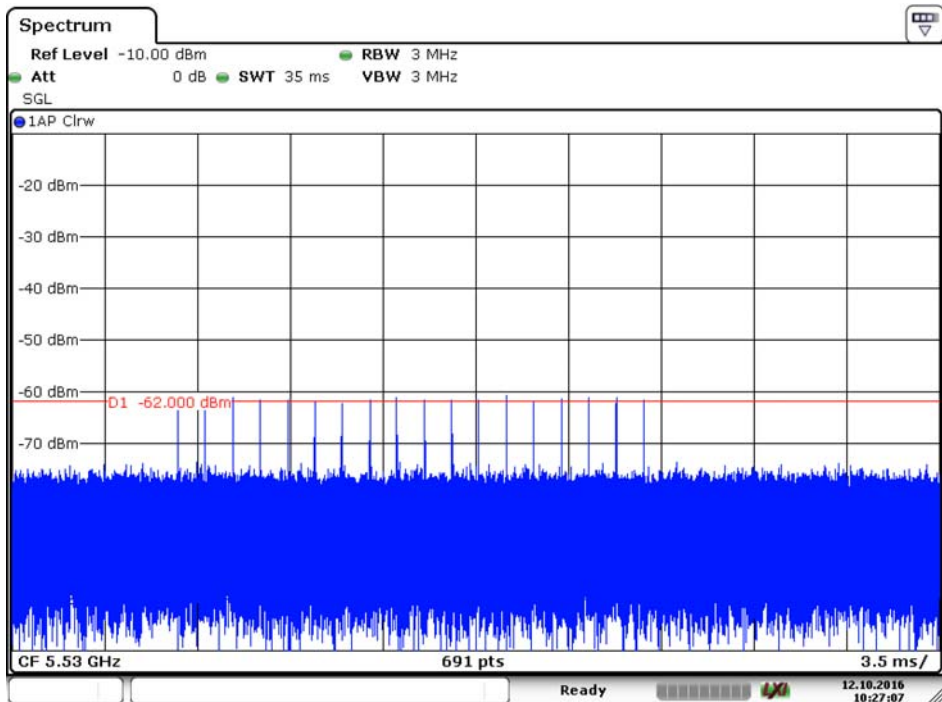

Radar Type 1A – 5530MHz

Radar type 1-B

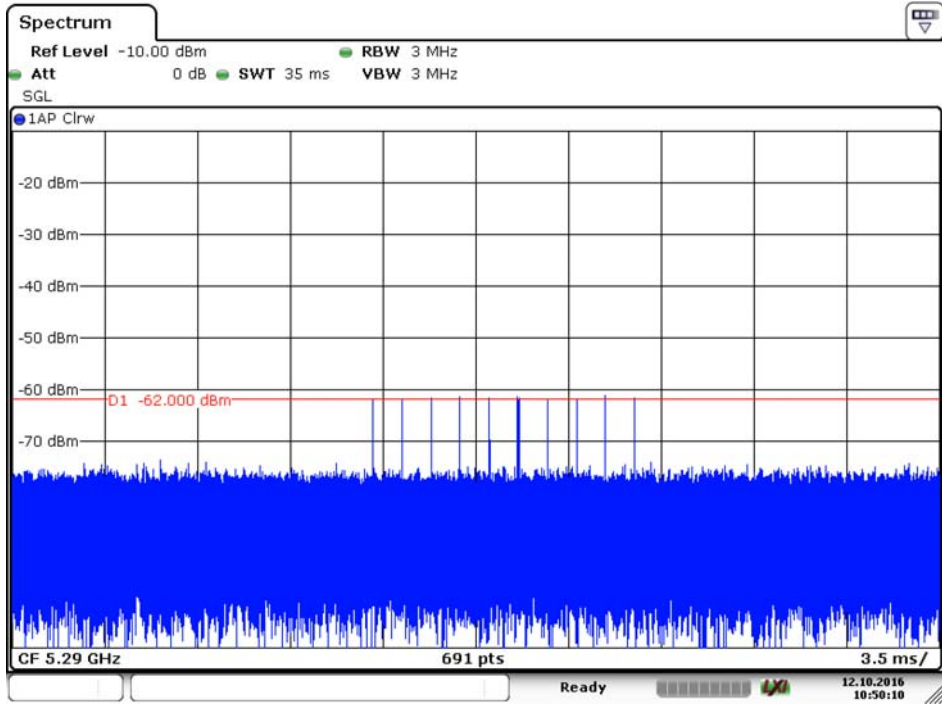

Radar Type 1B – 5290MHz

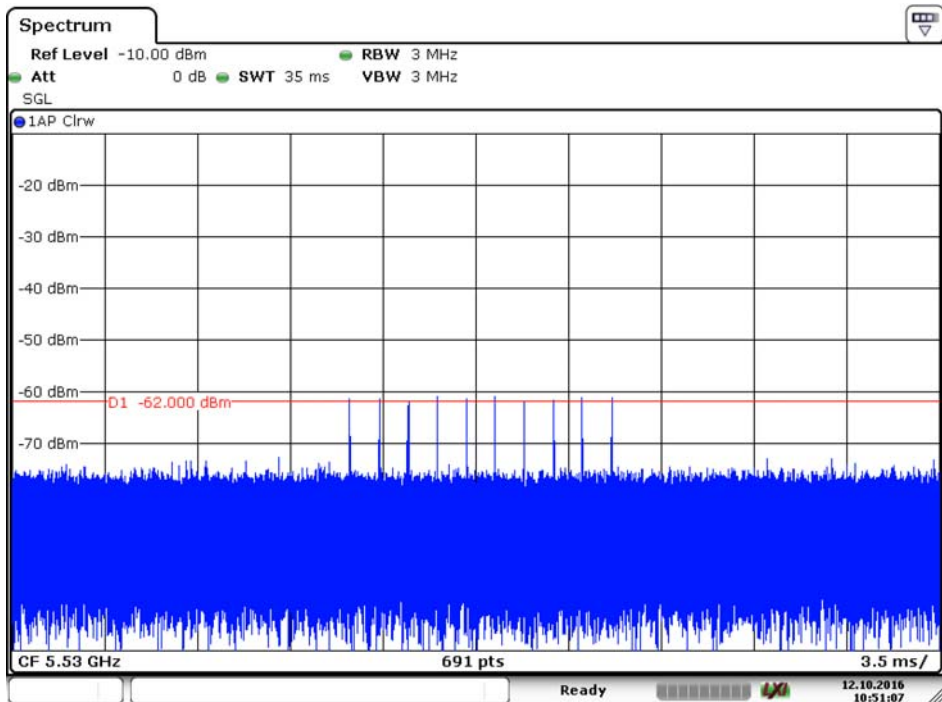

Radar Type 1B – 5530MHz

Radar type 2

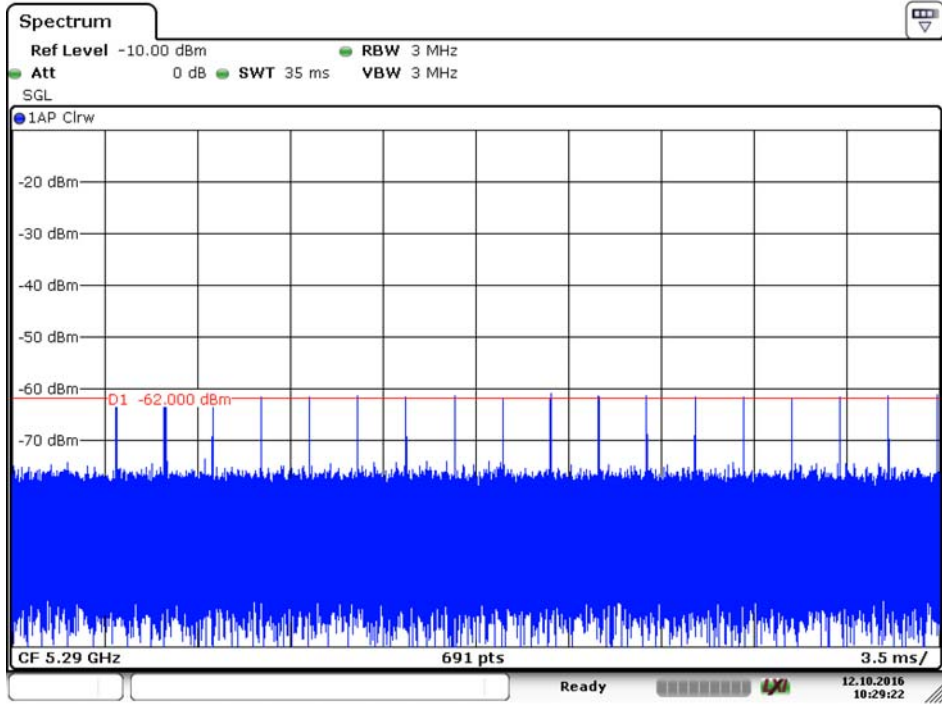

Radar Type 2 – 5290MHz

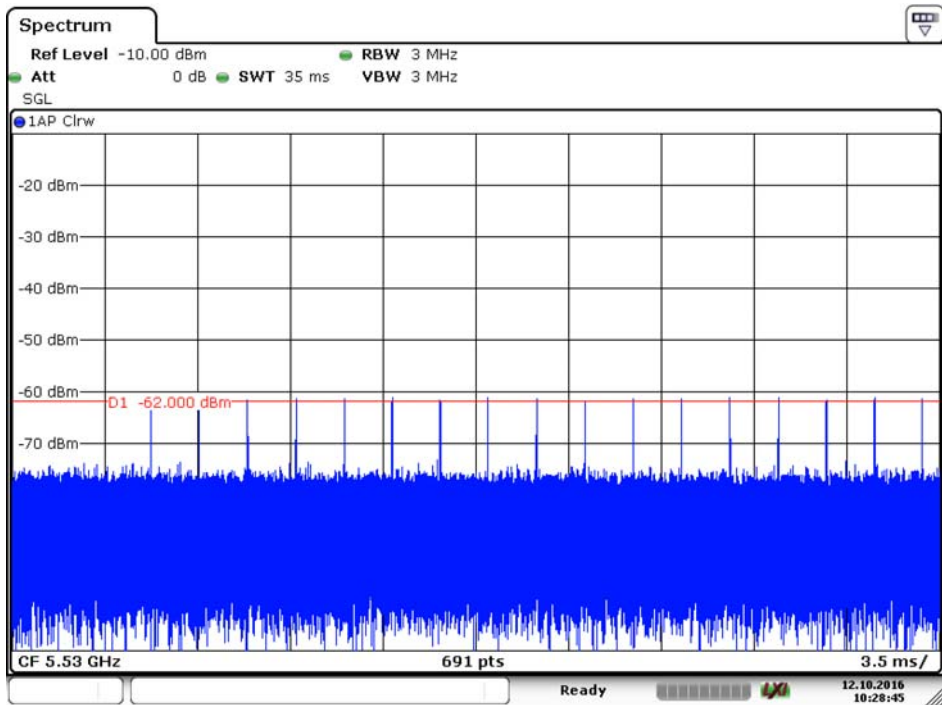

Radar Type 2 – 5530MHz

Radar type 3

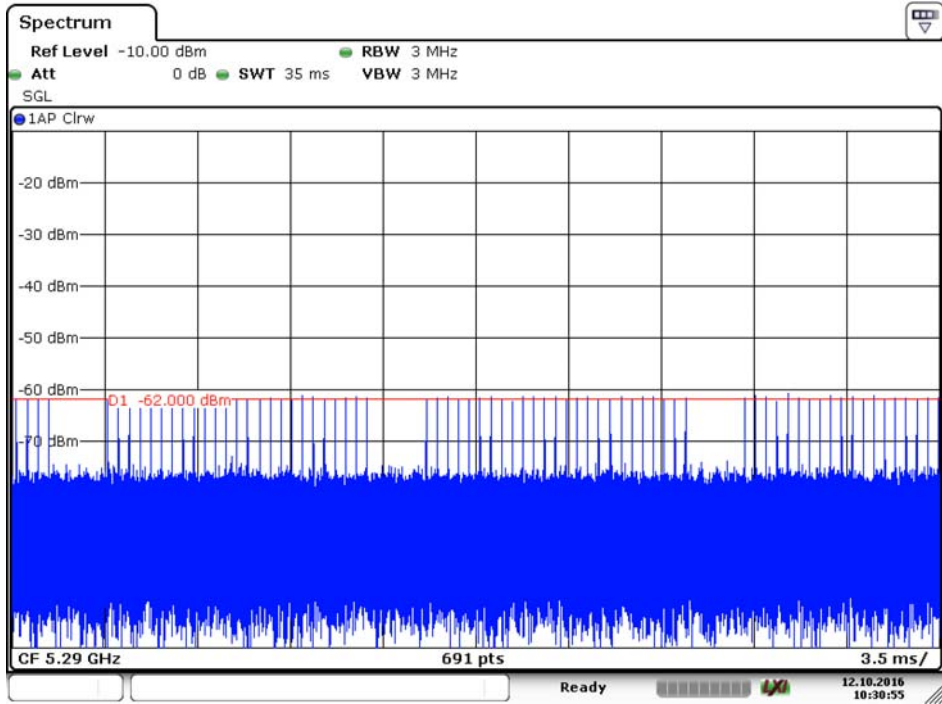

Radar Type 3 – 5290MHz

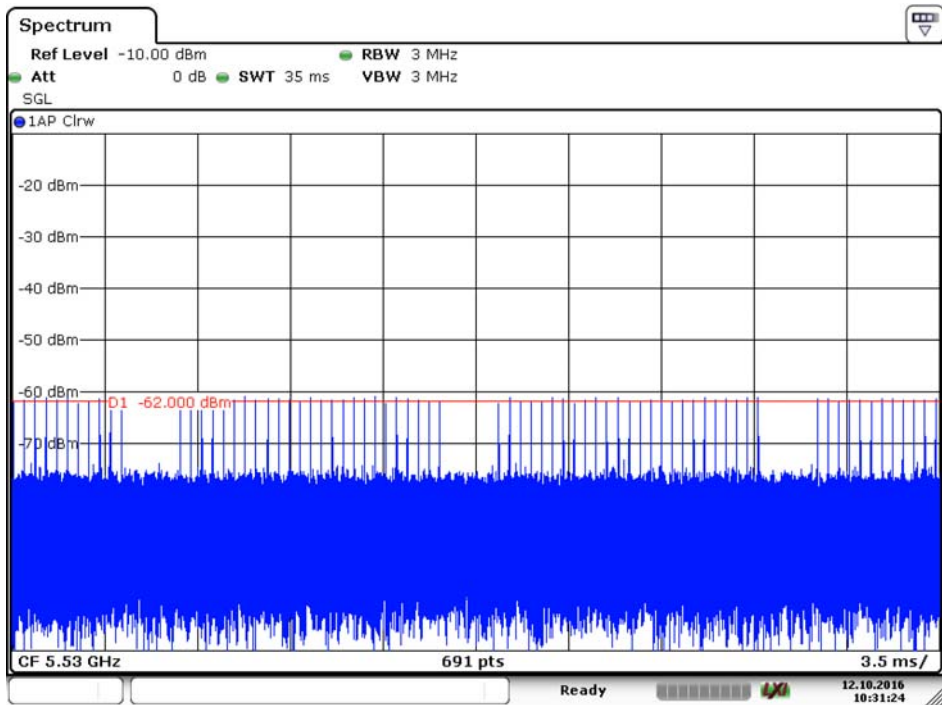

Radar Type 3 – 5530MHz

Radar type 4

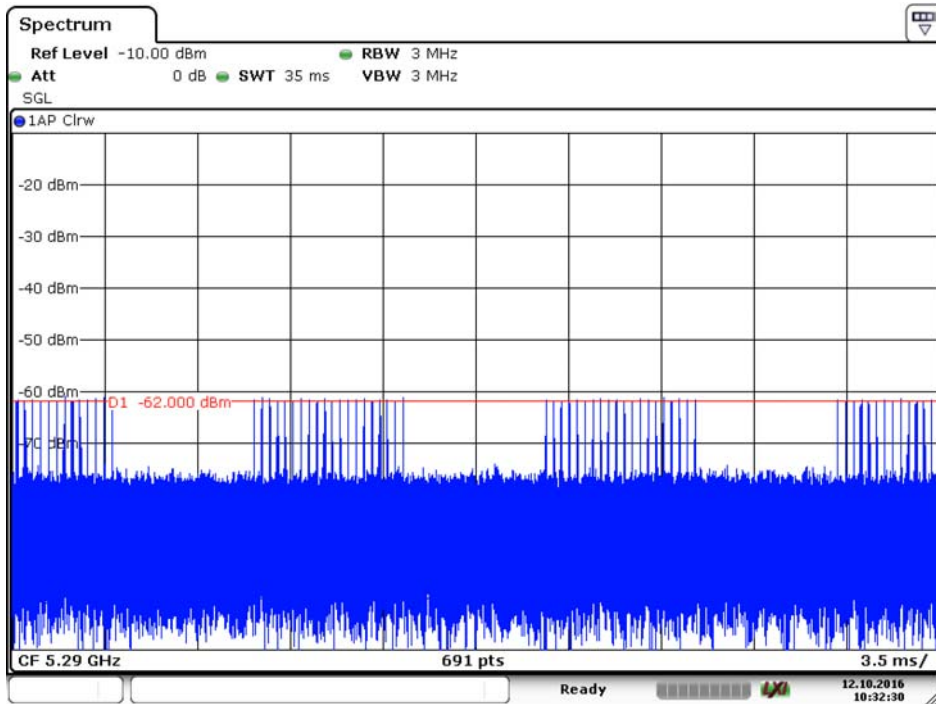

Radar Type 4 – 5290MHz

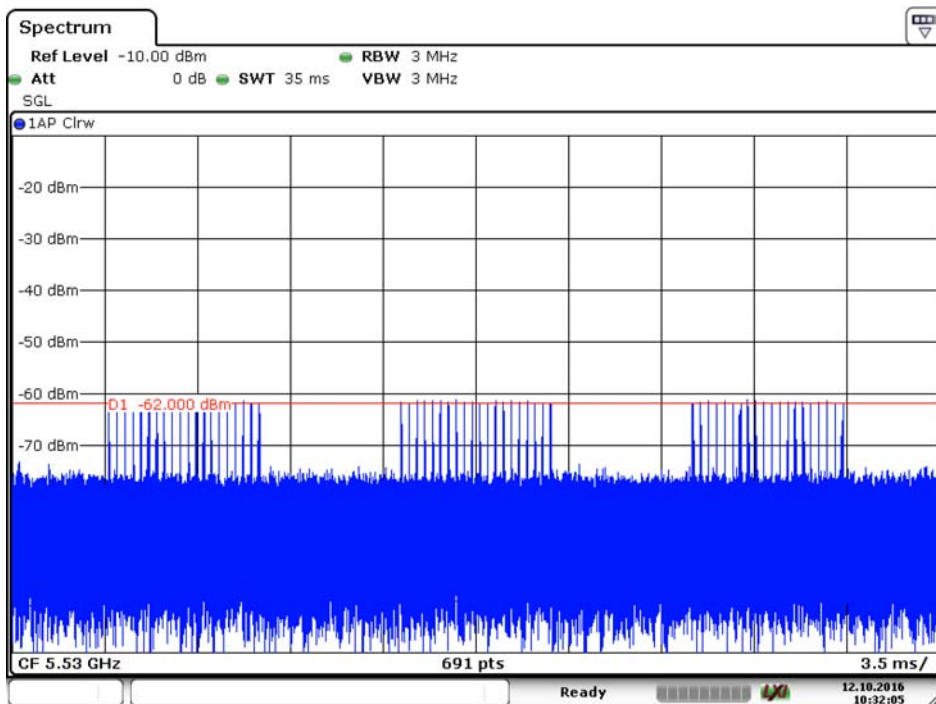

Radar Type 4 – 5530MHz

Radar type 5

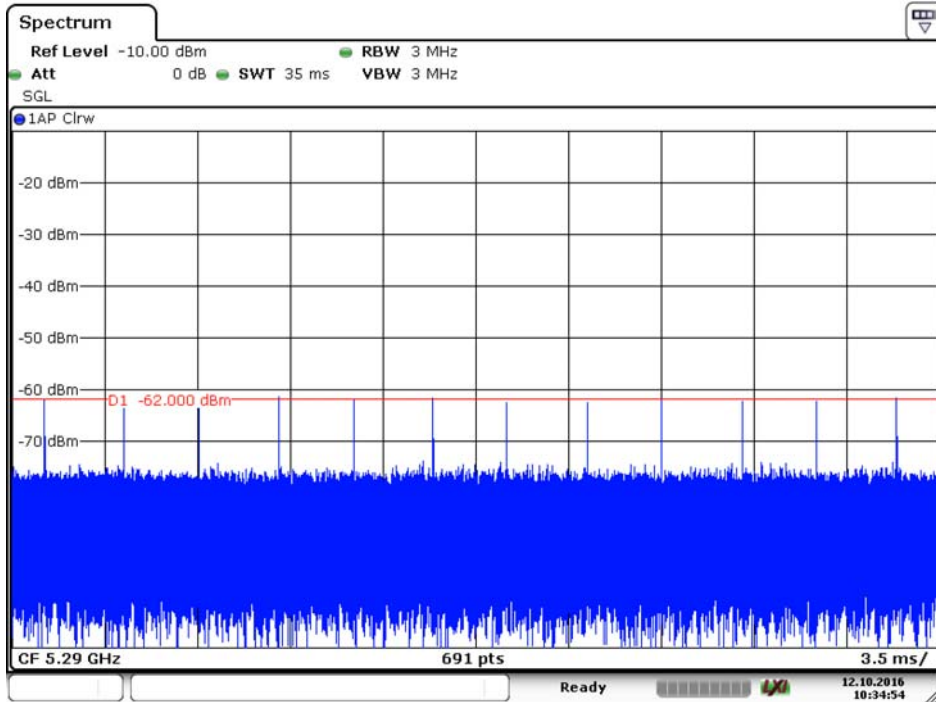

Radar Type 5 – 5290MHz

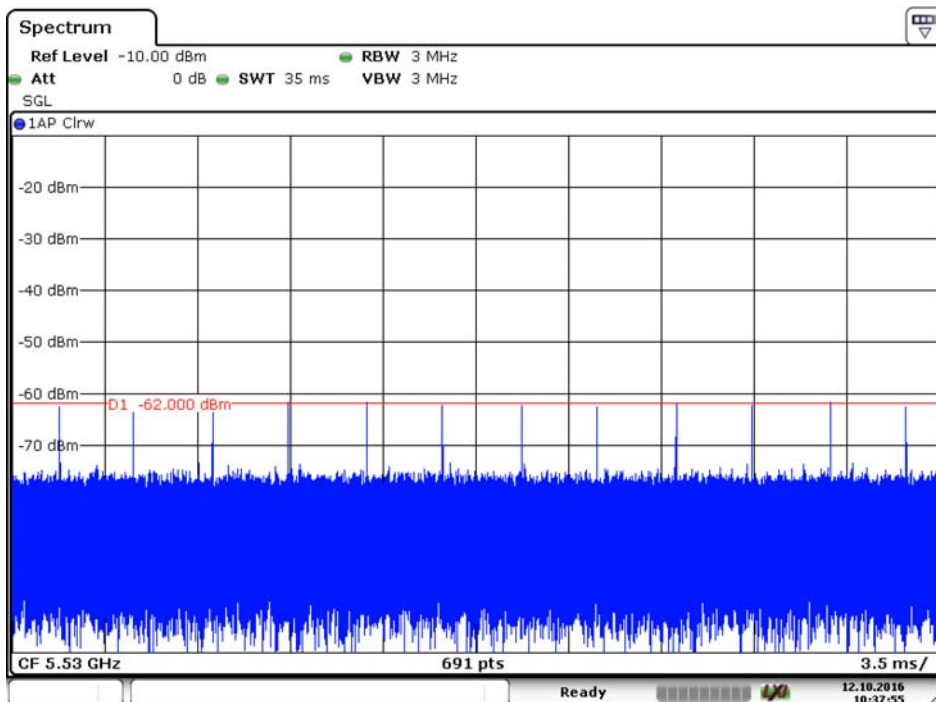

Radar Type 5 – 5530MHz

Radar type 6

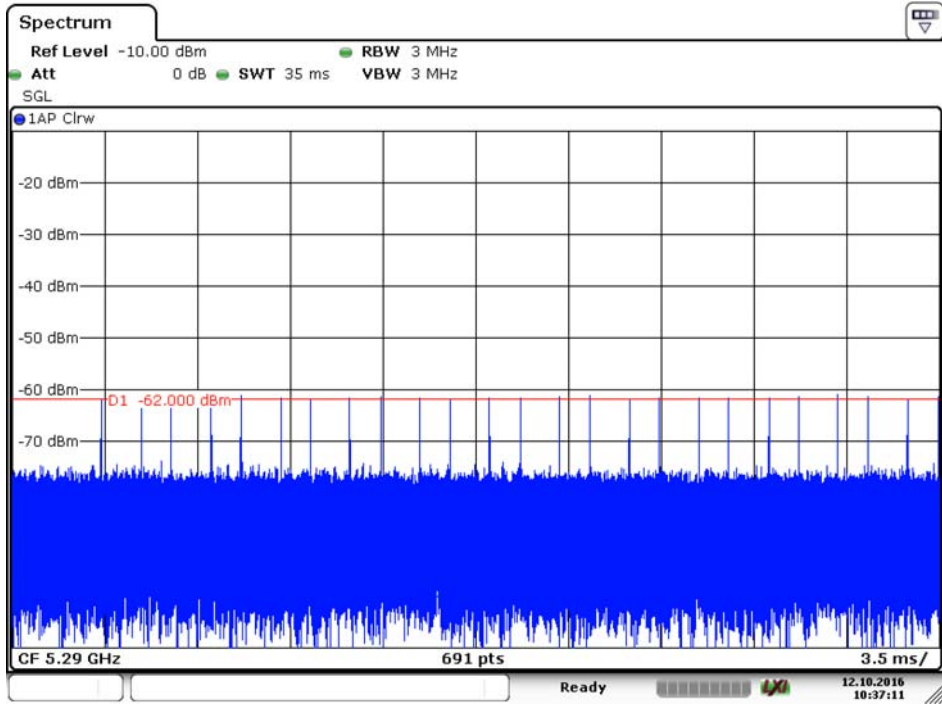

Radar Type 6 – 5290MHz

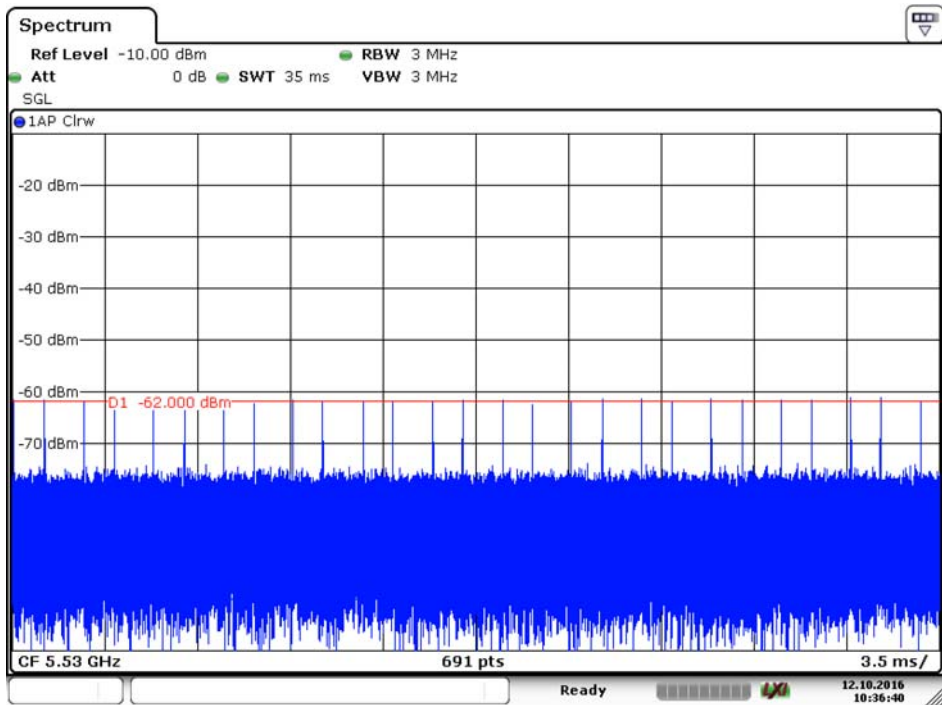

Radar Type 6 – 5530MHz



4. Test Results

Channel closing transmission and channel move time and Non-Occupancy period

Test Item	Operation Channel	Test Result	Limit	Pass / Fail
Channel Move Time	58	0.45275s	<10s	Pass
Channel Closing Transmission Time		208.75ms	<260ms	Pass
Non-Occupancy period		≥ 30	$\geq 30\text{min}$	Pass
Channel Move Time	106	0.49374s	<10s	Pass
Channel Closing Transmission Time		208.75ms	<260ms	Pass
Non-Occupancy period		≥ 30	$\geq 30\text{min}$	Pass

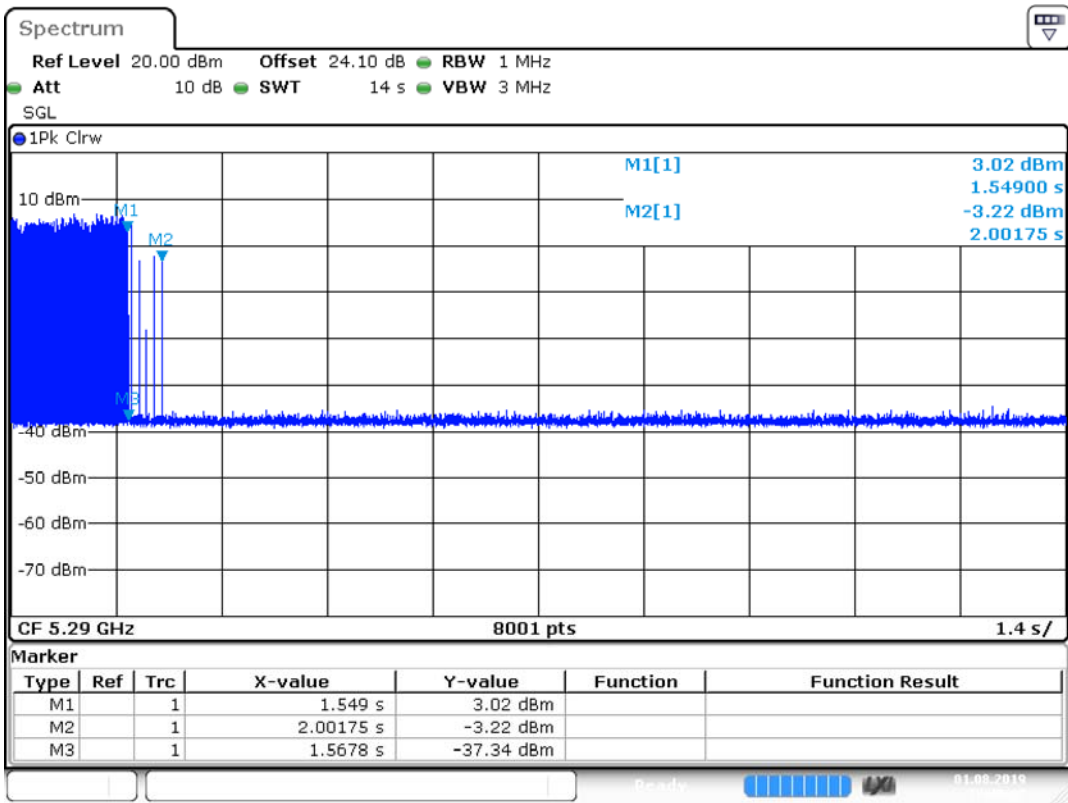

Date: 1.AUG.2019 18:49:27

80MHz / 5290 MHz Closing Transmission Time and Channel Move Time

- Note: 1.The whole time was 14s, the software of this paragraph of time recording points is 8001, each point represents the time is 1.75ms
2. Channel Closing transmission time(200+8.75ms)=200+Number(5)*Dwell(1.75ms)<260ms
 Channel Move time=M2-M1=2.00175-1.54900=0.45275s

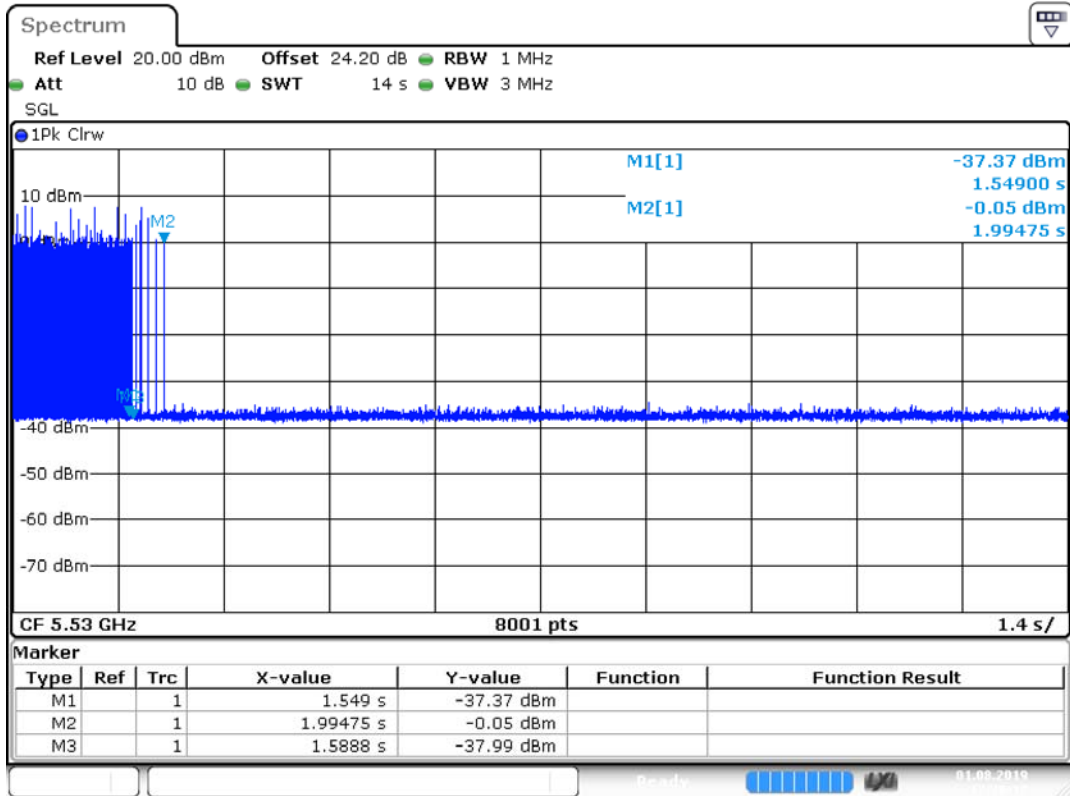

Date: 1.AUG.2019 17:26:12

80MHz / 5530 MHz Channel Move Time and Channel Move Time

- Note: 1. The whole time was 14s, the software of this paragraph of time recording points is 8001, each point represents the time is 1.75ms
2. Channel Closing transmission time $(200+8.75ms)=200+Number(5)*Dwell(1.75ms)<260ms$
 Channel Move time = $M2-M1=1.99475-1.54900=0.44575s$



Non-Occupancy period

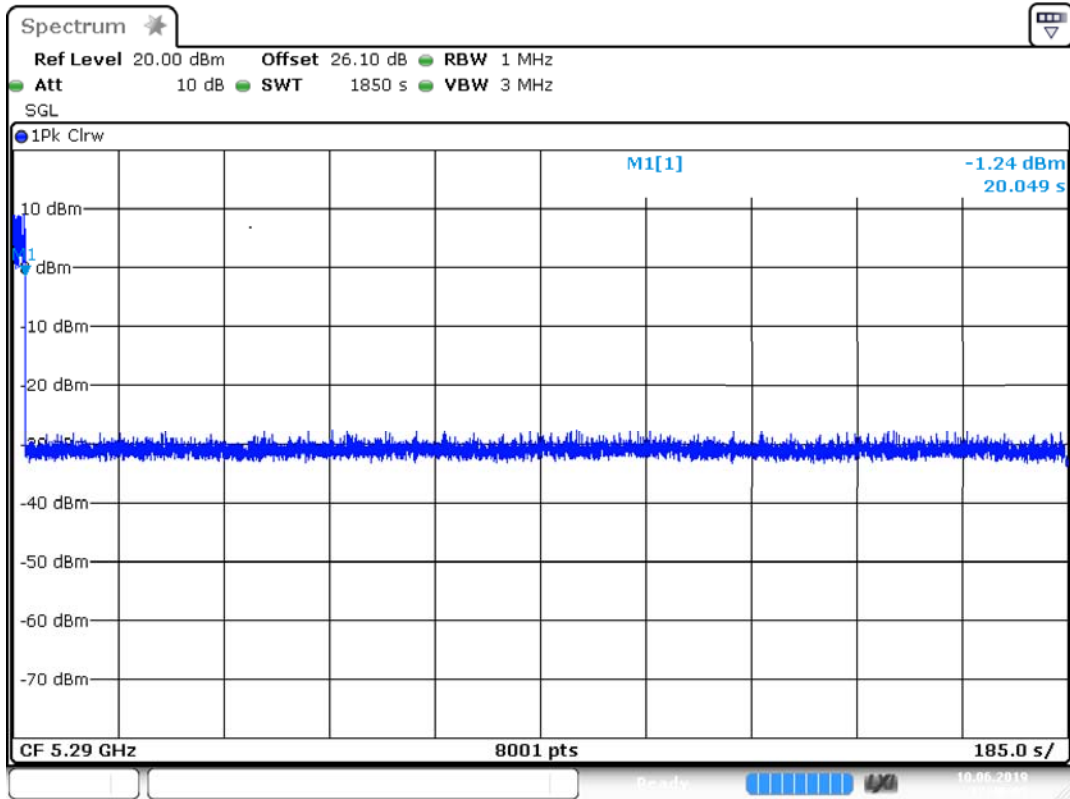

Date: 1.AUG.2019 18:58:53

80MHz / 5290 MHz Non-Occupancy period

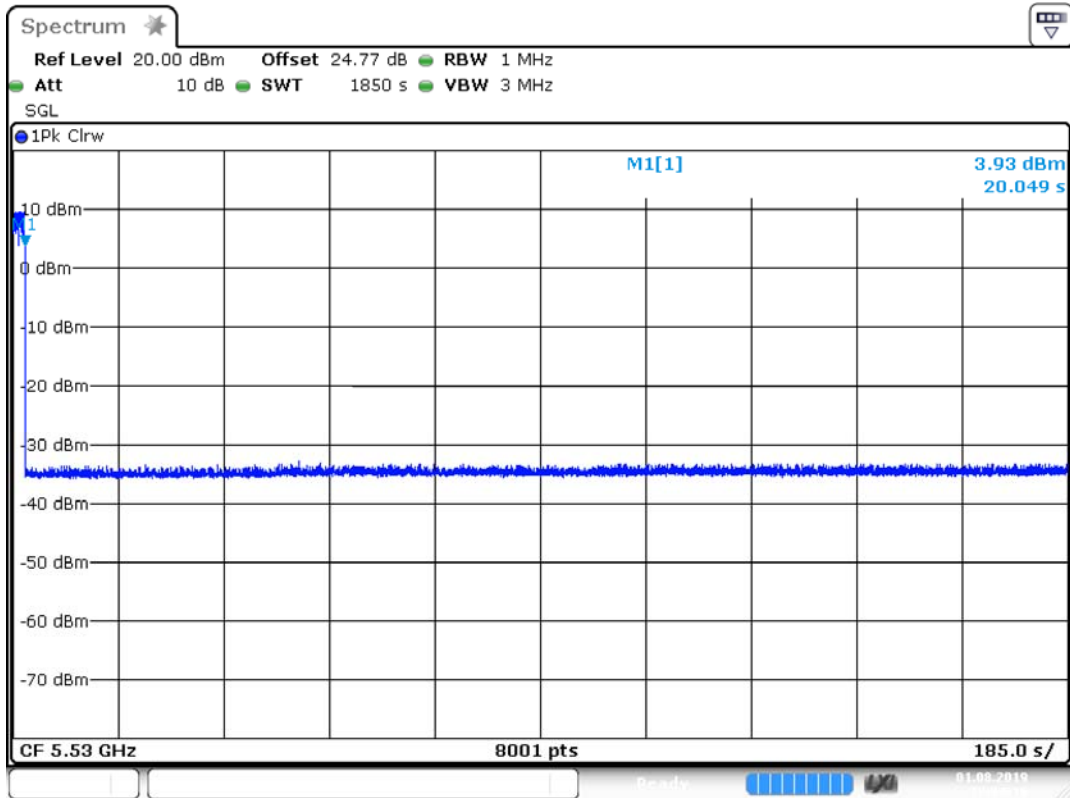

Date: 1.AUG.2019 18:04:16

80MHz / 5530 MHz Non-Occupancy period



5. List of measuring equipment

DFS Test System						
No.	Equipment Name	Serial No.	Model No.	Manufacturer	Cal Date	Due Date
1	Spectrum Analyzer	101008	FSV-40	R&S	2019.05.02	2020.05.01
2	Vector Signal Generator	105328	SMU200A	R&S	2019.05.02	2020.05.01
3	30dB Attenuator	272.4410.50	30	MCE/Weinschel	2019.05.21	2020.05.20
4	20dB Attenuator	04702	779	narda	2019.05.21	2020.05.20
5	6dB Attenuator	BM8173	2	MCE/Weinschel	2019.05.21	2020.05.20

Support Unit used in test configuration and system				
Equipment	Trade Name	Model Name	FCC ID	Serial No.
WLAN AP	D-Link	DIR-826	KA2IR826LMO1	QBQ91C6000056
Notebook	Lenovo	E40	\	TP00005A

** END OF REPORT **