

Conducted Band Edge

LTE Band 4 / 1.4MHz / QPSK



LTE Band 4 / 1.4MHz / 16QAM



Conducted Band Edge

LTE Band 4 / 3MHz / QPSK



LTE Band 4 / 3MHz / 16QAM



Conducted Band Edge

LTE Band 4 / 5MHz / QPSK



LTE Band 4 / 5MHz / 16QAM

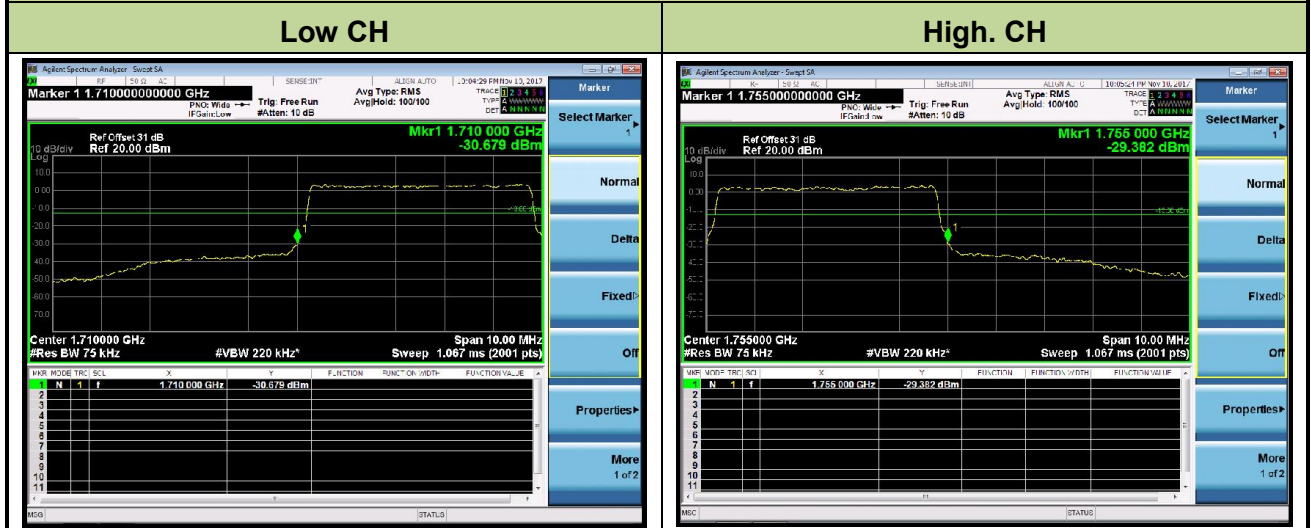

Conducted Band Edge

LTE Band 4 / 10MHz / QPSK



LTE Band 4 / 10MHz / 16QAM

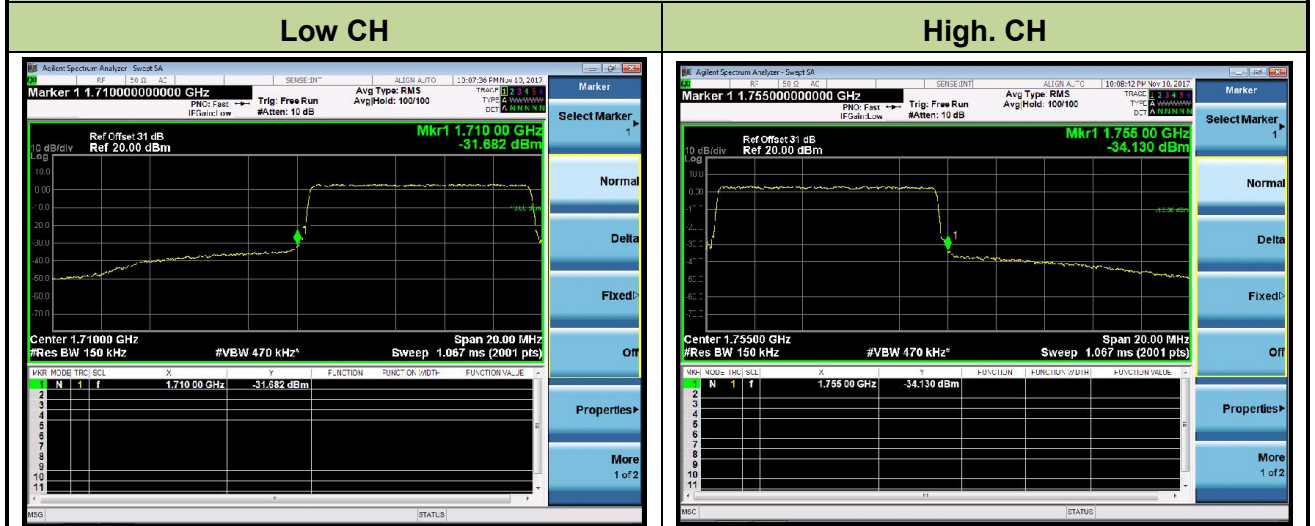

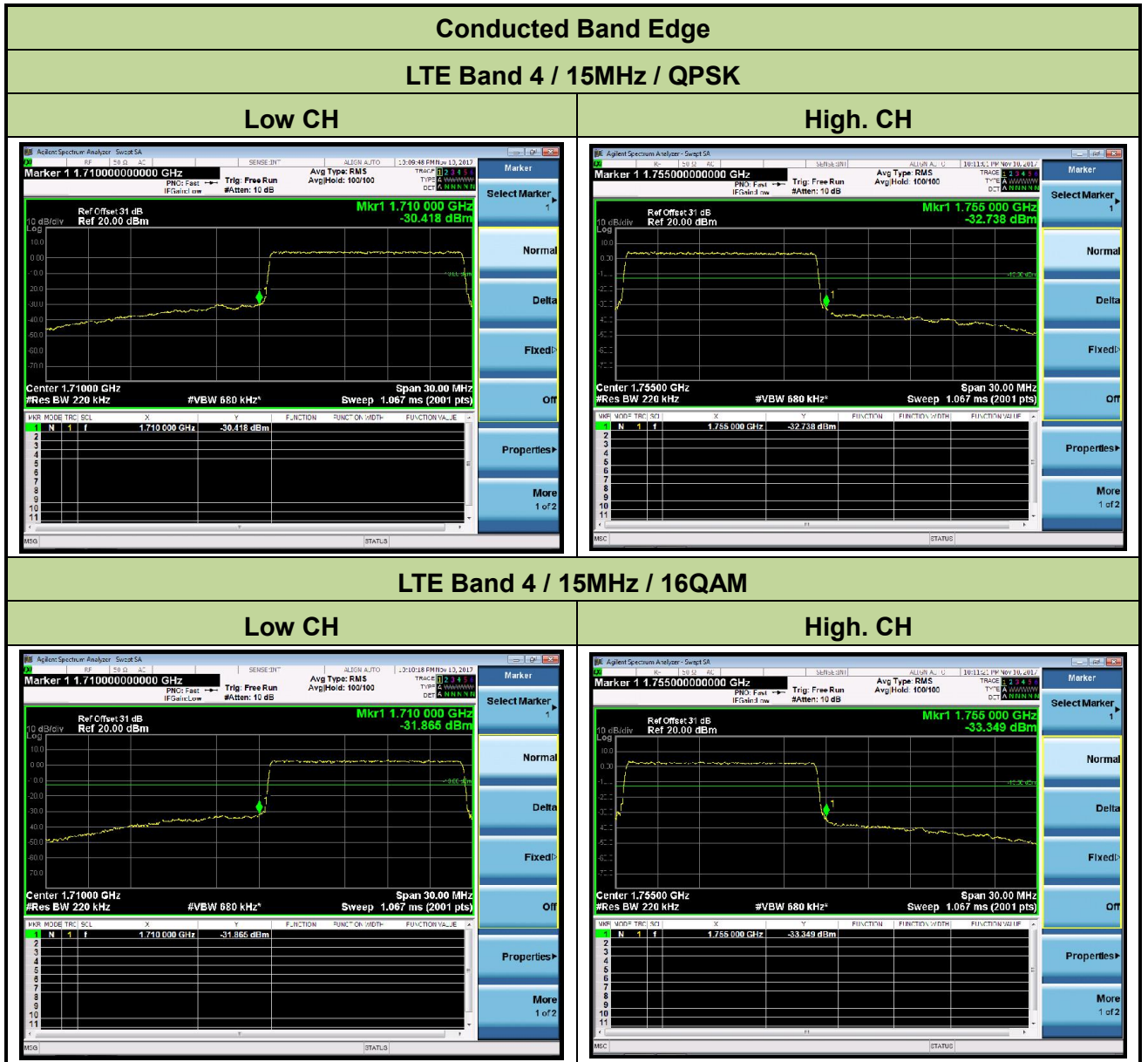

Conducted Band Edge

LTE Band 4 / 20MHz / QPSK



LTE Band 4 / 20MHz / 16QAM



Conducted Band Edge

LTE Band 7 / 5MHz / QPSK

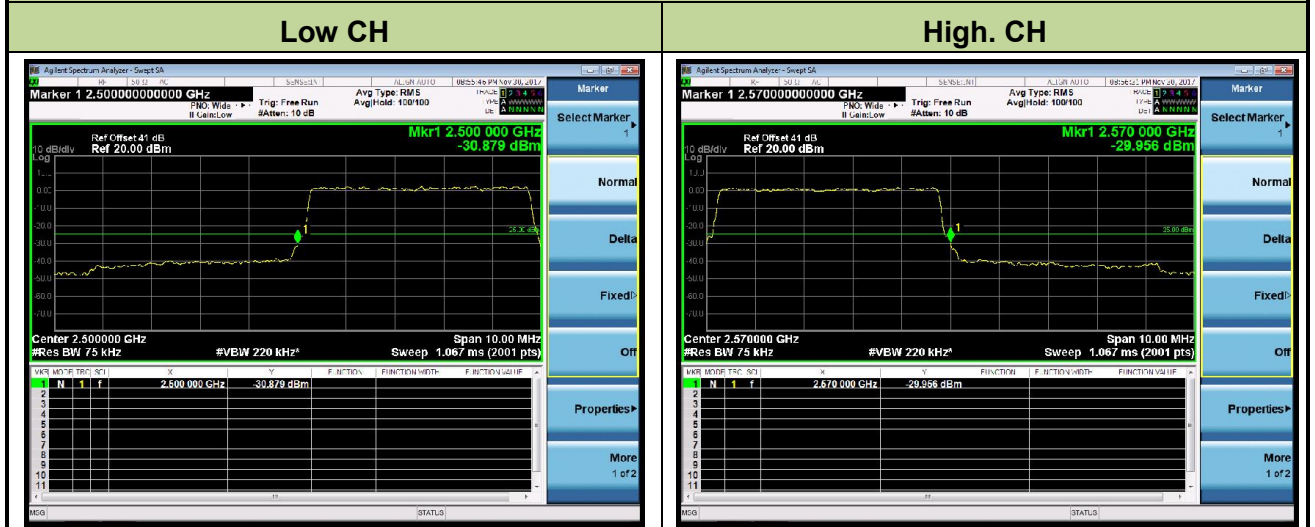

LTE Band 7 / 5MHz / 16QAM



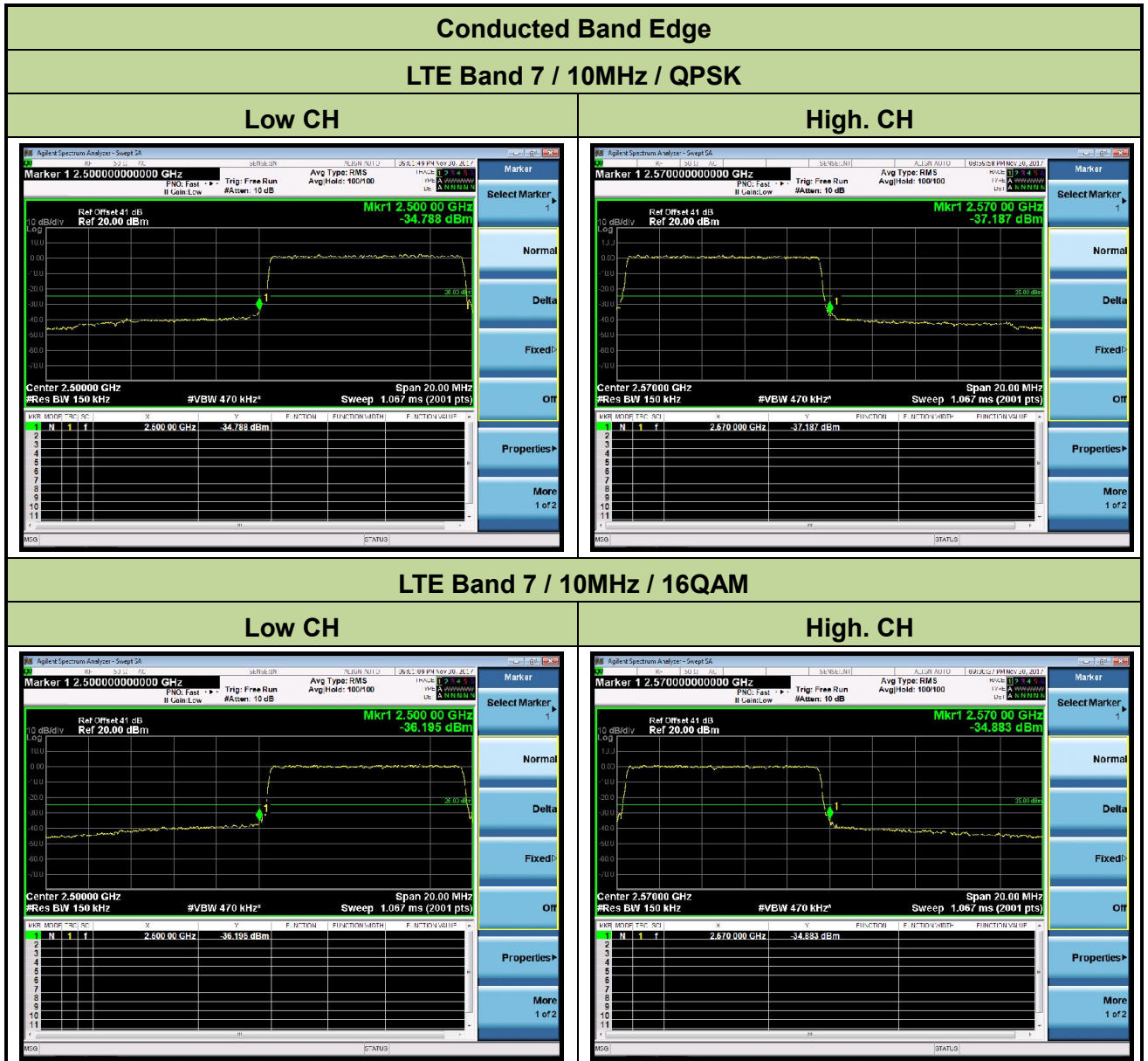

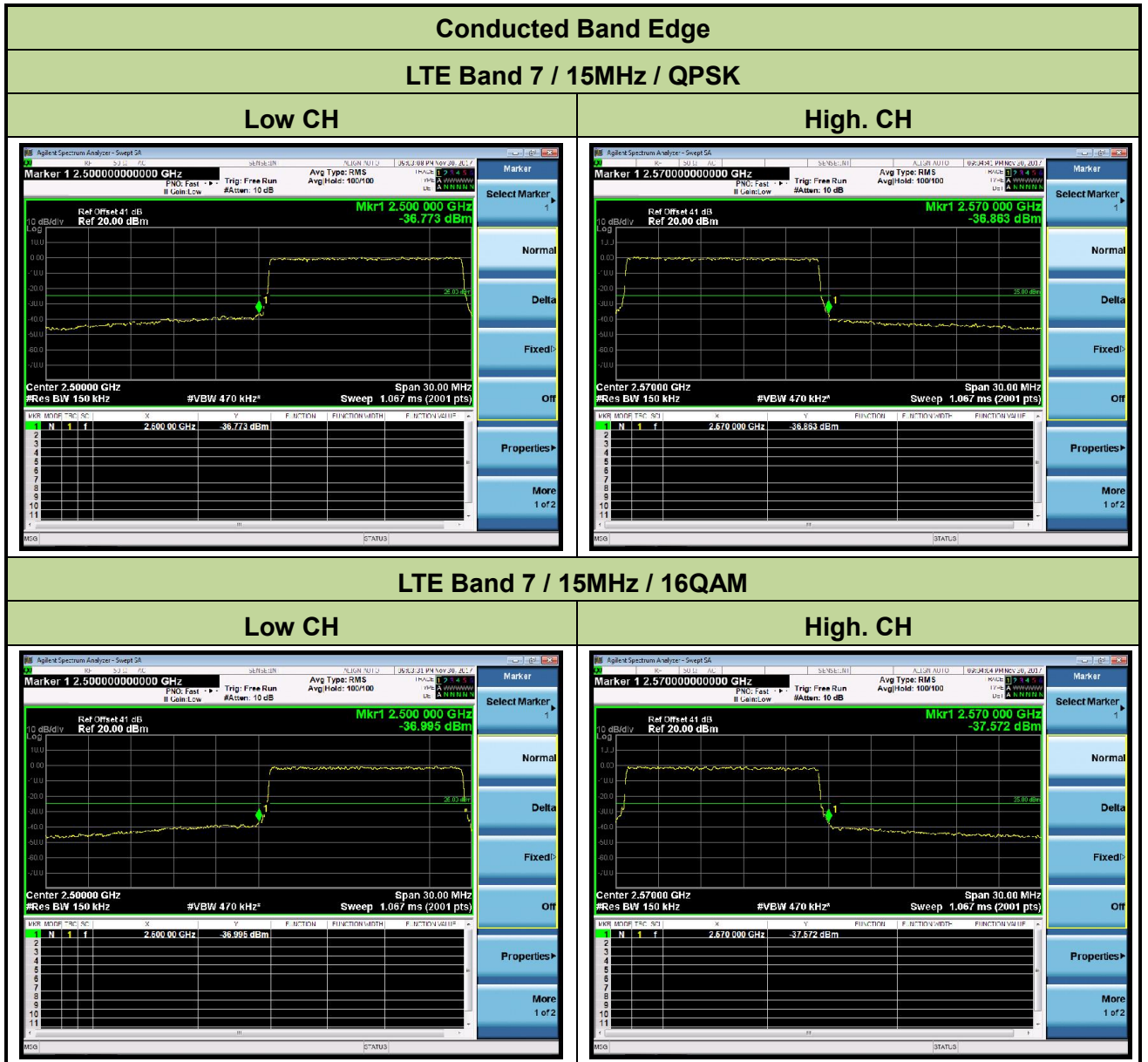

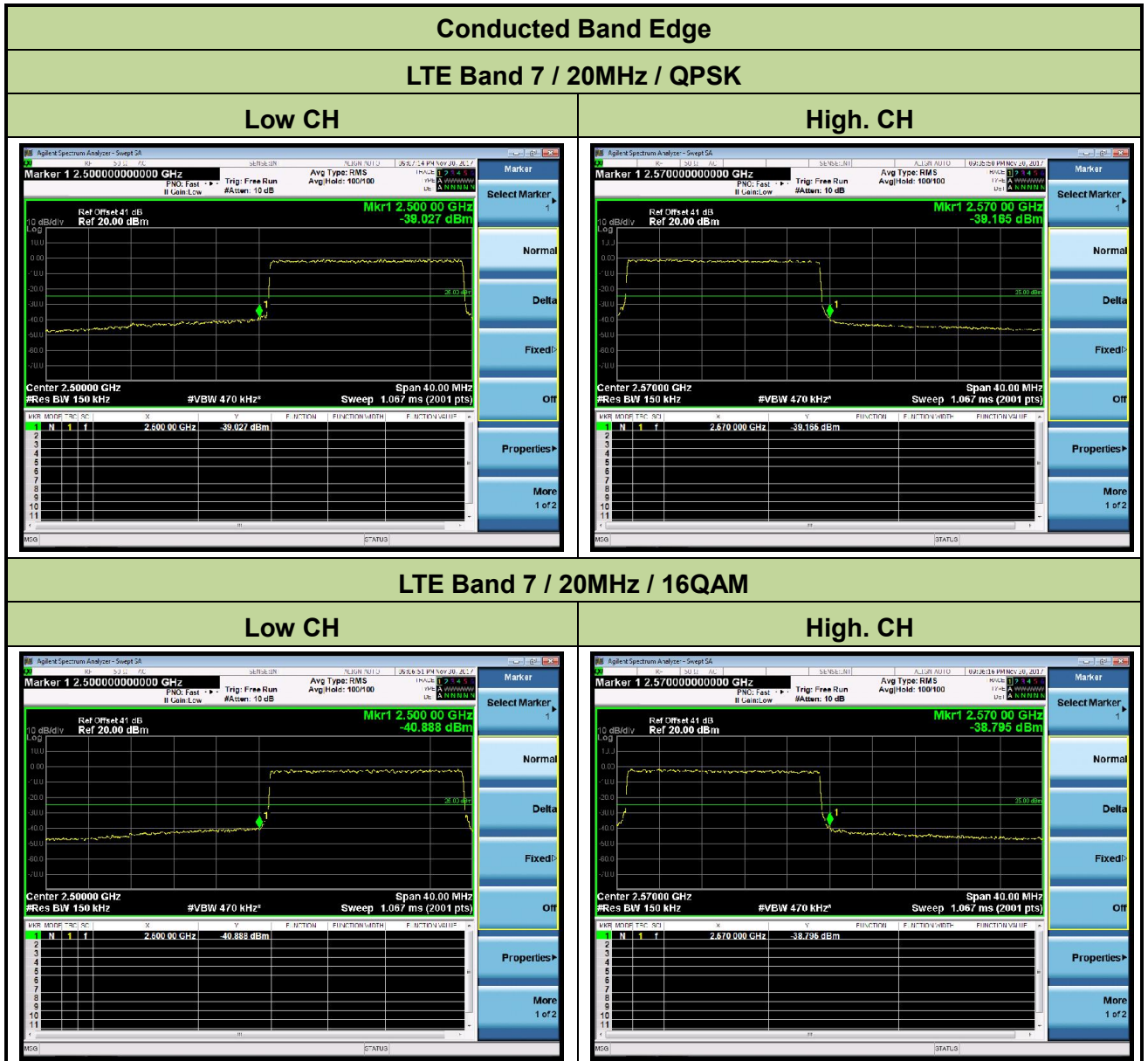

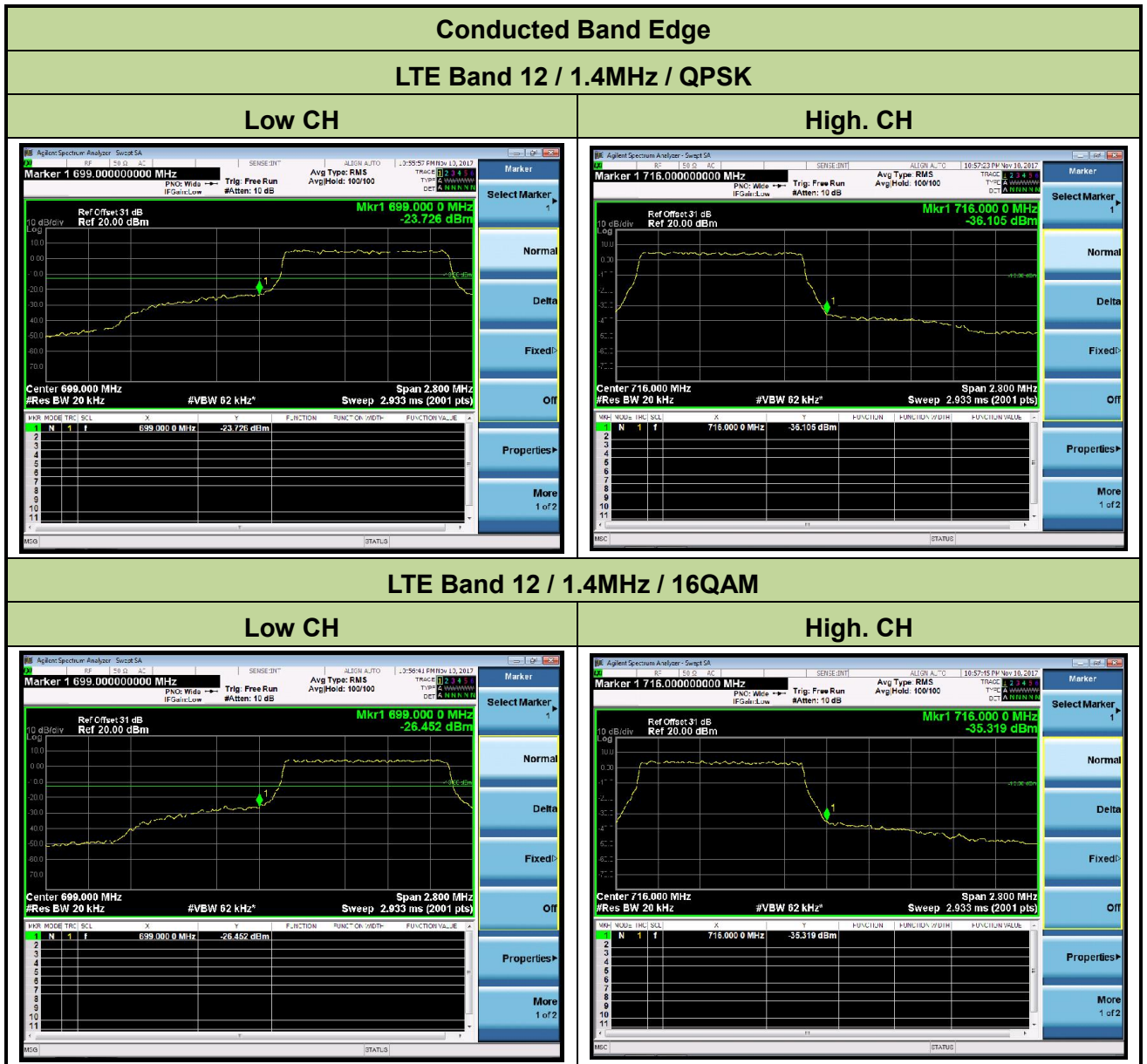

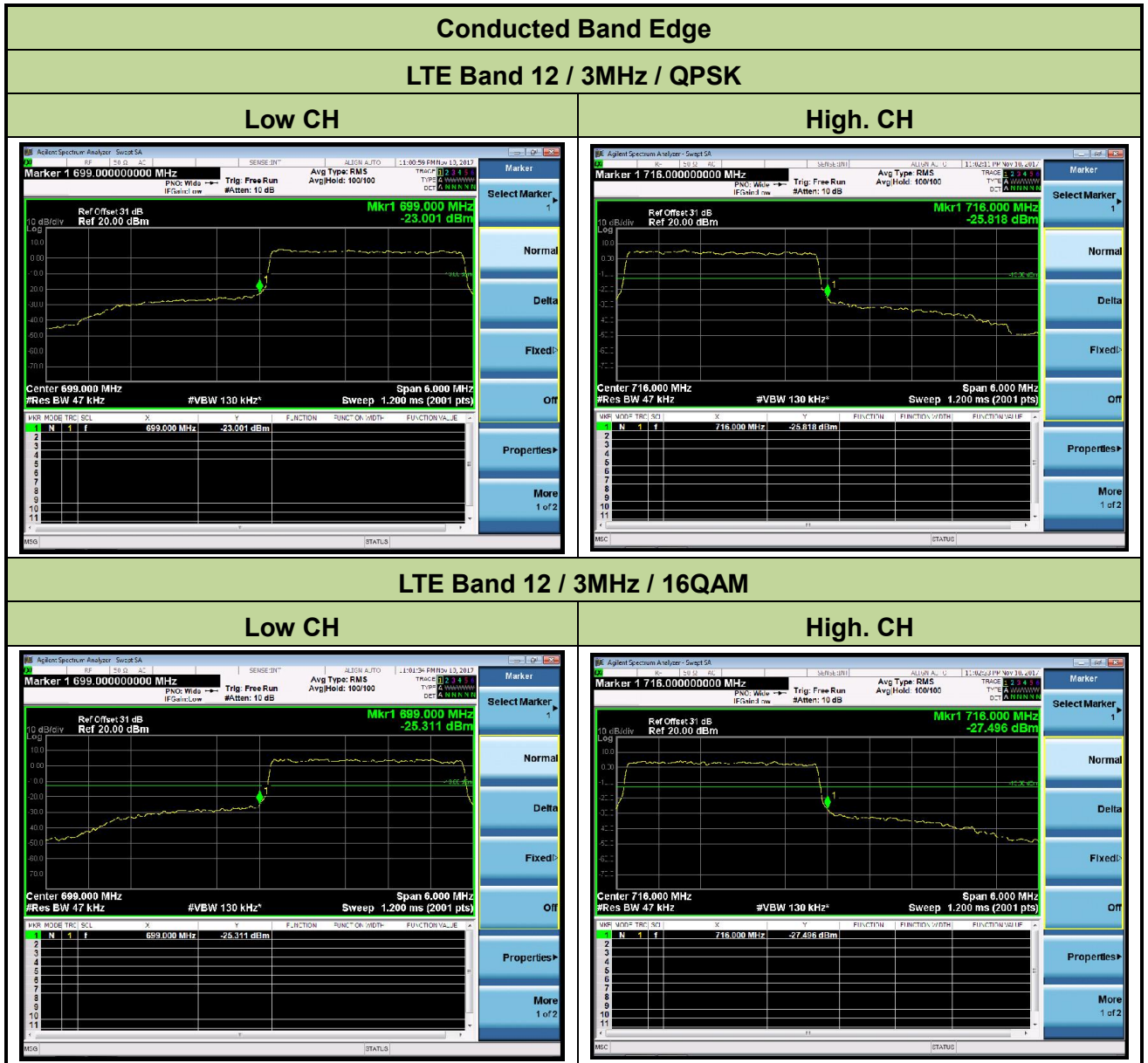

Conducted Band Edge

LTE Band 12 / 5MHz / QPSK

Low CH

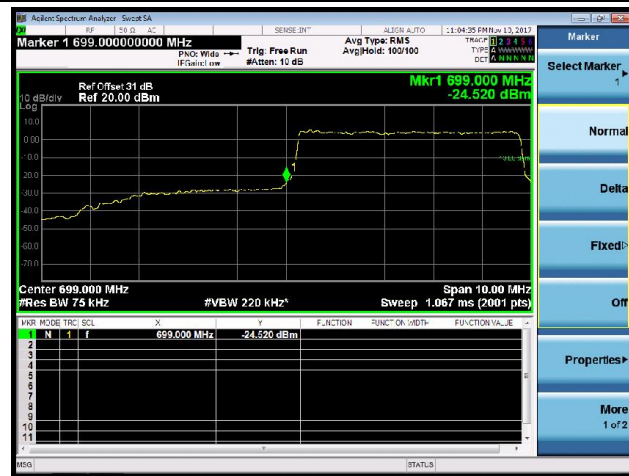

High. CH



LTE Band 12 / 5MHz / 16QAM

Low CH



High. CH



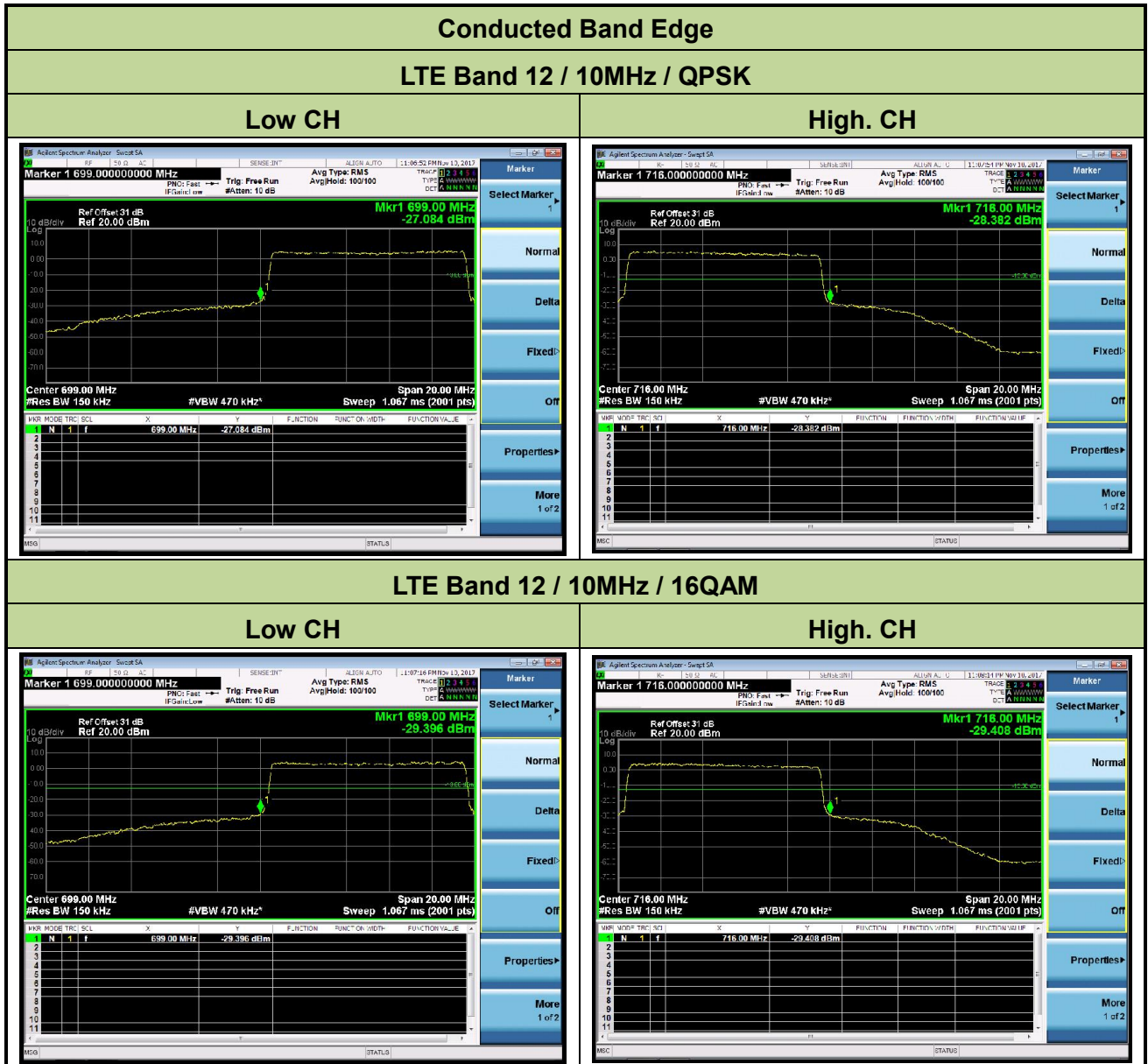

Conducted Band Edge

LTE Band 17 / 5MHz / QPSK

Low CH



High. CH



LTE Band 17 / 5MHz / 16QAM

Low CH

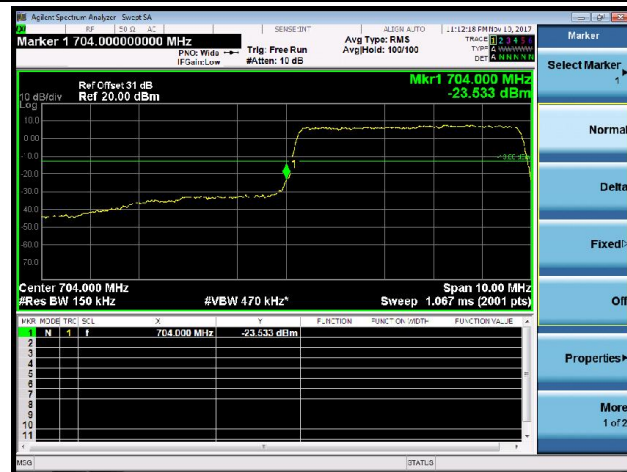

High. CH



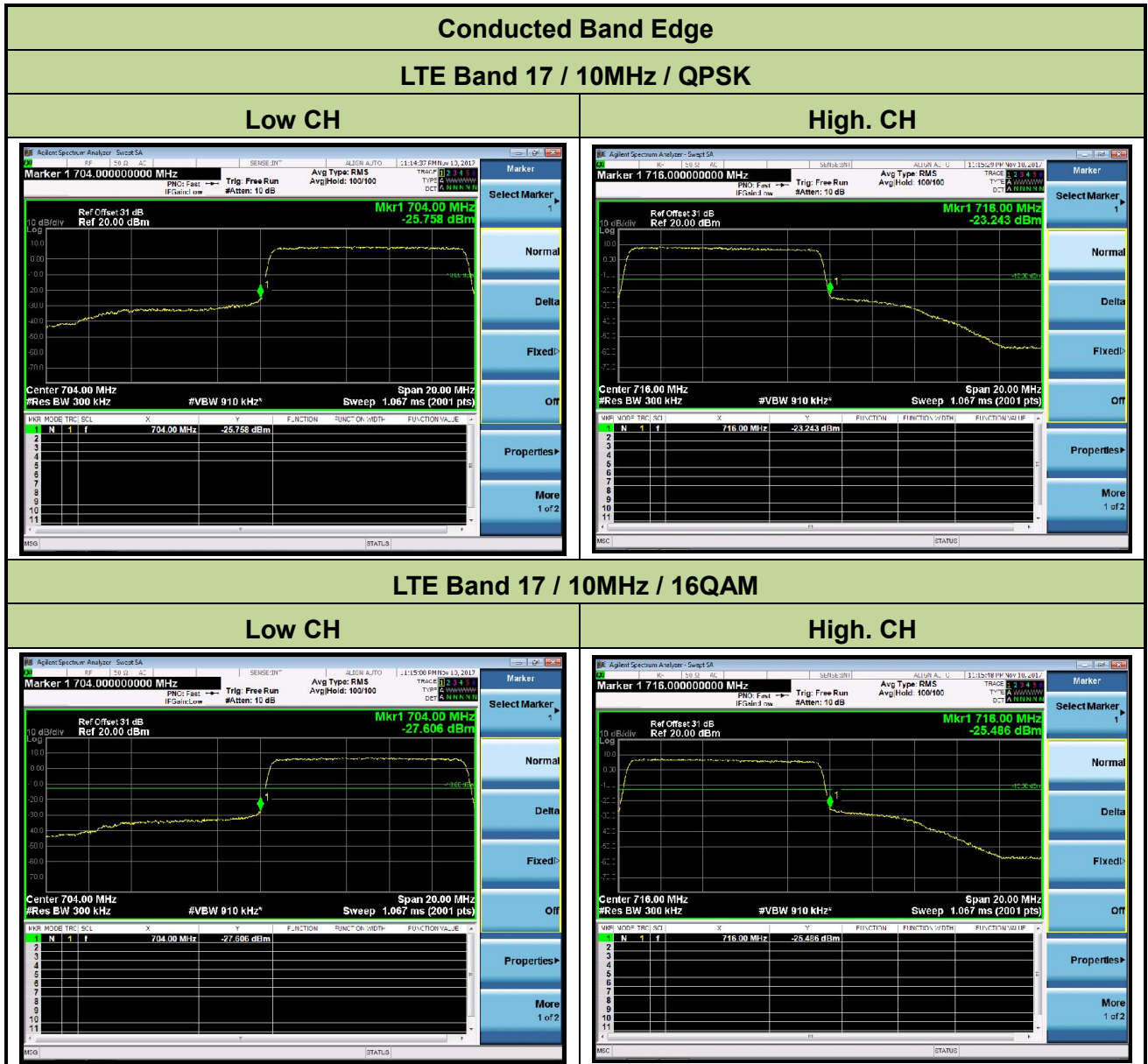

7.4. Spurious and Harmonic Emissions at Antenna Terminal

7.4.1. Test Limit

The power of any emission outside of the authorized operating frequency ranges must be attenuated below the transmitting power (P) by a factor of at least $43 + 10 \cdot \log(P)$ dB.

For LTE Band 7, the power of any emission outside of the authorized operating frequency ranges must be attenuated below the transmitting power (P) by a factor of at least $55 + 10 \cdot \log(P)$ dB.

7.4.2. Test Procedure Used

KDB 971168 D01v03 - Section 6.0 & ANSI/TIA-603-E-2016

7.4.3. Test Setting

In the 1MHz bands immediately outside and adjacent to the frequency block a resolution bandwidth of at least one percent of the emission bandwidth of the fundamental emission of the transmitter may be employed to measure the out of band Emissions.

7.4.4. Test Setup

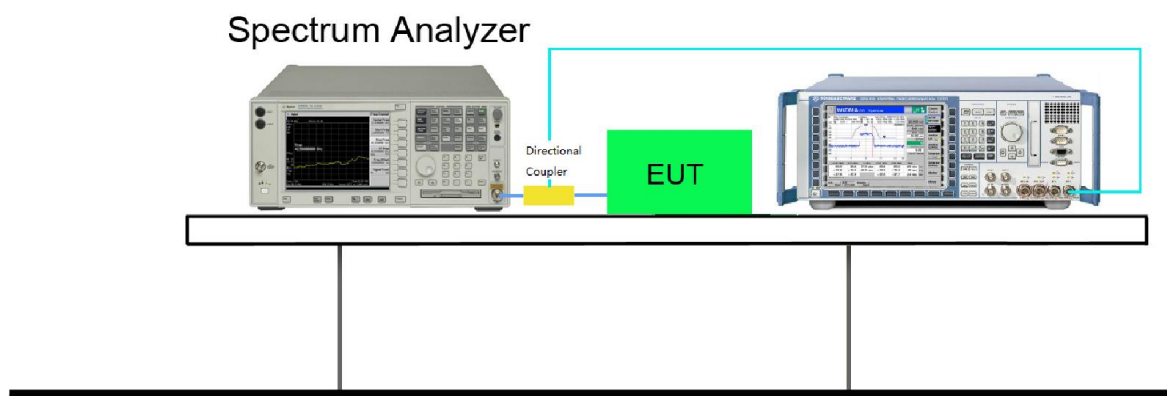

7.4.5. Test Result

Product	Mobile Data Terminal	Temperature	25°C
Test Engineer	Milo Li	Relative Humidity	52%
Test Site	TR3	Test Date	2017/11/07

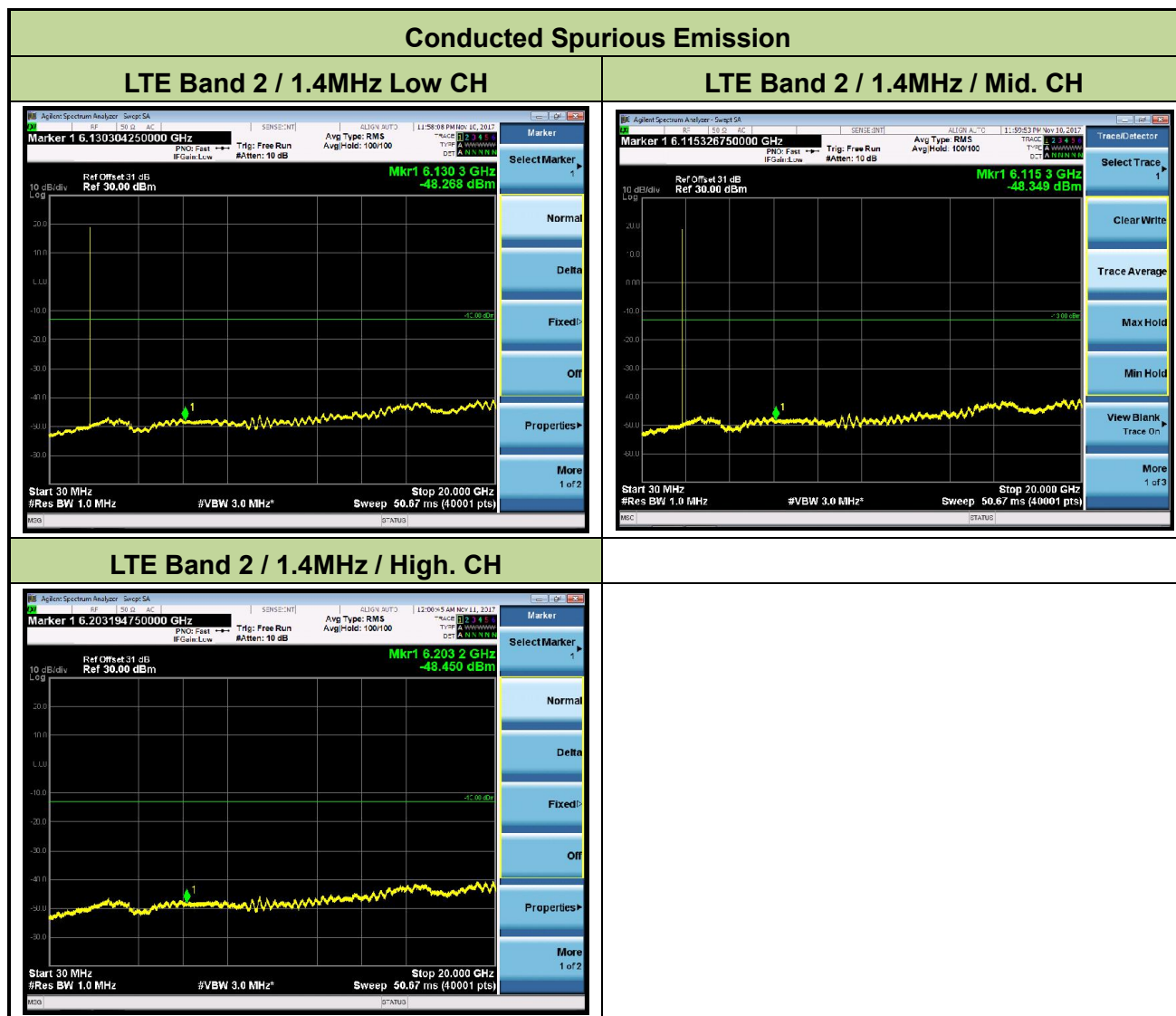

Conducted Spurious Emission

LTE Band 2 / 3MHz Low CH

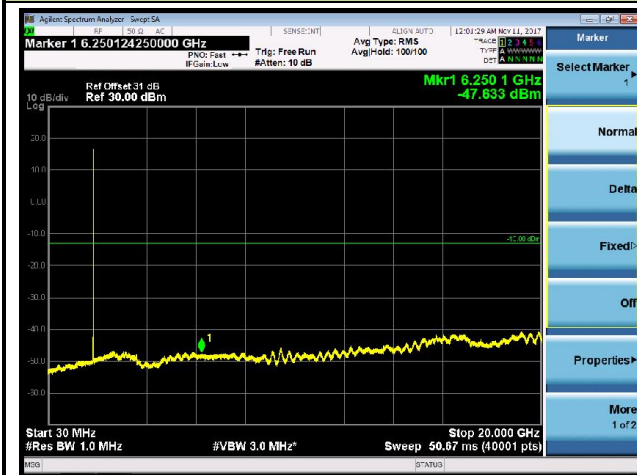

LTE Band 2 / 3MHz / Mid. CH



LTE Band 2 / 3MHz / High. CH



Conducted Spurious Emission

LTE Band 2 / 5MHz Low CH

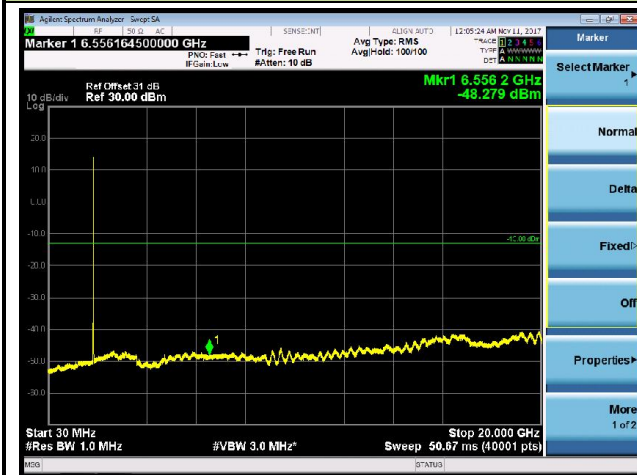

LTE Band 2 / 5MHz / Mid. CH



LTE Band 2 / 5MHz / High. CH



Conducted Spurious Emission

LTE Band 2 / 10MHz Low CH

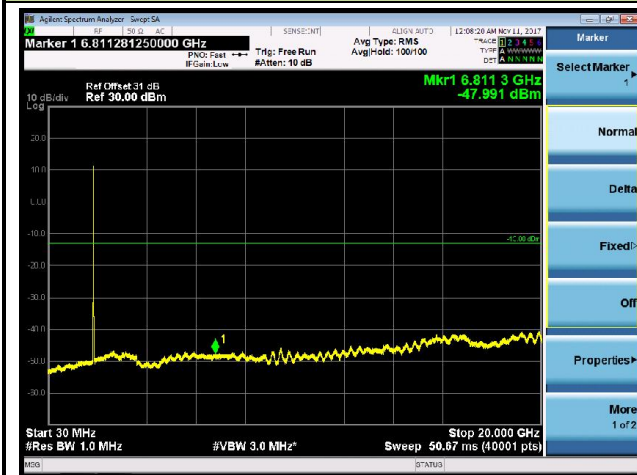

LTE Band 2 / 10MHz / Mid. CH



LTE Band 2 / 10MHz / High. CH



Conducted Spurious Emission

LTE Band 2 / 15MHz Low CH

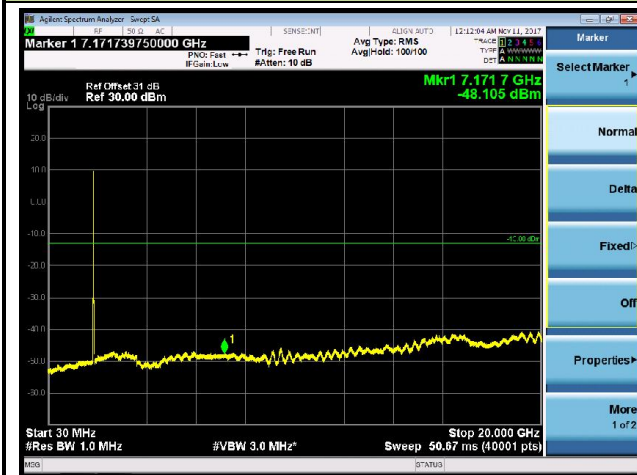

LTE Band 2 / 15MHz / Mid. CH



LTE Band 2 / 15MHz / High. CH

