



DFS MEASUREMENT REPORT

FCC PART 15.407

FCC ID: 2AC6AC71

APPLICANT: Shenzhen Chainway Information Technology Co., Ltd.

Application Type: Certification

Product: Mobile Data Terminal

Model No.: C71

Brand Name: CHAINWAY

FCC Classification: Unlicensed National Information Infrastructure (UNII)

FCC Rule Part(s): Part 15.407(h)(2), KDB 905462 D02v02,
KDB 905462 D03v01r02, KDB 905462 D04v01

Type of Device: Client Device without radar detection

Test Date: November 08 ~ 13, 2017

Reviewed By : Kevin Guo
(Kevin Guo)

Approved By : Marlin Chen
(Marlin Chen)



The test results relate only to the samples tested.

This equipment has been shown to be capable of compliance with the applicable technical standards as indicated in the measurement report and was tested in accordance with the measurement procedures specified in KDB 905462 D02v02. Test results reported herein relate only to the item(s) tested.

The test report shall not be reproduced except in full without the written approval of MRT Technology (Suzhou) Co., Ltd.

Revision History

Report No.	Version	Description	Issue Date	Note
1710RSU02704	Rev. 01	Initial report	12-07-2017	Valid

CONTENTS

Description	Page
Revision History	2
§2.1033 General Information	4
1. INTRODUCTION	5
1.1. Scope	5
1.2. MRT Test Location	5
2. PRODUCT INFORMATION	6
2.1. Equipment Description.....	6
2.2. Operating Frequency and Channel List.....	7
2.3. Test Mode	7
3. DFS DETECTION THRESHOLDS AND RADAR TEST WAVEFORMS	8
3.1. Applicability	8
3.2. DFS Devices Requirements.....	9
3.3. DFS Detection Threshold Values	10
3.4. Parameters of DFS Test Signals	11
3.5. Conducted Test Setup	14
4. TEST EQUIPMENT CALIBRATION DATE	15
5. TEST RESULT	16
5.1. Summary	16
5.2. Radar Waveform Calibration.....	17
5.2.1. Calibration Setup	17
5.2.2. Calibration Procedure	17
5.2.3. Calibration Result	18
5.3. Channel Loading Test Result	22
5.4. In-Service Monitoring for Channel Move Time, Channel Closing Transmission Time and Non-Occupancy Period Measurement.....	23
5.4.1. Test Limit	23
5.4.2. Test Procedure Used	23
5.4.3. Test Result.....	24
6. CONCLUSION	26

§2.1033 General Information

Applicant:	Shenzhen Chainway Information Technology Co., Ltd.		
Applicant Address:	9/F, Building 2, Daqian Industrial Park, Longchang Rd., District 67, Bao'an, Shenzhen, China		
Manufacturer:	Shenzhen Chainway Information Technology Co., Ltd.		
Manufacturer Address:	9/F, Building 2, Daqian Industrial Park, Longchang Rd., District 67, Bao'an, Shenzhen, China		
Test Site:	MRT Technology (Suzhou) Co., Ltd		
Test Site Address:	D8 Building, Youxin Industrial Park, No.2 Tian'edang Rd., Wuzhong Economic Development Zone, Suzhou, China		
MRT Registration No.:	893164		
MRT designation No.:	CN1166		
Test Device Serial No.:	N/A	<input type="checkbox"/> Production	<input checked="" type="checkbox"/> Pre-Production <input type="checkbox"/> Engineering

Test Facility / Accreditations

Measurements were performed at MRT Laboratory located in Tian'edang Rd., Suzhou, China.

- MRT facility is a FCC registered (MRT Reg. No. 893164) test facility with the site description report on file and has met all the requirements specified in Section 2.948 of the FCC Rules.
- MRT facility is an IC registered (MRT Reg. No. 11384A-1) test laboratory with the site description on file at Industry Canada.
- MRT facility is a VCCI registered (R-20025, G-20034, C-20020, T-20020) test laboratory with the site description on file at VCCI Council.
- MRT Lab is accredited to ISO 17025 by the American Association for Laboratory Accreditation (A2LA) under the American Association for Laboratory Accreditation Program (A2LA Cert. No. 3628.01) in EMC, Telecommunications and Radio testing for FCC, Industry Canada, EU and TELEC Rules.



1. INTRODUCTION

1.1. Scope

Measurement and determination of electromagnetic emissions (EMC) of radio frequency devices including intentional and/or unintentional radiators for compliance with the technical rules and regulations of the Federal Communications Commission and the Industry Canada Certification and Engineering Bureau.

1.2. MRT Test Location

The map below shows the location of the MRT LABORATORY, its proximity to the Taihu Lake. These measurement tests were conducted at the MRT Technology (Suzhou) Co., Ltd. Facility located at D8 Building, No.2 Tian'edang Rd., Wuzhong Economic Development Zone, Suzhou, China. The detailed description of the measurement facility was found to be in compliance with the requirements of § 2.948 according to ANSI C63.4-2009 on September 30, 2013.



2. PRODUCT INFORMATION

2.1. Equipment Description

Product Name	Mobile Data Terminal
Model No.	C71
Radio Type	Intentional Transceiver
Operation Mode	Client device without radar detection
Frequency Range	For 802.11a/n-HT20: 5260~5320MHz For 802.11n-HT40: 5270~5310MHz
Maximum Average Output Power	802.11a: 15.71dBm 802.11n-HT20: 15.83dBm 802.11n-HT40: 15.98dBm
Type of Modulation	802.11a/n: OFDM
Uniform Spreading	For the 5250-5350MHz, 5470-5725 MHz bands, the Master device provides, on aggregate, uniform loading of the spectrum across all devices by selecting an operating channel among the available channels using a random algorithm.

2.2. Operating Frequency and Channel List

802.11a/n-HT20

Channel	Frequency	Channel	Frequency	Channel	Frequency
52	5260 MHz	56	5280 MHz	60	5300 MHz
64	5320 MHz	--	--	--	--

802.11n-HT40

Channel	Frequency	Channel	Frequency	Channel	Frequency
54	5270 MHz	62	5310 MHz	--	--

2.3. Test Mode

Test Mode	Mode 1: Communication
-----------	-----------------------

3. DFS DETECTION THRESHOLDS AND RADAR TEST WAVEFORMS

3.1. Applicability

The following table from FCC KDB 905462 D02 UNII DFS Compliance Procedures New Rules v02 lists the applicable requirements for the DFS testing.

Requirement	Operational Mode		
	Master	Client Without Radar Detection	Client With Radar Detection
Non-Occupancy Period	Yes	Not required	Yes
DFS Detection Threshold	Yes	Not required	Yes
Channel Availability Check Time	Yes	Not required	Not required
U-NII Detection Bandwidth	Yes	Not required	Yes

Table 3-1: Applicability of DFS Requirements Prior to Use of a Channel

Requirement	Operational Mode	
	Master Device or Client With Radar Detection	Client Without Radar Detection
DFS Detection Threshold	Yes	Not required
Channel Closing Transmission Time	Yes	Yes
Channel Move Time	Yes	Yes
U-NII Detection Bandwidth	Yes	Not required

Additional requirements for devices with multiple bandwidth modes	Master Device or Client with Radar Detection	Client Without Radar Detection
U-NII Detection Bandwidth and Statistical Performance Check	All BW modes must be tested	Not required
Channel Move Time and Channel Closing Transmission Time	Test using widest BW mode available	Test using the widest BW mode available for the link
All other tests	Any single BW mode	Not required

Note: Frequencies selected for statistical performance check should include several frequencies within the radar detection bandwidth and frequencies near the edge of the radar detection bandwidth. For 802.11 devices it is suggested to select frequencies in each of the bonded 20 MHz channels and the channel center frequency.

Table 3-2: Applicability of DFS Requirements during normal operation

3.2. DFS Devices Requirements

Per FCC KDB 905462 D02 UNII DFS Compliance Procedures New Rules v02 the following are the requirements for Client Devices:

- a) A Client Device will not transmit before having received appropriate control signals from a Master Device.
- b) A Client Device will stop all its transmissions whenever instructed by a Master Device to which it is associated and will meet the Channel Move Time and Channel Closing transmission time requirements. The Client Device will not resume any transmissions until it has again received control signals from a Master Device.
- c) If a Client Device is performing In-Service Monitoring and detects a Radar Waveform above the DFS Detection Threshold, it will inform the Master Device. This is equivalent to the Master Device detecting the Radar Waveform.
- d) Irrespective of Client Device or Master Device detection the Channel Move Time and Channel Closing Transmission Time requirements remain the same.
- e) The client test frequency must be monitored to ensure no transmission of any type has occurred for 30 minutes. Note: If the client moves with the master, the device is considered compliant if nothing appears in the client non-occupancy period test. For devices that shut down (rather than moving channels), no beacons should appear.

Channel Move Time and Channel Closing Transmission Time requirements are listed in the following table.

Parameter	Value
Non-occupancy period	Minimum 30 minutes
Channel Availability Check Time	60 seconds
Channel Move Time	10 seconds See Note 1.
Channel Closing Transmission Time	200 milliseconds + an aggregate of 60 milliseconds over remaining 10 second period. See Notes 1 and 2.
U-NII Detection Bandwidth	Minimum 100% of the U-NII 99% transmission power bandwidth. See Note 3.

Note 1: Channel Move Time and the Channel Closing Transmission Time should be performed with Radar Type 0. The measurement timing begins at the end of the Radar Type 0 burst.

Note 2: The Channel Closing Transmission Time is comprised of 200 milliseconds starting at the beginning of the Channel Move Time plus any additional intermittent control signals required to facilitate a Channel move (an aggregate of 60 milliseconds) during the remainder of the 10 second period. The aggregate duration of control signals will not count quiet periods in between

transmissions.

Note 3: During the U-NII Detection Bandwidth detection test, radar type 0 should be used. For each frequency step the minimum percentage of detection is 90 percent. Measurements are performed with no data traffic.

Table 3-3: DFS Response Requirements

3.3. DFS Detection Threshold Values

The DFS detection thresholds are defined for Master devices and Client Devices with In-service monitoring. These detection thresholds are listed in the following table.

Maximum Transmit Power	Value (See Notes 1, 2, and 3)
EIRP ≥ 200 milliwatt	-64 dBm
EIRP < 200 milliwatt and power spectral density < 10 dBm/MHz	-62 dBm
EIRP < 200 milliwatt that do not meet the power spectral density requirement	-64 dBm

Note 1: This is the level at the input of the receiver assuming a 0 dBi receive antenna.

Note 2: Throughout these test procedures an additional 1 dB has been added to the amplitude of the test transmission waveforms to account for variations in measurement equipment. This will ensure that the test signal is at or above the detection threshold level to trigger a DFS response.

Note3: EIRP is based on the highest antenna gain. For MIMO devices refer to KDB Publication 662911 D01.

Table 3-4: Detection Thresholds for Master Devices and Client Devices with Radar Detection

3.4. Parameters of DFS Test Signals

This section provides the parameters for required test waveforms, minimum percentage of successful detections, and the minimum number of trials that must be used for determining DFS conformance. Step intervals of 0.1 microsecond for Pulse Width, 1 microsecond for PRI, 1 MHz for chirp width and 1 for the number of pulses will be utilized for the random determination of specific test waveforms.

Short Pulse Radar Test Waveforms

Radar Type	Pulse Width (μsec)	PRI (μsec)	Number of Pulses	Minimum Percentage of Successful Detection	Minimum Number of Trials
0	1	1428	18	See Note 1	See Note 1
1	1	Test A: 15 unique PRI values randomly selected from the list of 23 PRI values in Table 3-6	$\text{Roundup} \left\{ \left(\frac{1}{360} \right) \cdot \left(\frac{19 \cdot 10^6}{\text{PRI}_{\mu\text{sec}}} \right) \right\}$	60%	30
		Test B: 15 unique PRI values randomly selected within the range of 518-3066 μsec, with a minimum increment of 1 μsec, excluding PRI values selected in Test A			
2	1-5	150-230	23-29	60%	30
3	6-10	200-500	16-18	60%	30
4	11-20	200-500	12-16	60%	30
Aggregate (Radar Types 1-4)				80%	120
Note 1: Short Pulse Radar Type 0 should be used for the detection bandwidth test, channel move time, and channel closing time tests.					

Table 3-5: Parameters for Short Pulse Radar Waveforms

A minimum of 30 unique waveforms are required for each of the Short Pulse Radar Types 2 through 4. If more than 30 waveforms are used for Short Pulse Radar Types 2 through 4, then each additional waveform must also be unique and not repeated from the previous waveforms.

Pulse Repetition Frequency Number	Pulse Repetition Frequency (Pulses Per Second)	Pulse Repetition Interval (Microseconds)
1	1930.5	518
2	1858.7	538
3	1792.1	558
4	1730.1	578
5	1672.2	598
6	1618.1	618
7	1567.4	638
8	1519.8	658
9	1474.9	678
10	1432.7	698
11	1392.8	718
12	1355	738
13	1319.3	758
14	1285.3	778
15	1253.1	798
16	1222.5	818
17	1193.3	838
18	1165.6	858
19	1139	878
20	1113.6	898
21	1089.3	918
22	1066.1	938
23	326.2	3066

Table 3-6: Pulse Repetition Intervals Values for Test A

Long Pulse Radar Test Waveform

Radar Type	Pulse Width (μsec)	Chirp Width (MHz)	PRI (μsec)	Number of Pulses per Burst	Number of Bursts	Minimum Percentage of Successful Detection	Minimum Number of Trials
5	50 - 100	5 - 20	1000 - 2000	1 - 3	8 - 20	80%	30

Table 3-7: Parameters for Long Pulse Radar Waveforms

The parameters for this waveform are randomly chosen. Thirty unique waveforms are required for the Long Pulse Radar Type waveforms. If more than 30 waveforms are used for the Long Pulse Radar Type waveforms, then each additional waveform must also be unique and not repeated from the previous waveforms.

Frequency Hopping Radar Test Waveform

Radar Type	Pulse Width (μsec)	PRI (μsec)	Pulses Per Hop	Hopping Rate (kHz)	Hopping Sequence Length (msec)	Minimum Percentage of Successful Detection	Minimum Number of Trials
6	1	333	9	0.333	300	70%	30

Table 3-8: Parameters for Frequency Hopping Radar Waveforms

For the Frequency Hopping Radar Type, the same Burst parameters are used for each waveform. The hopping sequence is different for each waveform and a 100-length segment is selected from the hopping sequence defined by the following algorithm:

The first frequency in a hopping sequence is selected randomly from the group of 475 integer frequencies from 5250 – 5724MHz. Next, the frequency that was just chosen is removed from the group and a frequency is randomly selected from the remaining 474 frequencies in the group. This process continues until all 475 frequencies are chosen for the set. For selection of a random frequency, the frequencies remaining within the group are always treated as equally likely.

3.5. Conducted Test Setup

The FCC KDB 905462 D02 UNII DFS Compliance Procedures New Rules v01 describes a radiated test setup and a conducted test setup. The conducted test setup was used for this testing. Figure 3-1 shows the typical test setup.

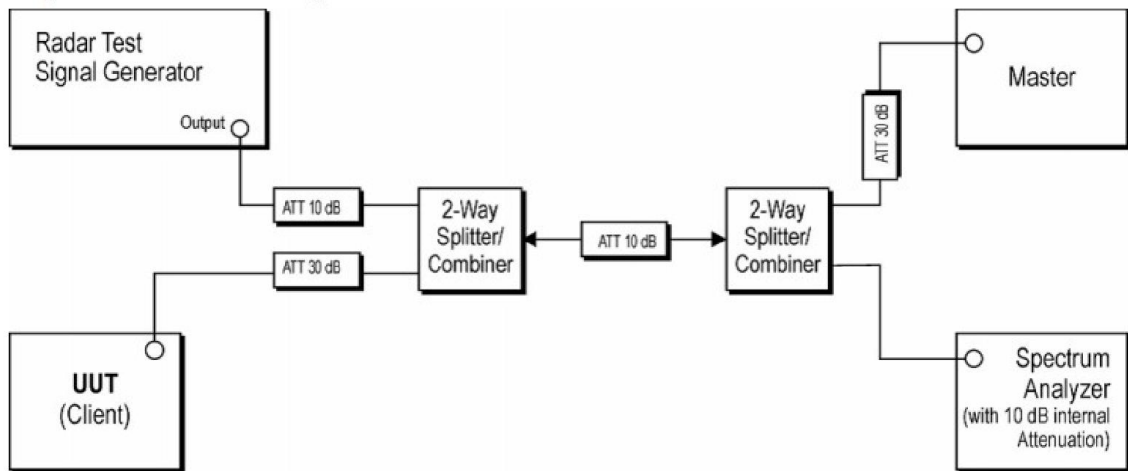

Figure 3-1: Conducted Test Setup where UUT is a Client and Radar Test Waveforms are injected into the Masters

4. TEST EQUIPMENT CALIBRATION DATE

Dynamic Frequency Selection - TR3

Instrument	Manufacturer	Type No.	Asset No.	Cali. Interval	Cali. Due Date
Spectrum Analyzer	Agilent	N9020A	MRTSUE06106	1 year	2018/05/08
ESG Vector Signal Generator	Agilent	E4438C	MRTSUE06026	1 year	2017/12/08
Temperature/Humidity Meter	Yuhuaze	HTC-2	N/A	1 year	2017/12/20

Software	Version	Manufacturer	Function
Pulse Building	N/A	Agilent	Radar Signal Generation Software
DFS Tool	V 6.9.2	Agilent	DFS Test Software

5. TEST RESULT

5.1. Summary

Product Name: Mobile Data Terminal
FCC ID: 2AC6AC71
FCC Classification: Unlicensed National Information Infrastructure (UNII)

Parameter	Limit	Test Result	Reference
Channel Move Time, Channel Closing Transmission Time and Non-Occupancy Period Measurement	Refer Table 3-3	Pass	Section 5.4

5.2. Radar Waveform Calibration

5.2.1. Calibration Setup

The conducted test setup was used for this calibration testing. Figure 3-2 shows the typical test setup.

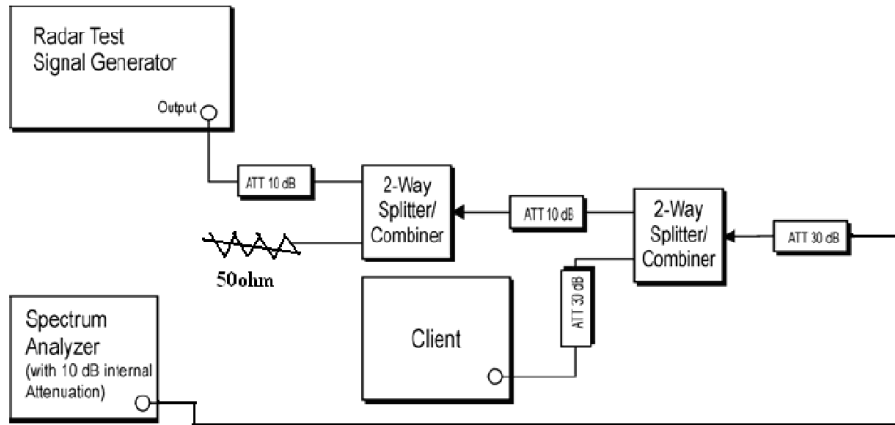

Figure 3-2: Conducted Test Setup

5.2.2. Calibration Procedure

The Interference Radar Detection Threshold Level is $(-64\text{dBm}) + (0) [\text{dBi}] + 1 \text{ dB} = -63 \text{ dBm}$ that had been taken into account the output power range and antenna gain. The above equipment setup was used to calibrate the conducted Radar Waveform. A vector signal generator was utilized to establish the test signal level for each radar type. During this process there were replace 50ohm terminal form Master and Client device and no transmissions by either the Master or Client Device. The spectrum analyzer was switched to the zero span (Time Domain) at the frequency of the Radar Waveform generator. Peak detection was used. The spectrum analyzer resolution bandwidth (RBW) and video bandwidth (VBW) were set to at least 3MHz. The vector signal generator amplitude was set so that the power level measured at the spectrum analyzer was $(-64\text{dBm}) + (0) [\text{dBi}] + 1 \text{ dB} = -63\text{dBm}$. Capture the spectrum analyzer plots on short pulse radar types, long pulse radar type and hopping radar waveform.

5.2.3. Cablibration Result

Radar #0 DFS detection threshold level and the burst of pulses on the Channel frequency

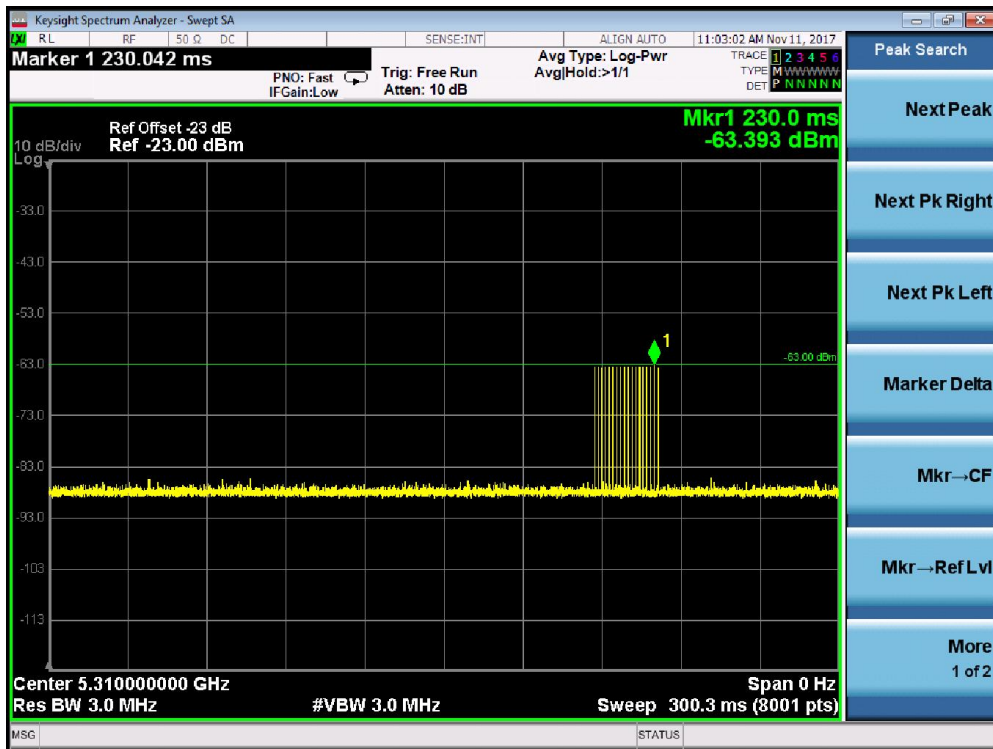

Radar #1(Test A) DFS detection threshold level and the burst of pulses on the Channel frequency

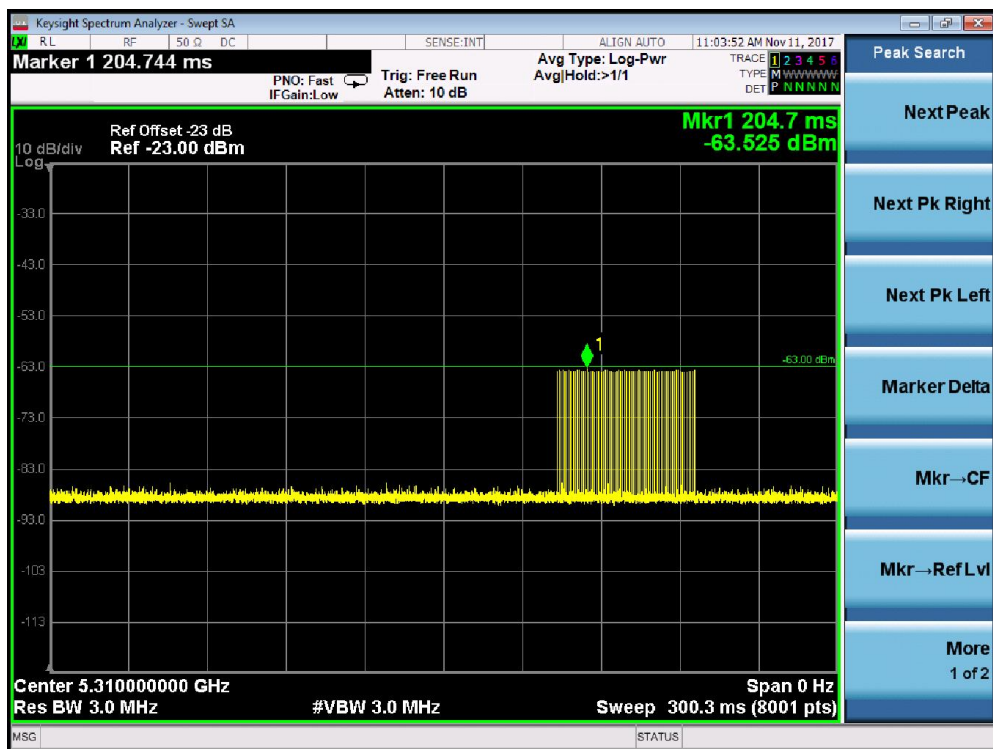

PRI = 758us and the number of pulses = 70

Radar #1(Test B) DFS detection threshold level and the burst of pulses on the Channel frequency

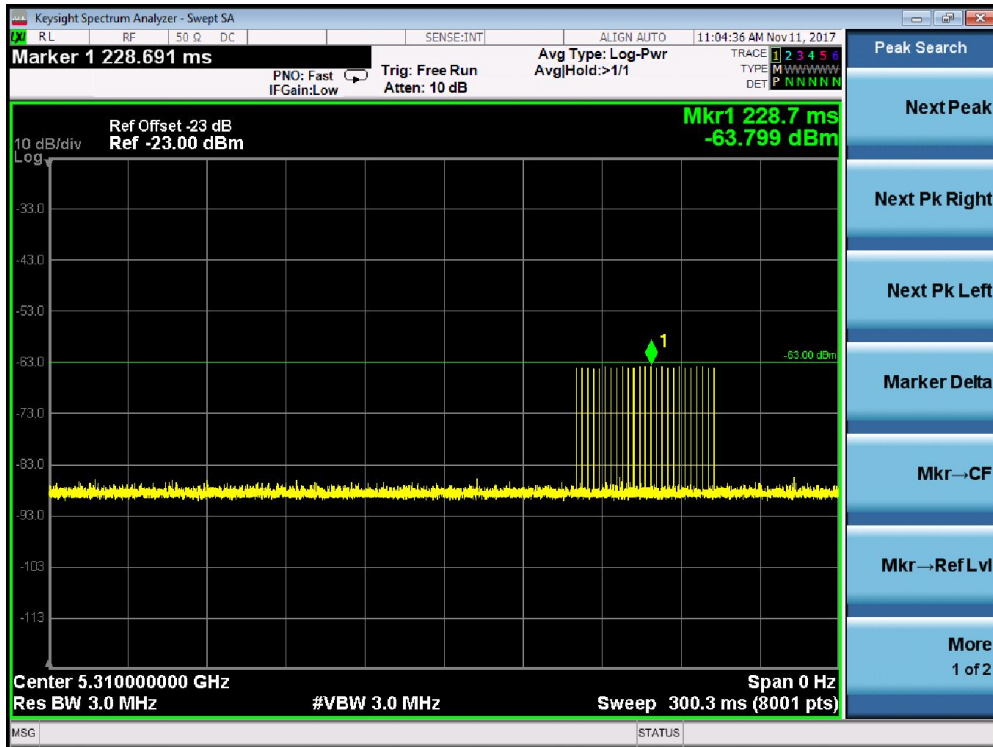

PRI = 2.199ms and the number of pulses = 25

Radar #2 DFS detection threshold level and the burst of pulses on the Channel frequency

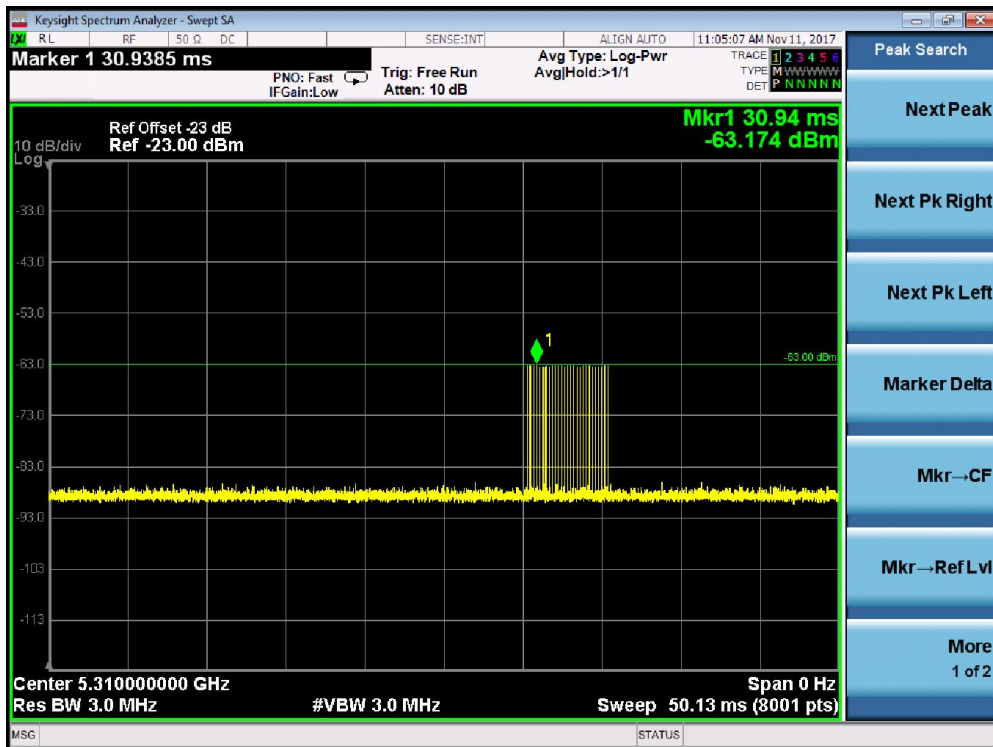

Radar #3 DFS detection threshold level and the burst of pulses on the Channel frequency

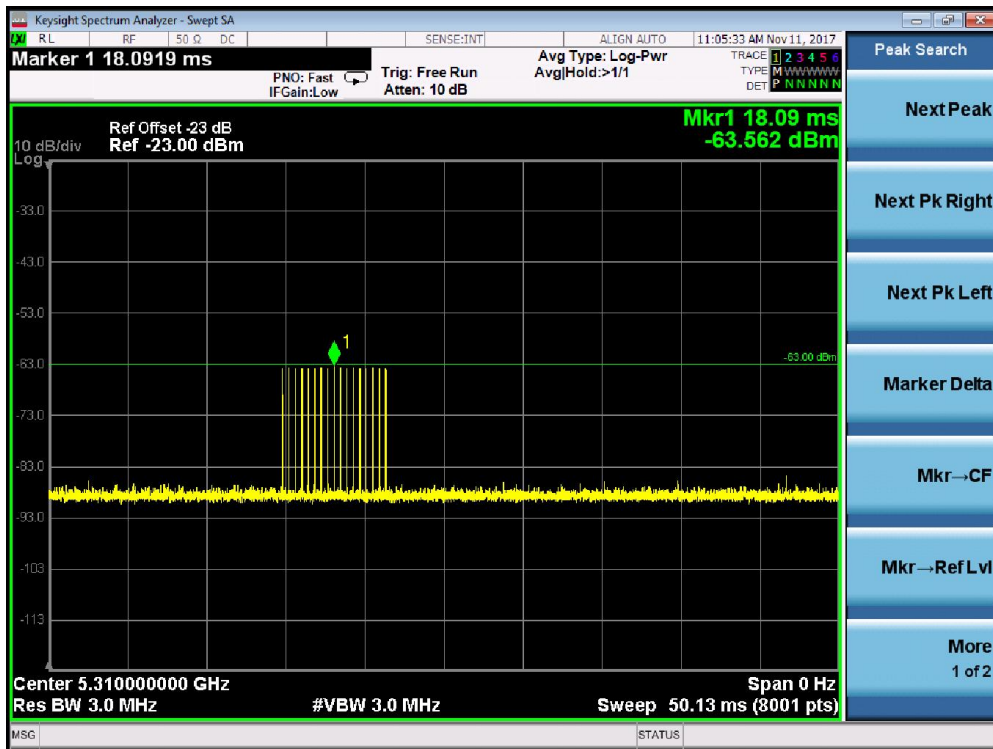

Radar #4 DFS detection threshold level and the burst of pulses on the Channel frequency

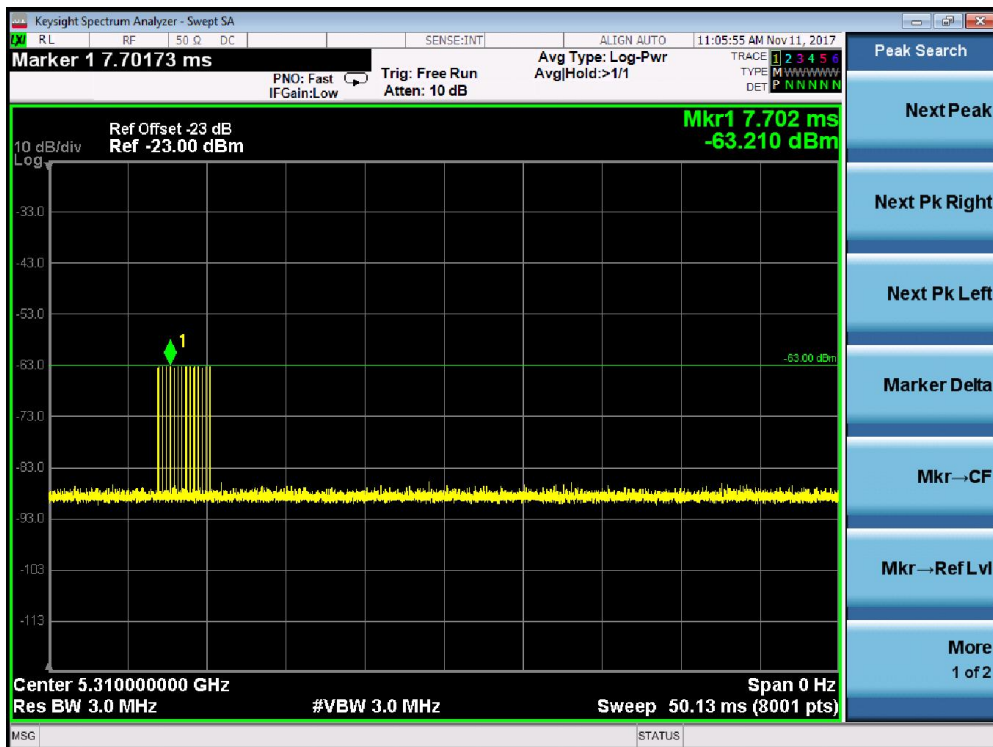

Radar #5 DFS detection threshold level and 12sec long burst on the Channel frequency

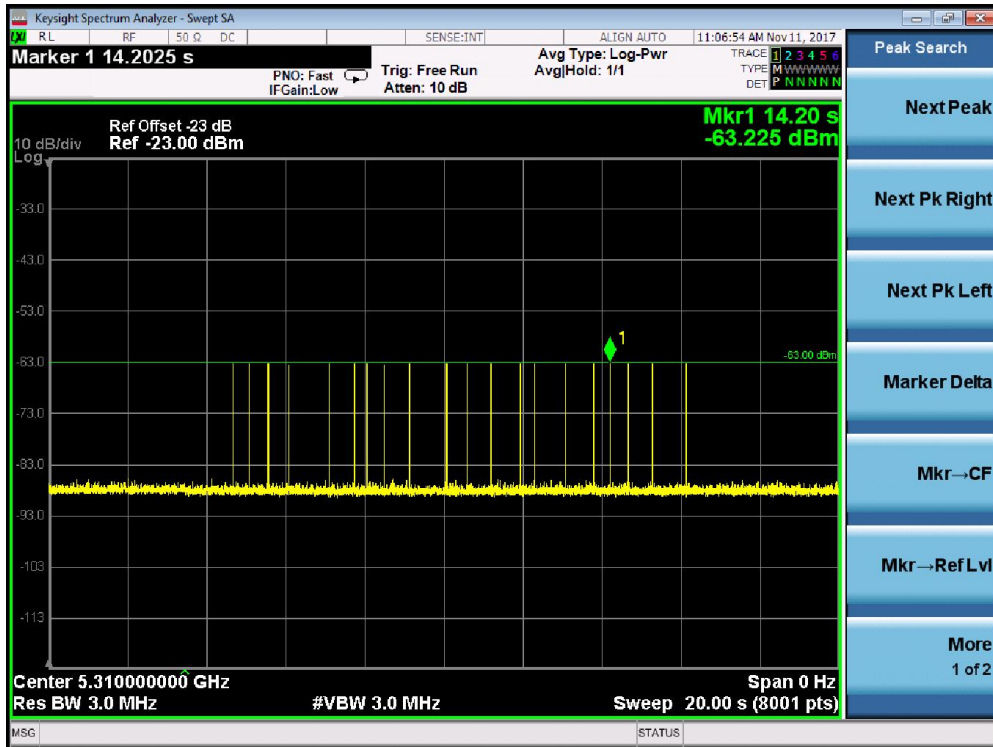

Radar #6 DFS detection threshold level and a single hop (9 pulses) on the Channel frequency within UNII detection bandwidth

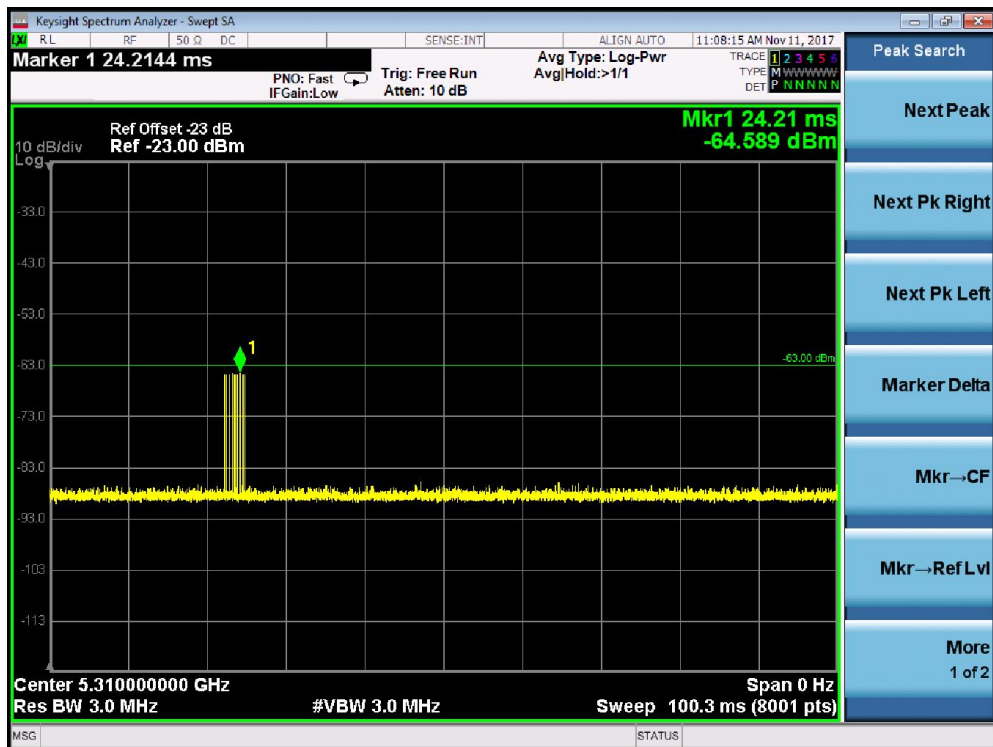

5.3. Channel Loading Test Result

System testing was performed with the designated MPEG test file that streams full motion video from the Mobile Data Terminal to the Client in full motion video mode using the media player with the V2.61 Codec package. This file is used by IP and Frame based systems for loading the test channel during the In-service compliance testing of the U-NII device

Channel Loading Plot - 802.11n-HT40 - 5310MHz

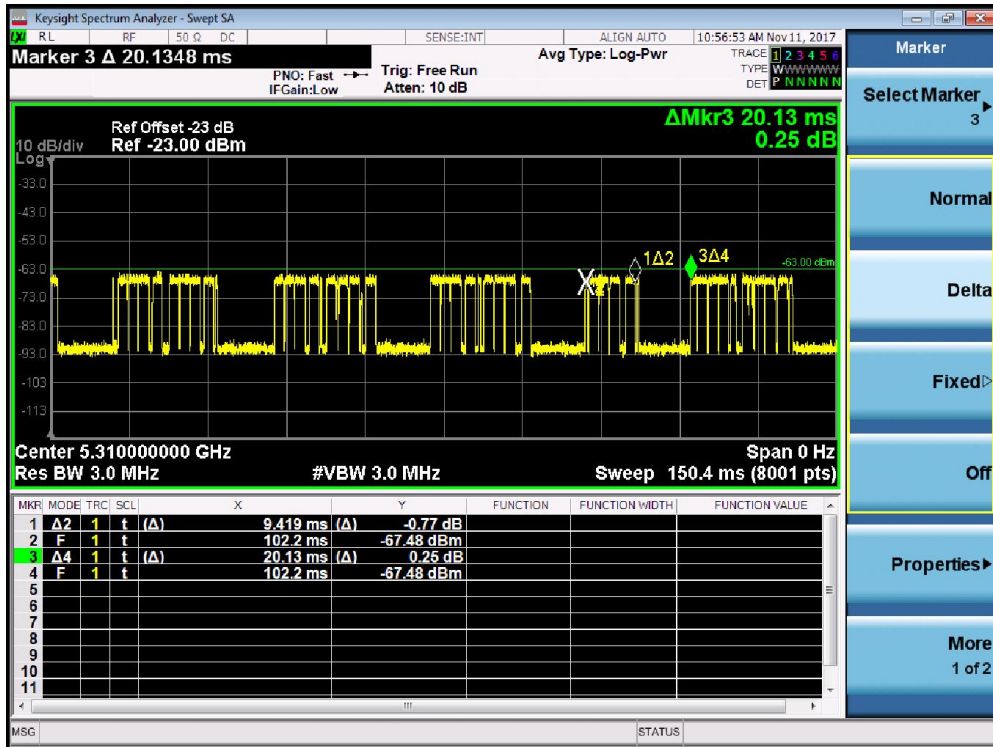

Test Mode	Packet ratio	Requirement ratio	Test Result
11n-HT40 - 5310MHz	46.79%	>17%	Pass

5.4. In-Service Monitoring for Channel Move Time, Channel Closing Transmission Time and Non-Occupancy Period Measurement

5.4.1. Test Limit

The EUT has In-Service Monitoring function to continuously monitor the radar signals. If the radar is detected, must leave the channel (Shutdown). The Channel Move Time to cease all transmissions on the current channel upon detection of a Radar Waveform above the DFS Detection Threshold within 10 sec. The total duration of Channel Closing Transmission Time is 260ms, consisting of data signals and the aggregate of control signals, by a U-NII device during the Channel Move Time. The Non-Occupancy Period time is 30 minute during which a Channel will not be utilized after a Radar Waveform is detected on that Channel.

5.4.2. Test Procedure Used

1. The test should be performed with Radar Type 0. The measurement timing begins at the end of the Radar Type 0.
2. When the radar burst with a level equal to the DFS Detection Threshold + 1dB is generated on the Operating Channel of the U-NII device. A U-NII device operating as a Master Device will associate with the Client Device at Channel. Stream the MPEG test file from the Master Device to the Client Device on the selected Channel for the entire period of the test. At time T0 the Radar Waveform generator sends a Burst of pulses for each of the radar types at Detection Threshold + 1dB.
2. Observe the transmissions of the EUT at the end of the radar Burst on the Operating Channel. Measure and record the transmissions from the EUT during the observation time (Channel Move Time).
3. Measurement of the aggregate duration of the Channel Closing Transmission Time method. With the spectrum analyzer set to zero span tuned to the center frequency of the EUT operating channel at the radar simulated frequency, peak detection, and max hold, the dwell time per bin is given by: $Dwell (1.5ms) = S (12 \text{ sec}) / B (8000)$; where Dwell is the dwell time per spectrum analyzer sampling bin, S is the sweep time and B is the number of spectrum analyzer sampling bins. An upper bound of the aggregate duration of the intermittent control signals of Channel Closing Transmission Time is calculated by: $80MHz: C = N \times Dwell$; where C is the Closing Time, N is the number of spectrum analyzer sampling bins showing a U-NII transmission and Dwell is the dwell time per bin.
4. Measure the UUT for more than 30 minutes following the channel close/move time to verify that the UUT does not resume any transmissions on this Channel.

5.4.3. Test Result

Channel Move Time and Channel Closing Transmission Time for 802.11n-HT40 - 5310MHz

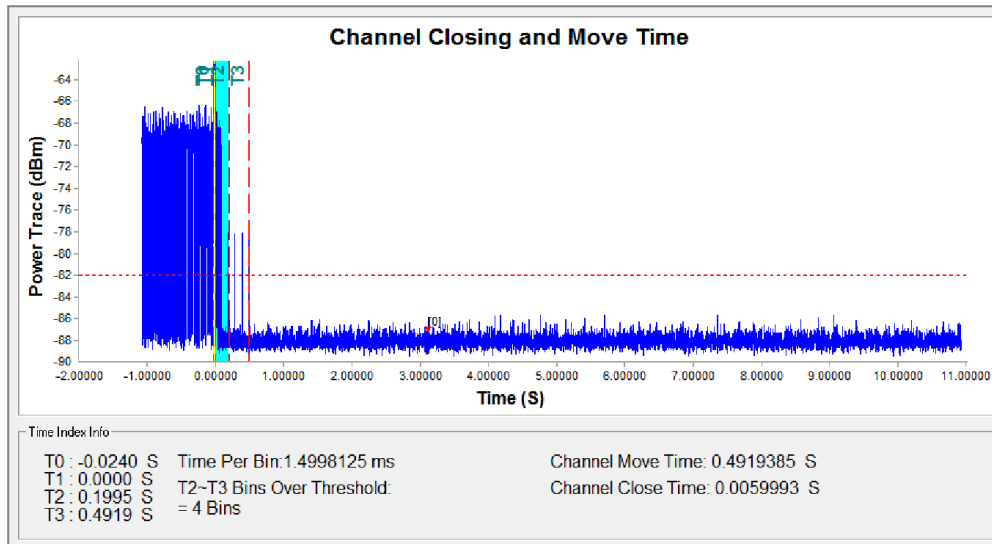
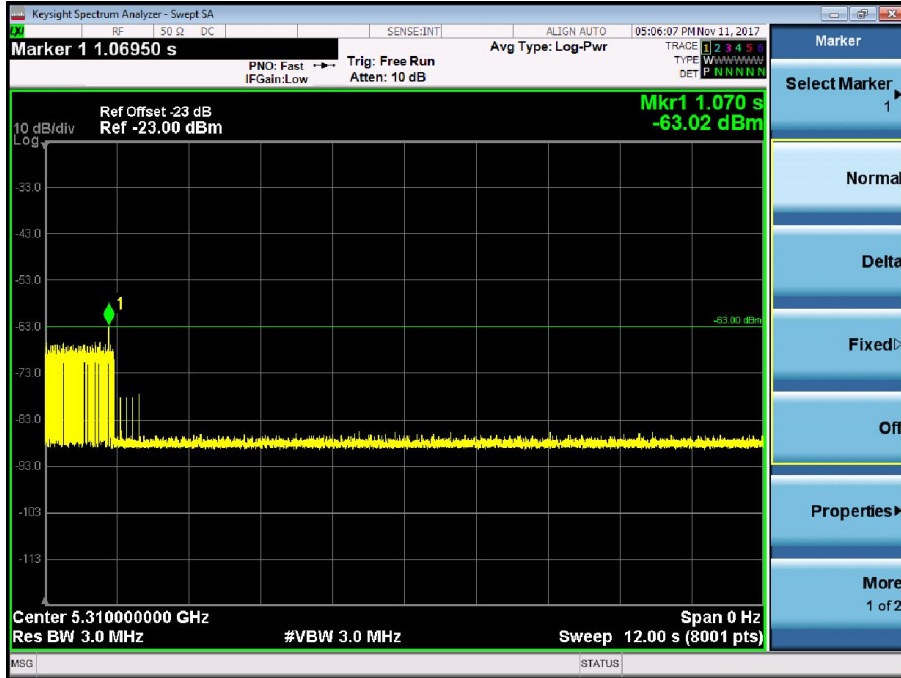

Non-Occupancy Period for 802.11n-HT40 - 5310MHz

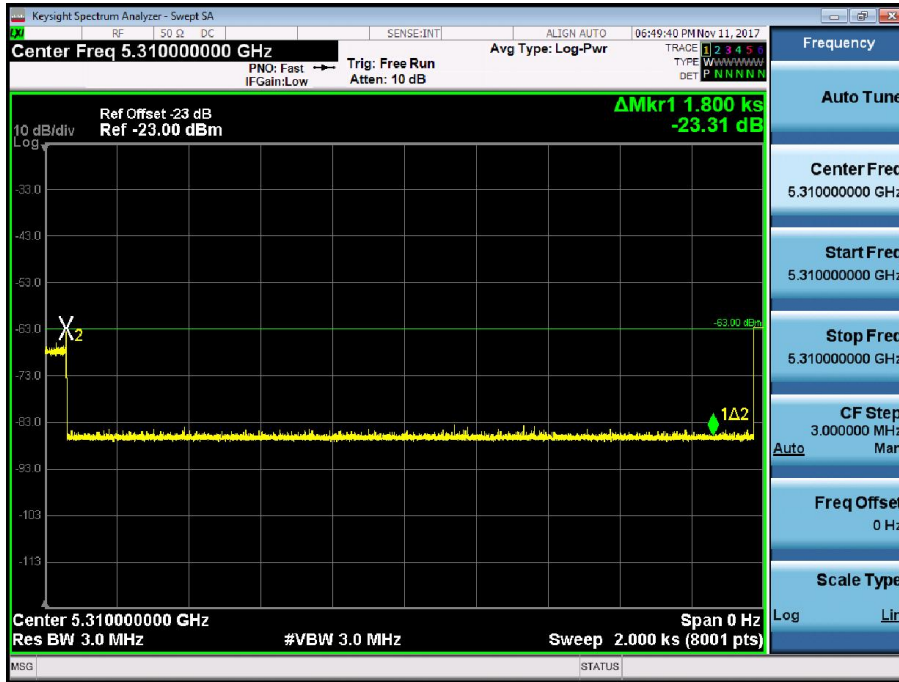

Parameter	Test Result	Limit
	Type 0	
Channel Move Time (s)	0.492s	<10s
Channel Closing Transmission Time (ms) (Note)	6.0ms	< 60ms
Non-Occupancy Period (min)	≥ 30min	≥ 30 min

Note: The Channel Closing Transmission Time is comprised of 200 milliseconds starting at the beginning of the Channel Move Time plus any additional intermittent control signals required to facilitate a Channel move (an aggregate of 60 milliseconds) during the remainder of the 10 seconds period. The aggregate duration of control signals will not count quiet periods in between transmissions.

6. CONCLUSION

The data collected relate only the item(s) tested and show that the **Mobile Data Terminal** is in compliance with Part 15E of the FCC Rules and IC Rules.

The End