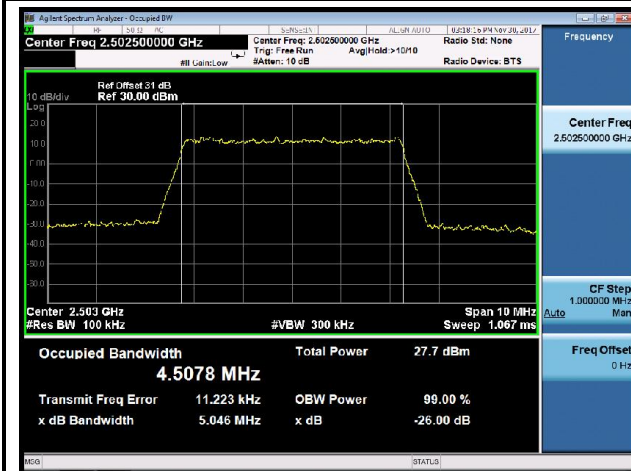
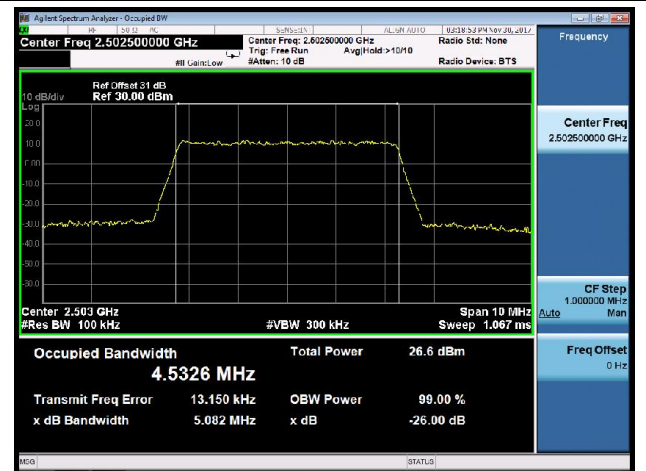
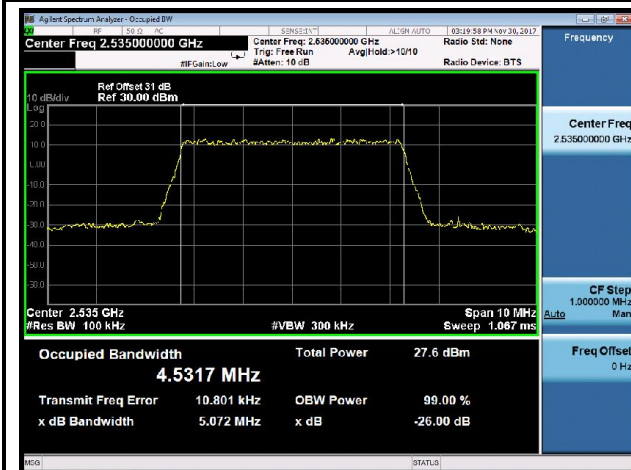
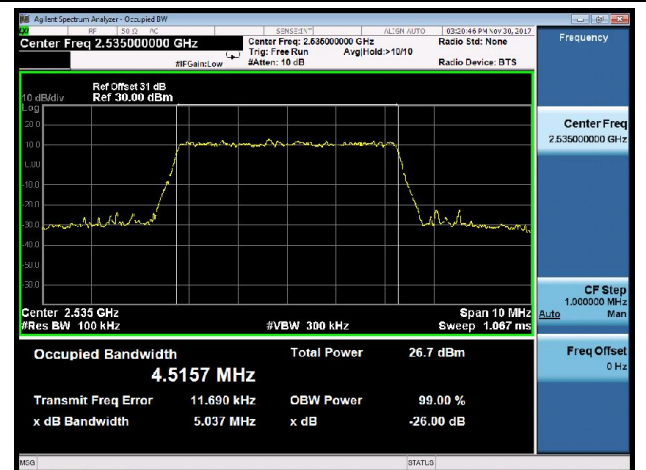
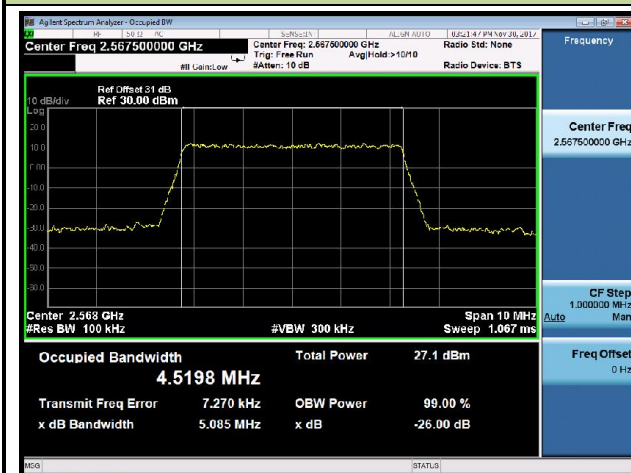
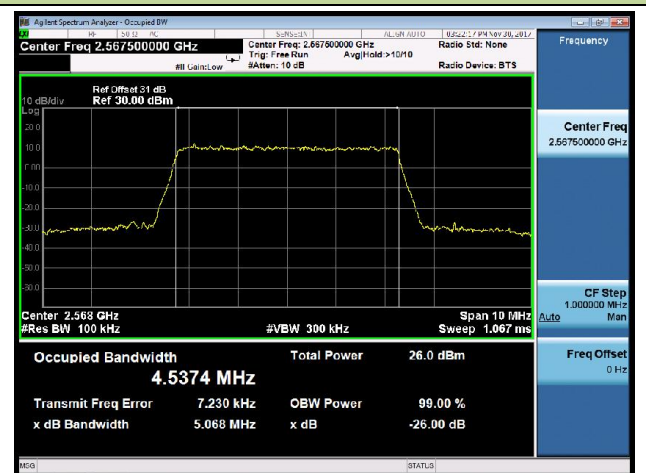
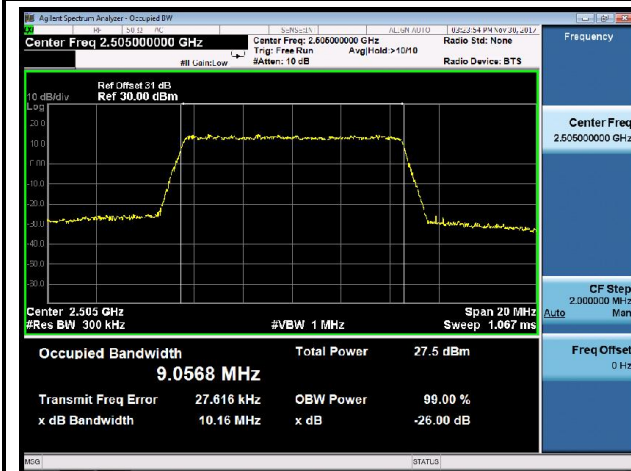
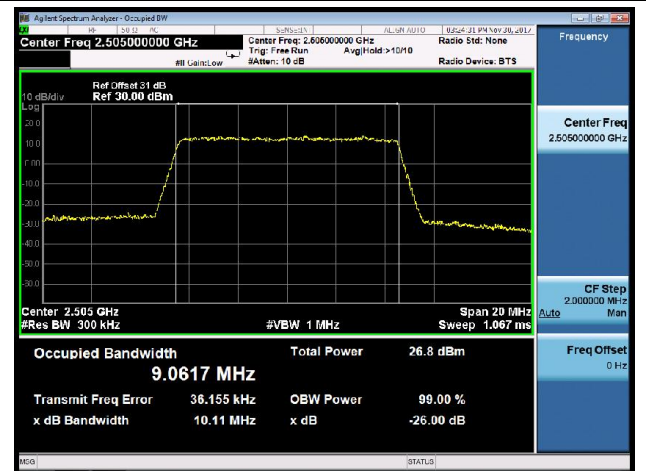
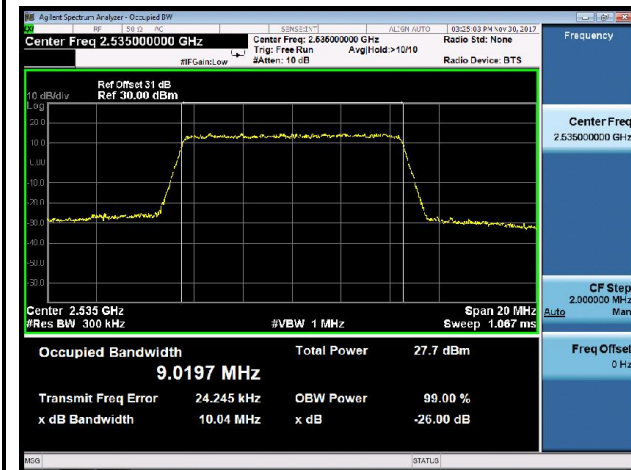
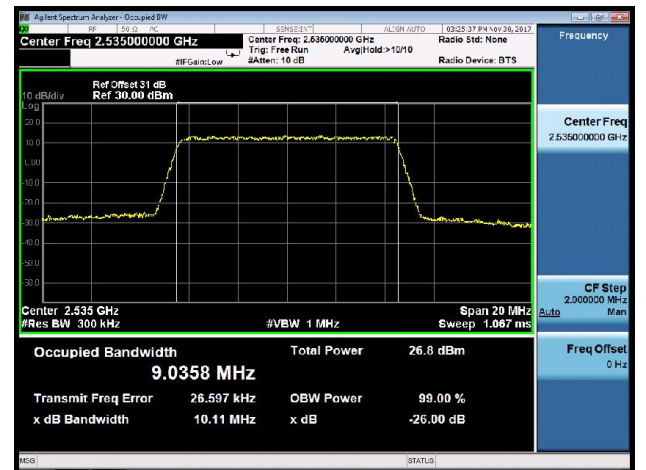
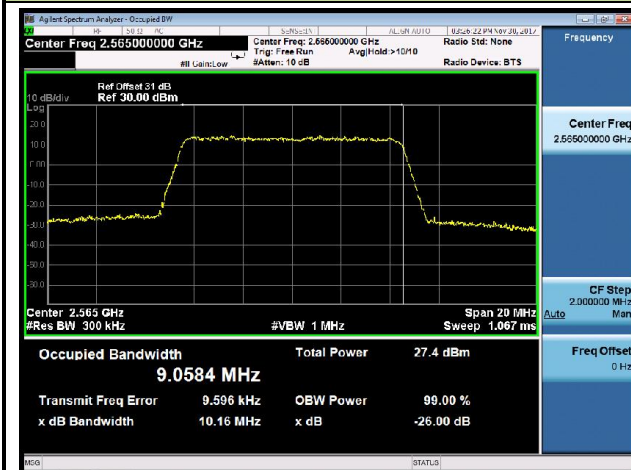
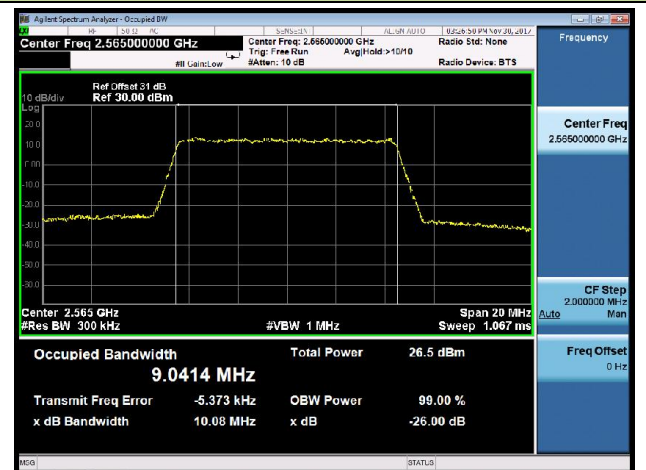
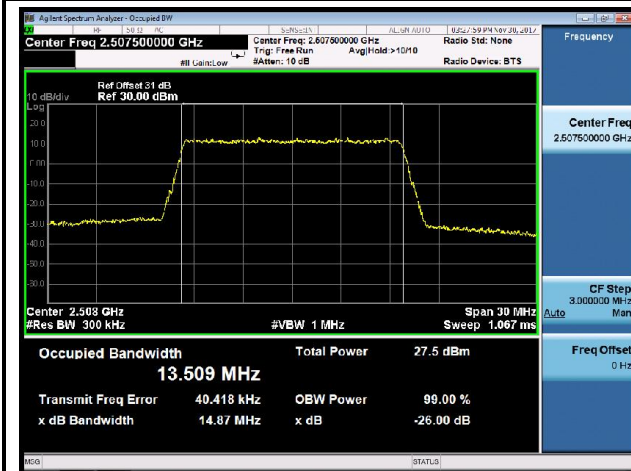

LTE Band 7 99% & 26dB Occupied Bandwidth
Low CH / 5MHz / QPSK

Low CH / 5MHz / 16-QAM

Mid. CH / 5MHz / QPSK

Mid. CH / 5MHz / 16-QAM

High CH / 5MHz / QPSK

High CH / 5MHz / 16-QAM

LTE Band 7 99% & 26dB Occupied Bandwidth
Low CH / 10MHz / QPSK

Low CH / 10MHz / 16-QAM

Mid. CH / 10MHz / QPSK

Mid. CH / 10MHz / 16-QAM

High CH / 10MHz / QPSK

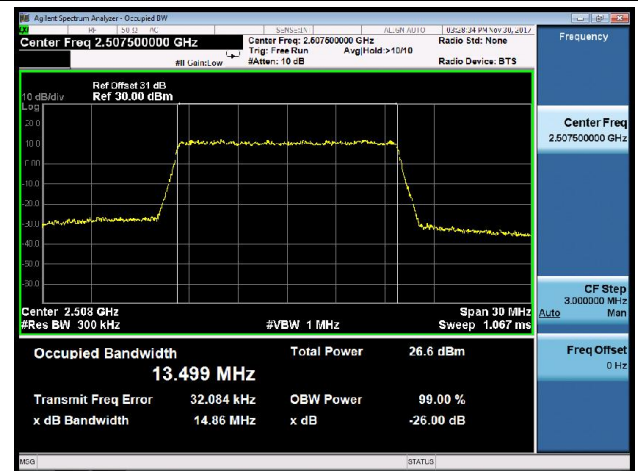
High CH / 10MHz / 16-QAM

LTE Band 7 99% & 26dB Occupied Bandwidth

Low CH / 15MHz / QPSK



Low CH / 15MHz / 16-QAM



Mid. CH / 15MHz / QPSK

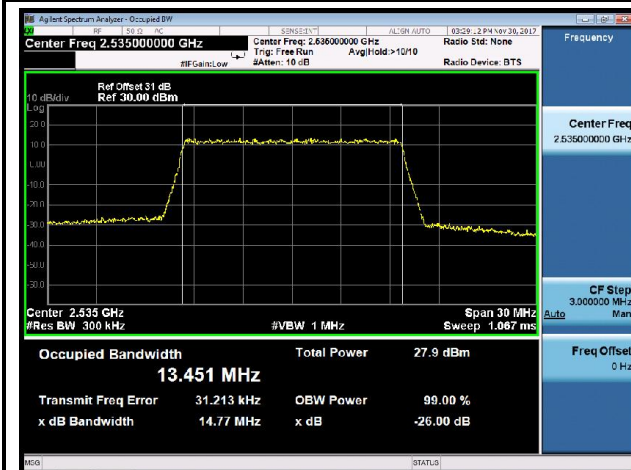

Mid. CH / 15MHz / 16-QAM

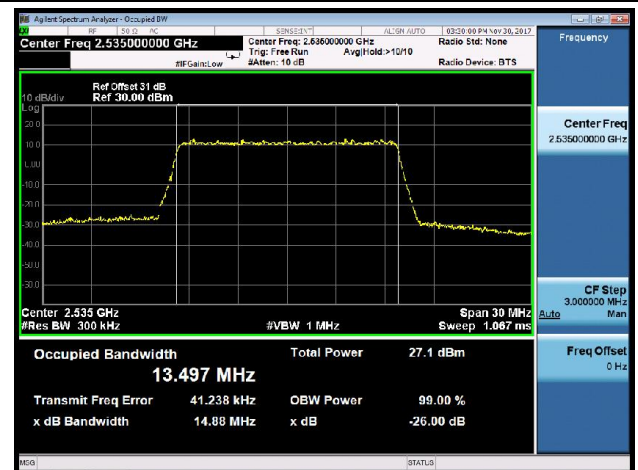

High CH / 15MHz / QPSK

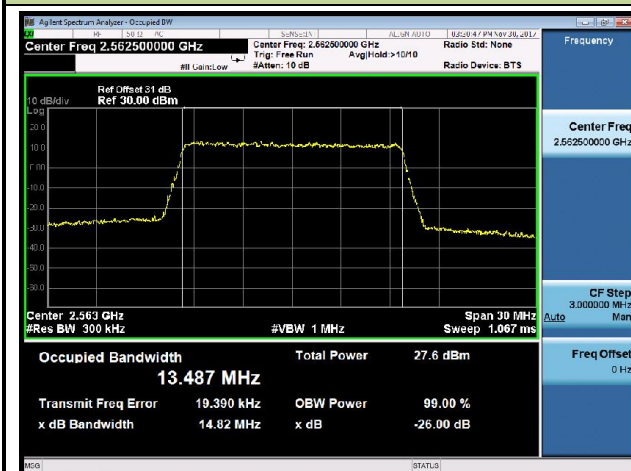

High CH / 15MHz / 16-QAM

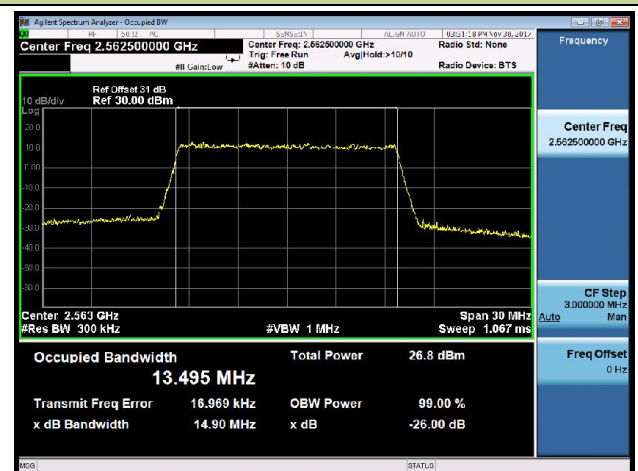

LTE Band 7 99% & 26dB Occupied Bandwidth

Low CH / 20MHz / QPSK

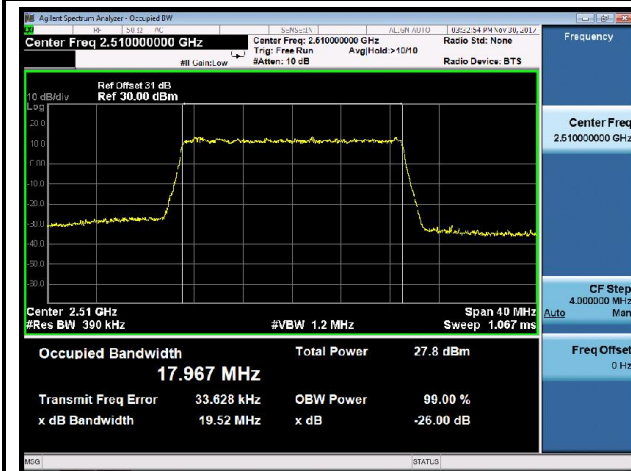

Low CH / 20MHz / 16-QAM

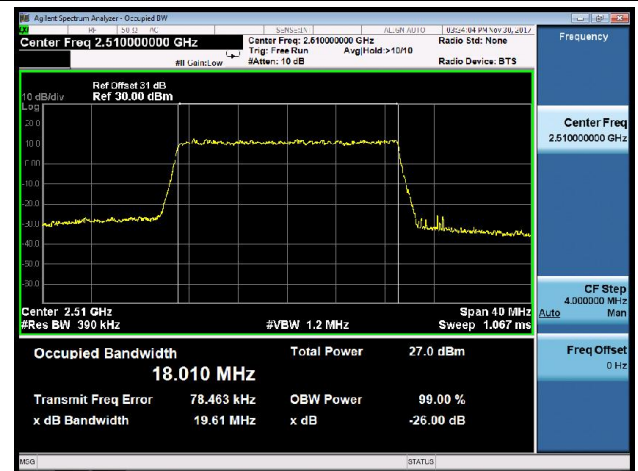

Mid. CH / 20MHz / QPSK

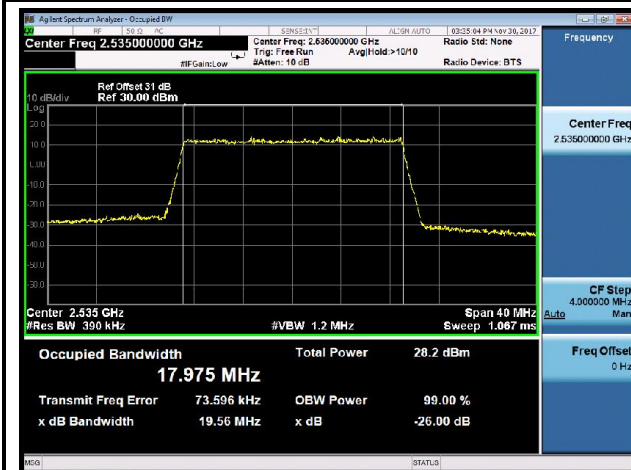

Mid. CH / 20MHz / 16-QAM

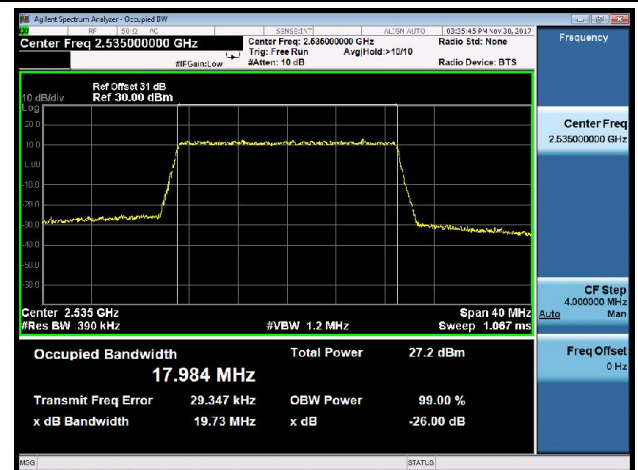

High CH / 20MHz / QPSK

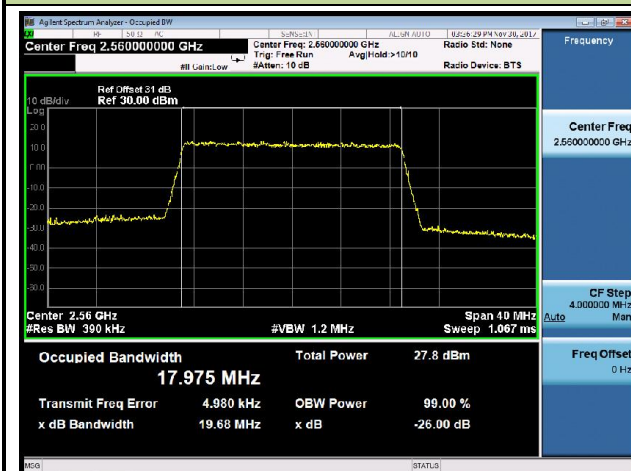

High CH / 20MHz / 16-QAM

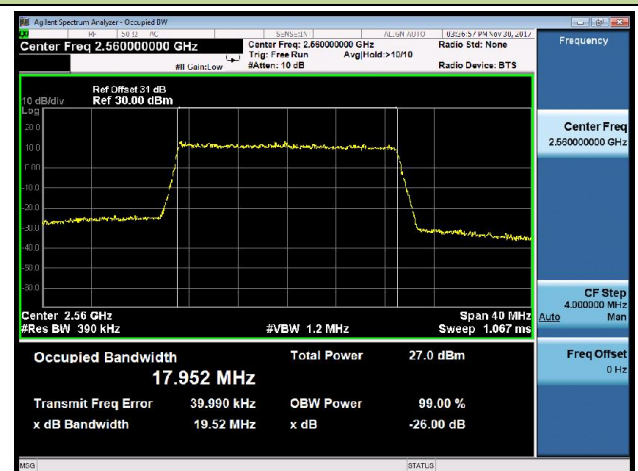

LTE Band 12 99% & 26dB Occupied Bandwidth

Low CH / 1.4MHz / QPSK



Low CH / 1.4MHz / 16-QAM



Mid. CH / 1.4MHz / QPSK

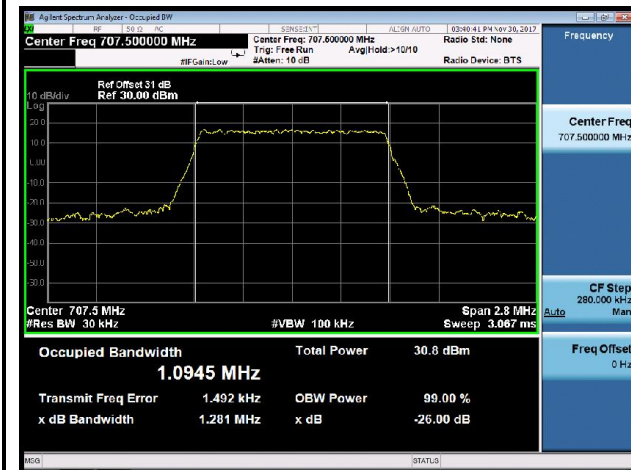

Mid. CH / 1.4MHz / 16-QAM

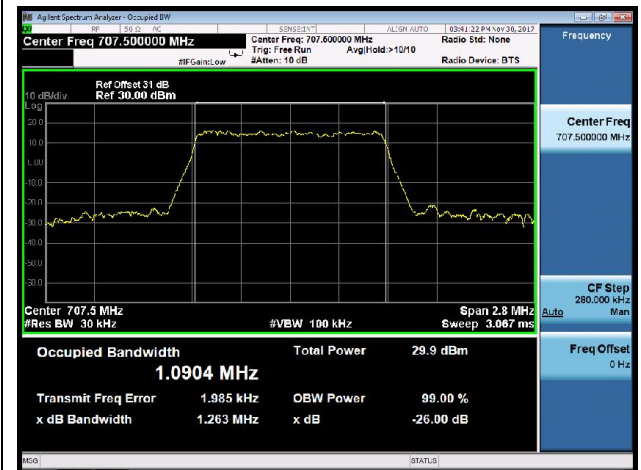

High CH / 1.4MHz / QPSK

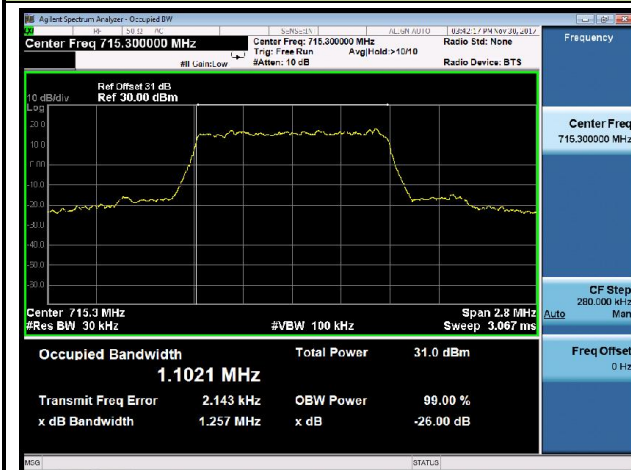

High CH / 1.4MHz / 16-QAM

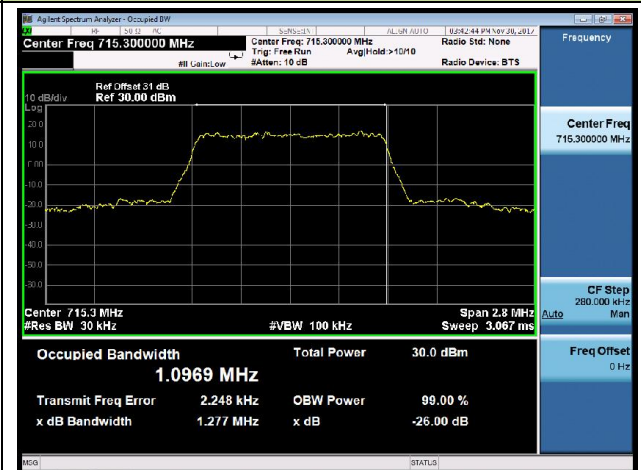

LTE Band 12 99% & 26dB Occupied Bandwidth

Low CH / 3MHz / QPSK

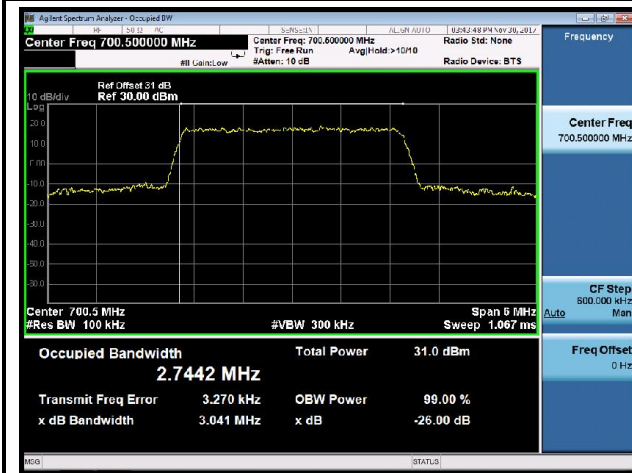

Low CH / 3MHz / 16-QAM



Mid. CH / 3MHz / QPSK

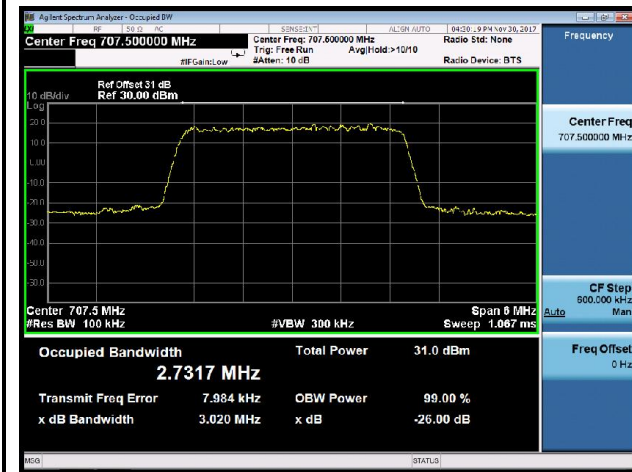

Mid. CH / 3MHz / 16-QAM

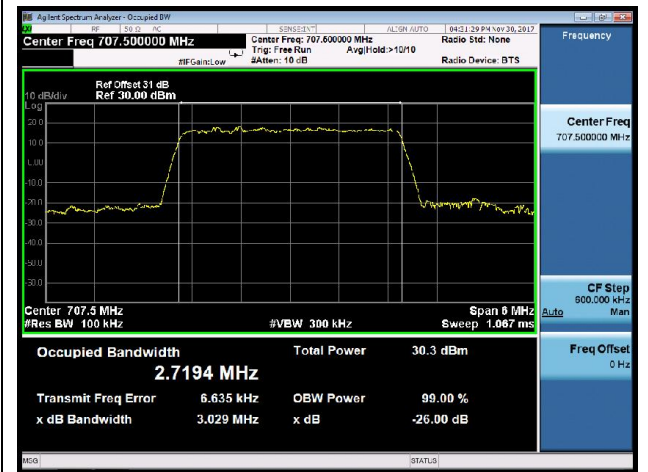

High CH / 3MHz / QPSK

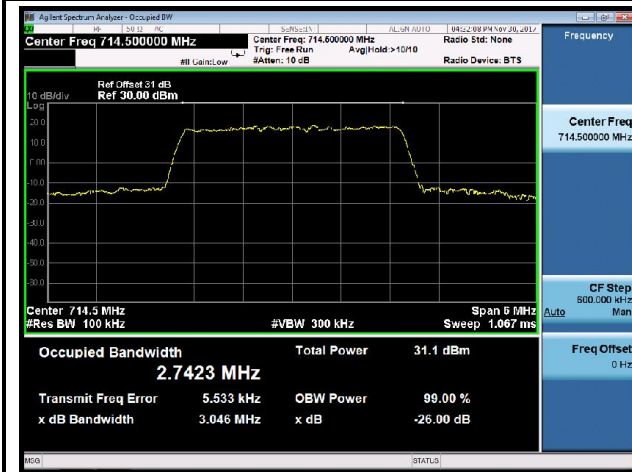

High CH / 3MHz / 16-QAM

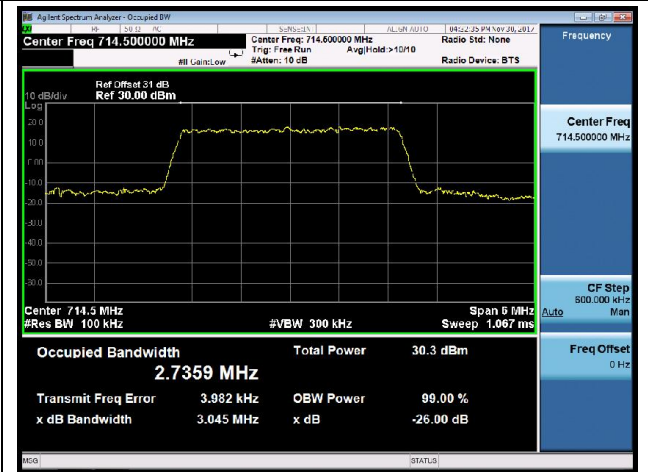

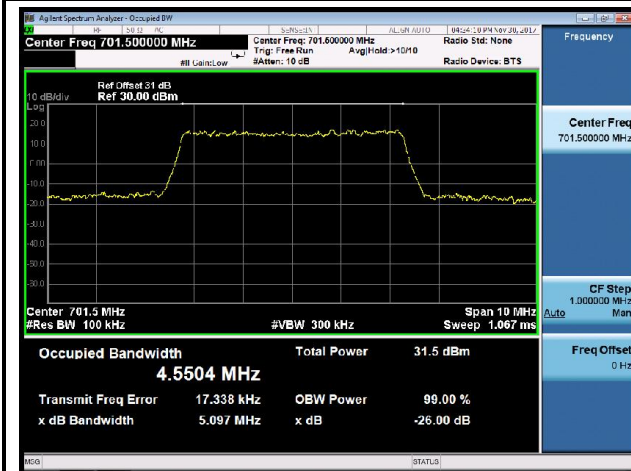
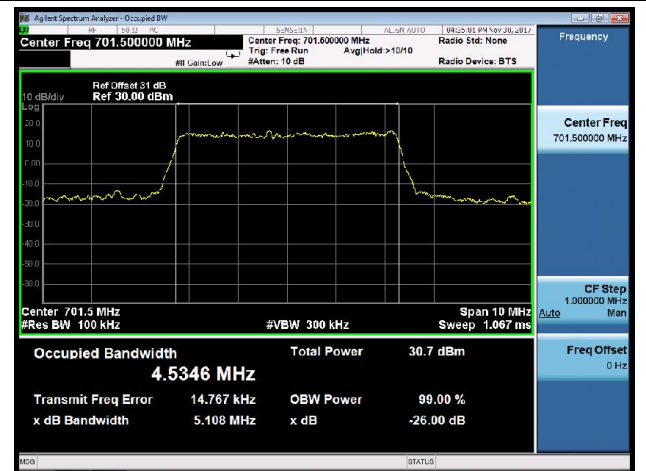
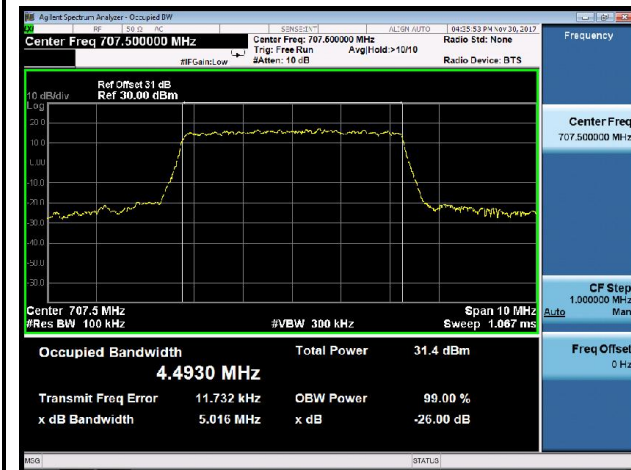
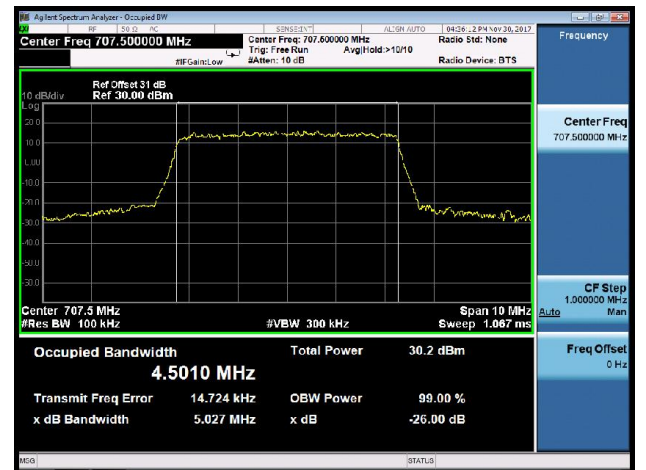
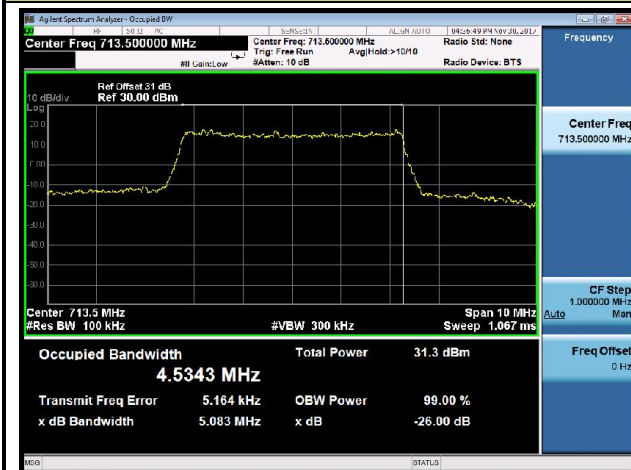
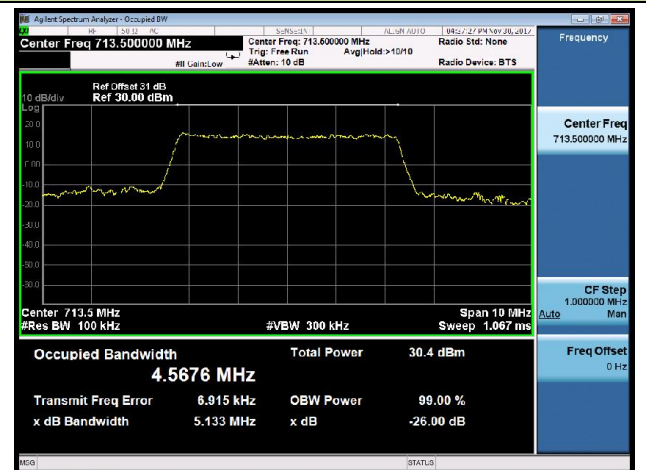
LTE Band 12 99% & 26dB Occupied Bandwidth
Low CH / 5MHz / QPSK

Low CH / 5MHz / 16-QAM

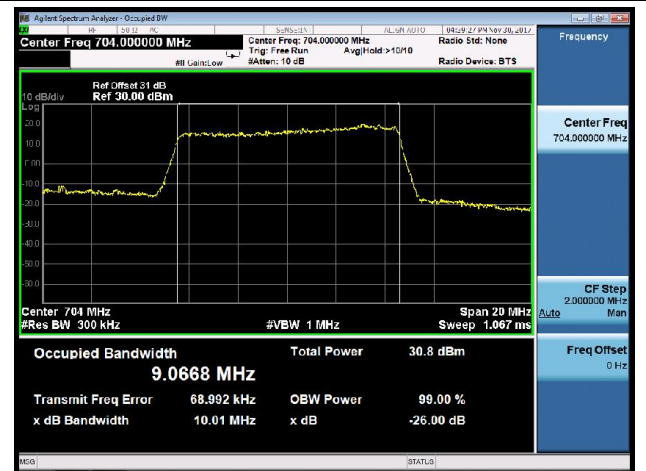
Mid. CH / 5MHz / QPSK

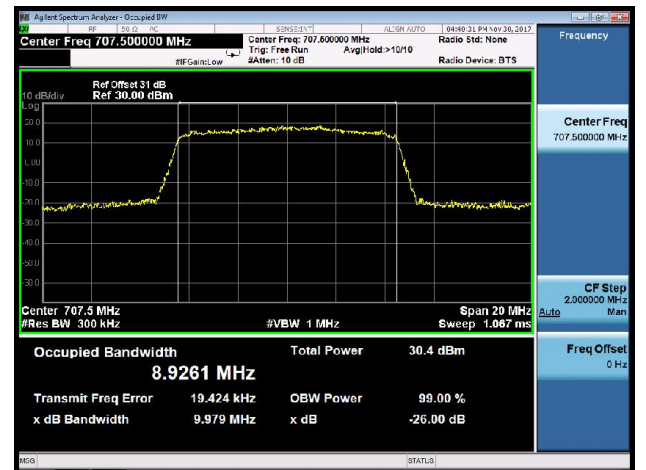
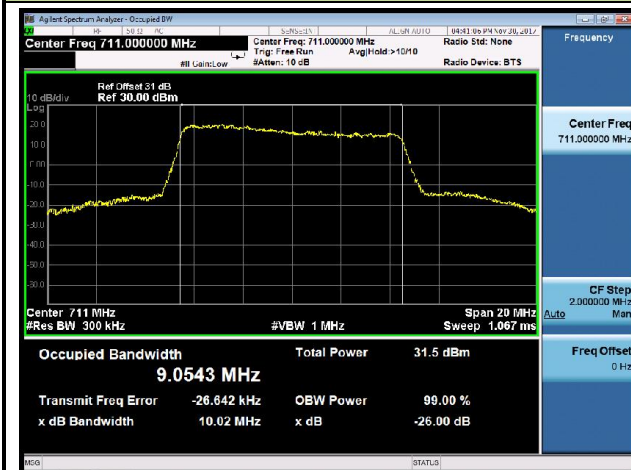
Mid. CH / 5MHz / 16-QAM

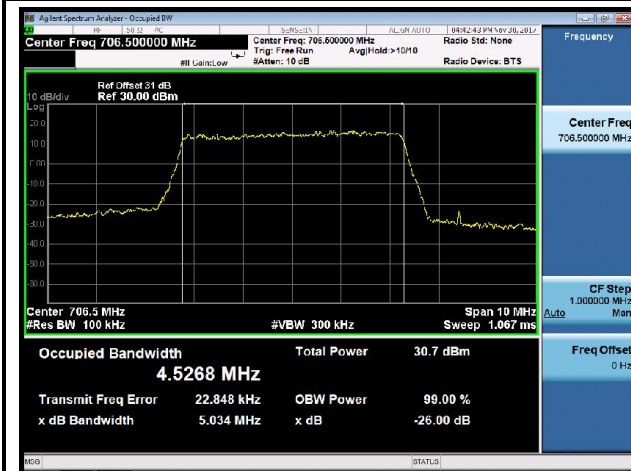
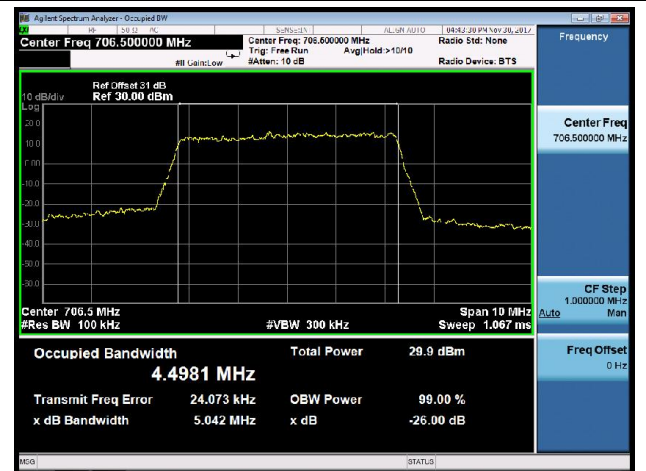
High CH / 5MHz / QPSK

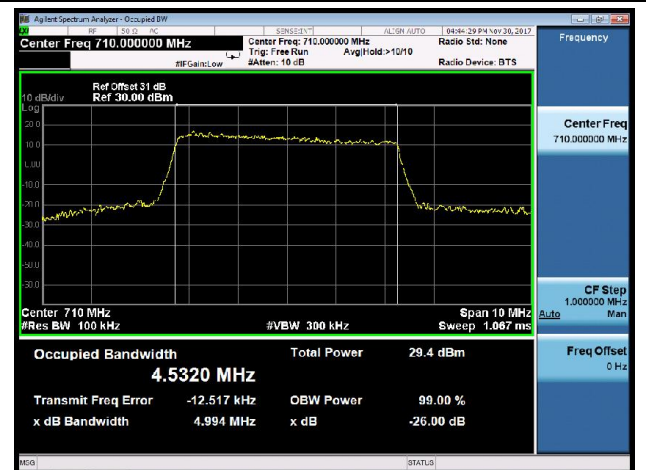
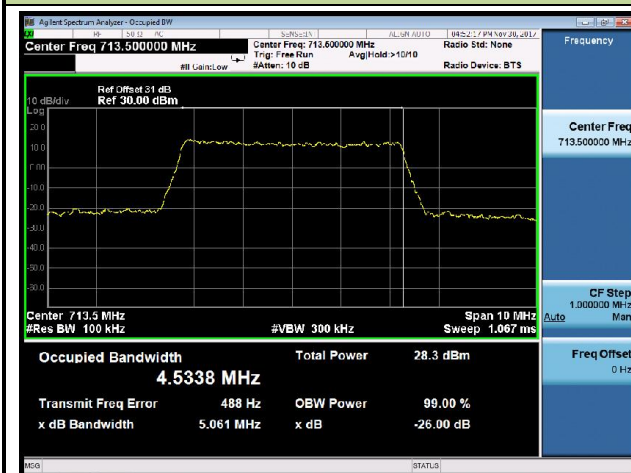
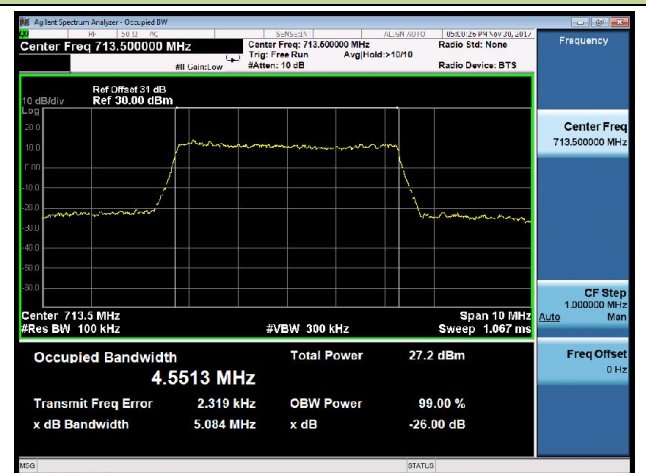
High CH / 5MHz / 16-QAM

LTE Band 12 99% & 26dB Occupied Bandwidth
Low CH / 10MHz / QPSK

Low CH / 10MHz / 16-QAM

Mid. CH / 10MHz / QPSK

Mid. CH / 10MHz / 16-QAM

High CH / 10MHz / QPSK

High CH / 10MHz / 16-QAM

LTE Band 17 99% & 26dB Occupied Bandwidth
Low CH / 5MHz / QPSK

Low CH / 5MHz / 16-QAM

Mid. CH / 5MHz / QPSK

Mid. CH / 5MHz / 16-QAM

High CH / 5MHz / QPSK

High CH / 5MHz / 16-QAM

LTE Band 17 99% & 26dB Occupied Bandwidth

Low CH / 10MHz / QPSK



Low CH / 10MHz / 16-QAM



Mid. CH / 10MHz / QPSK

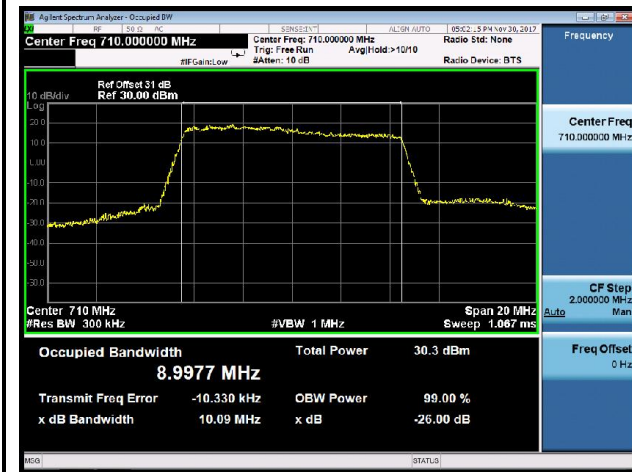

Mid. CH / 10MHz / 16-QAM



High CH / 10MHz / QPSK

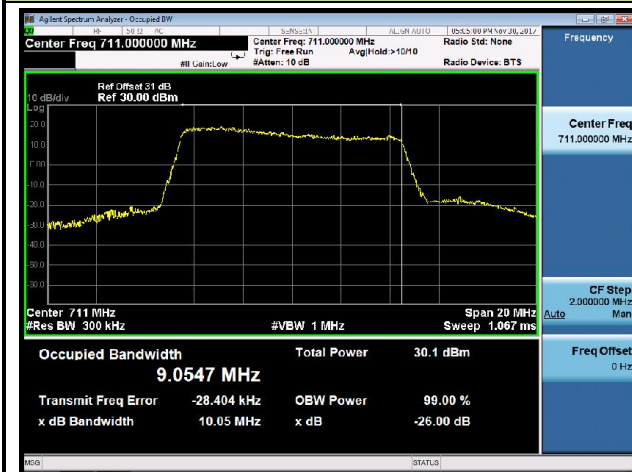

High CH / 10MHz / 16-QAM



7.3. Band Edge Emissions at Antenna Terminal

7.3.1. Test Limit

24.238 (a)

For operations in the 1850-1910 and 1930-1990 MHz band, the FCC limit is $43 + 10\log_{10}$ (P[Watts]) dB below the transmitter power P(Watts) in a 1MHz bandwidth. However, in the 1 MHz bands immediately outside and adjacent to the frequency block a resolution bandwidth of at least one percent of the emission bandwidth of the fundamental emission of the transmitter may be employed.

27.53 (g)

For operations in the 600 MHz band and the 698-746 MHz band, the power of any emission outside a licensee's frequency band(s) of operation shall be attenuated below the transmitter power (P) within the licensed band(s) of operation, measured in watts, by at least $43 + 10 \log (P)$ dB. Compliance with this provision is based on the use of measurement instrumentation employing a resolution bandwidth of 100 kilohertz or greater. However, in the 100kilohertz bands immediately outside and adjacent to a licensee's frequency block, a resolution bandwidth of at least 30kHz may be employed.

27.53 (h)

For operations in the 1710 - 1755 MHz band, the FCC limit is $43 + 10\log_{10}$ (P[Watts]) dB below the transmitter power P(Watts) in a 1 MHz bandwidth. However, in the 1MHz bands immediately outside and adjacent to the licensee's frequency block, a resolution bandwidth of at least one percent of the emission bandwidth of the fundamental emission of the transmitter may be employed.

27.53(m)(4)

For mobile digital stations, the attenuation factor shall be not less than $40 + 10 \log (P)$ dB on all frequencies between the channel edge and 5 megahertz from the channel edge, $43 + 10 \log (P)$ dB on all frequencies between 5 megahertz and X megahertz from the channel edge, and $55 + 10$

log (P) dB on all frequencies more than X megahertz from the channel edge, where X is the greater of 6 megahertz or the actual emission bandwidth as defined in paragraph (m)(6) of this section. In addition, the attenuation factor shall not be less than $43 + 10 \log (P)$ dB on all frequencies between 2490.5 MHz and 2496 MHz and $55 + 10 \log (P)$ dB at or below 2490.5 MHz. Mobile Satellite Service licensees operating on frequencies below 2495 MHz may also submit a documented interference complaint against BRS licensees operating on channel BRS Channel 1 on the same terms and conditions as adjacent channel BRS or EBS licensees.

7.3.2. Test Procedure Used

KDB 971168 D01v03 - Section 6.0 & ANSI/TIA-603-E-2016

7.3.3. Test Setting

1. Start frequency was set to 30MHz and stop frequency was set to at least $10 \times$ the fundamental frequency (separated into at least two plots per channel)
2. Detector = RMS
3. Trace mode = trace average for continuous emissions, max hold for pulse emissions
4. Sweep time = auto couple
5. The trace was allowed to stabilize
6. Please see test notes below for RBW and VBW settings

7.3.4. Test Setup

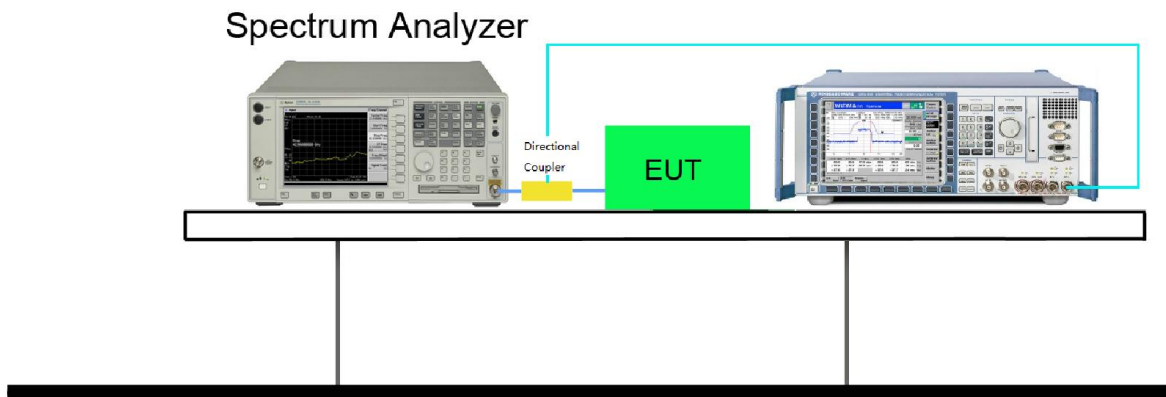

7.3.5. Test Result

Product	Mobile Data Terminal	Temperature	25°C
Test Engineer	Milo Li	Relative Humidity	54%
Test Site	TR3	Test Date	2017/11/30

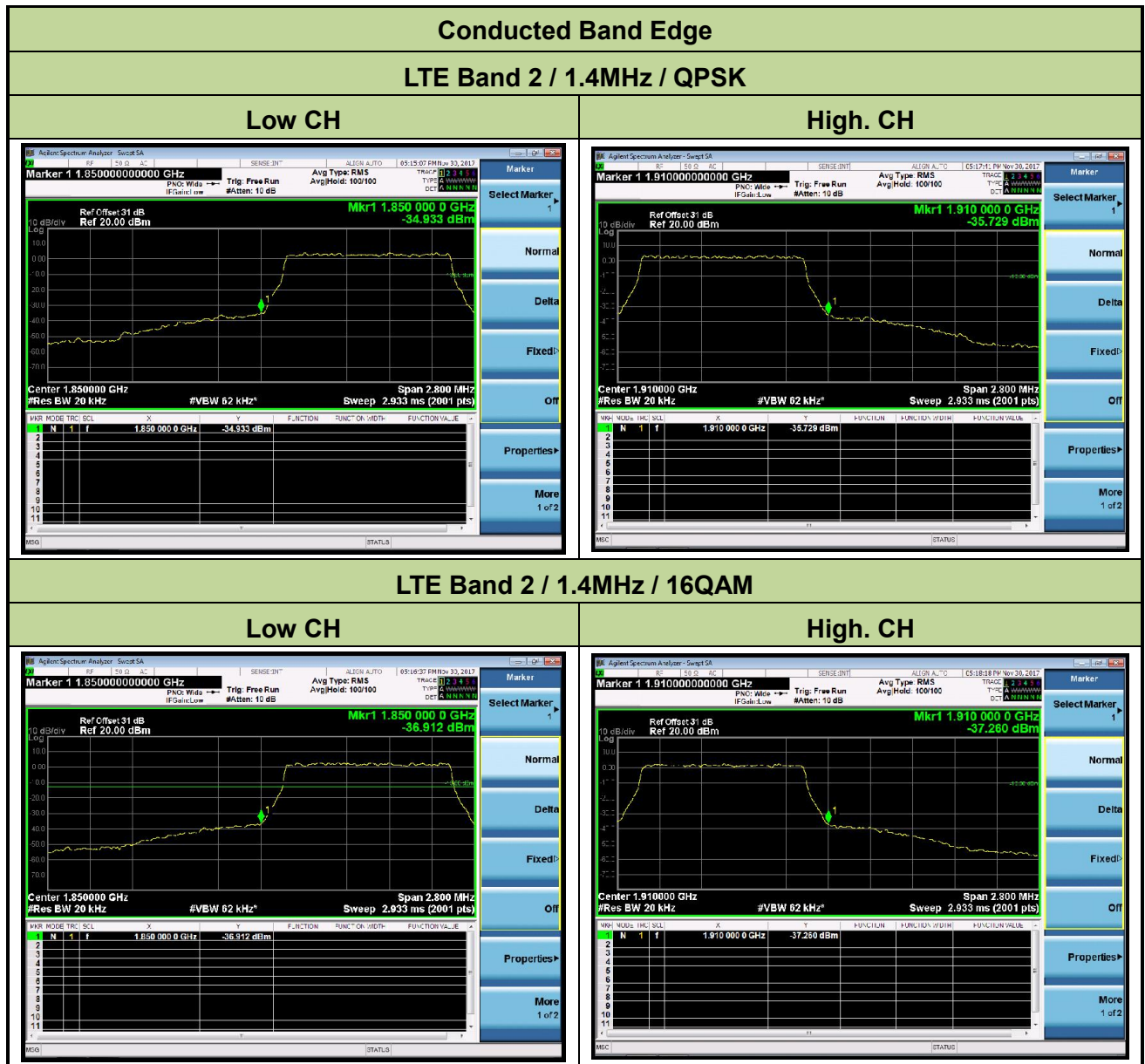

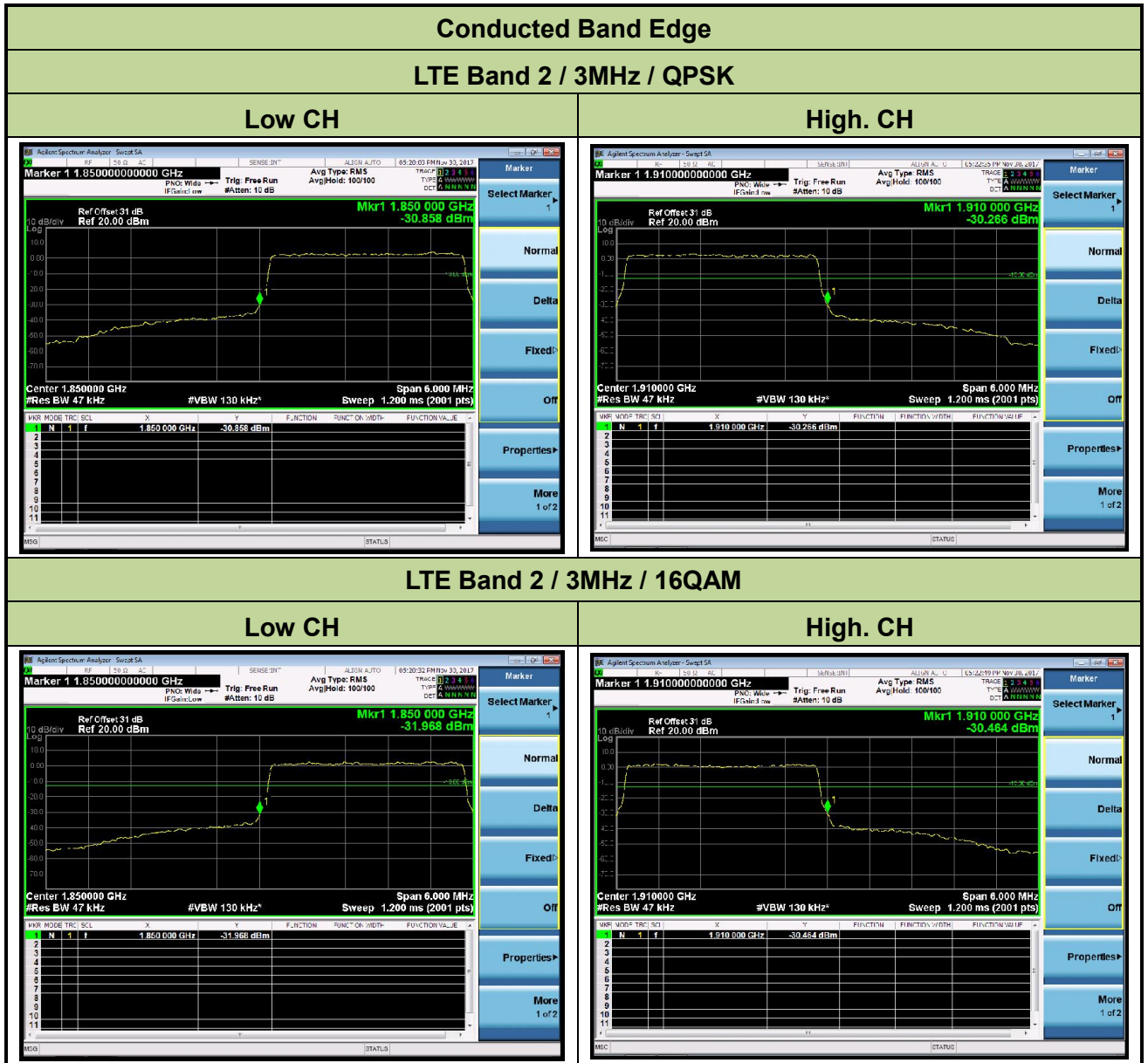

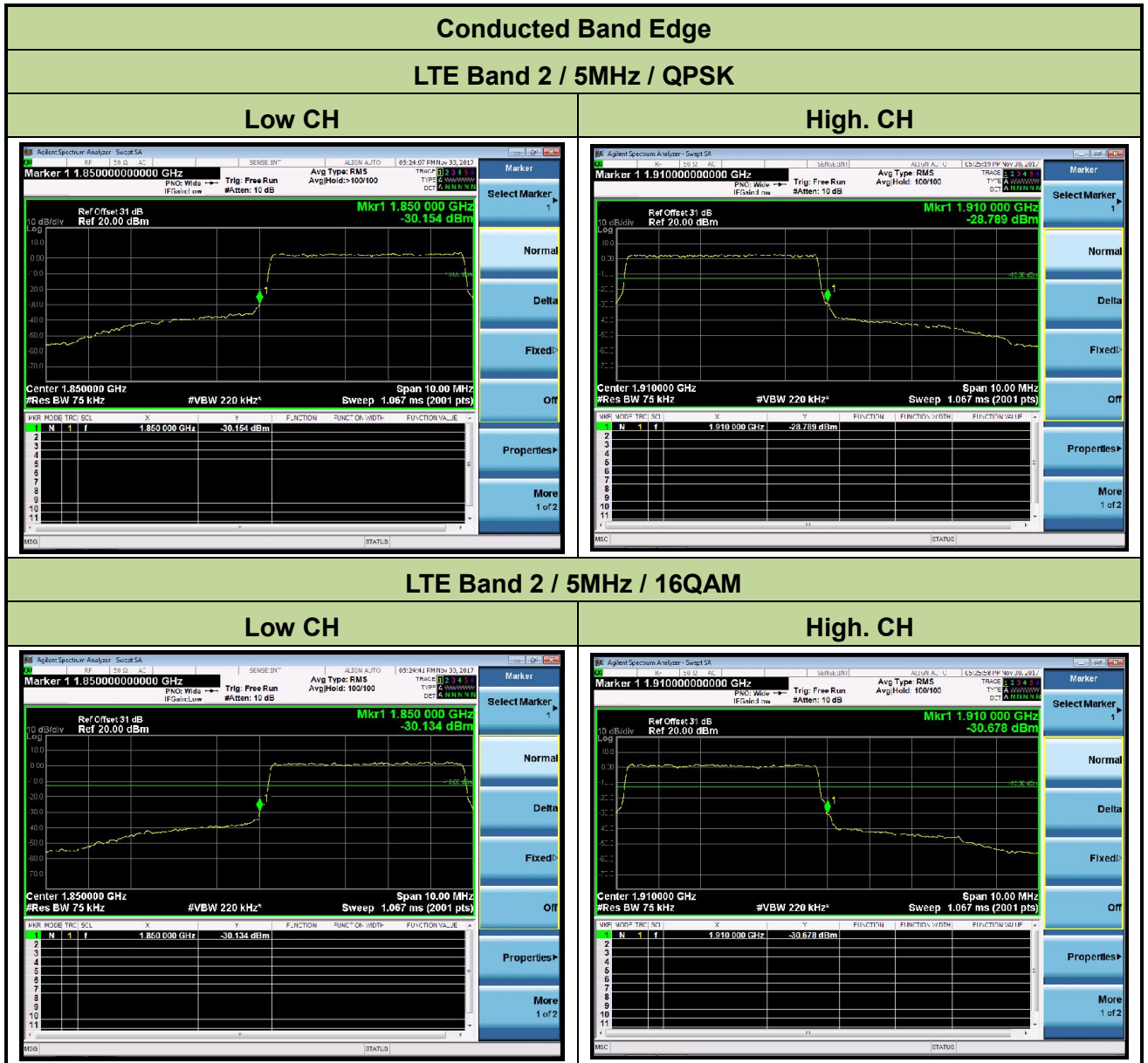

Conducted Band Edge

LTE Band 2 / 10MHz / QPSK



LTE Band 2 / 10MHz / 16QAM

