



MEASUREMENT REPORT

FCC PART 22 & 24 & 27 GSM & WCDMA

FCC ID: 2AC6AC70

APPLICANT: Shenzhen Chainway Information Technology Co., Ltd.

Application Type: Certification

Product: Mobile Data Terminal

Model No.: C70

Brand Name: CHAINWAY

FCC Classification: PCS Licensed Transmitter Held to Ear (PCE)

FCC Rule Part(s): Part 2, Part 22 Subpart H, Part 24 Subpart E,
Part 27 Subpart L

Test Procedure(s): ANSI/TIA-603-E-2016, KDB 971168 D01v03,

Test Date: October 31 ~ December 13, 2017

Reviewed By : Kevin Guo
(Kevin Guo)

Approved By : Marlin Chen
(Marlin Chen)



The test results relate only to the samples tested.

This equipment has been shown to be capable of compliance with the applicable technical standards as indicated in the measurement report and was tested in accordance with the measurement procedures specified in §2.947. Test results reported herein relate only to the item(s) tested.

The test report shall not be reproduced except in full without the written approval of MRT Technology (Suzhou) Co., Ltd.

Revision History

Report No.	Version	Description	Issue Date	Note
1711RSU00106	Rev. 01	Initial report	12-30-2017	Valid

CONTENTS

Description	Page
§2.1033 General Information	5
1. INTRODUCTION	6
1.1. Scope	6
1.2. MRT Test Location	6
2. PRODUCT INFORMATION	7
2.1. Equipment Description.....	7
2.2. Product Specification Subjective to this Report.....	7
2.3. Description of Available Antennas	8
2.4. Device Capabilities	8
2.5. Test Configuration	9
2.6. EMI Suppression Device(s)/Modifications.....	9
2.7. Labeling Requirements.....	9
3. DESCRIPTION OF TEST	10
3.1. Evaluation Procedure	10
3.2. Occupied Bandwidth.....	10
3.3. Spurious and Harmonic Emissions at Antenna Terminal.....	10
3.4. Radiated Power and Radiated Spurious Emissions	11
3.5. Peak-Average Ratio.....	12
3.6. Frequency Stability / Temperature Variation	12
4. TEST EQUIPMENT CALIBRATION DATE	13
5. SAMPLE CALCULATIONS	14
6. MEASUREMENT UNCERTAINTY	15
7. TEST RESULT	16
7.1. Summary	16
7.2. Occupied Bandwidth	18
7.2.1. Test Limit	18
7.2.2. Test Procedure used.....	18
7.2.3. Test Setting.....	18
7.2.4. Test Setup.....	18
7.2.5. Test Result.....	19
7.3. Spurious and Harmonic Emissions at Antenna Terminal.....	27
7.3.1. Test Limit	27

7.3.2. Test Procedure Used	27
7.3.3. Test Setting.....	27
7.3.4. Test Setup.....	27
7.3.5. Test Result.....	28
7.4. Conducted & Radiated Power and Radiated Spurious Emissions.....	36
7.4.1. Test Limit	36
7.4.2. Test Procedure Used	36
7.4.3. Test Setting.....	36
7.4.4. Test Setup.....	38
7.4.5. Test Result.....	39
7.5. Peak-Average Ratio.....	50
7.5.1. Test Limit	50
7.5.2. Test Procedure	50
7.5.3. Test Setup.....	50
7.5.4. Test Result.....	51
7.6. Frequency Stability Under Temperature & Voltage Variations.....	54
7.6.1. Test Limit	54
7.6.2. Test Procedure	54
7.6.3. Test Setup.....	54
7.6.4. Test Result.....	55
8. CONCLUSION.....	62

§2.1033 General Information

Applicant:	Shenzhen Chainway Information Technology Co., Ltd.
Applicant Address:	9/F, Building 2, Daqian Industrial Park, Longchang Rd., District 67, Bao'an, Shenzhen, China
Manufacturer:	Shenzhen Chainway Information Technology Co., Ltd.
Manufacturer Address:	9/F, Building 2, Daqian Industrial Park, Longchang Rd., District 67, Bao'an, Shenzhen, China
Test Site:	MRT Technology (Suzhou) Co., Ltd
Test Site Address:	D8 Building, Youxin Industrial Park, No.2 Tian'edang Rd., Wuzhong Economic Development Zone, Suzhou, China
MRT Registration No.:	893164
MRT designation No.:	CN1166
Test Device Serial No.:	N/A <input type="checkbox"/> Production <input checked="" type="checkbox"/> Pre-Production <input type="checkbox"/> Engineering

Test Facility / Accreditations

Measurements were performed at MRT Laboratory located in Tian'edang Rd., Suzhou, China.

- MRT facility is a FCC registered (MRT Reg. No. 893164) test facility with the site description report on file and has met all the requirements specified in Section 2.948 of the FCC Rules.
- MRT facility is an IC registered (MRT Reg. No. 11384A-1) test laboratory with the site description on file at Industry Canada.
- MRT facility is a VCCI registered (R-20025, G-20034, C-20020, T-20020) test laboratory with the site description on file at VCCI Council.
- MRT Lab is accredited to ISO 17025 by the American Association for Laboratory Accreditation (A2LA) under the American Association for Laboratory Accreditation Program (A2LA Cert. No. 3628.01) in EMC, Telecommunications and Radio testing for FCC, Industry Canada, EU and TELEC Rules.



1. INTRODUCTION

1.1. Scope

Measurement and determination of electromagnetic emissions (EMC) of radio frequency devices including intentional and/or unintentional radiators for compliance with the technical rules and regulations of the Federal Communications Commission and the Industry Canada Certification and Engineering Bureau.

1.2. MRT Test Location

The map below shows the location of the MRT LABORATORY, its proximity to the Taihu Lake. These measurement tests were conducted at the MRT Technology (Suzhou) Co., Ltd. Facility located at D8 Building, No.2 Tian'edang Rd., Wuzhong Economic Development Zone, Suzhou, China. The detailed description of the measurement facility was found to be in compliance with the requirements of § 2.948 according to ANSI C63.4-2009 on September 30, 2013.



2. PRODUCT INFORMATION

2.1. Equipment Description

Product Name:	Mobile Data Terminal
Model No.:	C70
Brand Name:	CHAINWAY
Hardware Version:	C70SEA_mb_v12
Software Version:	C70A_MT6735_V1.2_AM_GIT55c9324_20171104
Wi-Fi Specification:	802.11a/b/g/n
Bluetooth Version	V4.0 single mode
GSM Operation Band (s):	GSM 850 / 900 / 1800 / 1900
WCDMA Operation Band (s):	Band II / IV / V
LTE Operation Band (s):	FDD Band 2 / 4 / 7 / 12 / 17
NFC:	13.56MHz
GPS:	1575.42MHz
Components	
Adapter	Model No.: GME 10D-050200FUu Input Power: 100 - 240V ~ 50/60Hz, Max. 0.28A Output Power: 5VDC 2.0A

2.2. Product Specification Subjective to this Report

T _x Frequency Range	GSM850: 824.2 ~ 848.8MHz, PCS1900: 1850.2 ~ 1909.8MHz WCDMA Band II: 1852.4 ~ 1907.6MHz WCDMA Band IV: 1712.4 ~ 1752.6MHz WCDMA Band V: 826.4 ~ 846.6MHz
R _x Frequency Range	GSM850: 869.2 ~ 893.8MHz, PCS1900: 1930.2 ~ 1989.8MHz WCDMA Band II: 1852.4 ~ 1907.6MHz WCDMA Band IV: 1712.4 ~ 1752.6MHz WCDMA Band V: 826.4 ~ 846.6MHz
Type of Modulation	GSM / GPRS: GMSK EDGE: 8PSK WCDMA: QPSK

Note: For other features of this EUT, test report will be issued separately.

2.3. Description of Available Antennas

Antenna Type	Frequency Band	Max Peak Gain (dBi)
GPS Internal Antenna		
PIFA	1575.42MHz	0.92
2G Internal Antenna		
PIFA	GSM850	-1.00
	GSM1900	-0.40
3G Internal Antenna		
PIFA	WCDMA Band II	0.45
	WCDMA Band IV	-0.70
	WCDMA Band V	-1.15
4G Internal Antenna		
PIFA	FDD-LTE Band 2	0.50
	FDD-LTE Band 4	0.51
	FDD-LTE Band 7	-0.78
	FDD-LTE Band 12	-0.47
	FDD-LTE Band 17	-0.92
Wi-Fi Internal Antenna		
PIFA	2400 ~ 2483.5MHz	0.58
	5150 ~ 5250MHz	0.70
	5250 ~ 5350MHz	0.71
	5725 ~ 5850MHz	0.72
Bluetooth Internal Antenna		
PIFA	2400 ~ 2483.5MHz	0.58
NFC Internal Antenna		
PIFA	13.56MHz	1.20

2.4. Device Capabilities

This device contains the following capabilities:

GSM 850/1900 WCDMA Band II/IV/V, LTE FDD Band 2/4/7/12/17, 2.4GHz WLAN (DTS), 5GHz WLAN (UNII), Bluetooth (v4.0 single mode), NFC.

2.5. Test Configuration

The **Mobile Data Terminal** was tested per the guidance of ANSI/TIA-603-E-2016 and KDB 971168 D01v03. See section 3.0 of this report for a description of the radiated and antenna port conducted emissions tests.

2.6. EMI Suppression Device(s)/Modifications

No EMI suppression device(s) were added and no modifications were made during testing.

2.7. Labeling Requirements

Per 2.1074 & 15.19; Docket 95-19

The label shall be permanently affixed at a conspicuous location on the device; instruction manual or pamphlet supplied to the user and be readily visible to the purchaser at the time of purchase. However, when the device is so small wherein placement of the label with specified statement is not practical, only the FCC ID must be displayed on the device per Section 15.19(a)(5). Please see attachment for FCC ID label and label location.

3. DESCRIPTION OF TEST

3.1. Evaluation Procedure

The measurement procedures described in the “Land Mobile FM or PM - Communications Equipment - Measurements and Performance Standards” (ANSI/TIA-603-E-2016) and “Procedures for Compliance Measurement of the Fundamental Emission Power of Licensed Wideband (> 1 MHz) Digital Transmission Systems” (KDB 971168) were used in the measurement of the **Mobile Data Terminal**.

Deviation from measurement procedure.....None

3.2. Occupied Bandwidth

§2.1049

The occupied bandwidth, that is the frequency bandwidth such that, below its lower and above its upper frequency limits, the mean powers radiated are each equal to 0.5 percent of the total mean power radiated by a given emission shall be measured. The spectrum analyzers’ “occupied bandwidth” measurement function was used to record the occupied bandwidth in accordance with KDB 971168.

3.3. Spurious and Harmonic Emissions at Antenna Terminal

§2.1051 §22.917(a) §24.238(a) §27.53(h)

The level of the carrier and the various conducted spurious and harmonic frequencies is measured by means of a calibrated spectrum analyzer. The spectrum is scanned from the lowest frequency generated in the equipment up to a frequency including its 10th harmonic. On any frequency outside a licensee’s frequency block, the power of any emission shall be attenuated below the transmitter power (P) by at least $43 + 10 \log(P)$ dB. Compliance with these provisions is based on the use of measurement instrumentation employing a resolution bandwidth of 100 kHz or greater for Part 22 and 1 MHz or greater for Part 24 and Part 27L. However, in the 1 MHz bands immediately outside and adjacent to the frequency block a resolution bandwidth of at least one percent of the emission bandwidth of the fundamental emission of the transmitter may be employed. The emission bandwidth is defined as the width of the signal between two points, one below the carrier center frequency and one above the carrier center frequency, outside of which all emission are attenuated at least 26 dB below the transmitter power.

3.4. Radiated Power and Radiated Spurious Emissions

§2.1053 §22.913(a.2) §22.917(a) §24.232(c) §24.238(a) &27.50(d.4) &27.53(h)

The radiated test facilities consisted of an indoor 3 meter semi-anechoic chamber used for final measurement and exploratory measurements, when necessary. The measurement area is contained within the semi-anechoic chamber which is shielded from any ambient interference. For measurements above 1GHz absorbers are arranged on the floor between the turn table and the antenna mast in such a way so as to maximize the reduction of reflections. For measurements below 1GHz, the absorbers are removed. A MF Model 210SS turntable is used for radiated measurement. It is a continuously rotatable, remote-controlled, metallic turntable and 2 meters (6.56 ft.) in diameter. The turn table is flush with the raised floor of the chamber in order to maintain its function as a ground plane. A 80cm high PVC support structure is placed on top of the turntable.

The equipment under test was transmitting while connected to its integral antenna and is placed on a wooden turntable 80cm above the ground plane and 3 meters from the receive antenna. The receive antenna height is adjusted between 1 and 4 meter height, the turntable is rotated through 360 degrees, and the EUT is manipulated through all orthogonal planes representative of its typical use to achieve the highest reading on the receive spectrum analyzer. Radiated power levels are also investigated with the receive antenna horizontally and vertically polarized. The maximized power level is recorded using the spectrum analyzer “Channel Power” function with the integration band set to the emissions’ occupied bandwidth, a RMS detector, RBW = 100kHz, VBW = 300kHz, and a 1 second sweep time over a minimum of 10 sweeps, per the guidelines of KDB 971168.

Per the guidance of ANSI/TIA-603-E-2016, a half-wave dipole is then substituted in place of the EUT. For emissions above 1GHz, a horn antenna is substituted in place of the EUT. The substitute antenna is driven by a signal generator with the level of the signal generator being adjusted to obtain the same receive spectrum analyzer level previously recorded from the spurious emission from the EUT. The power of the emission is calculated using the following formula:

$$P_d \text{ [dBm]} = P_g \text{ [dBm]} - \text{cable loss [dB]} + \text{antenna gain [dBd/dBi]}$$

Where, P_d is the dipole equivalent power, P_g is the generator output into the substitution antenna, and the antenna gain is the gain of the substitute antenna used relative to either a half-wave dipole (dBd) or an isotropic source (dBi). The substitute level is equal to $P_g \text{ [dBm]} - \text{cable loss [dB]}$.

The calculated P_d levels are then compared to the absolute spurious emission limit of -13dBm which is equivalent to the required minimum attenuation of $43 + 10 \cdot \log_{10}(\text{Power [Watts]})$ specified in 22.917(a) and 24.238(a) and 27.53(h).

3.5. Peak-Average Ratio

§24.232(d)

A peak to average ratio measurement is performed at the conducted port of the EUT. The spectrum analyzers Complementary Cumulative Distribution Function (CCDF) measurement profile is used to determine the largest deviation between the average and the peak power of the EUT in a given bandwidth. The CCDF curve shows how much time the peak waveform spends at or above a given average power level. The percent of time the signal spends at or above the level defines the probability for that particular power level.

For pulsed signals, the spectrum analyzer is set to use an internal “RF Burst” trigger that is synced with an incoming pulse and the measurement interval is set to less than the duration of the “on time” of one burst to ensure that energy is only captured during a time in which the transmitter is operating at maximum power. For continuous signals, the trigger is set to “free run” in the CCDF measurement mode.

3.6. Frequency Stability / Temperature Variation

§2.1055 §22.355 §22.863 §22.905 §24.229 §24.235 & 27.54

Frequency stability testing is performed in accordance with the guidelines of ANSI/TIA-603-E-2016. The frequency stability of the transmitter is measured by:

- a.) Temperature: The temperature is varied from -30°C to +50°C in 10°C increments using an environmental chamber.
- b.) Primary Supply Voltage: The primary supply voltage is varied from 85% to 115% of the nominal value for non hand-carried battery and AC powered equipment. For hand-carried, battery-powered equipment, primary supply voltage is reduced to the battery operating end point which shall be specified by the manufacturer.

Specification – For Part 22, the frequency stability of the transmitter shall be maintained within $\pm 0.00025\%$ (± 2.5 ppm) of the center frequency. For Part 24 and Part 27L, the frequency stability shall be sufficient to ensure that the fundamental emission stays within the authorized frequency block.

Time Period and Procedure:

1. The carrier frequency of the transmitter is measured at room temperature (20°C to provide a reference).
2. The equipment is turned on in a “standby” condition for fifteen minutes before applying power to the transmitter. Measurement of the carrier frequency of the transmitter is made within one minute after applying power to the transmitter.
3. Frequency measurements are made at 10°C intervals ranging from -30°C to +50°C. A period of at least one half-hour is provided to allow stabilization of the equipment at each temperature level.

4. TEST EQUIPMENT CALIBRATION DATE

Radiated Emissions - AC2

Instrument	Manufacturer	Type No.	Asset No.	Cali. Interval	Cali. Due Date
Spectrum Analyzer	Agilent	N9038A	MRTSUE06125	1 year	2018/08/18
EMI Test Receiver	R&S	ESR7	MRTSUE06001	1 year	2018/08/18
Radio Communication Tester	R&S	CMU 200	MRTSUE06009	1 year	2018/10/27
Wideband Radio Communication Tester	R&S	CMW 500	MRTSUE06243	1 year	2018/02/14
Preamplifier	Schwarzbeck	BBV 9721	MRTSUE06121	1 year	2018/04/15
Loop Antenna	Schwarzbeck	FMZB1519	MRTSUE06025	1 year	2018/11/21
Bilog Period Antenna	Schwarzbeck	VULB9162	MRTSUE06022	1 year	2018/10/21
Broad Band Horn Antenna	Schwarzbeck	BBHA 9120D	MRTSUE06171	1 year	2018/11/18
Broadband Horn Antenna	Schwarzbeck	BBHA9170	MRTSUE06024	1 year	2018/01/04
Digital Thermometer & Hygrometer	Minggao	ETH529	MRTSUE06170	1 year	2018/12/12
Anechoic Chamber	RIKEN	Chamber-AC2	MRTSUE06213	1 year	2018/05/10

Conducted Test Equipment - TR3

Instrument	Manufacturer	Type No.	Asset No.	Cali. Interval	Cali. Due Date
Spectrum Analyzer	Agilent	N9020A	MRTSUE06106	1 year	2018/04/25
Radio Communication Tester	R&S	CMU 200	MRTSUE06009	1 year	2018/10/27
Wideband Radio Communication Tester	R&S	CMW 500	MRTSUE06243	1 year	2018/02/14
DC Power Supply	GWINSTEK	DPS-3303C	MRTSUE06064	N/A	N/A
Temperature Humidity Chamber	BAOYT	BYH-150CL	MRTSUE06051	1 year	2018/12/06
Thermohygrometer	Testo	608-H1	MRTSUE06401	1 year	2018/08/14

Software	Version	Function
e3	V8.3.5	EMI Test Software

5. SAMPLE CALCULATIONS

GSM Emission Designator

Emission Designator = 250KGXW

GSM BW = 250 kHz

G = Phase Modulation

X = Cases not otherwise covered

W = Combination (Audio/Data)

EDGE Emission Designator

Emission Designator = 250KG7W

GSM BW = 250 kHz

G = Phase Modulation

7 = Quantized/Digital Info

W = Combination (Audio/Data)

WCDMA Emission Designator

Emission Designator = 4M16F9W

WCDMA BW = 4.16 MHz

F = Frequency Modulation

9 = Composite Digital Info

W = Combination (Audio/Data) (Measured at the 99.75% power bandwidth)

Spurious Radiated Emission

Example: Spurious emission at 3700.40 MHz

The receive spectrum analyzer reading at 3 meters with the EUT on the turntable was -81.0dBm .

The gain of the substituted antenna is 8.1dBi . The signal generator connected to the substituted antenna terminals is adjusted to produce a reading of -81.0dBm on the spectrum analyzer. The loss of the cable between the signal generator and the terminals of the substituted antenna is 2.0dB at 3700.40MHz . So 6.1dB is added to the signal generator reading of -30.9dBm yielding -24.80dBm . The fundamental EIRP was 25.50dBm so this harmonic was $25.50\text{dBm} - (-24.80) = 50.3\text{dBc}$.

6. MEASUREMENT UNCERTAINTY

Where relevant, the following test uncertainty levels have been estimated for tests performed on the EUT as specified in CISPR 16-4-2. This uncertainty represents an expanded uncertainty expressed at approximately the 95% confidence level using a coverage factor of $k = 2$.

AC Conducted Emission Measurement - SR2
Measuring Uncertainty for a Level of Confidence of 95% ($U=2Uc(y)$): 150kHz~30MHz: 3.46dB
Radiated Emission Measurement - AC2
Measuring Uncertainty for a Level of Confidence of 95% ($U=2Uc(y)$): 9kHz ~ 1GHz: 4.18dB 1GHz ~ 25GHz: 4.76dB
Occupied Bandwidth - TR3
Measuring Uncertainty for a Level of Confidence of 95% ($U=2Uc(y)$): 0.28%
Spurious Emissions, Conducted - TR3
Measuring Uncertainty for a Level of Confidence of 95% ($U=2Uc(y)$): 0.78dB
Output Power - TR3
Measuring Uncertainty for a Level of Confidence of 95% ($U=2Uc(y)$): 1.13dB

7. TEST RESULT

7.1. Summary

Company Name: Shenzhen Chainway Information Technology Co., Ltd.
FCC ID: 2AC6AC70
FCC Classification: PCS Licensed Transmitter Held to Ear (PCE)
Mode(s): GSM / WCDMA

FCC Part Section(s)	Test Description	Test Limit	Test Condition	Test Result	Reference
2.1049	Occupied bandwidth	N/A	Conducted	Pass	Section 7.2
2.1051 22.917(a) 24.238(a) 27.53(h)	Band Edge / Conducted Spurious Emissions	$> 43 + \log_{10}(P[\text{Watts}])$ at Band Edge and for all out-of-band emissions		Pass	Section 7.3
24.232(d)	Peak-Average Ratio	$< 13 \text{ dB}$		Pass	Section 7.5
2.1046	Transmitter Conducted Output Power	N/A		Pass	Section 7.4
22.913(a.2)	Effective Radiated Power	$< 7 \text{ Watts max. ERP}$		Pass	Section 7.4
24.232(c)	Equivalent Isotropic Radiated Power	$< 2 \text{ Watts max. EIRP}$	Radiated	Pass	Section 7.4
27.50(d.4)	Equivalent Isotropic Radiated Power	$< 1 \text{ Watts max. EIRP}$		Pass	Section 7.4
2.1053 22.917(a) 24.238(a) 27.53(h)	Undesirable Emissions	$> 43 + \log_{10}(P[\text{Watts}])$ for all out-of-band emissions		Pass	Section 7.4
2.1055 22.355 24.235 27.54	Frequency Stability	$< 2.5 \text{ ppm (Part 22)}$ Emission must remain in band (Part 24 and Part 27L)	Conducted	Pass	Section 7.6

Notes:

- 1) All modes of operation and data rates were investigated. The test results shown in the following sections represent the worst case emissions.
- 2) The analyzer plots shown in Section 4.0 were all taken with a correction table loaded into the analyzer. The correction table was used to account for the losses of the cables, directional couplers, and

attenuators used as part of the system to maintain a link between the call box and the EUT at all frequencies of interest.

- 3) All antenna port conducted emissions testing was performed on a test bench with the antenna port of the EUT connected to the spectrum analyzer through calibrated cables, attenuators, and couplers.

7.2. Occupied Bandwidth

7.2.1. Test Limit

N/A

7.2.2. Test Procedure used

KDB 971168 D01v03 - Section 4.3 & ANSI/TIA-603-E-2016

7.2.3. Test Setting

1. The spectrum analyzer center frequency is set to the nominal EUT channel center frequency.
Set span $\geq 1.5 \times \text{OBW}$.
2. The nominal IF filter 3 dB bandwidth (RBW) shall be in the range of 1% to 5% of the anticipated OBW, and the VBW shall be set $\geq 3 \times \text{RBW}$.
3. Set the reference level of the instrument as required to prevent the signal amplitude from exceeding the maximum spectrum analyzer input mixer level for linear operation.
4. Set the detection mode to peak, and the trace mode to max-hold.

7.2.4. Test Setup

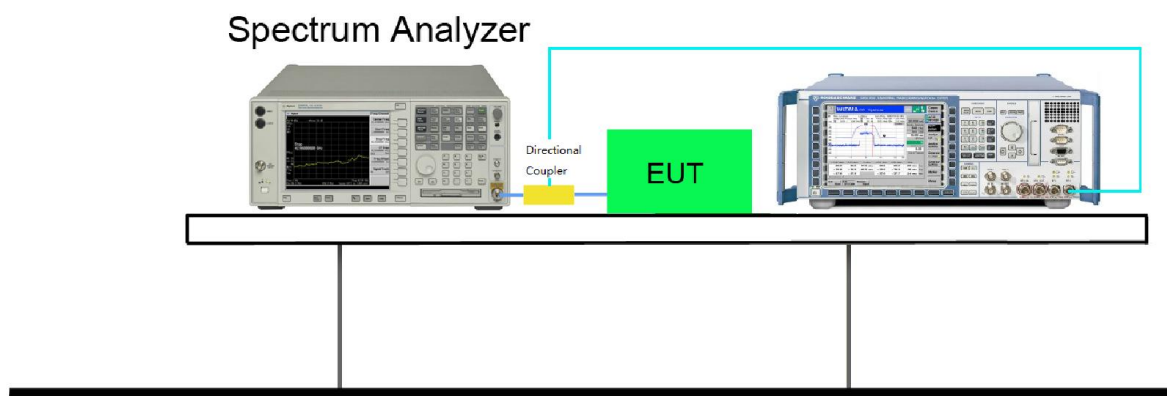

7.2.5. Test Result

Product	Mobile Data Terminal	Temperature	25°C
Test Engineer	Milo Li	Relative Humidity	52%
Test Site	TR3	Test Date	2017/11/14

Test Mode	Channel No.	Frequency (MHz)	99% Occupied Bandwidth (kHz)	-26dB Occupied Bandwidth (kHz)	Result
GSM850	128	824.2	244.1	317.7	Pass
	189	836.4	246.1	317.2	Pass
	251	848.8	244.9	314.3	Pass
PCS1900	512	1850.2	245.8	316.6	Pass
	661	1880.0	244.9	317.0	Pass
	810	1909.8	244.4	318.7	Pass
EDGE850	128	824.2	244.2	315.5	Pass
	189	836.4	245.7	318.2	Pass
	251	848.8	245.6	318.3	Pass
EDGE1900	512	1850.2	245.2	314.9	Pass
	661	1880.0	245.7	312.9	Pass
	810	1909.8	244.5	315.4	Pass
WCDMA Band II	9262	1852.4	4230.8	4887.0	Pass
	9400	1880.0	4231.4	4925.0	Pass
	9538	1907.6	4240.5	4914.0	Pass
WCDMA Band IV	1312	1712.4	4204.9	4831.0	Pass
	1413	1732.6	4221.5	4840.0	Pass
	1513	1752.6	4205.7	4821.0	Pass
WCDMA Band V	4132	826.4	4214.7	4846.0	Pass
	4182	836.4	4226.4	4833.0	Pass
	4233	846.6	4215.7	4845.0	Pass

GSM850 Occupied Bandwidth

Channel 128 (824.2MHz)

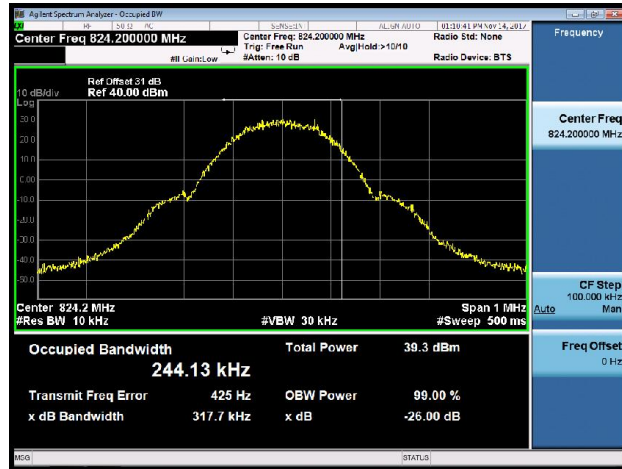

Channel 189 (836.4MHz)

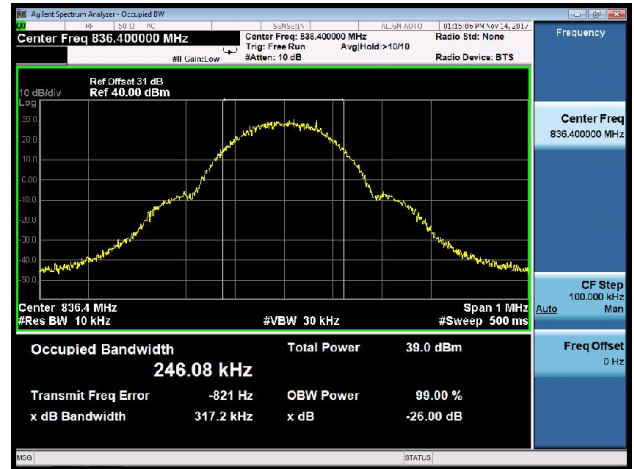

Channel 251 (848.8MHz)

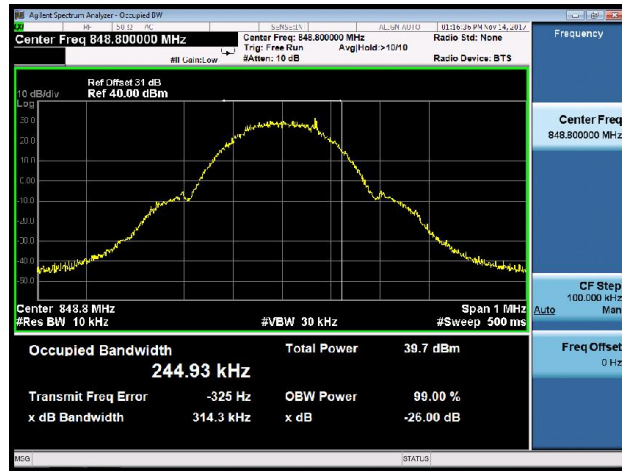

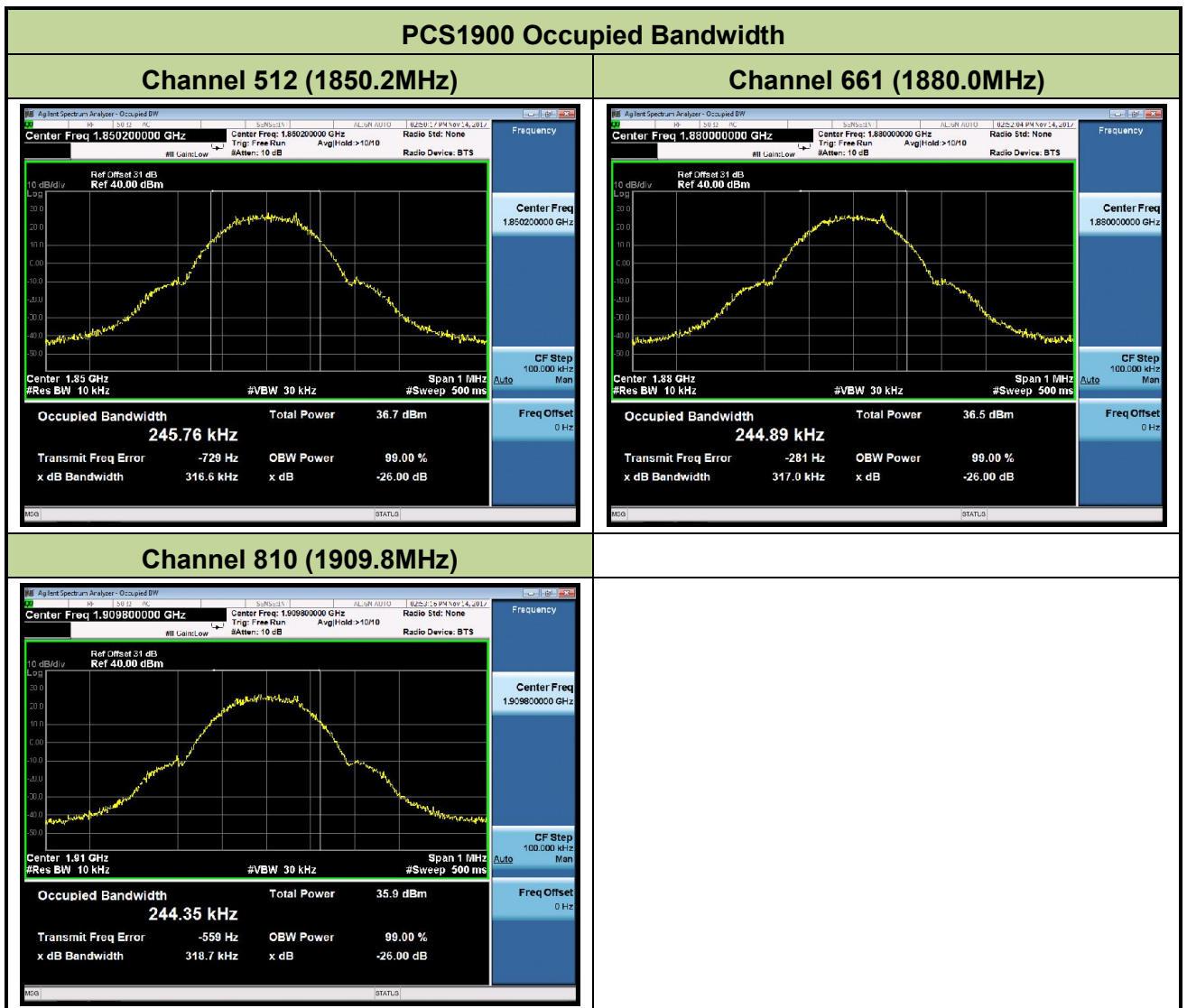

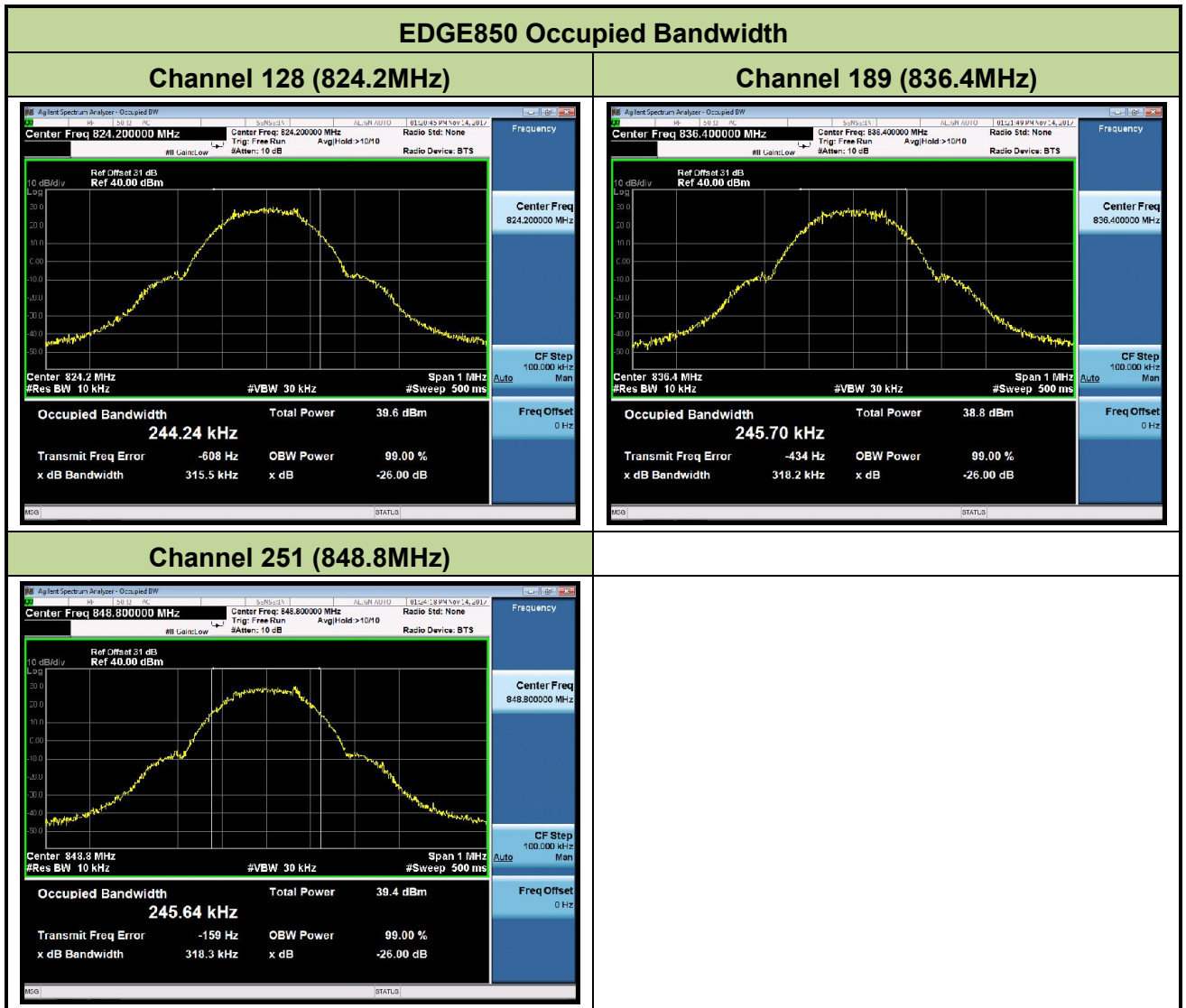

EDGE1900 Occupied Bandwidth

Channel 512 (1850.2MHz)



Channel 661 (1880.0MHz)

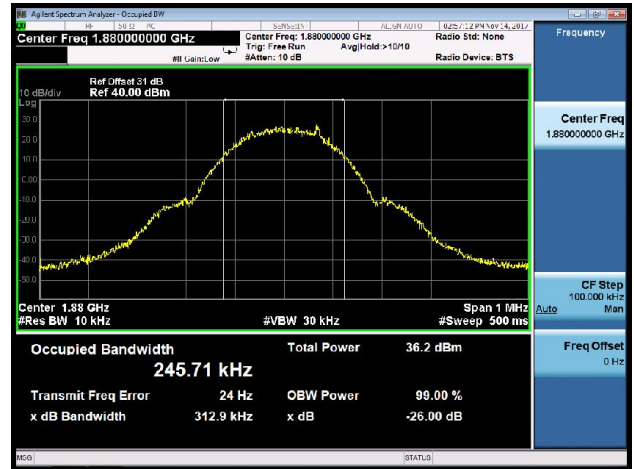

Channel 810 (1909.8MHz)

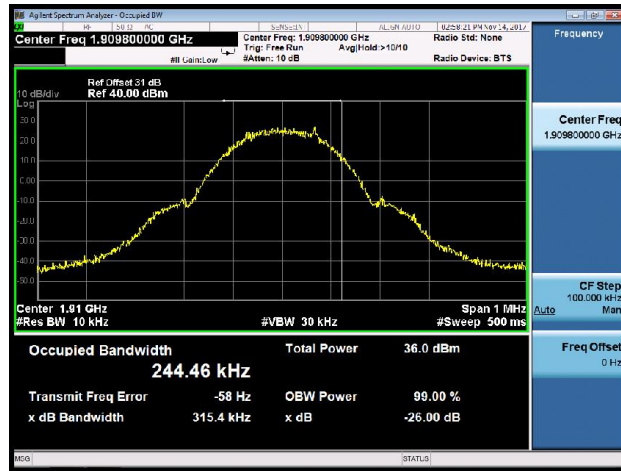

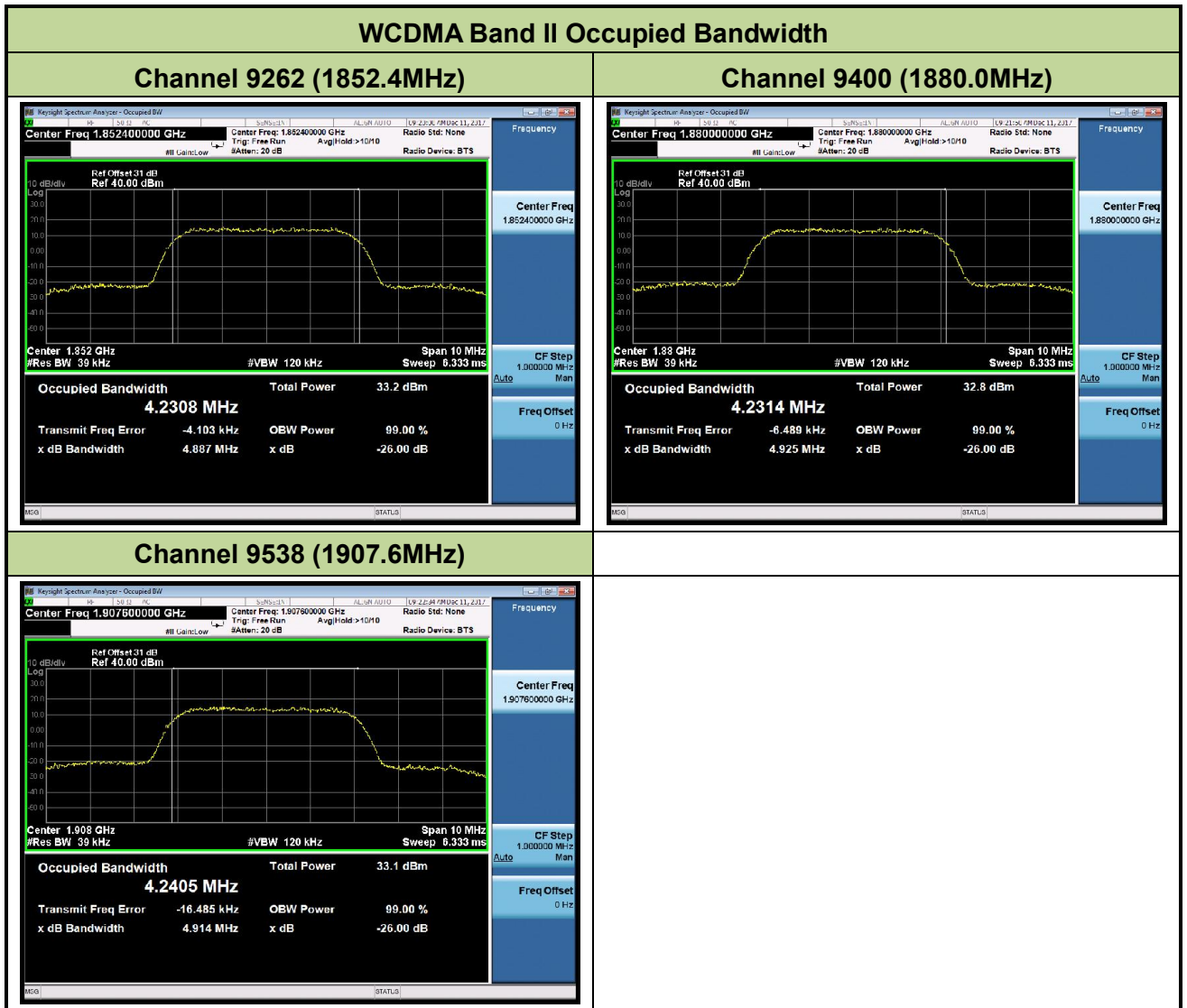

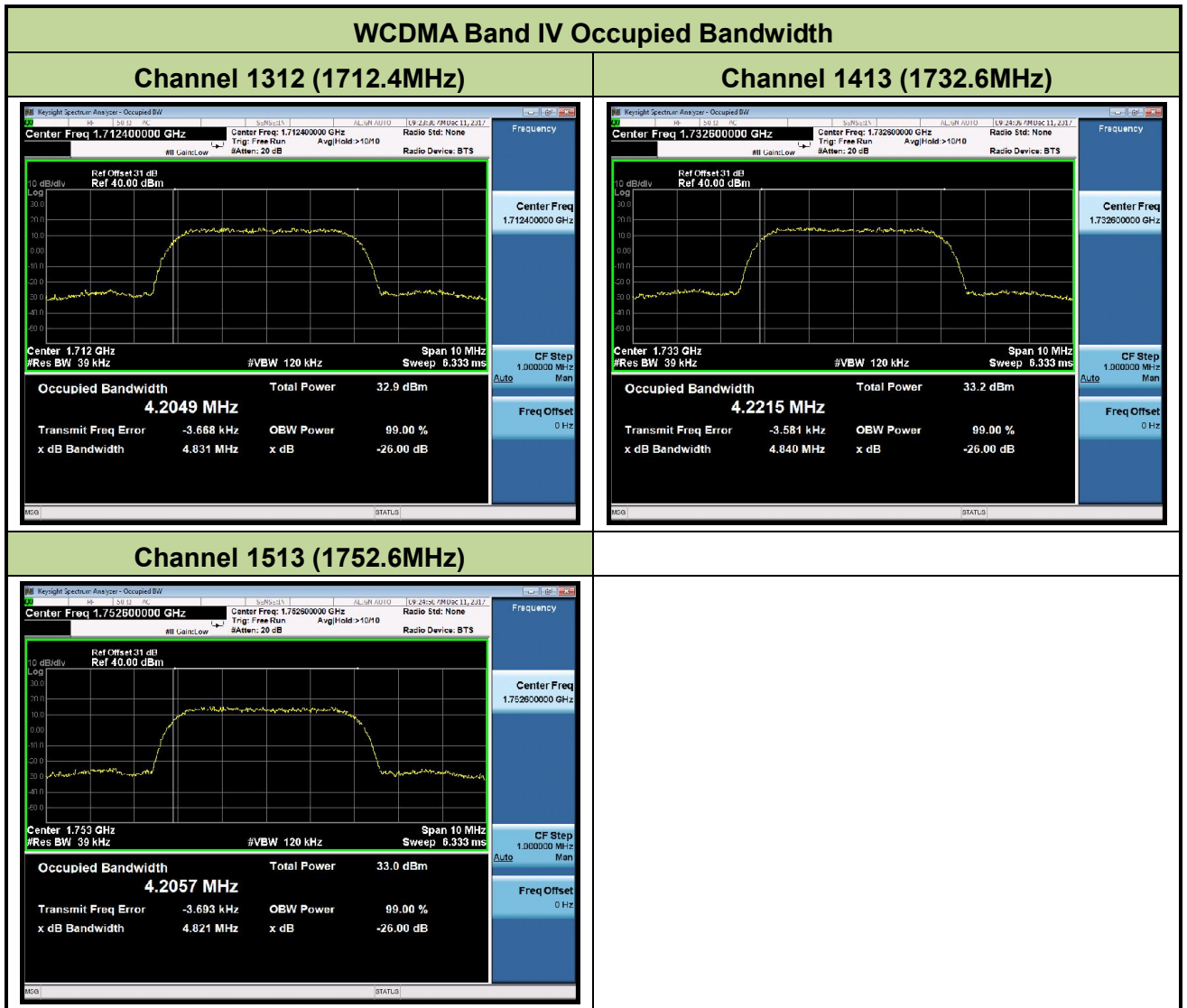

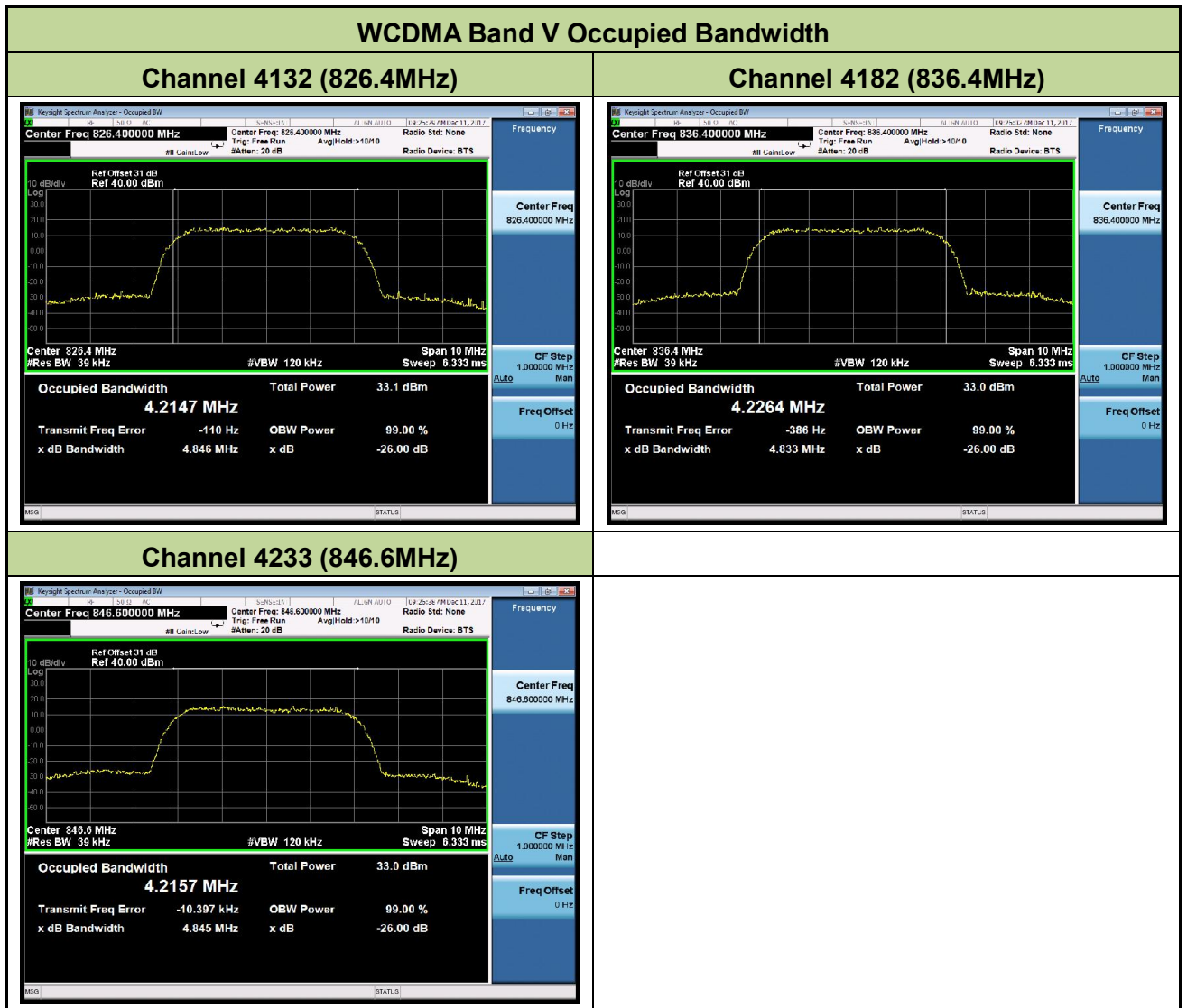

7.3. Spurious and Harmonic Emissions at Antenna Terminal

7.3.1. Test Limit

The power of any emission outside of the authorized operating frequency ranges must be attenuated below the transmitting power (P) by a factor of at least $43 + 10\log(P)$ dB.

7.3.2. Test Procedure Used

KDB 971168 D01v03 - Section 6.0 & ANSI/TIA-603-E-2016

7.3.3. Test Setting

In the 1MHz bands immediately outside and adjacent to the frequency block a resolution bandwidth of at least one percent of the emission bandwidth of the fundamental emission of the transmitter may be employed to measure the out of band Emissions.

7.3.4. Test Setup

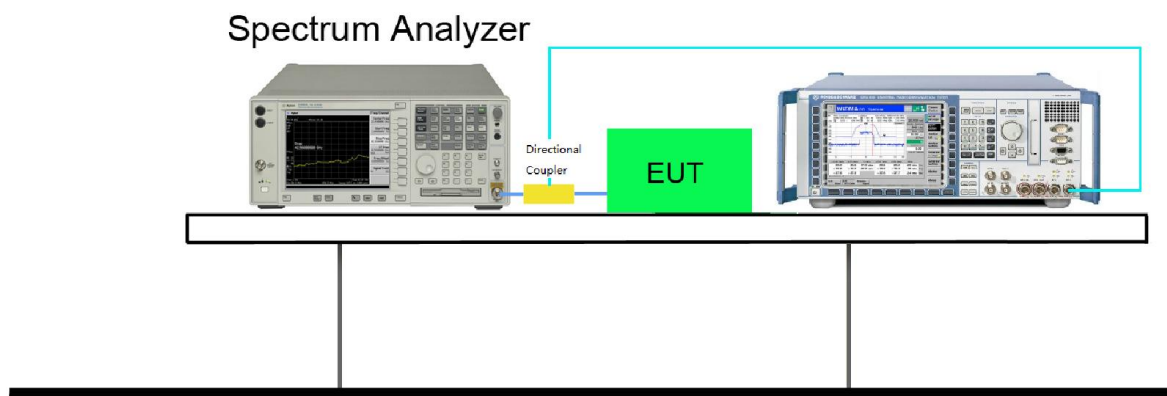

7.3.5. Test Result

Product	Mobile Data Terminal	Temperature	25°C
Test Engineer	Milo	Relative Humidity	52%
Test Site	TR3	Test Date	2017/12/11

Mode	Channel No.	Frequency (MHz)	Modulation	Test Result
GSM850	128	824.20	GMSK	Pass
GSM850	189	836.40	GMSK	Pass
GSM850	251	848.80	GMSK	Pass
PCS1900	512	1850.20	GMSK	Pass
PCS1900	661	1880.00	GMSK	Pass
PCS1900	810	1909.80	GMSK	Pass
EDGE850	128	824.20	8PSK	Pass
EDGE850	189	836.40	8PSK	Pass
EDGE850	251	848.80	8PSK	Pass
EDGE1900	512	1850.20	8PSK	Pass
EDGE1900	661	1880.00	8PSK	Pass
EDGE1900	810	1909.80	8PSK	Pass
WCDMA Band II	9262	1852.4	QPSK	Pass
WCDMA Band II	9400	1880.0	QPSK	Pass
WCDMA Band II	9538	1907.6	QPSK	Pass
WCDMA Band IV	1312	1712.4	QPSK	Pass
WCDMA Band IV	1413	1732.6	QPSK	Pass
WCDMA Band IV	1513	1752.6	QPSK	Pass
WCDMA Band V	4132	826.40	QPSK	Pass
WCDMA Band V	4182	836.40	QPSK	Pass
WCDMA Band V	4233	846.60	QPSK	Pass

GSM850 Band Edge

Channel 128 (824.20MHz)

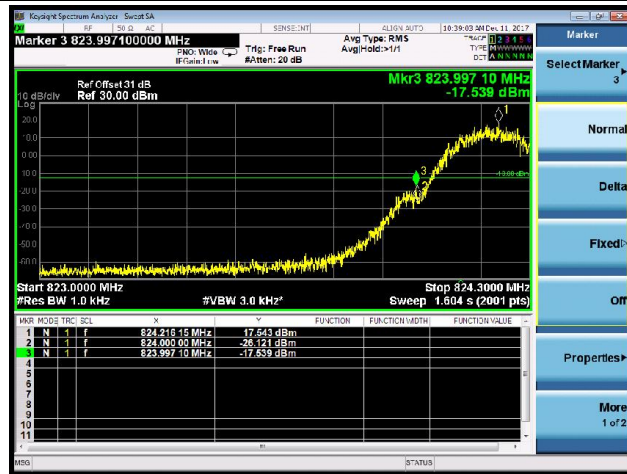

Channel 251 (848.80MHz)



GSM850 Conducted Spurious Emission

Channel 128 (824.20MHz)

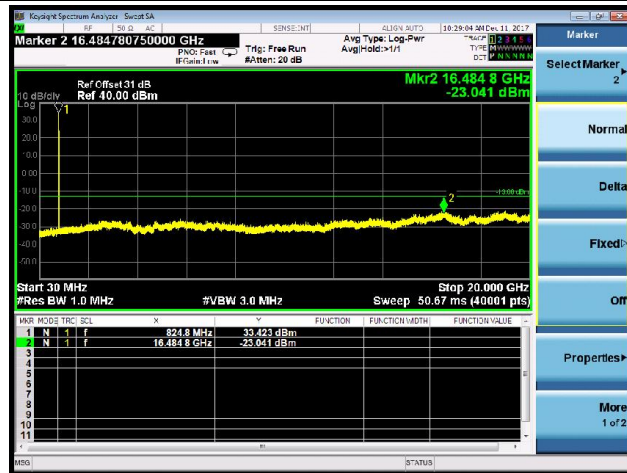

Channel 189 (836.40MHz)

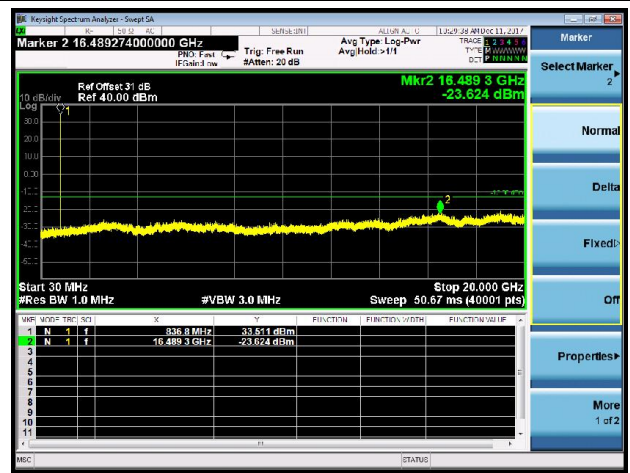

Channel 251 (848.80MHz)

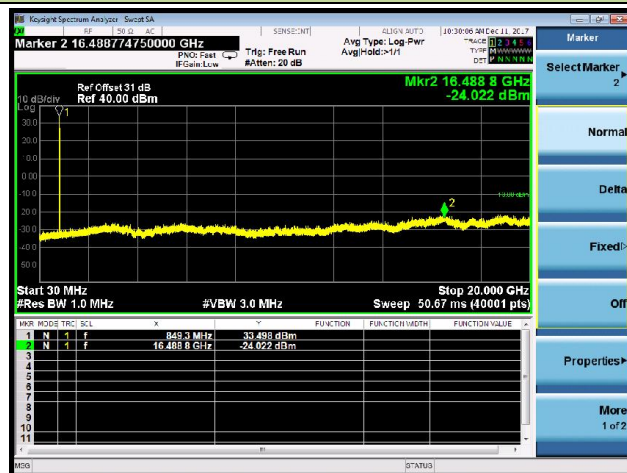

PCS1900 Band Edge

Channel 512 (1850.20MHz)

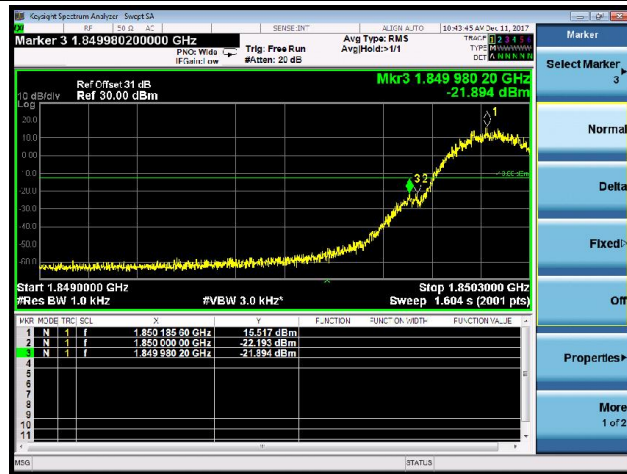

Channel 810 (1909.80MHz)

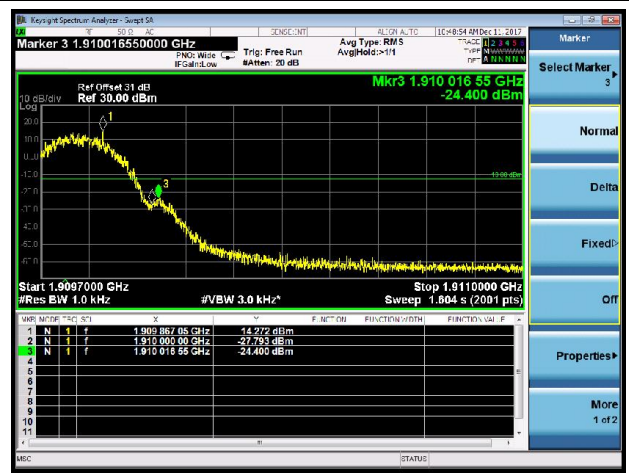

PCS1900 Conducted Spurious Emission

Channel 512 (1850.20MHz)

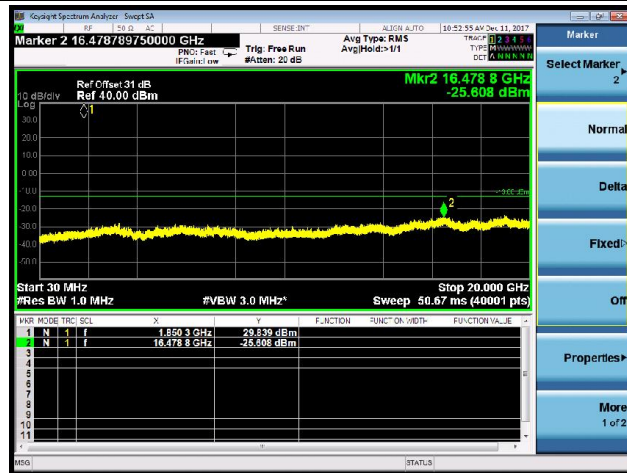

Channel 661 (1880.00MHz)

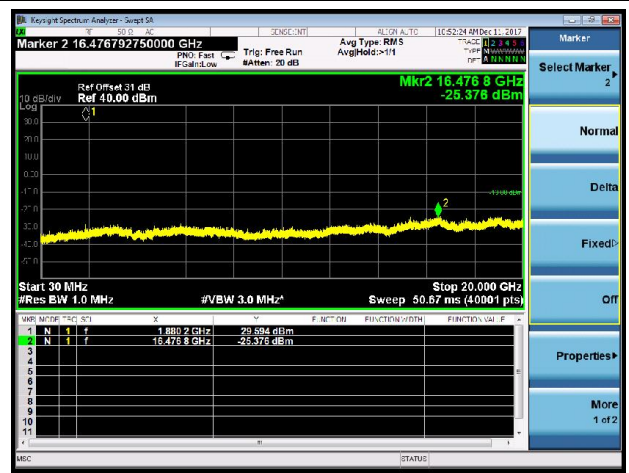

Channel 810 (1909.80MHz)

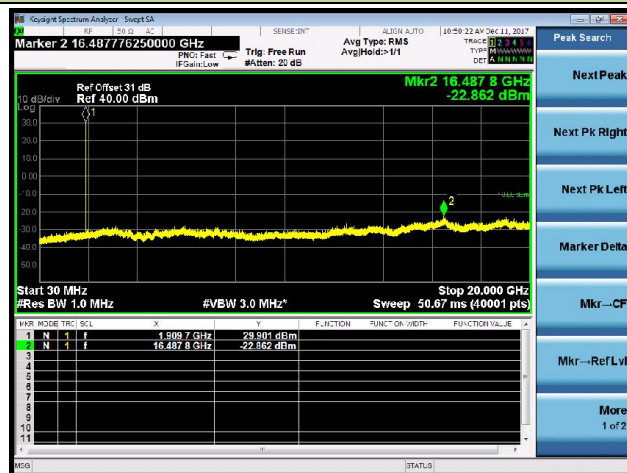

Peak Search:

- Next Peak
- Next Pk Right
- Next Pk Left
- Marker Delta
- Mkr--CF
- Mkr--RefLvl

EDGE850 Band Edge

Channel 128 (824.20MHz)

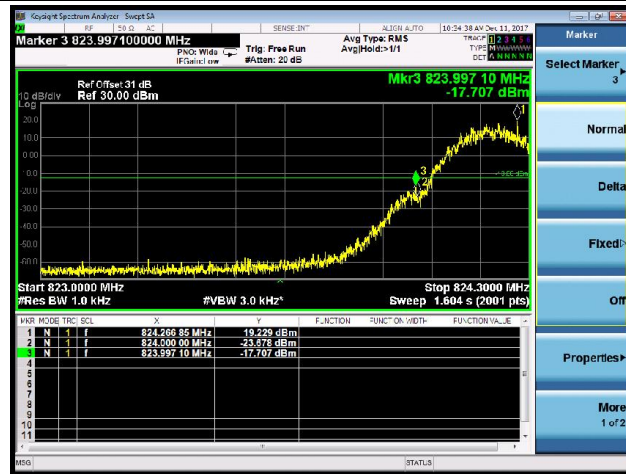

Channel 251 (848.80MHz)

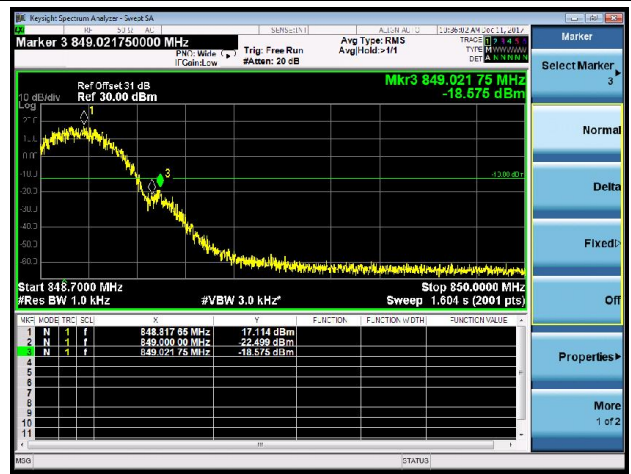

EDGE850 Conducted Spurious Emission

Channel 128 (824.20MHz)

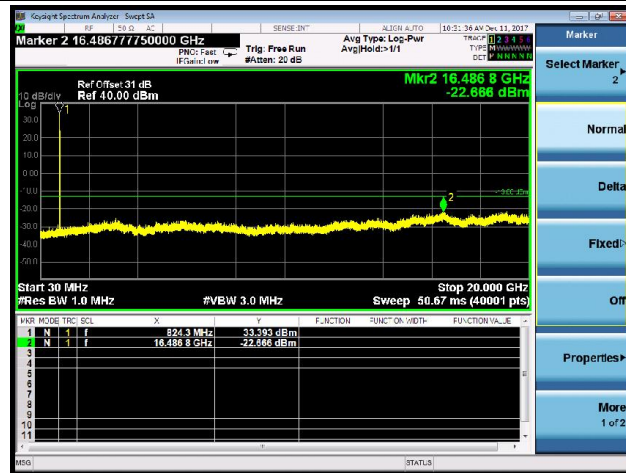

Channel 189 (836.40MHz)

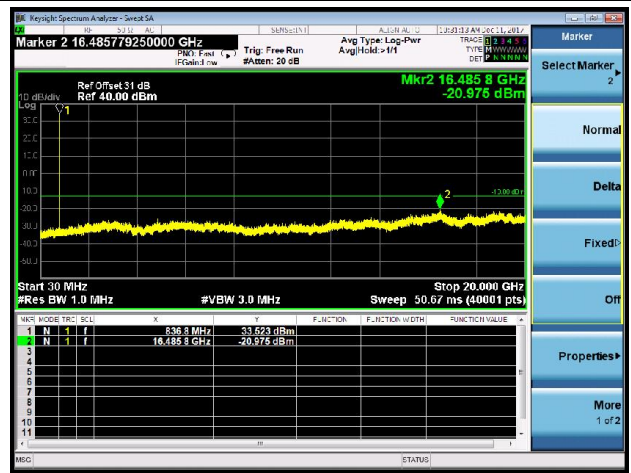

Channel 251 (848.80MHz)

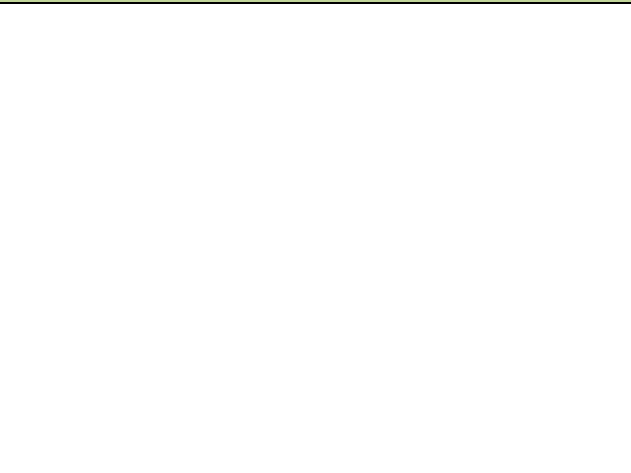
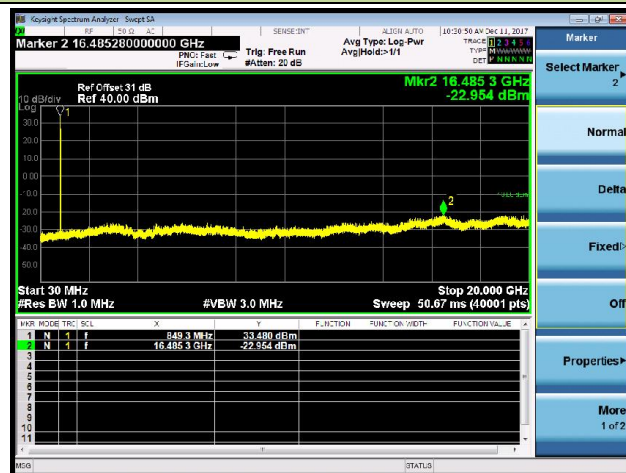

EDGE1900 Band Edge

Channel 512 (1850.20MHz)

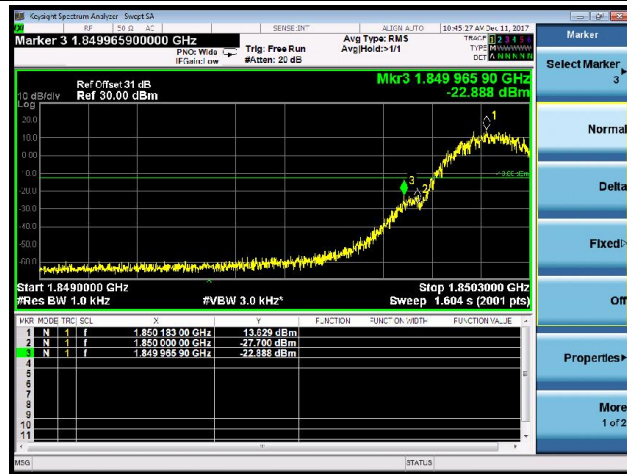

Channel 810 (1909.80MHz)



EDGE1900 Conducted Spurious Emission

Channel 512 (1850.20MHz)

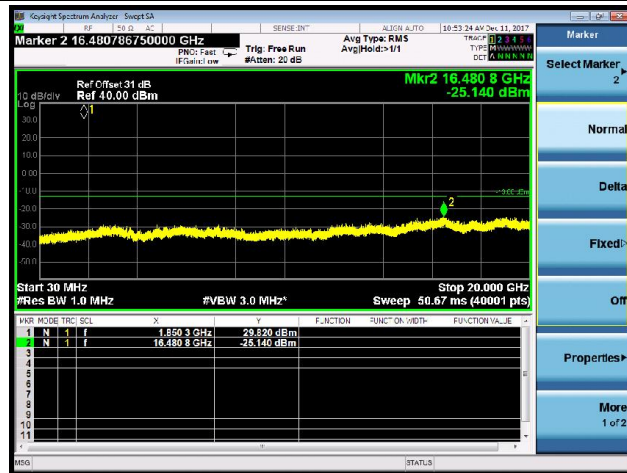

Channel 661 (1880.00MHz)

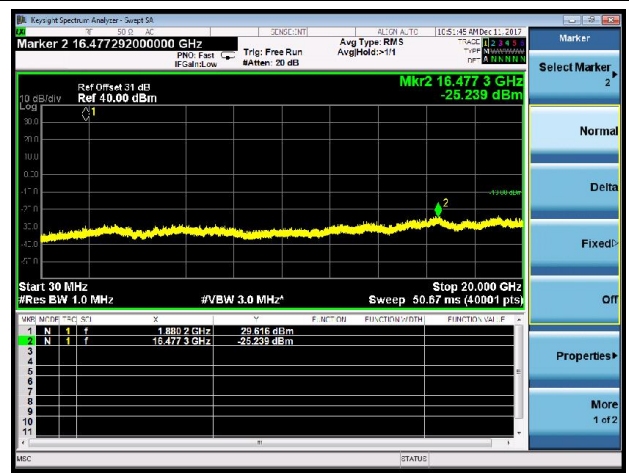

Channel 810 (1909.80MHz)

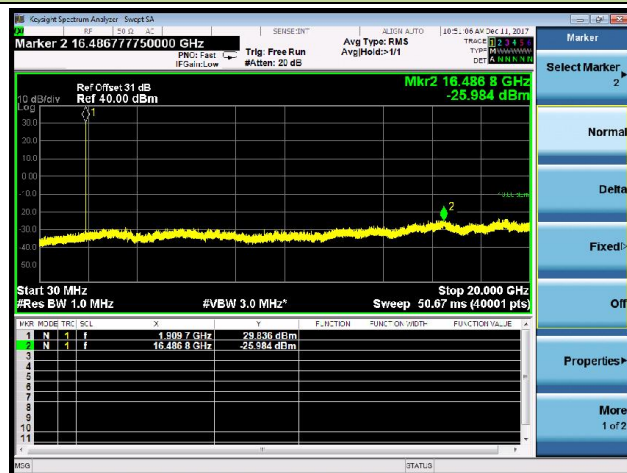

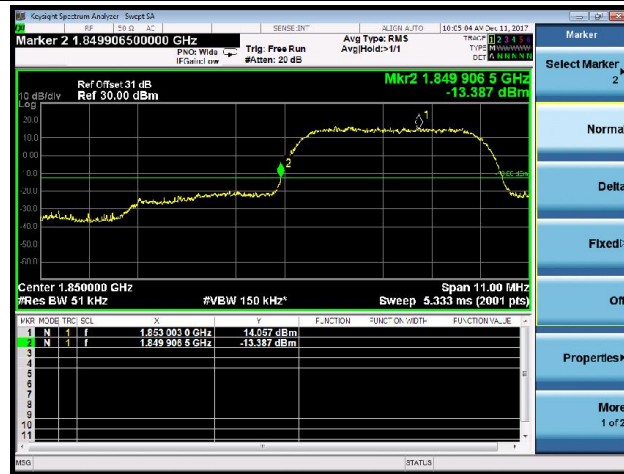
WCDMA Band II Band Edge
Channel 9262 (1852.4MHz)

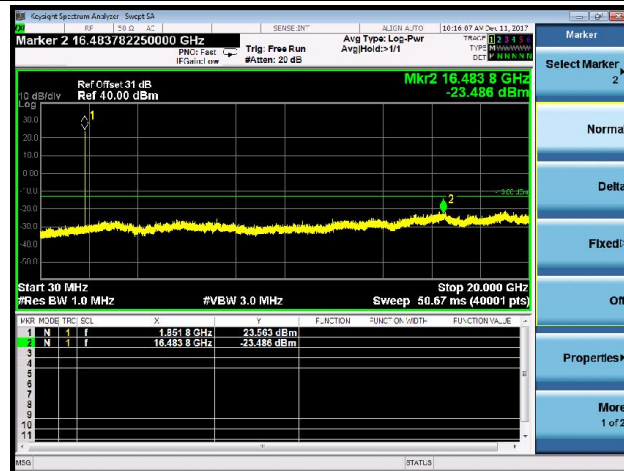
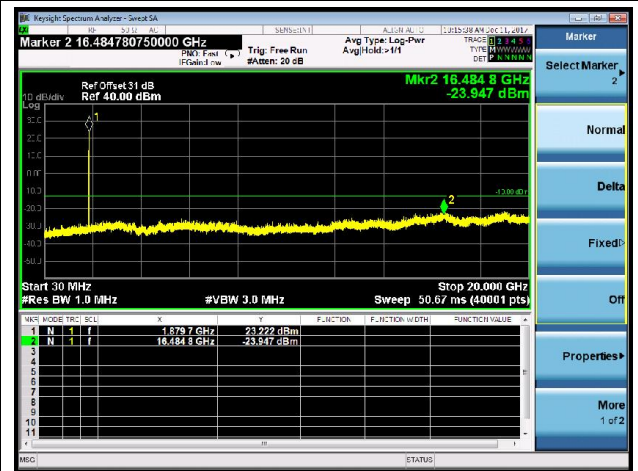
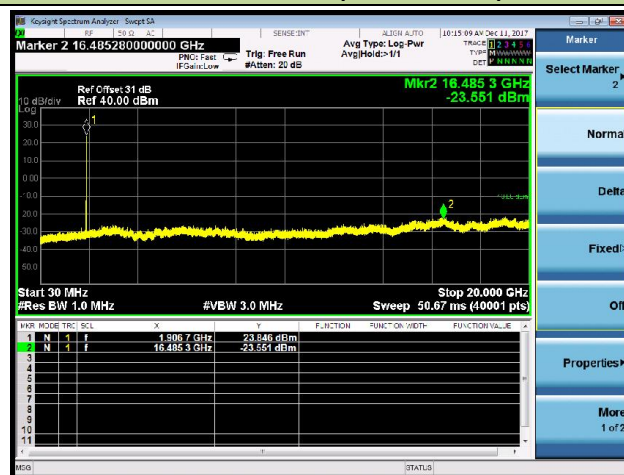
Channel 9538 (1907.6MHz)

WCDMA Band II Conducted Spurious Emission
Channel 9262 (1852.4MHz)

Channel 9400 (1880.0MHz)

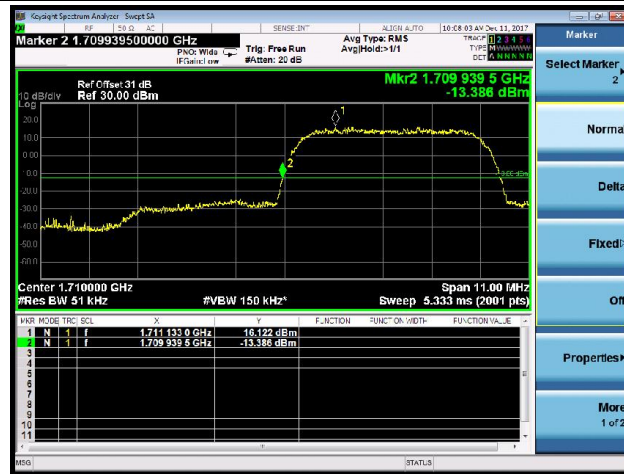
Channel 9538 (1907.6MHz)

WCDMA Band IV Band Edge

Channel 1312 (1712.4MHz)

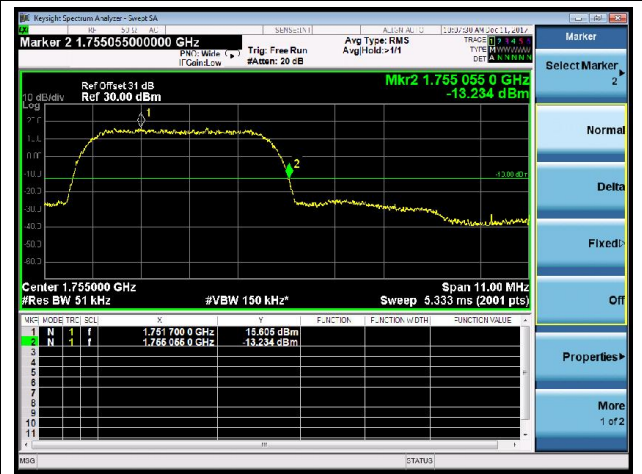

Channel 1513 (1752.6MHz)



WCDMA Band IV Conducted Spurious Emission

Channel 1312 (1712.4MHz)

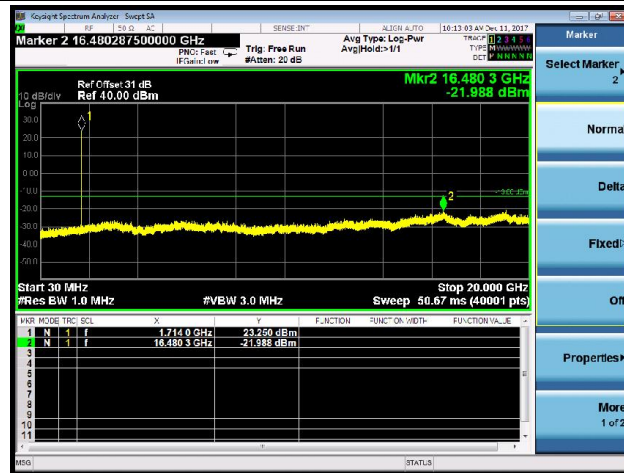

Channel 1413 (1732.6MHz)

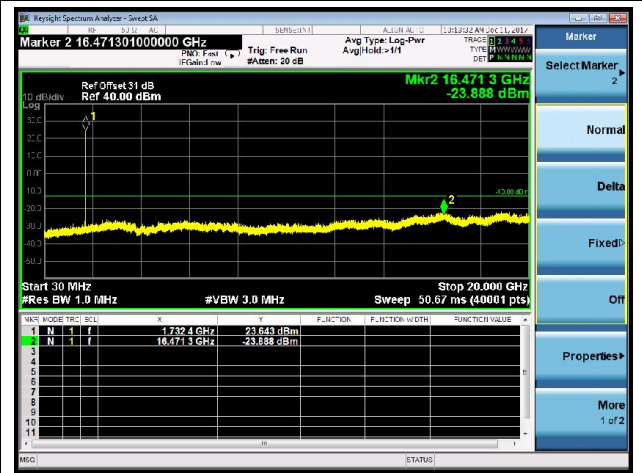

Channel 1513 (1752.6MHz)

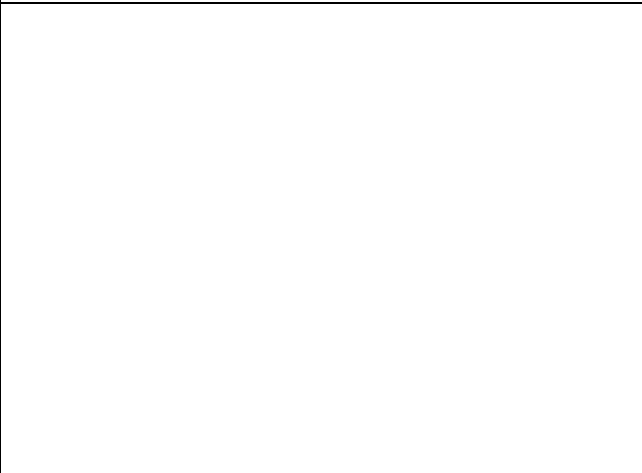
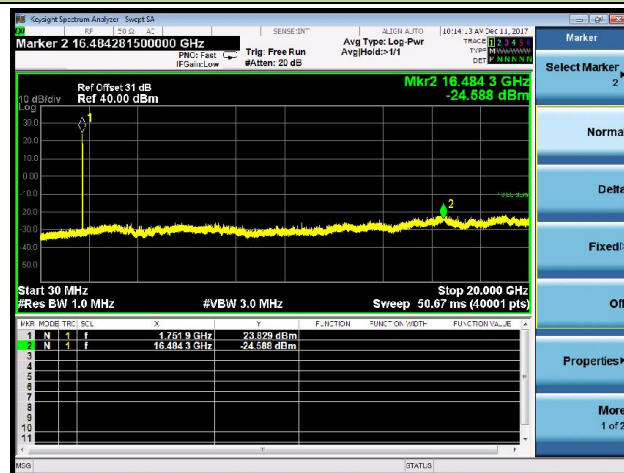

WCDMA Band V Band Edge

Channel 4132 (826.4MHz)

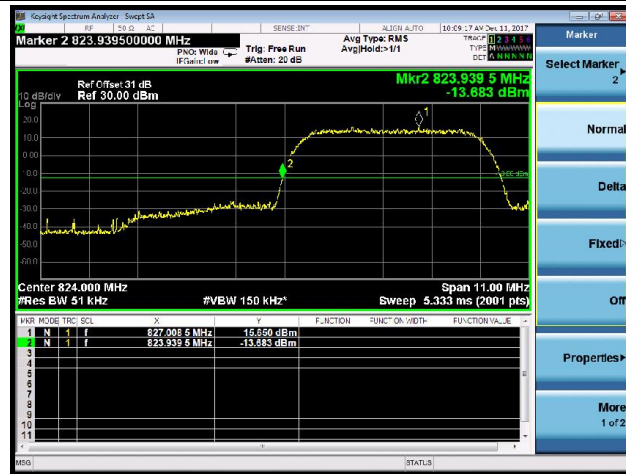

Channel 4233 (846.6MHz)

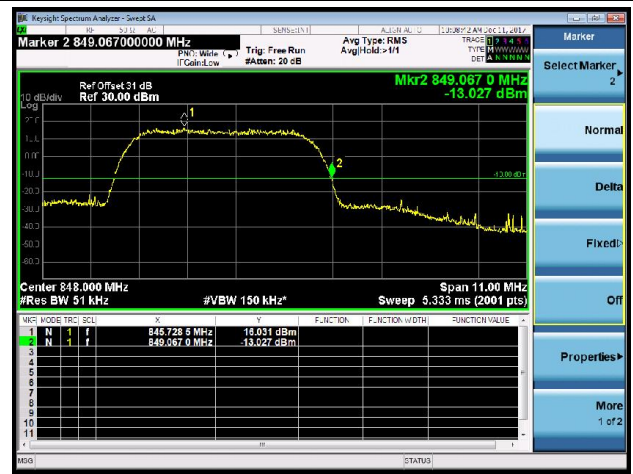

WCDMA Band V Conducted Spurious Emission

Channel 4132 (826.4MHz)

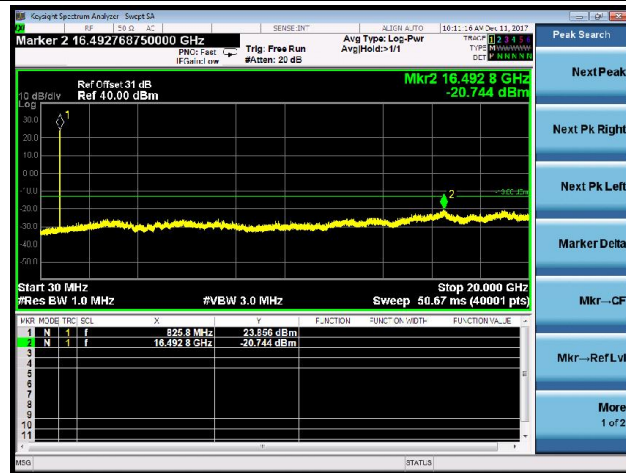

Channel 4182 (836.4MHz)

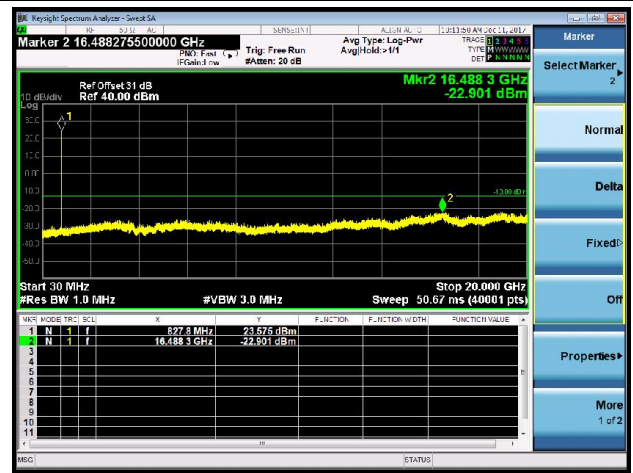

Channel 4233 (846.6MHz)

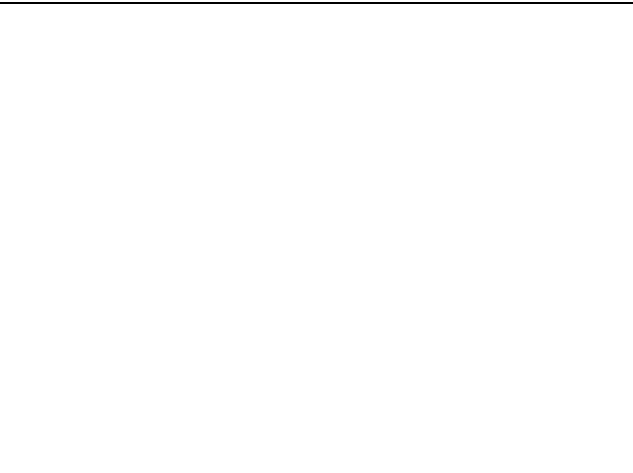
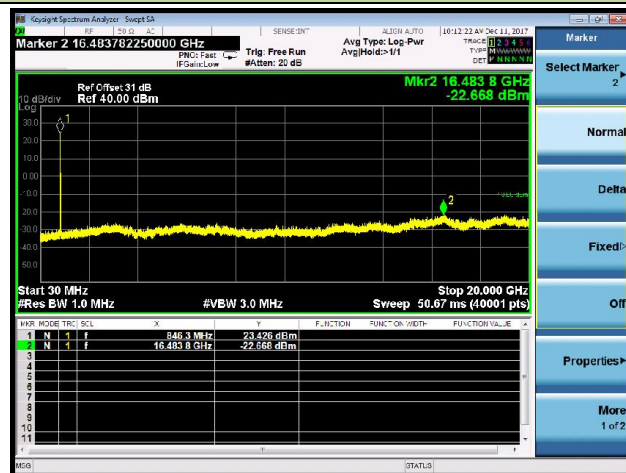

7.4. Conducted & Radiated Power and Radiated Spurious Emissions

7.4.1. Test Limit

Radiated Power

For FCC Part 22.913(a)(2):

The ERP of mobile transmitters and auxiliary test transmitters must not exceed 7 Watts.

For FCC Part 24.232(b):

The EIRP of mobile transmitters and auxiliary test transmitters must not exceed 2 Watts.

For FCC Part 27.50(d)(4)

The EIRP of mobile transmitters and auxiliary test transmitters must not exceed 1 Watts.

Radiated Spurious Emissions

The power of any emission outside of the authorized operating frequency ranges must be attenuated below the transmitting power (P) by a factor of at least $43 + 10\log(P)$ dB.

7.4.2. Test Procedure Used

KDB 971168 D01v03 - Section 7.0 & ANSI/TIA-603-E-2016

7.4.3. Test Setting

1. The EUT shall be placed at the specified height on a support, and in the position closest to normal use as declared by provider.
2. The test antenna shall be oriented initially for vertical polarization and shall be chosen to correspond to the frequency of the transmitter
3. The output of the test antenna shall be connected to the measuring receiver.
4. The transmitter shall be switched on and the measuring receiver shall be tuned to the frequency of the transmitter under test.
5. The test antenna shall be raised and lowered through the specified range of height until a maximum signal level is detected by the measuring receiver.
6. The transmitter shall then be rotated through 360° in the horizontal plane, until the maximum

- signal level is detected by the measuring receiver.
7. The test antenna shall be raised and lowered again through the specified range of height until a maximum signal level is detected by the measuring receiver.
 8. The maximum signal level detected by the measuring receiver shall be noted.
 9. The transmitter shall be replaced by a substitution antenna.
 10. The substitution antenna shall be orientated for vertical polarization and the length of the substitution antenna shall be adjusted to correspond to the frequency of the transmitter.
 11. The substitution antenna shall be connected to a calibrated signal generator.
 12. If necessary, the input attenuator setting of the measuring receiver shall be adjusted in order to increase the sensitivity of the measuring receiver.
 13. The test antenna shall be raised and lowered through the specified range of height to ensure that the maximum signal is received.
 14. The input signal to the substitution antenna shall be adjusted to the level that produces a level detected by the measuring receiver, that is equal to the level noted while the transmitter radiated power was measured, corrected for the change of input attenuator setting of the measuring receiver.
 15. The measurement shall be repeated with the test antenna and the substitution antenna orientated for horizontal polarization.
 16. The measure of the effective radiated power is the larger of the two levels recorded at the input to the substitution antenna, corrected for gain of the substitution antenna if necessary.
 17. Test site anechoic chamber refer to ANSI C63.4: 2014.

7.4.4. Test Setup

30MHz ~ 1GHz Test Setup:

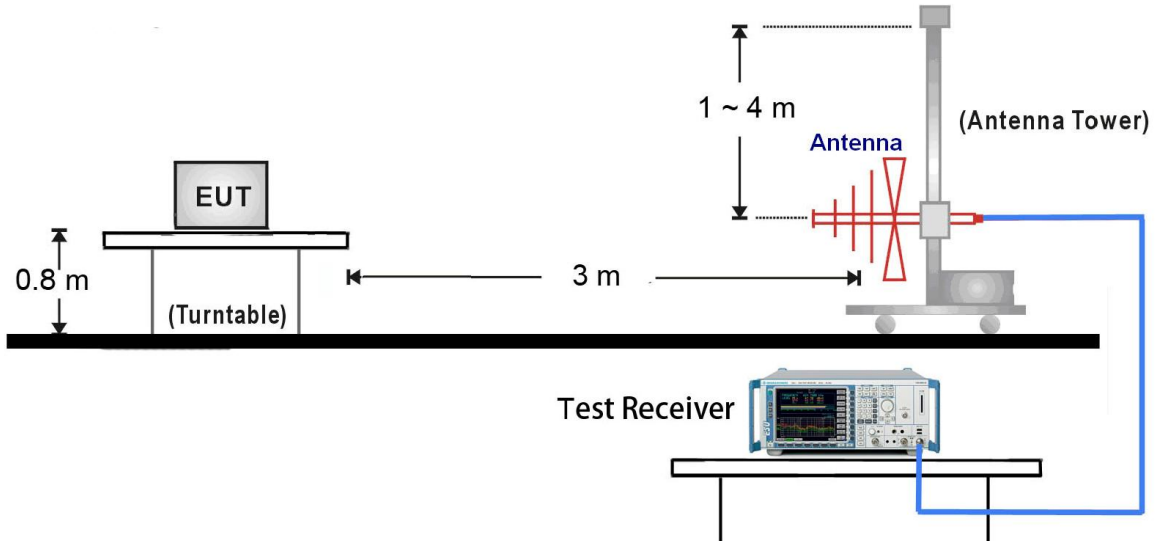

1GHz ~ 20GHz Test Setup:

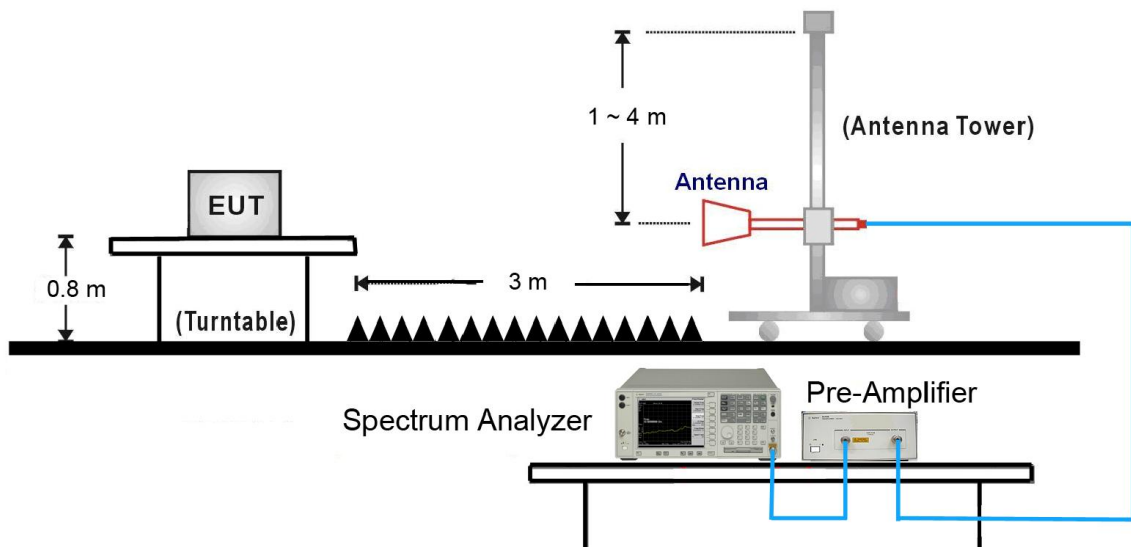

7.4.5. Test Result

Product	Mobile Data Terminal	Temperature	25°C
Test Engineer	Snake Ni	Relative Humidity	54%
Test Site	TR3	Test Date	2017/12/11

Mode	Frequency (MHz)	Avg. Burst Power (dBm)	Duty Cycle Factor (dB)	Frame Power (dBm)	Radiated Power (dBm)
GSM850	824.2	32.32	-9.00	23.32	30.82
	836.4	32.38	-9.00	23.38	30.88
	848.8	32.49	-9.00	23.49	30.99
GPRS850 (1 Slot)	824.2	32.22	-9.00	23.22	30.72
	836.4	32.33	-9.00	23.33	30.83
	848.8	32.38	-9.00	23.38	30.88
GPRS850 (2 Slot)	824.2	31.65	-6.00	25.65	30.15
	836.4	31.75	-6.00	25.75	30.25
	848.8	31.80	-6.00	25.80	30.30
GPRS850 (3 Slot)	824.2	30.03	-4.25	25.78	28.53
	836.4	30.15	-4.25	25.90	28.65
	848.8	30.22	-4.25	25.97	28.72
GPRS850 (4 Slot)	824.2	28.98	-3.00	25.98	27.48
	836.4	29.05	-3.00	26.05	27.55
	848.8	29.10	-3.00	26.10	27.60
EDGE850 (1 Slot)	824.2	27.67	-9.00	18.67	26.17
	836.4	27.89	-9.00	18.89	26.39
	848.8	27.72	-9.00	18.72	26.22
EDGE850 (2 Slot)	824.2	26.84	-6.00	20.84	25.34
	836.4	26.96	-6.00	20.96	25.46
	848.8	26.78	-6.00	20.78	25.28
EDGE850 (3 Slot)	824.2	26.72	-4.25	22.47	25.22
	836.4	26.69	-4.25	22.44	25.19
	848.8	26.19	-4.25	21.94	24.69
EDGE850 (4 Slot)	824.2	26.70	-3.00	23.70	25.20
	836.4	26.43	-3.00	23.43	24.93
	848.8	26.51	-3.00	23.51	25.01

Mode	Frequency (MHz)	Avg. Burst Power (dBm)	Duty Cycle Factor (dB)	Frame Power (dBm)	Radiated Power (dBm)
PCS1900	1850.2	28.96	-9.00	19.96	28.06
	1880.0	28.99	-9.00	19.99	28.09
	1909.8	29.07	-9.00	20.07	28.17
GPRS1900 (1 Slot)	1850.2	28.66	-9.00	19.66	27.76
	1880.0	28.67	-9.00	19.67	27.77
	1909.8	28.97	-9.00	19.97	28.07
GPRS1900 (2 Slot)	1850.2	28.54	-6.00	22.54	27.64
	1880.0	28.50	-6.00	22.50	27.60
	1909.8	28.61	-6.00	22.61	27.71
GPRS1900 (3 Slot)	1850.2	26.95	-4.25	22.70	26.05
	1880.0	27.02	-4.25	22.77	26.12
	1909.8	27.21	-4.25	22.96	26.31
GPRS1900 (4 Slot)	1850.2	25.91	-3.00	22.91	25.01
	1880.0	25.96	-3.00	22.96	25.06
	1909.8	26.16	-3.00	23.16	25.26
EDGE1900 (1 Slot)	1850.2	26.01	-9.00	17.01	25.11
	1880.0	26.03	-9.00	17.03	25.13
	1909.8	26.09	-9.00	17.09	25.19
EDGE1900 (2 Slot)	1850.2	24.33	-6.00	18.33	23.43
	1880.0	24.41	-6.00	18.41	23.51
	1909.8	24.34	-6.00	18.34	23.44
EDGE1900 (3 Slot)	1850.2	24.80	-4.25	20.55	23.90
	1880.0	24.31	-4.25	20.06	23.41
	1909.8	24.08	-4.25	19.83	23.18
EDGE1900 (4 Slot)	1850.2	24.00	-3.00	21.00	23.10
	1880.0	24.03	-3.00	21.03	23.13
	1909.8	23.99	-3.00	20.99	23.09

Note 1: Frame Power (dBm) = Avg. Burst Power (dBm) + Duty Cycle Factor (dB)

Note 2: Radiated Power (dBm) = Avg. Burst Power (dBm) + Antenna Gain (dBi) - Cable Loss (dB)

Mode	3GPP Subtest	Conducted Power (dBm)			MPR	Radiated Power (dBm)		
		Band II Channel				Band II Channel		
		9262	9400	9538		9262	9400	9538
WCDMA R99	1	22.07	22.16	22.39	N/A	22.02	22.11	22.34
Rel5 HSDPA	1	21.24	21.36	21.62	0	21.19	21.31	21.57
	2	21.25	21.36	21.60	0	21.20	21.31	21.55
	3	20.76	20.90	21.20	0.5	20.71	20.85	21.15
	4	20.73	20.87	21.11	0.5	20.68	20.82	21.06
Rel6 HSUPA	1	19.22	19.30	19.52	0.0	19.17	19.25	19.47
	2	19.15	19.27	19.53	2.0	19.10	19.22	19.48
	3	20.18	20.30	20.56	1.0	20.13	20.25	20.51
	4	18.67	18.79	18.99	2.0	18.62	18.74	18.94
	5	21.14	21.33	21.52	0.0	21.09	21.28	21.47
Rel7 HSPA+	1	20.83	20.88	21.01	0.0	20.78	20.83	20.96

Mode	3GPP Subtest	Conducted Power (dBm)			MPR	Radiated Power (dBm)		
		Band IV Channel				Band IV Channel		
		4132	4182	4233		4132	4182	4233
WCDMA R99	1	22.14	21.99	21.92	N/A	20.94	20.79	20.72
Rel5 HSDPA	1	21.18	21.08	21.06	0	19.98	19.88	19.86
	2	21.17	21.08	21.05	0	19.97	19.88	19.85
	3	20.74	20.61	20.56	0.5	19.54	19.41	19.36
	4	20.70	20.63	20.58	0.5	19.50	19.43	19.38
Rel6 HSUPA	1	19.19	19.10	19.03	0.0	17.99	17.90	17.83
	2	19.20	19.06	18.97	2.0	18.00	17.86	17.77
	3	20.22	20.09	20.02	1.0	19.02	18.89	18.82
	4	18.66	18.61	18.48	2.0	17.46	17.41	17.28
	5	21.12	21.05	20.97	0.0	19.92	19.85	19.77
Rel7 HSPA+	1	21.00	21.04	20.72	0.0	19.80	19.84	19.52

Mode	3GPP Subtest	Conducted Power (dBm)			MPR	Radiated Power (dBm)		
		Band V Channel				Band V Channel		
		4132	4182	4233		4132	4182	4233
WCDMA R99	1	21.74	21.43	21.65	N/A	20.09	19.78	20.00
Rel5 HSDPA	1	21.23	21.17	21.34	0	19.58	19.52	19.69
	2	21.21	21.16	21.31	0	19.56	19.51	19.66
	3	20.72	20.69	20.85	0.5	19.07	19.04	19.20
	4	20.71	20.67	20.83	0.5	19.06	19.02	19.18
Rel6 HSUPA	1	19.23	19.17	19.36	0.0	17.58	17.52	17.71
	2	19.16	19.12	19.28	2.0	17.51	17.47	17.63
	3	20.18	20.17	20.33	1.0	18.53	18.52	18.68
	4	18.7	18.61	18.72	2.0	17.05	16.96	17.07
	5	21.21	21.16	21.27	0.0	19.56	19.51	19.62
Rel7 HSPA+	1	20.96	20.84	21.03	0.0	19.31	19.19	19.38

NOTES:

1. Radiated Power (dBm) = Conducted Power (dBm) + Antenna Gain (dBi) - Cable Loss (dB)
2. This device was tested under all configurations and the highest power is reported in GSM mode. This device employs UMTS technology with WCDMA (AMR/RMC), HSDPA, HSUPA, HSPA+ and GSM/GPRS/EDGE capabilities. For WCDMA and HSPA transmission, all configurations were investigated and the worst case UMTS emissions were found in RMC WCDMA mode at 12.2kbps rate.
3. This unit was tested with its standard adapter.
4. The EUT was tested in three orthogonal planes and in all possible test configurations and positioning. The “H” positioning is defined with the EUT lying flat on the test surface, the “H2” positioning is defined with the EUT standing up on its side, and the “V” positioning is defined with the EUT standing upright. The worst case test configuration was found in the EUT in the H positioning. The data reported in the table above was measured in this test setup.

Radiated Spurious Emission

GSM850

Frequency (MHz)	Ant. Pol. (H/V)	SG Reading (dBm)	Cable Loss (dB)	Substitute Antenna Gain (dBd)	ERP (dBm)	Limit (dBm)	Margin (dB)
Low Channel 128 (824.20MHz)							
1646.00	V	-64.58	1.26	9.76	-56.08	-13.00	-43.08
2470.50	V	-56.92	1.49	10.48	-47.93	-13.00	-34.93
2470.50	H	-59.12	1.25	10.48	-49.89	-13.00	-36.89
4119.50	H	-61.80	1.45	12.64	-50.61	-13.00	-37.61
Middle Channel 189 (836.40MHz)							
1671.50	V	-64.81	0.99	9.93	-55.87	-13.00	-42.87
2513.00	V	-50.27	1.27	10.62	-40.92	-13.00	-27.92
1671.50	H	-66.09	1.27	9.93	-57.43	-13.00	-44.43
2513.00	H	-53.09	1.40	10.62	-43.87	-13.00	-30.87
High Channel 251 (848.80MHz)							
1697.00	V	-63.98	1.29	10.11	-55.16	-13.00	-42.16
2547.00	V	-49.82	1.46	10.68	-40.60	-13.00	-27.60
2547.00	H	-48.40	1.00	10.68	-38.72	-13.00	-25.72
4247.00	H	-59.76	1.29	12.71	-48.34	-13.00	-35.34

Note:

1. Spurious emissions within 30-1000MHz were found more than 20dB below limit line.
2. $ERP \text{ (dBm)} = SG \text{ Reading (dBm)} - Cable \text{ Loss (dB)} + Substitute \text{ Antenna Gain (dBd)}$

PCS1900

Frequency (MHz)	Ant. Pol. (H/V)	SG Reading (dBm)	Cable Loss (dB)	Substitute Antenna Gain (dBi)	EIRP (dBm)	Limit (dBm)	Margin (dB)
Low Channel 512 (1850.20MHz)							
5547.50	V	-55.85	1.26	13.15	-43.96	-13.00	-30.96
8038.00	V	-56.86	1.49	11.37	-46.98	-13.00	-33.98
3703.00	H	-63.22	1.25	12.69	-51.78	-13.00	-38.78
5547.50	H	-61.00	1.45	13.15	-49.30	-13.00	-36.30
Middle Channel 661 (1880.00MHz)							
5641.00	V	-56.83	0.99	13.14	-44.68	-13.00	-31.68
7502.50	V	-57.14	1.27	11.24	-47.17	-13.00	-34.17
3762.50	H	-63.12	1.27	12.73	-51.66	-13.00	-38.66
5641.00	H	-58.19	1.40	13.14	-46.45	-13.00	-33.45
High Channel 810 (1909.80MHz)							
5726.00	V	-53.30	1.29	13.11	-41.48	-13.00	-28.48
8046.50	V	-56.71	1.46	11.39	-46.78	-13.00	-33.78
5726.00	H	-56.77	1.00	13.11	-44.66	-13.00	-31.66
8072.00	H	-58.32	1.29	11.46	-48.15	-13.00	-35.15

Note:

1. Spurious emissions within 30-1000MHz were found more than 20dB below limit line.
2. $EIRP (dBm) = SG \text{ Reading (dBm)} - Cable \text{ Loss (dB)} + Substitute \text{ Antenna Gain (dB)}$

EDGE850

Frequency (MHz)	Ant. Pol. (H/V)	SG Reading (dBm)	Cable Loss (dB)	Substitute Antenna Gain (dBd)	ERP (dBm)	Limit (dBm)	Margin (dB)
Low Channel 128 (824.20MHz)							
1646.00	V	-65.81	1.26	9.76	-57.31	-13.00	-44.31
2470.50	V	-57.20	1.49	10.48	-48.21	-13.00	-35.21
2470.50	H	-58.77	1.25	10.48	-49.54	-13.00	-36.54
4119.50	H	-62.43	1.45	12.64	-51.24	-13.00	-38.24
Middle Channel 189 (836.40MHz)							
1671.50	V	-64.70	0.99	9.93	-55.76	-13.00	-42.76
2513.00	V	-50.60	1.27	10.62	-41.25	-13.00	-28.25
1671.50	H	-66.52	1.27	9.93	-57.86	-13.00	-44.86
2513.00	H	-53.80	1.40	10.62	-44.58	-13.00	-31.58
High Channel 251 (848.80MHz)							
1697.00	V	-64.16	1.29	10.11	-55.34	-13.00	-42.34
2547.00	V	-50.50	1.46	10.68	-41.28	-13.00	-28.28
2547.00	H	-49.53	1.00	10.68	-39.85	-13.00	-26.85
4247.00	H	-60.11	1.29	12.71	-48.69	-13.00	-35.69

Note:

1. Spurious emissions within 30-1000MHz were found more than 20dB below limit line.
2. $ERP (dBm) = SG \text{ Reading } (dBm) - Cable \text{ Loss } (dB) + Substitute \text{ Antenna Gain } (dBd)$

EDGE1900

Frequency (MHz)	Ant. Pol. (H/V)	SG Reading (dBm)	Cable Loss (dB)	Substitute Antenna Gain (dBi)	EIRP (dBm)	Limit (dBm)	Margin (dB)
Low Channel 512 (1850.20MHz)							
5547.50	V	-56.41	1.26	13.15	-44.52	-13.00	-31.52
8038.00	V	-57.46	1.49	11.37	-47.58	-13.00	-34.58
3703.00	H	-63.65	1.25	12.69	-52.21	-13.00	-39.21
5547.50	H	-61.55	1.45	13.15	-49.85	-13.00	-36.85
Middle Channel 661 (1880.00MHz)							
5641.00	V	-56.99	0.99	13.14	-44.84	-13.00	-31.84
7502.50	V	-58.12	1.27	11.24	-48.15	-13.00	-35.15
3762.50	H	-63.21	1.27	12.73	-51.75	-13.00	-38.75
5641.00	H	-58.52	1.40	13.14	-46.78	-13.00	-33.78
High Channel 810 (1909.80MHz)							
5726.00	V	-54.07	1.29	13.11	-42.25	-13.00	-29.25
8046.50	V	-57.11	1.46	11.39	-47.18	-13.00	-34.18
5726.00	H	-56.96	1.00	13.11	-44.85	-13.00	-31.85
8072.00	H	-59.80	1.29	11.46	-49.63	-13.00	-36.63

Note:

1. Spurious emissions within 30-1000MHz were found more than 20dB below limit line.
2. $EIRP (dBm) = SG \text{ Reading (dBm)} - Cable \text{ Loss (dB)} + Substitute \text{ Antenna Gain (dBi)}$

WCDMA Band II

Frequency (MHz)	Ant. Pol. (H/V)	SG Reading (dBm)	Cable Loss (dB)	Substitute Antenna Gain (dBd)	ERP (dBm)	Limit (dBm)	Margin (dB)
Low Channel 9262 (1852.4MHz)							
5556.00	V	-58.34	1.26	13.15	-46.45	-13.00	-33.45
7409.00	V	-52.16	1.49	11.03	-42.62	-13.00	-29.62
5556.00	H	-55.92	1.25	13.15	-44.02	-13.00	-31.02
7409.00	H	-50.95	1.45	11.03	-41.37	-13.00	-28.37
Middle Channel 9400 (1880.0MHz)							
5632.50	V	-55.94	0.99	13.14	-43.79	-13.00	-30.79
7519.50	V	-55.24	1.27	11.28	-45.23	-13.00	-32.23
5632.50	H	-54.92	1.27	13.14	-43.05	-13.00	-30.05
7511.00	H	-51.61	1.40	11.26	-41.75	-13.00	-28.75
High Channel 9538 (1907.6MHz)							
3813.50	V	-56.98	1.29	12.74	-45.53	-13.00	-32.53
5726.00	V	-58.15	1.46	13.11	-46.50	-13.00	-33.50
5726.00	H	-55.62	1.00	13.11	-43.51	-13.00	-30.51
7630.00	H	-55.54	1.29	11.46	-45.37	-13.00	-32.37

Note:

1. Spurious emissions within 30-1000MHz were found more than 20dB below limit line.
2. $EIRP (dBm) = SG \text{ Reading (dBm)} - Cable \text{ Loss (dB)} + Substitute \text{ Antenna Gain (dBd)}$

WCDMA Band IV

Frequency (MHz)	Ant. Pol. (H/V)	SG Reading (dBm)	Cable Loss (dB)	Substitute Antenna Gain (dBd)	ERP (dBm)	Limit (dBm)	Margin (dB)
Low Channel 1312 (1712.4MHz)							
6848.00	V	-54.75	1.26	12.17	-43.84	-13.00	-30.84
10273.50	V	-45.73	1.49	11.85	-35.37	-13.00	-22.37
5139.50	H	-53.48	1.25	12.80	-41.93	-13.00	-28.93
10265.00	H	-48.72	1.45	11.86	-38.31	-13.00	-25.31
Middle Channel 1413 (1732.6MHz)							
5258.50	V	-49.19	0.99	12.94	-37.24	-13.00	-24.24
10520.00	V	-50.55	1.27	11.65	-40.17	-13.00	-27.17
5258.50	H	-53.25	1.27	12.94	-41.58	-13.00	-28.58
7009.50	H	-50.60	1.40	11.61	-40.39	-13.00	-27.39
High Channel 1513 (1752.6MHz)							
5258.50	V	-48.57	1.29	12.94	-36.92	-13.00	-23.92
10511.50	V	-50.22	1.46	11.66	-40.02	-13.00	-27.02
5258.50	H	-53.15	1.00	12.94	-41.21	-13.00	-28.21
7018.00	H	-51.60	1.29	11.58	-41.31	-13.00	-28.31

Note:

1. Spurious emissions within 30-1000MHz were found more than 20dB below limit line.
2. $EIRP (dBm) = SG \text{ Reading (dBm)} - Cable \text{ Loss (dB)} + Substitute \text{ Antenna Gain (dBd)}$

WCDMA Band V

Frequency (MHz)	Ant. Pol. (H/V)	SG Reading (dBm)	Cable Loss (dB)	Substitute Antenna Gain (dBd)	ERP (dBm)	Limit (dBm)	Margin (dB)
Low Channel 4132 (826.40MHz)							
4128.00	V	-44.40	1.26	12.65	-33.01	-13.00	-20.01
4961.00	V	-43.29	1.49	12.63	-32.15	-13.00	-19.15
4128.00	H	-47.44	1.25	12.65	-36.04	-13.00	-23.04
4969.50	H	-48.76	1.45	12.64	-37.57	-13.00	-24.57
Middle Channel 4182 (836.40MHz)							
4179.00	V	-43.11	0.99	12.69	-31.41	-13.00	-18.41
5012.00	V	-46.22	1.27	12.66	-34.83	-13.00	-21.83
4187.50	H	-46.13	1.27	12.69	-34.71	-13.00	-21.71
5012.00	H	-51.96	1.40	12.66	-40.70	-13.00	-27.70
High Channel 4233 (846.60MHz)							
4230.00	V	-42.85	1.29	12.71	-31.43	-13.00	-18.43
5088.50	V	-50.51	1.46	12.74	-39.23	-13.00	-26.23
3388.50	H	-54.84	1.00	12.94	-42.90	-13.00	-29.90
4238.50	H	-46.21	1.29	12.71	-34.79	-13.00	-21.79

Note:

1. Spurious emissions within 30-1000MHz were found more than 20dB below limit line.
2. $ERP (dBm) = SG \text{ Reading } (dBm) - Cable \text{ Loss } (dB) + Substitute \text{ Antenna Gain } (dBd)$

7.5. Peak-Average Ratio

7.5.1. Test Limit

The transmitter's peak-to-average power ratio (PAPR) shall not exceed 13 dB for more than 0.1% of the time using a signal corresponding to the highest PAPR during periods of continuous transmission.

7.5.2. Test Procedure

KDB 971168 D01v03 - Section 5.7 & ANSI/TIA-603-E-2016

7.5.3. Test Setup

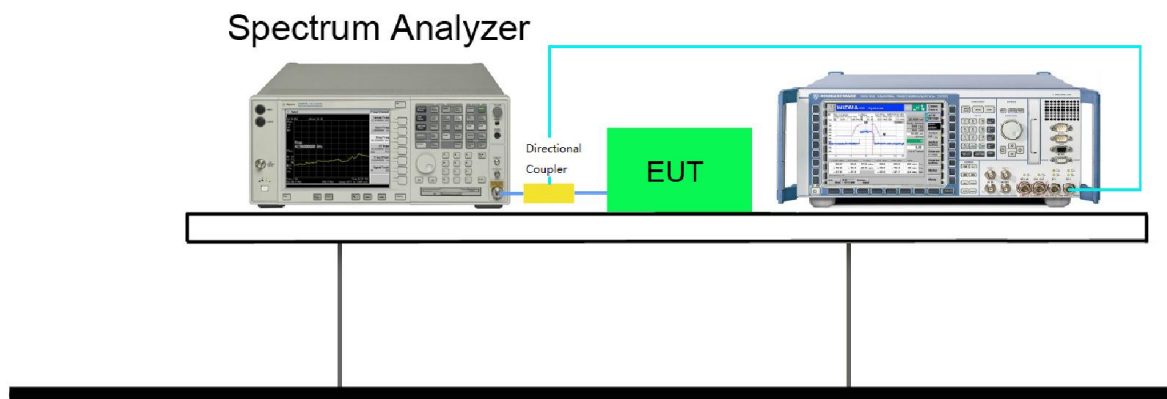

7.5.4. Test Result

Product	Mobile Data Terminal	Temperature	25°C
Test Engineer	Polly Zong	Relative Humidity	52%
Test Site	TR3	Test Date	2017/11/14

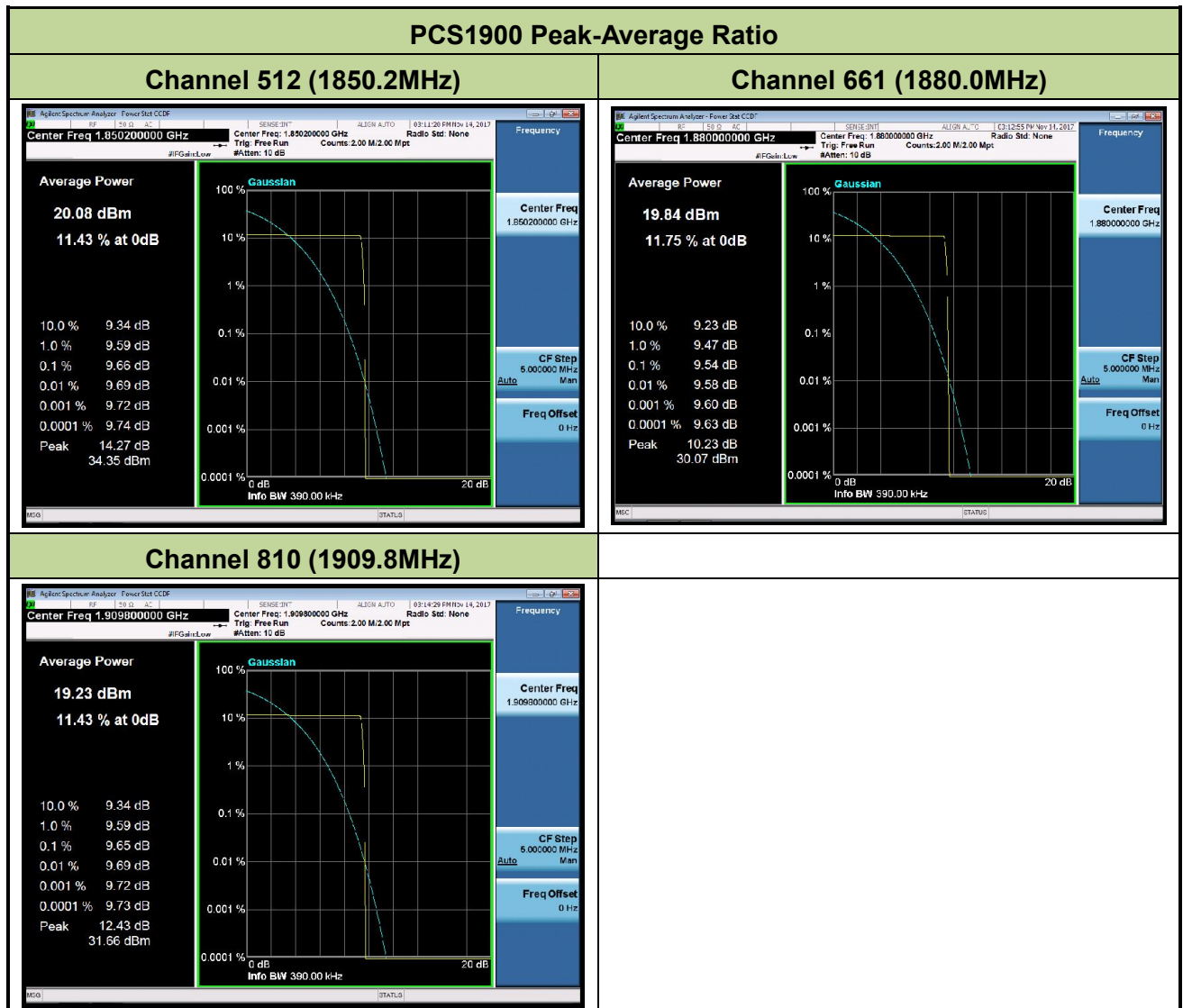

EDGE1900 Peak-Average Ratio

Channel 512 (1850.2MHz)



Channel 661 (1880.0MHz)

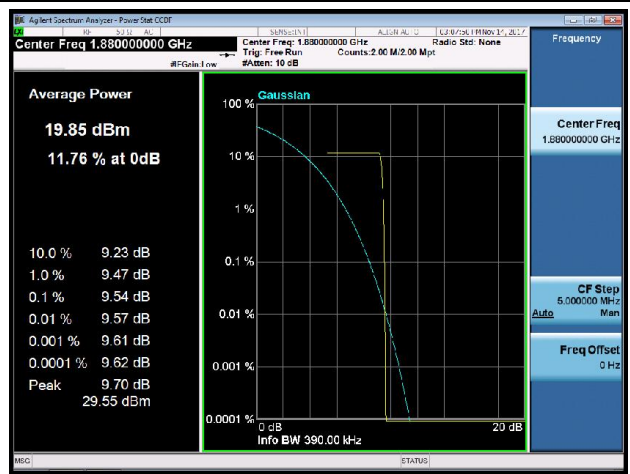

Channel 810 (1909.8MHz)

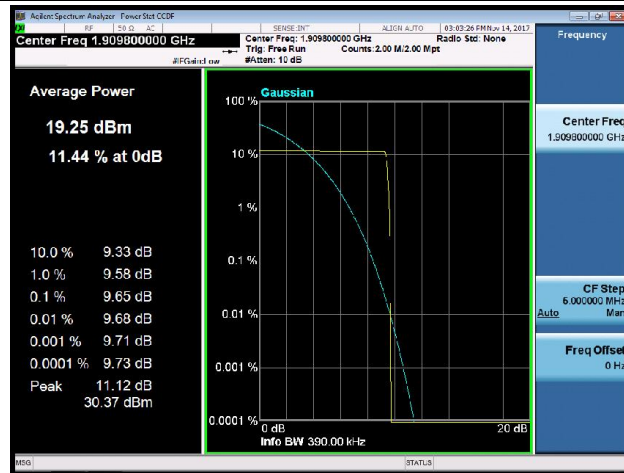

WCDMA Band II Peak-Average Ratio

Channel 9262 (1852.4MHz)

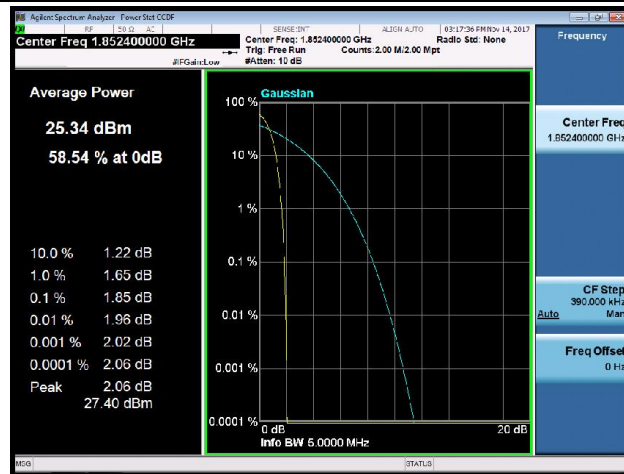

Channel 9400 (1880.0MHz)

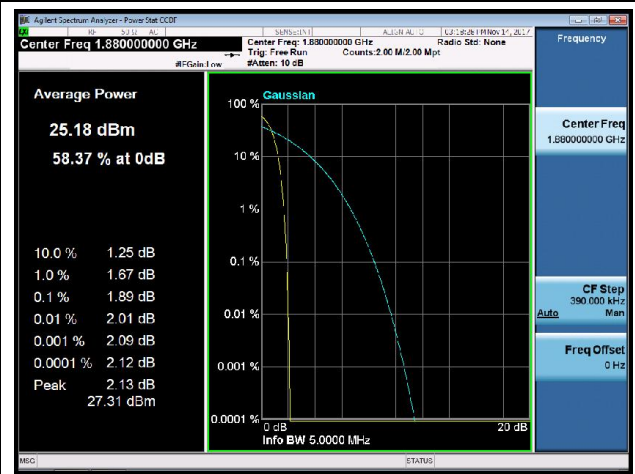

Channel 9538 (1907.6MHz)

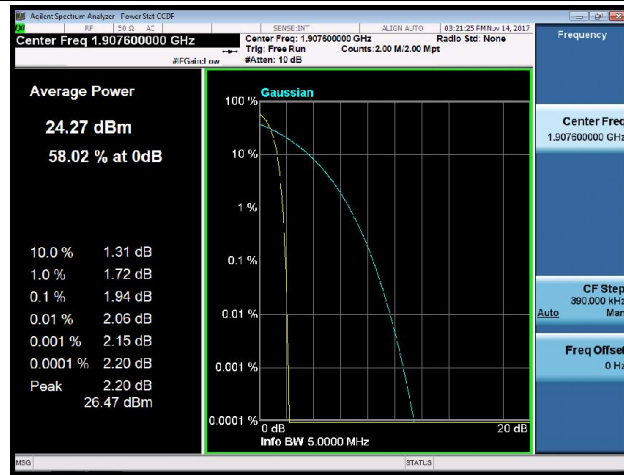

7.6. Frequency Stability Under Temperature & Voltage Variations

7.6.1. Test Limit

The frequency stability shall be sufficient to ensure that the fundamental emission stays within the authorized frequency block.

Limit	$< \pm 2.5$ ppm
-------	-----------------

7.6.2. Test Procedure

KDB 971168 D01v03 - Section 9.0 & ANSI/TIA-603-E-2016

7.6.3. Test Setup

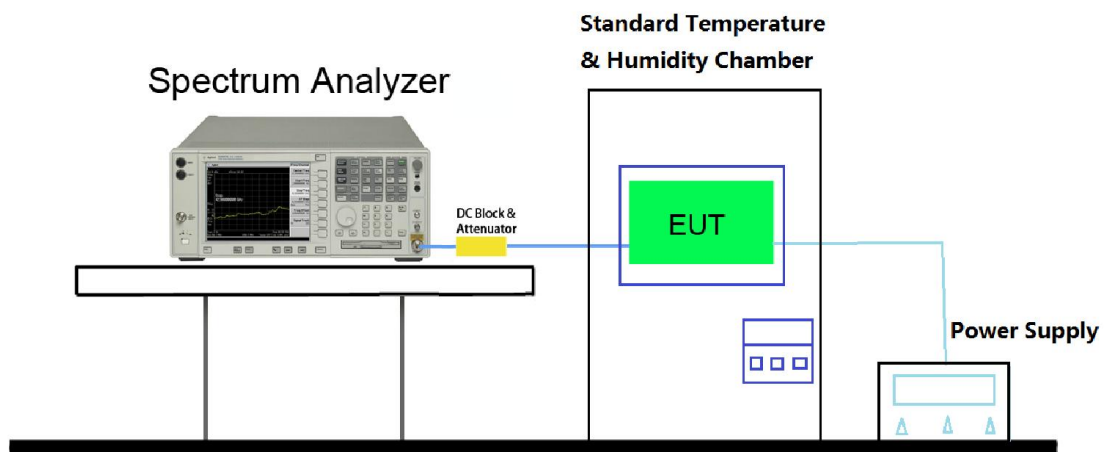

7.6.4. Test Result

Product	Mobile Data Terminal	Temperature	25°C
Test Engineer	Milo Li	Relative Humidity	52%
Test Site	TR3	Test Date	2017/11/08
Test Mode	GSM850	Operating Frequency	836.4MHz (Channel 189)

Voltage (%)	Power (V _{DC})	TEMP (%)	Frequency (Hz)	Freq. Dev. (Hz)	Deviation (%)	Limit (%)	Result
100%	3.8	+20(Ref)	836,400,000	-50	-0.000006	±0.00025	Pass
100%		-30	836,400,000	-47	-0.000006	±0.00025	Pass
100%		-20	836,400,000	37	0.000004	±0.00025	Pass
100%		-10	836,400,000	46	0.000005	±0.00025	Pass
100%		0	836,400,000	12	0.000001	±0.00025	Pass
100%		+10	836,400,000	63	0.000008	±0.00025	Pass
100%		+20	836,400,000	53	0.000006	±0.00025	Pass
100%		+30	836,400,000	17	0.000002	±0.00025	Pass
100%		+40	836,400,000	-23	-0.000003	±0.00025	Pass
100%		+50	836,400,000	-14	-0.000002	±0.00025	Pass
115%	4.37	+20	836,400,000	55	0.000007	±0.00025	Pass
BAT.ENDPOINT	3.23	+20	836,400,000	94	0.000011	±0.00025	Pass

Product	Mobile Data Terminal	Temperature	25°C
Test Engineer	Milo Li	Relative Humidity	52%
Test Site	TR3	Test Date	2017/11/08
Test Mode	PCS1900	Operating Frequency	1880.0MHz (Channel 661)

Voltage (%)	Power (V _{DC})	TEMP (%)	Frequency (Hz)	Freq. Dev. (Hz)	Deviation (%)	Limit (%)	Result
100%	3.8	+20(Ref)	1880,000,000	25	0.000001	±0.00025	Pass
100%		-30	1880,000,000	-15	-0.000001	±0.00025	Pass
100%		-20	1880,000,000	95	0.000005	±0.00025	Pass
100%		-10	1880,000,000	88	0.000005	±0.00025	Pass
100%		0	1880,000,000	83	0.000004	±0.00025	Pass
100%		+10	1880,000,000	55	0.000003	±0.00025	Pass
100%		+20	1880,000,000	89	0.000005	±0.00025	Pass
100%		+30	1880,000,000	46	0.000002	±0.00025	Pass
100%		+40	1880,000,000	41	0.000002	±0.00025	Pass
100%		+50	1880,000,000	-11	-0.000001	±0.00025	Pass
115%	4.37	+20	1880,000,000	-13	-0.000001	±0.00025	Pass
BAT.ENDPOINT	3.23	+20	1880,000,000	19	0.000001	±0.00025	Pass

Product	Mobile Data Terminal	Temperature	25°C
Test Engineer	Milo	Relative Humidity	52%
Test Site	TR3	Test Date	2017/11/08
Test Mode	EDGE850	Operating Frequency	836.4MHz (Channel 189)

Voltage (%)	Power (V _{DC})	TEMP (%)	Frequency (Hz)	Freq. Dev. (Hz)	Deviation (%)	Limit (%)	Result
100%	3.8	+20(Ref)	836,400,000	34	0.000004	±0.00025	Pass
100%		-30	836,400,000	28	0.000003	±0.00025	Pass
100%		-20	836,400,000	61	0.000007	±0.00025	Pass
100%		-10	836,400,000	81	0.000010	±0.00025	Pass
100%		0	836,400,000	22	0.000003	±0.00025	Pass
100%		+10	836,400,000	84	0.000010	±0.00025	Pass
100%		+20	836,400,000	11	0.000001	±0.00025	Pass
100%		+30	836,400,000	7	0.000001	±0.00025	Pass
100%		+40	836,400,000	97	0.000012	±0.00025	Pass
100%		+50	836,400,000	7	0.000001	±0.00025	Pass
115%	4.37	+20	836,400,000	27	0.000003	±0.00025	Pass
BAT.ENDPOINT	3.23	+20	836,400,000	76	0.000009	±0.00025	Pass

Product	Mobile Data Terminal	Temperature	25°C
Test Engineer	Milo	Relative Humidity	52%
Test Site	TR3	Test Date	2017/11/08
Test Mode	EDGE1900	Operating Frequency	1880.0MHz (Channel 661)

Voltage (%)	Power (V _{DC})	TEMP (%)	Frequency (Hz)	Freq. Dev. (Hz)	Deviation (%)	Limit (%)	Result
100%	3.8	+20(Ref)	1880,000,000	26	0.000001	±0.00025	Pass
100%		-30	1880,000,000	62	0.000003	±0.00025	Pass
100%		-20	1880,000,000	98	0.000005	±0.00025	Pass
100%		-10	1880,000,000	48	0.000003	±0.00025	Pass
100%		0	1880,000,000	14	0.000001	±0.00025	Pass
100%		+10	1880,000,000	74	0.000004	±0.00025	Pass
100%		+20	1880,000,000	84	0.000004	±0.00025	Pass
100%		+30	1880,000,000	-44	-0.000002	±0.00025	Pass
100%		+40	1880,000,000	-39	-0.000002	±0.00025	Pass
100%		+50	1880,000,000	55	0.000003	±0.00025	Pass
115%	4.37	+20	1880,000,000	16	0.000001	±0.00025	Pass
BAT.ENDPOINT	3.23	+20	1880,000,000	42	0.000002	±0.00025	Pass

Product	Mobile Data Terminal	Temperature	25°C
Test Engineer	Milo Li	Relative Humidity	52%
Test Site	TR3	Test Date	2017/11/08
Test Mode	WCDMA Band II	Operating Frequency	1880.0MHz (Channel 9400)

Voltage (%)	Power (V _{DC})	TEMP (%)	Frequency (Hz)	Freq. Dev. (Hz)	Deviation (%)	Limit (%)	Result
100%	3.8	+20(Ref)	1880,000,000	74	0.000004	±0.00025	Pass
100%		-30	1880,000,000	36	0.000002	±0.00025	Pass
100%		-20	1880,000,000	31	0.000002	±0.00025	Pass
100%		-10	1880,000,000	-15	-0.000001	±0.00025	Pass
100%		0	1880,000,000	64	0.000003	±0.00025	Pass
100%		+10	1880,000,000	17	0.000001	±0.00025	Pass
100%		+20	1880,000,000	5	0.000000	±0.00025	Pass
100%		+30	1880,000,000	99	0.000005	±0.00025	Pass
100%		+40	1880,000,000	35	0.000002	±0.00025	Pass
100%		+50	1880,000,000	9	0.000000	±0.00025	Pass
115%	4.37	+20	1880,000,000	-14	-0.000001	±0.00025	Pass
BAT.ENDPOINT	3.23	+20	1880,000,000	12	0.000001	±0.00025	Pass

Product	Mobile Data Terminal	Temperature	25°C
Test Engineer	Milo Li	Relative Humidity	52%
Test Site	TR3	Test Date	2017/11/08
Test Mode	WCDMA Band IV	Operating Frequency	1732.6MHz (Channel 1413)

Voltage (%)	Power (V _{DC})	TEMP (%)	Frequency (Hz)	Freq. Dev. (Hz)	Deviation (%)	Limit (%)	Result
100%	3.8	+20(Ref)	1,732,600,000	-13	-0.000001	±0.00025	Pass
100%		-30	1,732,600,000	75	0.000004	±0.00025	Pass
100%		-20	1,732,600,000	22	0.000001	±0.00025	Pass
100%		-10	1,732,600,000	82	0.000005	±0.00025	Pass
100%		0	1,732,600,000	68	0.000004	±0.00025	Pass
100%		+10	1,732,600,000	77	0.000004	±0.00025	Pass
100%		+20	1,732,600,000	-25	-0.000001	±0.00025	Pass
100%		+30	1,732,600,000	-10	-0.000001	±0.00025	Pass
100%		+40	1,732,600,000	-49	-0.000003	±0.00025	Pass
100%		+50	1,732,600,000	43	0.000002	±0.00025	Pass
115%		4.37	+20	1,732,600,000	50	0.000003	±0.00025
BAT.ENDPOINT	3.23	+20	1,732,600,000	-31	-0.000002	±0.00025	Pass

Product	Mobile Data Terminal	Temperature	25°C
Test Engineer	Milo Li	Relative Humidity	52%
Test Site	TR3	Test Date	2017/11/08
Test Mode	WCDMA Band V	Operating Frequency	836.4MHz (Channel 4182)

Voltage (%)	Power (V _{DC})	TEMP (%)	Frequency (Hz)	Freq. Dev. (Hz)	Deviation (%)	Limit (%)	Result
100%	3.8	+20(Ref)	836,400,000	11	0.000001	±0.00025	Pass
100%		-30	836,400,000	-39	-0.000005	±0.00025	Pass
100%		-20	836,400,000	78	0.000009	±0.00025	Pass
100%		-10	836,400,000	-25	-0.000003	±0.00025	Pass
100%		0	836,400,000	63	0.000008	±0.00025	Pass
100%		+10	836,400,000	77	0.000009	±0.00025	Pass
100%		+20	836,400,000	95	0.000011	±0.00025	Pass
100%		+30	836,400,000	11	0.000001	±0.00025	Pass
100%		+40	836,400,000	91	0.000011	±0.00025	Pass
100%		+50	836,400,000	-24	-0.000003	±0.00025	Pass
115%		4.37	+20	836,400,000	38	0.000005	±0.00025
BAT.ENDPOINT	3.23	+20	836,400,000	-23	-0.000003	±0.00025	Pass

8. CONCLUSION

The data collected relate only the item(s) tested and show that the **Mobile Data Terminal** compliance with all the requirements of Parts 2, 22, 24, 27 of the FCC Rules.