



MEASUREMENT REPORT

FCC PART 15.225 NFC 13.56MHz

FCC ID: 2AC6AC70

APPLICANT: Shenzhen Chainway Information Technology Co., Ltd.

Application Type: Certification

Product: Mobile Data Terminal

Model No.: C70

Brand Name: CHAINWAY

FCC Classification: Part 15 Low Power Communication Device Transmitter
(DXX)

FCC Rule Part(s): Part 15.225

Test Procedure(s): ANSI C63.10-2013

Test Date: October 31 ~ December 28, 2017

Reviewed By : Kevin Guo
(Kevin Guo)

Approved By : Marlin Chen
(Marlin Chen)



The test results relate only to the samples tested.

This equipment has been shown to be capable of compliance with the applicable technical standards as indicated in the measurement report and was tested in accordance with the measurement procedures specified in ANSI C63.10. Test results reported herein relate only to the item(s) tested.

The test report shall not be reproduced except in full without the written approval of MRT Technology (Suzhou) Co., Ltd.

Revision History

Report No.	Version	Description	Issue Date	Note
1711RSU00105	Rev. 01	Initial report	12-30-2017	Valid

CONTENTS

Description	Page
§2.1033 General Information	5
1. INTRODUCTION	6
1.1. Scope	6
1.2. MRT Test Location	6
2. PRODUCT INFORMATION	7
2.1. Equipment Description.....	7
2.2. Test Mode	7
2.3. Device Capabilities	7
2.4. Test Configuration	8
2.5. EMI Suppression Device(s)/Modifications.....	8
2.6. Labeling Requirements.....	8
3. DESCRIPTION OF TEST	9
3.1. Evaluation Procedure	9
3.2. AC Line Conducted Emissions	9
3.3. Radiated Emissions.....	10
4. ANTENNA REQUIREMENTS.....	11
5. TEST EQUIPMENT CALIBRATION DATE	12
6. MEASUREMENT UNCERTAINTY.....	13
7. TEST RESULT	14
7.1. Summary	14
7.2. In-band Emission.....	15
7.2.1. Test Limit	15
7.2.2. Test Procedure Used	15
7.2.3. Test Setup.....	16
7.2.4. Test Result.....	17
7.3. Out-band Emission	18
7.3.1. Test Limit	18
7.3.2. Test Procedure Used	18
7.3.3. Test Setup.....	19
7.3.4. Test Result.....	20
7.4. 20dB Bandwidth	21
7.4.1. Test Limit	21
7.4.2. Test Procedure Used	21

7.4.3. Test Setup..... 21

7.4.4. Test Result..... 22

7.5. Frequency Tolerance..... 23

7.5.1. Test Limit 23

7.5.2. Test Procedure Used 23

7.5.3. Test Setup..... 23

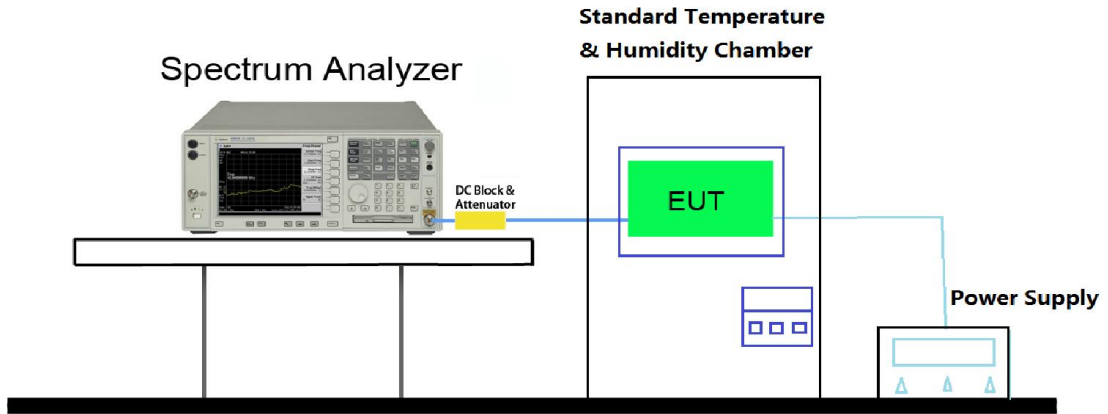

..... 23

7.5.4. Test Result..... 24

7.6. AC Conducted Emissions Measurement..... 25

7.6.1. Test Limit 25

7.6.2. Test Setup..... 25

7.6.3. Test Result..... 26

8. CONCLUSION..... 28

§2.1033 General Information

Applicant:	Shenzhen Chainway Information Technology Co., Ltd.			
Applicant Address:	9/F, Building 2, Daqian Industrial Park, Longchang Rd., District 67, Bao'an, Shenzhen, China			
Manufacturer:	Shenzhen Chainway Information Technology Co., Ltd.			
Manufacturer Address:	9/F, Building 2, Daqian Industrial Park, Longchang Rd., District 67, Bao'an, Shenzhen, China			
Test Site:	MRT Technology (Suzhou) Co., Ltd			
Test Site Address:	D8 Building, No.2 Tian'edang Rd., Wuzhong Economic Development Zone, Suzhou, China			
MRT Registration No.:	893164			
MRT designation No.:	CN1166			
Test Device Serial No.:	N/A	<input type="checkbox"/> Production	<input checked="" type="checkbox"/> Pre-Production	<input type="checkbox"/> Engineering

Test Facility / Accreditations

Measurements were performed at MRT Laboratory located in Tian'edang Rd., Suzhou, China.

- MRT facility is a FCC registered (MRT Reg. No. 893164) test facility with the site description report on file and has met all the requirements specified in Section 2.948 of the FCC Rules.
- MRT facility is an IC registered (MRT Reg. No. 11384A-1) test laboratory with the site description on file at Industry Canada.
- MRT facility is a VCCI registered (R-20025, G-20034, C-20020, T-20020) test laboratory with the site description on file at VCCI Council.
- MRT Lab is accredited to ISO 17025 by the American Association for Laboratory Accreditation (A2LA) under the American Association for Laboratory Accreditation Program (A2LA Cert. No. 3628.01) in EMC, Telecommunications and Radio testing for FCC, Industry Canada, EU and TELEC Rules.



1. INTRODUCTION

1.1. Scope

Measurement and determination of electromagnetic emissions (EMC) of radio frequency devices including intentional and/or unintentional radiators for compliance with the technical rules and regulations of the Federal Communications Commission and the Industry Canada Certification and Engineering Bureau.

1.2. MRT Test Location

The map below shows the location of the MRT LABORATORY, its proximity to the Taihu Lake. These measurement tests were conducted at the MRT Technology (Suzhou) Co., Ltd. Facility located at D8 Building, No.2 Tian'edang Rd., Wuzhong Economic Development Zone, Suzhou, China. The detailed description of the measurement facility was found to be in compliance with the requirements of § 2.948 according to ANSI C63.4-2009 on September 30, 2013.



2. PRODUCT INFORMATION

2.1. Equipment Description

Product Name:	Mobile Data Terminal
Model No.:	C70
Brand Name:	CHAINWAY
Hardware Version:	C70SEA_mb_v12
Software Version:	C70A_MT6735_V1.2_AM_GIT55c9324_20171104
Wi-Fi Specification:	802.11a/b/g/n
Bluetooth Version	V4.0 single mode
GSM Operation Band (s):	GSM 850 / 900 / 1800 / 1900
WCDMA Operation Band (s):	Band II / IV / V
LTE Operation Band (s):	FDD Band 2 / 4 / 7 / 12 / 17
NFC:	13.56MHz
GPS:	1575.42MHz
Components	
Adapter	Model No.: GME 10D-050200FUu Input Power: 100 - 240V ~ 50/60Hz, Max. 0.28A Output Power: 5VDC 2.0A

2.2. Test Mode

Test Mode
Mode 1: Transmit by NFC

2.3. Device Capabilities

This device contains the following capabilities:

GSM 850/900/1800/1900, WCDMA Band II/IV/V, LTE FDD Band 2/4/7/12/17, 2.4GHz WLAN (DTS), 5GHz WLAN (UNII), Bluetooth (v4.0 single mode), NFC.

2.4. Test Configuration

The **Mobile Data Terminal** was set to continuous transmission. This was performance using manufacturer software loaded on the terminal to allow for continuous transmission. This device was tested in accordance with the guidance of ANSI C63.10-2013. ANSI C63.4-2014 was used to reference the appropriate EUT setup for radiated spurious emissions testing and AC line conducted testing.

2.5. EMI Suppression Device(s)/Modifications

No EMI suppression device(s) were added and/or no modifications were made during testing.

2.6. Labeling Requirements

Per 2.1074 & 15.19; Docket 95-19

The label shall be permanently affixed at a conspicuous location on the device; instruction manual or pamphlet supplied to the user and be readily visible to the purchaser at the time of purchase.

However, when the device is so small wherein placement of the label with specified statement is not practical, only the FCC ID must be displayed on the device per Section 15.19(a)(5). Please see attachment for FCC ID label and label location.

3. DESCRIPTION OF TEST

3.1. Evaluation Procedure

The measurement procedures described in the American National Standard for Testing Unlicensed Wireless Devices (ANSI C63.10-2013) was used in the measurement of the **Mobile Data Terminal**.

Deviation from measurement procedure.....None

3.2. AC Line Conducted Emissions

The line-conducted facility is located inside an 8'x4'x4' shielded enclosure. A 1m x 2m wooden table 80cm high is placed 40cm away from the vertical wall and 80cm away from the sidewall of the shielded room. Two 10kHz-30MHz, 50Ω/50uH Line-Impedance Stabilization Networks (LISNs) are bonded to the shielded room floor. Power to the LISNs is filtered by external high-current high-insertion loss power line filters. These filters attenuate ambient signal noise from entering the measurement lines. These filters are also bonded to the shielded enclosure.

The EUT is powered from one LISN and the support equipment is powered from the second LISN. All interconnecting cables more than 1 meter were shortened to a 1 meter length by non-inductive bundling (serpentine fashion) and draped over the back edge of the test table. All cables were at least 40cm above the horizontal reference ground-plane. Power cables for support equipment were routed down to the second LISN while ensuring that that cables were not draped over the second LISN.

Sufficient time for the EUT, support equipment, and test equipment was allowed in order for them to warm up to their normal operating condition. The RF output of the LISN was connected to the receiver and exploratory measurements were made to determine the frequencies producing the maximum emission from the EUT. The receiver was scanned from 150kHz to 30MHz. The detector function was set to peak mode for exploratory measurements while the bandwidth of the analyzer was set to 9kHz. The EUT, support equipment, and interconnecting cables were arranged and manipulated to maximize each emission. Each emission was also maximized by varying: power lines, the mode of operation or data exchange speed, or support equipment whichever determined the worst-case emission. Once the worst case emissions have been identified, the one EUT cable configuration/arrangement and mode of operation that produced these emissions are used for final measurements on the same test site. The analyzer is set to CISPR quasi-peak and average detectors with a 9kHz resolution bandwidth for final measurements.

An extension cord was used to connect to a single LISN which powered by EUT. The extension cord was calibrated with LISN, the impedance and insertion loss are compliance with the requirements as stated in ANSI C63.10-2013 at Clause 4.3.

3.3. Radiated Emissions

The radiated test facilities consisted of an indoor 3 meter semi-anechoic chamber used for final measurements and exploratory measurements, when necessary. The measurement area is contained within the semi-anechoic chamber which is shielded from any ambient interference. For measurements above 1GHz absorbers are arranged on the floor between the turn table and the antenna mast in such a way so as to maximize the reduction of reflections. For measurements below 1GHz, the absorbers are removed. A MF Model 210SS turntable is used for radiated measurement. It is a continuously rotatable, remote controlled, metallic turntable and 2 meters (6.56 ft.) in diameter. The turn table is flush with the raised floor of the chamber in order to maintain its function as a ground plane. An 80cm high PVC support structure is placed on top of the turntable.

For all measurements, the spectrum was scanned through all EUT azimuths and from 1 to 4 meter receive antenna height using a broadband antenna from 30MHz up to the upper frequency shown in 15.33(b)(1) depending on the highest frequency generated or used in the device or on which the device operates or tunes. For frequencies above 1GHz, linearly polarized double ridge horn antennas were used. For frequencies below 30MHz, a calibrated loop antenna was used. When exploratory measurements were necessary, they were performed at 1 meter test distance inside the semi-anechoic chamber using broadband antennas, broadband amplifiers, and spectrum analyzers to determine the frequencies and modes producing the maximum emissions. Sufficient time for the EUT, support equipment, and test equipment was allowed in order for them to warm up to their normal operating condition. The test set-up was placed on top of the 0.8 meter high, 1 x 1.5 meter table. The EUT, support equipment, and interconnecting cables were arranged and manipulated to maximize each emission. Appropriate precaution was taken to ensure that all emissions from the EUT were maximized and investigated. The system configuration, clock speed, mode of operation or video resolution, if applicable, turntable azimuth, and receive antenna height was noted for each frequency found.

Final measurements were made in the semi-anechoic chamber using calibrated, linearly polarized broadband and horn antennas. The test setup was configured to the setup that produced the worst case emissions. The spectrum analyzer was set to investigate all frequencies required for testing to compare the highest radiated disturbances with respect to the specified limits. The turntable containing the EUT was rotated through 360 degrees and the height of the receive antenna was varied 1 to 4 meters and stopped at the azimuth and height producing the maximum emission. Each emission was maximized by changing the orientation of the EUT through three orthogonal planes and changing the polarity of the receive antenna, whichever produced the worst-case emissions. According to 3dB Beam-Width of horn antenna, the horn antenna should be always directed to the EUT when rising height.

4. ANTENNA REQUIREMENTS

Excerpt from §15.203 of the FCC Rules/Regulations:

“An intentional radiator antenna shall be designed to ensure that no antenna other than that furnished by the responsible party can be used with the device. The use of a permanently attached antenna or of an antenna that uses a unique coupling to the intentional radiator shall be considered sufficient to comply with the provisions of this section.”

- The antenna of the **Mobile Data Terminal** is **permanently attached**.
- There are no provisions for connection to an external antenna.

Conclusion:

The **Mobile Data Terminal** unit complies with the requirement of §15.203.

5. TEST EQUIPMENT CALIBRATION DATE

Conducted Emission - SR2

Instrument	Manufacturer	Type No.	Asset No.	Cali. Interval	Cali. Due Date
EMI Test Receiver	R&S	ESR3	MRTSUE06185	1 year	2018/04/25
Two-Line V-Network	R&S	ENV216	MRTSUE06002	1 year	2018/06/21
Two-Line V-Network	R&S	ENV216	MRTSUE06003	1 year	2018/06/21
Temperature/Humidity Meter	Yuhuaze	HTC-2	MRTSUE06181	1 year	2018/12/21
Shielding Anechoic Chamber	Mikebang	Chamber-SR2	MRTSUE06214	1 year	2018/05/10

Radiated Emissions - AC2

Instrument	Manufacturer	Type No.	Asset No.	Cali. Interval	Cali. Due Date
MXE EMI Receiver	Agilent	N9038A	MRTSUE06125	1 year	2018/08/18
EMI Test Receiver	R&S	ESR7	MRTSUE06001	1 year	2018/06/20
Loop Antenna	Schwarzbeck	FMZB1519	MRTSUE06025	1 year	2018/11/21
Bilog Period Antenna	Schwarzbeck	VULB9162	MRTSUE06022	1 year	2018/10/21
Digital Thermometer & Hygrometer	Minggao	ETH529	MRTSUE06170	1 year	2018/12/12
Anechoic Chamber	RIKEN	Chamber-AC2	MRTSUE06213	1 year	2018/05/10

Conducted Test Equipment - TR3

Instrument	Manufacturer	Type No.	Asset No.	Cali. Interval	Cali. Due Date
Spectrum Analyzer	Agilent	N9020A	MRTSUE06106	1 year	2018/04/25
Power Meter	Agilent	U2021XA	MRTSUE06030	1 year	2018/12/06
Thermohygrometer	Testo	608-H1	MRTSUE06401	1 year	2018/08/14

Software	Version	Function
e3	V 8.3.5	EMI Test Software

6. MEASUREMENT UNCERTAINTY

Where relevant, the following test uncertainty levels have been estimated for tests performed on the EUT as specified in CISPR 16-4-2. This uncertainty represents an expanded uncertainty expressed at approximately the 95% confidence level using a coverage factor of $k = 2$.

AC Conducted Emission Measurement - SR2
Measuring Uncertainty for a Level of Confidence of 95% ($U=2Uc(y)$): 150kHz~30MHz: 3.46dB
Radiated Emission Measurement - AC2
Measuring Uncertainty for a Level of Confidence of 95% ($U=2Uc(y)$): 9kHz ~ 1GHz: 4.18dB 1GHz ~ 25GHz: 4.76dB

7. TEST RESULT

7.1. Summary

Product Name: Mobile Data Terminal
FCC ID: 2AC6AC70
FCC Classification: Low Power Communication Device Transmitter (DXX)
Frequency Examined: 13.56MHz

FCC Part Section(s)	Test Description	Test Limit	Test Condition	Test Result	Reference
15.225 (a), (b), (c)	In-Band Emission	15,848uV/m @ 30m 13.553 ~ 13.567 MHz 334uV/m @ 30m 13.410 ~ 13.553 MHz 13.567 ~ 13.710 MHz 106uV/m @ 30m 13.110 ~ 13.410 MHz 13.710 ~ 14.010 MHz	Radiated	Pass	Section 7.2
15.225(d)	Out-Band Emission	Emissions outside of the specified band (13.110~14.010 MHz) must meet the radiated limits detailed in 15.209		Pass	Section 7.3
2.1049	20dB Bandwidth	N/A		Pass	Section 7.4
15.225(e)	Frequency Stability Tolerance	±0.01% of operating frequency		Pass	Section 7.5
15.207	AC Conducted Emissions 150kHz - 30MHz	< FCC 15.207 limits	Line Conducted	Pass	Section 7.6

Notes:

- 1) All modes of operation and data rates were investigated. For radiated emission test, every axis (X, Y, Z) was also verified. The test results shown in the following sections represent the worst case emissions.
- 2) The analyzer plots shown in this section were all taken with a correction table loaded into the analyzer. The correction table was used to account for the losses of the cables and attenuators used as part of the system to connect the EUT to the analyzer at all frequencies of interest.

7.2. In-band Emission

7.2.1. Test Limit

FCC Part 15 Subpart C Paragraph 15.225		
Frequency (MHz)	Distance (m)	Level (uV/m)
13.553 ~13.567	30	15848
13.410 ~13.553 13.567 ~13.710	30	334
13.110 ~13.410 13.710 ~14.010	30	106

Note 1: The lower limit shall apply at the transition frequency.

Note 2: Distance refers to the distance in meters between the measuring instrument antenna and the closed point of any part of the device or system.

Note 3: E field strength (dBuV/m) = 20 log E field strength (uV/m)

7.2.2. Test Procedure Used

The EUT was setup according to ANSI C63.4, 2014 and tested according to ANSI C63.10: 2013 for compliance to FCC 47CFR 15.225 requirements.

The EUT is placed on a turn table which is 0.8 meter above ground. The turn table is rotated 360 degrees to determine the position of the maximum emission level. The EUT was positioned such that the distance from antenna to the EUT was 3 meters.

The antenna is scanned from 1 meter to 4 meters to find out the maximum emission level. This is repeated for both horizontal and vertical polarization of the antenna. In order to find the maximum emission, all of the interface cables were manipulated according to ANSI C63.4:2014 on radiated measurement.

The EUT should be operate in transmission mode.

7.2.3. Test Setup

9kHz ~ 30MHz Test Setup:

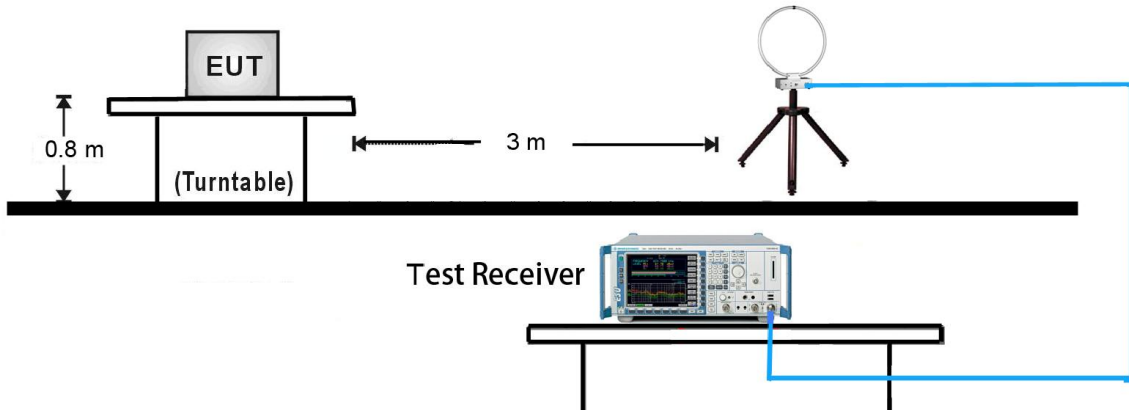

30MHz ~ 1GHz Test Setup:

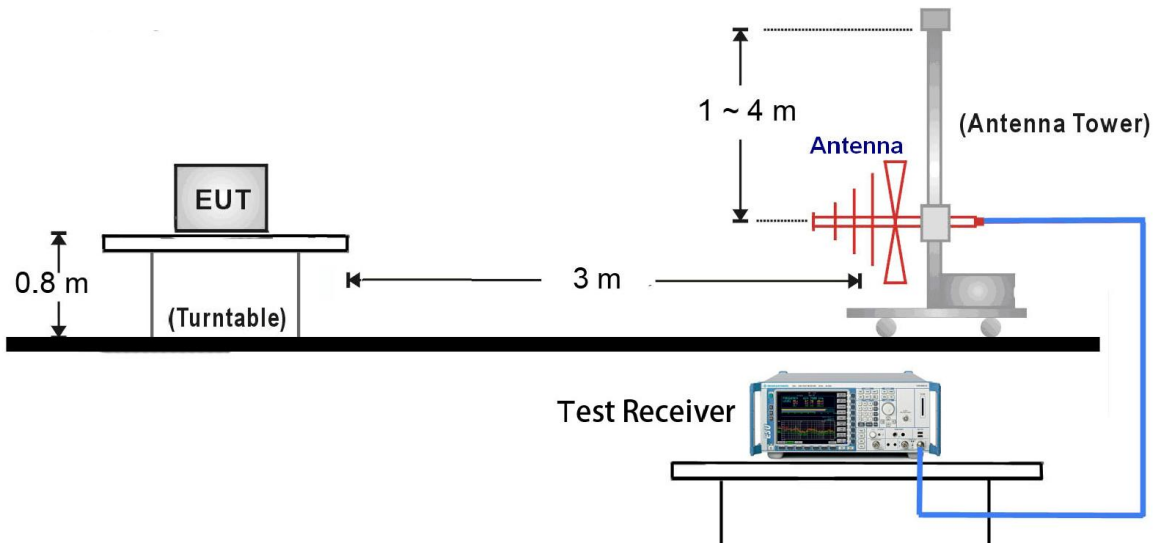

7.2.4. Test Result

Test Engineer	Snake Ni	Temperature	25°C
Test Time	2017/12/26	Relative Humidity	52%
Test Mode	Mode 1	Test Site	AC2

Frequency	Reading Level(dBuV/m)	Factor	Measure Level(dBuV/m)	Limit(3m) [dBuV/m]	Margin [dB]
Face On					
13.35	8.013	19.85	27.859	80.51	-52.65
13.53	15.418	19.86	35.282	90.47	-55.19
13.56	34.011	19.87	53.875	123.99	-70.12
13.57	30.902	19.86	50.766	90.47	-39.70
13.77	7.985	19.88	27.860	80.51	-52.65
Face Off					
13.31	7.448	19.85	27.298	80.51	-53.21
13.54	16.226	19.86	36.089	90.47	-54.38
13.56	30.928	19.87	50.792	123.99	-73.20
13.58	15.053	19.86	34.916	90.47	-55.55
13.80	7.687	19.88	27.566	80.51	-52.94

Note1: All measurements were performed using a loop antenna. The antenna was positioned in two orthogonal (face on and face off) and the position with the highest emission level was recorded.

Note2: Measurements were tested at 3m and the data was extrapolated to the specified measurement distance of 30m using the square of an inverse linear extrapolation factor (40 dB/decade) as specified in &15.31(f)(2).

Extrapolation Factor = $40 * \log(30/3) = 40 \text{ dB}$

Note3: All measurements were recorded using a EMI test receiver employing a peak detector.

7.3. Out-band Emission

7.3.1. Test Limit

FCC Part 15 Subpart C Paragraph 15.209		
Frequency (MHz)	Distance (m)	Level (uV/m)
0.009 - 0.490	300	2400/F (kHz)
0.490 - 1.705	30	2400/F (kHz)
1.705 - 30	30	30
30 - 88	3	100
88 - 216	3	150
216 - 960	3	200
Above 960	3	500

Note 1: The lower limit shall apply at the transition frequency.

Note 2: Distance refers to the distance in meters between the measuring instrument antenna and the closed point of any part of the device or system.

Note 3: E field strength (dBuV/m) = 20 log E field strength (uV/m)

7.3.2. Test Procedure Used

The EUT was tested from 9kHz up to the 1GHz excluding the band 13.110-14.010 MHz. All measurements were recorded with a spectrum analyzer employing an average detector for emissions below 30MHz. Above 30MHz a Quasi-peak detector was used. All out-of-band emissions must not exceed the limits shown as stated per Section 15.209. A loop antenna was used for searching for emissions below 30MHz.

7.3.3. Test Setup

9kHz ~ 30MHz Test Setup:

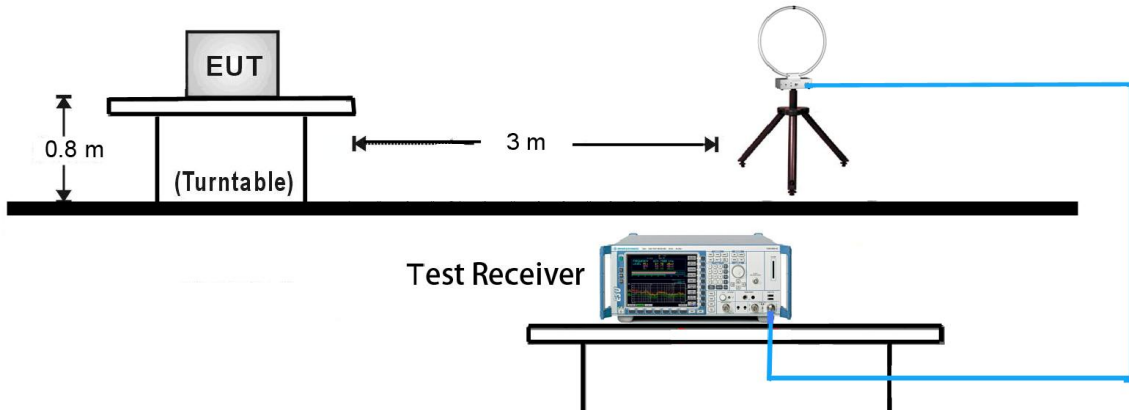

30MHz ~ 1GHz Test Setup:

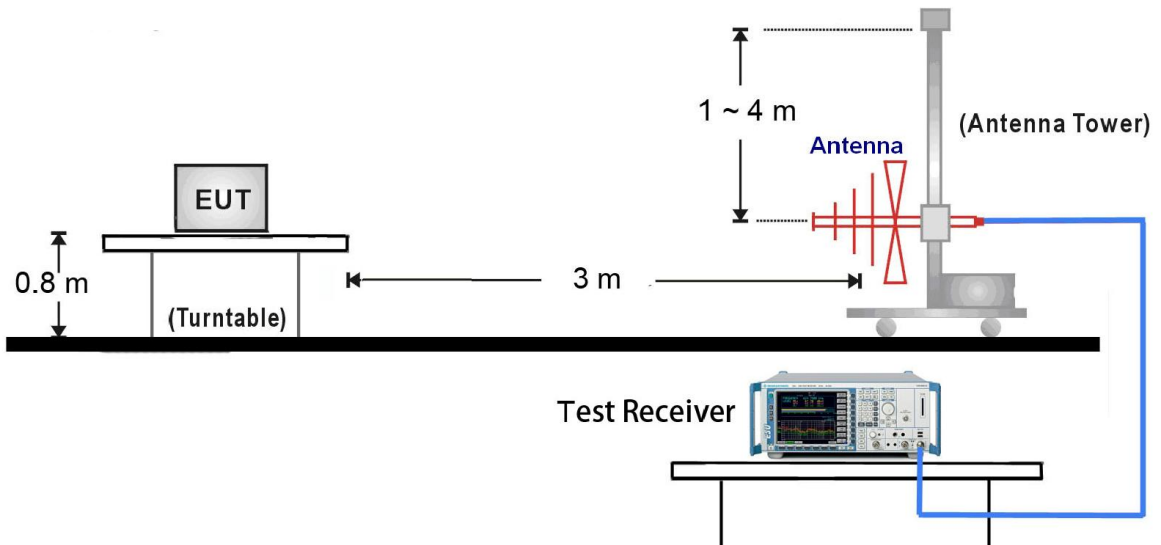

7.3.4. Test Result

Test Engineer	Snake Ni	Temperature	25°C
Test Time	2017/12/26	Relative Humidity	52%
Test Mode	Mode1	Test Site	AC2

Out-Band Emission Below 30MHz						
Frequency (MHz)	Reading Level (dBuV/m)	Factor (dB)	Measure Level (dBuV/m)	Limit (dBuV/m)	Margin (dB)	Detector
Face On						
2.60	15.85	20.42	36.27	69.54	-33.27	QP
Face Off						
2.43	16.37	20.42	36.79	69.54	-32.75	QP

Out-Band Emission Above 30MHz							
Antenna	Frequency (MHz)	Reading Level (dBuV/m)	Factor (dB)	Measure Level (dBuV/m)	Limit (dBuV/m)	Margin (dB)	Detector
H	54.250	-2.433	13.763	11.330	40.000	-28.670	QP
H	160.465	-1.368	15.136	13.768	43.500	-29.732	QP
H	384.050	-2.643	16.177	13.534	46.000	-32.466	QP
H	554.770	-0.317	19.555	19.238	46.000	-26.762	QP
H	727.915	-0.969	22.410	21.441	46.000	-24.559	QP
H	852.560	-1.222	23.675	22.453	46.000	-23.547	QP
V	32.910	10.965	13.727	24.692	40.000	-15.308	QP
V	53.280	-0.895	13.826	12.931	40.000	-27.069	QP
V	151.735	-1.865	15.186	13.321	43.500	-30.179	QP
V	308.390	-1.965	14.519	12.554	46.000	-33.446	QP
V	525.185	-1.629	18.989	17.360	46.000	-28.640	QP
V	712.395	-0.758	22.177	21.419	46.000	-24.581	QP

Note1: All measurements were performed using a loop antenna. The antenna was positioned in two orthogonal (face on and face off) and the position with the highest emission level was recorded.

Note2: Measurements were tested at 3m and the data was extrapolated to the specified measurement distance of 30m using the square of an inverse linear extrapolation factor (40 dB/decade) as specified in §15.31(f)(2).

Extrapolation Factor = $40 * \log(30/3) = 40 \text{ dB}$

Note3: All measurements were recorded using a EMI test receiver employing a peak detector.

7.4. 20dB Bandwidth

7.4.1. Test Limit

N/A

7.4.2. Test Procedure Used

The 20dB bandwidth is measured with a spectrum analyzer connected via a receive antenna placed near the EUT while the EUT is operating in transmission mode.

7.4.3. Test Setup

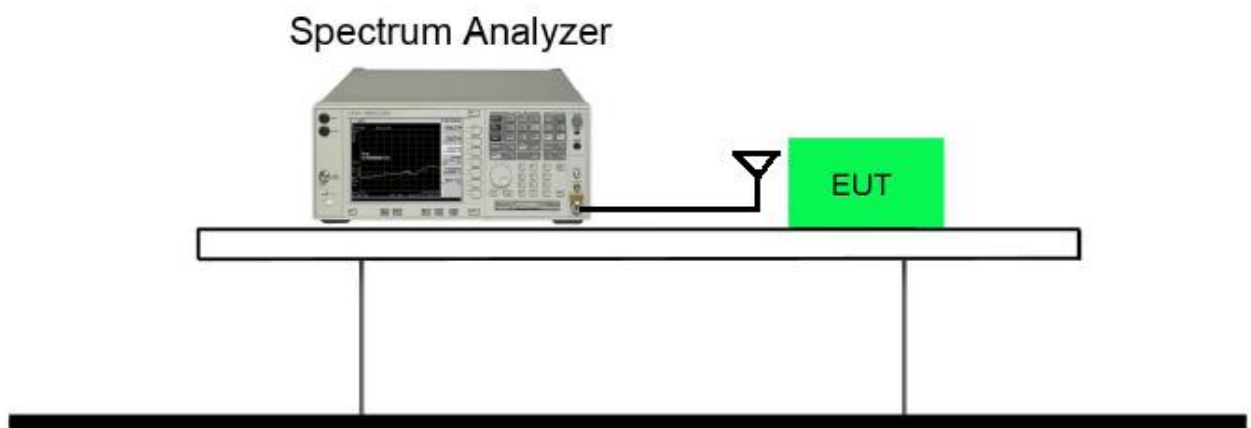

7.4.4. Test Result

Test Engineer	Snake Ni	Temperature	26°C
Test Time	2017/12/26	Relative Humidity	53%
Test Mode	Mode1	Test Site	AC2

Frequency (MHz)	Occupied Bandwidth (kHz)
13.56	18.1



7.5. Frequency Tolerance

7.5.1. Test Limit

The frequency tolerance of the carrier signal shall be maintained within $\pm 0.01\%$ of the operating frequency.

7.5.2. Test Procedure Used

The equipment under test was connected to an external AC or DC power supply and input rated voltage. RF output was connected to a frequency counter or spectrum analyzer via feed through attenuators. The EUT was placed inside the temperature chamber. Set the spectrum analyzer RBW low enough to obtain the desired frequency resolution and measure EUT 20°C operating frequency as reference frequency. Turn EUT off and set the chamber temperature to highest. After the temperature stabilized for approximately 30 minutes recorded the frequency. Repeat step measure with 10°C decreased per stage until the lowest temperature reached.

7.5.3. Test Setup

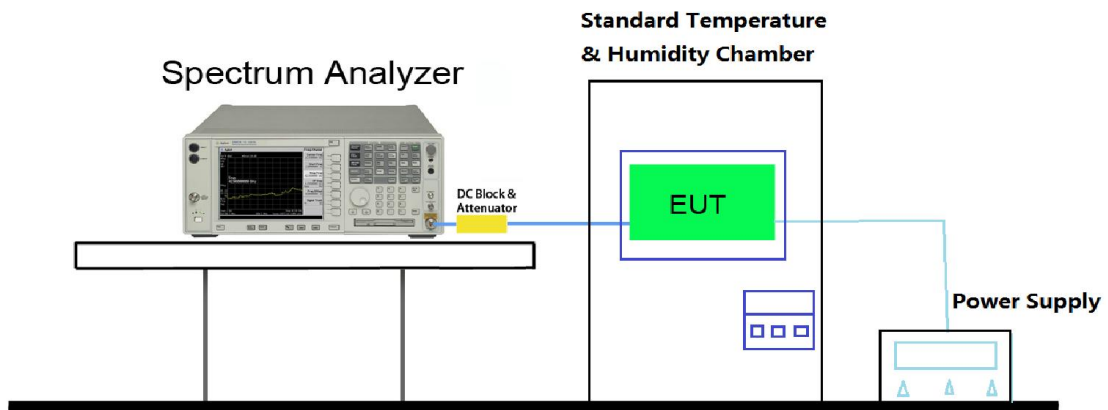

7.5.4. Test Result

Test Engineer	Milo Li	Temperature	26°C
Test Time	2017/12/26	Relative Humidity	53%
Test Mode	Mode1	Test Site	AC2

Operating Frequency: 13.56MHz					
Reference Voltage: 3.8Vdc					
Deviation Limit: +/- 0.01% = 1356Hz					
Voltage (%)	Power Battery	TEMP (°C)	FREQ. (Hz)	FREQ. Dev. (Hz)	Deviation (%)
100%	3.80	+20(Ref)	13,558,450	-1,550	-0.011431
100%		-30	13,558,571	-1,429	-0.010538
100%		-20	13,558,643	-1,357	-0.010007
100%		-10	13,558,887	-1,113	-0.008208
100%		0	13,558,945	-1,055	-0.007780
100%		+10	13,559,245	-755	-0.005568
100%		+20	13,560,042	42	0.000310
100%		+30	13,560,765	765	0.005642
100%		+40	13,560,923	923	0.006807
100%		+50	13,561,275	1,275	0.009403
Battery End Point	3.40	+20	13,559,512	-488	-0.003599
115%	4.37	+20	13,561,345	1,345	0.009919

7.6. AC Conducted Emissions Measurement

7.6.1. Test Limit

FCC Part 15 Subpart C Paragraph 15.207 Limits		
Frequency (MHz)	QP (dBuV)	AV (dBuV)
0.15 - 0.50	66 - 56	56 - 46
0.50 - 5.0	56	46
5.0 - 30	60	50

Note 1: The lower limit shall apply at the transition frequencies.

Note 2: The limit decreases linearly with the logarithm of the frequency in the range 0.15MHz to 0.5MHz.

7.6.2. Test Setup

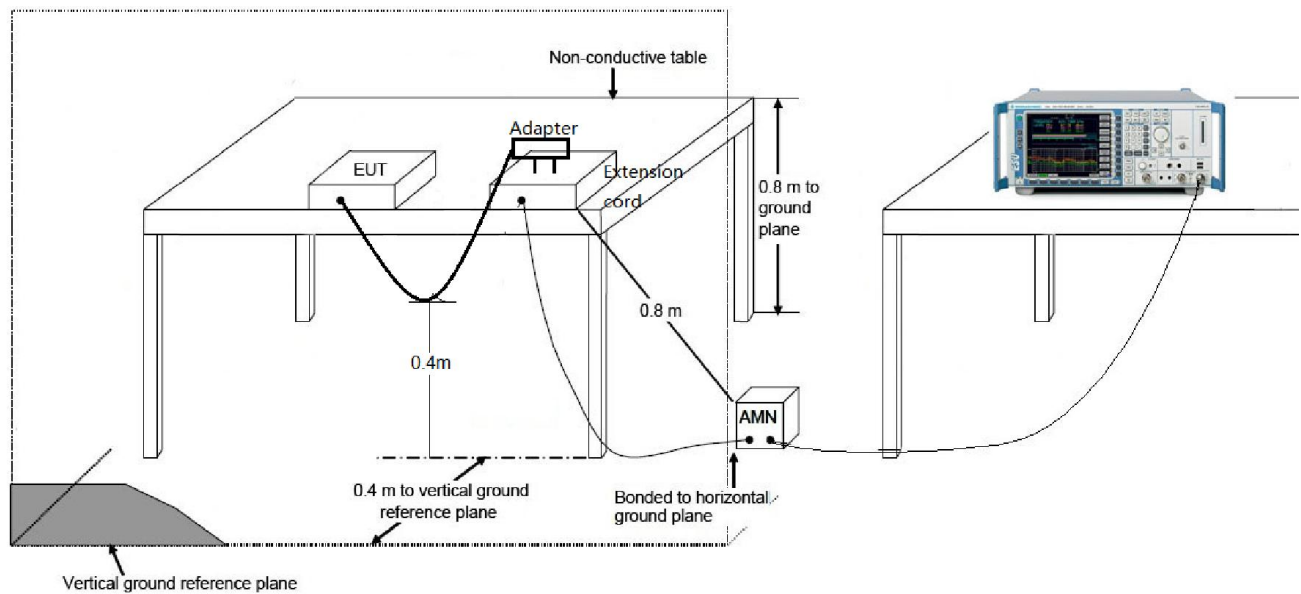

7.6.3. Test Result

Site: SR2	Time: 2017/11/29 - 11:46
Limit: FCC_Part15.207_CE_AC Power	Engineer: Polly Zong
Probe: ENV216_101683_Filter On	Polarity: Line
EUT: Mobile Data Terminal	Power: AC 120V/60Hz
Test Mode: Mode 1	

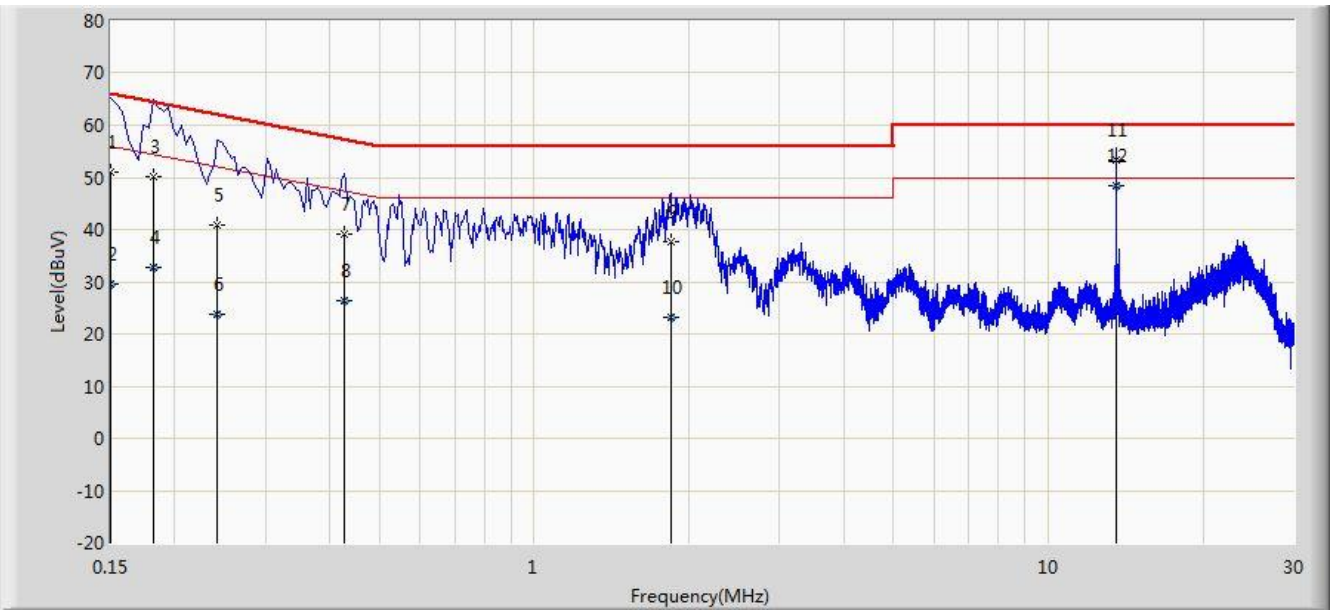

No	Flag	Mark	Frequency (MHz)	Measure Level (dBuV)	Reading Level (dBuV)	Over Limit (dB)	Limit (dBuV)	Factor (dB)	Type
1			0.150	50.890	39.722	-15.110	66.000	11.168	QP
2			0.150	29.496	18.327	-26.504	56.000	11.168	AV
3			0.182	50.223	40.175	-14.171	64.394	10.048	QP
4			0.182	32.665	22.617	-21.728	54.394	10.048	AV
5			0.242	40.890	30.933	-21.137	62.027	9.958	QP
6			0.242	23.771	13.814	-28.256	52.027	9.958	AV
7			0.426	39.112	29.005	-18.219	57.330	10.107	QP
8			0.426	26.300	16.193	-21.030	47.330	10.107	AV
9			1.842	37.569	27.693	-18.431	56.000	9.876	QP
10			1.842	23.271	13.395	-22.729	46.000	9.876	AV
11			13.558	53.361	43.303	-6.639	60.000	10.058	QP
12		*	13.558	48.516	38.458	-1.484	50.000	10.058	AV

Note: Measure Level (dBμV) = Reading Level (dBμV) + Factor (dB)

Factor (dB) = Cable Loss (dB) + LISN Factor (dB).

Site: SR2	Time: 2017/11/29 - 11:51
Limit: FCC_Part15.207_CE_AC Power	Engineer: Polly Zong
Probe: ENV216_101683_Filter On	Polarity: Neutral
EUT: Mobile Data Terminal	Power: AC 120V/60Hz
Test Mode: Mode 1	

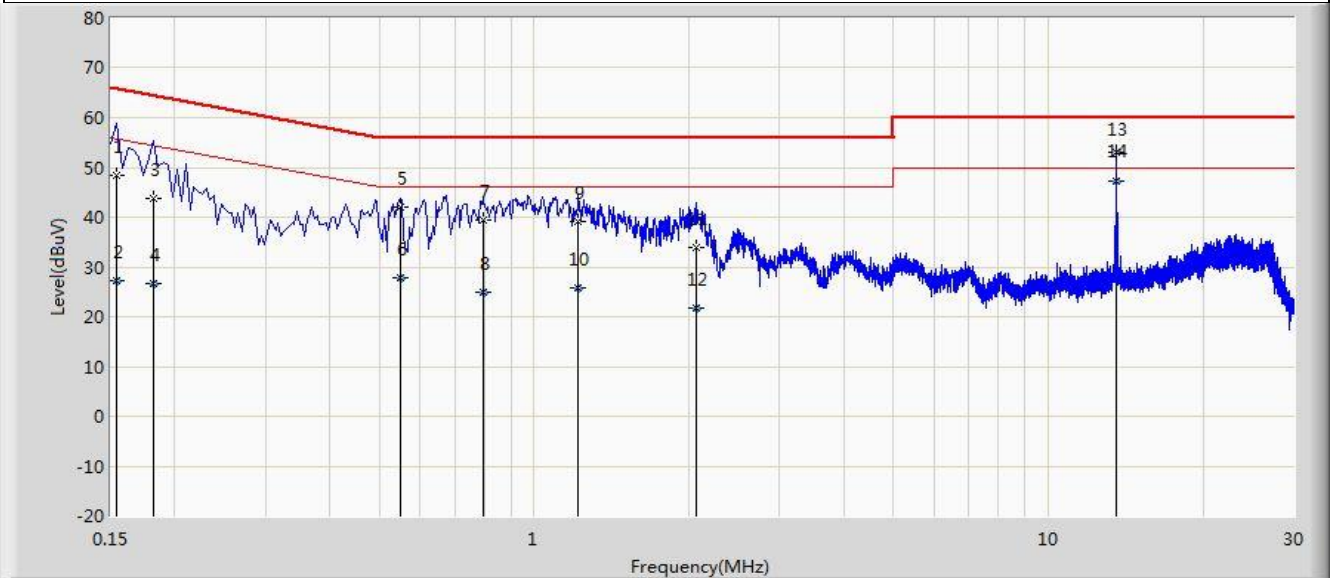

No	Flag	Mark	Frequency (MHz)	Measure Level (dBuV)	Reading Level (dBuV)	Over Limit (dB)	Limit (dBuV)	Factor (dB)	Type
1			0.154	48.293	37.577	-17.489	65.781	10.716	QP
2			0.154	27.122	16.406	-28.660	55.781	10.716	AV
3			0.182	43.766	33.724	-20.627	64.394	10.042	QP
4			0.182	26.796	16.753	-27.598	54.394	10.042	AV
5			0.550	42.159	32.000	-13.841	56.000	10.159	QP
6			0.550	27.863	17.704	-18.137	46.000	10.159	AV
7			0.794	39.491	29.468	-16.509	56.000	10.023	QP
8			0.794	25.014	14.991	-20.986	46.000	10.023	AV
9			1.218	39.168	29.267	-16.832	56.000	9.901	QP
10			1.218	25.770	15.868	-20.230	46.000	9.901	AV
11			2.062	33.970	24.098	-22.030	56.000	9.872	QP
12			2.062	21.804	11.932	-24.196	46.000	9.872	AV
13			13.558	52.576	42.477	-7.424	60.000	10.100	QP
14		*	13.558	47.125	37.026	-2.875	50.000	10.100	AV

Note: Measure Level (dB μ V) = Reading Level (dB μ V) + Factor (dB)

Factor (dB) = Cable Loss (dB) + LISN Factor (dB).

8. CONCLUSION

The data collected relate only the item(s) tested and show that the **Mobile Data Terminal** is in compliance with Part 15C of the FCC Rules.

The End