

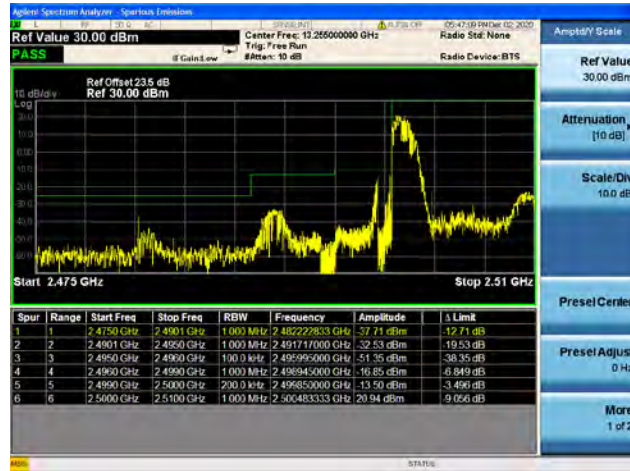

Band7 / 10MHz / Low CH / QPSK / 1 RB



Band7 / 10MHz / Low CH / QPSK / FULL RB



Band7 / 10MHz / High CH / QPSK / 1 RB

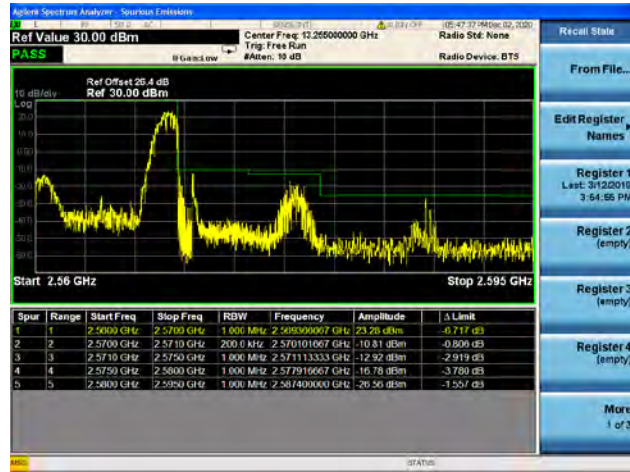

Band7 / 10MHz / High CH / QPSK / FULL RB

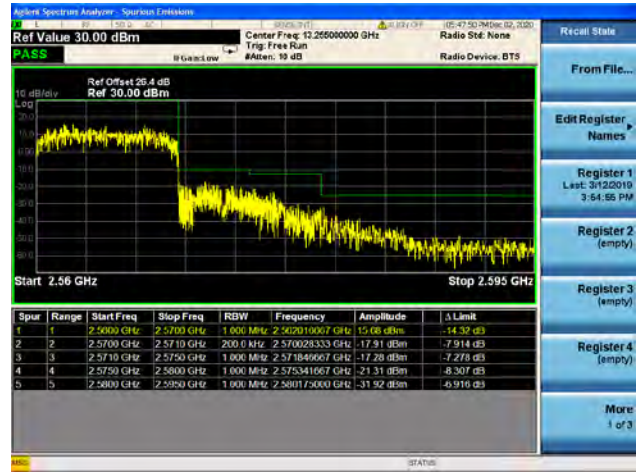

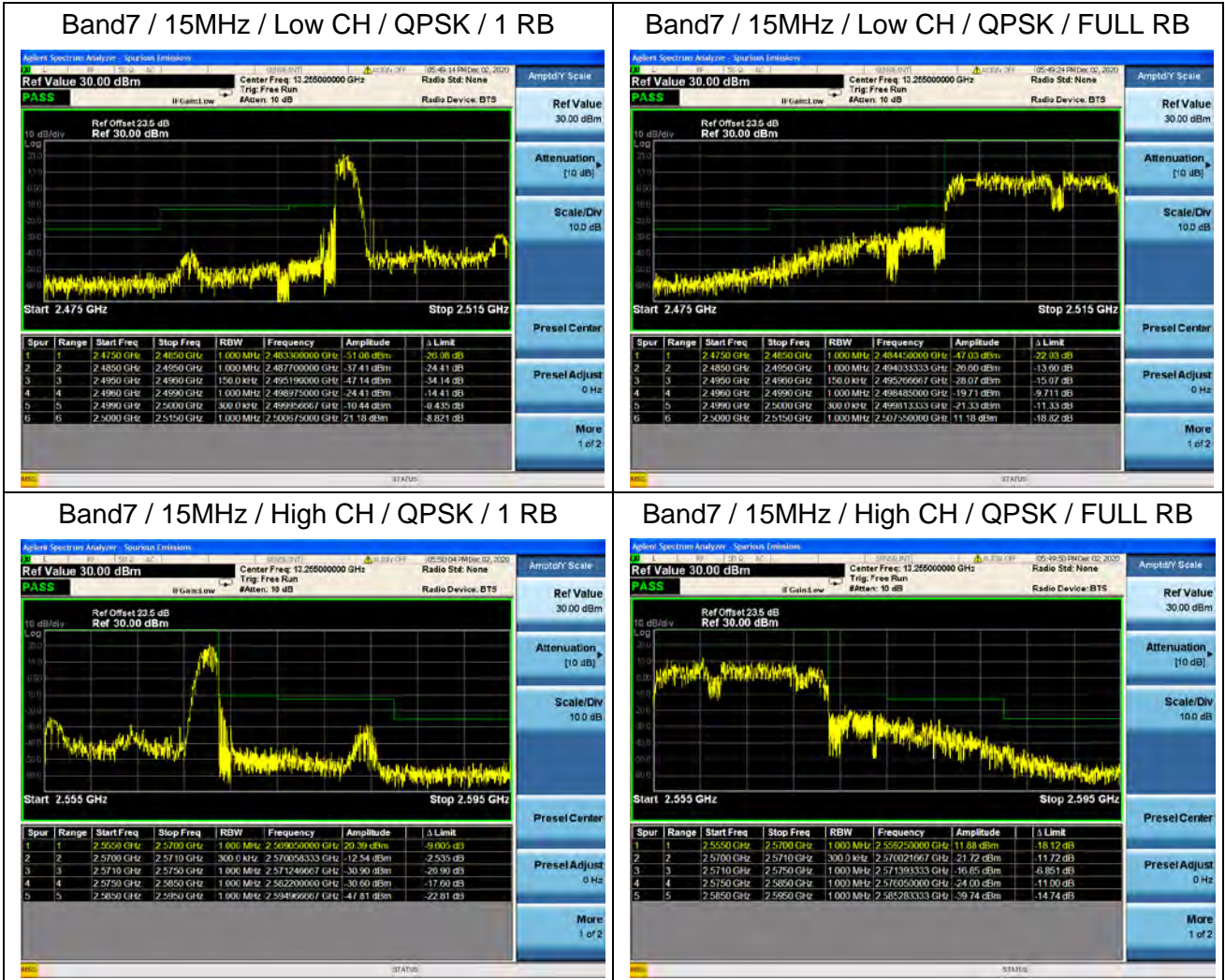



Band7 / 20MHz / Low CH / QPSK / 1 RB

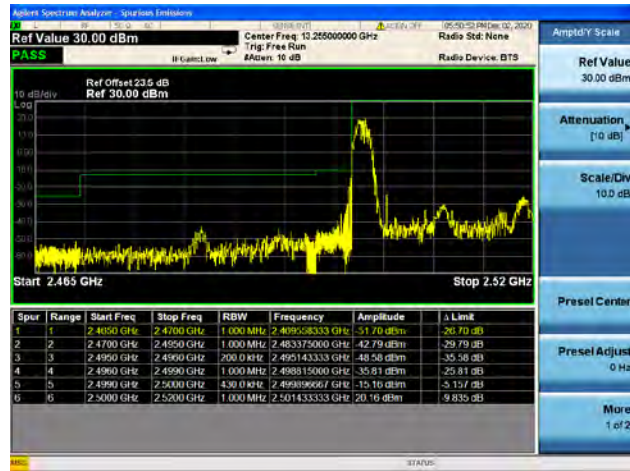

Band7 / 20MHz / Low CH / QPSK / FULL RB

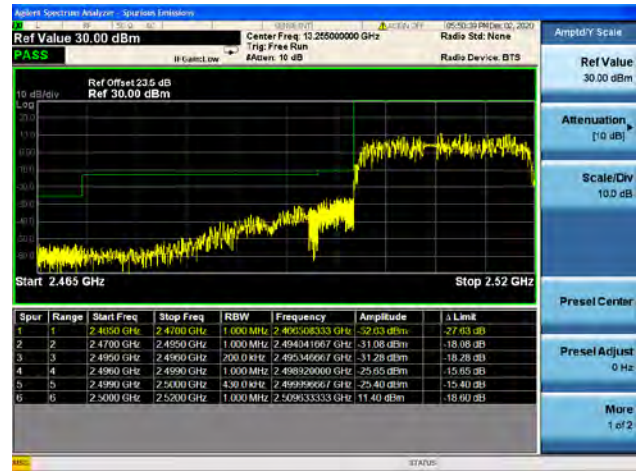

Band7 / 20MHz / High CH / QPSK / 1 RB

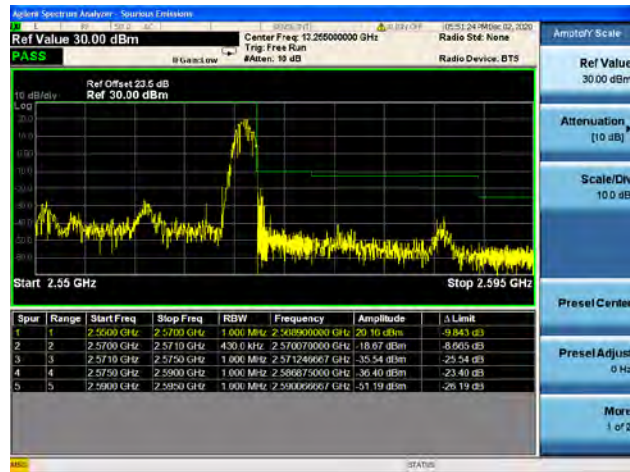

Band7 / 20MHz / High CH / QPSK / FULL RB

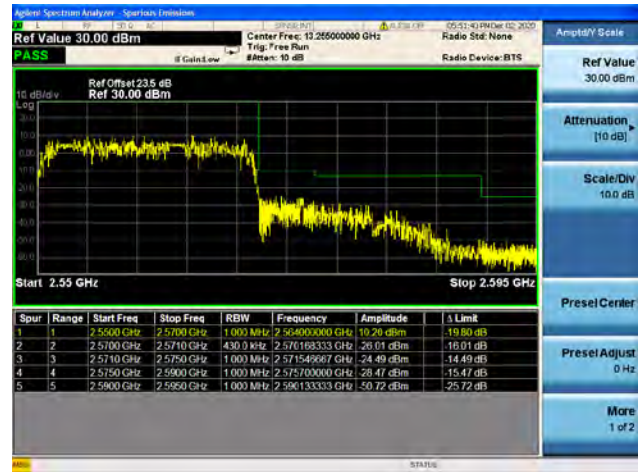



Band12 / 1.4MHz / Low CH / QPSK / 1 RB



Band12 / 1.4MHz / Low CH / QPSK / FULL RB



Band12 / 1.4MHz / High CH / QPSK / 1 RB



Band12 / 1.4MHz / High CH / QPSK / FULL RB



Band12 / 3MHz / Low CH / QPSK / 1 RB



Band12 / 3MHz / Low CH / QPSK / FULL RB





Band12 / 3MHz / High CH / QPSK / 1 RB



Band12 / 3MHz / High CH / QPSK / FULL RB



Band12 / 5MHz / Low CH / QPSK / 1 RB



Band12 / 5MHz / Low CH / QPSK / FULL RB



Band12 / 5MHz / High CH / QPSK / 1 RB



Band12 / 5MHz / High CH / QPSK / FULL RB





Band12 / 10MHz / Low CH / QPSK / 1 RB



Band12 / 10MHz / Low CH / QPSK / FULL RB



Band12 / 10MHz / High CH / QPSK / 1 RB



Band12 / 10MHz / High CH / QPSK / FULL RB





Band17 / 5MHz / Low CH / QPSK / 1 RB



Band17 / 5MHz / Low CH / QPSK / FULL RB



Band17 / 5MHz / High CH / QPSK / 1 RB



Band17 / 5MHz / High CH / QPSK / FULL RB



Band17 / 10MHz / Low CH / QPSK / 1 RB



Band17 / 10MHz / Low CH / QPSK / FULL RB





Band17 / 10MHz / High CH / QPSK / 1 RB

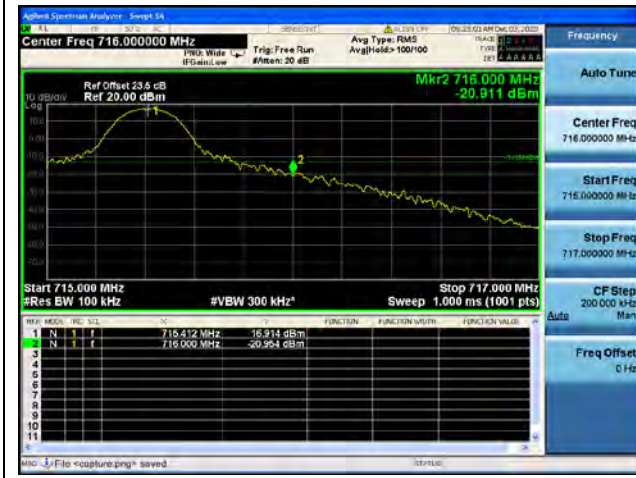

Band17 / 10MHz / High CH / QPSK / FULL RB





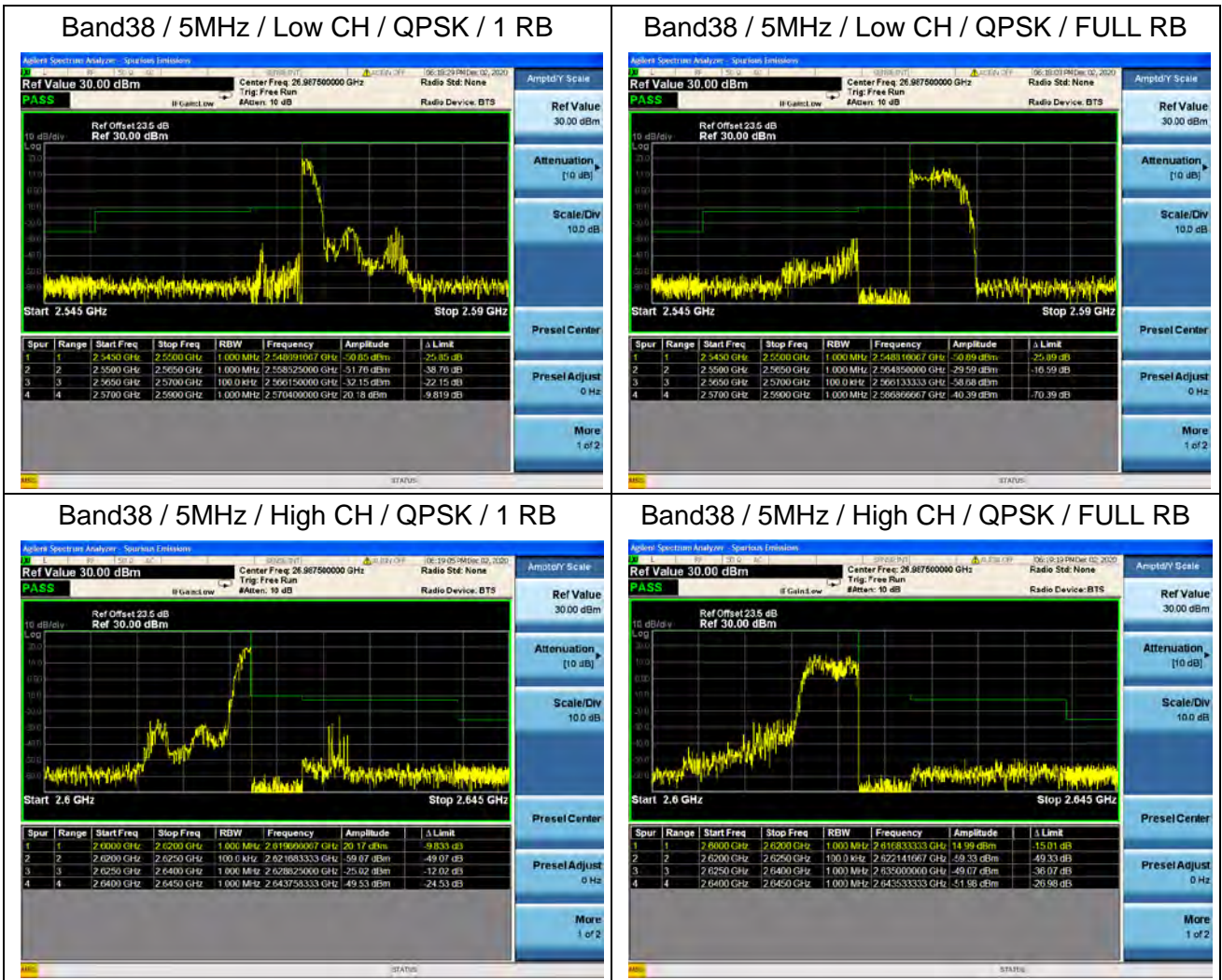



Band38 / 10MHz / Low CH / QPSK / 1 RB

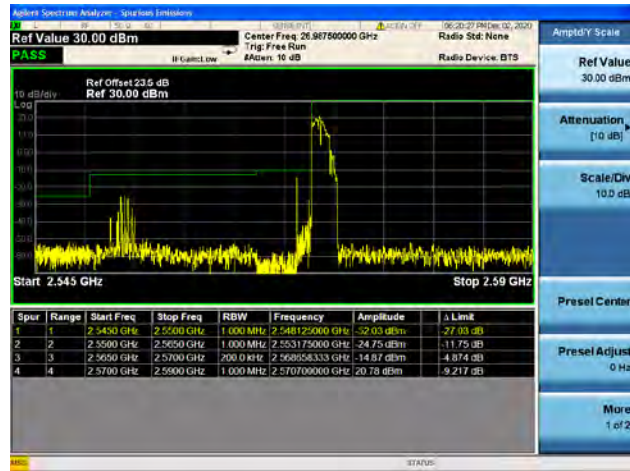

Band38 / 10MHz / Low CH / QPSK / FULL RB

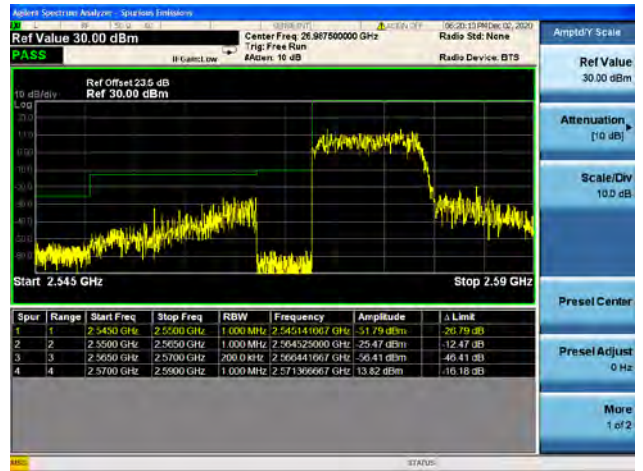

Band38 / 10MHz / High CH / QPSK / 1 RB

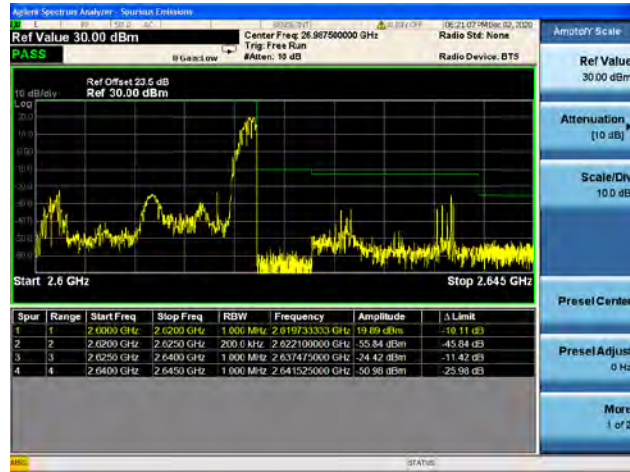

Band38 / 10MHz / High CH / QPSK / FULL RB

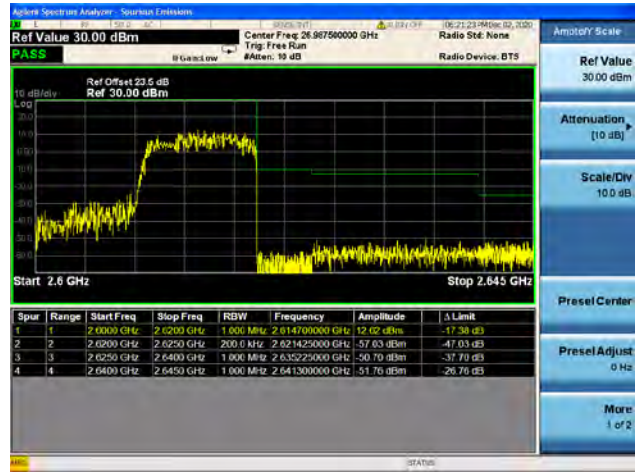



Band38 / 15MHz / Low CH / QPSK / 1 RB

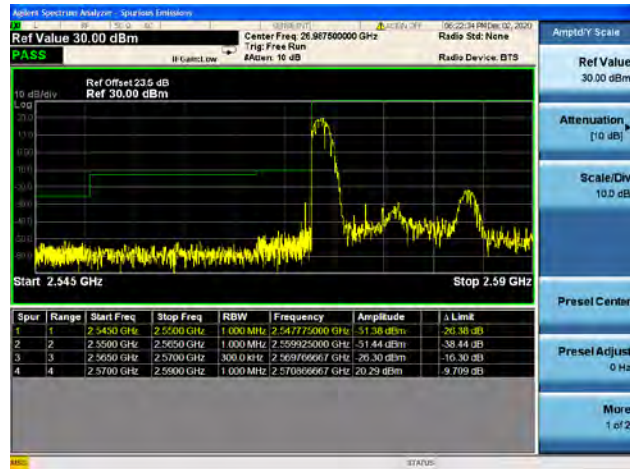

Band38 / 15MHz / Low CH / QPSK / FULL RB

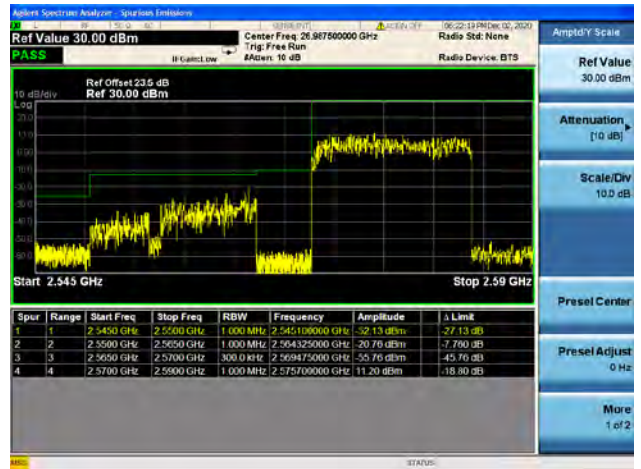

Band38 / 15MHz / High CH / QPSK / 1 RB

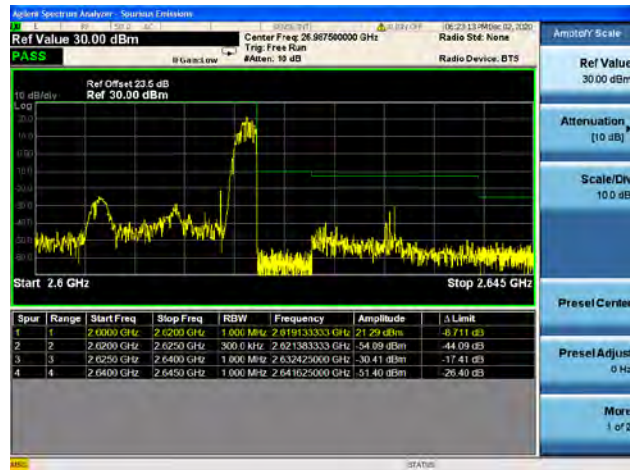

Band38 / 15MHz / High CH / QPSK / FULL RB

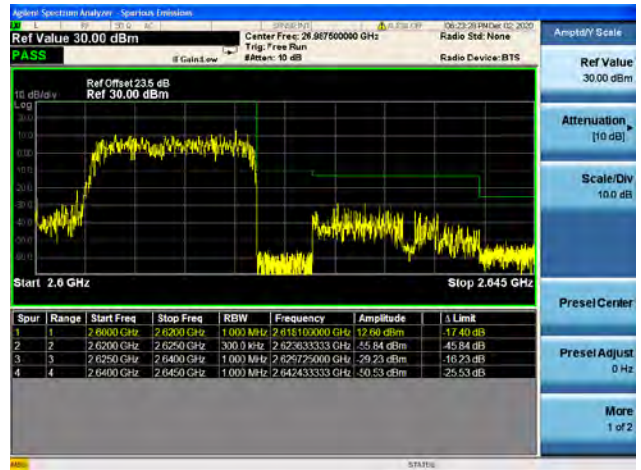

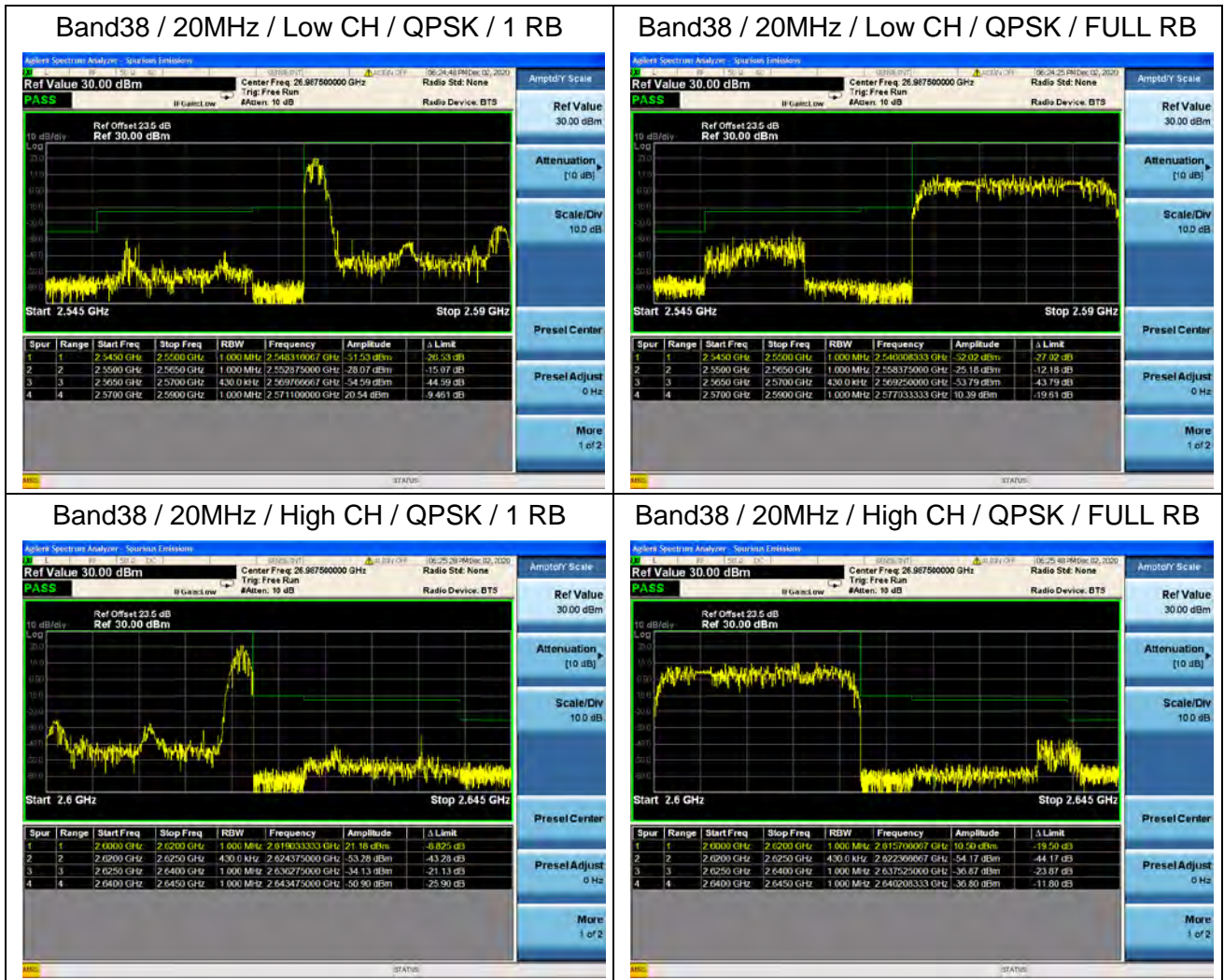

Band 40, Block A

Band40 / 5MHz / Low CH / QPSK / 1 RB

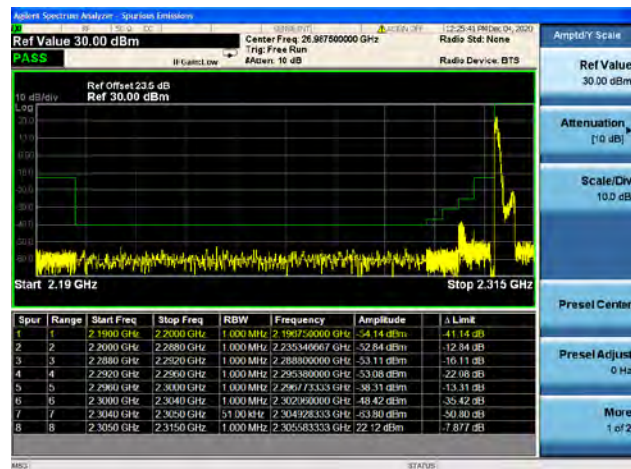

Band40 / 5MHz / Low CH / QPSK / FULL RB

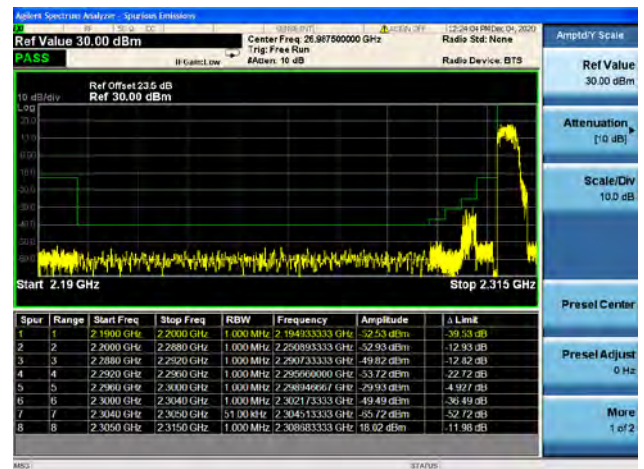

Band40 / 5MHz / High CH / QPSK / 1 RB

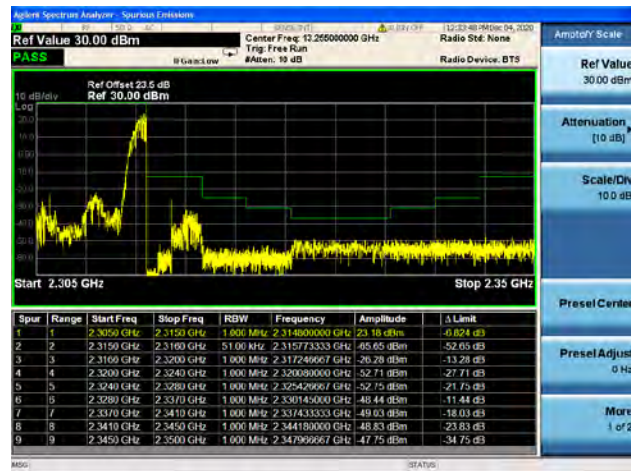

Band40 / 5MHz / High CH / QPSK / FULL RB

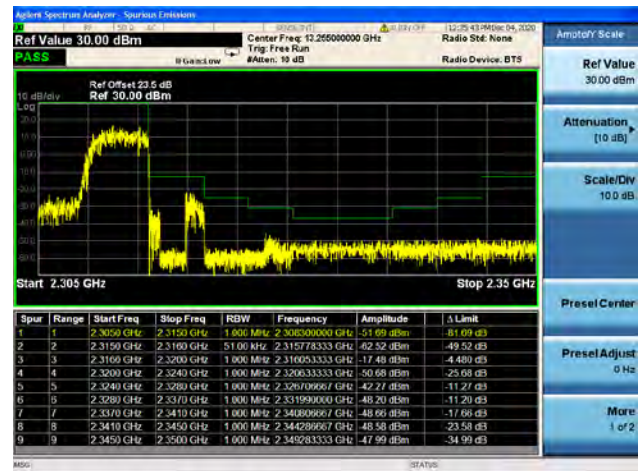

Band 40, Block A

Band40 / 10MHz / Low CH / QPSK / 1 RB

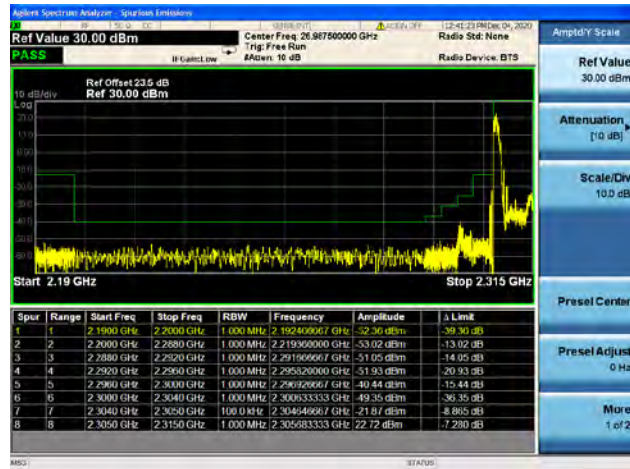

Band40 / 10MHz / Low CH / QPSK / FULL RB

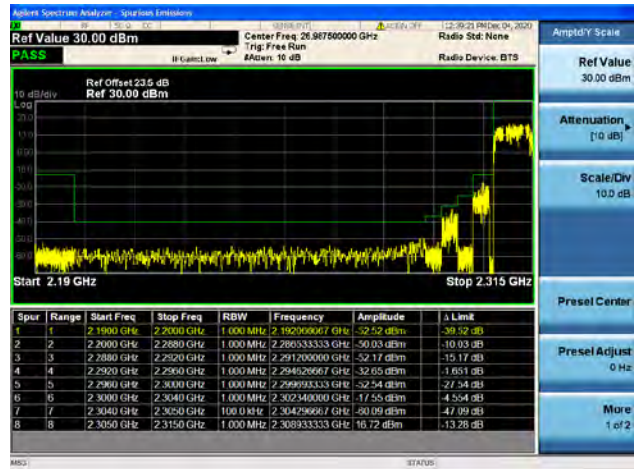

Band40 / 10MHz / High CH / QPSK / 1 RB

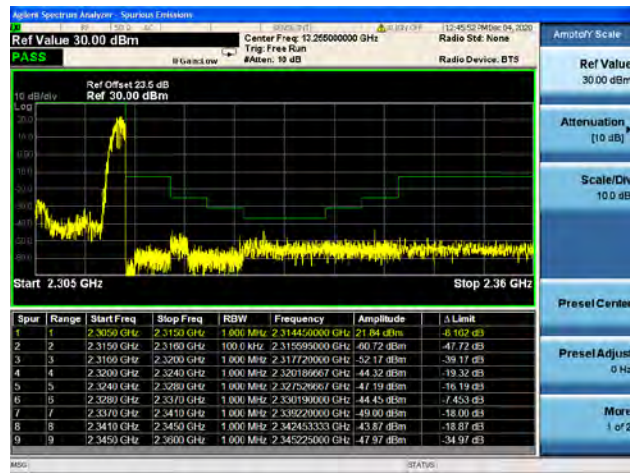

Band40 / 10MHz / High CH / QPSK / FULL RB

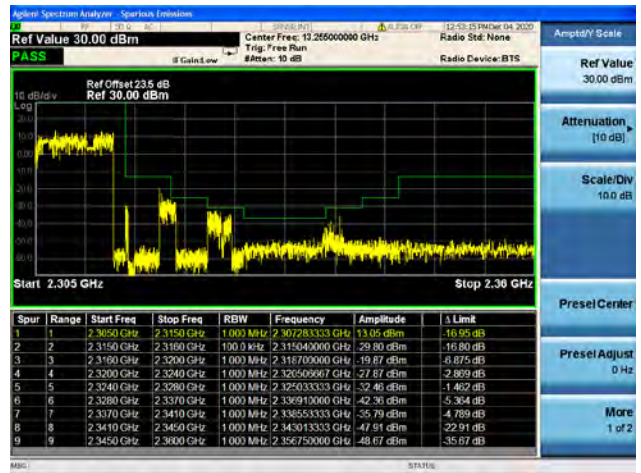

Band 40, Block B

Band40 / 5MHz / Low CH / QPSK / 1 RB

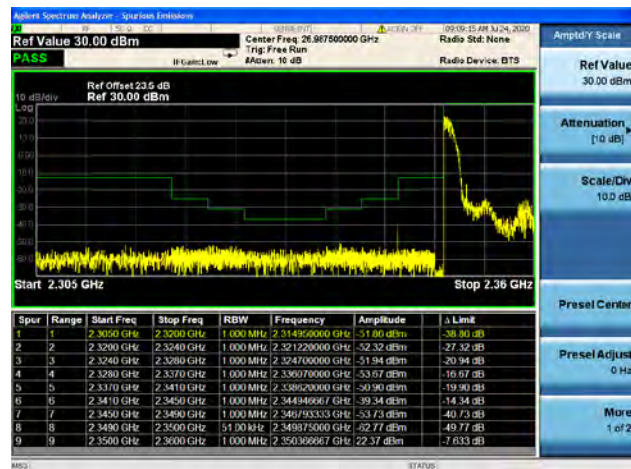

Band40 / 5MHz / Low CH / QPSK / FULL RB

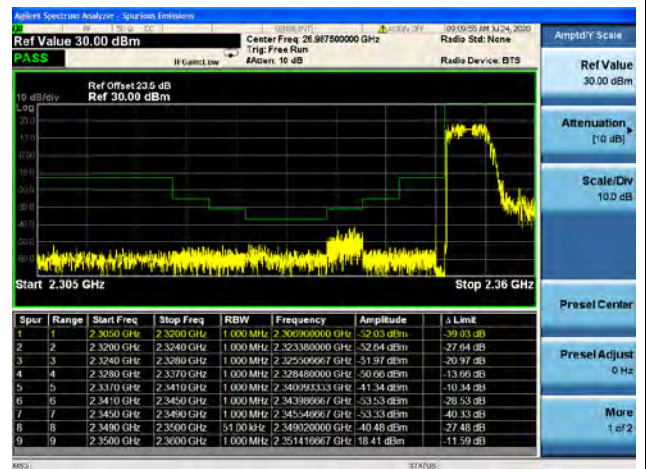

Band40 / 5MHz / High CH / QPSK / 1 RB

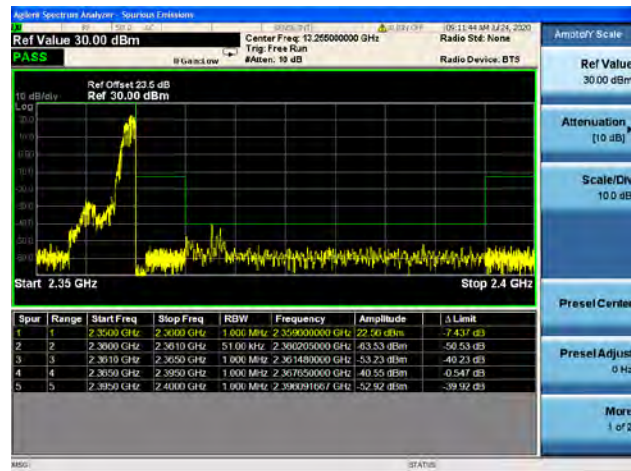

Band40 / 5MHz / High CH / QPSK / FULL RB

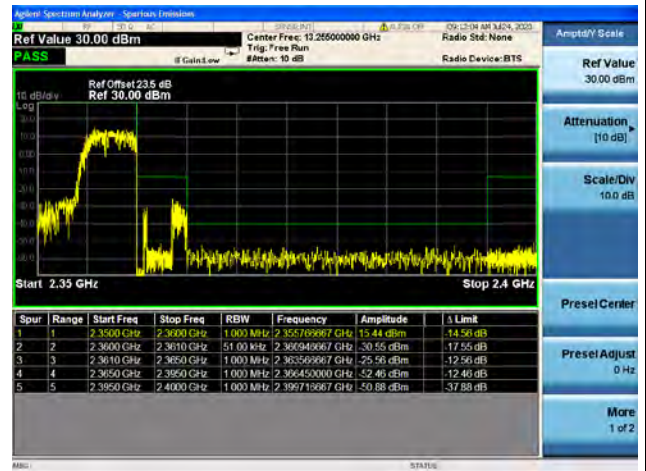

Band 40, Block B

Band40 / 10MHz / Low CH / QPSK / 1 RB

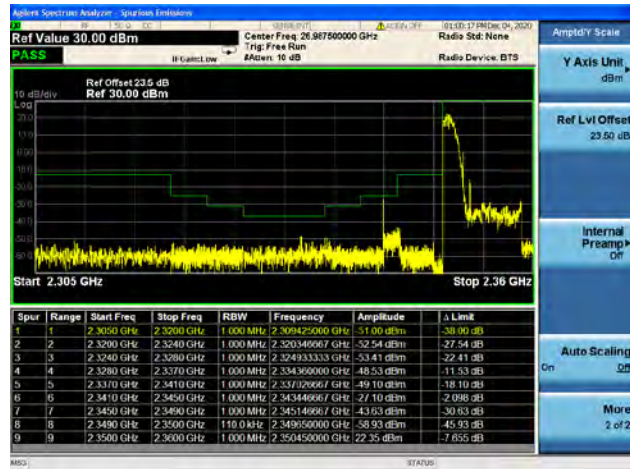

Band40 / 10MHz / Low CH / QPSK / FULL RB

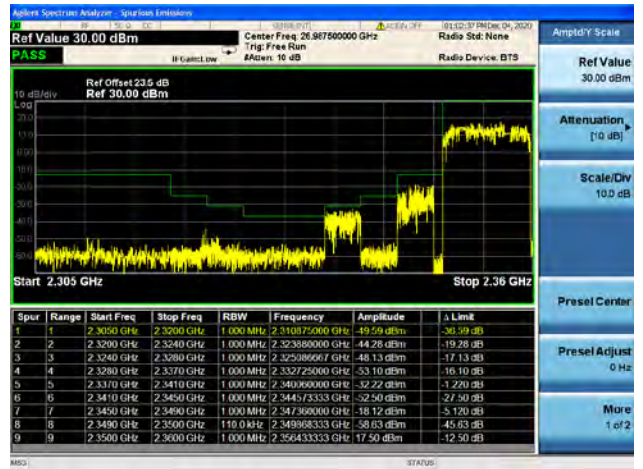

Band40 / 10MHz / High CH / QPSK / 1 RB

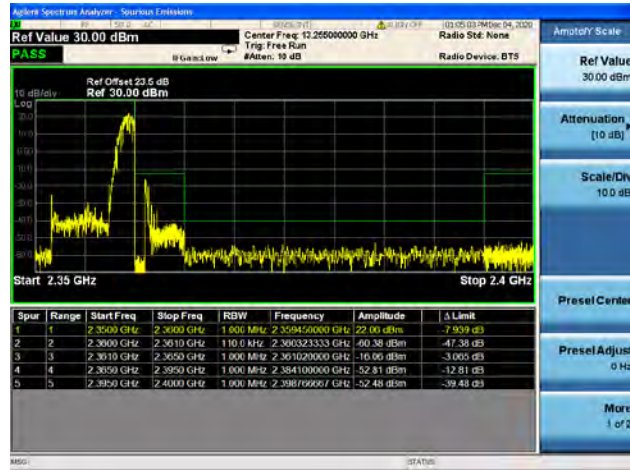

Band40 / 10MHz / High CH / QPSK / FULL RB

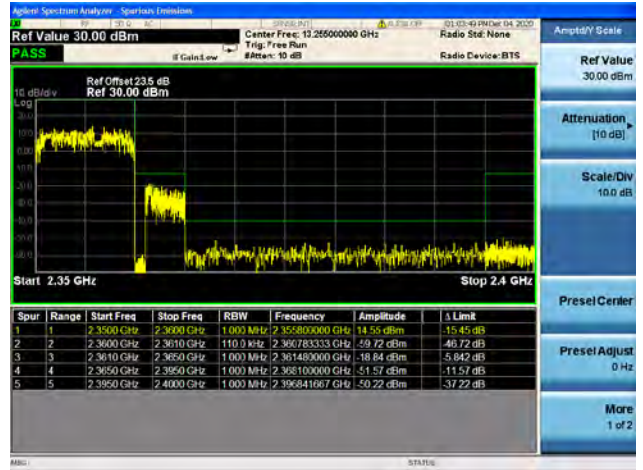



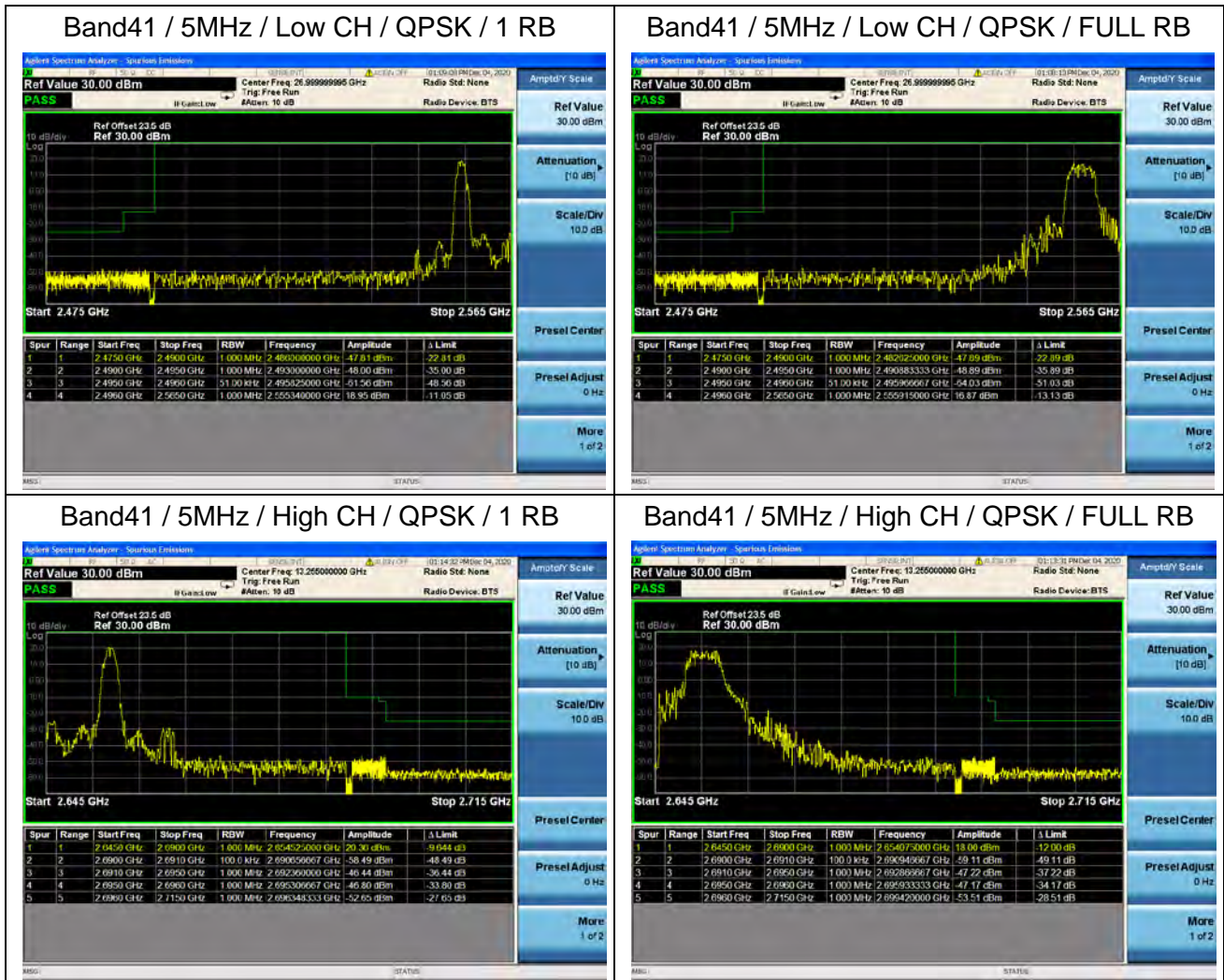



Band41 / 10MHz / Low CH / QPSK / 1 RB

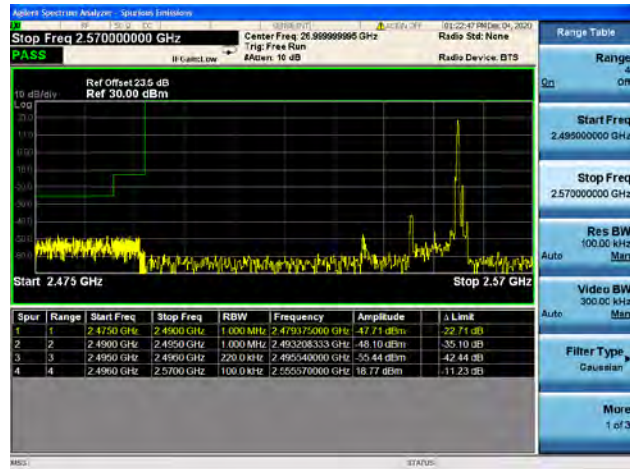

Band41 / 10MHz / Low CH / QPSK / FULL RB

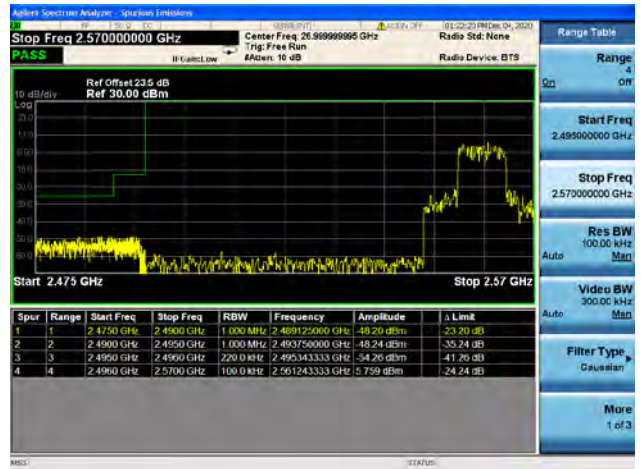

Band41 / 10MHz / High CH / QPSK / 1 RB

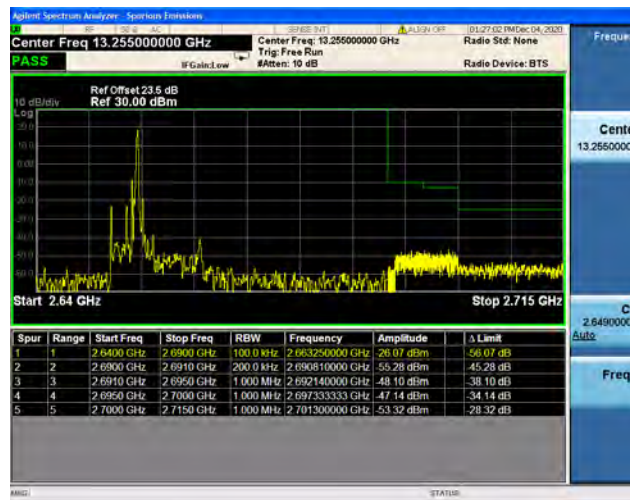

Band41 / 10MHz / High CH / QPSK / FULL RB

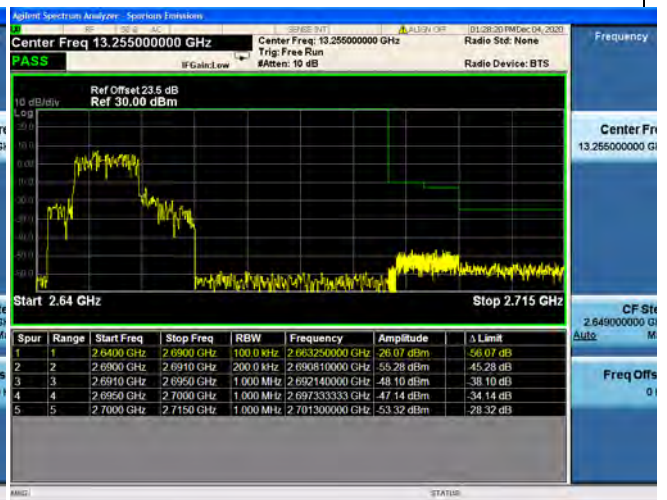



Band41 / 15MHz / Low CH / QPSK / 1 RB

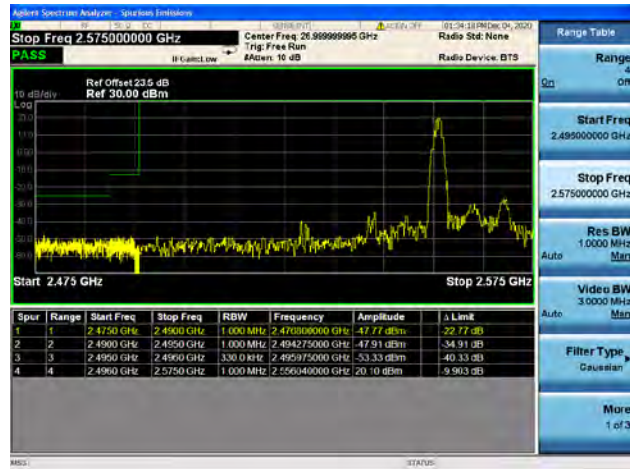

Band41 / 15MHz / Low CH / QPSK / FULL RB

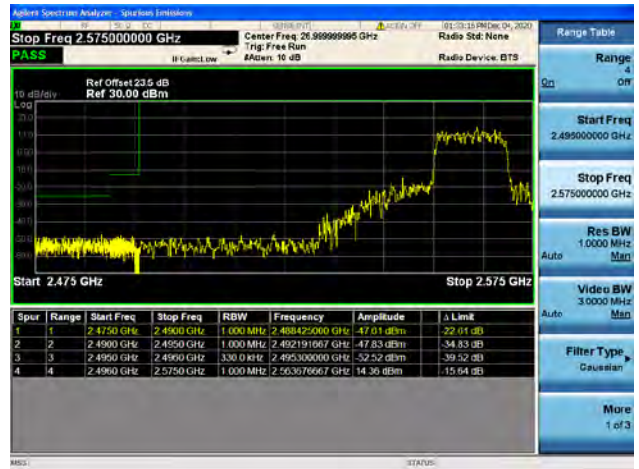

Band41 / 15MHz / High CH / QPSK / 1 RB

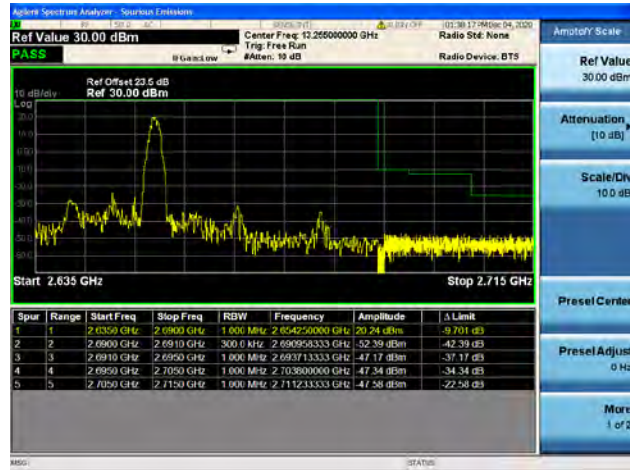

Band41 / 15MHz / High CH / QPSK / FULL RB

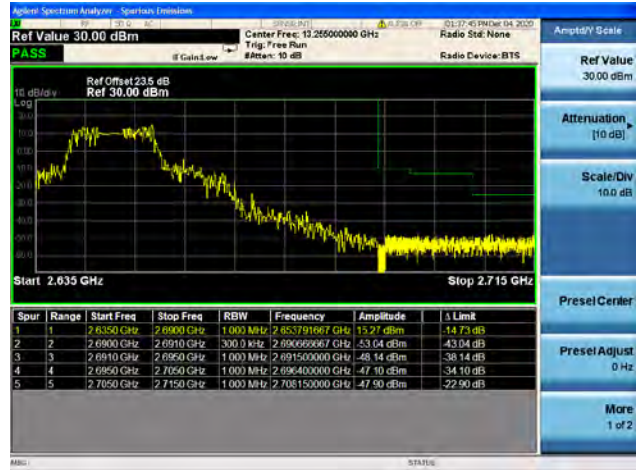



Band41 / 20MHz / Low CH / QPSK / 1 RB

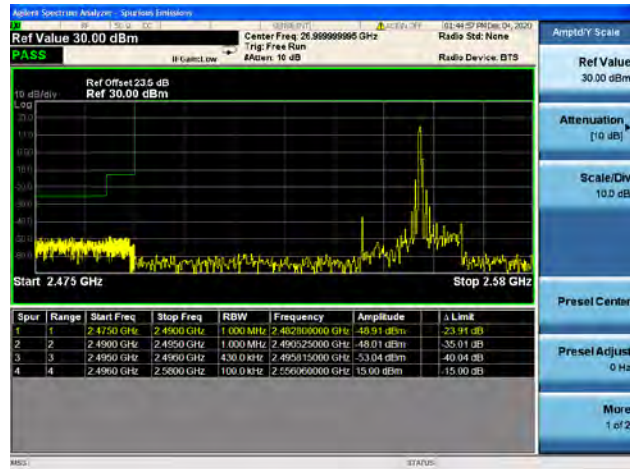

Band41 / 20MHz / Low CH / QPSK / FULL RB

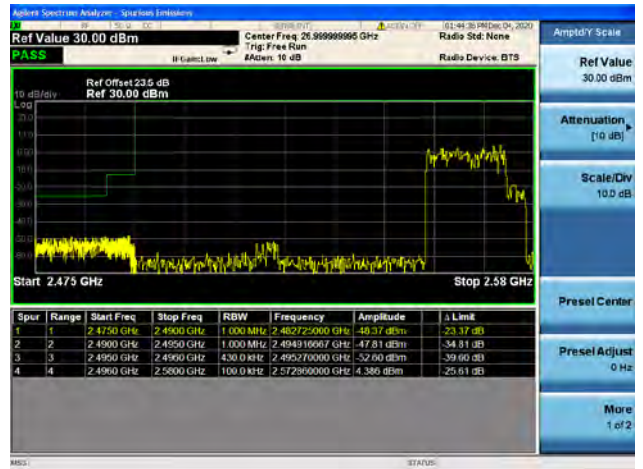

Band41 / 20MHz / High CH / QPSK / 1 RB

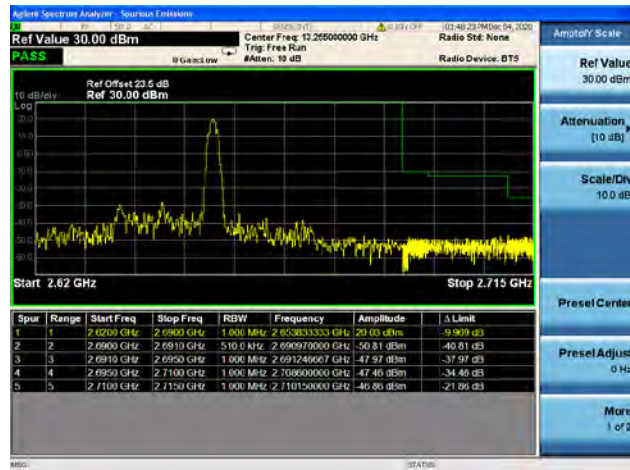

Band41 / 20MHz / High CH / QPSK / FULL RB

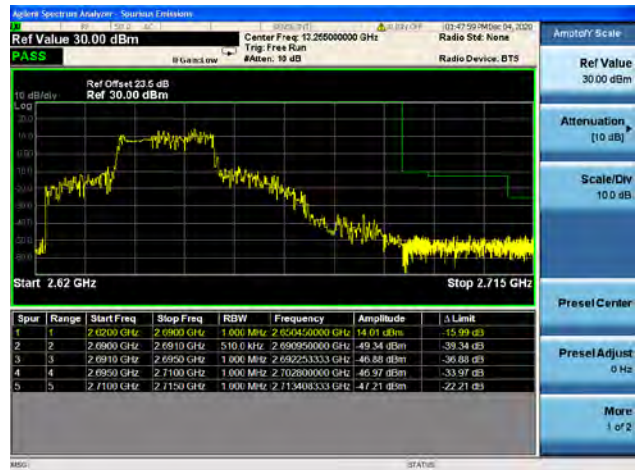

## 2.7. Radiated Spurious Emissions

### 2.7.1. Requirement

According to FCC section 2.1051, the power of any emission outside of the authorized operating frequency ranges must be attenuated below the transmitting power (P) by a factor of at least  $43 + 10 \cdot \log(P)$  dB. This calculated to be -13dBm.

Additional requirement for LTE Band 7, 38, 41

The power of any emission outside of the authorized operating frequency ranges must be attenuated below the transmitting power (P) by a factor of at least  $55 + 10 \log(P)$  dB. This calculated to be -25dBm.

Additional requirement for LTE Band 40

The power of any emission outside of the authorized operating frequency ranges must be attenuated below the transmitter power (P) by a factor of at least  $70 + 10 \log(P)$  dB. This calculated to be -40dBm.

### 2.7.2. Test Description

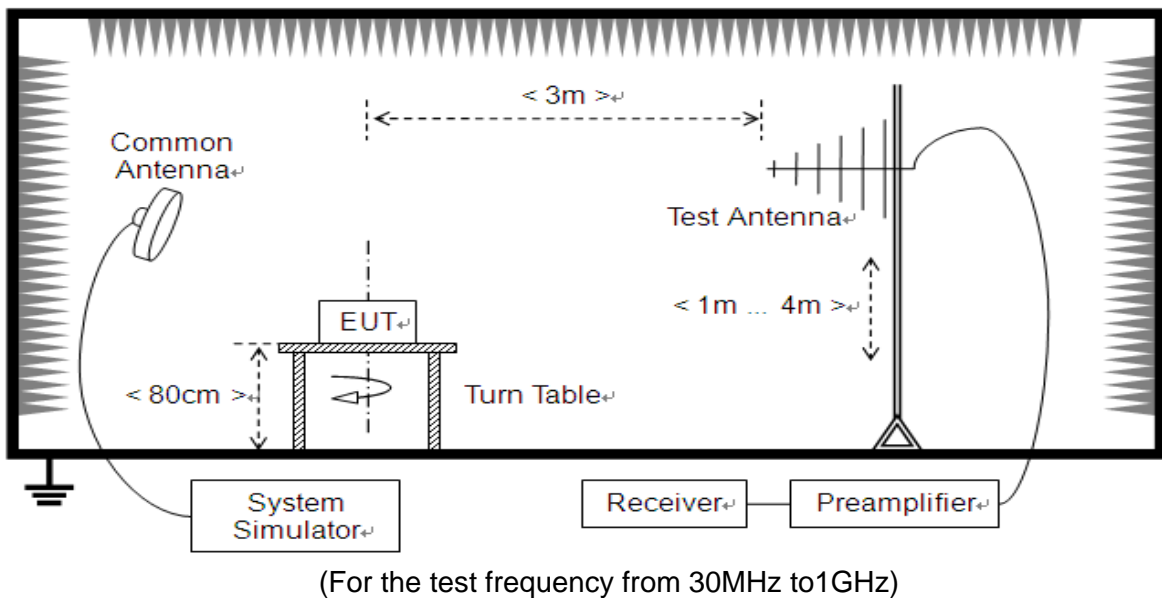

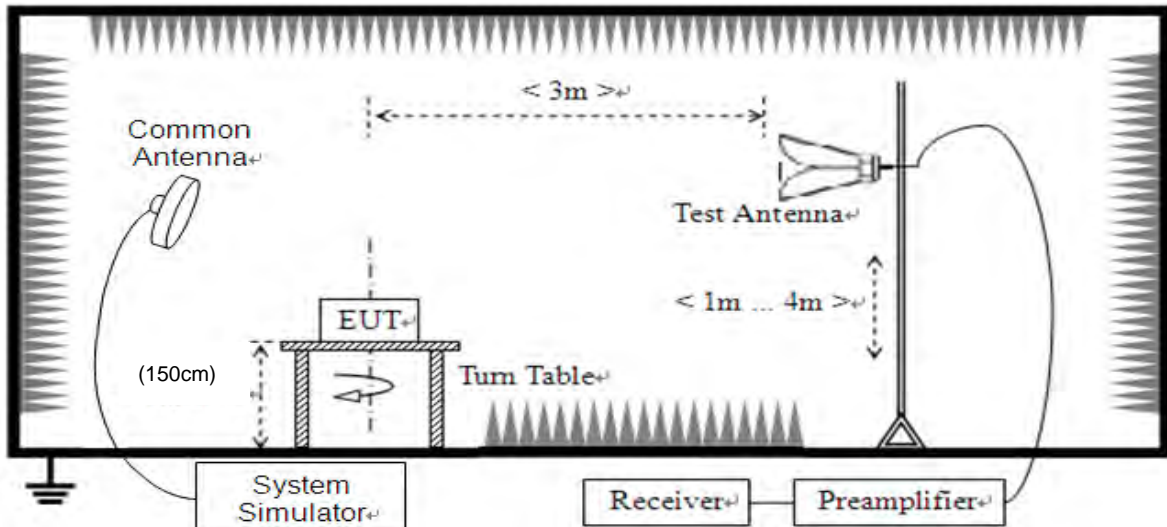

(For the test frequency above 1GHz)

The EUT is located in a 3m Full-Anechoic Chamber, the cable loss, air loss and so on of the site as factors are pre-calibrated using the "Substitution" method, and calculated to correct the reading. A call is established between the EUT and the SS via a Common Antenna. The EUT is commanded by the SS to operate at the maximum and minimum output power, and only the test result of the maximum output power was recorded.

In the frequency range above 30MHz, Bi-Log Test Antenna (30MHz to 1GHz) and Horn Test Antenna (above 1GHz) are used. Test Antenna is 3m away from the EUT. Test Antenna height is varied from 1m to 4m above the ground and the Turn Table is actuated to turn from 0° to 360° to determine the maximum value of the radiated power. The emission levels at both horizontal and vertical polarizations should be tested. The Filters consists of Notch Filters and High Pass Filter.

**Note:** When doing measurements above 1GHz, the EUT has been within the 3dB cone width of the horn antenna during horizontal antenna.

### 2.7.3. Test Procedure

KDB 971168 D01v03 Section 5.8 and ANSI/TIA-603-E-2016.

For measurements below 1 GHz the resolution bandwidth is set to 100 kHz for peak detection measurements.

For measurements above 1GHz (exclude 1559-1610 MHz) the resolution bandwidth is set to 1MHz, the video band width is set to 3MHz for peak measurements.



#### 2.7.4. Test Result

The measurement frequency range is from 30MHz to the 10th harmonic of the fundamental frequency. The Turn Table is actuated to turn from 0° to 360°, and both horizontal and vertical polarizations of the Test Antenna are used to find the maximum radiated power. The lowest, middle and highest channels are tested to verify the out of band emissions.

The substitution corrections are obtained as described below:

$$A_{\text{SUBST}} = P_{\text{SUBST\_TX}} - P_{\text{SUBST\_RX}} - L_{\text{SUBST\_CABLES}} + G_{\text{SUBST\_TX\_ANT}}$$

$$A_{\text{TOT}} = L_{\text{CABLES}} + A_{\text{SUBST}}$$

Where  $A_{\text{SUBST}}$  is the final substitution correction including receive antenna gain.

$P_{\text{SUBST\_TX}}$  is signal generator level,

$P_{\text{SUBST\_RX}}$  is receiver level,

$L_{\text{SUBST\_CABLES}}$  is cable losses including TX cable,

$G_{\text{SUBST\_TX\_ANT}}$  is substitution antenna gain.

$A_{\text{TOT}}$  is total correction factor including cable loss and substitution correction

During the test, the data of  $A_{\text{TOT}}$  was added in the test spectrum analyze, so spectrum analyze reading is the final values which contain the data of  $A_{\text{TOT}}$ .

**Note1:** The power of the EUT transmitting frequency should be ignored.

**Note2:** All Spurious Emission tests were performed in X, Y, Z axis direction. And only the worst axis test condition was recorded in this test report.

**Note3:** All bandwidth and modulation were considered and evaluated respectively by performing full test for each band, only the worst cases (Max Bandwidth and QPSK mode) were recorded in this test report.

LTE Band 2, 20MHz BW, Low Channel, QPSK

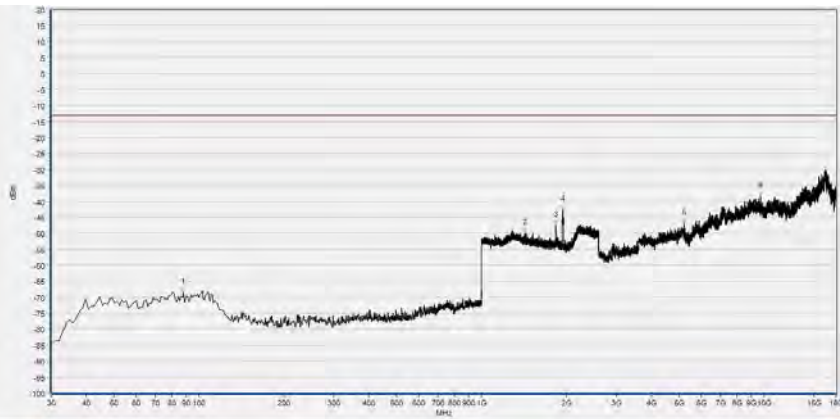

No.	Fre.(MHz)	PK (dBm)	Limit (dBm)	Antenna	Verdict
1	88.200	-68.53	-13.00	Horizontal	PASS
2	1424.490	-50.04	-13.00	Horizontal	PASS
3	1834.254	-47.39	-13.00	Horizontal	PASS
4	1944.378	-42.61	-13.00	Horizontal	PASS
5	5215.676	-46.71	-13.00	Horizontal	PASS
6	9724.495	-38.33	-13.00	Horizontal	PASS

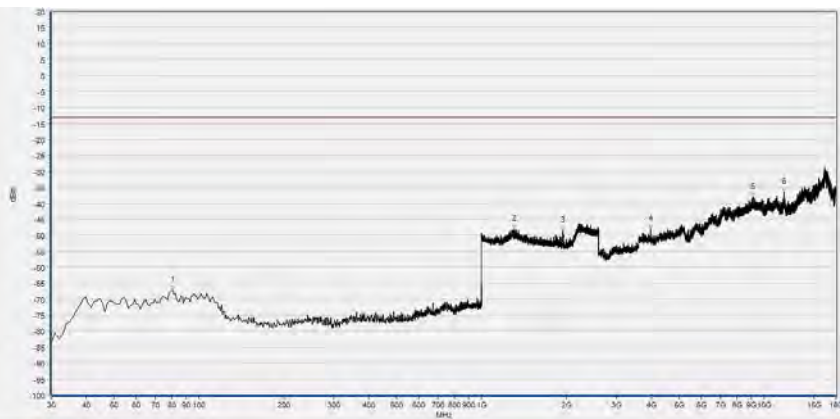

No.	Fre.(MHz)	PK (dBm)	Limit (dBm)	Antenna	Verdict
1	80.440	-67.06	-13.00	Vertical	PASS
2	1303.481	-48.25	-13.00	Vertical	PASS
3	1939.256	-48.53	-13.00	Vertical	N/A
4	3961.047	-47.84	-13.00	Vertical	PASS
5	9136.388	-38.06	-13.00	Vertical	PASS
6	11799.673	-36.58	-13.00	Vertical	PASS



LTE Band 2, 20MHz BW, Mid Channel, QPSK

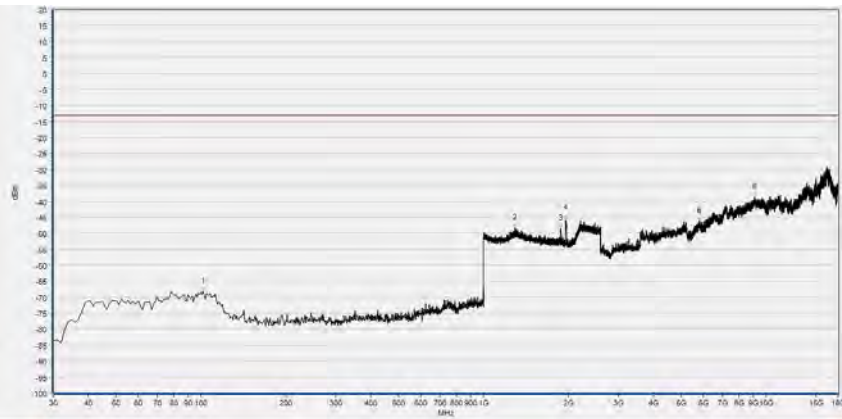

No.	Fre.(MHz)	PK (dBm)	Limit (dBm)	Antenna	Verdict
1	101.780	-68.29	-13.00	Horizontal	PASS
2	1291.957	-48.40	-13.00	Horizontal	PASS
3	1877.791	-48.50	-13.00	Horizontal	PASS
4	1952.701	-45.85	-13.00	Horizontal	PASS
5	5803.783	-46.41	-13.00	Horizontal	PASS
6	9108.383	-38.78	-13.00	Horizontal	PASS

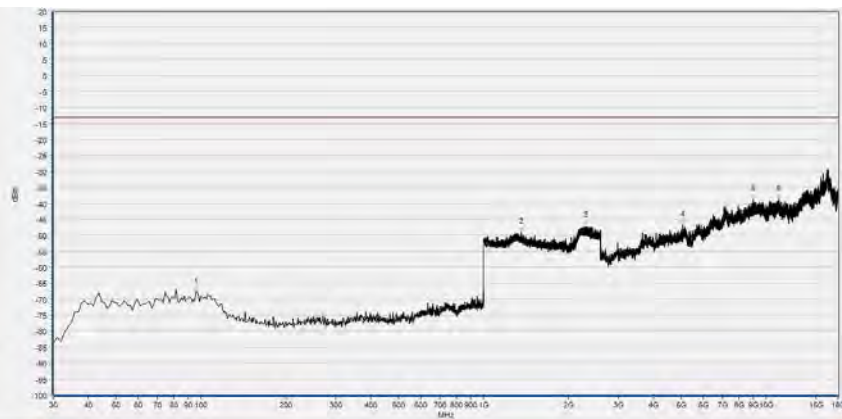

No.	Fre.(MHz)	PK (dBm)	Limit (dBm)	Antenna	Verdict
1	95.960	-67.71	-13.00	Vertical	PASS
2	1363.025	-48.99	-13.00	Vertical	PASS
3	2303.561	-46.96	-13.00	Vertical	N/A
4	5078.451	-46.83	-13.00	Vertical	PASS
5	9029.969	-38.71	-13.00	Vertical	PASS
6	11077.141	-38.86	-13.00	Vertical	PASS

LTE Band 2, 20MHz BW, High Channel, QPSK

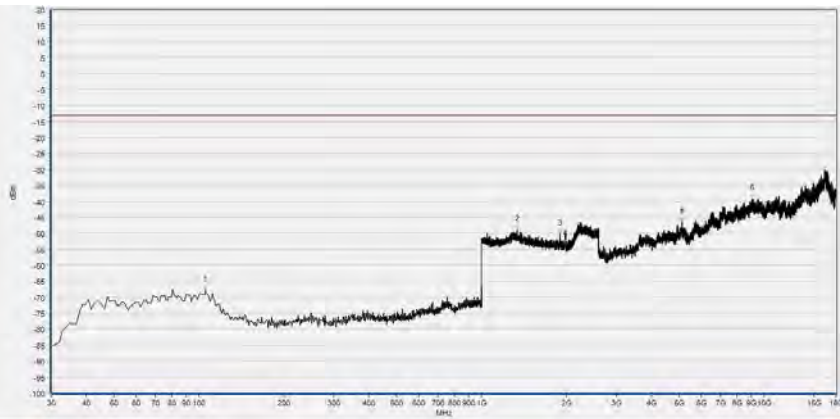

No.	Fre.(MHz)	PK (dBm)	Limit (dBm)	Antenna	Verdict
1	105.660	-67.72	-13.00	Horizontal	PASS
2	1339.336	-48.83	-13.00	Horizontal	PASS
3	1891.236	-50.17	-13.00	Horizontal	PASS
4	1975.750	-50.08	-13.00	Horizontal	PASS
5	5137.261	-46.45	-13.00	Horizontal	PASS
6	9085.979	-39.13	-13.00	Horizontal	PASS

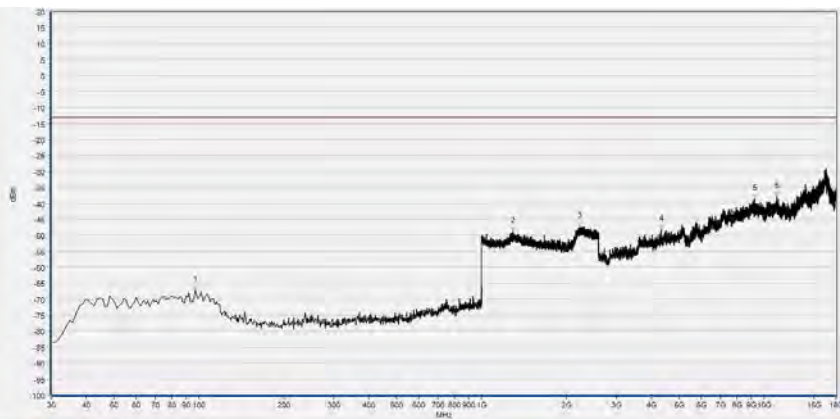

No.	Fre.(MHz)	PK (dBm)	Limit (dBm)	Antenna	Verdict
1	96.930	-67.07	-13.00	Vertical	PASS
2	1293.878	-48.85	-13.00	Vertical	PASS
3	2233.133	-47.18	-13.00	Vertical	PASS
4	4333.515	-48.16	-13.00	Vertical	PASS
5	9296.017	-38.48	-13.00	Vertical	PASS
6	11135.952	-37.94	-13.00	Vertical	PASS

LTE Band 4, 20MHz BW, Low Channel, QPSK

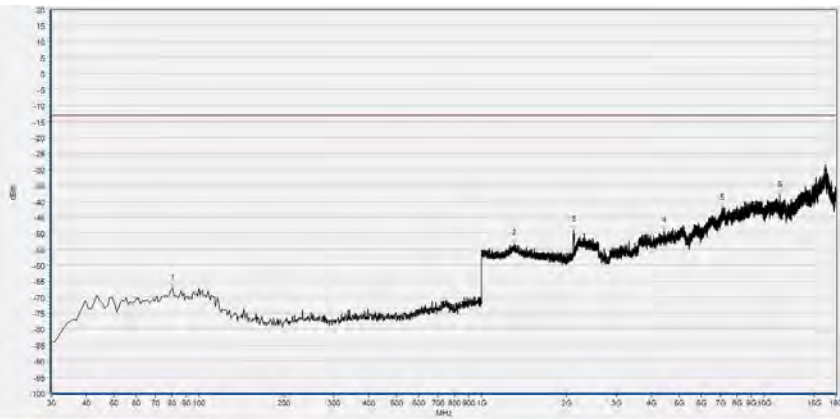

No.	Fre.(MHz)	PK (dBm)	Limit (dBm)	Antenna	Verdict
1	80.490	-67.05	-13.00	Horizontal	PASS
2	1309.755	-53.39	-13.00	Horizontal	PASS
3	2114.957	-49.05	-13.00	Horizontal	PASS
4	4432.905	-49.36	-13.00	Horizontal	PASS
5	7102.684	-42.10	-13.00	Horizontal	PASS
6	11340.957	-38.16	-13.00	Horizontal	PASS

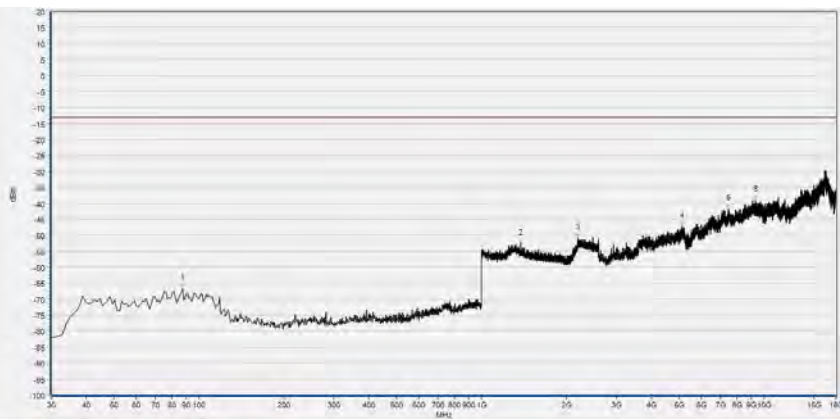

No.	Fre.(MHz)	PK (dBm)	Limit (dBm)	Antenna	Verdict
1	87.287	-66.69	-13.00	Vertical	PASS
2	1376.988	-52.73	-13.00	Vertical	PASS
3	2192.596	-50.91	-13.00	Vertical	PASS
4	5136.289	-47.22	-13.00	Vertical	PASS
5	7474.912	-41.72	-13.00	Vertical	PASS
6	9325.788	-38.92	-13.00	Vertical	PASS



LTE Band 4, 20MHz BW, Mid Channel, QPSK

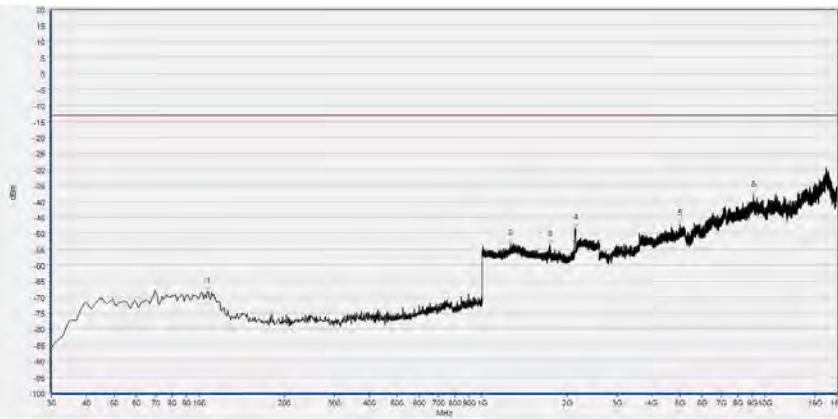

No.	Fre.(MHz)	PK (dBm)	Limit (dBm)	Antenna	Verdict
1	107.678	-68.23	-13.00	Horizontal	PASS
2	1262.531	-53.25	-13.00	Horizontal	PASS
3	1733.167	-53.44	-13.00	Horizontal	PASS
4	2140.570	-48.36	-13.00	Horizontal	PASS
5	5018.203	-46.96	-13.00	Horizontal	PASS
6	9099.883	-38.12	-13.00	Horizontal	PASS

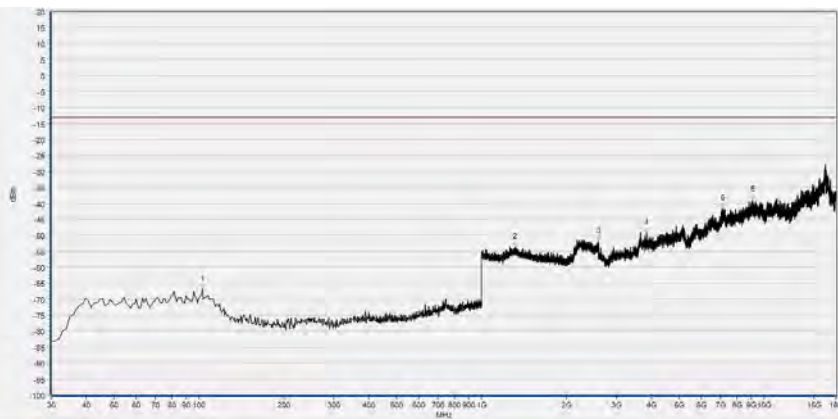

No.	Fre.(MHz)	PK (dBm)	Limit (dBm)	Antenna	Verdict
1	102.823	-66.84	-13.00	Vertical	PASS
2	1312.956	-53.84	-13.00	Vertical	PASS
3	2591.996	-51.98	-13.00	Vertical	PASS
4	3842.474	-49.25	-13.00	Vertical	PASS
5	7125.788	-41.76	-13.00	Vertical	PASS
6	9125.554	-38.92	-13.00	Vertical	PASS

LTE Band 4, 20MHz BW, High Channel, QPSK

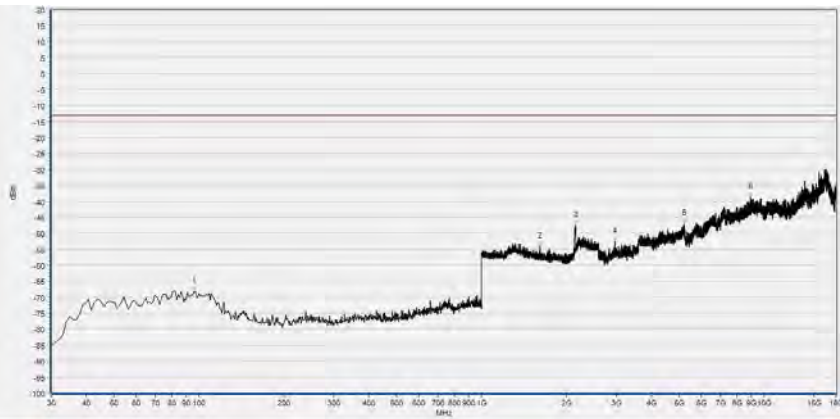

No.	Fre.(MHz)	PK (dBm)	Limit (dBm)	Antenna	Verdict
1	96.026	-68.38	-13.00	Horizontal	PASS
2	1613.907	-54.29	-13.00	Horizontal	PASS
3	2152.576	-47.55	-13.00	Horizontal	PASS
4	2969.662	-52.59	-13.00	Horizontal	PASS
5	5223.571	-47.03	-13.00	Horizontal	PASS
6	8974.096	-38.80	-13.00	Horizontal	PASS

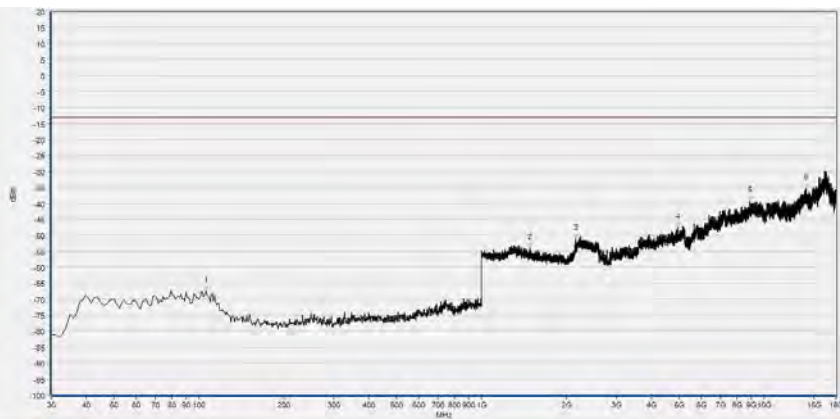

No.	Fre.(MHz)	PK (dBm)	Limit (dBm)	Antenna	Verdict
1	105.736	-67.48	-13.00	Vertical	PASS
2	1481.841	-54.06	-13.00	Vertical	PASS
3	2154.177	-51.03	-13.00	Vertical	PASS
4	4951.459	-47.50	-13.00	Vertical	PASS
5	8922.754	-39.20	-13.00	Vertical	PASS
6	14105.718	-35.22	-13.00	Vertical	PASS

LTE Band 5, 10MHz BW, Low Channel, QPSK

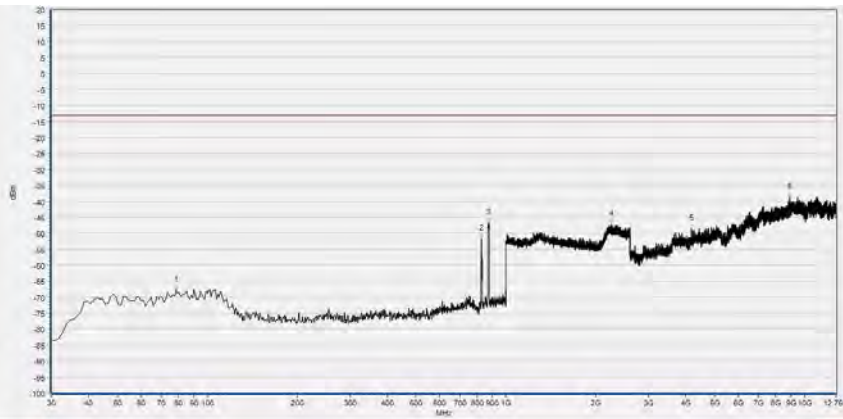

No.	Fre.(MHz)	PK (dBm)	Limit (dBm)	Antenna	Verdict
1	78.500	-67.79	-13.00	Horizontal	PASS
2	827.340	-51.68	-13.00	Horizontal	N/A
3	875.840	-46.72	-13.00	Horizontal	N/A
4	2258.103	-47.37	-13.00	Horizontal	PASS
5	4165.230	-48.65	-13.00	Horizontal	PASS
6	8923.677	-38.73	-13.00	Horizontal	PASS

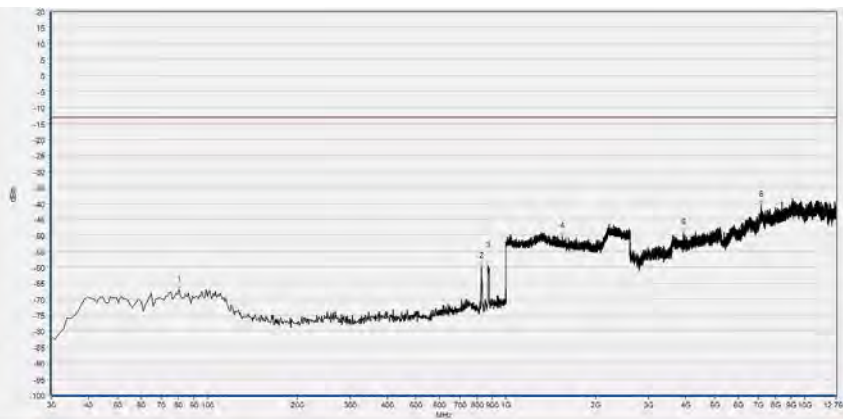

No.	Fre.(MHz)	PK (dBm)	Limit (dBm)	Antenna	Verdict
1	80.440	-66.95	-13.00	Vertical	PASS
2	828.310	-59.79	-13.00	Vertical	N/A
3	870.990	-59.61	-13.00	Vertical	N/A
4	1545.498	-50.43	-13.00	Vertical	PASS
5	3917.894	-49.26	-13.00	Vertical	PASS
6	7157.256	-40.49	-13.00	Vertical	PASS

LTE Band 5, 10MHz BW, Mid Channel, QPSK

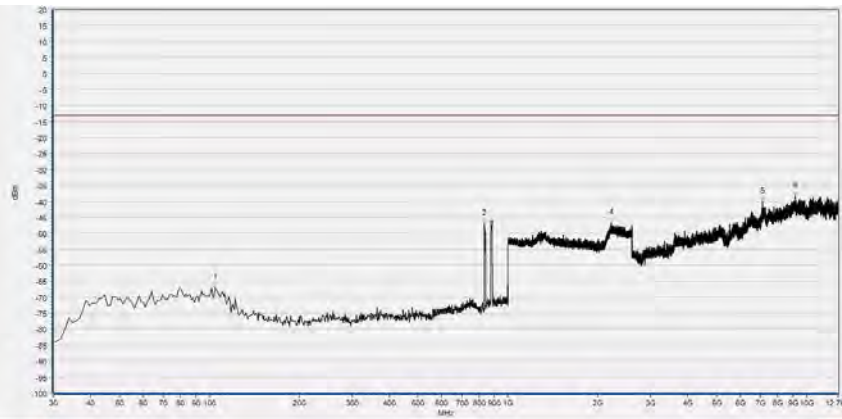

No.	Fre.(MHz)	PK (dBm)	Limit (dBm)	Antenna	Verdict
1	104.690	-66.83	-13.00	Horizontal	PASS
2	833.160	-47.11	-13.00	Horizontal	N/A
3	877.780	-47.59	-13.00	Horizontal	N/A
4	2221.609	-46.77	-13.00	Horizontal	PASS
5	7107.420	-40.19	-13.00	Horizontal	PASS
6	9148.863	-38.41	-13.00	Horizontal	PASS

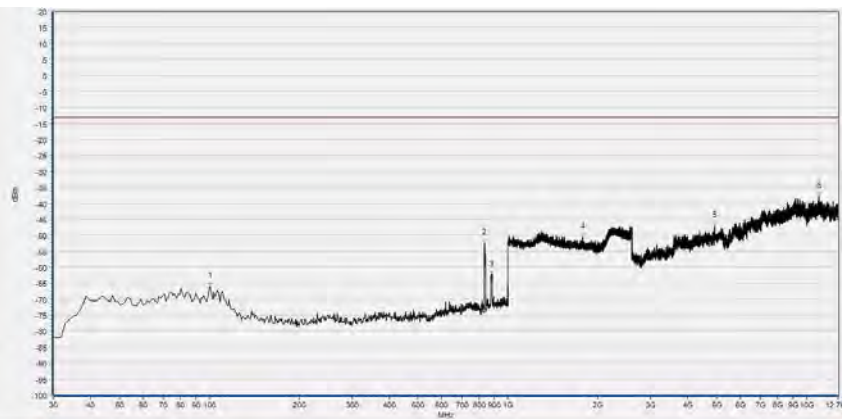

No.	Fre.(MHz)	PK (dBm)	Limit (dBm)	Antenna	Verdict
1	100.810	-66.10	-13.00	Vertical	PASS
2	834.130	-52.36	-13.00	Vertical	N/A
3	878.750	-62.47	-13.00	Vertical	N/A
4	1779.192	-50.51	-13.00	Vertical	PASS
5	4931.233	-46.97	-13.00	Vertical	PASS
6	10965.121	-37.94	-13.00	Vertical	PASS

LTE Band 5, 10MHz BW, High Channel, QPSK

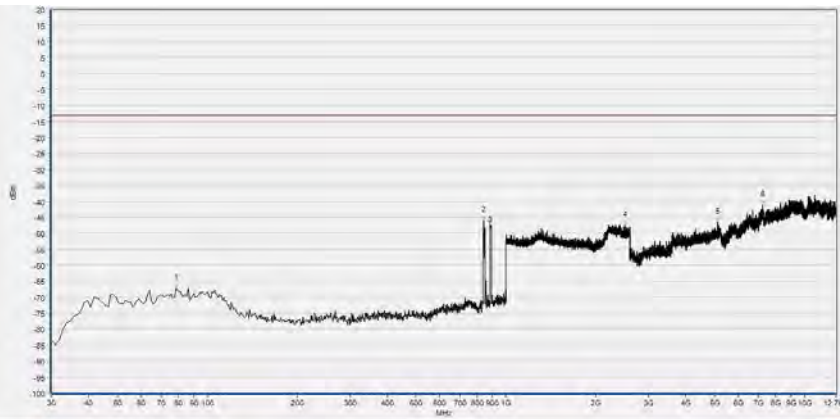

No.	Fre.(MHz)	PK (dBm)	Limit (dBm)	Antenna	Verdict
1	78.500	-67.25	-13.00	Horizontal	PASS
2	843.830	-45.86	-13.00	Horizontal	N/A
3	886.510	-46.95	-13.00	Horizontal	N/A
4	2503.962	-47.41	-13.00	Horizontal	PASS
5	5121.349	-46.69	-13.00	Horizontal	PASS
6	7231.087	-41.22	-13.00	Horizontal	PASS

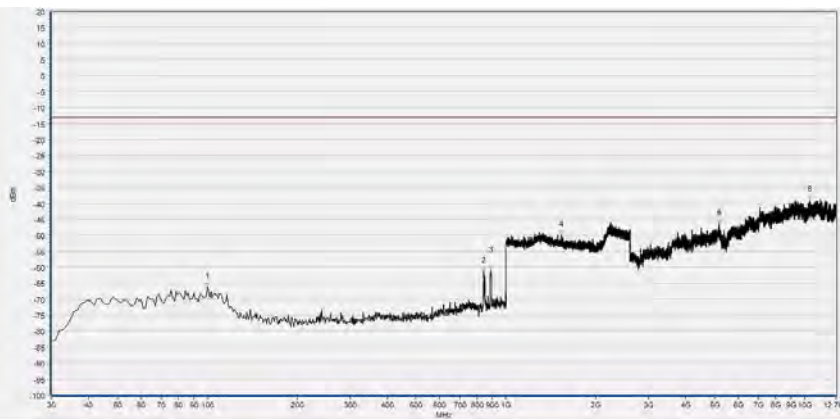

No.	Fre.(MHz)	PK (dBm)	Limit (dBm)	Antenna	Verdict
1	99.840	-66.16	-13.00	Vertical	PASS
2	842.860	-61.26	-13.00	Vertical	N/A
3	890.390	-60.97	-13.00	Vertical	N/A
4	1530.132	-49.85	-13.00	Vertical	PASS
5	5169.340	-46.31	-13.00	Vertical	PASS
6	10389.234	-38.90	-13.00	Vertical	PASS



LTE Band 7, 20MHz BW, Low Channel, QPSK

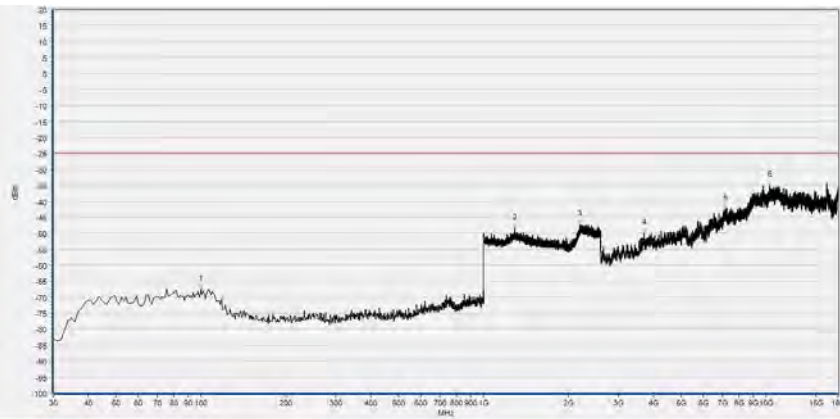

No.	Fre.(MHz)	PK (dBm)	Limit (dBm)	Antenna	Verdict
1	99.840	-67.57	-25.00	Horizontal	PASS
2	1288.115	-48.35	-25.00	Horizontal	PASS
3	2194.718	-47.18	-25.00	Horizontal	PASS
4	3694.999	-49.87	-25.00	Horizontal	PASS
5	7164.830	-42.39	-25.00	Horizontal	PASS
6	10292.999	-34.88	-25.00	Horizontal	PASS

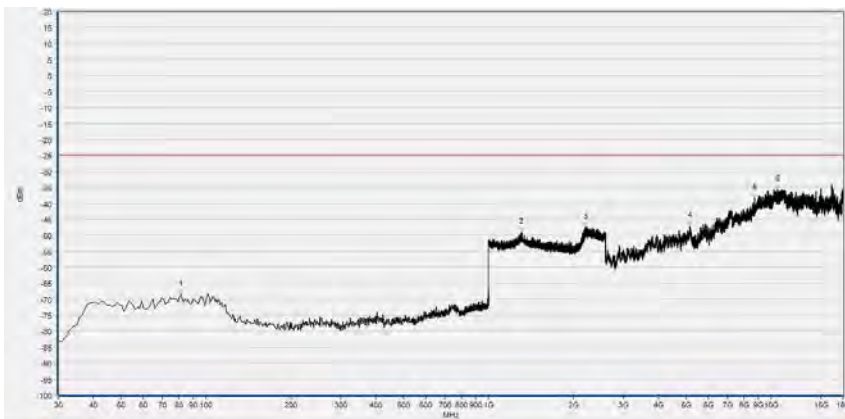

No.	Fre.(MHz)	PK (dBm)	Limit (dBm)	Antenna	Verdict
1	81.410	-68.47	-25.00	Vertical	PASS
2	1305.402	-49.09	-25.00	Vertical	PASS
3	2199.840	-47.56	-25.00	Vertical	PASS
4	5162.466	-47.04	-25.00	Vertical	PASS
5	8741.517	-38.38	-25.00	Vertical	PASS
6	10567.449	-35.75	-25.00	Vertical	PASS

LTE Band 7, 20MHz BW, Mid Channel, QPSK

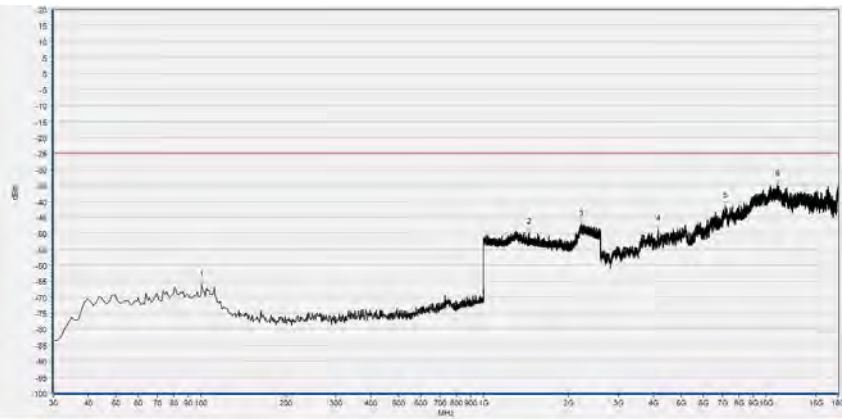

No.	Fre.(MHz)	PK (dBm)	Limit (dBm)	Antenna	Verdict
1	100.810	-66.32	-25.00	Horizontal	PASS
2	1449.460	-49.81	-25.00	Horizontal	PASS
3	2215.206	-47.26	-25.00	Horizontal	PASS
4	4159.884	-48.93	-25.00	Horizontal	PASS
5	7181.633	-41.54	-25.00	Horizontal	PASS
6	10970.722	-34.83	-25.00	Horizontal	PASS

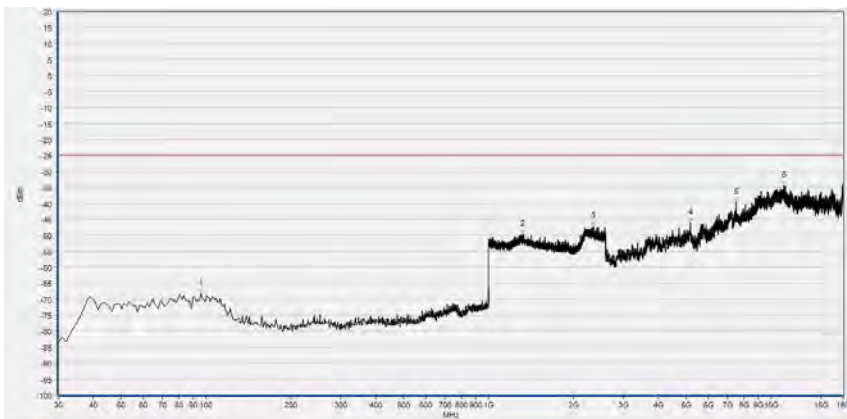

No.	Fre.(MHz)	PK (dBm)	Limit (dBm)	Antenna	Verdict
1	95.960	-68.30	-25.00	Vertical	PASS
2	1322.689	-49.81	-25.00	Vertical	PASS
3	2357.983	-47.18	-25.00	Vertical	PASS
4	5182.069	-46.17	-25.00	Vertical	PASS
5	7506.492	-39.69	-25.00	Vertical	PASS
6	11135.952	-34.57	-25.00	Vertical	PASS

LTE Band 7, 20MHz BW, High Channel, QPSK

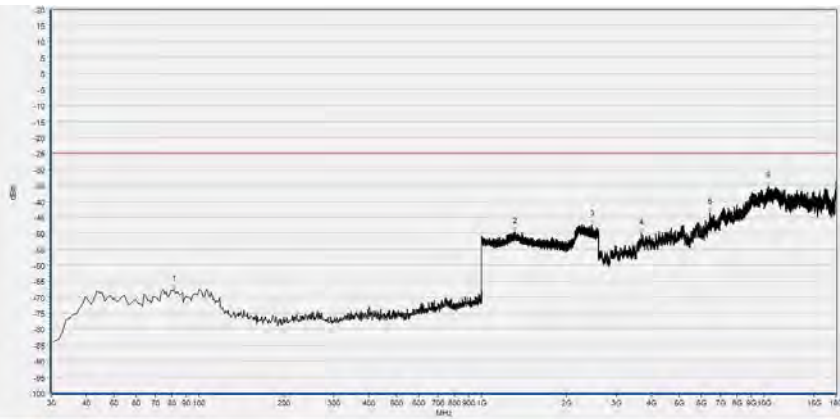

No.	Fre.(MHz)	PK (dBm)	Limit (dBm)	Antenna	Verdict
1	81.410	-67.61	-25.00	Horizontal	PASS
2	1316.927	-49.51	-25.00	Horizontal	PASS
3	2462.985	-47.31	-25.00	Horizontal	PASS
4	3680.997	-50.03	-25.00	Horizontal	PASS
5	6425.496	-43.43	-25.00	Horizontal	PASS
6	10332.206	-35.29	-25.00	Horizontal	PASS

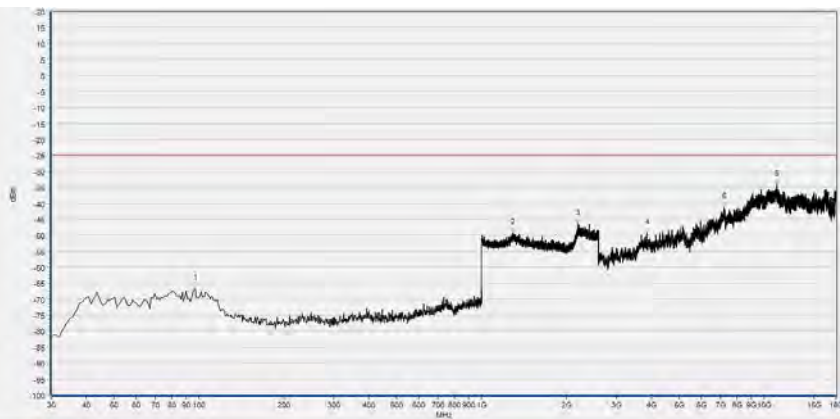

No.	Fre.(MHz)	PK (dBm)	Limit (dBm)	Antenna	Verdict
1	96.930	-66.61	-25.00	Vertical	PASS
2	1290.676	-49.33	-25.00	Vertical	PASS
3	2199.200	-46.41	-25.00	Vertical	PASS
4	3851.828	-49.22	-25.00	Vertical	PASS
5	7237.643	-41.31	-25.00	Vertical	PASS
6	11133.151	-34.05	-25.00	Vertical	PASS

LTE Band 12, 10MHz BW, Low Channel, QPSK

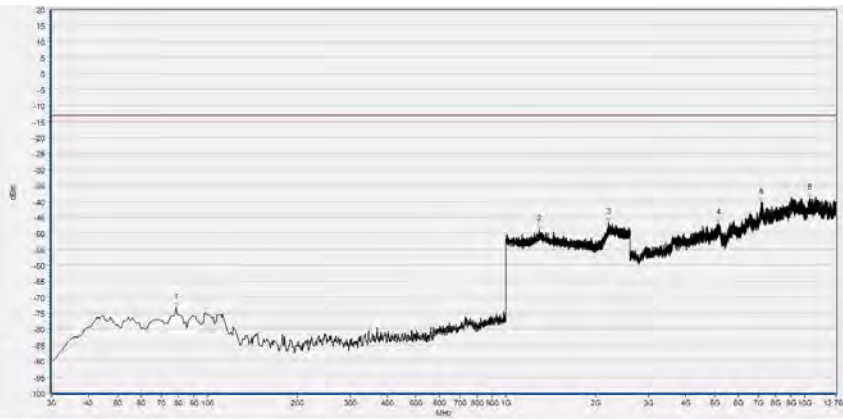

No.	Fre.(MHz)	PK (dBm)	Limit (dBm)	Antenna	Verdict
1	78.549	-73.23	-13.00	Horizontal	PASS
2	1293.431	-48.78	-13.00	Horizontal	PASS
3	2206.269	-46.67	-13.00	Horizontal	PASS
4	5152.220	-46.80	-13.00	Horizontal	PASS
5	7164.353	-40.38	-13.00	Horizontal	PASS
6	10374.425	-38.91	-13.00	Horizontal	PASS

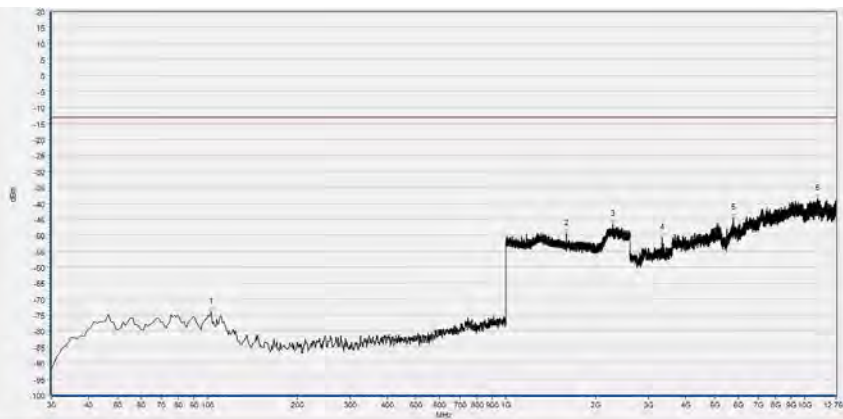

No.	Fre.(MHz)	PK (dBm)	Limit (dBm)	Antenna	Verdict
1	102.823	-74.13	-13.00	Vertical	PASS
2	1595.932	-49.45	-13.00	Vertical	PASS
3	2282.561	-46.58	-13.00	Vertical	PASS
4	3335.007	-50.86	-13.00	Vertical	PASS
5	5771.494	-44.64	-13.00	Vertical	PASS
6	11078.976	-38.51	-13.00	Vertical	PASS

LTE Band 12, 10MHz BW, Mid Channel, QPSK

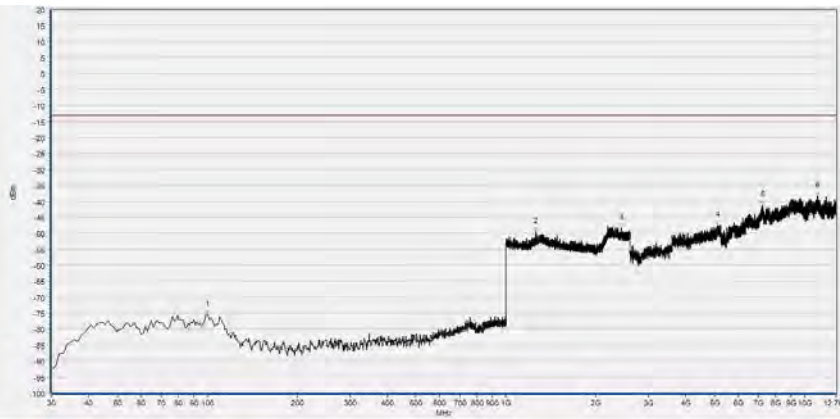

No.	Fre.(MHz)	PK (dBm)	Limit (dBm)	Antenna	Verdict
1	99.910	-75.40	-13.00	Horizontal	PASS
2	1258.219	-49.49	-13.00	Horizontal	PASS
3	2439.947	-48.42	-13.00	Horizontal	PASS
4	5111.612	-47.53	-13.00	Horizontal	PASS
5	7251.660	-41.22	-13.00	Horizontal	PASS
6	11058.672	-38.43	-13.00	Horizontal	PASS

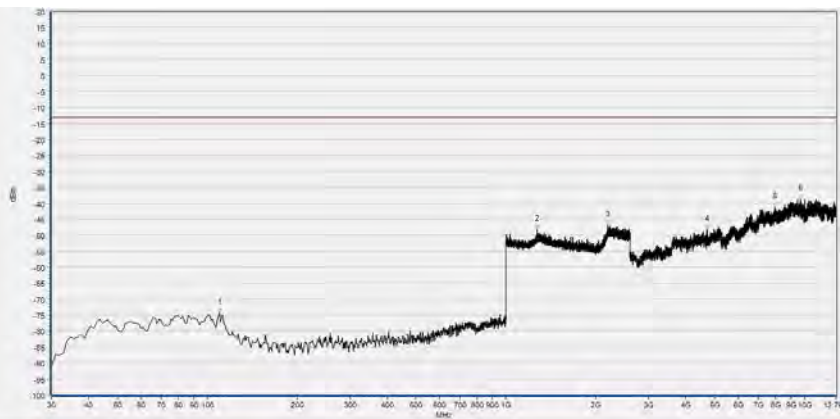

No.	Fre.(MHz)	PK (dBm)	Limit (dBm)	Antenna	Verdict
1	109.620	-74.27	-13.00	Vertical	PASS
2	1271.557	-48.12	-13.00	Vertical	PASS
3	2187.062	-46.76	-13.00	Vertical	PASS
4	4707.562	-48.13	-13.00	Vertical	PASS
5	7931.846	-41.31	-13.00	Vertical	PASS
6	9673.935	-38.79	-13.00	Vertical	PASS

LTE Band 12, 10MHz BW, High Channel, QPSK

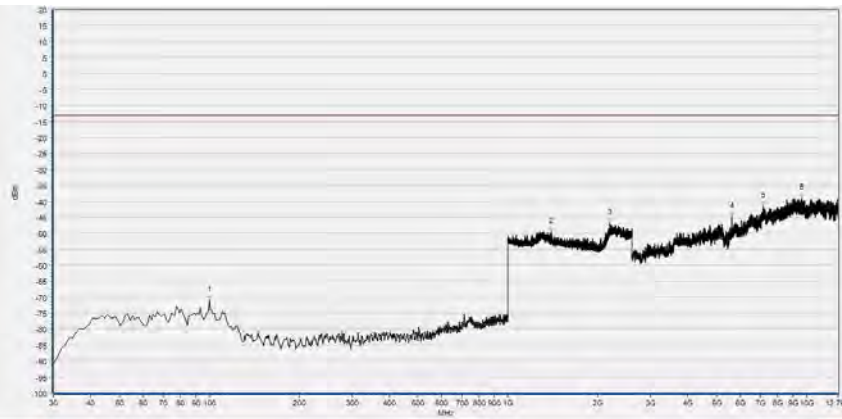

No.	Fre.(MHz)	PK (dBm)	Limit (dBm)	Antenna	Verdict
1	99.910	-71.01	-13.00	Horizontal	PASS
2	1396.932	-49.59	-13.00	Horizontal	PASS
3	2188.663	-46.93	-13.00	Horizontal	PASS
4	5613.123	-44.79	-13.00	Horizontal	PASS
5	7172.474	-41.52	-13.00	Horizontal	PASS
6	9633.327	-38.91	-13.00	Horizontal	PASS

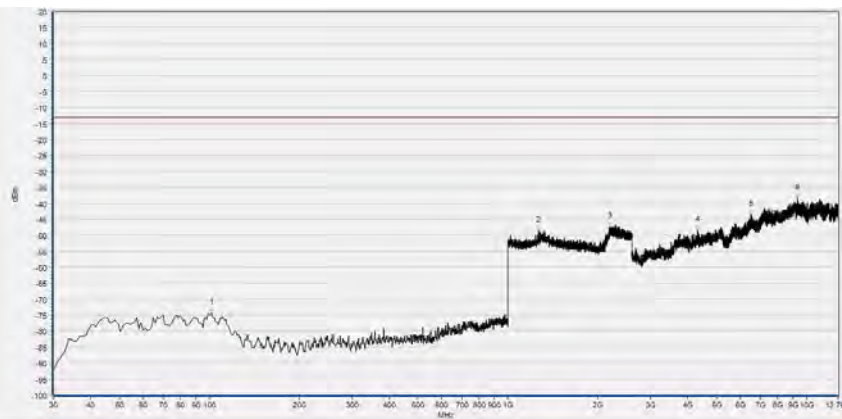

No.	Fre.(MHz)	PK (dBm)	Limit (dBm)	Antenna	Verdict
1	101.852	-74.30	-13.00	Vertical	PASS
2	1267.289	-48.50	-13.00	Vertical	PASS
3	2188.663	-47.25	-13.00	Vertical	PASS
4	4321.784	-48.27	-13.00	Vertical	PASS
5	6524.775	-43.53	-13.00	Vertical	PASS
6	9306.431	-38.43	-13.00	Vertical	PASS

LTE Band 17, 10MHz BW, Low Channel, QPSK

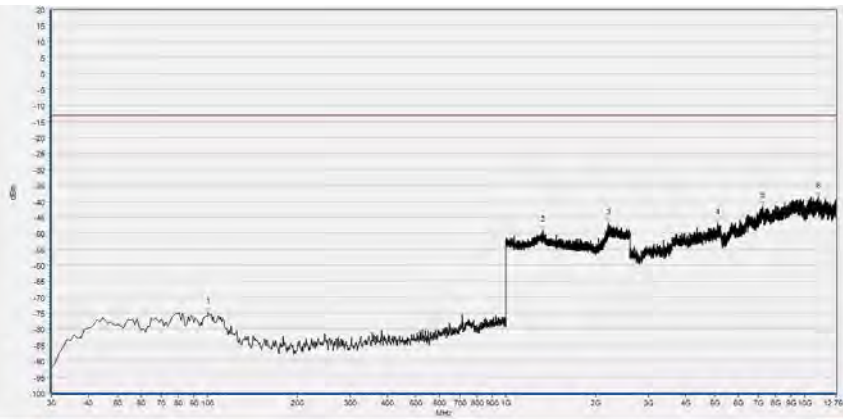

No.	Fre.(MHz)	PK (dBm)	Limit (dBm)	Antenna	Verdict
1	100.881	-74.79	-13.00	Horizontal	PASS
2	1330.243	-49.14	-13.00	Horizontal	PASS
3	2198.800	-46.77	-13.00	Horizontal	PASS
4	5101.460	-46.85	-13.00	Horizontal	PASS
5	7225.265	-41.56	-13.00	Horizontal	PASS
6	11087.097	-38.51	-13.00	Horizontal	PASS

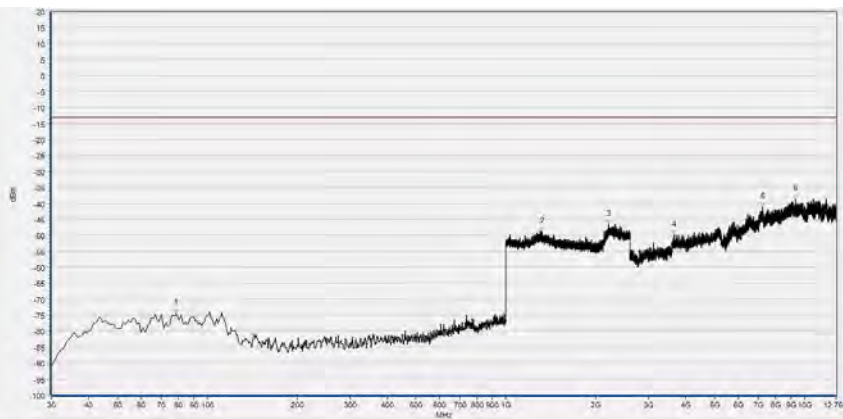

No.	Fre.(MHz)	PK (dBm)	Limit (dBm)	Antenna	Verdict
1	78.549	-74.56	-13.00	Vertical	PASS
2	1321.707	-48.83	-13.00	Vertical	PASS
3	2200.934	-46.49	-13.00	Vertical	PASS
4	3655.811	-49.88	-13.00	Vertical	PASS
5	7243.539	-41.27	-13.00	Vertical	PASS
6	9326.735	-38.66	-13.00	Vertical	PASS

LTE Band 17, 10MHz BW, Mid Channel, QPSK

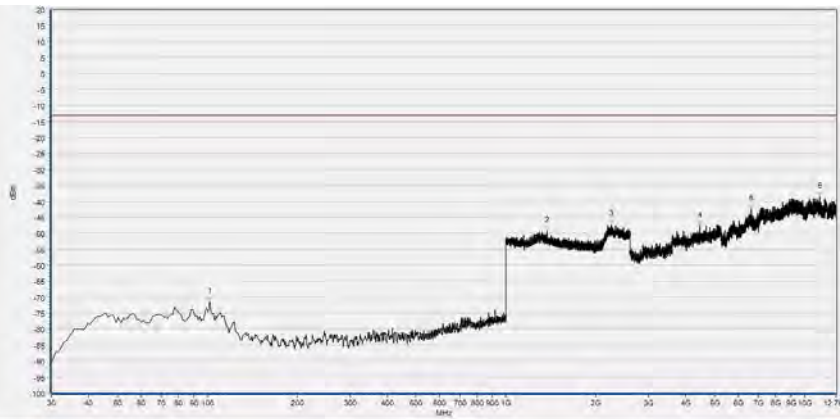

No.	Fre.(MHz)	PK (dBm)	Limit (dBm)	Antenna	Verdict
1	101.852	-71.49	-13.00	Horizontal	PASS
2	1371.857	-49.34	-13.00	Horizontal	PASS
3	2251.617	-47.26	-13.00	Horizontal	PASS
4	4453.761	-47.62	-13.00	Horizontal	PASS
5	6626.295	-42.34	-13.00	Horizontal	PASS
6	11223.135	-38.52	-13.00	Horizontal	PASS

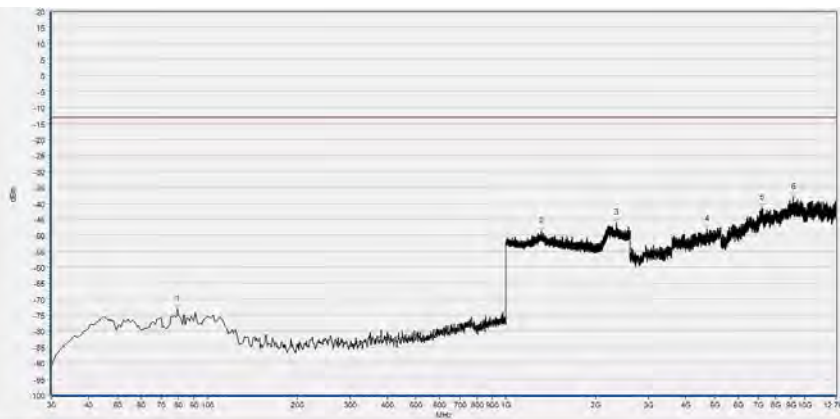

No.	Fre.(MHz)	PK (dBm)	Limit (dBm)	Antenna	Verdict
1	79.520	-73.22	-13.00	Vertical	PASS
2	1311.037	-48.90	-13.00	Vertical	PASS
3	2338.580	-46.22	-13.00	Vertical	PASS
4	4711.622	-48.25	-13.00	Vertical	PASS
5	7184.657	-41.54	-13.00	Vertical	PASS
6	9156.181	-38.18	-13.00	Vertical	PASS



LTE Band 17, 10MHz BW, High Channel, QPSK

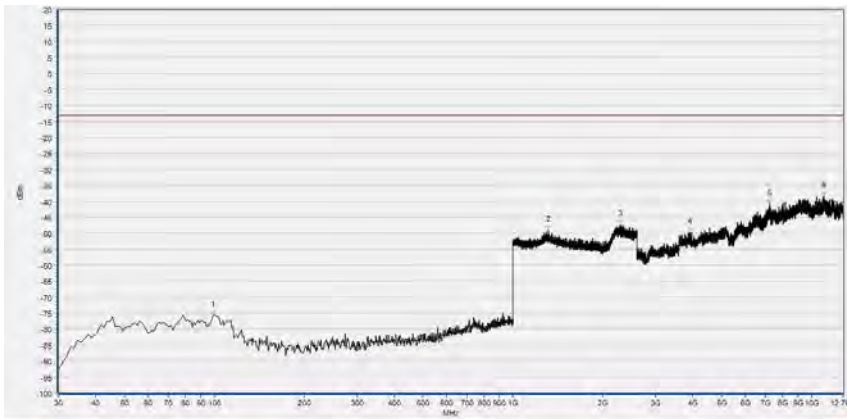

No.	Fre.(MHz)	PK (dBm)	Limit (dBm)	Antenna	Verdict
1	98.939	-75.65	-13.00	Horizontal	PASS
2	1313.705	-49.15	-13.00	Horizontal	PASS
3	2288.429	-47.36	-13.00	Horizontal	PASS
4	3913.673	-49.83	-13.00	Horizontal	PASS
5	7235.417	-40.73	-13.00	Horizontal	PASS
6	10985.577	-38.39	-13.00	Horizontal	PASS

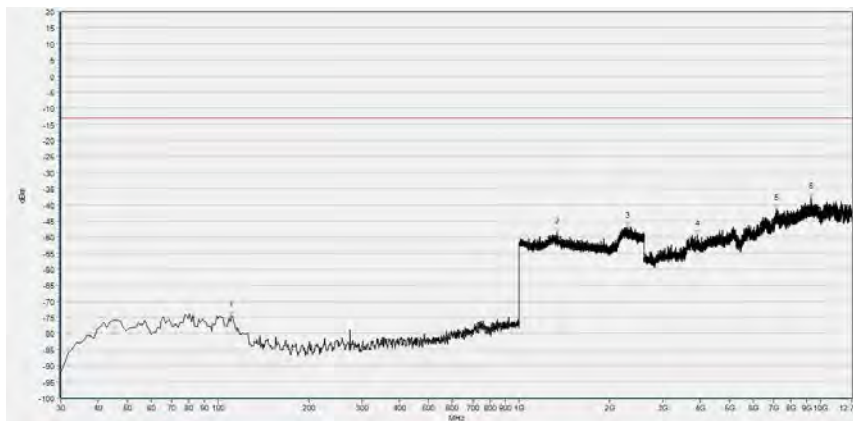

No.	Fre.(MHz)	PK (dBm)	Limit (dBm)	Antenna	Verdict
1	110.591	-74.63	-13.00	Vertical	PASS
2	1333.444	-48.68	-13.00	Vertical	PASS
3	2285.762	-46.76	-13.00	Vertical	PASS
4	3901.490	-49.38	-13.00	Vertical	PASS
5	7152.170	-41.31	-13.00	Vertical	PASS
6	9316.583	-37.74	-13.00	Vertical	PASS

LTE Band 38, 20MHz BW, Low Channel, QPSK

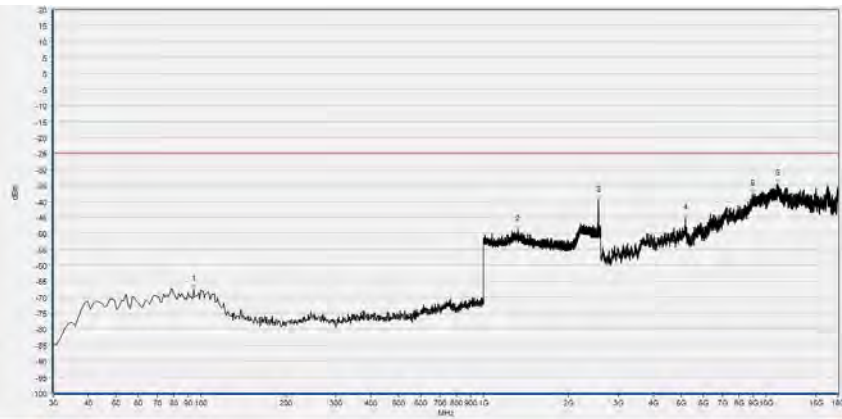

No.	Fre.(MHz)	PK (dBm)	Limit (dBm)	Antenna	Verdict
1	94.084	-67.51	-25.00	Horizontal	PASS
2	1325.975	-48.79	-25.00	Horizontal	PASS
3	2553.585	-39.68	-25.00	Horizontal	PASS
4	5178.476	-45.24	-25.00	Horizontal	PASS
5	8973.795	-37.70	-25.00	Horizontal	PASS
6	10997.760	-34.55	-25.00	Horizontal	PASS

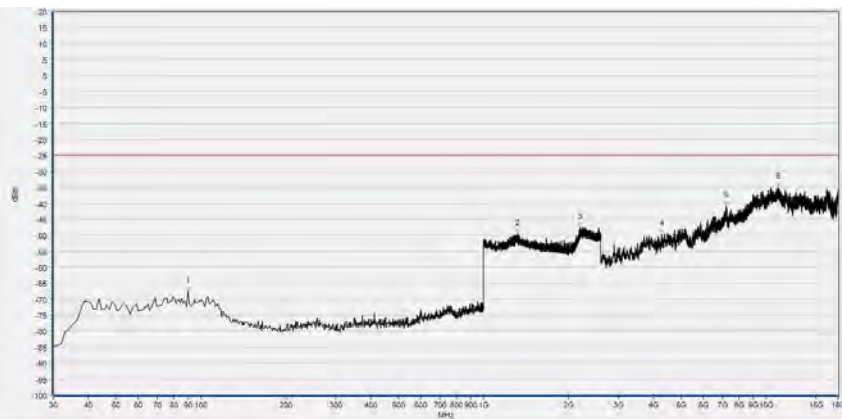

No.	Fre.(MHz)	PK (dBm)	Limit (dBm)	Antenna	Verdict
1	90.200	-67.51	-25.00	Vertical	PASS
2	1320.107	-49.56	-25.00	Vertical	PASS
3	2197.733	-47.49	-25.00	Vertical	PASS
4	4272.775	-49.63	-25.00	Vertical	PASS
5	7211.682	-40.73	-25.00	Vertical	PASS
6	11013.163	-34.92	-25.00	Vertical	PASS

LTE Band 38, 20MHz BW, Mid Channel, QPSK

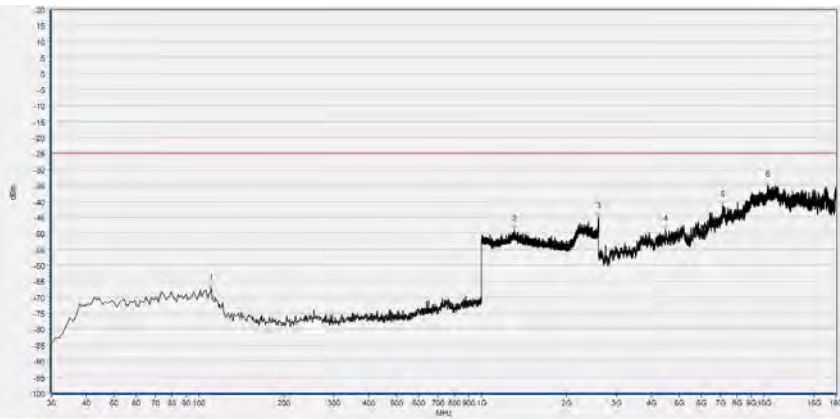

No.	Fre.(MHz)	PK (dBm)	Limit (dBm)	Antenna	Verdict
1	110.591	-67.11	-25.00	Horizontal	PASS
2	1310.504	-48.80	-25.00	Horizontal	PASS
3	2590.397	-44.87	-25.00	Horizontal	N/A
4	4485.337	-48.91	-25.00	Horizontal	PASS
5	7156.231	-41.26	-25.00	Horizontal	PASS
6	10329.266	-35.01	-25.00	Horizontal	PASS

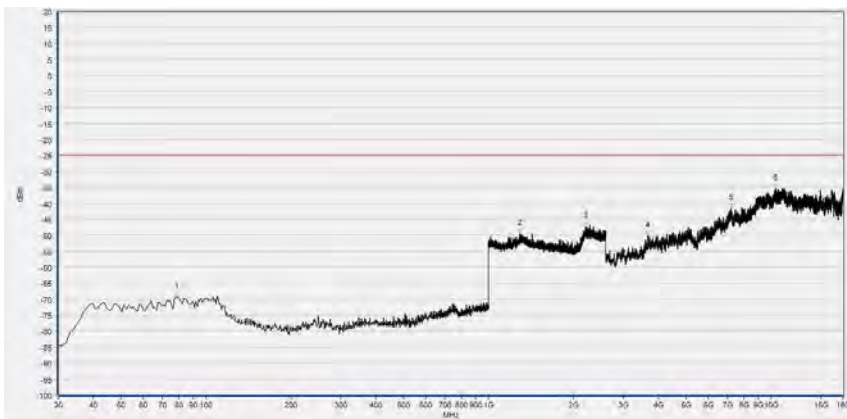

No.	Fre.(MHz)	PK (dBm)	Limit (dBm)	Antenna	Verdict
1	78.549	-69.31	-25.00	Vertical	PASS
2	1289.163	-49.51	-25.00	Vertical	PASS
3	2199.867	-47.22	-25.00	Vertical	PASS
4	3665.893	-50.25	-25.00	Vertical	PASS
5	7242.488	-41.49	-25.00	Vertical	PASS
6	10350.830	-35.46	-25.00	Vertical	PASS

LTE Band 38, 20MHz BW, High Channel, QPSK

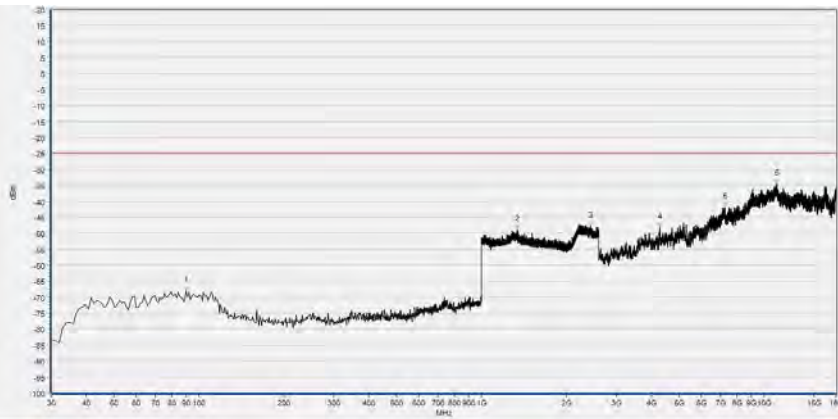

No.	Fre.(MHz)	PK (dBm)	Limit (dBm)	Antenna	Verdict
1	90.200	-67.96	-25.00	Horizontal	PASS
2	1339.313	-48.75	-25.00	Horizontal	PASS
3	2437.279	-47.77	-25.00	Horizontal	PASS
4	4275.855	-48.13	-25.00	Horizontal	PASS
5	7248.650	-41.80	-25.00	Horizontal	PASS
6	11130.226	-34.52	-25.00	Horizontal	PASS

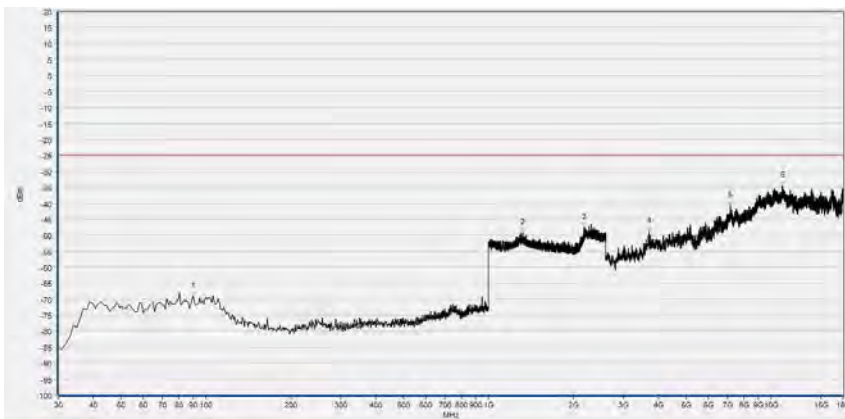

No.	Fre.(MHz)	PK (dBm)	Limit (dBm)	Antenna	Verdict
1	90.200	-68.85	-25.00	Vertical	PASS
2	1322.241	-49.33	-25.00	Vertical	PASS
3	2174.258	-47.58	-25.00	Vertical	PASS
4	3702.861	-48.91	-25.00	Vertical	PASS
5	7190.118	-40.82	-25.00	Vertical	PASS
6	10976.195	-34.50	-25.00	Vertical	PASS

LTE Band 40, Block A, 5MHz BW, Low Channel, QPSK

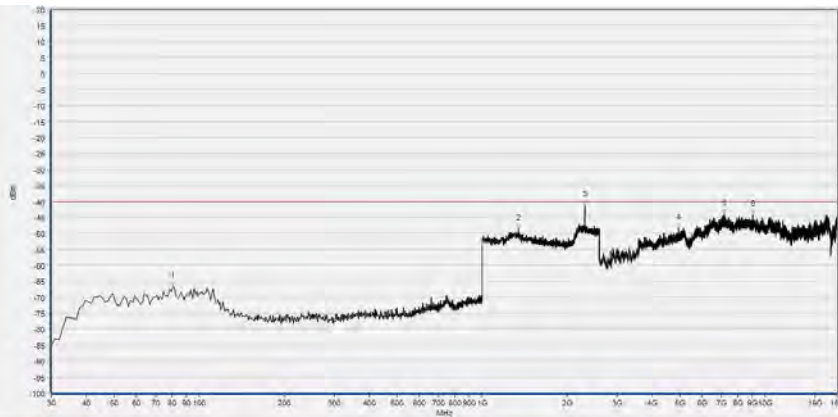

No.	Fre.(MHz)	PK (dBm)	Limit (dBm)	Antenna	Verdict
1	80.490	-66.80	-40.00	Horizontal	PASS
2	1342.743	-48.49	-40.00	Horizontal	PASS
3	2305.305	-41.20	-40.00	Horizontal	PASS
4	4947.429	-48.47	-40.00	Horizontal	N/A
5	7165.473	-44.01	-40.00	Horizontal	PASS
6	9041.568	-44.19	-40.00	Horizontal	PASS

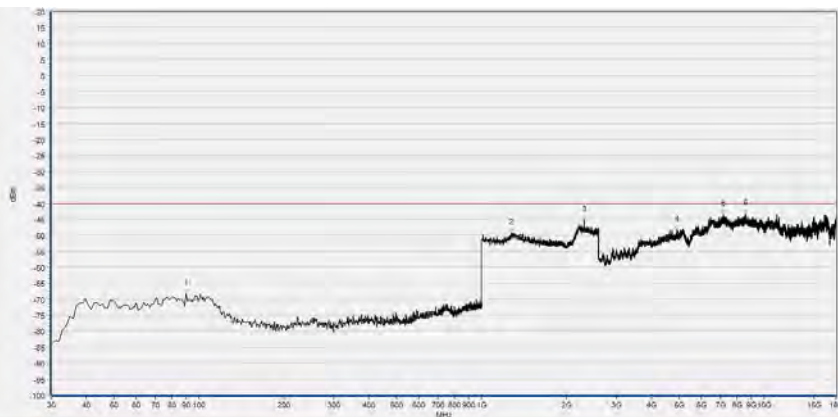

No.	Fre.(MHz)	PK (dBm)	Limit (dBm)	Antenna	Verdict
1	90.200	-68.20	-40.00	Vertical	PASS
2	1277.077	-49.29	-40.00	Vertical	PASS
3	2305.305	-45.27	-40.00	Vertical	N/A
4	4922.785	-48.30	-40.00	Vertical	PASS
5	7171.634	-43.49	-40.00	Vertical	PASS
6	8619.524	-43.20	-40.00	Vertical	PASS

LTE Band 40, Block A, 5MHz BW, High Channel, QPSK

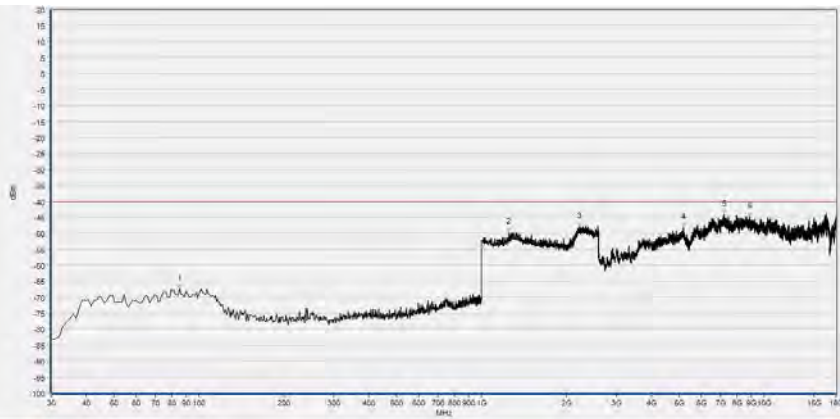

No.	Fre.(MHz)	PK (dBm)	Limit (dBm)	Antenna	Verdict
1	85.345	-67.43	-40.00	Horizontal	PASS
2	1249.850	-49.77	-40.00	Horizontal	PASS
3	2223.624	-48.02	-40.00	Horizontal	PASS
4	5187.718	-48.05	-40.00	Horizontal	PASS
5	7205.521	-44.16	-40.00	Horizontal	PASS
6	8902.941	-44.80	-40.00	Horizontal	PASS

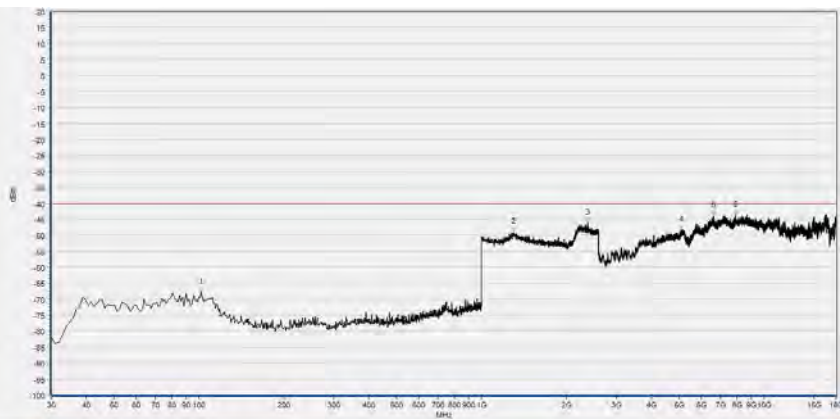

No.	Fre.(MHz)	PK (dBm)	Limit (dBm)	Antenna	Verdict
1	101.852	-67.78	-40.00	Vertical	PASS
2	1296.296	-49.01	-40.00	Vertical	PASS
3	2385.385	-46.19	-40.00	Vertical	PASS
4	5098.380	-48.47	-40.00	Vertical	PASS
5	6629.446	-43.84	-40.00	Vertical	PASS
6	7926.385	-43.71	-40.00	Vertical	PASS

LTE Band 40, Block B, 5MHz BW, Low Channel, QPSK

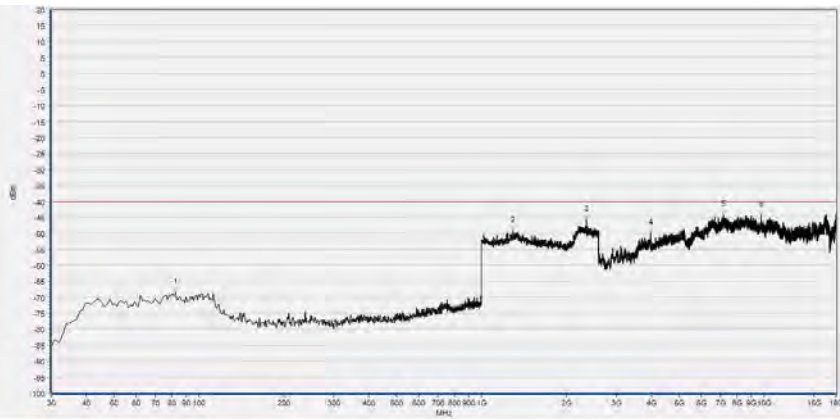

No.	Fre.(MHz)	PK (dBm)	Limit (dBm)	Antenna	Verdict
1	82.432	-68.55	-40.00	Horizontal	PASS
2	1293.093	-49.24	-40.00	Horizontal	PASS
3	2353.353	-45.72	-40.00	Horizontal	N/A
4	3967.794	-49.92	-40.00	Horizontal	PASS
5	7168.554	-44.09	-40.00	Horizontal	PASS
6	9756.271	-44.41	-40.00	Horizontal	PASS

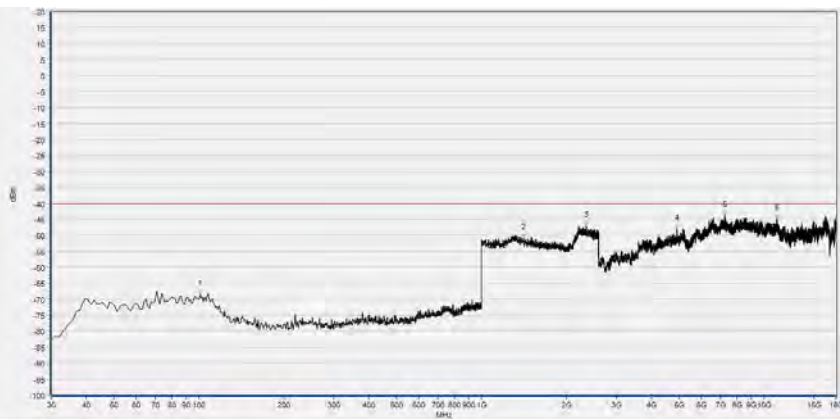

No.	Fre.(MHz)	PK (dBm)	Limit (dBm)	Antenna	Verdict
1	100.881	-68.40	-40.00	Vertical	PASS
2	1408.408	-50.86	-40.00	Vertical	PASS
3	2353.353	-47.01	-40.00	Vertical	N/A
4	4910.462	-48.00	-40.00	Vertical	PASS
5	7257.892	-43.79	-40.00	Vertical	PASS
6	11133.307	-44.91	-40.00	Vertical	PASS

LTE Band 40, Block B, 5MHz BW, High Channel, QPSK

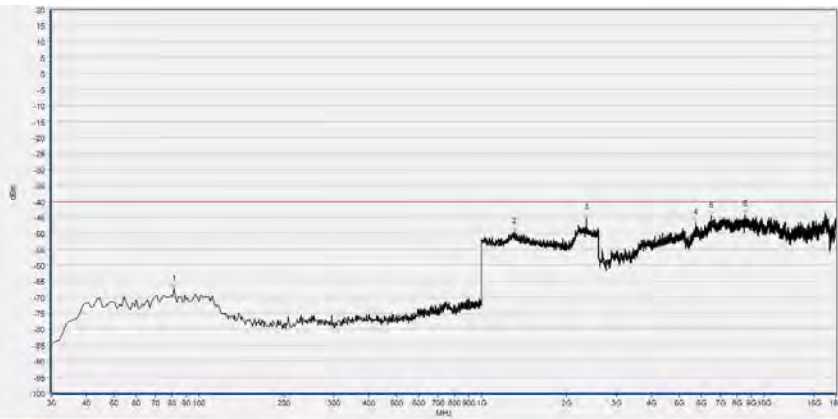

No.	Fre.(MHz)	PK (dBm)	Limit (dBm)	Antenna	Verdict
1	81.461	-67.38	-40.00	Horizontal	PASS
2	1307.508	-49.48	-40.00	Horizontal	PASS
3	2354.955	-45.28	-40.00	Horizontal	N/A
4	5732.987	-46.86	-40.00	Horizontal	PASS
5	6518.544	-44.63	-40.00	Horizontal	PASS
6	8573.315	-44.20	-40.00	Horizontal	PASS

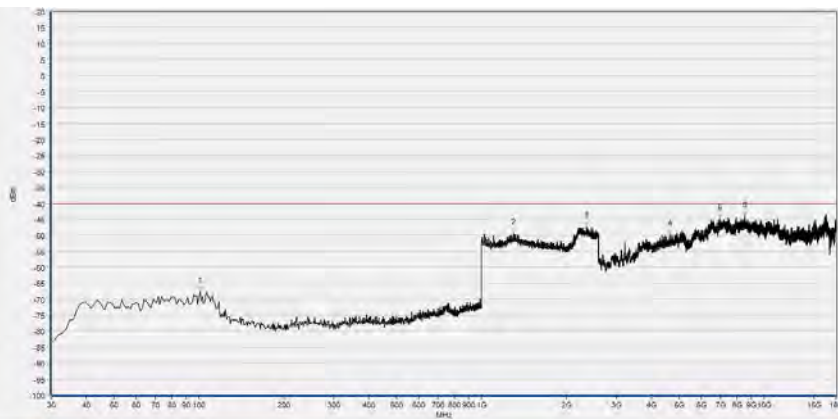

No.	Fre.(MHz)	PK (dBm)	Limit (dBm)	Antenna	Verdict
1	100.881	-67.64	-40.00	Vertical	PASS
2	1296.296	-49.31	-40.00	Vertical	PASS
3	2356.557	-47.20	-40.00	Vertical	N/A
4	4633.207	-49.71	-40.00	Vertical	PASS
5	6983.717	-44.89	-40.00	Vertical	PASS
6	8533.267	-43.88	-40.00	Vertical	PASS



LTE Band 41, 20MHz BW, Low Channel, QPSK

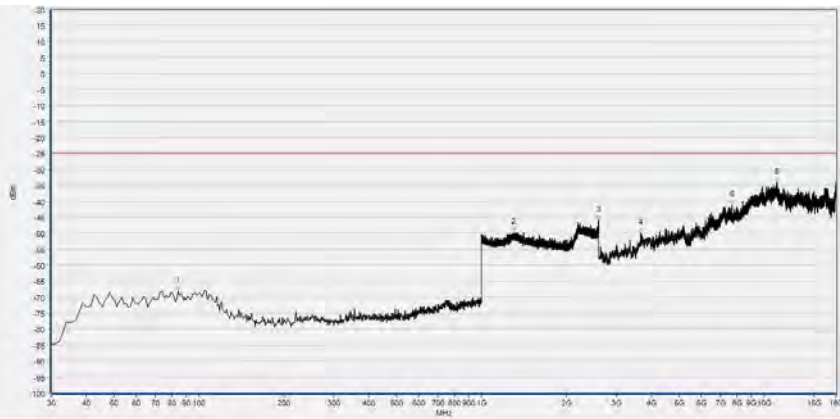

No.	Fre.(MHz)	PK (dBm)	Limit (dBm)	Antenna	Verdict
1	84.374	-68.05	-25.00	Horizontal	PASS
2	1296.099	-49.73	-25.00	Horizontal	PASS
3	2591.464	-45.99	-25.00	Horizontal	N/A
4	3653.571	-49.88	-25.00	Horizontal	PASS
5	7683.017	-41.29	-25.00	Horizontal	PASS
6	11127.145	-34.14	-25.00	Horizontal	PASS

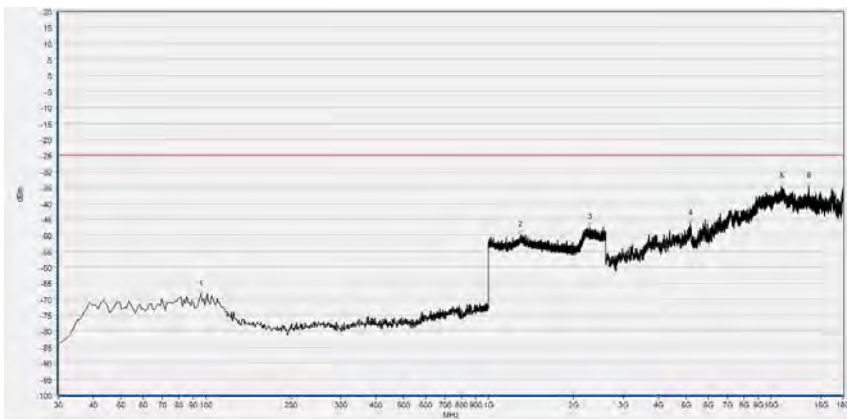

No.	Fre.(MHz)	PK (dBm)	Limit (dBm)	Antenna	Verdict
1	96.026	-68.41	-25.00	Vertical	PASS
2	1299.833	-49.85	-25.00	Vertical	PASS
3	2279.360	-47.57	-25.00	Vertical	PASS
4	5190.798	-46.35	-25.00	Vertical	PASS
5	10926.905	-34.78	-25.00	Vertical	PASS
6	13594.719	-34.81	-25.00	Vertical	PASS

LTE Band 41, 20MHz BW, Mid Channel, QPSK

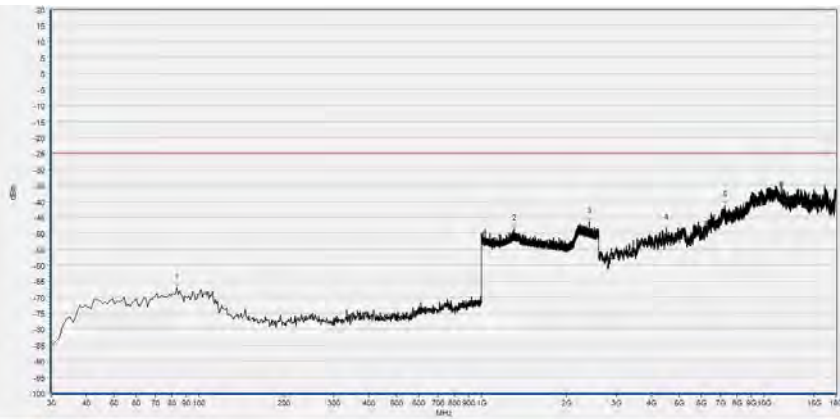

No.	Fre.(MHz)	PK (dBm)	Limit (dBm)	Antenna	Verdict
1	83.403	-66.90	-25.00	Horizontal	PASS
2	1307.836	-48.66	-25.00	Horizontal	PASS
3	2401.000	-46.36	-25.00	Horizontal	PASS
4	4522.304	-48.34	-25.00	Horizontal	PASS
5	7257.892	-41.24	-25.00	Horizontal	PASS
6	11490.658	-35.29	-25.00	Horizontal	PASS

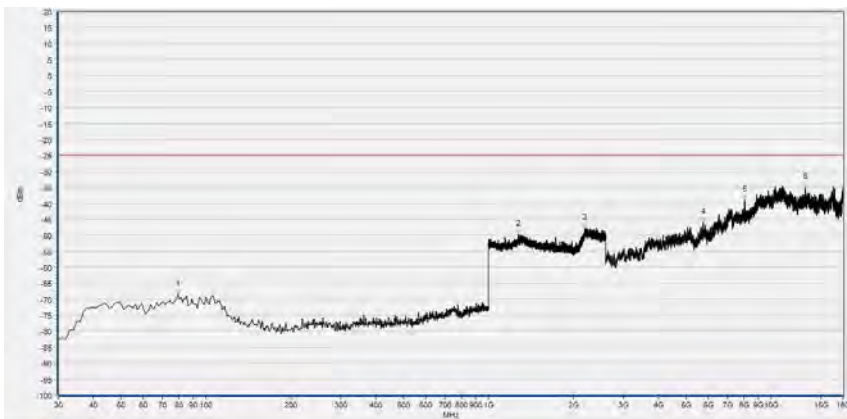

No.	Fre.(MHz)	PK (dBm)	Limit (dBm)	Antenna	Verdict
1	79.520	-68.39	-25.00	Vertical	PASS
2	1273.691	-49.68	-25.00	Vertical	PASS
3	2198.800	-47.81	-25.00	Vertical	PASS
4	5754.551	-45.99	-25.00	Vertical	PASS
5	8055.771	-39.05	-25.00	Vertical	PASS
6	13243.529	-35.07	-25.00	Vertical	PASS