

7.6. Time of Occupancy Measurement

7.6.1. Test Limit

The maximum permissible time of occupancy is 400ms within a period of 400ms multiplied by the number of hopping channels employed.

7.6.2. Test Procedure Used

ANSI C63.10-2009 – Section 7.7.4

7.6.3. Test Setting

1. Span = zero span, centered on a hopping channel.
2. RBW = 1MHz
3. VBW \geq RBW
4. Sweep time = as necessary to capture the entire dwell time per hopping channel
5. Detector = Peak
6. Trace mode = max hold

If possible, use the marker-delta function to determine the dwell time. If this value varies with different modes of operation (data rate, modulation format, etc.), repeat this test for each variation.

An oscilloscope may be used instead of a spectrum analyzer. The EUT shall show compliance with the appropriate regulatory limit for the number of hopping channels. A plot of the data shall be included in the test report.

7.6.4. Test Setup

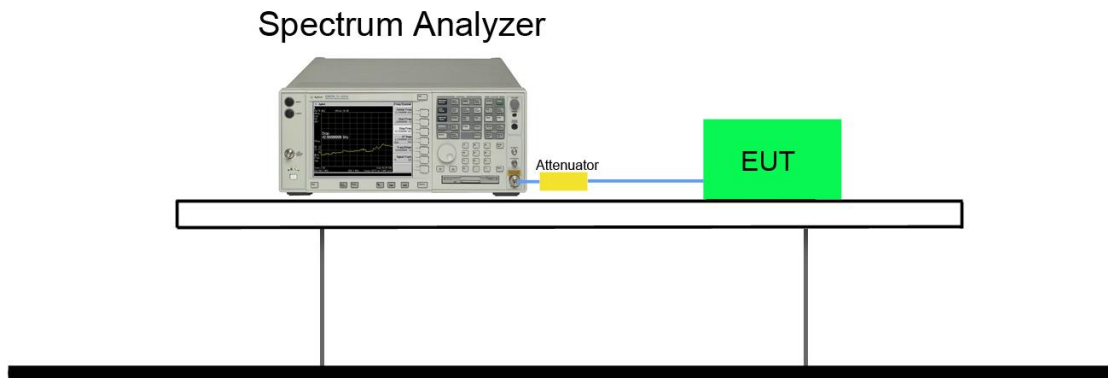

7.6.5. Test Result

Test Mode	Channel No.	Frequency (MHz)	Time of Occupancy (ms)	Limit (ms)	Result
3DH1	39	2441	121.60	< 400	Pass
3DH3	39	2441	259.20	< 400	Pass
3DH5	39	2441	322.56	< 400	Pass

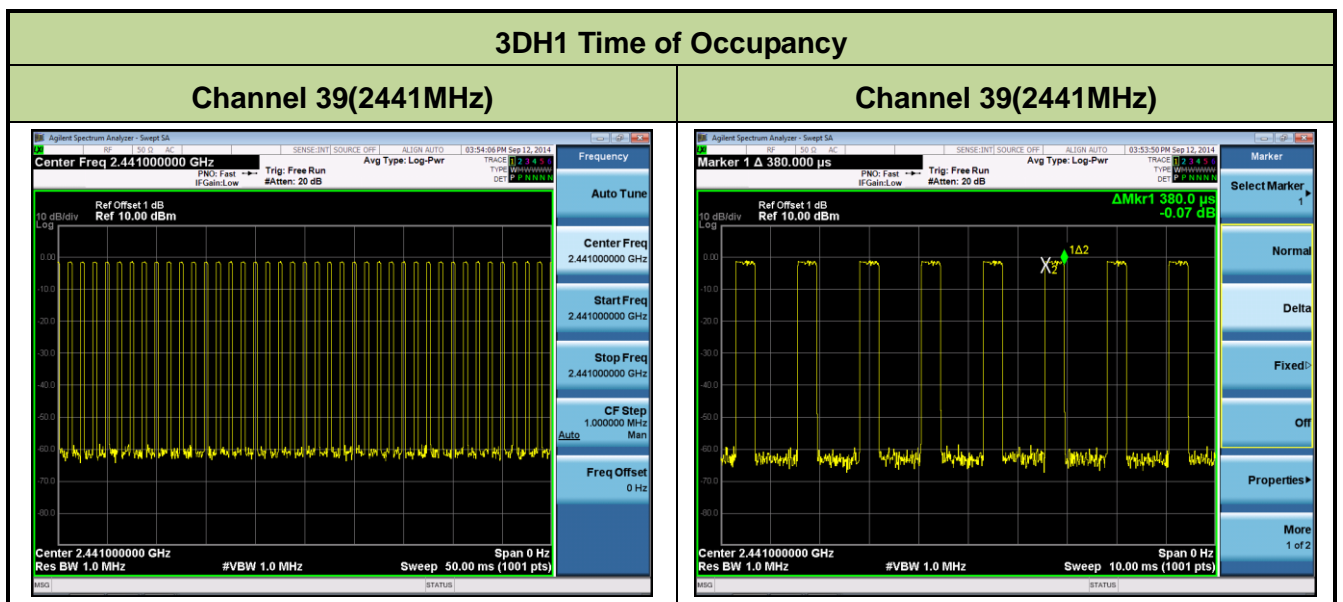

Note: Test Time Period: $0.4 * 79 = 31.6$ sec, Hopping Times Within 1sec: $40/50$ msec= 800 hops/sec.
 The Maximum Occupancy Time within 31.6sec: $[(0.380\text{ms} * 800) / 79] * 31.6 = 121.60$ msec.

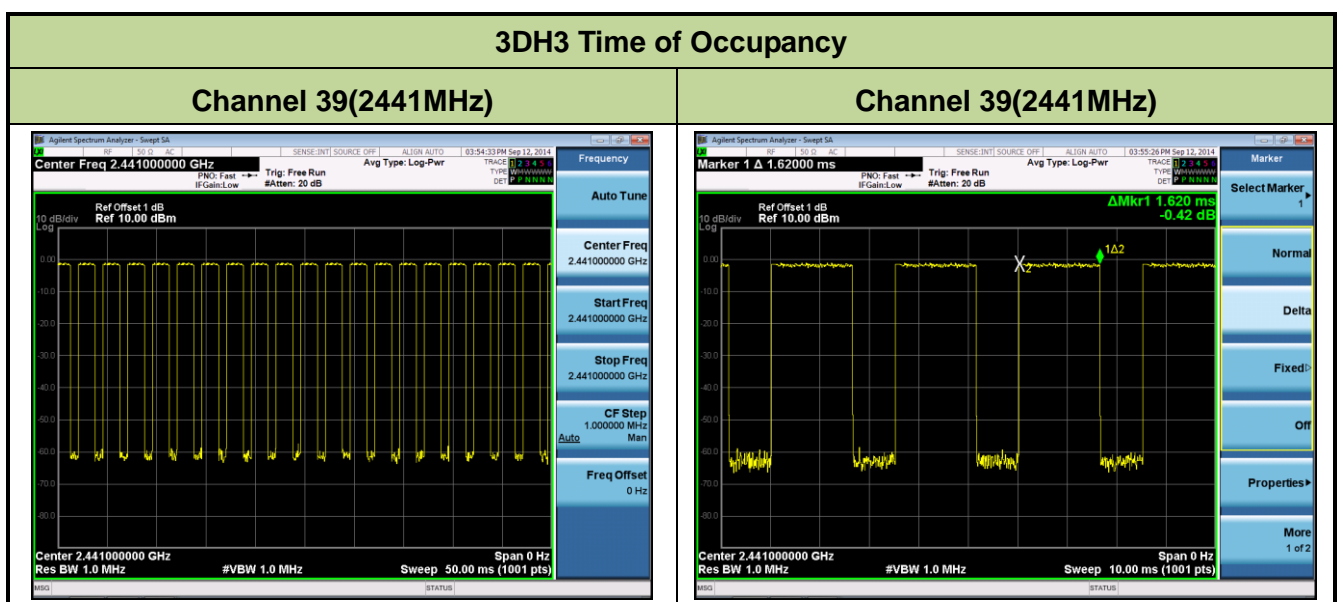

Note: Test Time Period: $0.4 * 79 = 31.6$ sec, Hopping Times Within 1sec: $20/50$ msec= 400 hops/sec.
 The Maximum Occupancy Time within 31.6sec: $[(1.62\text{ms} * 400) / 79] * 31.6 = 259.20$ msec.

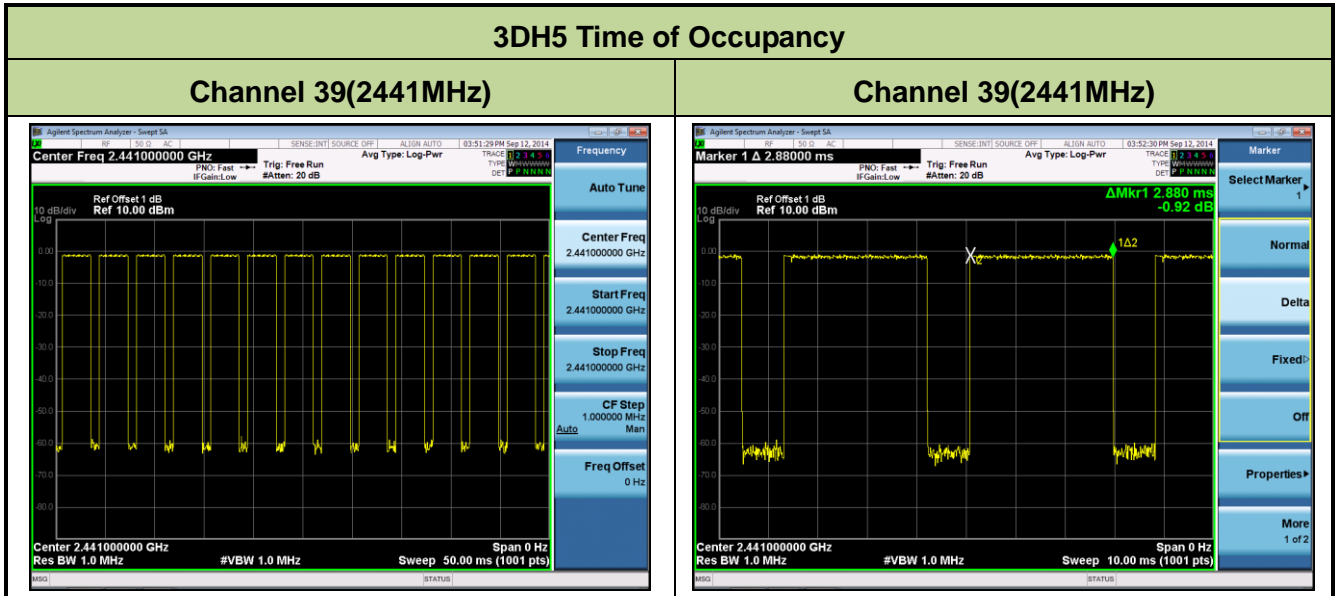

Note: Test Time Period: $0.4 \times 79 = 31.6$ sec, Hopping Times Within 1sec: $14/50$ msec = 280 hops/sec.

The Maximum Occupancy Time within 31.6sec: $[(2.880 \text{ ms} \times 280) / 79] \times 31.6 = 322.56$ msec.

7.7. Band-edge Compliance Measurement

7.7.1. Test Limit

The maximum permissible emission level is 20dBc. Any emission lying outside of the emission bandwidth and in a restricted band is subject to a field strength limit specified in Section 15.209 of the Title 47 CFR.

7.7.2. Test Procedure Used

ANSI C63.10-2009 – Section 7.7.9

7.7.3. Test Setting

1. Span = wide enough to capture the peak level of the emission operating on the channel closest to the band edge, as well as any modulation products which fall outside of the authorized band of operation.
2. RBW \geq 1% of spectrum analyzer display span
3. VBW \geq RBW
4. Detector = peak
5. Sweep time = auto couple
6. Trace mode = max hold
7. Trace was allowed to stabilize

Allow the trace to stabilize. Set the marker on the emission at the band edge, or on the highest modulation product outside of the band, if this level is greater than that at the band edge. Enable the marker-delta function, then use the marker-to-peak function to move the marker to the peak of the in-band emission.

7.7.4. Test Setup

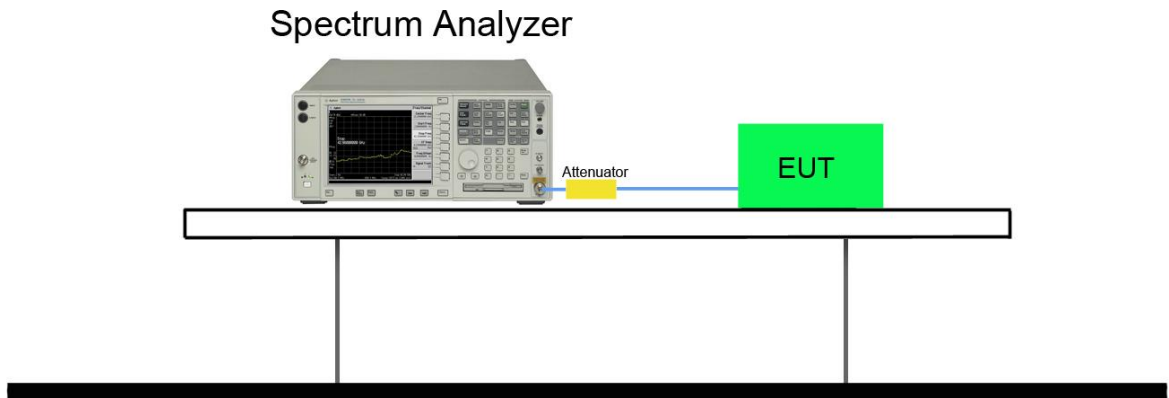

7.7.5. Test Result

Test Mode	Channel No.	Frequency (MHz)	Limit	Result
DH5	00	2402	20dBc	Pass
DH5	78	2480	20dBc	Pass
2DH5	00	2402	20dBc	Pass
2DH5	78	2480	20dBc	Pass
3DH5	00	2402	20dBc	Pass
3DH5	78	2480	20dBc	Pass

DH5 Band-edge Compliance
Channel 00 (2402MHz)

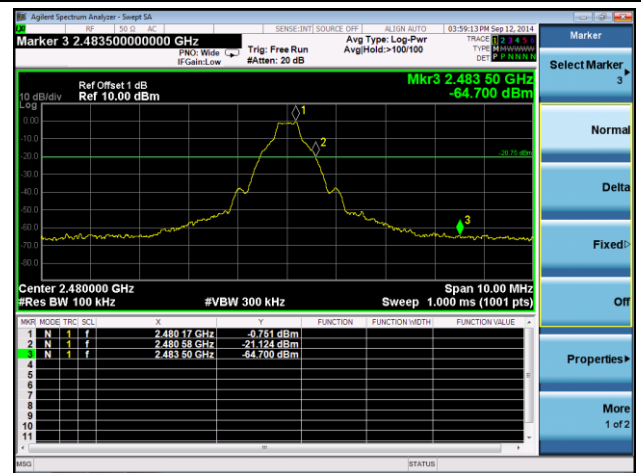
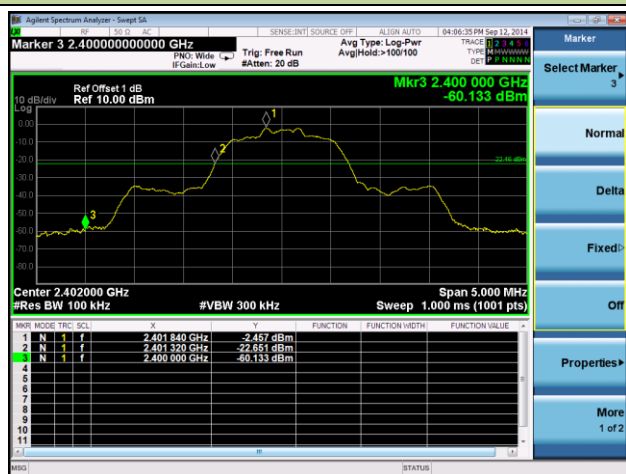
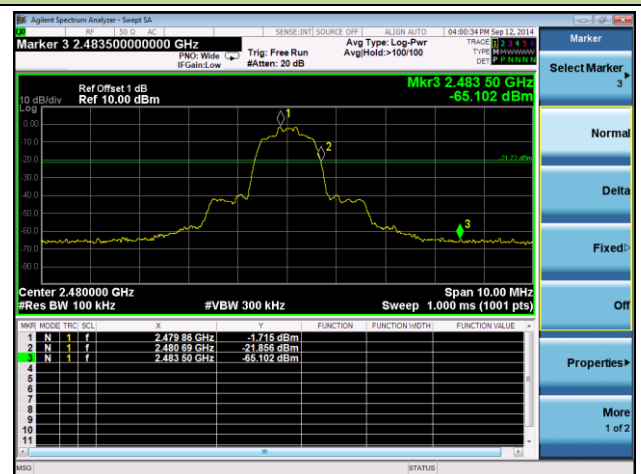
Channel 78 (2480MHz)

2DH5 Band-edge Compliance
Channel 00 (2402MHz)

Channel 78 (2480MHz)

3DH5 Band-edge Compliance

Channel 00 (2402MHz)

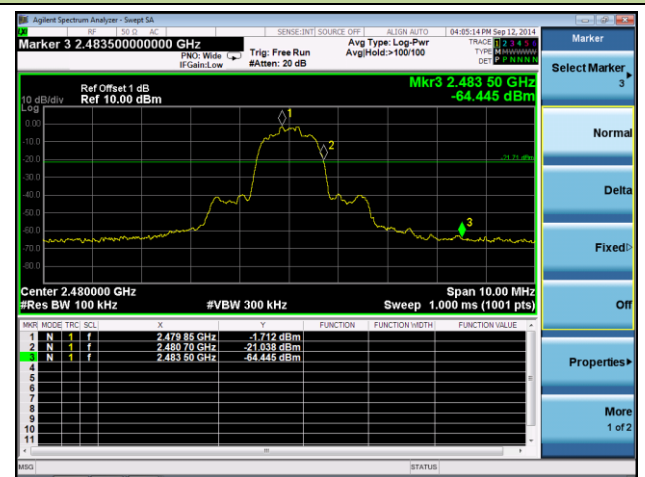

Channel 78 (2480MHz)



DH5 Band-edge Compliance within Hopping Mode

Channel 00 (2402MHz)

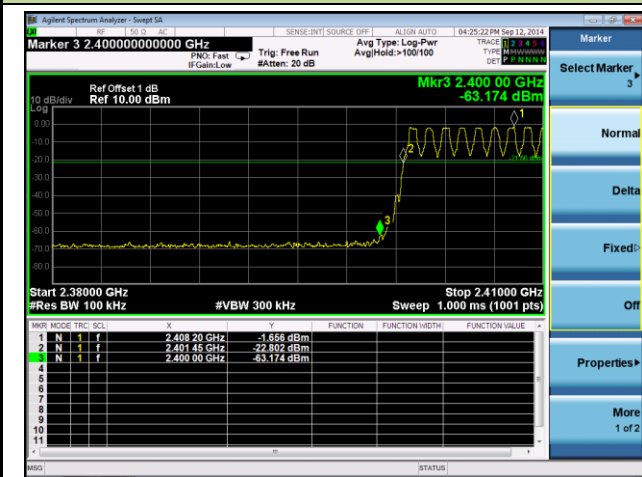

Channel 78 (2480MHz)

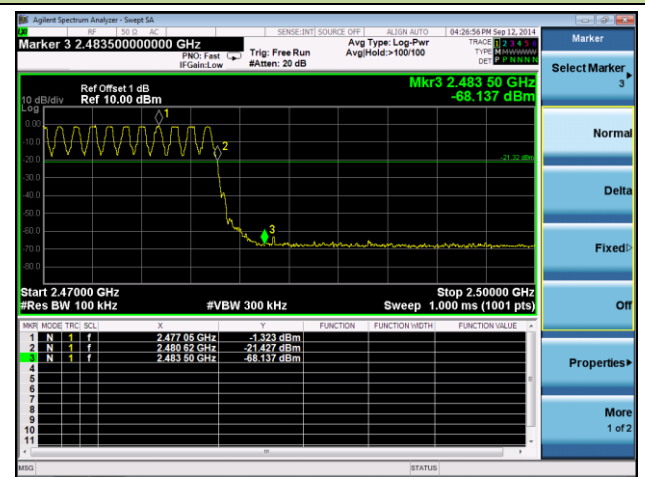

2DH5 Band-edge Compliance within Hopping Mode

Channel 00 (2402MHz)



Channel 78 (2480MHz)



3DH5 Band-edge Compliance within Hopping Mode

Channel 00 (2402MHz)

Channel 78 (2480MHz)

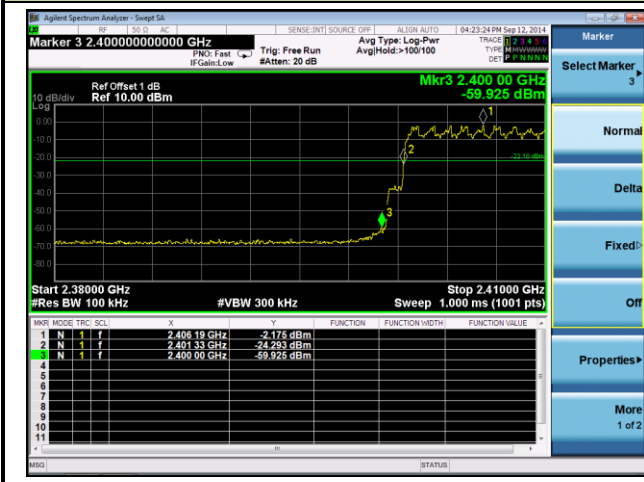

7.8. Conducted Spurious Emissions Measurement

7.8.1. Test Limit

In any 100 kHz bandwidth outside the frequency band in which the spread spectrum or digitally modulated intentional radiator is operating, the radio frequency power that is produced by the intentional radiator shall be at least 20 dB below that in the 100 kHz bandwidth within the band that contains the highest level of the desired power, based on either an RF conducted or a radiated measurement, provided the transmitter demonstrates compliance with the peak conducted or a radiated measurement, provided the transmitter demonstrates compliance with the peak conducted power limits. If the transmitter complies with the conducted power limits based on the use of RMS averaging over a time interval, the attenuation required under this paragraph shall be 30 dB instead of 20 dB.

7.8.2. Test Procedure Used

ANSI C63.10-2009 – Section 7.7.10

7.8.3. Test Setting

1. Span = wide enough to capture the peak level of the in-band emission and all spurious emissions (e.g., harmonics) from the lowest frequency generated in the EUT up through the 10th harmonic. Typically, several plots are required to cover this entire span.
2. RBW = 100 KHz
3. VBW \geq RBW
4. Detector = peak
5. Sweep time = auto couple
6. Trace mode = max hold
7. Trace was allowed to stabilize

Set the marker on the peak of any spurious emission recorded. The level displayed must comply with the limit specified in this section.

7.8.4. Test Setup

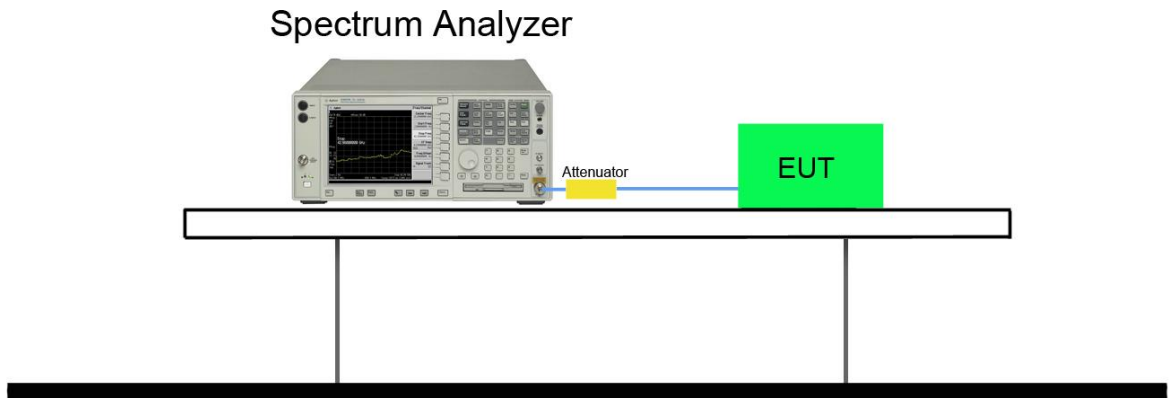

7.8.5. Test Result

Test Mode	Channel No.	Frequency (MHz)	Limit (MHz)	Result
DH5	00	2402	20dBc	Pass
DH5	39	2441	20dBc	Pass
DH5	78	2480	20dBc	Pass
2DH5	00	2402	20dBc	Pass
2DH5	39	2441	20dBc	Pass
2DH5	78	2480	20dBc	Pass
3DH5	00	2402	20dBc	Pass
3DH5	39	2441	20dBc	Pass
3DH5	78	2480	20dBc	Pass

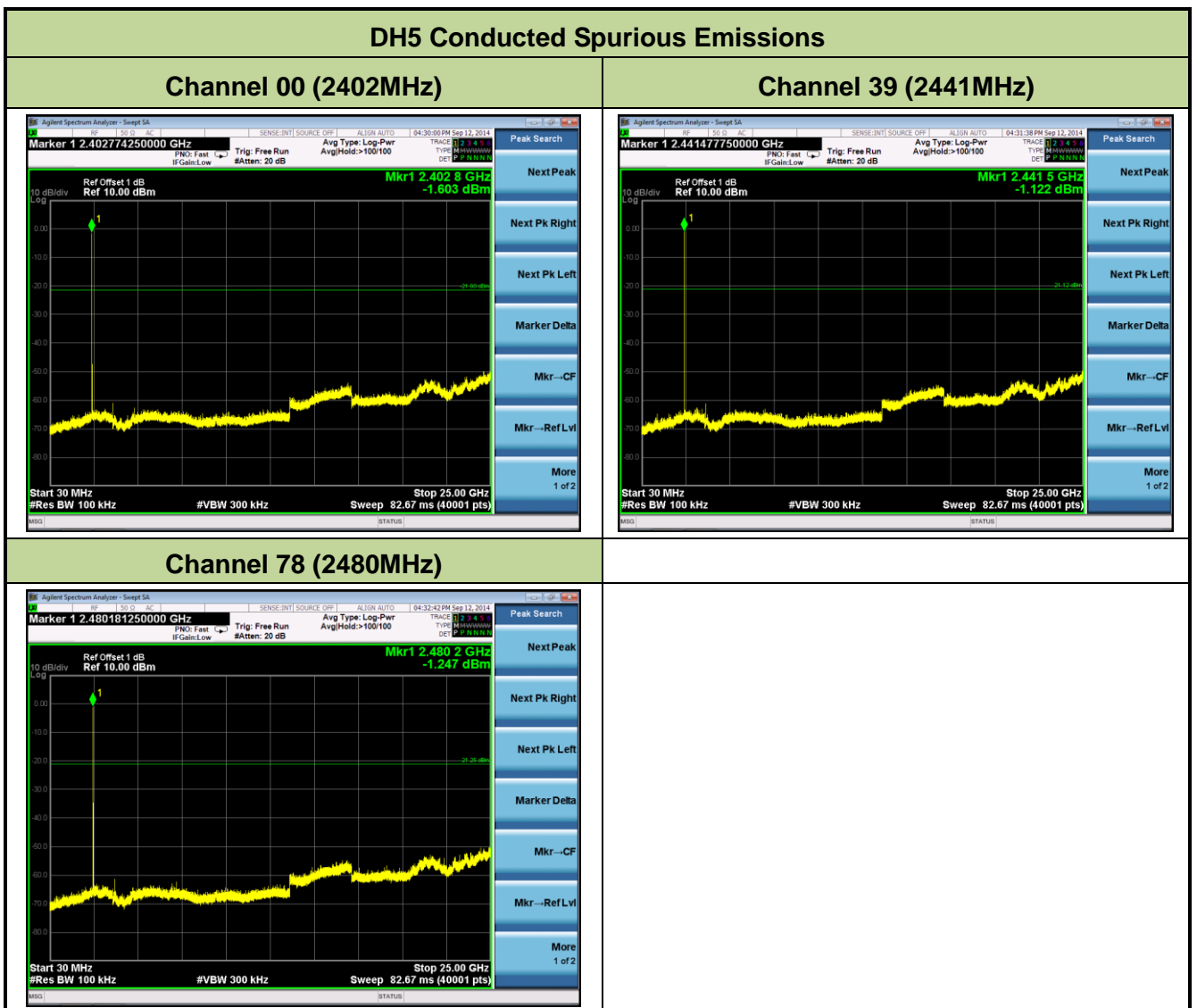

2DH5 Conducted Spurious Emissions

Channel 00 (2402MHz)

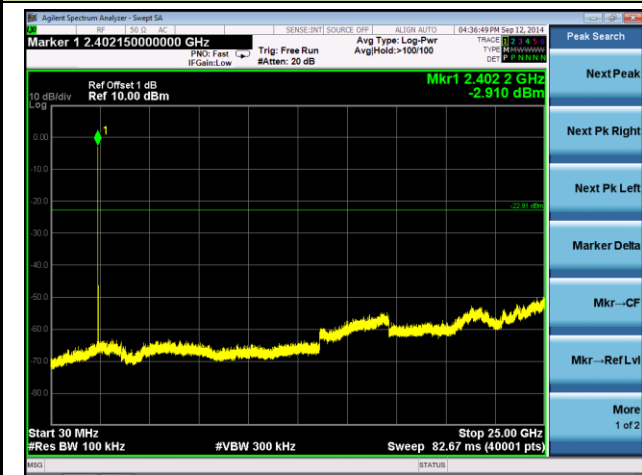

Channel 39 (2441MHz)



Channel 78 (2480MHz)

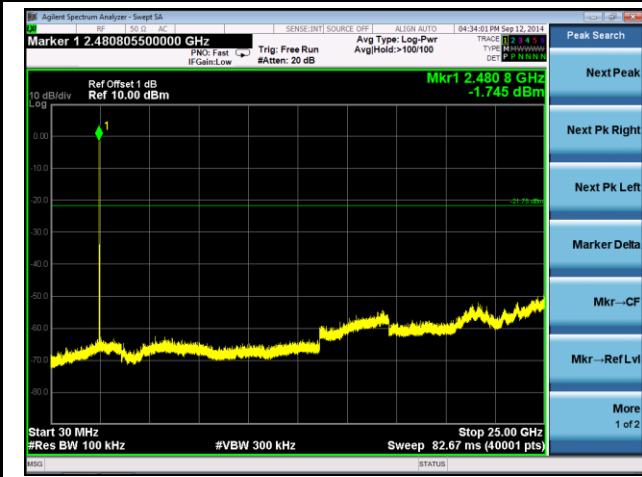

3DH5 Conducted Spurious Emissions

Channel 00 (2402MHz)



Channel 39 (2441MHz)



Channel 78 (2480MHz)



7.9. Radiated Spurious Emission Measurement

7.9.1. Test Limit

All out of band emissions appearing in a restricted band as specified in Section 15.205 of the Title 47 CFR must not exceed the limits shown in Table per Section 15.209.

FCC Part 15 Subpart C Paragraph 15.209		
Frequency [MHz]	Field Strength [V/m]	Measured Distance [Meters]
0.009 – 0.490	2400/F (kHz)	300
0.490 – 1.705	24000/F (kHz)	30
1.705 - 30	30	30
30 - 88	100	3
88 - 216	150	3
216 - 960	200	3
Above 960	500	3

7.9.2. Test Procedure Used

ANSI C63.10-2009 – Section 7.10.1 & Section 7.10.2

7.9.3. Test Setting

Peak Field Strength Measurements

1. Analyzer center frequency was set to the frequency of the radiated spurious emission of interest
2. RBW = 1MHz
3. VBW = 3MHz
4. Detector = peak
5. Sweep time = auto couple
6. Trace mode = max hold
7. Trace was allowed to stabilize

Average Field Strength Measurements

1. Analyzer center frequency was set to the frequency of the radiated spurious emission of interest
2. RBW = 1MHz
3. VBW = 3MHz
4. Detector = power average (RMS)
5. Number of measurement points = 1001 (Number of points must be $> 2 \times \text{span}/\text{RBW}$)
6. Sweep time = auto
7. Trace (RMS) averaging was performed over at least 100 traces

7.9.4. Test Setup

9kHz ~ 30MHz Test Setup:

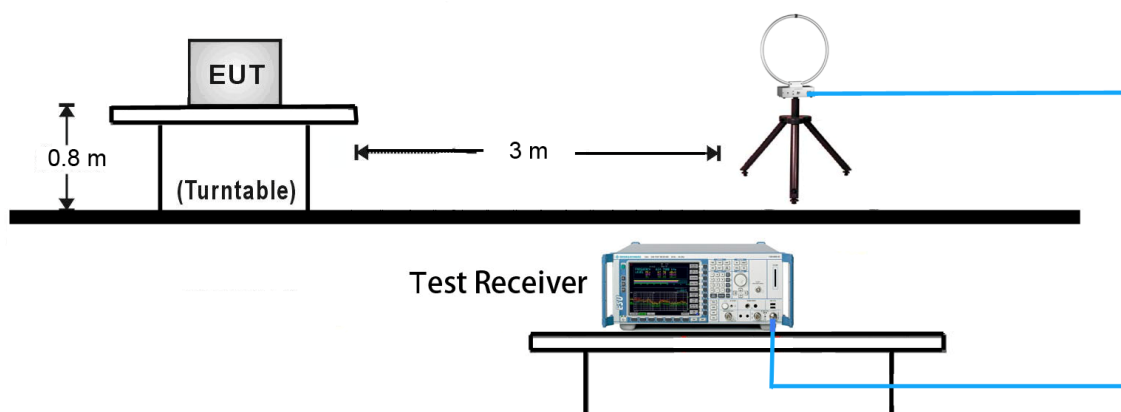

30MHz ~ 1GHz Test Setup:

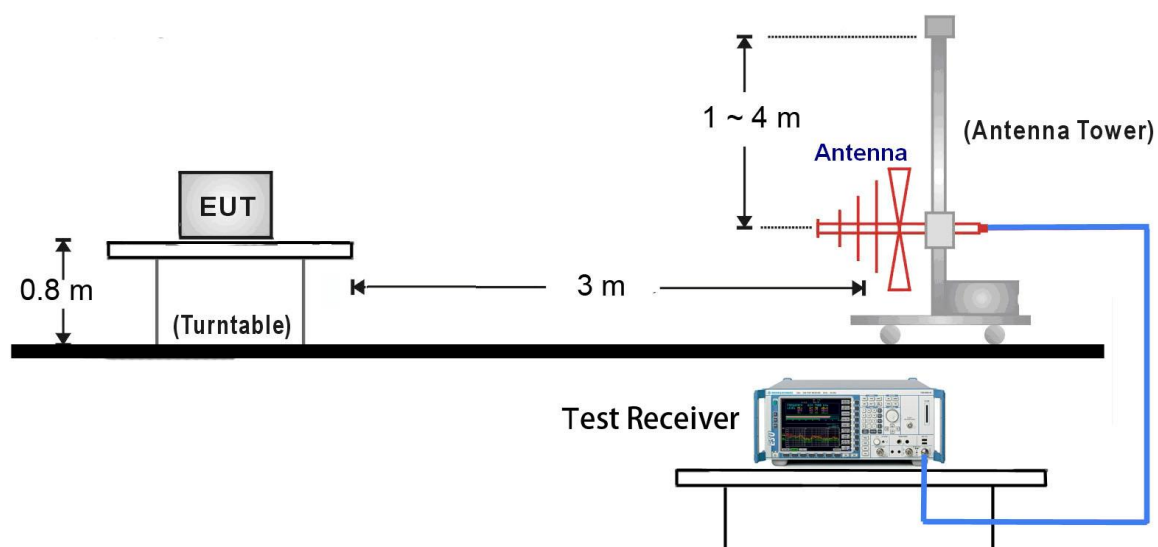

1GHz ~ 25GHz Test Setup:

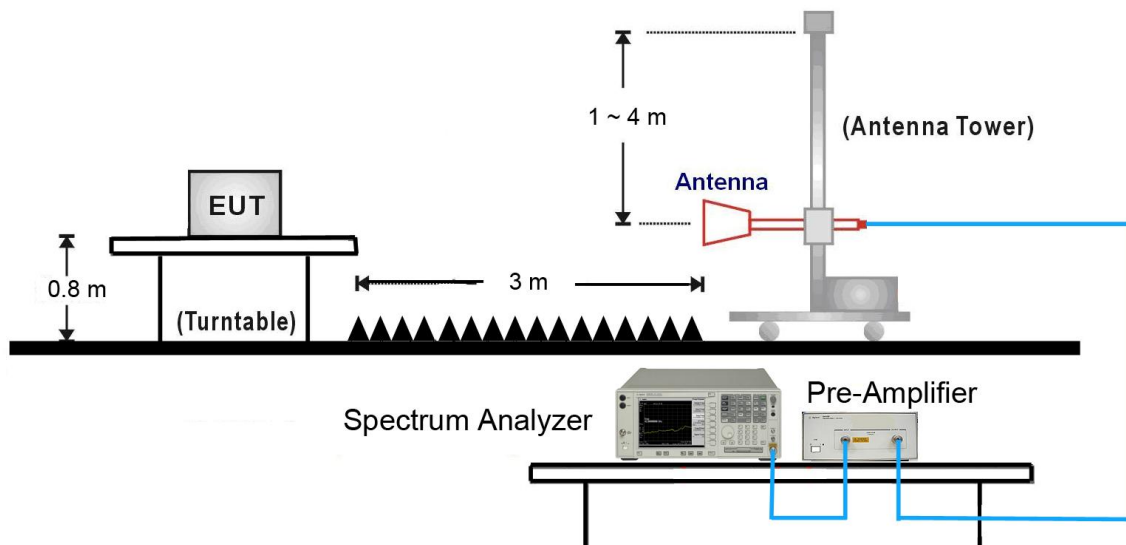

7.9.5. Test Result

Test Mode:	DH5	Test Site:	AC1
Test Channel:	78	Test Engineer:	Milo Li
Remark:	1. Average measurement was not performed if peak level lower than average limit. 2. The worst case of Radiated Spurious Emission. 3. Other frequency was 20dB below limit line within 1-18GHz, there is not show in the report.		

Mark	Frequency (MHz)	Reading Level (dB μ V/m)	Factor (dB)	Measure Level (dB μ V/m)	Limit (dB μ V/m)	Margin (dB)	Detector	Polarization
*	3516.0	36.8	3.9	40.7	68.9	-28.2	Peak	Horizontal
*	4459.5	36.0	5.5	41.5	68.9	-27.4	Peak	Horizontal
	4882.0	36.6	6.6	43.2	74.0	-30.8	Peak	Horizontal
	7323.0	34.5	14.0	48.5	74.0	-25.5	Peak	Horizontal
*	3439.5	36.2	3.5	39.7	68.9	-29.2	Peak	Vertical
*	4476.5	38.4	5.6	44.0	68.9	-24.9	Peak	Vertical
	4882.0	36.8	6.6	43.4	74.0	-30.6	Peak	Vertical
	7323.0	35.0	14.0	49.0	74.0	-25.0	Peak	Vertical

Note 1: "*" is not in restricted band, its limit is 20dBc of the fundamental emission level (88.9dB μ V/m).

Note 2: Measure Level (dB μ V/m) = Reading Level (dB μ V) + Factor (dB)

Factor (dB) = Cable Loss (dB) + Antenna Factor (dB/m) - Pre_Amplifier Gain (dB)

The worst case of Radiated Emission 9KHz ~ 1GHz and 18GHz ~ 25GHz:

Engineer: Milo Li	
Site: AC1	Time: 2014/09/01 - 15:59
Limit: FCC_Part15.209_RE(3m)	Margin: 0
Probe: VULB9162_0.03-8GHz	Polarity: Horizontal
EUT: Mobile Data Terminal	Power: AC 120V/60Hz
Worst Case Mode: DH5 channel 2480MHz	

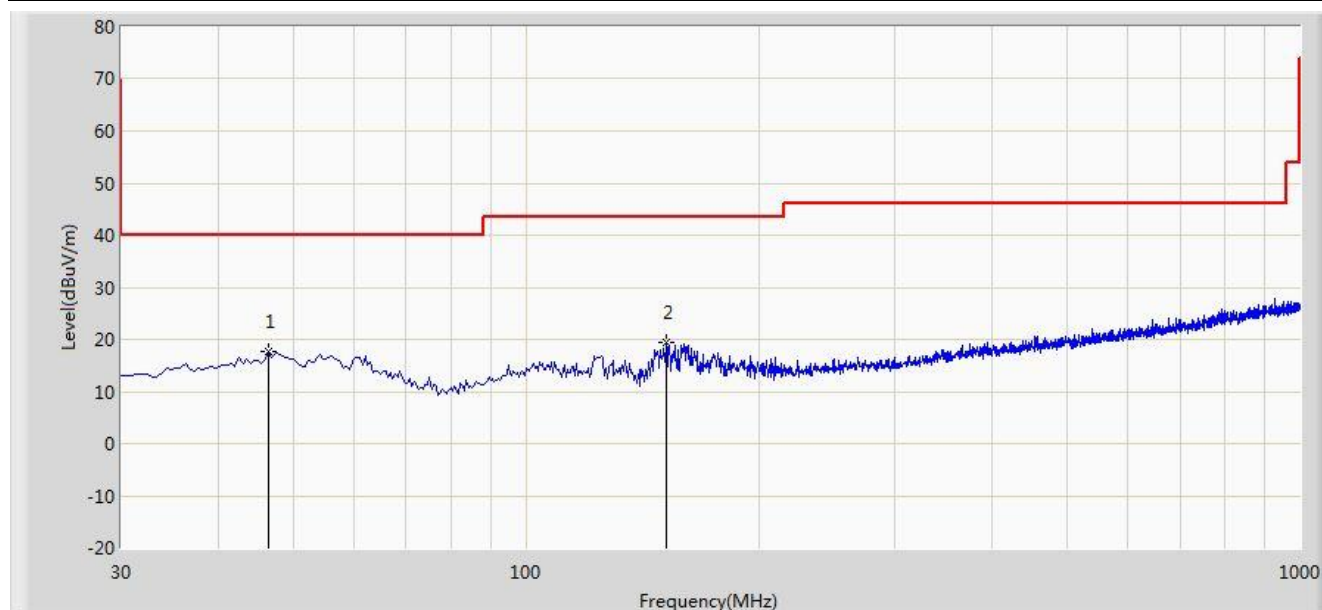

No	Flag	Mark	Frequency (MHz)	Measure Level (dBuV/m)	Reading Level (dBuV)	Over Limit (dB)	Limit (dBuV/m)	Factor (dB)	Type
1		*	46.490	17.723	2.907	-22.277	40.000	14.816	QP
2			151.735	19.557	10.326	-23.943	43.500	9.232	QP

Note: Measure Level (dB μ V/m) = Reading Level (dB μ V) + Factor (dB)

Factor (dB) = Cable Loss (dB) + Antenna Factor (dB/m).

Engineer: Milo Li	
Site: AC1	Time: 2014/09/01 - 16:02
Limit: FCC_Part15.209_RE(3m)	Margin: 0
Probe: VULB9162_0.03-8GHz	Polarity: Vertical
EUT: Mobile Data Terminal	Power: AC 120V/60Hz
Worst Case Mode: DH5 channel 2480MHz	

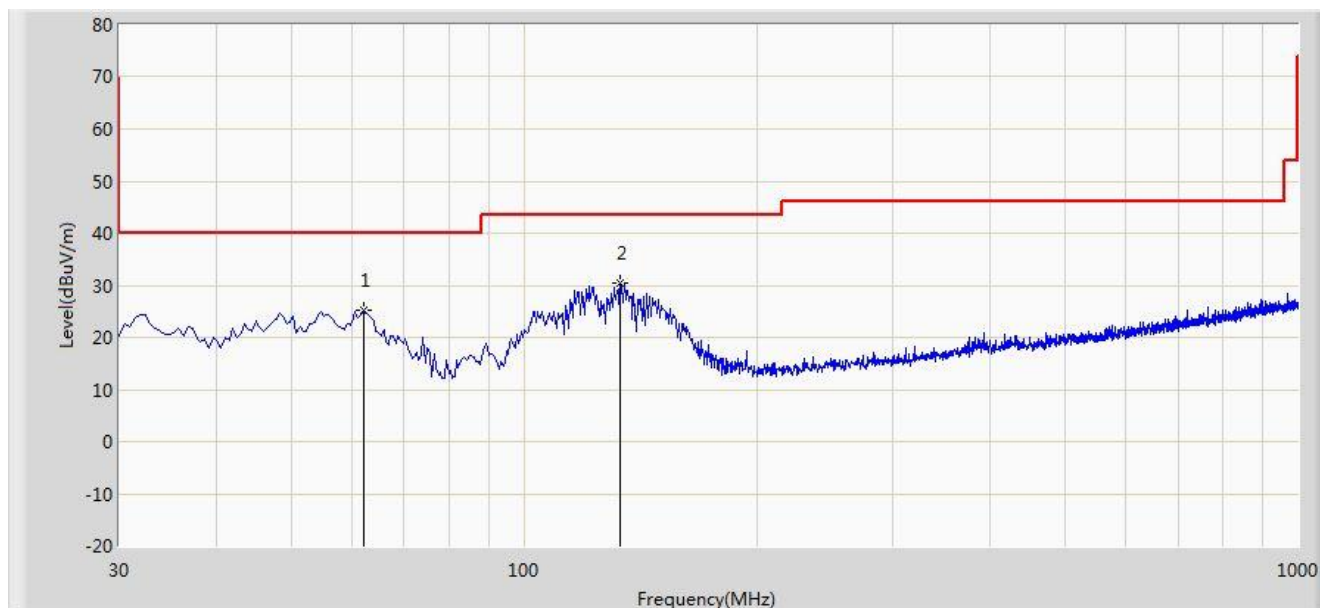

No	Flag	Mark	Frequency (MHz)	Measure Level (dBuV/m)	Reading Level (dBuV)	Over Limit (dB)	Limit (dBuV/m)	Factor (dB)	Type
1			62.010	25.306	11.971	-14.694	40.000	13.335	QP
2		*	133.305	30.526	21.015	-12.974	43.500	9.511	QP

Note: Measure Level (dB μ V/m) = Reading Level (dB μ V) + Factor (dB)

Factor (dB) = Cable Loss (dB) + Antenna Factor (dB/m).

Engineer: Roy Cheng	
Site: AC1	Time: 2014/09/01 - 13:34
Limit: FCC_Part15.209_RE(3m)	Margin: 0
Probe: FMZB1519_0.009-30MHz	Polarity: Face On
EUT: Mobile Data Terminal	Power: AC 120V/60Hz
Note: There is the ambient noise within frequency range 9kHz~30MHz.	

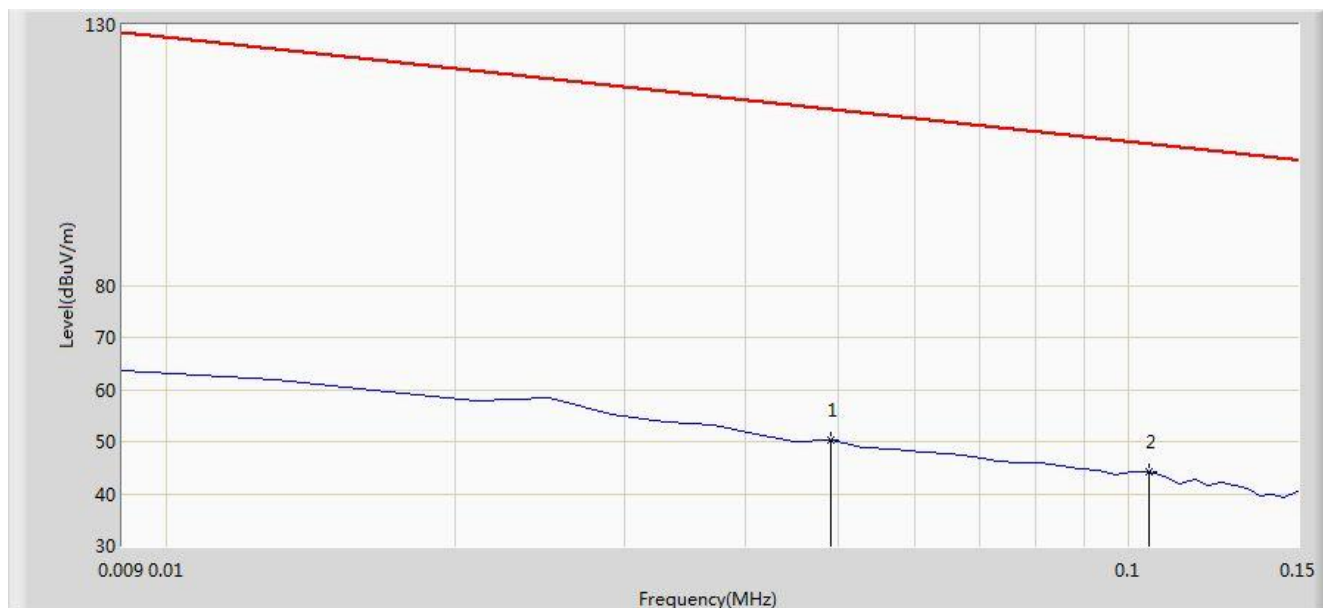

No	Flag	Mark	Frequency (MHz)	Measure Level (dBuV/m)	Reading Level (dBuV)	Over Limit (dB)	Limit (dBuV/m)	Factor (dB)	Type
1			0.049	50.367	29.861	-63.422	113.789	20.505	QP
2		*	0.105	44.143	23.996	-63.029	107.173	20.147	QP

Note: Measure Level (dB μ V/m) = Reading Level (dB μ V) + Factor (dB)

Factor (dB) = Cable Loss (dB) + Antenna Factor (dB/m)

Engineer: Roy Cheng	
Site: AC1	Time: 2014/09/01 - 13:45
Limit: FCC_Part15.209_RE(3m)	Margin: 0
Probe: FMZB1519_0.009-30MHz	Polarity: Face On
EUT: Mobile Data Terminal	Power: AC 120V/60Hz
Note: There is the ambient noise within frequency range 9kHz~30MHz.	

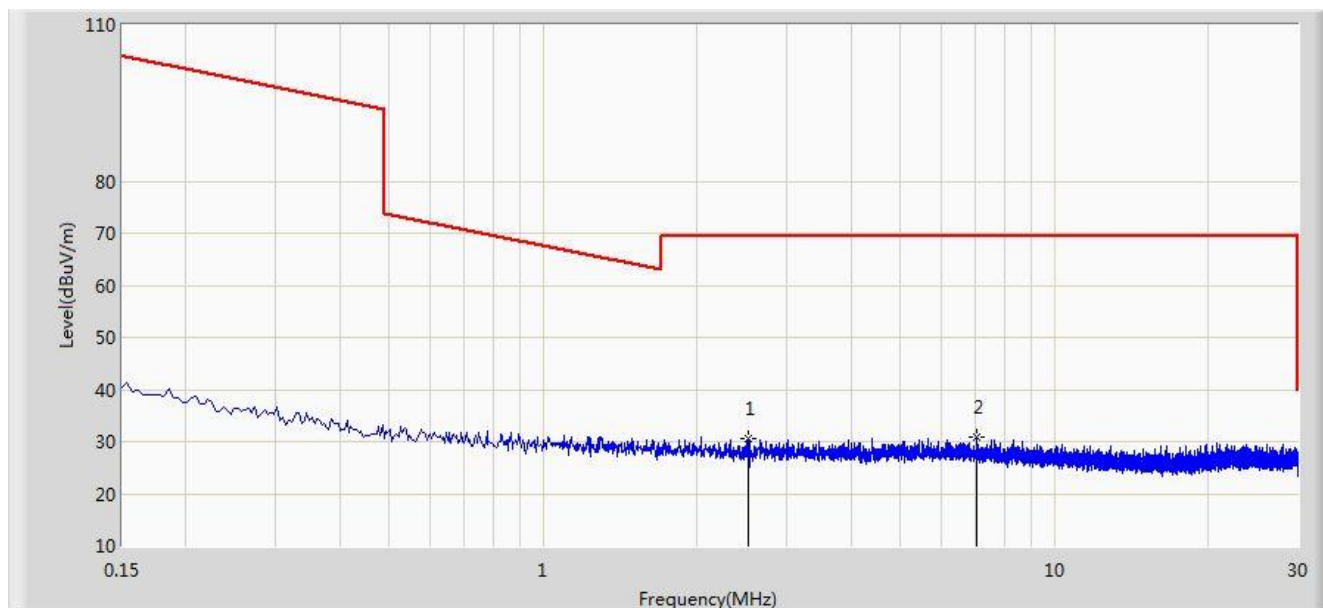

No	Flag	Mark	Frequency (MHz)	Measure Level (dBuV/m)	Reading Level (dBuV)	Over Limit (dB)	Limit (dBuV/m)	Factor (dB)	Type
1			2.513	30.495	10.336	-39.005	69.500	20.159	QP
2		*	7.041	30.974	10.579	-38.526	69.500	20.395	QP

Note: Measure Level (dBμV/m) = Reading Level (dBμV) + Factor (dB)

Factor (dB) = Cable Loss (dB) + Antenna Factor (dB/m)

Engineer: Roy Cheng	
Site: AC1	Time: 2014/09/01 - 13:59
Limit: FCC_Part15.209_RE(3m)	Margin: 0
Probe: BBHA9170_18-40GHz	Polarity: Horizontal
EUT: Mobile Data Terminal	Power: AC 120V/60Hz
Note: There is the ambient noise within frequency range 18GHz~25GHz.	

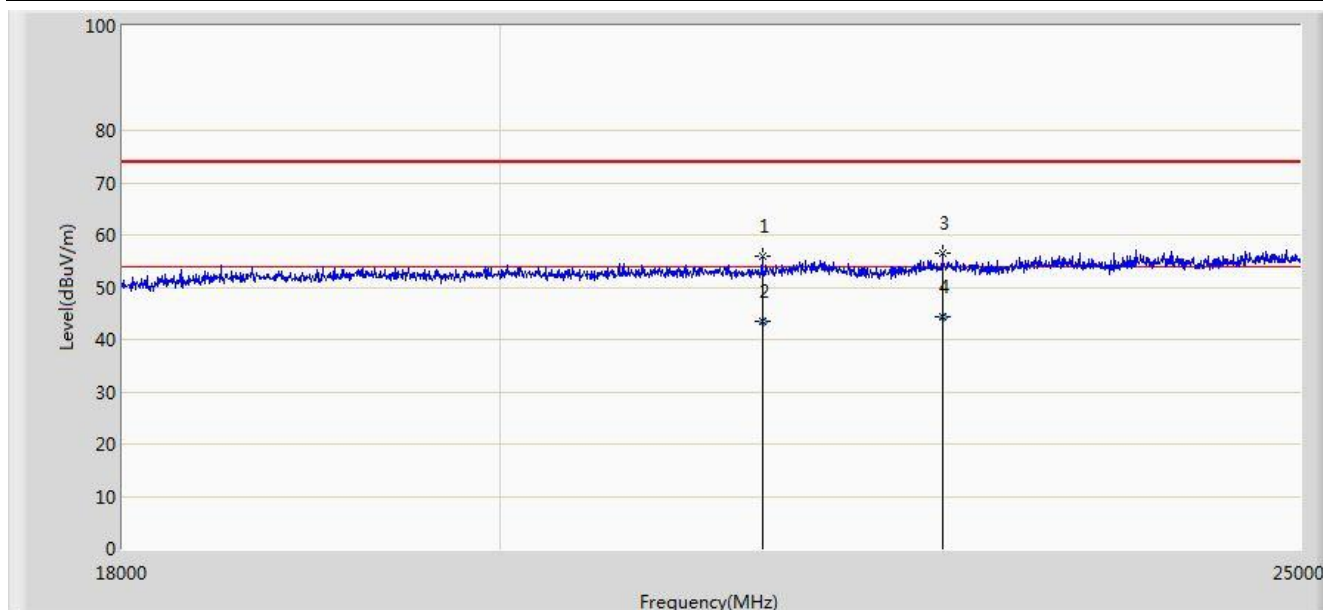

No	Flag	Mark	Frequency (MHz)	Measure Level (dBuV/m)	Reading Level (dBuV)	Over Limit (dB)	Limit (dBuV/m)	Factor (dB)	Type
1			21517.500	55.869	17.883	-18.131	74.000	37.986	PK
2			21517.650	43.351	5.365	-10.649	54.000	37.986	AV
3			22630.500	56.509	18.223	-17.491	74.000	38.286	PK
4		*	22630.540	44.310	6.024	-9.690	54.000	38.286	AV

Note: Measure Level (dB μ V/m) = Reading Level (dB μ V) + Factor (dB)

Factor (dB) = Cable Loss (dB) + Antenna Factor (dB/m)

Engineer: Roy Cheng	
Site: AC1	Time: 2014/09/01 - 14:05
Limit: FCC_Part15.209_RE(3m)	Margin: 0
Probe: BBHA9170_18-40GHz	Polarity: Vertical
EUT: Mobile Data Terminal	Power: AC 120V/60Hz
Note: There is the ambient noise within frequency range 18GHz~25GHz.	

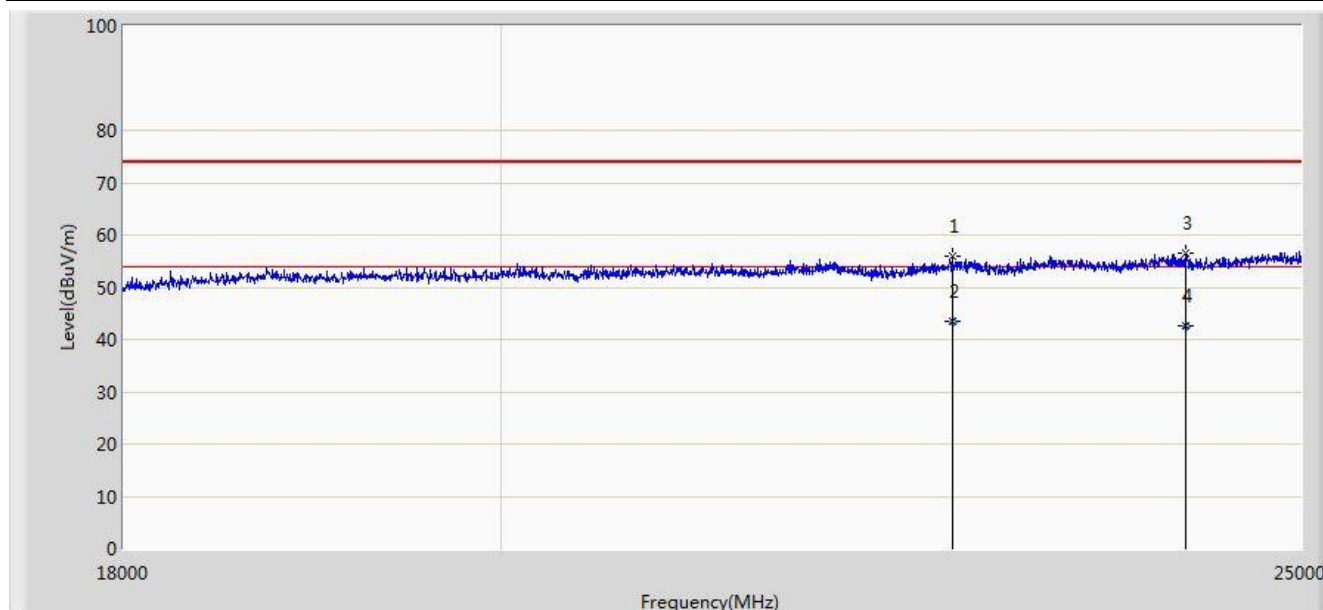

No	Flag	Mark	Frequency (MHz)	Measure Level (dBuV/m)	Reading Level (dBuV)	Over Limit (dB)	Limit (dBuV/m)	Factor (dB)	Type
1			22686.500	55.811	17.457	-18.189	74.000	38.354	PK
2			22686.540	43.598	5.244	-10.402	54.000	38.354	AV
3			24205.500	56.430	17.607	-17.570	74.000	38.823	PK
4		*	24205.658	42.518	3.695	-11.482	54.000	38.823	AV

Note: Measure Level (dBuV/m) = Reading Level (dBuV) + Factor (dB)

Factor (dB) = Cable Loss (dB) + Antenna Factor (dB/m)

7.10. Radiated Restricted Band Edge Measurement

7.10.1. Test Result

Engineer: Milo Li	
Site: AC1	Time: 2014/09/12 - 14:39
Limit: FCC_Part15.209_RE(3m)	Margin: 0
Probe: BBHA9120D_1-18GHz	Polarity: Horizontal
EUT: Mobile Data Terminal	Power: AC 120V/60Hz
Worst Case Mode: DH5 Channel 2402MHz	

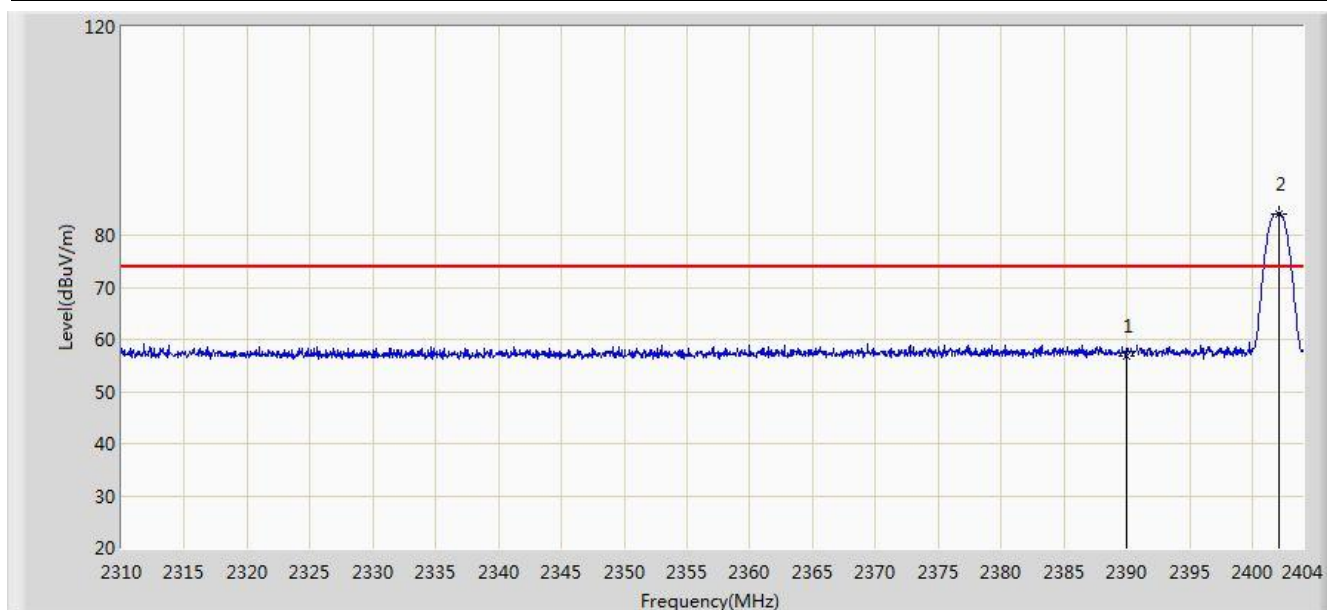

No	Flag	Mark	Frequency (MHz)	Measure Level (dBuV/m)	Reading Level (dBuV)	Over Limit (dB)	Limit (dBuV/m)	Factor (dB)	Type
1			2390.000	56.824	26.140	-17.176	74.000	30.684	PK
2		*	2402.073	84.163	53.502	N/A	N/A	30.661	PK

Note: Measure Level (dB μ V/m) = Reading Level (dB μ V) + Factor (dB)

Factor (dB) = Cable Loss (dB) + Antenna Factor (dB/m).

Engineer: Milo Li	
Site: AC1	Time: 2014/09/12 - 14:40
Limit: FCC_Part15.209_RE(3m)	Margin: 0
Probe: BBHA9120D_1-18GHz	Polarity: Horizontal
EUT: Mobile Data Terminal	Power: AC 120V/60Hz
Worst Case Mode: DH5 Channel 2402MHz	

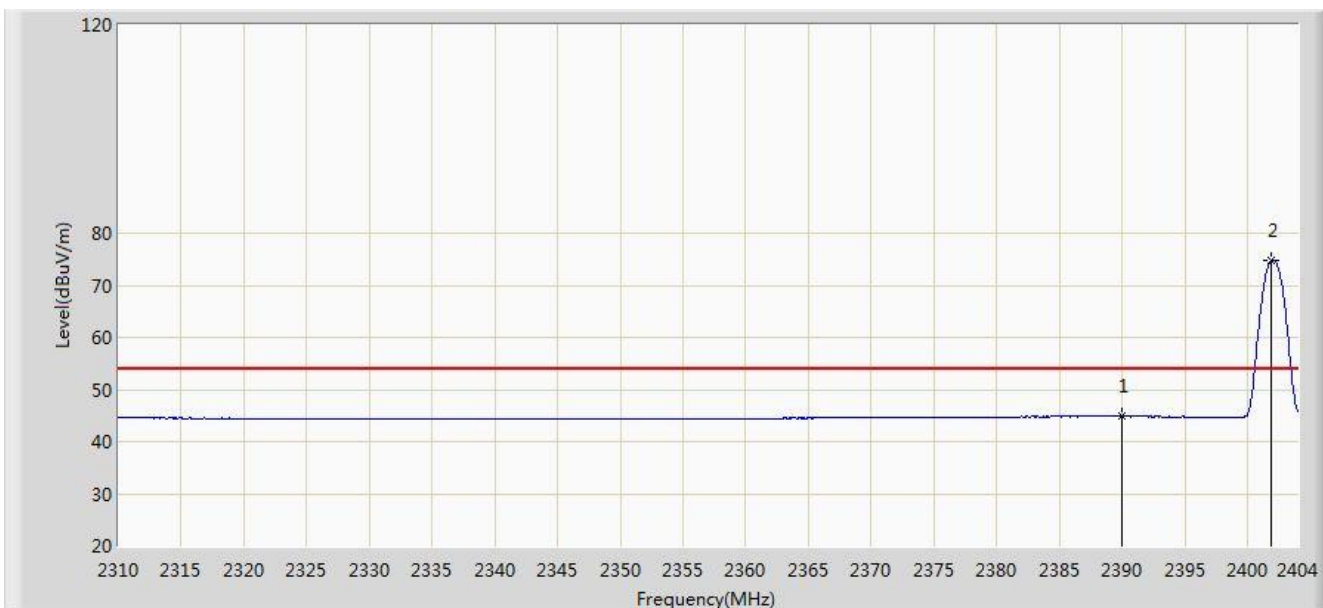

No	Flag	Mark	Frequency (MHz)	Measure Level (dBuV/m)	Reading Level (dBuV)	Over Limit (dB)	Limit (dBuV/m)	Factor (dB)	Type
1			2390.000	44.807	14.123	-9.193	54.000	30.684	AV
2		*	2401.932	74.841	44.180	N/A	N/A	30.662	AV

Note: Measure Level (dB μ V/m) = Reading Level (dB μ V) + Factor (dB)

Factor (dB) = Cable Loss (dB) + Antenna Factor (dB/m).

Engineer: Milo Li	
Site: AC1	Time: 2014/09/12 - 14:40
Limit: FCC_Part15.209_RE(3m)	Margin: 0
Probe: BBHA9120D_1-18GHz	Polarity: Vertical
EUT: Mobile Data Terminal	Power: AC 120V/60Hz
Worst Case Mode: DH5 Channel 2402MHz	

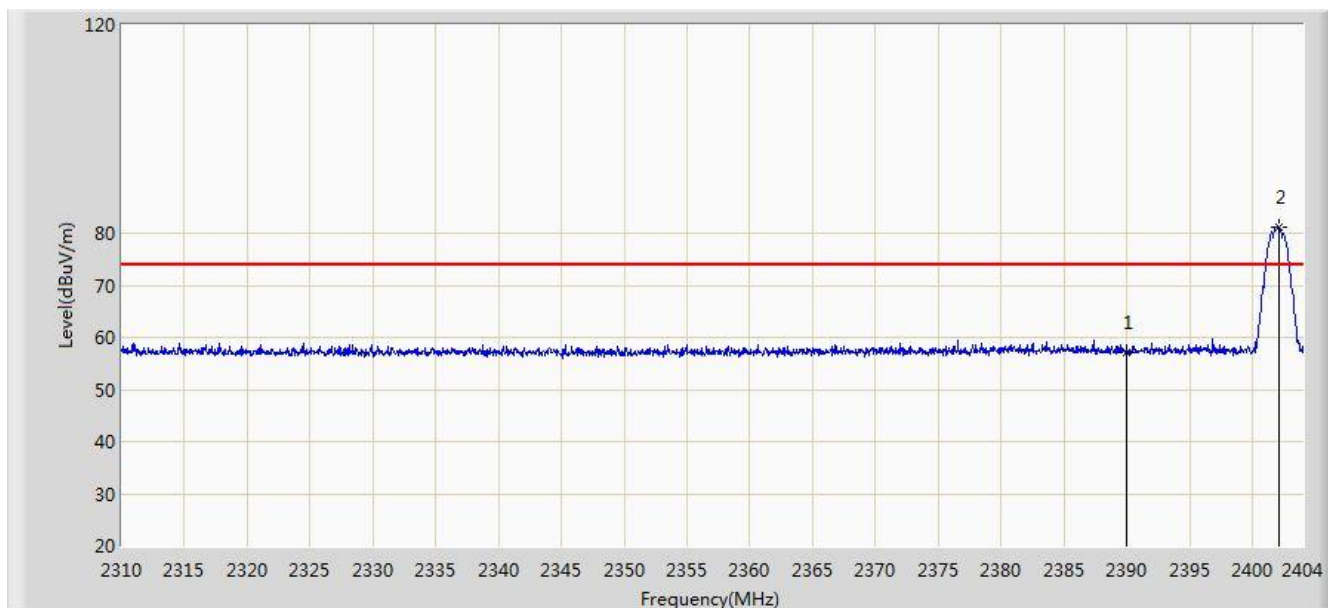

No	Flag	Mark	Frequency (MHz)	Measure Level (dBuV/m)	Reading Level (dBuV)	Over Limit (dB)	Limit (dBuV/m)	Factor (dB)	Type
1			2390.000	57.154	26.470	-16.846	74.000	30.684	PK
2		*	2402.073	81.136	50.475	N/A	N/A	30.661	PK

Note: Measure Level (dB μ V/m) = Reading Level (dB μ V) + Factor (dB)

Factor (dB) = Cable Loss (dB) + Antenna Factor (dB/m).

Engineer: Milo Li	
Site: AC1	Time: 2014/09/12 - 14:40
Limit: FCC_Part15.209_RE(3m)	Margin: 0
Probe: BBHA9120D_1-18GHz	Polarity: Vertical
EUT: Mobile Data Terminal	Power: AC 120V/60Hz
Worst Case Mode: DH5 Channel 2402MHz	

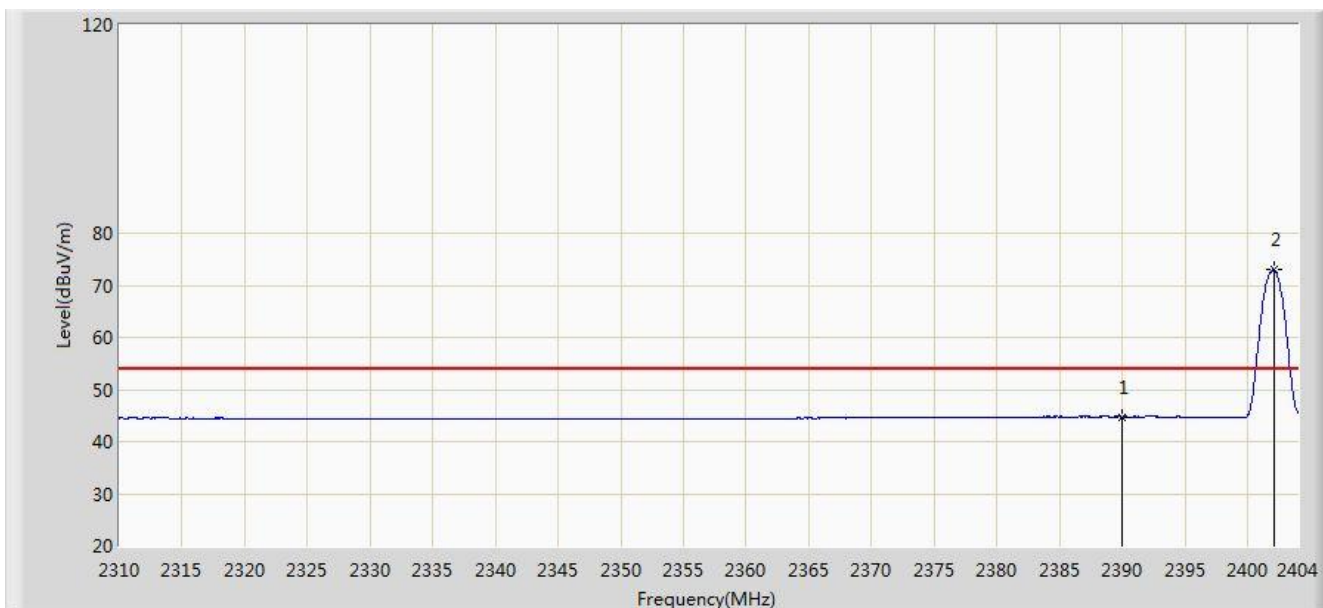

No	Flag	Mark	Frequency (MHz)	Measure Level (dBuV/m)	Reading Level (dBuV)	Over Limit (dB)	Limit (dBuV/m)	Factor (dB)	Type
1			2390.000	44.756	14.072	-9.244	54.000	30.684	AV
2		*	2402.073	72.971	42.310	N/A	N/A	30.661	AV

Note: Measure Level (dB μ V/m) = Reading Level (dB μ V) + Factor (dB)

Factor (dB) = Cable Loss (dB) + Antenna Factor (dB/m).

Engineer: Milo Li	
Site: AC1	Time: 2014/09/12 - 14:41
Limit: FCC_Part15.209_RE(3m)	Margin: 0
Probe: BBHA9120D_1-18GHz	Polarity: Horizontal
EUT: Mobile Data Terminal	Power: AC 120V/60Hz
Worst Case Mode: DH5 Channel 2480MHz	

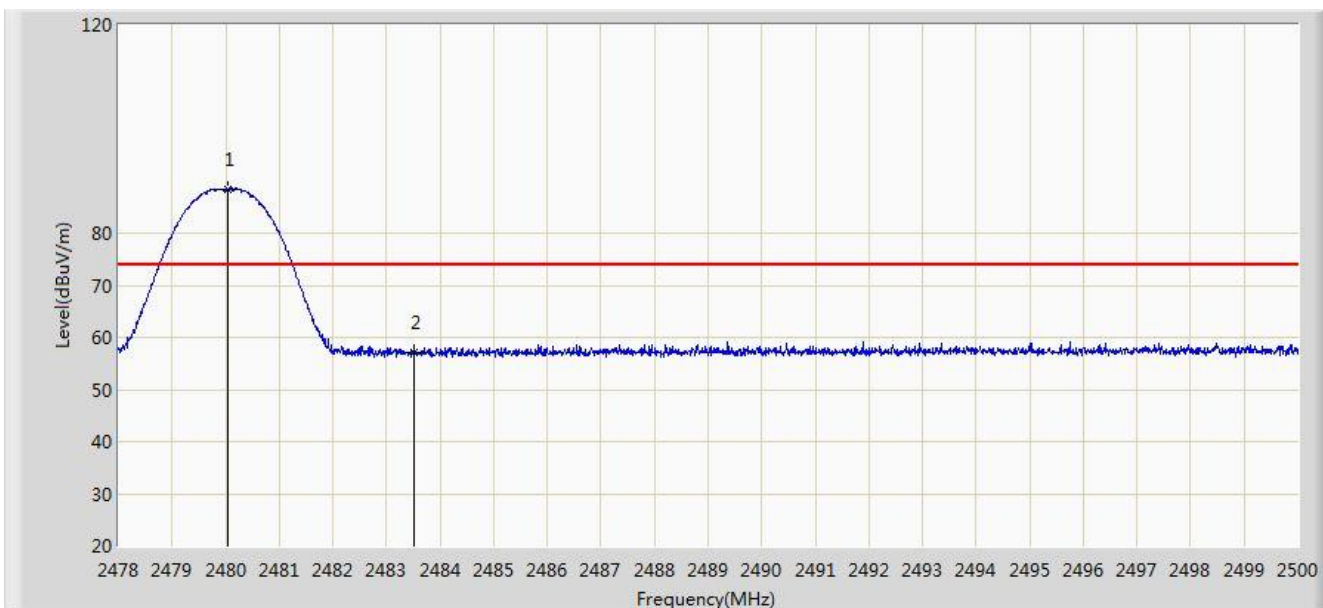

No	Flag	Mark	Frequency (MHz)	Measure Level (dBuV/m)	Reading Level (dBuV)	Over Limit (dB)	Limit (dBuV/m)	Factor (dB)	Type
1		*	2480.046	88.521	57.858	N/A	N/A	30.662	PK
2			2483.500	57.235	26.562	-16.765	74.000	30.673	PK

Note: Measure Level (dB μ V/m) = Reading Level (dB μ V) + Factor (dB)

Factor (dB) = Cable Loss (dB) + Antenna Factor (dB/m).

Engineer: Milo Li	
Site: AC1	Time: 2014/09/12 - 14:41
Limit: FCC_Part15.209_RE(3m)	Margin: 0
Probe: BBHA9120D_1-18GHz	Polarity: Horizontal
EUT: Mobile Data Terminal	Power: AC 120V/60Hz
Worst Case Mode: DH5 Channel 2480MHz	

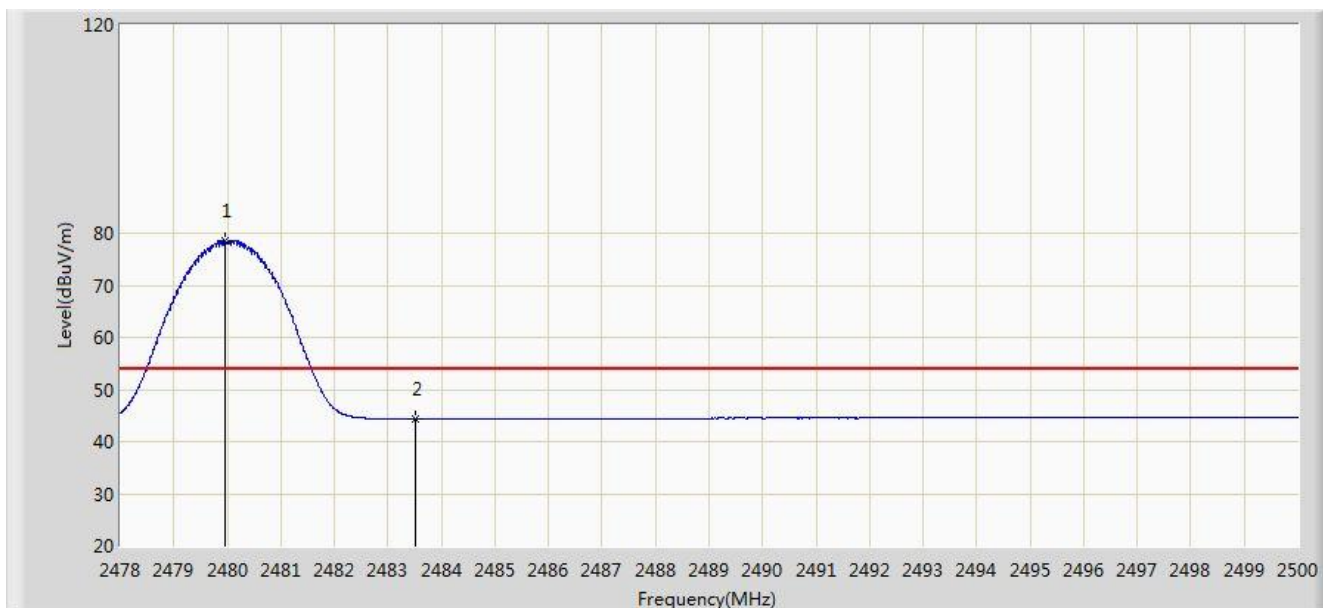

No	Flag	Mark	Frequency (MHz)	Measure Level (dBuV/m)	Reading Level (dBuV)	Over Limit (dB)	Limit (dBuV/m)	Factor (dB)	Type
1		*	2479.969	78.634	47.972	N/A	N/A	30.662	AV
2			2483.500	44.372	13.699	-9.628	54.000	30.673	AV

Note: Measure Level (dB μ V/m) = Reading Level (dB μ V) + Factor (dB)

Factor (dB) = Cable Loss (dB) + Antenna Factor (dB/m).

Engineer: Milo Li	
Site: AC1	Time: 2014/09/12 - 14:41
Limit: FCC_Part15.209_RE(3m)	Margin: 0
Probe: BBHA9120D_1-18GHz	Polarity: Vertical
EUT: Mobile Data Terminal	Power: AC 120V/60Hz
Worst Case Mode: DH5 Channel 2480MHz	

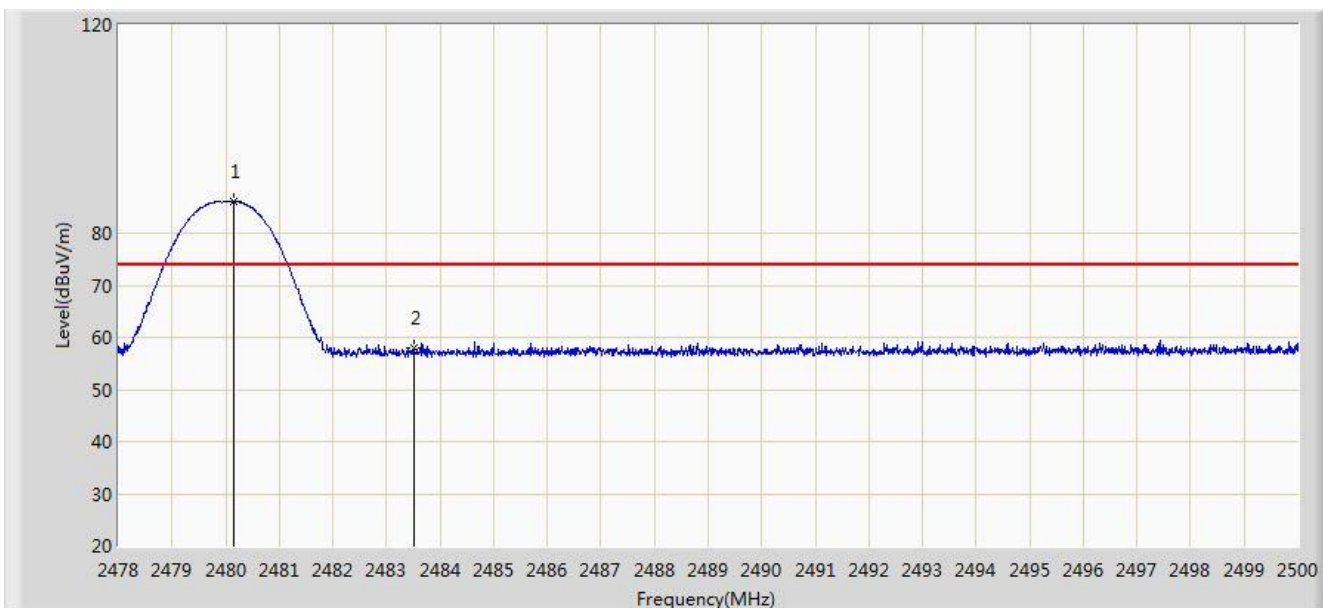

No	Flag	Mark	Frequency (MHz)	Measure Level (dBuV/m)	Reading Level (dBuV)	Over Limit (dB)	Limit (dBuV/m)	Factor (dB)	Type
1		*	2480.145	86.064	55.401	N/A	N/A	30.663	PK
2			2483.500	57.997	27.324	-16.003	74.000	30.673	PK

Note: Measure Level (dB μ V/m) = Reading Level (dB μ V) + Factor (dB)

Factor (dB) = Cable Loss (dB) + Antenna Factor (dB/m).

Engineer: Milo Li	
Site: AC1	Time: 2014/09/12 - 14:41
Limit: FCC_Part15.209_RE(3m)	Margin: 0
Probe: BBHA9120D_1-18GHz	Polarity: Vertical
EUT: Mobile Data Terminal	Power: AC 120V/60Hz
Worst Case Mode: DH5 Channel 2480MHz	

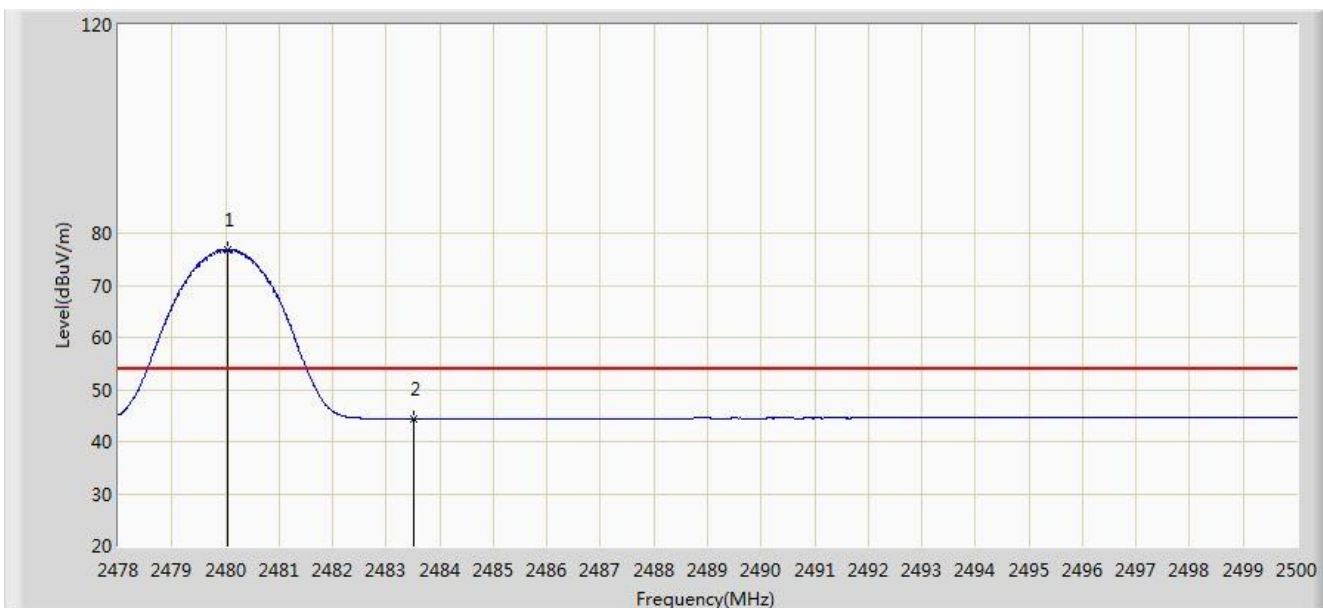

No	Flag	Mark	Frequency (MHz)	Measure Level (dBuV/m)	Reading Level (dBuV)	Over Limit (dB)	Limit (dBuV/m)	Factor (dB)	Type
1		*	2480.046	76.844	46.181	N/A	N/A	30.662	AV
2			2483.500	44.333	13.660	-9.667	54.000	30.673	AV

Note: Measure Level (dB μ V/m) = Reading Level (dB μ V) + Factor (dB)

Factor (dB) = Cable Loss (dB) + Antenna Factor (dB/m).

7.11. AC Conducted Emissions Measurement

7.11.1. Test Limit

FCC Part 15 Subpart C Paragraph 15.207 Limits		
Frequency (MHz)	QP (dB μ V)	Average (dB μ V)
0.15 - 0.50	66 - 56	56 - 46
0.50 - 5.0	56	46
5.0 - 30	60	50

Note 1: The lower limit shall apply at the transition frequencies.

Note 2: The limit decreases linearly with the logarithm of the frequency in the range 0.15MHz to 0.5MHz.

7.11.2. Test Setup

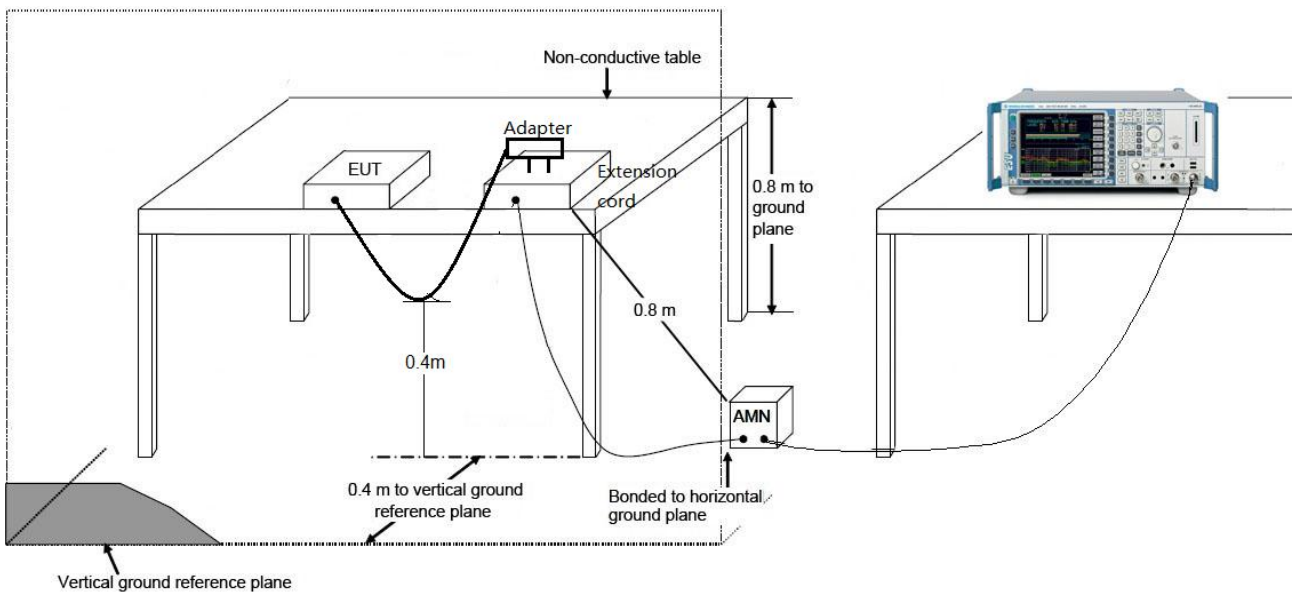

7.11.3. Test Result

Engineer: Milo Li	
Site: SR2	Time: 2014/09/13 - 14:29
Limit: FCC_Part15.207_CE_AC Power_ClassB	Margin: 0
Probe: ENV216_101683_Filter On	Polarity: Line
EUT: Mobile Data Terminal	Power: AC 120V/60Hz
Note: Mode1	

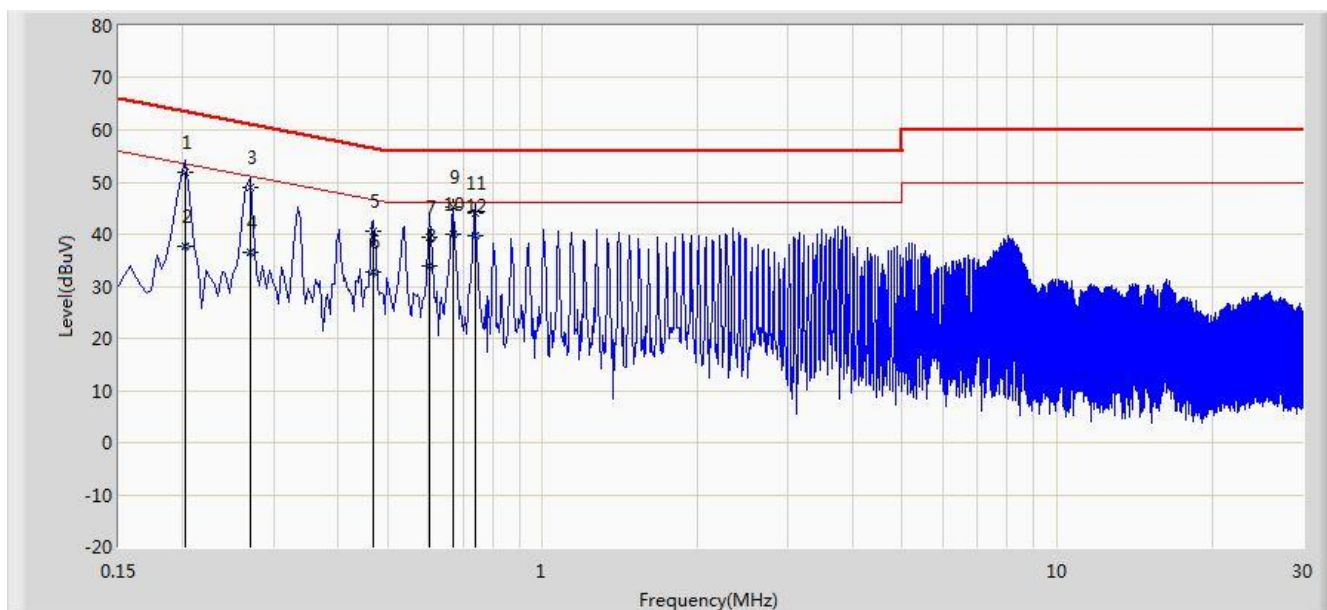

No	Flag	Mark	Frequency (MHz)	Measure Level (dBuV)	Reading Level (dBuV)	Over Limit (dB)	Limit (dBuV)	Factor (dB)	Type
1			0.202	51.972	41.979	-11.556	63.528	9.993	QP
2			0.202	37.707	27.714	-15.821	53.528	9.993	AV
3			0.270	48.958	38.978	-12.160	61.118	9.980	QP
4			0.270	36.415	26.435	-14.703	51.118	9.980	AV
5			0.470	40.640	30.498	-15.873	56.514	10.142	QP
6			0.470	32.609	22.467	-13.905	46.514	10.142	AV
7			0.602	39.470	29.356	-16.530	56.000	10.114	QP
8			0.602	33.980	23.866	-12.020	46.000	10.114	AV
9			0.670	45.188	35.109	-10.812	56.000	10.079	QP
10		*	0.670	40.045	29.966	-5.955	46.000	10.079	AV
11			0.738	44.135	34.091	-11.865	56.000	10.044	QP
12			0.738	39.829	29.785	-6.171	46.000	10.044	AV

Note: Measure Level (dBμV) = Reading Level (dBμV) + Factor (dB)

Factor (dB) = Cable Loss (dB) + LISN Factor (dB).

Engineer: Milo Li	
Site: SR2	Time: 2014/09/13 - 14:33
Limit: FCC_Part15.207_CE_AC Power_ClassB	Margin: 0
Probe: ENV216_101683_Filter On	Polarity: Neutral
EUT: Mobile Data Terminal	Power: AC 120V/60Hz
Note: Mode1	

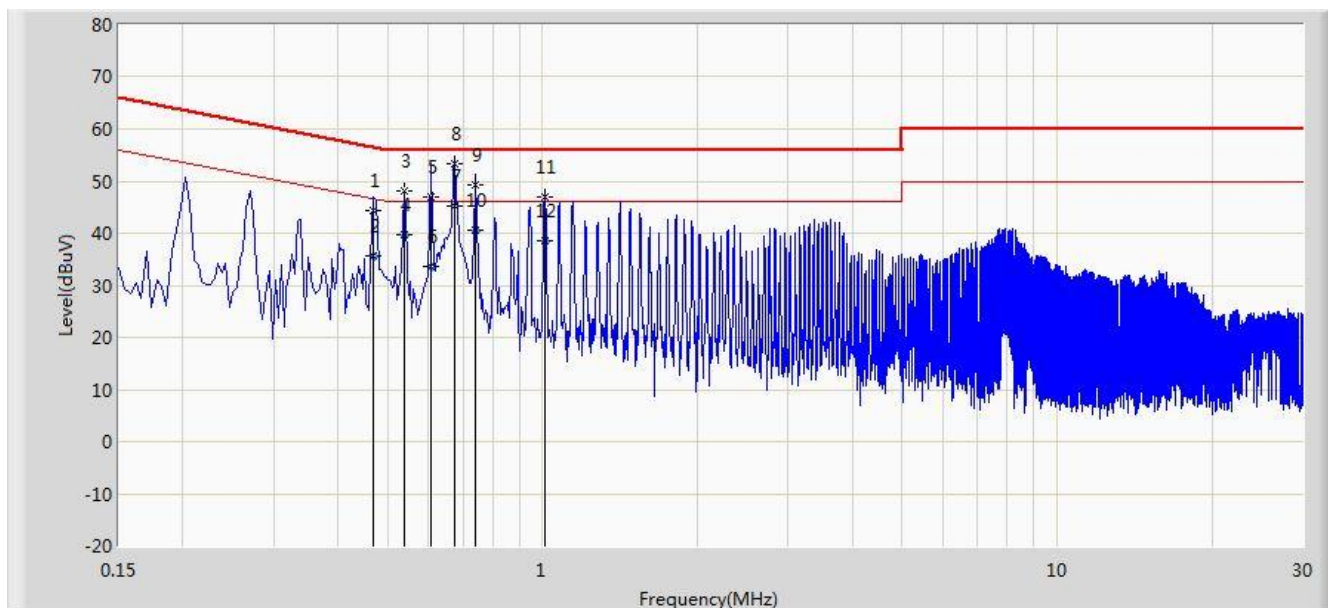

No	Flag	Mark	Frequency (MHz)	Measure Level (dBuV)	Reading Level (dBuV)	Over Limit (dB)	Limit (dBuV)	Factor (dB)	Type
1			0.470	44.224	34.060	-12.290	56.514	10.164	QP
2			0.470	35.715	25.551	-10.799	46.514	10.164	AV
3			0.538	47.981	37.816	-8.019	56.000	10.166	QP
4			0.538	39.646	29.480	-6.354	46.000	10.166	AV
5			0.606	47.058	36.930	-8.942	56.000	10.128	QP
6			0.606	33.742	23.613	-12.258	46.000	10.128	AV
7			0.674	45.190	35.100	-10.810	56.000	10.090	QP
8		*	0.674	53.290	43.200	-2.710	56.000	10.090	QP
9			0.742	49.383	39.331	-6.617	56.000	10.051	QP
10			0.742	40.540	30.489	-5.460	46.000	10.051	AV
11			1.010	46.936	37.027	-9.064	56.000	9.909	QP
12			1.010	38.593	28.685	-7.407	46.000	9.909	AV

Note: Measure Level (dBμV) = Reading Level (dBμV) + Factor (dB)

Factor (dB) = Cable Loss (dB) + LISN Factor (dB).

8. CONCLUSION

The data collected relate only the item(s) tested and show that the **Mobile Data Terminal FCC ID: 2AC6AC4000** is in compliance with Part 15C of the FCC Rules.

————— The End —————