



Shenzhen Global Test Service Co., Ltd

No.7-101 and 8A-104, Building 7 and 8, DCC Cultural and Creative Garden, No.98, Pingxin North Road, Shangmugu Community, Pinghu Street, Longgang District, Shenzhen, Guangdong

TEST REPORT

FCC 47 CFR Part 15 Subpart B

Radio Frequency Devices – Unintentional Radiators – Limits and methods of measurement

ANSI C63.4: 2014

American National Standard for Methods of Measurement of Radio-Noise Emissions from Low-Voltage Electrical and Electronic Equipment in the Range of 9 kHz to 40 GHz

Report Reference No.....: **GTS20220526009-1-1**

FCC ID.....: **2AC68-CRUISE2A**

Date of issue.....: **May.27, 2022**

Testing Laboratory Name.....: **Shenzhen Global Test Service Co.,Ltd.**

Address: **No.7-101 and 8A-104, Building 7 and 8, DCC Cultural and Creative Garden, No.98, Pingxin North Road, Shangmugu Community, Pinghu Street, Longgang District, Shenzhen, Guangdong**

Reviewed by
(Testing Engineer).....: **Peter Xiao**

Supervised by
(position+printed name+signature) : **Test Engineer
Jenny Zeng**

Approved by
(Manager).....: **Simon Hu**



Applicant's name.....: **SEUIC Technologies Co., Ltd.**

Address: **NO.15 Xinghuo Road, Nanjing New & High Technology Industry Development Zone, Nanjing, China, 210061**

Manufacturer's name: **SEUIC Technologies Co., Ltd.**

Address: **NO.15 Xinghuo Road, Nanjing New & High Technology Industry Development Zone, Nanjing, China, 210061**

Test specification:

Standard.....: **47 CFR FCC Part 15 Subpart B
ANSI C63.4: 2014**

Receiver Date.....: **Mar. 09, 2022**

Test Period.....: **Mar. 09, 2022- Mar. 30, 2022**

Test item description.....: **Portable Data Collection Terminal**

Trade Mark.....: **N/A**

Model/Type reference.....: **CRUISE2A**

Listed Models.....: **CRUISE2**

Ratings.....: **DC 3.85V by battery
Recharged by DC 9.0V**

Result.....: **PASS**

Shenzhen Global Test Service Co., Ltd. All rights reserved.

This publication may be reproduced in whole or in part for non-commercial purposes as long as the Shenzhen Global Test Service Co., Ltd. is acknowledged as copyright owner and source of the material. Shenzhen Global Test Service Co., Ltd. takes no responsibility for and will not assume liability for damages resulting from the reader's interpretation of the reproduced material due to its placement and context.

TEST REPORT

Test Report No. : GTS20220526009-1-1	May.27, 2022 Date of issue
--	-------------------------------

Equipment under Test : Portable Data Collection Terminal

Model /Type : CRUISE2A

Listed Models : CRUISE2

Applicant : **SEUIC Technologies Co., Ltd.**

Address : NO.15 Xinghuo Road, Nanjing New & High Technology Industry
Development Zone, Nanjing, China, 210061

Manufacturer : **SEUIC Technologies Co., Ltd.**

Address : NO.15 Xinghuo Road, Nanjing New & High Technology Industry
Development Zone, Nanjing, China, 210061

Test Result	Pass
--------------------	-------------

The above equipment has been tested by Shenzhen Global Test Service Co., Ltd., and found compliance with the requirements set forth in the technical standards mentioned above. The results of testing in this report apply only to the product/system, which was tested. Other similar equipment will not necessarily produce the same results due to production tolerance and measurement uncertainties.

Contents

1. TEST SUMMARY	4
2. EUT INFORMATION	5
2.1. I/O Port Description	5
2.2. EUT operation mode	5
2.3. Product Description	6
2.4. EUT configuration.....	7
3. TEST ENVIRONMENT.....	8
3.1. Address of the test laboratory	8
3.2. Test Facility	8
3.3. Test Software	8
3.4. Statement of the measurement uncertainty	8
3.5. Test Site Environmental	9
3.6. Test Instruments.....	9
4. TEST CONDITIONS AND RESULTS	10
4.1. Conducted Emission	10
4.1.1. Limits	10
4.1.2 Test Configuration	10
4.1.3 Test Procedure.....	11
4.1.4 Test Results	12
4.2. Radiated Emission	14
4.2.1 Limit.....	14
4.2.2 Test Configuration	15
4.2.3 Test Procedure.....	16
4.2.4 Test Results	18
5. TEST SETUP PHOTOS OF THE EUT.....	21
6. EXTERNAL AND INTERNAL PHOTOS OF THE EUT	23
6.1. External photos of the EUT	23
6.2. Internal photos of the EUT	28

1. TEST SUMMARY

Emission			
Standard	Item	Verdict	Remark
FCC 47 CFR PART 15 SUBPART B ANSI C63.4	Conducted Emission	PASS	Meet Class B limit
FCC 47 CFR PART 15 SUBPART B ANSI C63.4	Radiated Emission	PASS	Meet Class B limit

The test results of this report was related only to the tested sample(s) identified in this report. Manufacturer or whom it may concern should recognize the pass or fail of the test result.

2. EUT INFORMATION

2.1. I/O Port Description

I/O Port Types	Q'TY	Test Description
1). DC IN Port	1	Connect to Adapter

2.2. EUT operation mode

Pre-Test Mode	Mode 1: Work Mode Mode 2: Idle Mode		
Final Test Mode	Conducted Emission		Mode 1
	Radiates Emission	Below 1GHz	Mode 1
		Above 1GHz	N/A

Then, the above highest emission mode of the configuration of the EUT and cable was chosen for all final test items.

***Note:

1. We tested the all modes,, but we only recorded the worst case in this report.

2.3. Product Description

Product Name	Portable Data Collection Terminal
Trade Mark	N/A
Model/Type reference	CRUISE2A
List Models	CRUISE2
Model Declaration	N/A
Power supply:	DC 3.85V by battery Recharged by DC 9.0V
Working Frequency	> 108MHz

2.4.EUT configuration

The following peripheral devices and interface cables were connected during the measurement:

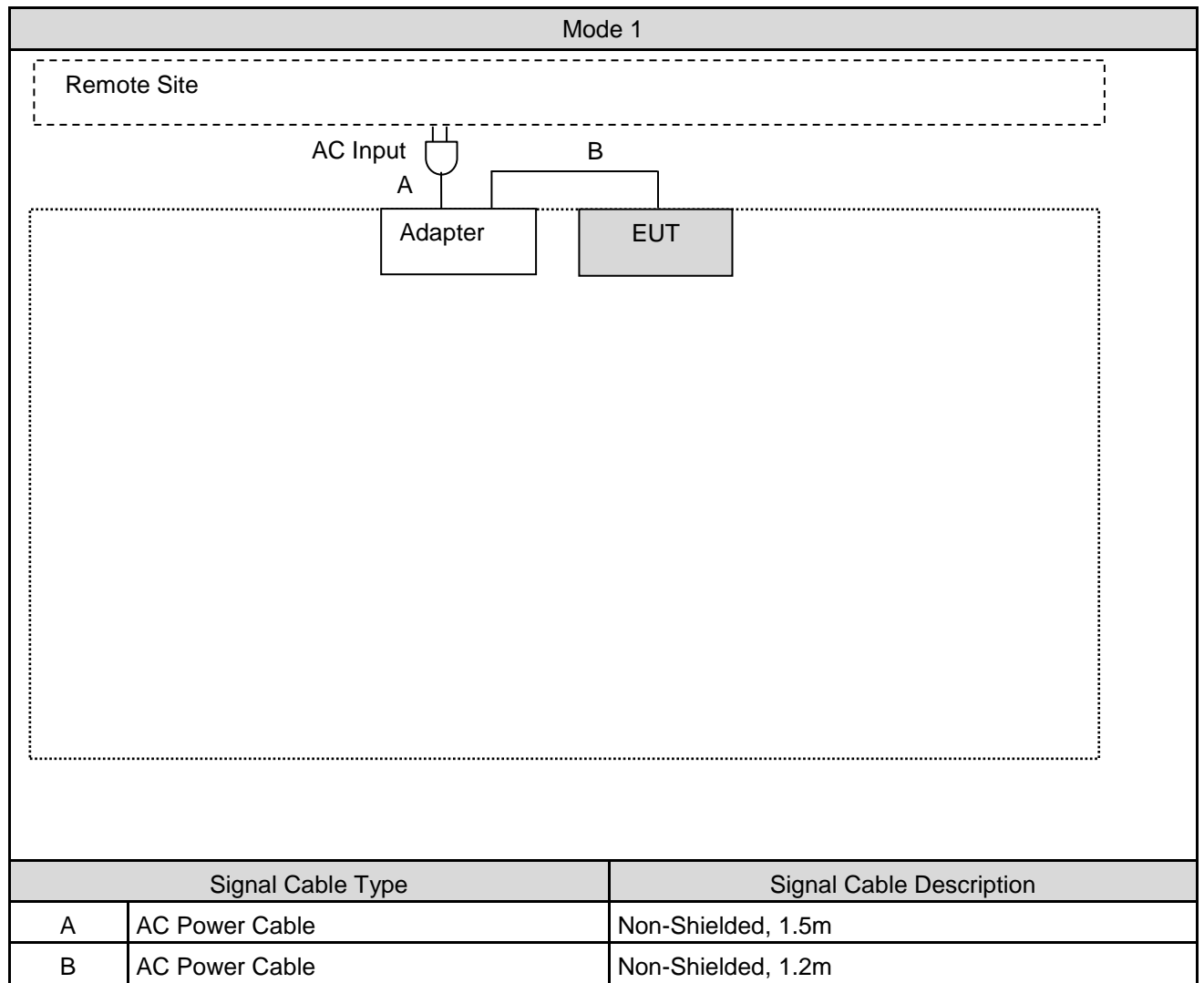

Devices Description				
Product	Manufacturer	Model Number	Serial Number	Power Cord
(1) Adapter	Shenzhen Tianyin Electronics Co., Ltd.	TPA-10R120150UU01	N/A	Non-Shielded, 1.2m

3. TEST ENVIRONMENT

3.1. Address of the test laboratory

Shenzhen Global Test Service Co., Ltd.

No.7-101 and 8A-104, Building 7 and 8, DCC Cultural and Creative Garden, No.98, Pingxin North Road, Shangmugu Community, Pinghu Street, Longgang District, Shenzhen, Guangdong

3.2. Test Facility

The test facility is recognized, certified, or accredited by the following organizations:

CNAS (No. CNAS L8169)

Shenzhen Global Test Service Co., Ltd. has been assessed and proved to be in compliance with CNAS-CL01 Accreditation Criteria for Testing and Calibration Laboratories (identical to ISO/IEC 17025: 2019 General Requirements) for the Competence of Testing and Calibration Laboratories.

A2LA (Certificate No. 4758.01)

Shenzhen Global Test Service Co., Ltd. has been assessed by the American Association for Laboratory Accreditation (A2LA). Certificate No. 4758.01.

Industry Canada Registration Number. is 24189.

FCC Designation Number is CN1234.

FCC Registered Test Site Number is165725.

3.3. Test Software

Measurement Software			
No.	Description	Software	Version
1	Conducted Emission	JS32-CE	V2.5.0.9
2	Radiated Emission _ Below 1GHz	JS32-RE	V2.5.0.9
3	Radiated Emission _ Above 1GHz	JS32-RE	V2.5.0.9

3.4. Statement of the measurement uncertainty

Test Item	Test Site	Frequency Range		Uncertainty (dB)
Conducted Emission AC Power Port	Conductive Shielding Room	9 kHz ~ 150 kHz		2.7
		150 kHz ~ 30 MHz		2.7
Radiated Emission	966	30 MHz ~ 1000 MHz	Horizontal	5.6
			Vertical	6.0
		1000 MHz ~ 40000 MHz		5.2

Note: The Vertical and Horizontal measurement uncertainty of 1GHz to 6GHz is evaluated and choose which polarity is worst value.

3.5. Test Site Environmental

Test Item	Required (IEC 60068-1)		Actual
Conducted Emission	Temperature (°C)	15-35	24
	Humidity (%RH)	25-75	56
	Barometric pressure (mbar)	860-1060	950
Radiated Emission	Temperature (°C)	15-35	23
	Humidity (%RH)	25-75	57
	Barometric pressure (mbar)	860-1060	950

3.6. Test Instruments

Test Period: Mar.11, 2021

Conducted Emission test site					
Equipment	Manufacturer	Model Number	Serial Number	Cal. Date	Cal. Period
Test Receiver	R&S	ESPI	101841	2021/07/17	1 year
Transient Limiter	CYBERTEK	EM5010A	E1950100106	2021/07/17	1 year
LISN	R&S	ESH2-Z5	893606/008	2021/07/17	1 year
LISN	CYBERTEK	EM5040A	E1850400105	2021/07/17	1 year
ISN	SCHWARZBECK	CAT 3	066	2021/09/19	1 year
ISN	SCHWARZBECK	CAT 5	121	2021/09/19	1 year
ISN	SCHWARZBECK	NTFM	102	2021/09/19	1 year
Test Site	XINJU	Conductive Shielding Room	N/A	N.C.R.	-----

Test Period: Mar.12, 2021

966 Chamber					
Equipment	Manufacturer	Model Number	Serial Number	Cal. Date	Cal. Period
Amplifier	SCHWARZBECK MESS-ELEKTRONIK	BBV 9743	202	2021/07/17	1 year
Amplifier	EMCI	EMC051845SE	980355	2021/07/17	1 year
Amplifier	ETS	3116C-PA	/	2021/07/17	
Test Receiver	R&S	ESCI 7	101102	2021/09/19	1 year
Spectrum Analyzer	R&S	FSV40-N	101800	2021/09/19	1 year
Broadband Antenna	SCHWARZBECK MESS-ELEKTRONIK	VULB 9163	00976	2021/07/17	1 year
Double Ridged Horn Antenna (1~18GHz)	SCHWARZBECK MESS-ELEKTRONIK	BBHA 9120D	01622	2021/11/17	1 year
Horn Antenna (18GHz~40GHz)	ETS	3116C	00086467	2021/11/17	1 year
Test Site	XINJU	966	N/A	2021/09/19	3 year

4. TEST CONDITIONS AND RESULTS

4.1. Conducted Emission

4.1.1. Limits

Frequency (MHz)	Class A (dBuV)		Class B (dBuV)	
	Quasi-peak	Average	Quasi-peak	Average
0.15 - 0.5	79	66	66 - 56	56 - 46
0.50 - 5.0	73	60	56	46
5.0 - 30.0	73	60	60	50

Note: (1) The lower limit shall apply at the transition frequencies.

(2) The limit decreases in line with the logarithm of the frequency in the range 0.15 to 0.50 MHz.

4.1.2 Test Configuration

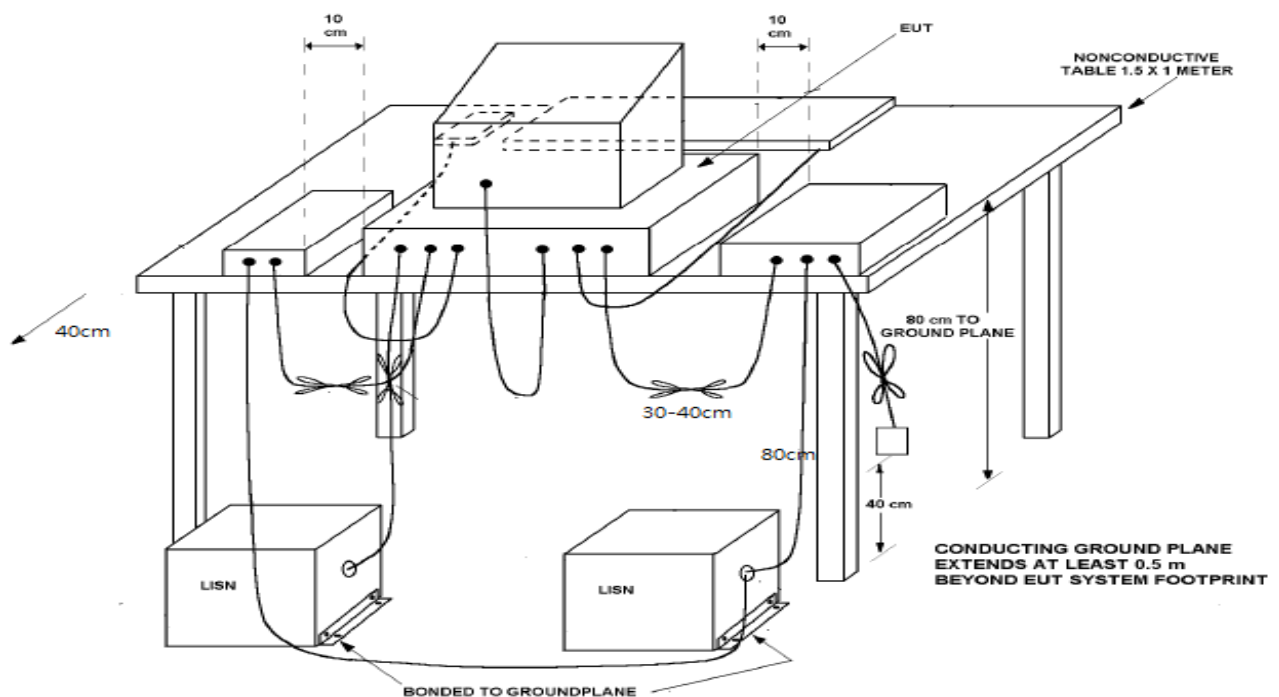
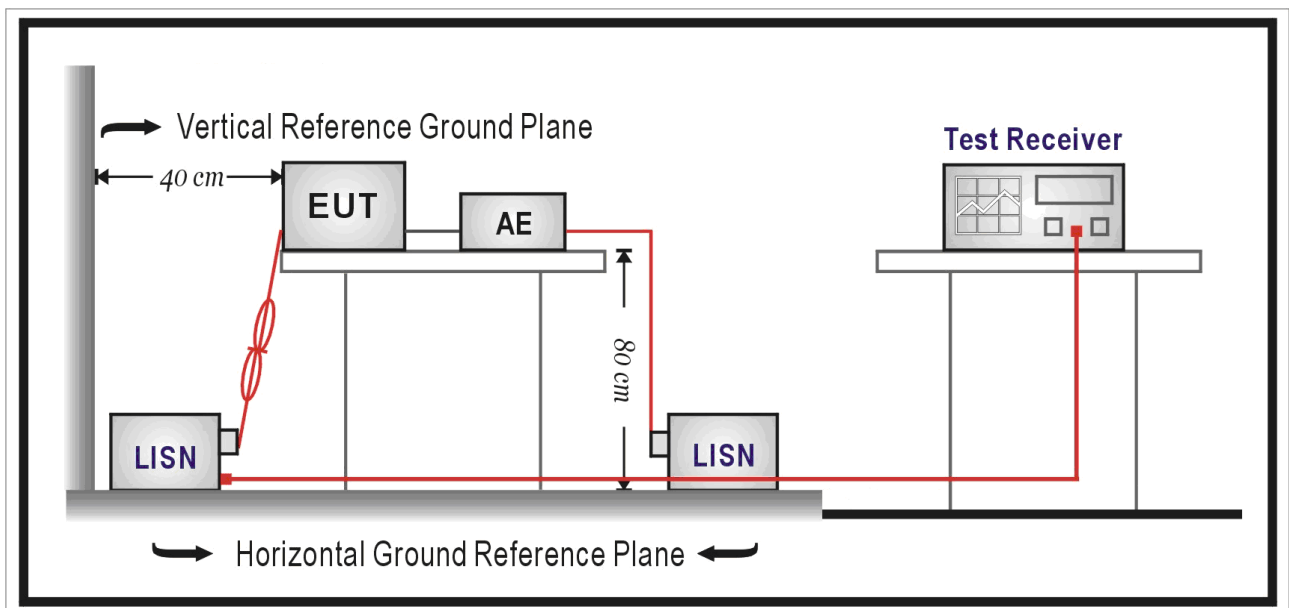

4.1.3 Test Procedure

The EUT and simulators are connected to the main power through a line impedance stabilization network (L.I.S.N.). This provides a 50 Ω // 50 μ H coupling impedance for the measuring equipment. The peripheral devices are also connected to the main power through a LISN that provides a 50 Ω // 50 μ H coupling impedance with 50 ohm termination.

Tabletop device shall be placed on a non-conducting platform, of nominal size 1 m by 1.5 m, raised 80 cm above the reference ground plane. The wall of screened room shall be located 40 cm to the rear of the EUT. Other surfaces of tabletop or floor standing EUT shall be at least 80 cm from any other ground conducting surface including one or more LISNs. For floor-standing device shall be placed under the EUT with a 12 mm insulating material.

Conducted emissions were investigated over the frequency range from 0.15 MHz to 30 MHz using a resolution bandwidth of 9 kHz. The equipment under test (EUT) shall be meet the limits in section 4.1.1, as applicable, including the average limit and the quasi-peak limit when using respectively, an average detector and quasi-peak detector measured in accordance with the methods described of related standard. When all of peak value were complied with quasi-peak and average limit from 150 kHz to 30 MHz then quasi-peak and average measurement was unnecessary.

The AMN shall be placed 0,8 m from the boundary of the unit under test and bonded to a ground reference plane for AMNs mounted on top of the ground reference plane. This distance is between the closest points of the AMN and the EUT. All other units of the EUT and associated equipment shall be at least 0,8 m from the AMN. If the mains power cable is longer than 1 m then the cable shall be folded back and forth at the center of the lead to form a bundle no longer than 0.4 m. All of interconnecting cables that hang closer than 40 cm to the ground plane shall be folded back and forth in the center forming a bundle 30 cm to 40 cm long. All of EUT and AE shall be separate place more than 0.1 m. All 50 Ω ports of the LISN shall be resistively terminated into 50 Ω loads when not connected to the measuring instrument.

If the reading of the measuring receiver shows fluctuations close to the limit, the reading shall be observed for at least 15 s at each measurement frequency; the higher reading shall be recorded with the exception of any brief isolated high reading which shall be ignored.

4.1.4 Test Results

Test Standard:	FCC Part 15B	Power Line:	L
Test Mode:	Mode 1	Test Power:	AC 120 V/60 Hz
Model:	CRUISE2A		

Test Graph

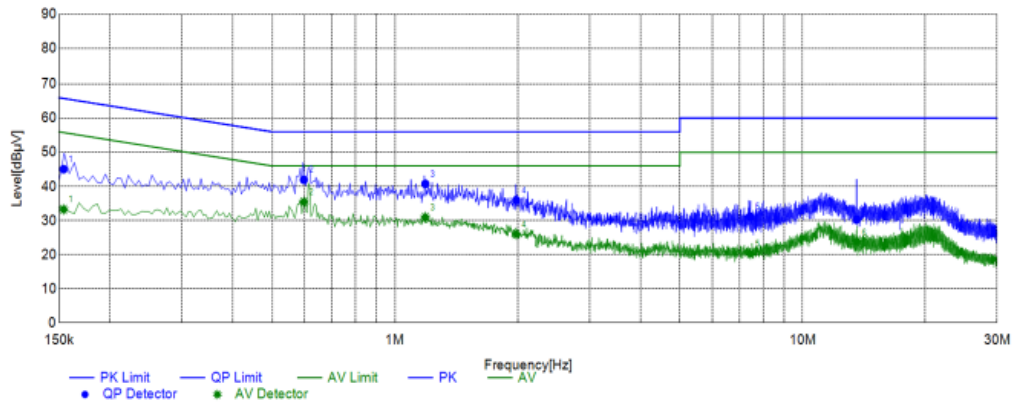

Final Data List

NO.	Frequency [MHz]	QP Reading [dBµV]	AVG. Reading [dBµV]	Factor [dB]	QP Result [dBµV]	AVG. Result [dBµV]	QP Limit [dBµV]	AVG. Limit [dBµV]	QP Margin [dB]	AVG. Margin [dB]	Line	Remark
1	0.1539	35.45	23.66	9.60	45.05	33.26	65.79	55.79	20.74	22.53	L1	PASS
2	0.5978	32.24	25.74	9.70	41.94	35.44	56.00	46.00	14.06	10.56	L1	PASS
3	1.1874	31.37	21.56	9.40	40.77	30.96	56.00	46.00	15.23	15.04	L1	PASS
4	1.9844	26.64	16.66	9.35	35.99	26.01	56.00	46.00	20.01	19.99	L1	PASS
5	7.4457	21.86	10.95	9.28	31.14	20.23	60.00	50.00	28.86	29.77	L1	PASS
6	13.5604	21.14	14.48	9.17	30.31	23.65	60.00	50.00	29.69	26.35	L1	PASS

Note: 1. Result (dBµV) = Reading (dBµV) + Factor (dB).

2. Factor (dB) = Cable loss (dB) + LISN Factor (dB).

Test Standard:	FCC Part 15B	Power Line:	N
Test Mode:	Mode 1	Test Power:	AC 120 V/60 Hz
Model:	CRUISE2A		

Test Graph

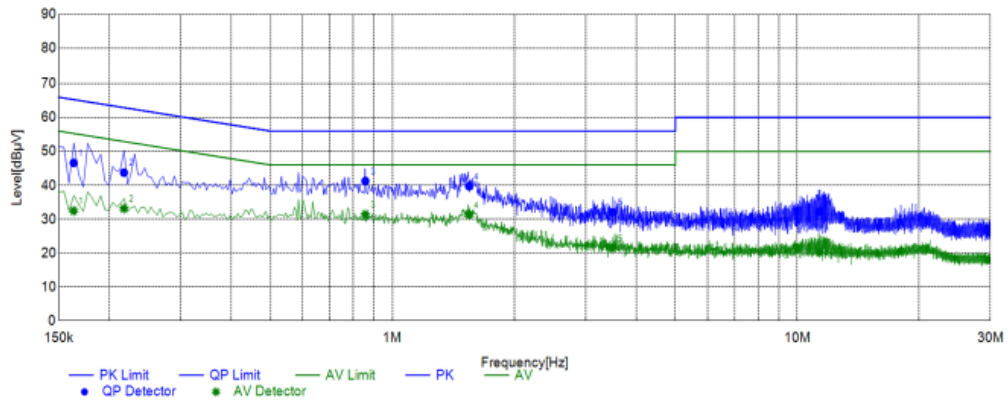

Final Data List

NO.	Frequency [MHz]	QP Reading [dBµV]	AVG. Reading [dBµV]	Factor [dB]	QP Result [dBµV]	AVG. Result [dBµV]	QP Limit [dBµV]	AVG. Limit [dBµV]	QP Margin [dB]	AVG. Margin [dB]	Line	Remark
1	0.1633	37.01	22.85	9.60	46.61	32.45	65.29	55.29	18.68	22.84	N	PASS
2	0.2174	34.17	23.56	9.57	43.74	33.13	62.92	52.92	19.18	19.79	N	PASS
3	0.8578	31.88	21.99	9.37	41.25	31.36	56.00	46.00	14.75	14.64	N	PASS
4	1.5467	30.37	21.85	9.36	39.73	31.21	56.00	46.00	16.27	14.79	N	PASS
5	3.5066	22.68	12.13	9.36	32.04	21.49	56.00	46.00	23.96	24.51	N	PASS
6	11.3448	22.98	10.95	9.25	32.23	20.20	60.00	50.00	27.77	29.80	N	PASS

Note: 1. Result (dBµV) = Reading (dBµV) + Factor (dB).
 2. Factor (dB) = Cable loss (dB) + LISN Factor (dB).

4.2. Radiated Emission

4.2.1 Limit

■ Below 1 GHz test shall not exceed following value

FCC 47 CFR PART 15 SUBPART B				
Frequency range (MHz)	Class A		Class B	
	Distance (m)	dBuV/m	Distance (m)	dBuV/m
30 to 88	10	39	3	40
88 to 216	10	43.5	3	43.5
216 to 960	10	46.4	3	46
Above 960	10	49.5	3	54

■ Above 1 GHz test shall not exceed following value

Frequency (MHz)	dBuV/m (Distance 3m)			
	Class A		Class B	
	Average	Peak	Average	Peak
1000 ~ 40000	60	80	54	74

- Remark:
1. The tighter limit shall apply at the edge between two frequency bands.
 2. Distance refers to the distance in meters between the measuring instrument antenna and the closed point of any part of the device or system.
 3. RF Voltage (dBuV/m) = 20 log RF Voltage (uV/m)
 4. Peak detector limit is corresponding to 20 dB above the maximum permitted average limit.

According to FCC Part 15.33 (b), for an unintentional radiator, including a digital device, the spectrum shall be investigated from the lowest radio frequency signal generated or used in the device, without going below the lowest frequency for which a radiated emission limit is specified, up to the frequency shown in the following table:

Highest frequency generated or used in the device or in which the device operated or tunes (MHz)	Upper frequency of measurement range (MHz)
Below 1.75	30
1.75-108	1000
108-500	2000
500-1000	5000
Above 1000	5th harmonic of the highest frequency or 40 GHz, whichever is lower

4.2.2 Test Configuration

■ Below 1GHz

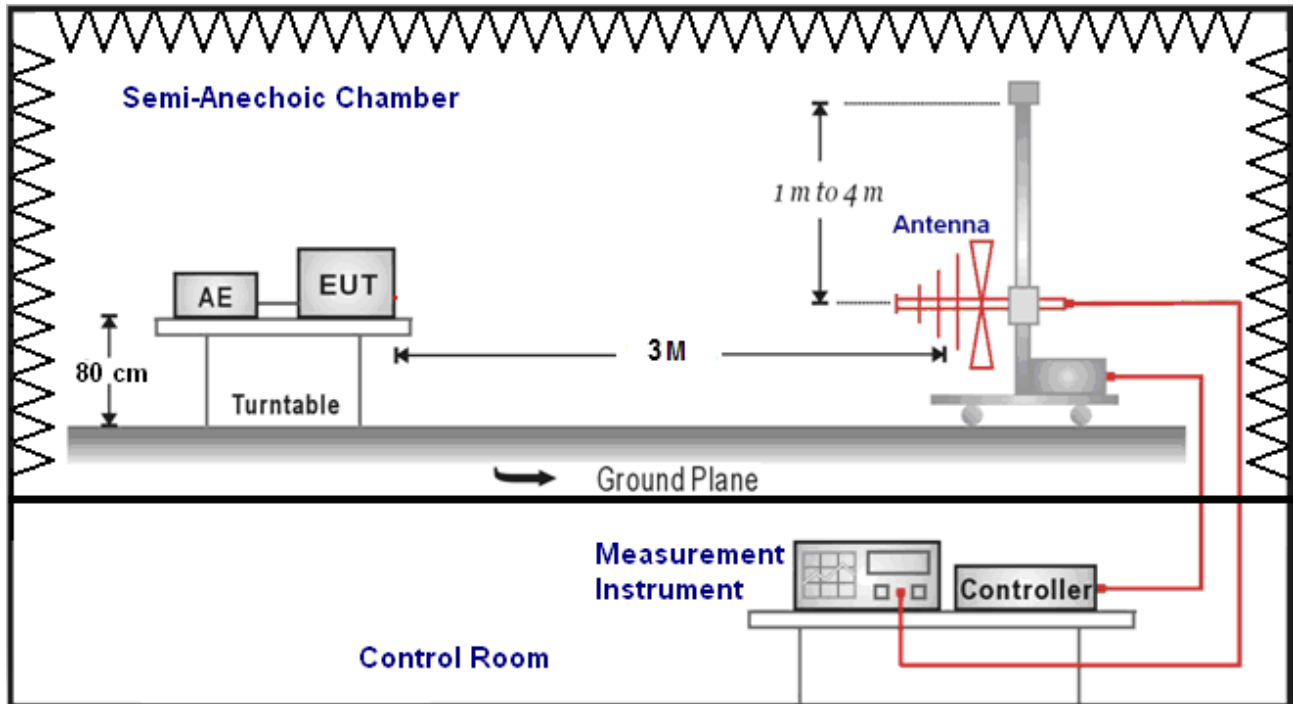

■ Above 1GHz

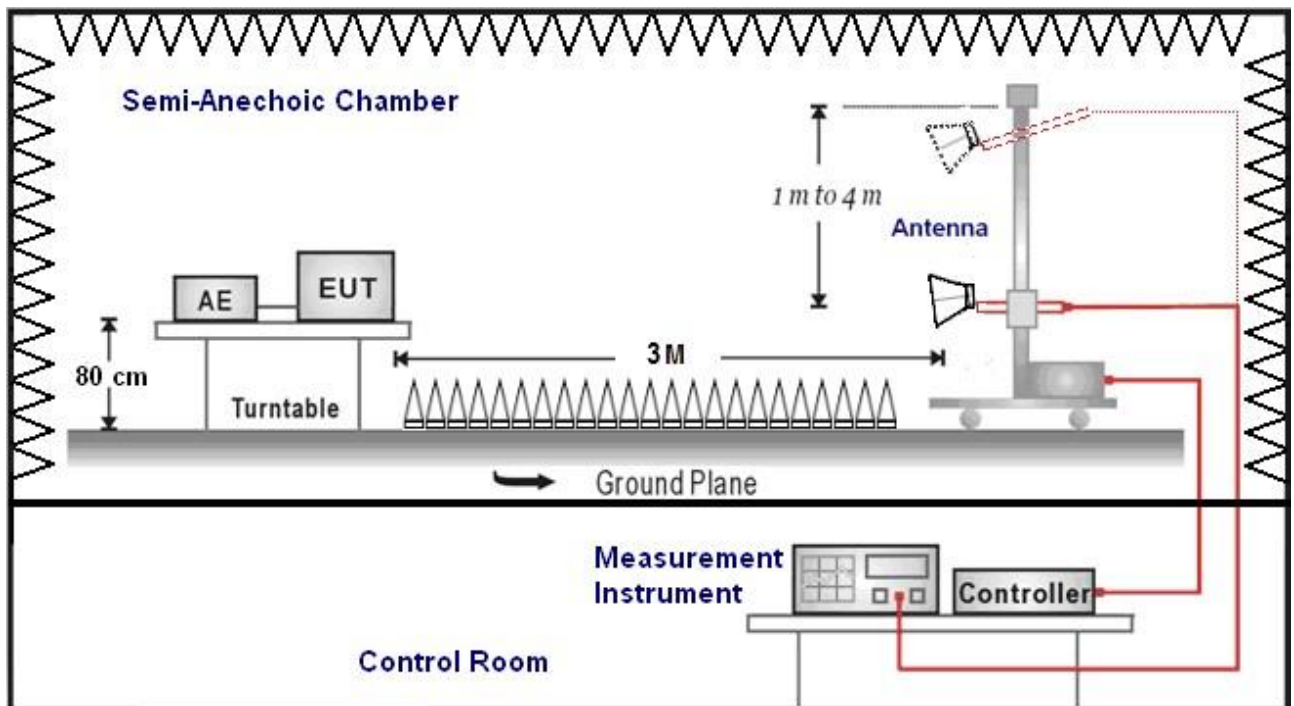

Test arrangement for radiated emissions of tabletop equipment.

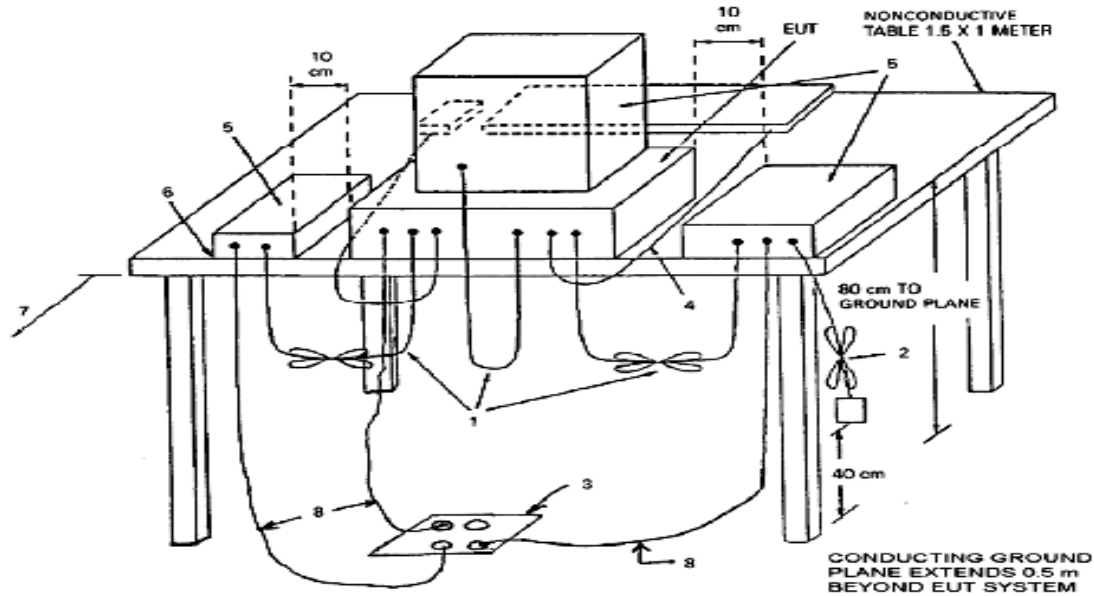

4.2.3 Test Procedure

■ Below 1 GHz

The EUT and its simulators are placed on a turn table which is 0.8 meter above ground. When the EUT is floor-standing equipment, it is placed on the ground plane which has a 12 mm non-conductive covering to insulate the EUT from the ground plane.

The turn table is 0.8 m height and 2.0 m wide x 1.0 m deep size. It can rotate 360 degrees to determine the position of the maximum emission level. The spacing between the each equipment was 10 cm. The mains cables are dropped to floor and are round to receptacle. Interconnecting cables of table top equipment that hang closer than 0.4 m to the ground plane are folded back and forth forming a bundle 0.3 m to 0.4 m long, hanging approximately in the middle between ground plane and table. The EUT was positioned such that the distance from antenna to the EUT was 10 meters and the receive antenna was moved from 1m to 4m to investigate maximum highest emission at least 6 points over the frequency range from 30 MHz to 1 GHz using a resolution bandwidth of 120 kHz and measured by the quasi-peak detector.

According to this standard paragraph 15.109, as an alternative to the radiated emission limits, digital devices may be shown to comply with the standards contained in Third Edition of the International Special Committee on Radio Interference (CISPR), Pub. 22, "Information Technology Equipment - Radio Disturbance Characteristics - Limits and Methods of Measurement".

■ Above 1 GHz

The Setup is same as Below 1 GHz placement. The turn table is 0.8 m height and 1.8 m wide x 1.0 m deep size.

The turn table can rotate 360 degrees to determine the position of the maximum emission level. The EUT was positioned such that the distance from antenna to the EUT was 3 meter for above 1 GHz, the highest frequency performed according to internal source frequency of the EUT, the specification was below:

Highest frequency generated or used in the device or on which the device operates or tunes (MHz)	Upper frequency of measurement range (MHz)
Below 1.705	30
1.705 - 108	1000
108 - 500	2000
500 - 1000	5000
Above 1000	5th harmonic of the highest frequency or 40 GHz, whichever is lower

Absorber shall be spread between floor of a turn table and a receive antenna shown in 4.2.3. The antenna used boresight antenna master from 1 meter and 4 meters to find out the maximum emission level and find the highest emission at least 6 points. Both horizontal and vertical polarization of the antenna are set on measurement. In order to find the maximum emission, all of the interface cables must be manipulated on radiated measurement.

Radiated emissions were applied to above 1 GHz using a resolution bandwidth of 1 MHz and measured by the peak and average detector which antenna to the EUT distance was 3 meters. If the EUT was meet both limits and measurement with the average detector receiver is unnecessary.

4.2.4 Test Results

Test Standard:	FCC Part 15B	Test Distance:	3 m
Test Mode:	Mode 1	Test Power:	AC 120 V/60 Hz
Measurement Range:	30 MHz~1 GHz	Ant.Polar.:	Horizontal
Model:	CRUISE2A		

Test Graph

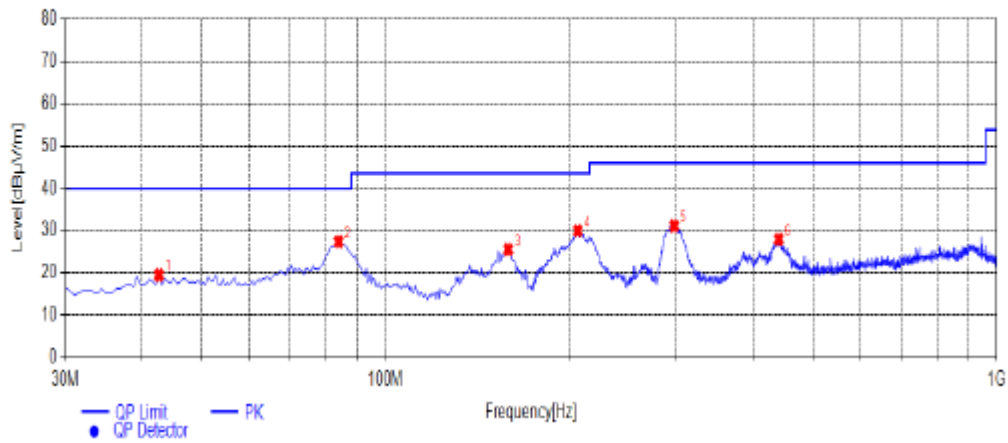

Suspected List											
NO.	Frequency [MHz]	Reading [dBµV/m]	Factor [dB]	Result [dBµV/m]	Limit [dBµV/m]	Margin [dB]	Height [cm]	Angle [°]	Detector	Polarity	Remark
1	42.6100	26.46	-6.99	19.47	40.00	20.53	100	194	PK	Horizontal	PASS
2	83.8350	39.13	-11.78	27.35	40.00	12.65	100	4	PK	Horizontal	PASS
3	159.0100	37.18	-11.63	25.55	43.50	17.95	100	70	PK	Horizontal	PASS
4	206.5400	38.97	-9.01	29.96	43.50	13.54	100	104	PK	Horizontal	PASS
5	297.2350	38.59	-7.48	31.11	46.00	14.89	100	94	PK	Horizontal	PASS
6	440.3100	32.07	-4.12	27.95	46.00	18.05	100	284	PK	Horizontal	PASS

Note:1. Result (dBµV/m) = Reading(dBµV/m) + Factor (dB) .

2. Factor (dB) = Antenna Factor (dB/m) + Cable loss (dB) - Pre Amplifier gain (dB).

Test Standard:	FCC Part 15B	Test Distance:	3 m
Test Mode:	Mode 1	Test Power:	AC 120 V/60 Hz
Measurement Range:	30 MHz~1 GHz	Ant.Polar.:	Vertical
Model:	CRUISE2A		

Test Graph

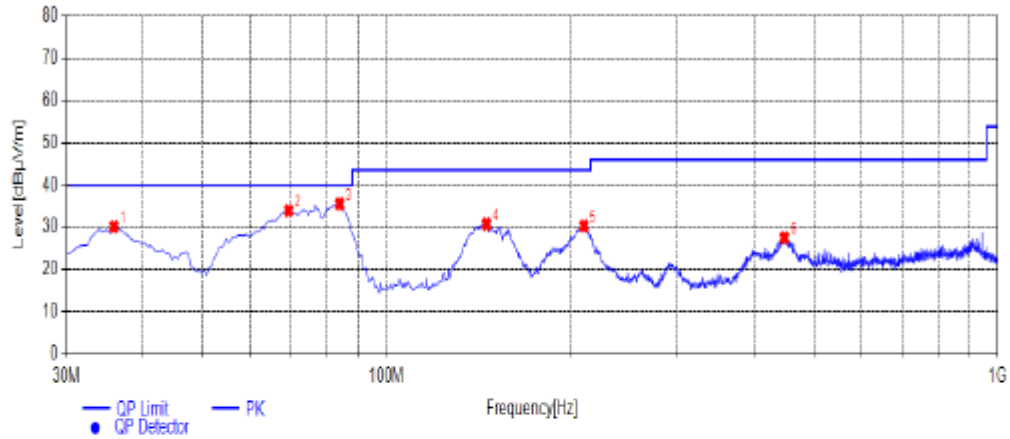

Suspected List												
NO.	Frequency [MHz]	Reading [dBµV/m]	Factor [dB]	Result [dBµV/m]	Limit [dBµV/m]	Margin [dB]	Height [cm]	Angle [°]	Detector	Polarity	Remark	
1	35.8200	39.84	-9.68	30.16	40.00	9.84	100	14	PK	Vertical	PASS	
2	69.2850	44.05	-10.06	33.99	40.00	6.01	100	11	PK	Vertical	PASS	
3	83.8350	47.34	-11.78	35.56	40.00	4.44	100	247	PK	Vertical	PASS	
4	145.9150	43.19	-12.43	30.76	43.50	12.74	100	62	PK	Vertical	PASS	
5	210.4200	39.56	-9.23	30.33	43.50	13.17	100	98	PK	Vertical	PASS	
6	448.0700	32.02	-4.53	27.49	46.00	18.51	100	347	PK	Vertical	PASS	

Note:1. Result (dBµV/m) = Reading(dBµV/m) + Factor (dB) .

2. Factor (dB) = Antenna Factor (dB/m) + Cable loss (dB) - Pre Amplifier gain (dB).

Test Mode: Mode 1 (above 1GHz)	Test Distance: 3m
Test voltage: AC 120 V/60 Hz	Test Results: Passed
Detector Function: Peak+AV	

Frequency MHz	Emission Level dB μ V/m		Limits dB μ V/m		Margin dB μ V/m		Polarization
	Peak	AV	Peak	AV	Peak	AV	
2539.54	40.11	24.95	74.00	54.00	-33.89	-29.05	H
5788.85	45.29	29.91	74.00	54.00	-28.71	-24.09	H
11452.75	50.08	34.72	74.00	54.00	-23.92	-19.28	H
15553.86	54.88	40.01	74.00	54.00	-19.12	-13.99	H
22897.35	60.08	43.15	74.00	54.00	-13.92	-10.85	H
29776.05	65.01	44.99	74.00	54.00	-8.99	-9.01	H
2540.05	39.95	25.15	74.00	54.00	-34.05	-28.85	V
5790.23	45.10	29.91	74.00	54.00	-28.90	-24.09	V
9998.50	49.97	34.91	74.00	54.00	-24.03	-19.09	V
15554.19	55.22	40.06	74.00	54.00	-18.78	-13.94	V
19998.39	60.07	42.94	74.00	54.00	-13.93	-11.06	V
29776.50	65.15	45.10	74.00	54.00	-8.85	-8.90	V

5. TEST SETUP PHOTOS OF THE EUT

Radiated Emission

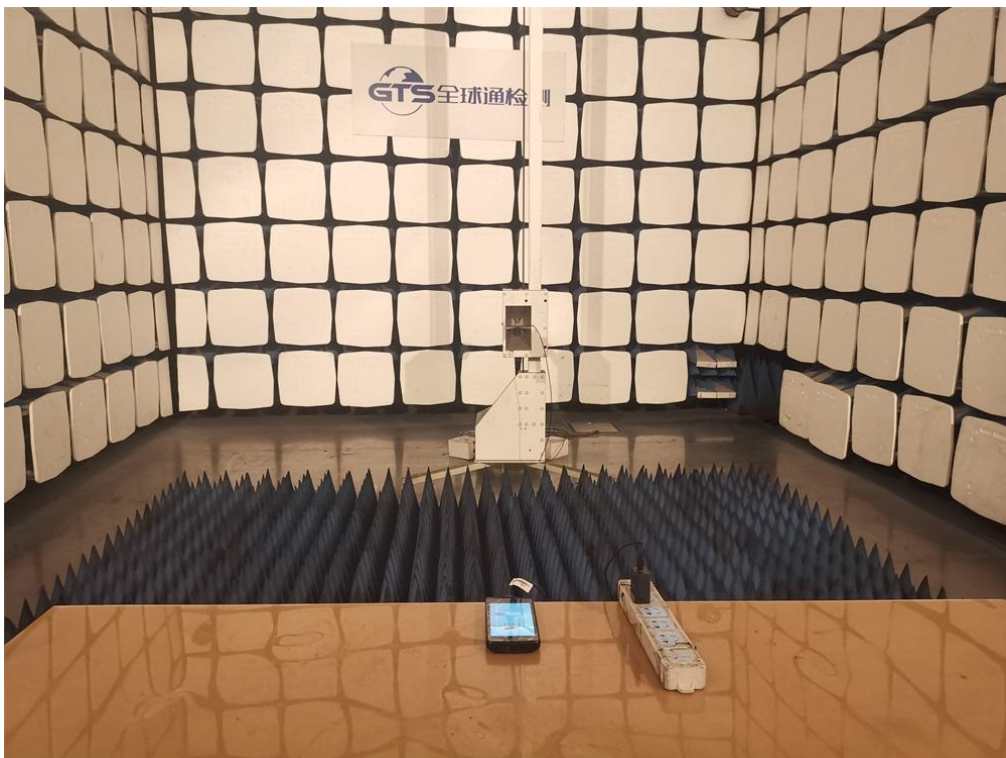
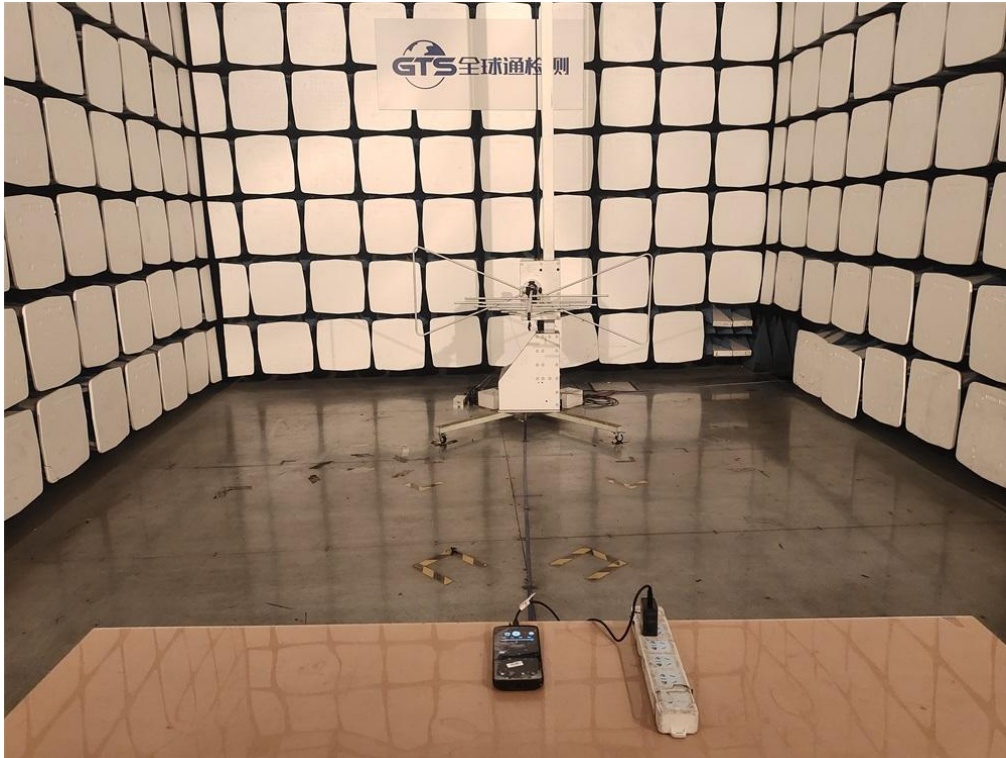

Conducted Emission



6. EXTERNAL AND INTERNAL PHOTOS OF THE EUT

6.1. External photos of the EUT

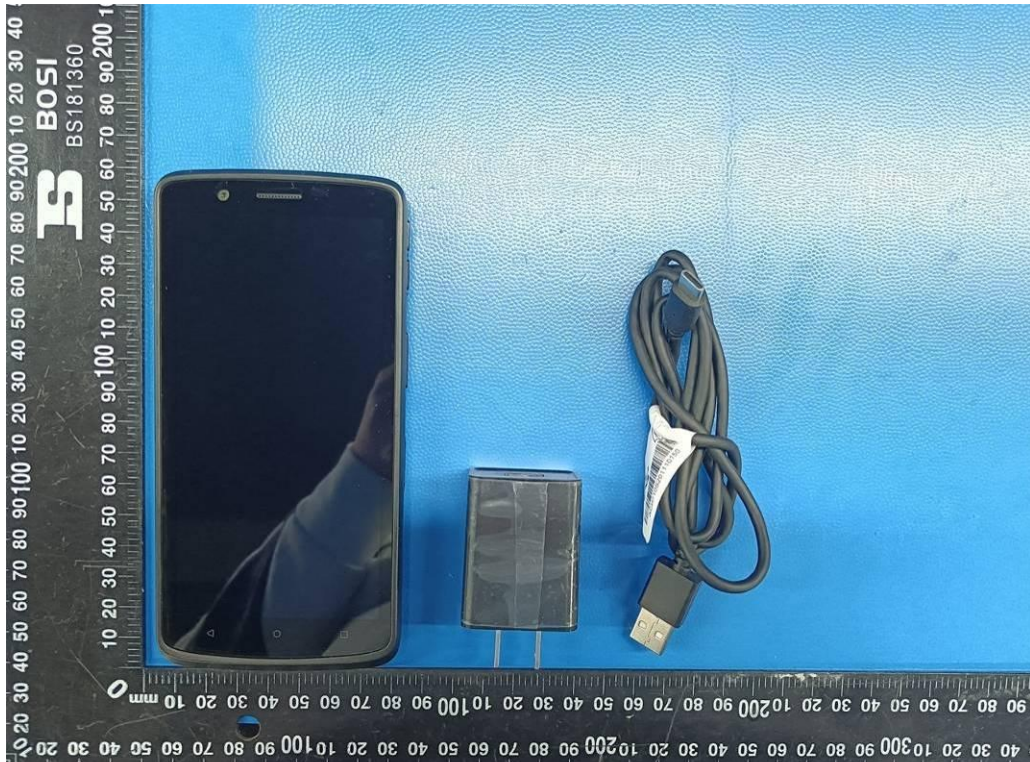

Fig. 1

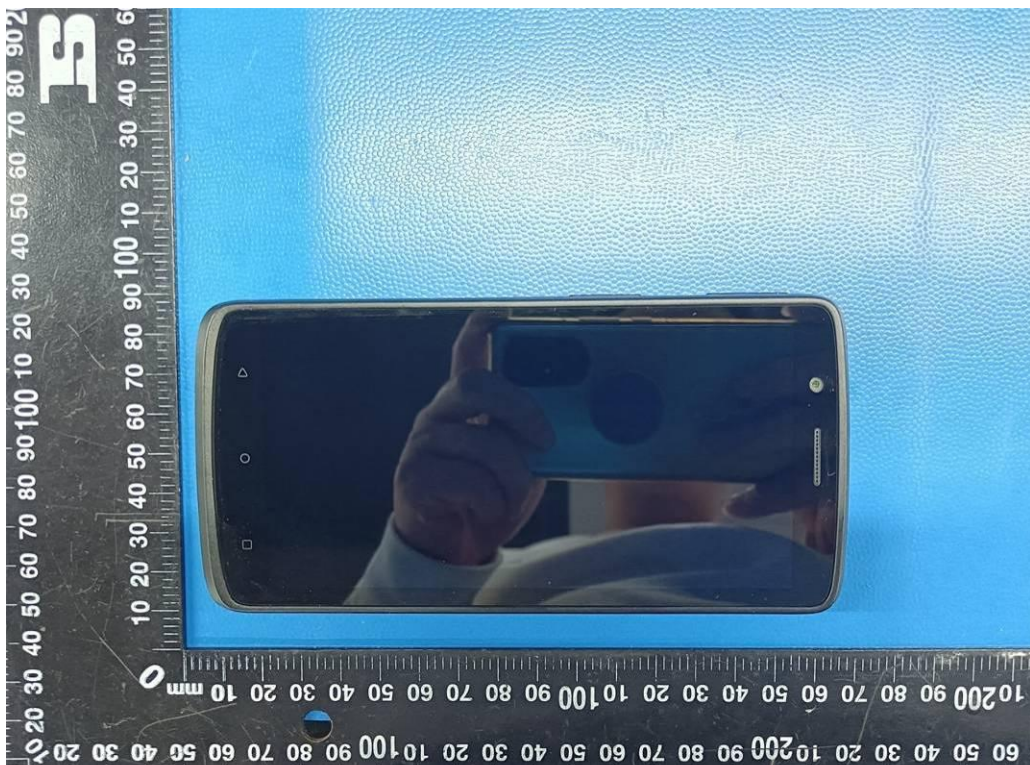

Fig. 2



Fig. 3



Fig. 4



Fig. 5



Fig. 6



Fig. 7

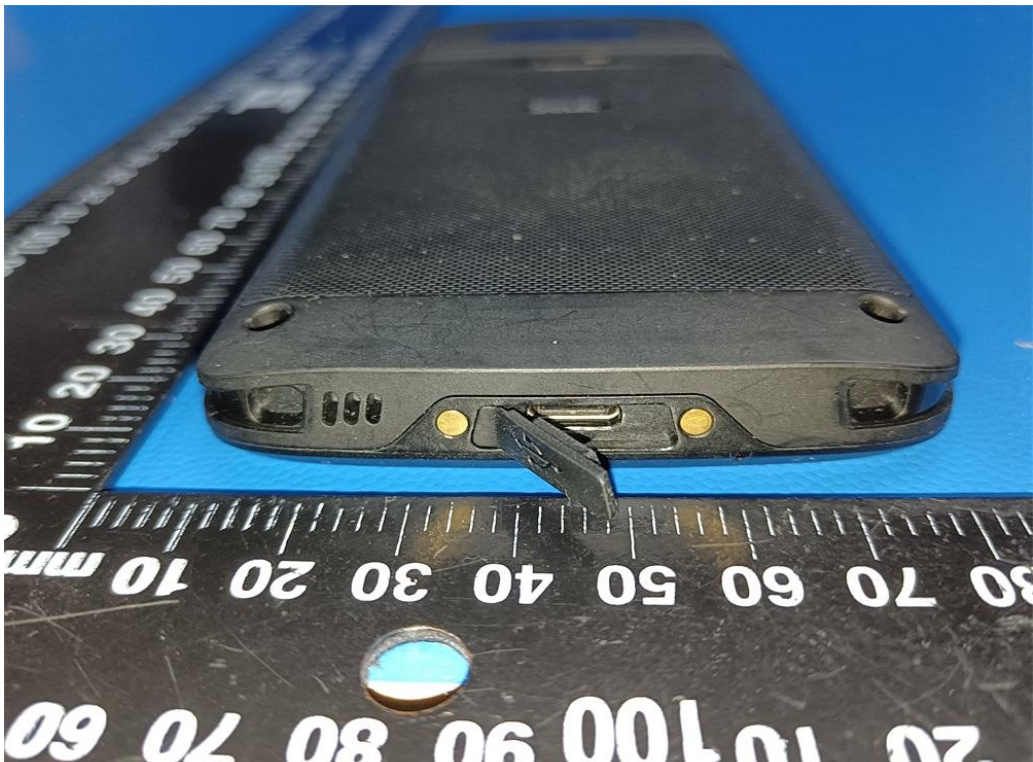

Fig. 8

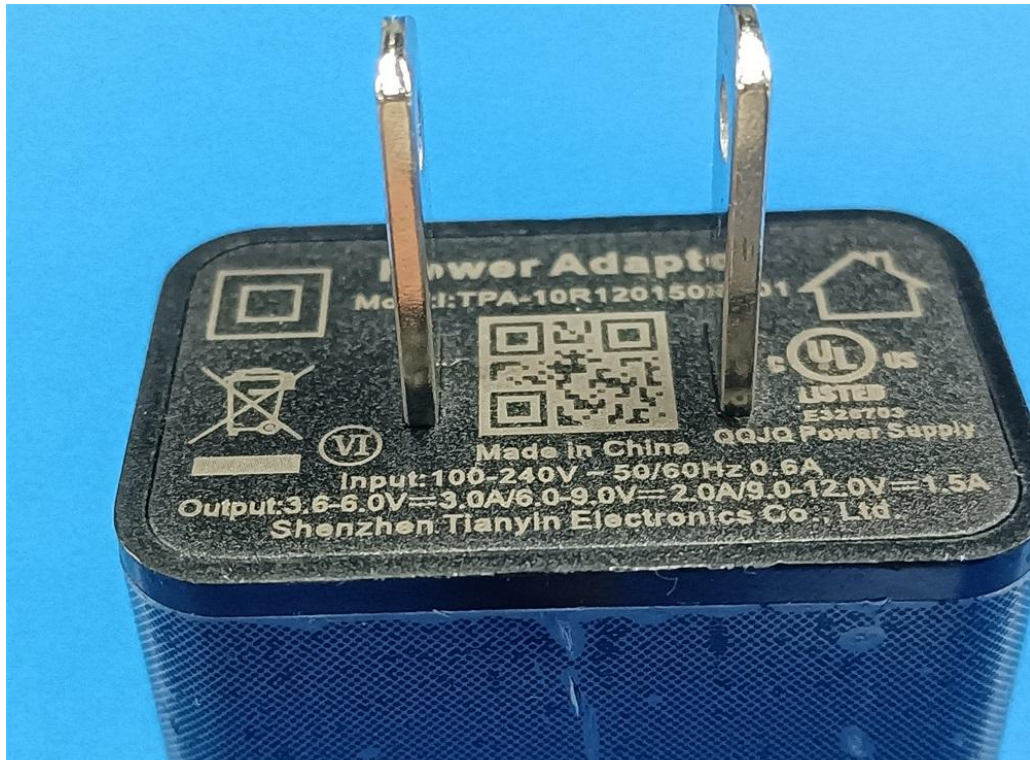

Fig. 9

6.2. Internal photos of the EUT



Fig. 10



Fig. 11



Fig. 12

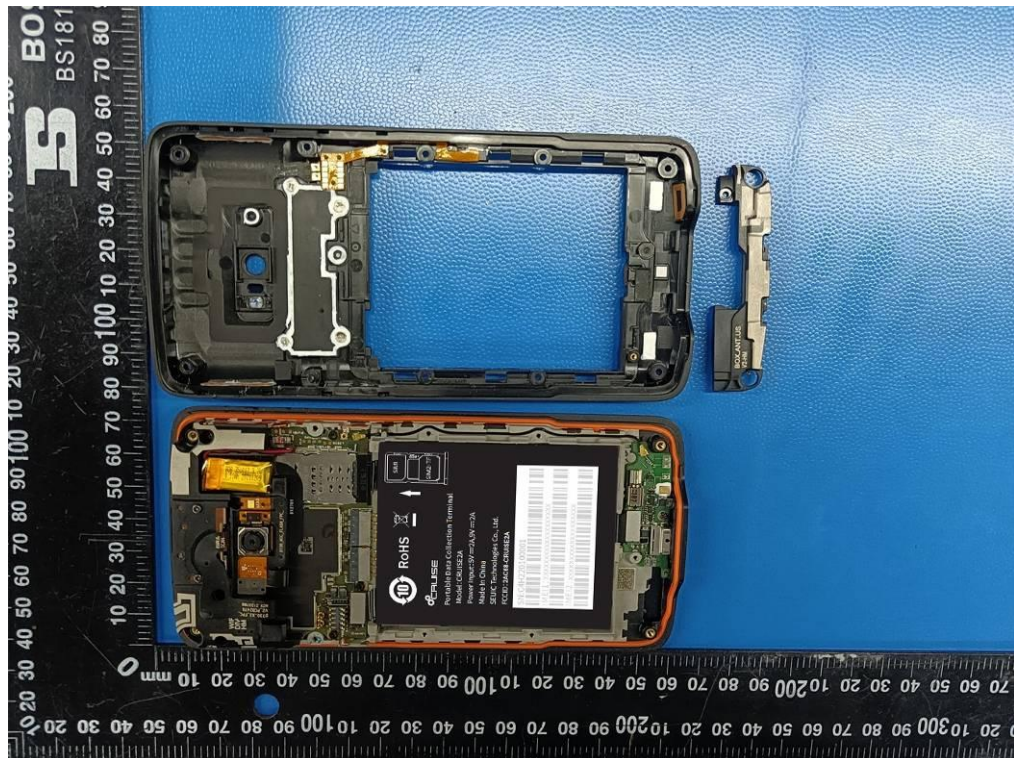

Fig. 13

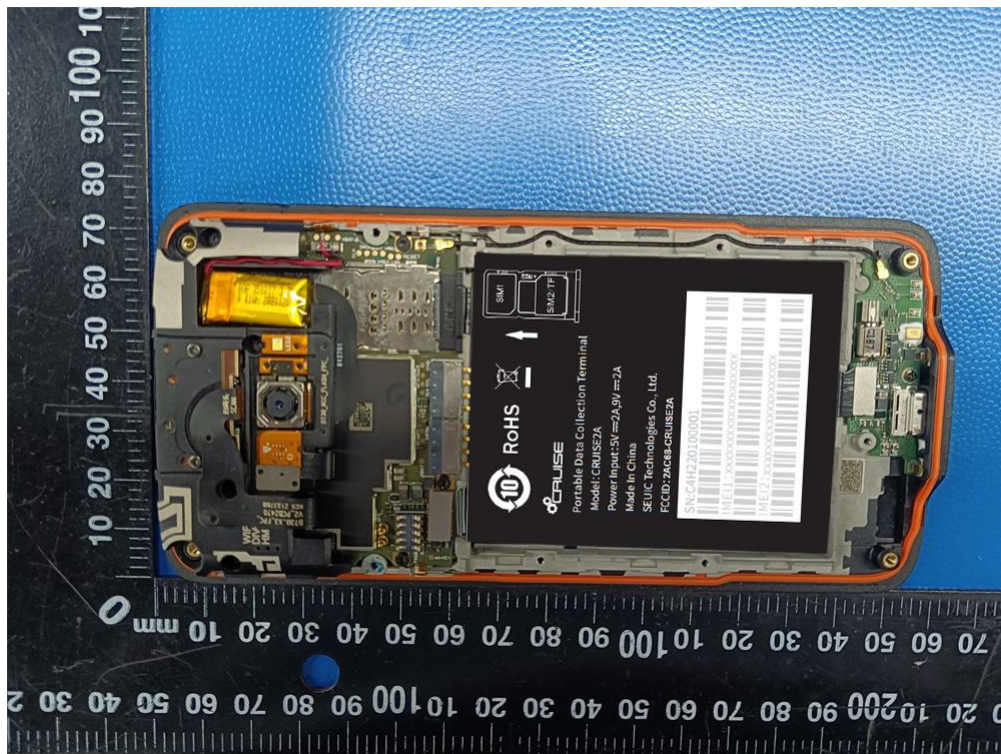

Fig. 14



Fig. 15

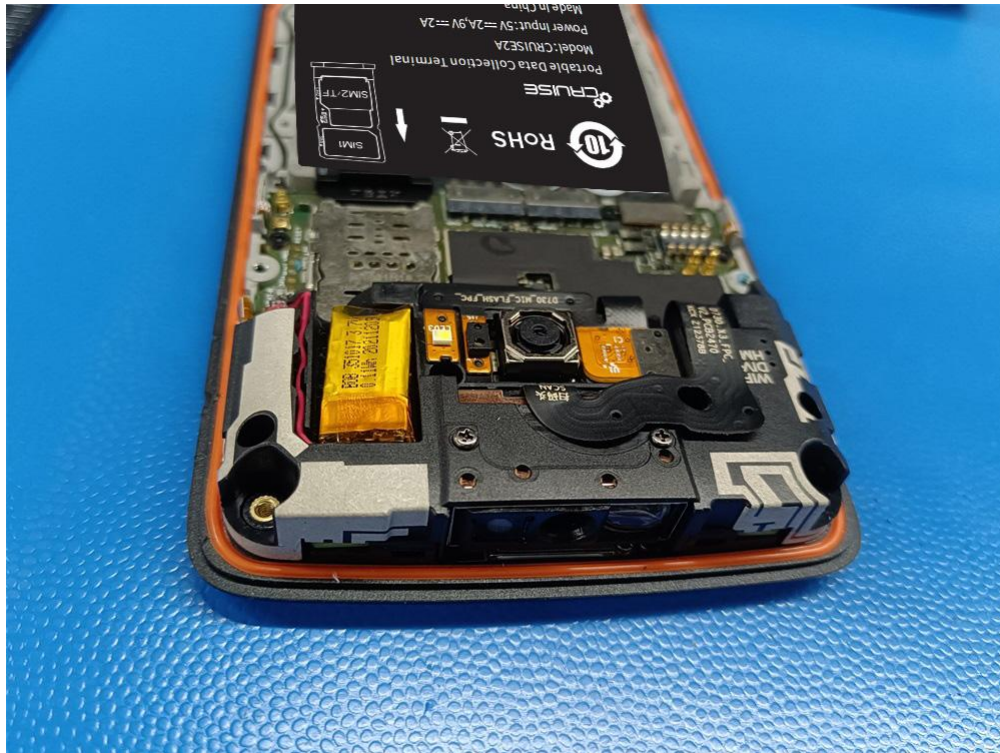

Fig. 16



Fig. 17



Fig. 18

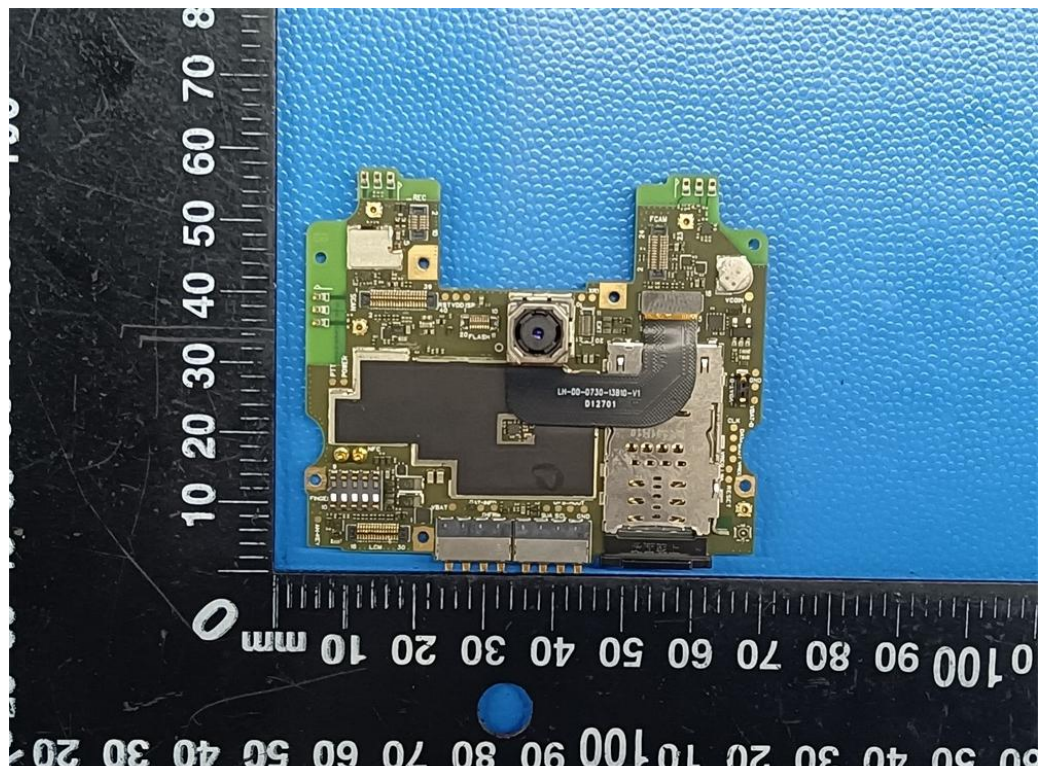

Fig. 19

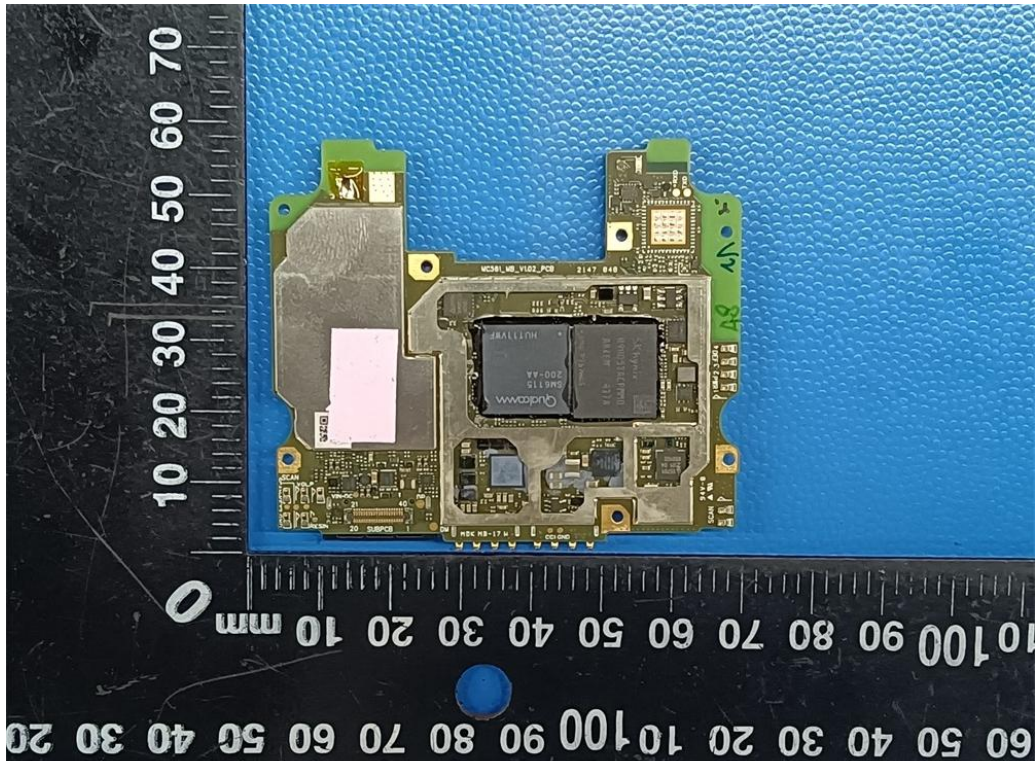

Fig. 20

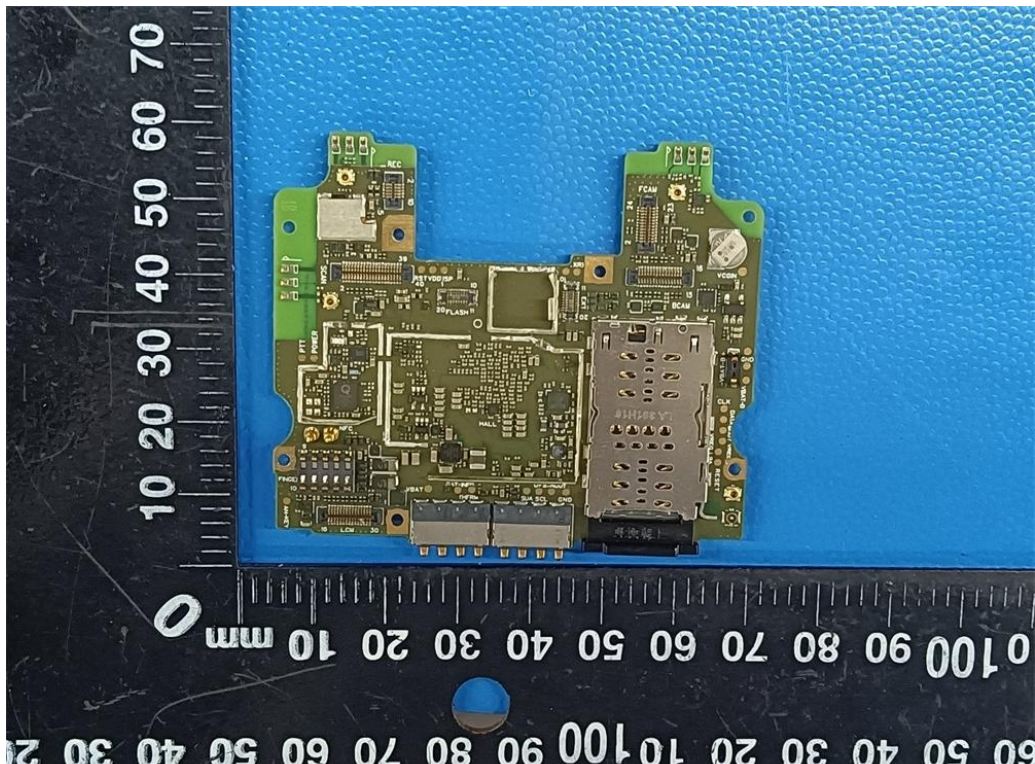

Fig. 21

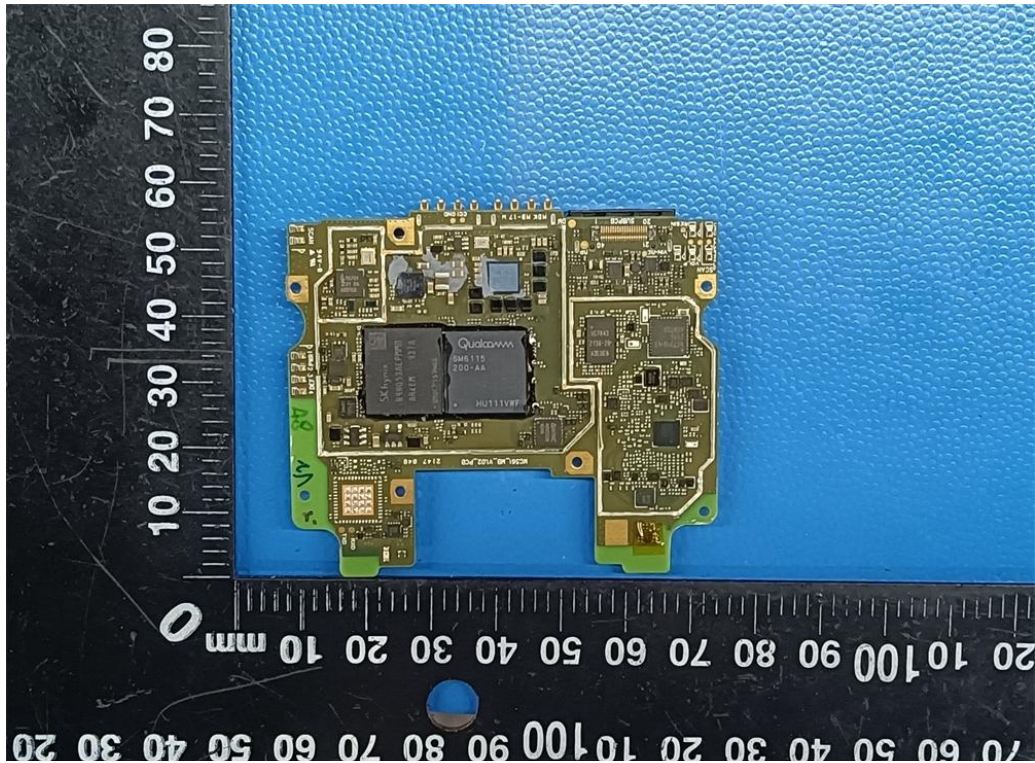

Fig. 22



Fig. 23



Fig. 24



Fig. 25

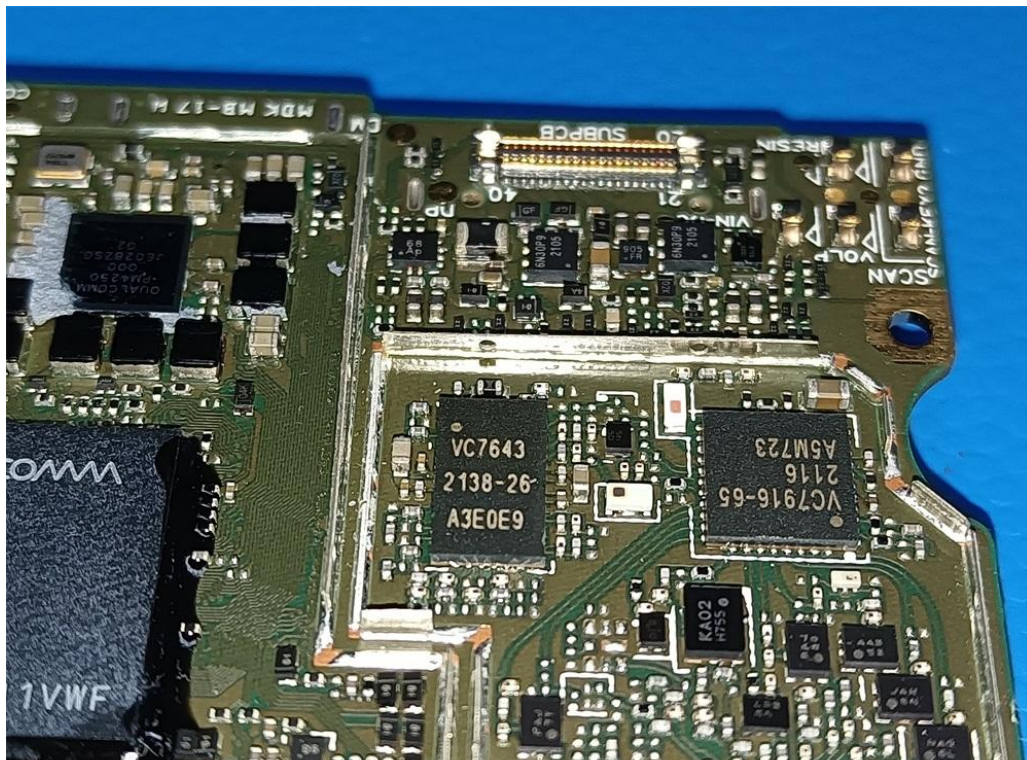

Fig. 26

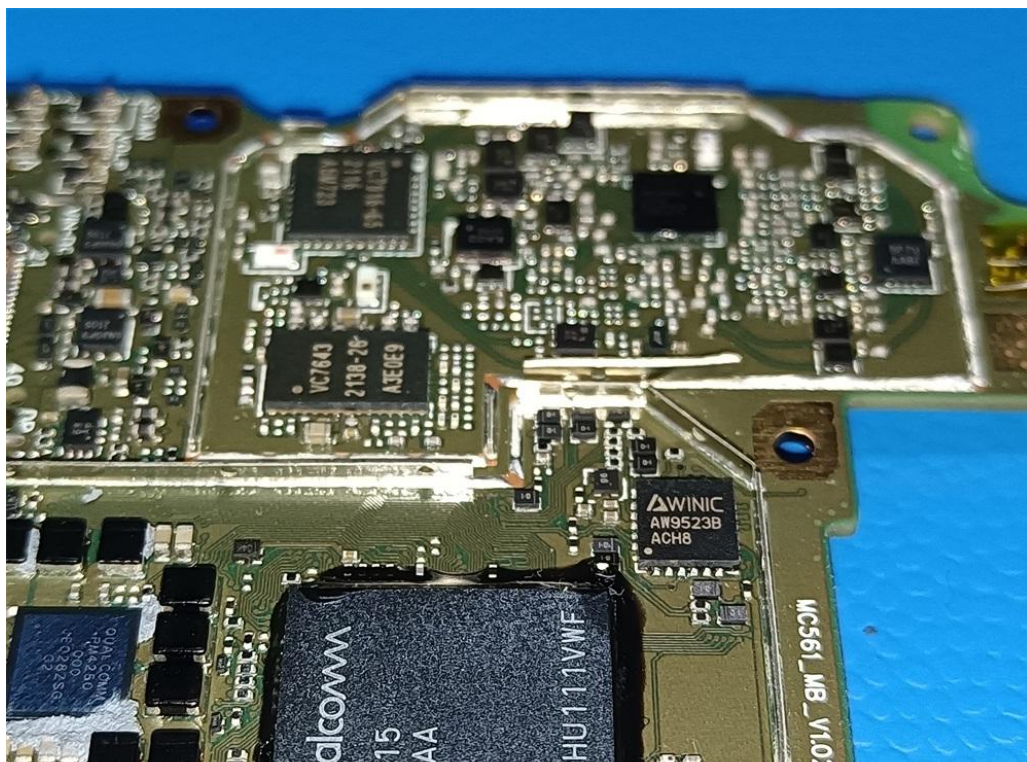

Fig. 27

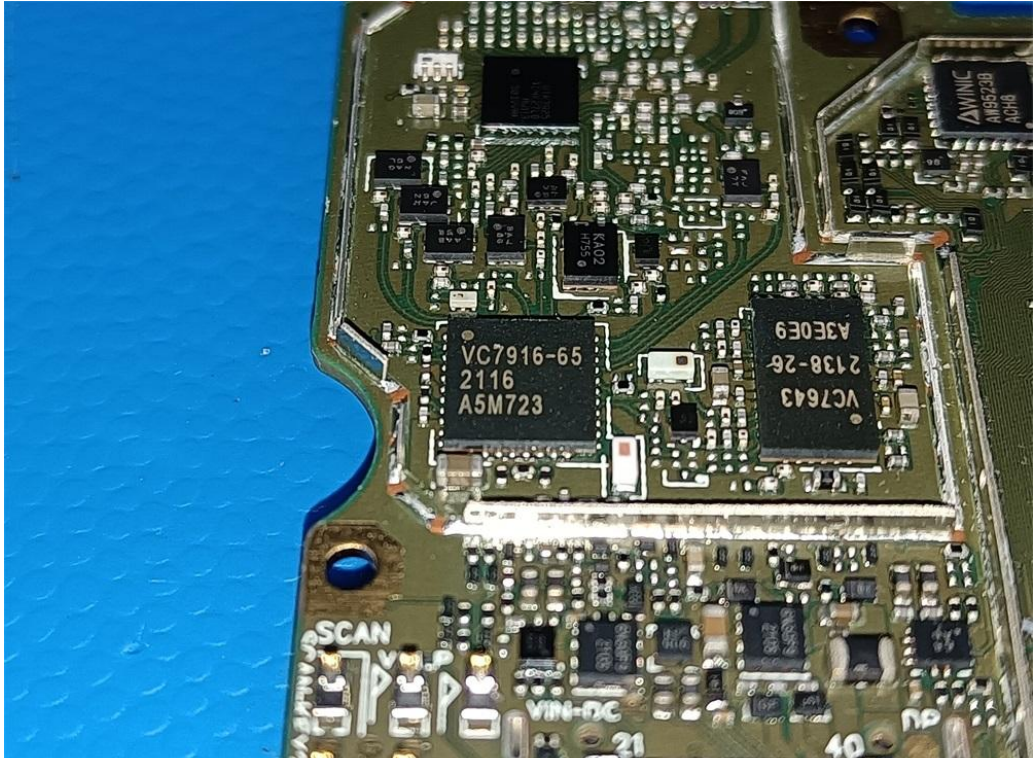

Fig. 28

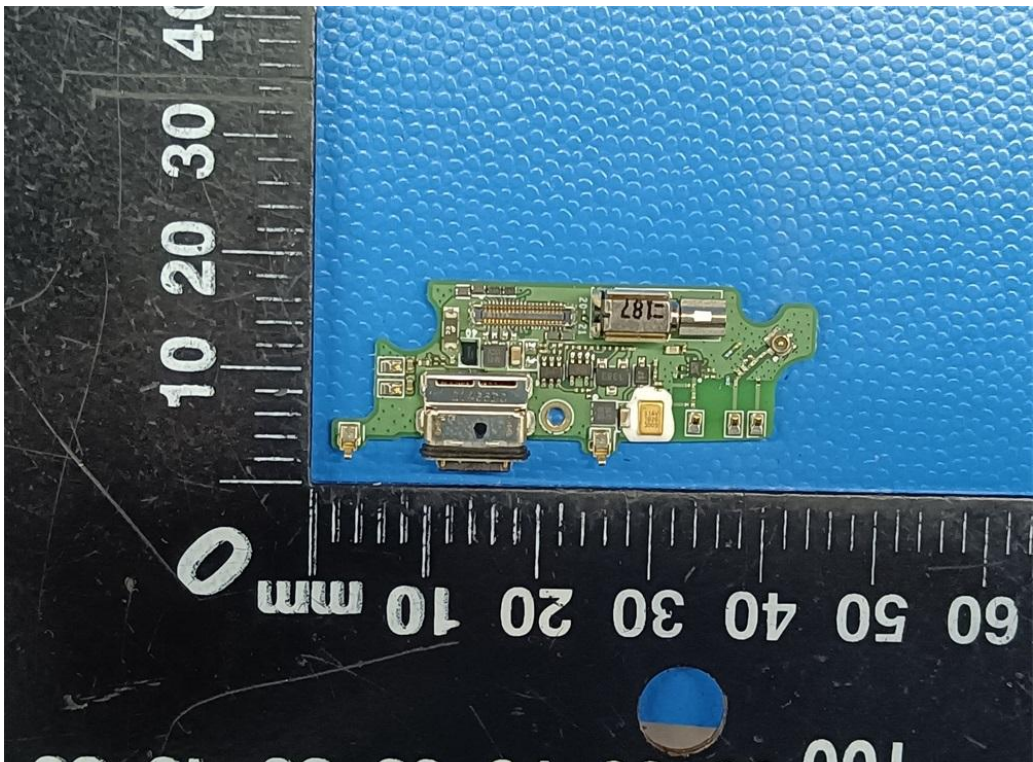

Fig. 29

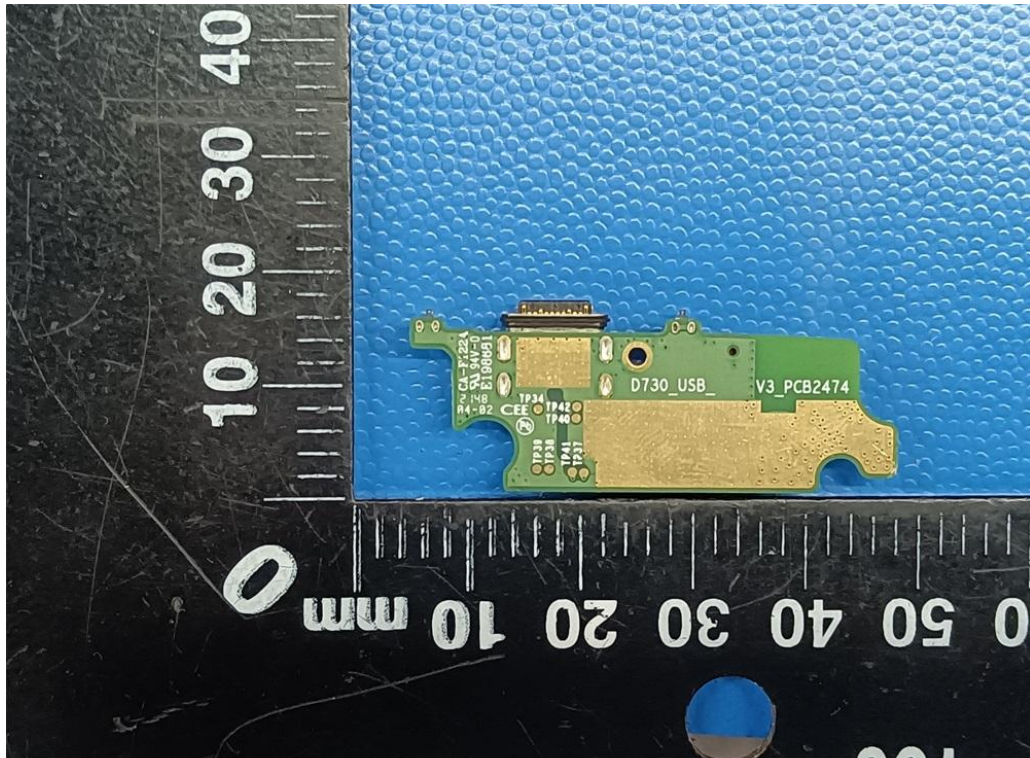

Fig. 30

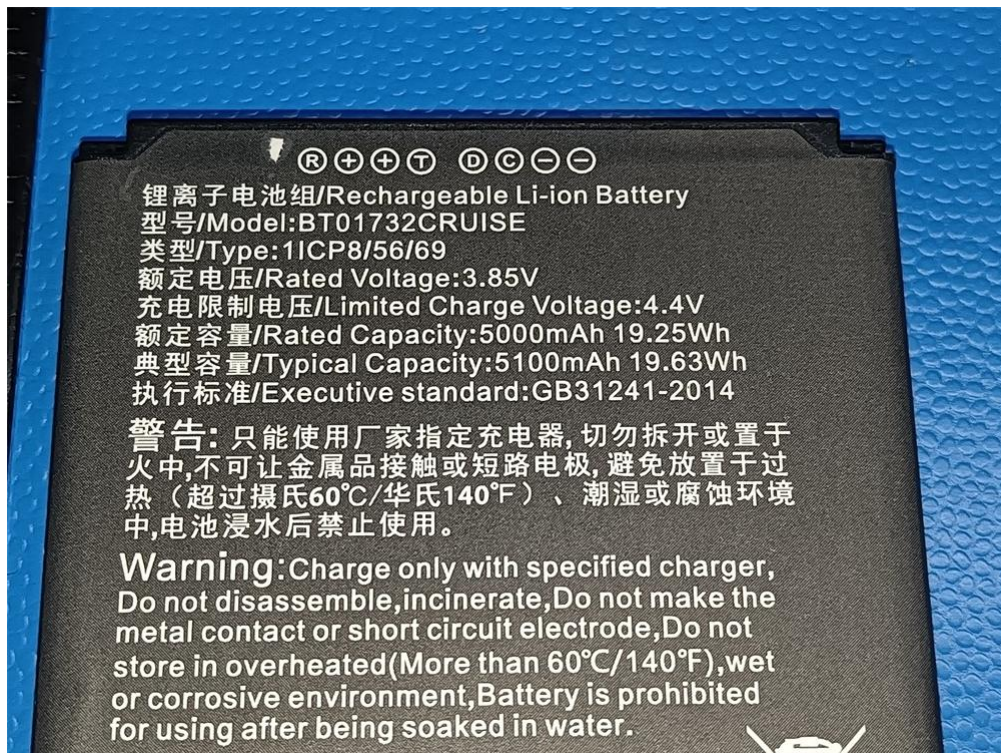

Fig. 31

.....End of Report.....