



Shenzhen Global Test Service Co.,Ltd.

No.7-101 and 8A-104, Building 7 and 8, DCC Cultural and Creative Garden, No.98, Pingxin North Road, Shangmugu Community, Pinghu Street, Longgang District, Shenzhen, Guangdong

FCC TEST REPORT

FCC Part 22/Part 24/Part 27

Report Reference No.....: **GTS20220307015-1-6**

FCC ID.....: **2AC68-CRUISE2A**

Compiled by
(position+printed name+signature)..: File administrators Peter Xiao

Supervised by
(position+printed name+signature)..: Test Engineer Jenny Zeng

Approved by
(position+printed name+signature)..: Manager Simon Hu

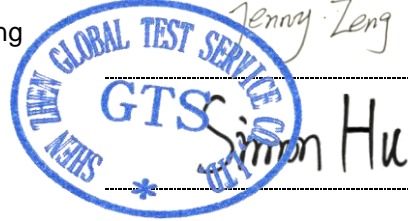

Date of issue.....: Mar. 30, 2022

Representative Laboratory Name .: Shenzhen Global Test Service Co.,Ltd.

Address: No.7-101 and 8A-104, Building 7 and 8, DCC Cultural and Creative Garden, No.98, Pingxin North Road, Shangmugu Community, Pinghu Street, Longgang District, Shenzhen, Guangdong

Applicant's name: SEUIC Technologies Co., Ltd.

Address: NO.15 Xinghuo Road, Nanjing New & High Technology Industry Development Zone, Nanjing, China, 210061

Test specification

FCC CFR Title 47 Part 2, Part 22H, Part 24E,Part 27

Standard.....: **TIA-603-E March 2016**

FCC KDB971168 D01 Power Meas License Digital Systems v03r01

TRF Originator.....: Shenzhen Global Test Service Co.,Ltd..

Shenzhen Global Test Service Co.,Ltd. All rights reserved.

This publication may be reproduced in whole or in part for non-commercial purposes as long as the Shenzhen Global Test Service Co.,Ltd. is acknowledged as copyright owner and source of the material. Shenzhen Global Test Service Co.,Ltd. takes no responsibility for and will not assume liability for damages resulting from the reader's interpretation of the reproduced material due to its placement and context.

Test item description **Portable Data Collection Terminal**

Trade Mark: N/A

Manufacturer: SEUIC Technologies Co., Ltd.

Model/Type reference.....: CRUISE2A

Listed Models: CRUISE2

Modulation Type.....: QPSK, 16QAM

Hardware Version: MC561_MB_V1.02

Software Version: D730_V0.1.7

Rating: DC 3.85V by battery
Recharged by DC 9.0V

Result.....: **PASS**

TEST REPORT

Test Report No. : GTS20220307015-1-6	Mar. 30, 2022
	Date of issue

Equipment under Test : Portable Data Collection Terminal

Model /Type : CRUISE2A

Listed model : CRUISE2

Applicant : **SEUIC Technologies Co., Ltd.**

Address : NO.15 Xinghuo Road, Nanjing New & High Technology Industry Development Zone, Nanjing, China, 210061

Manufacturer : **SEUIC Technologies Co., Ltd.**

Address : NO.15 Xinghuo Road, Nanjing New & High Technology Industry Development Zone, Nanjing, China, 210061

Test result	Pass *
--------------------	---------------

* In the configuration tested, the EUT complied with the standards specified page 4.

The test report merely corresponds to the test sample.
 It is not permitted to copy extracts of these test result without the written permission of the test laboratory.

Contents

1 SUMMARY	4
1.1 TEST STANDARDS	4
2 GENERAL INFORMATION.....	5
2.1 General Remarks	5
2.2 Product Description	5
2.3 Equipment Under Test	7
2.4 Short description of the Equipment under Test (EUT)	7
2.5 Environmental conditions	7
2.6 Description of Test Modes	7
2.7 Block Diagram of Test Setup	7
2.8 Special Accessories	7
2.9 Related Submittal(s) / Grant (s)	7
2.10 Modifications	7
3 TEST ENVIRONMENT	8
3.1 Address of the test laboratory	8
3.2 Test Facility	8
3.3 Environmental conditions	8
3.4 Statement of the measurement uncertainty	8
3.5 Test Description	9
3.6 Equipments Used during the Test.....	10
4 TEST CONDITIONS AND RESULTS	11
4.1 Output Power	11
4.2 Peak-to-Average Ratio (PAR)	16
4.3 Occupied Bandwidth and Emission Bandwidth.....	19
4.4 Band Edge compliance	22
4.5 Spurious Emission.....	25
4.6 Frequency Stability under Temperature & Voltage Variations	35
5 TEST SETUP PHOTOS OF THE EUT.....	37
6 EXTERNAL AND INTERNAL PHOTOS OF THE EUT	37

1 SUMMARY

1.1 TEST STANDARDS

The tests were performed according to following standards:

[FCC Part 22](#) : PUBLIC MOBILE SERVICES

[FCC Part 24](#) : PERSONAL COMMUNICATIONS SERVICES

[FCC Part 27](#) : MISCELLANEOUS WIRELESS COMMUNICATIONS SERVICES

[TIA-603-E March 2016](#): Land Mobile FM or PM Communications Equipment Measurement and Performance Standards.

[FCC Part 2](#): FREQUENCY ALLOCATIONS AND RADIO TREATY MATTERS; GENERAL RULES AND REGULATIONS

[FCC KDB971168 D01](#) Power Meas License Digital Systems v03r01

[ANSI C63.26:2015](#):American National Standard for Compliance Testing of Transmitters Used in Licensed Radio Services

2 GENERAL INFORMATION

2.1 General Remarks

Date of receipt of test sample	:	Mar. 09, 2022
Testing commenced on	:	Mar. 09, 2022
Testing concluded on	:	Mar. 30, 2022

2.2 Product Description

Product Name	Portable Data Collection Terminal
Trade Mark	N/A
Model/Type reference	CRUISE2A
List Models	CRUISE2
Model Declaration	PCB board, structure and internal of these model(s) are the same, Only the model name different , So no additional models were tested.
Power supply:	DC 3.85V by battery Recharged by DC 9.0V
Sample ID	GTS20220307015-1-1# & GTS20220307015-1-2#
Bluetooth	
Operation frequency	2402-2480MHz
Channel Number	79 channels for Bluetooth (DSS) 40 channels for Bluetooth (DTS)
Channel Spacing	1MHz for Bluetooth (DSS) 2MHz for Bluetooth (DTS)
Modulation Type	GFSK, $\pi/4$ -DQPSK, 8DPSK for Bluetooth (DSS) GFSK for Bluetooth (DTS)
WIFI(2.4G Band)	
Frequency Range	2412MHz ~ 2462MHz
Channel Spacing	5MHz
Channel Number	11 Channel for 20MHz bandwidth(2412~2462MHz) 7 Channel for 40MHz bandwidth(2422~2452MHz)
Modulation Type	802.11b: DSSS(CCK,DQPSK,DBPSK); 802.11g/n: OFDM(64QAM, 16QAM, QPSK, BPSK)
WIFI(5.2G Band)	
Frequency Range	5180MHz ~ 5240MHz, 5260MHz ~ 5320MHz, 5500MHz ~ 5700MHz
Channel Number	4 Channels for 20MHz bandwidth(5180-5240MHz) 4 Channels for 20MHz bandwidth(5260-5320MHz) 11 Channels for 20MHz bandwidth(5500-5700MHz) 2 channels for 40MHz bandwidth(5190~5230MHz) 2 channels for 40MHz bandwidth(5270~5310MHz) 5 Channels for 40MHz bandwidth(5510-5670MHz) 1 channels for 80MHz bandwidth(5210MHz) 1 channels for 80MHz bandwidth(5290MHz) 2 Channels for 80MHz bandwidth(5530-5610MHz)
Modulation Type	802.11a/n/ac: OFDM(256QAM,64QAM, 16QAM, QPSK, BPSK)
WIFI (5.8G Band)	
Frequency Range	5745MHz ~ 5825MHz
Channel Number	5 channels for 20MHz bandwidth(5745-5825MHz) 2 channels for 40MHz bandwidth(5755~5795MHz) 1 channels for 80MHz bandwidth(5775MHz)
Modulation Type	802.11a/n/ac: OFDM(256QAM,64QAM, 16QAM, QPSK, BPSK)
Antenna Description	Internal Antenna, -1dBi(Max.) for 2.4G Band and 5G Band
2G	
Support Band	GSM850/GSM1900/GPRS850/GPRS1900/EDGE850/EDGE1900

Release Version	R99
GPRS Class	Class 12
EGPRS Class	Class 12
GSM/EDGE/GPRS Power Class	GSM850:Power Class 4/ PCS1900:Power Class 1
GPRS/EDGE Multislot Class	GPRS/EDGE: Multi-slot Class 12
Type Of Modulation	GMSK for GSM/GPRS; GMSK/8PSK for EGPRS
Antenna Description	Internal Antenna; 2.52dBi (max.) For GSM 850, DCS 1900
3G	
UMTS Operation Frequency Band	UMTS FDD Band 2(1850 MHz -1910MHz) UMTS FDD Band 4(1710 MHz -1755MHz) UMTS FDD Band 5(824 MHz -849MHz)
WCDMA Release Version	R8
HSDPA Release Version	Release 8
HSUPA Release Version	Release 8
Modulation Type	QPSK/16QAM
Antenna Description	Internal Antenna; 2.52dBi (max.) For WCDMA Band 2, 4, 5;
LTE	
LTE Operation Frequency Band	E-UTRA Band 2(1850 MHz -1910MHz) E-UTRA Band 4(1710 MHz -1755MHz) E-UTRA Band 5(824 MHz -849MHz) E-UTRA Band 7(2500 MHz -2570MHz) E-UTRA Band 12(699 MHz -716MHz) E-UTRA Band 13(777 MHz -787MHz) E-UTRA Band 17(704 MHz -716MHz) E-UTRA Band 25(1850 MHz -1915MHz) E-UTRA Band 26(814 MHz -824MHz) E-UTRA Band 26(824 MHz -849MHz) E-UTRA Band 38(2570 MHz -2620MHz) E-UTRA Band 41(2555 MHz -2655MHz) E-UTRA Band 66(1710 MHz -1780MHz)
LTE Release Version	R10
Type Of Modulation	QPSK/16QAM/64QAM
Antenna Description	Internal Antenna; 2.52dBi (max.) For LTE Band 2, 4, 5, 7, 12, 13, 17, 25, 26, 38, 41, 66;
RFID(13.56MHz) (Optional)	
Frequency Range	13.56MHz
Channel Number	1
Modulation Type	ASK
Antenna Description	Internal Antenna, 0dBi (Max.)
GPS(RX)	Support

2.3 Equipment Under Test

Power supply system utilised

Power supply voltage	:	<input type="radio"/>	230V / 50 Hz	<input type="radio"/>	120V / 60Hz
		<input type="radio"/>	12 V DC	<input type="radio"/>	24 V DC
		<input checked="" type="radio"/>	Other (specified in blank below)		

DC 3.85V

2.4 Short description of the Equipment under Test (EUT)

This is a Portable Data Collection Terminal .For more details, refer to the user's manual of the EUT.

2.5 Environmental conditions

During the measurement the environmental conditions were within the listed ranges:

Normal Temperature:	25°C
Relative Humidity:	55 %
Air Pressure:	101 kPa

2.6 Description of Test Modes

The EUT has been tested under typical operating condition. The CMW500 used to control the EUT staying in continuous transmitting and receiving mode for testing. Regards to the frequency band operation: the lowest, middle and highest frequency of channel were selected to perform the test, then shown on this report.

Note:

1. For the ERP/EIRP and radiated emission test, every axis (X, Y, Z) was verified, and show the worst result on this report.
2. Test method and refer to 3GPP TS134 121.

2.7 Block Diagram of Test Setup

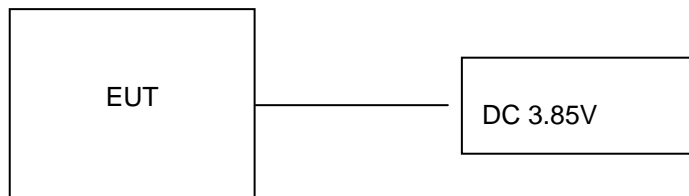

2.8 Special Accessories

Manufacturer	Description	Model	Serial Number	Certificate
Shenzhen Tianyin Electronics Co., Ltd.	Adapter	TPA-10R120150UU01	--	SDOC

2.9 Related Submittal(s) / Grant (s)

This submittal(s) (test report) is filing to comply with of the FCC Part 22,Part 24,Part 27 Rules.

2.10 Modifications

No modifications were implemented to meet testing criteria.

3 TEST ENVIRONMENT

3.1 Address of the test laboratory

Shenzhen Global Test Service Co.,Ltd.

No.7-101 and 8A-104, Building 7 and 8, DCC Cultural and Creative Garden, No.98, Pingxin North Road, Shangmugu Community, Pinghu Street, Longgang District, Shenzhen, Guangdong,China.

The sites are constructed in conformance with the requirements of ANSI C63.4 (2014) and CISPR Publication 22.

3.2 Test Facility

The test facility is recognized, certified, or accredited by the following organizations:

CNAS (No. CNAS L8169)

Shenzhen Global Test Service Co., Ltd. has been assessed and proved to be in compliance with CNAS-CL01 Accreditation Criteria for Testing and Calibration Laboratories (identical to ISO/IEC 17025: 2019 General Requirements) for the Competence of Testing and Calibration Laboratories.

A2LA (Certificate No. 4758.01)

Shenzhen Global Test Service Co., Ltd. has been assessed by the American Association for Laboratory Accreditation (A2LA). Certificate No. 4758.01.

Industry Canada Registration Number. is 24189.

FCC Designation Number is CN1234.

FCC Registered Test Site Number is165725.

3.3 Environmental conditions

During the measurement the environmental conditions were within the listed ranges:

Temperature:	15-35 ° C
Humidity:	30-60 %
Atmospheric pressure:	950-1050mbar

3.4 Statement of the measurement uncertainty

The data and results referenced in this document are true and accurate. The reader is cautioned that there may be errors within the calibration limits of the equipment and facilities. The measurement uncertainty was calculated for all measurements listed in this test report acc. to CISPR 16 - 4 „Specification for radio disturbance and immunity measuring apparatus and methods – Part 4: Uncertainty in EMC Measurements“ and is documented in the Shenzhen Global Test Service Co.,Ltd quality system acc. to DIN EN ISO/IEC 17025. Furthermore, component and process variability of devices similar to that tested may result in additional deviation. The manufacturer has the sole responsibility of continued compliance of the device.

Hereafter the best measurement capability for Shenzhen GTS laboratory is reported:

Test	Range	Measurement Uncertainty	Notes
Radiated Emission	30~1000MHz	4.10 dB	(1)
Radiated Emission	1~18GHz	4.32 dB	(1)
Radiated Emission	18-40GHz	5.54 dB	(1)
Conducted Disturbance	0.15~30MHz	3.12 dB	(1)

This uncertainty represents an expanded uncertainty expressed at approximately the 95% confidence level using a coverage factor of k=2.

3.5 Test Description

Test Item	Section in CFR 47	Test Sample	Result
RF Output Power	Part 2.1046 Part 22.913(a) Part 24.232(c) Part 27.50	GTS20220307015-1-1#	Pass
Peak-to-Average Ratio	Part 2.1046 Part 24.232 Part 27.50(d)	GTS20220307015-1-1#	Pass
99% & -26 dB Occupied Bandwidth	Part 2.1049	GTS20220307015-1-1#	Pass
Spurious Emissions at Antenna Terminal	Part 2.1051 Part 22.917 Part 24.238 Part 27.53	GTS20220307015-1-1#	Pass
Field Strength of Spurious Radiation	Part 2.1053 Part 22.917(b) Part 24.238 Part 27.53	GTS20220307015-1-1#	Pass
Out of band emission, Band Edge	Part 2.1051 Part 22.917(b) Part 24.238 Part 27.53	GTS20220307015-1-1#	Pass
Frequency stability	Part 2.1055 Part 22.355 Part 24.235 Part 27.54	GTS20220307015-1-1#	Pass

Remark:

1. The measurement uncertainty is not included in the test result.
2. NA = Not Applicable; NP = Not Performed
3. Note 1 – Test results inside test report;
4. Note 2 – Test results in other test report (SAR Report).
5. We tested all test mode and recorded worst case in report

3.6 Equipments Used during the Test

Test Equipment	Manufacturer	Model No.	Serial No.	Calibration Date	Calibration Due Date
LISN	CYBERTEK	EM5040A	E1850400105	2021/07/17	2022/07/16
LISN	R&S	ESH2-Z5	893606/008	2021/07/17	2022/07/16
EMI Test Receiver	R&S	ESPI3	101841-cd	2021/07/17	2022/07/16
EMI Test Receiver	R&S	ESCI7	101102	2021/09/19	2022/09/18
Spectrum Analyzer	Agilent	N9020A	MY48010425	2021/09/19	2022/09/18
Spectrum Analyzer	R&S	FSV40	100019	2021/07/17	2022/07/16
Vector Signal generator	Agilent	N5181A	MY49060502	2021/07/17	2022/07/16
Signal generator	Agilent	N5182A	3610AO1069	2021/09/19	2022/09/18
Climate Chamber	ESPEC	EL-10KA	A20120523	2021/09/19	2022/09/18
Controller	EM Electronics	Controller EM 1000	N/A	N/A	N/A
Horn Antenna	Schwarzbeck	BBHA 9120D	01622	2021/11/07	2022/11/06
Active Loop Antenna	Beijing Da Ze Technology Co.,Ltd.	ZN30900C	15006	2021/10/10	2022/11/09
Bilog Antenna	Schwarzbeck	VULB9163	000976	2021/07/23	2022/07/22
Broadband Horn Antenna	SCHWARZBECK	BBHA 9170	791	2021/11/07	2022/11/06
Amplifier	Schwarzbeck	BBV 9743	#202	2021/08/08	2022/08/07
Amplifier	Schwarzbeck	BBV9179	9719-025	2021/07/17	2022/07/16
Amplifier	EMCI	EMC051845B	980355	2021/07/17	2022/07/16
Temperature/Humidity Meter	Gangxing	CTH-608	02	2021/07/17	2022/07/16
High-Pass Filter	K&L	9SH10-2700/X12750-O/O	KL142031	2021/07/17	2022/07/16
High-Pass Filter	K&L	41H10-1375/U12750-O/O	KL142032	2021/07/17	2022/07/16
RF Cable(below 1GHz)	HUBER+SUHNER	RG214	RE01	2021/07/17	2022/07/16
RF Cable(above 1GHz)	HUBER+SUHNER	RG214	RE02	2021/07/17	2022/07/16
Data acquisition card	Agilent	U2531A	TW53323507	2021/07/17	2022/07/16
Power Sensor	Agilent	U2021XA	MY5365004	2021/07/17	2022/07/16
Test Control Unit	Tonscend	JS0806-1	178060067	2021/07/17	2022/07/16
Automated filter bank	Tonscend	JS0806-F	19F8060177	2021/07/17	2022/07/16
EMI Test Software	Tonscend	JS1120-1	Ver 2.6.8.0518	/	/
Radio Communication Tester	Rohde&Schwarz	CMW500	115406	2021/07/17	2022/07/16
EMI Test Software	Tonscend	JS1120-3	Ver 2.5.77.0418	/	/
EMI Test Software	Tonscend	JS32-CE	Ver 2.5	/	/
EMI Test Software	Tonscend	JS32-RE	Ver 2.5.1.8	/	/

Note: The Cal.Interval was one year.

4 TEST CONDITIONS AND RESULTS

4.1 Output Power

LIMIT

This is the test for the maximum radiated power from the EUT.

Per rule Part 24.232(c) specifies, "Mobile/portable stations are limited to 2 watts e.i.r.p. Peak power" and 24.232(e) specifies that "Peak transmit power must be measured over any interval of continuous transmission using instrumentation calibrated in terms of an rms-equivalent voltage."

Per rule Part 22.913(a) specifies " The ERP of mobile transmitters and auxiliary test transmitters must not exceed 7 Watts."

Per rule Part 27.50 specifies " The ERP of Fixed, mobile, and portable (hand-held) stations must not exceed 1 Watts."

TEST CONFIGURATION

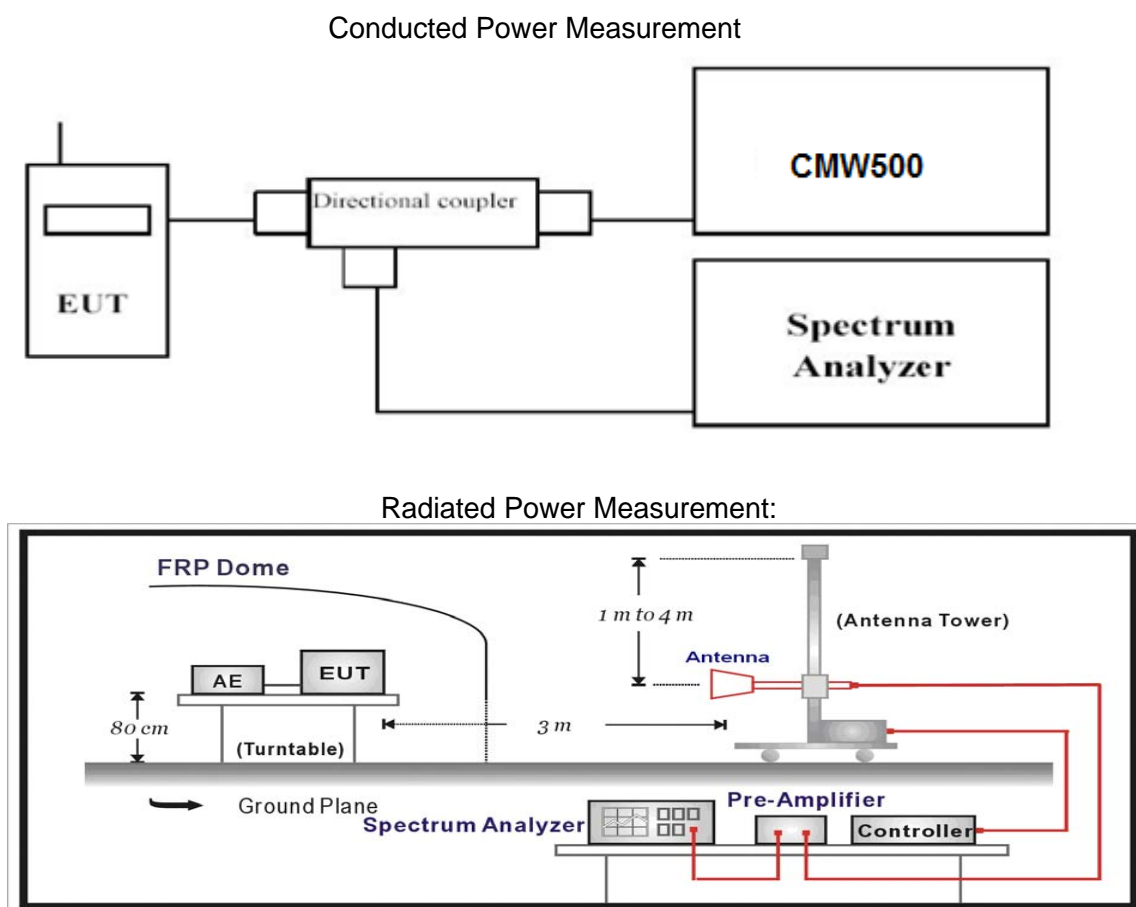

TEST PROCEDURE

The EUT was setup according to EIA/TIA 603D

Conducted Power Measurement:

- Place the EUT on a bench and set it in transmitting mode.
- Connect a low loss RF cable from the antenna port to a spectrum analyzer and CMW500 by a Directional Couple.
- EUT Communicate with CMW500, then select a channel for testing.
- Add a correction factor to the display of spectrum, and then test.

Radiated Power Measurement:

- The EUT shall be placed at the specified height on a support, and in the position closest to normal use as declared by provider.

- b. The test antenna shall be oriented initially for vertical polarization and shall be chosen to correspond to the frequency of the transmitter
- c. The output of the test antenna shall be connected to the measuring receiver.
- d. The transmitter shall be switched on and the measuring receiver shall be tuned to the frequency of the
- e. transmitter under test.
- f. The test antenna shall be raised and lowered through the specified range of height until a maximum signal level is detected by the measuring receiver.
- g. The transmitter shall then be rotated through 360° in the horizontal plane, until the maximum signal level is detected by the measuring receiver.
- h. The test antenna shall be raised and lowered again through the specified range of height until a maximum signal level is detected by the measuring receiver.
- i. The maximum signal level detected by the measuring receiver shall be noted.
- j. The transmitter shall be replaced by a substitution antenna.
- k. The substitution antenna shall be orientated for vertical polarization and the length of the substitution antenna shall be adjusted to correspond to the frequency of the transmitter.
- l. The substitution antenna shall be connected to a calibrated signal generator.
- m. If necessary, the input attenuator setting of the measuring receiver shall be adjusted in order to increase the sensitivity of the measuring receiver.
- n. The test antenna shall be raised and lowered through the specified range of height to ensure that the maximum signal is received.
- o. The input signal to the substitution antenna shall be adjusted to the level that produces a level detected by the measuring receiver, that is equal to the level noted while the transmitter radiated power was measured, corrected for the change of input attenuator setting of the measuring receiver.
- p. The measurement shall be repeated with the test antenna and the substitution antenna orientated for horizontal polarization.
- q. The measure of the effective radiated power is the larger of the two levels recorded at the input to the substitution antenna, corrected for gain of the substitution antenna if necessary.
- r. Test site anechoic chamber refer to ANSI C63.26.

TEST RESULTS

Temperature	24.5°C	Humidity	53.7%
Test Engineer	Jenny Zeng	Configurations	WCDMA

Conducted Measurement:

WCDMA Band II

Mode	3GPP Sub Test	Low Channel	Middle Channel	High Channel
		Ave.Power (dBm)	Ave.Power (dBm)	Ave. Power (dBm)
Rel 99	1	23.65	23.30	23.29
HSDPA	1	23.88	23.62	23.74
	2	22.56	22.92	22.25
	3	21.65	21.54	21.83
	4	20.71	20.29	20.32
HSUPA	1	21.52	21.64	21.57
	2	21.07	21.33	21.29
	3	20.93	20.32	20.65
	4	19.82	19.71	19.50
	5	19.47	19.42	19.36

WCDMA Band VI

Mode	3GPP Sub Test	Low Channel	Middle Channel	High Channel
		Ave.Power (dBm)	Ave.Power (dBm)	Ave. Power (dBm)
Rel 99	1	23.48	23.62	23.70
HSDPA	1	23.90	23.92	23.23
	2	22.75	22.64	22.01
	3	21.87	21.42	21.17
	4	20.24	20.37	20.31
HSUPA	1	21.93	21.64	21.86
	2	21.20	21.11	21.46
	3	20.15	20.70	20.90
	4	20.00	19.78	19.66
	5	19.32	19.12	19.39

WCDMA Band V

Mode	3GPP Sub Test	Low Channel	Middle Channel	High Channel
		Ave.Power (dBm)	Ave.Power (dBm)	Ave. Power (dBm)
Rel 99	1	23.25	23.95	23.40
HSDPA	1	23.14	23.88	23.16
	2	22.43	22.56	22.13
	3	21.49	21.53	21.35
	4	20.66	20.67	20.48
HSUPA	1	21.91	21.95	21.50
	2	21.27	21.07	21.17
	3	21.00	20.43	20.31
	4	19.98	19.91	19.72
	5	19.36	19.14	19.17

NOTE:We measured all modes and only recorded the worst case.

Radiated Measurement:

Remark:

1. We were tested all RB Configuration refer 3GPP TS134 121 for each Channel Bandwidth of WCDMA Band II, WCDMA Band IV, WCDMA Band V; recorded worst case for each Channel Bandwidth of WCDMA Band II, WCDMA Band IV, WCDMA Band V.
2. ERP = EIRP – 2.15dBi as EIRP by subtracting the gain of the dipole.
3. The unit of Antenna Gain is dBd for frequency below 1GHz, and the unit of Antenna Gain is dBi for frequency above 1GHz.
4. Absolute Level = Substituted Level - Cable loss + Antenna Gain
5. Margin = Limit-Absolute Level

Temperature	24.5°C	Humidity	53.7%
Test Engineer	Jenny Zeng	Configurations	WCDMA

Frequency (MHz)	Polar (H/V)	Receiver Reading (dB μ V)	Substituted Method			Absolute Level EIRP/ERP (dBm)	Limit (dBm)	Margin (dB)
			Substituted Level (dBm)	Antenna Gain (dBd/dBi)	Cable Loss(dB)			
WCDMA Band II Low Channel								
1,852.40	H	84.20	13.86	11.59	2.11	23.34	33.00	9.66
1,852.40	V	84.62	12.08	11.59	2.11	21.56	33.00	11.44
WCDMA Band II Middle Channel								
1,880.00	H	86.06	14.00	11.56	2.14	23.42	33.00	9.58
1,880.00	V	85.54	12.13	11.56	2.14	21.55	33.00	11.45
WCDMA Band II High Channel								
1,907.60	H	86.15	11.96	11.52	2.18	21.30	33.00	11.70
1,907.60	V	84.88	11.30	11.52	2.18	20.64	33.00	12.36
WCDMA Band IV Low Channel								
1712.4	H	84.91	13.86	11.58	2.10	23.34	30.00	6.66
1712.4	V	87.52	13.93	11.58	2.10	23.41	30.00	6.59
WCDMA Band IV Middle Channel								
1732.60	H	84.82	13.95	11.56	2.14	23.37	30.00	6.63
1732.60	V	85.59	13.67	11.56	2.14	23.09	30.00	6.91
WCDMA Band IV High Channel								
1752.6	H	85.88	13.67	11.53	2.16	23.04	30.00	6.96
1752.6	V	86.01	13.66	11.53	2.16	23.03	30.00	6.97
WCDMA Band V Low Channel								
826.40	H	87.38	20.63	1.65	0.58	21.70	38.45	16.75
826.40	V	84.94	20.22	1.65	0.58	21.29	38.45	17.16
WCDMA Band V Middle Channel								
836.60	H	85.99	20.51	1.59	0.65	21.45	38.45	17.00
836.60	V	86.25	20.44	1.59	0.65	21.38	38.45	17.07
WCDMA Band V High Channel								
846.60	H	86.23	20.53	1.53	0.71	21.35	38.45	17.10
846.60	V	86.32	20.16	1.53	0.71	20.98	38.45	17.47

NOTE:We measured all modes and only recorded the worst case.

4.2 Peak-to-Average Ratio (PAR)

LIMIT

The Peak-to-Average Ratio (PAR) of the transmission may not exceed 13 dB.

TEST CONFIGURATION

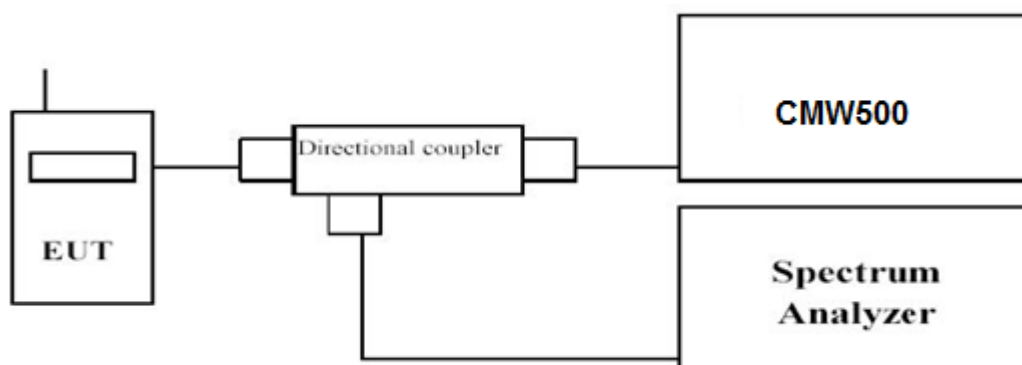

TEST PROCEDURE

1. Refer to instrument's analyzer instruction manual for details on how to use the power statistics/CCDF function;
2. Set resolution/measurement bandwidth \geq signal's occupied bandwidth;
3. Set the number of counts to a value that stabilizes the measured CCDF curve;
4. Set the measurement interval as follows:
 - 1). for continuous transmissions, set to 1 ms,
 - 2). for burst transmissions, employ an external trigger that is synchronized with the EUT burst tN/Ag sequence, or use the internal burst trigger with a trigger level that allows the burst to stabilize and set the measurement interval to a time that is less than or equal to the burst duration.
5. Record the maximum PAPR level associated with a probability of 0.1%.

TEST RESULTS

Temperature	24.5°C	Humidity	53.7%
Test Engineer	Jenny Zeng	Configurations	WCDMA

Remark:

We were tested all RB Configuration refer 3GPP TS134 121 for each Channel Bandwidth of WCDMA Band II, WCDMA Band IV, WCDMA Band V; recorded worst case for each Channel Bandwidth of WCDMA Band II, WCDMA Band IV, WCDMA Band V.

WCDMA :

Test Mode	Channel	Frequency (MHz)	PAPR Value (dB)	Limits (dB)	Verdict
UMTS/TM1/ WCDMA Band II	9262	1852.4	3.16	13.0	PASS
	9400	1880.0	3.28	13.0	PASS
	9538	1907.6	3.19	13.0	PASS
UMTS/TM1/ WCDMA Band IV	1312	1712.40	3.07	13.0	PASS
	1413	1732.60	2.49	13.0	PASS
	1513	1752.60	3.16	13.0	PASS
UMTS/TM1/ WCDMA Band V	4132	826.4	3.19	13.0	PASS
	4182	836.4	3.22	13.0	PASS
	4233	846.6	3.28	13.0	PASS

NOTE:We measured all modes and only recorded the worst case.

Peak-to-Average Ratio (PAR)

UMTS/TM1/ WCDMA Band II

UMTS/TM1/ WCDMA Band IV

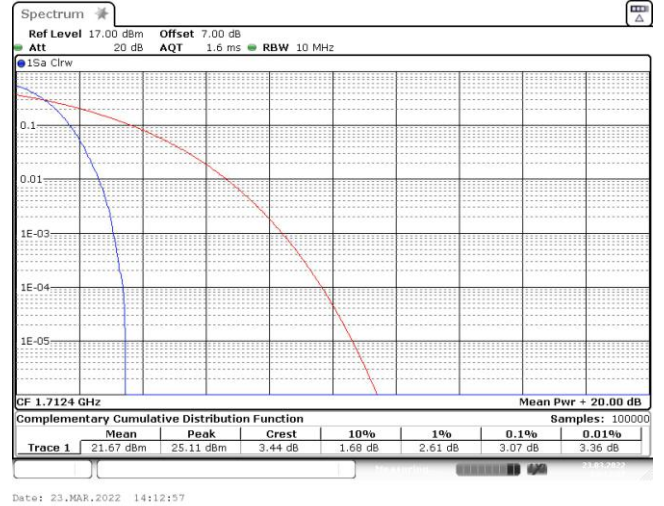
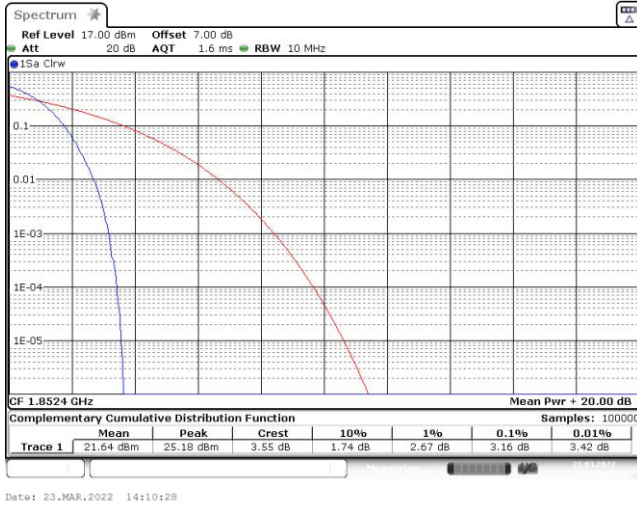

Date: 23.MAR.2022 14:10:28

Date: 23.MAR.2022 14:12:57

Channel 9262 / 1852.4 MHz

Channel 1312 / 1712.4 MHz



Date: 23.MAR.2022 14:09:16

Date: 23.MAR.2022 14:12:27

Channel 9400 / 1880.0 MHz

Channel 1413 / 1732.6 MHz

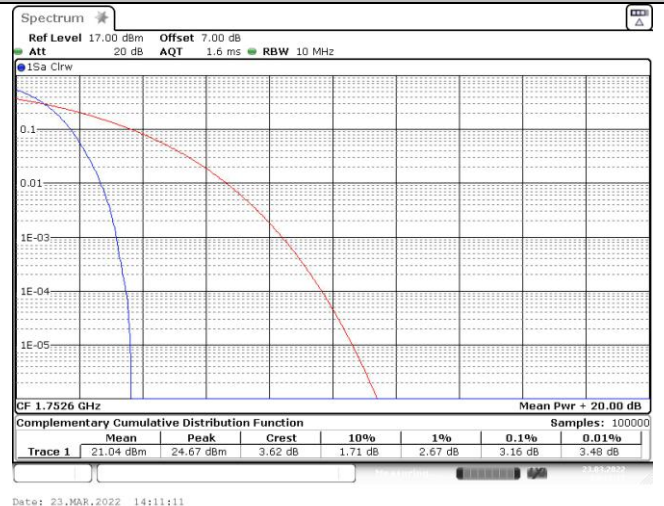
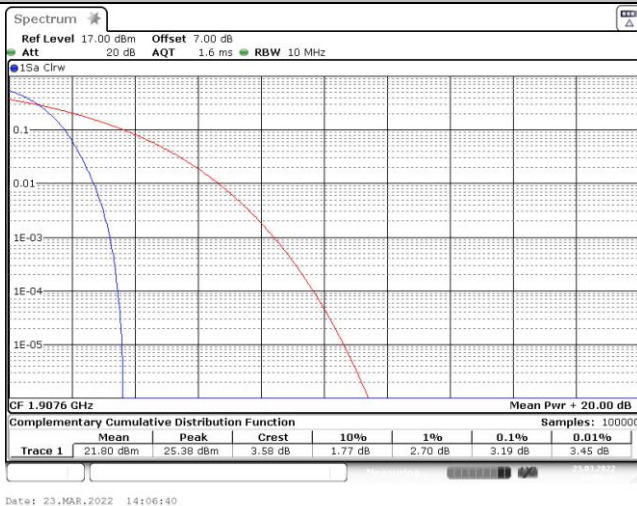

Date: 23.MAR.2022 14:06:40

Date: 23.MAR.2022 14:11:11

Channel 9538 / 1907.6 MHz

Channel 1513 / 1752.6 MHz

Peak-to-Average Ratio (PAR)

UMTS/TM1/ WCDMA Band V

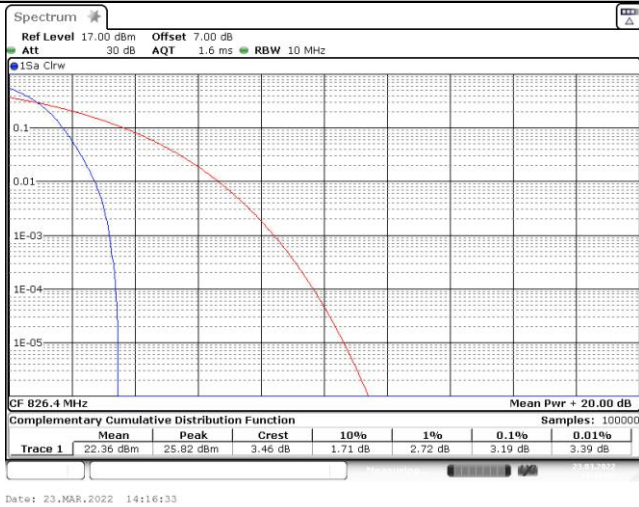

Channel 4132/ 826.4 MHz

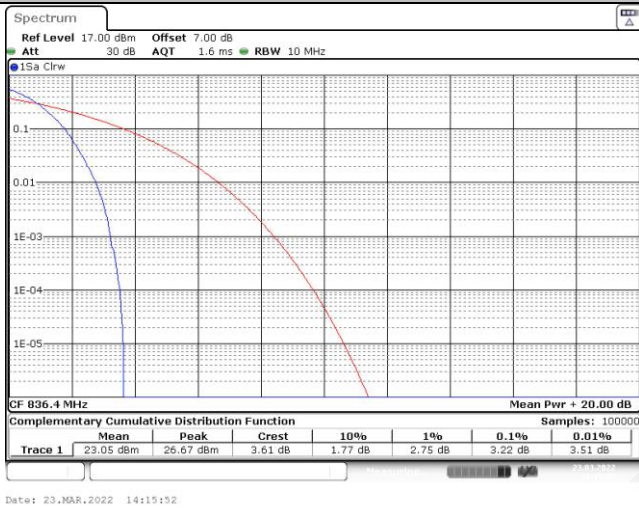

Channel 4182/ 836.4 MHz

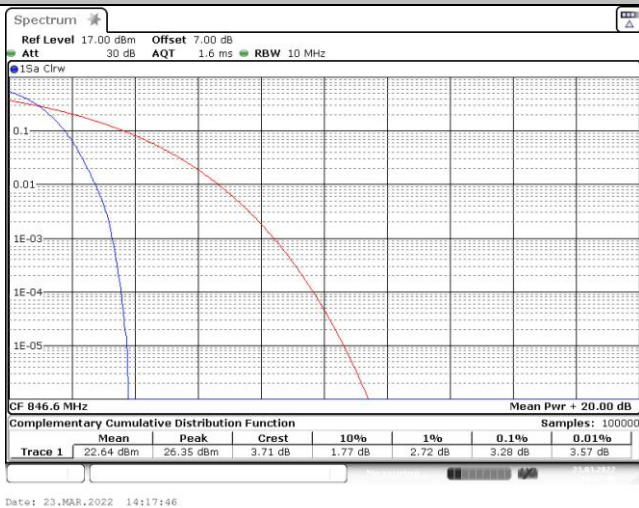

Channel 4233/ 846.6 MHz

NOTE:We measured all modes and only recorded the worst case.

4.3 Occupied Bandwidth and Emission Bandwidth

LIMIT

N/A

TEST CONFIGURATION

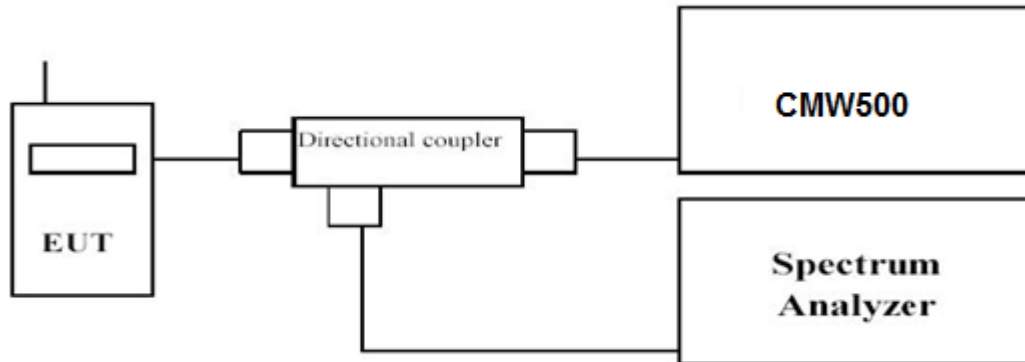

TEST PROCEDURE

The transmitter output was connected to a calibrated coaxial cable and coupler, the other end of which was connected to a spectrum analyzer. The occupied bandwidth was measured with the spectrum analyzer at low, middle and high channel in each band. The -26dBc Emission bandwidth was also measured and recorded. Set RBW was set to about 1% of emission BW, VBW≥3 times RBW. -26dBc display line was placed on the screen (or 99% bandwidth), the occupied bandwidth is the delta frequency between the two points where the display line intersects the signal trace.

TEST RESULTS

Temperature	24.5°C	Humidity	53.7%
Test Engineer	Jenny Zeng	Configurations	WCDMA

Remark:

We were tested all RB Configuration refer 3GPP TS134 121 for each Channel Bandwidth of WCDMA Band II, WCDMA Band IV, WCDMA Band V; recorded worst case for each Channel Bandwidth of WCDMA Band II, WCDMA Band IV, WCDMA Band V.

Test Mode	Channel	Frequency (MHz)	Occupied Bandwidth (99% BW) (MHz)	Emission Bandwidth (-26 dBc BW) (MHz)	Verdict
UMTS/TM1/ WCDMA Band II	9262	1852.4	4.1398	4.721	PASS
	9400	1880.0	4.1362	4.704	PASS
	9538	1907.6	4.1415	4.721	PASS
UMTS/TM1/ WCDMA Band IV	1312	1712.40	4.1344	4.713	PASS
	1413	1732.60	4.1511	4.743	PASS
	1513	1752.60	4.1227	4.716	PASS
UMTS/TM1/ WCDMA Band V	4132	826.4	4.1294	4.692	PASS
	4182	836.4	4.1471	4.697	PASS
	4233	846.6	4.1471	4.699	PASS

Remark:

1. Test results including cable loss;
2. Please refer to following plots;

Occupied Bandwidth & Emission Bandwidth

UMTS/TM1/ WCDMA Band II

UMTS/TM1/ WCDMA Band IV

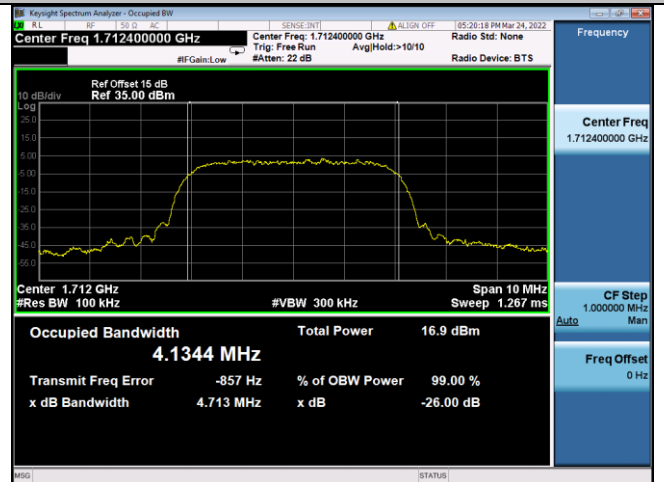
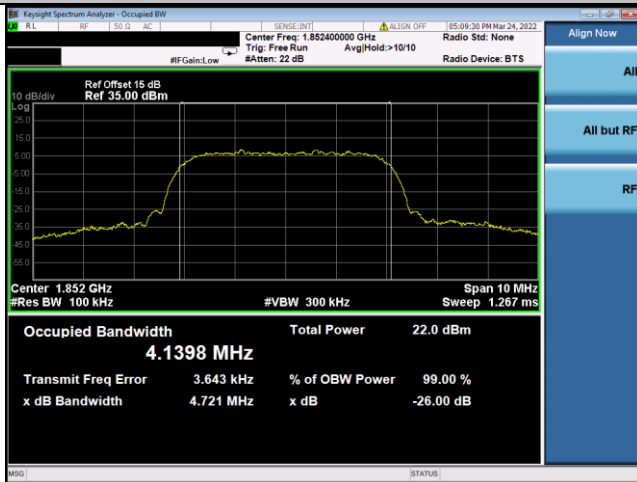

Channel 9262 / 1852.4 MHz

Channel 1312 / 1712.4 MHz

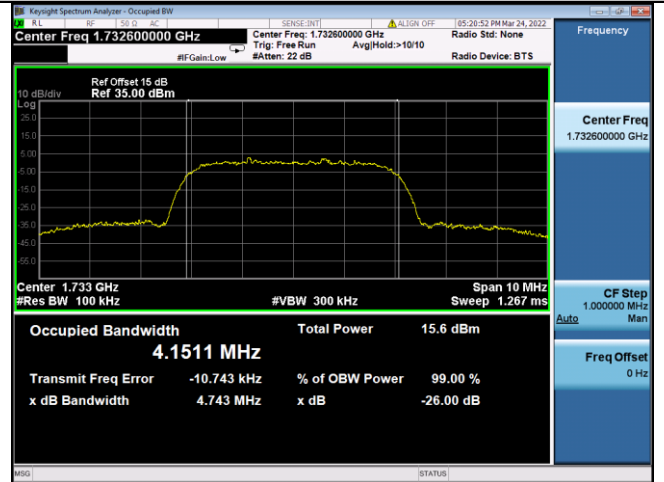
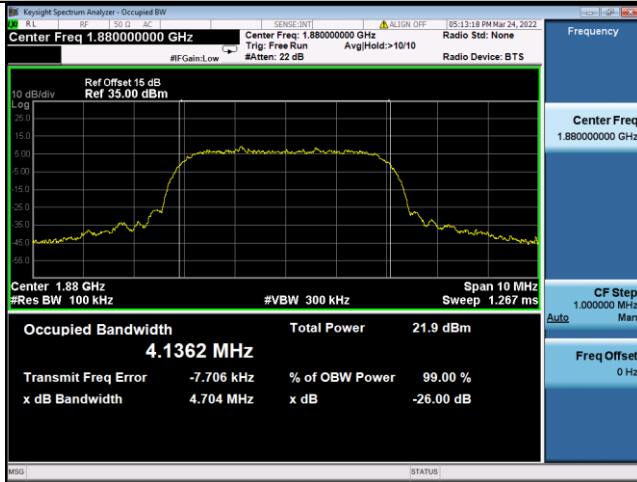

Channel 9400 / 1880.0 MHz

Channel 1413 / 1732.6 MHz

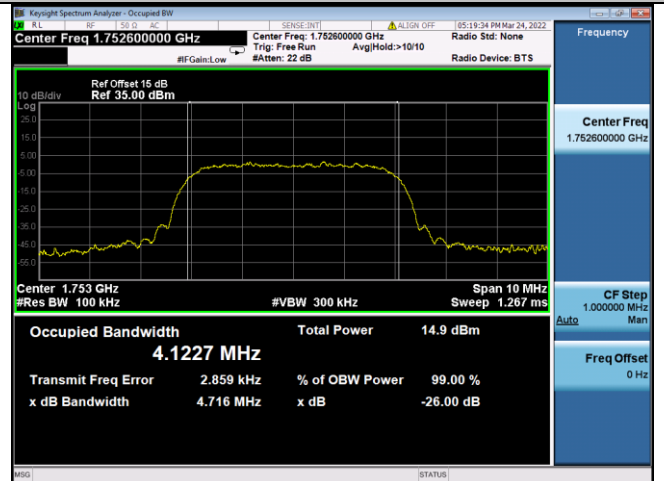
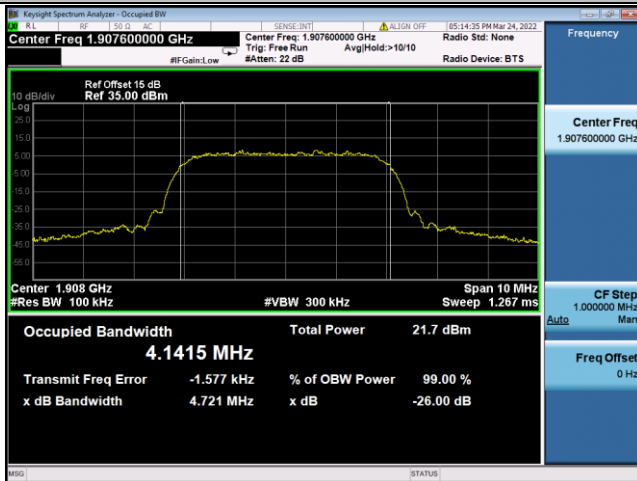

Channel 9538 / 1907.6 MHz

Channel 1513 / 1752.6 MHz

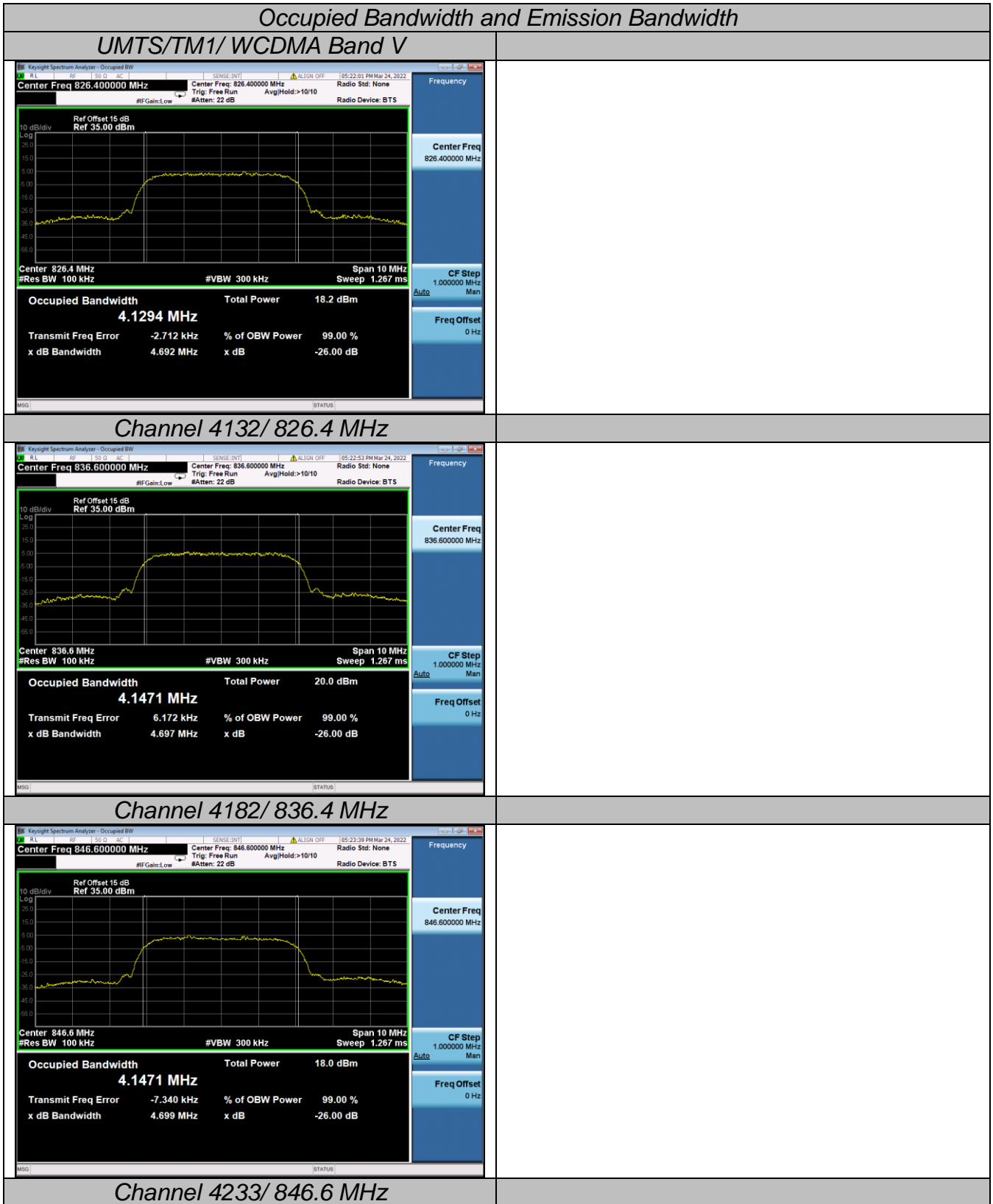

NOTE: We measured all modes and only recorded the worst case.

4.4 Band Edge compliance

LIMIT

FCC § 2.1053, §22.917, § 24.238 and § 27.53.

TEST CONFIGURATION

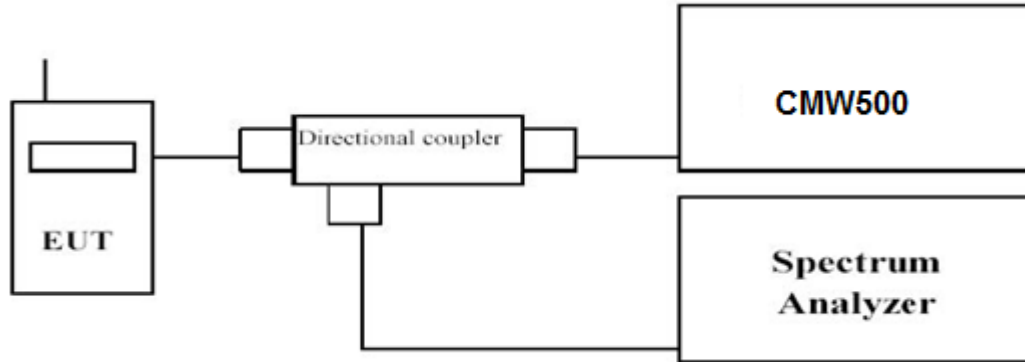

TEST PROCEDURE

1. The transmitter output port was connected to base station.
2. The RF output of EUT was connected to the power meter by RF cable and attenuator, the path loss was compensated to the results for each measurement.
3. Set EUT at maximum power through base station.
4. Select lowest and highest channels for each band and different modulation.
5. Measure Band edge using RMS (Average) detector by spectrum

TEST RESULTS

Temperature	24.5°C	Humidity	53.7%
Test Engineer	Jenny Zeng	Configurations	WCDMA

Remark:

We were tested all RB Configuration refer 3GPP TS134 121 for each Channel Bandwidth of WCDMA Band II, WCDMA Band IV, WCDMA Band V; recorded worst case for each Channel Bandwidth of WCDMA Band II, WCDMA Band IV, WCDMA Band V.

Test Mode	Channel	Frequency (MHz)	Band Edg Compliance (dBm)	Limits (dBm)	Verdict
UMTS/TM1/WCDMA Band II	9262	1852.40	<-13dBm	-13dBm	PASS
	9538	1907.60	<-13dBm	-13dBm	
UMTS/TM1/WCDMA Band IV	8562	1712.4	<-13dBm	-13dBm	PASS
	8763	1752.6	<-13dBm	-13dBm	
UMTS/TM1/WCDMA Band V	4132	826.40	<-13dBm	-13dBm	PASS
	4233	846.60	<-13dBm	-13dBm	

Remark:

1. Test results including cable loss;
2. Please refer to following plots;

Band-edge Compliance

UMTS/TM1/WCDMA Band II

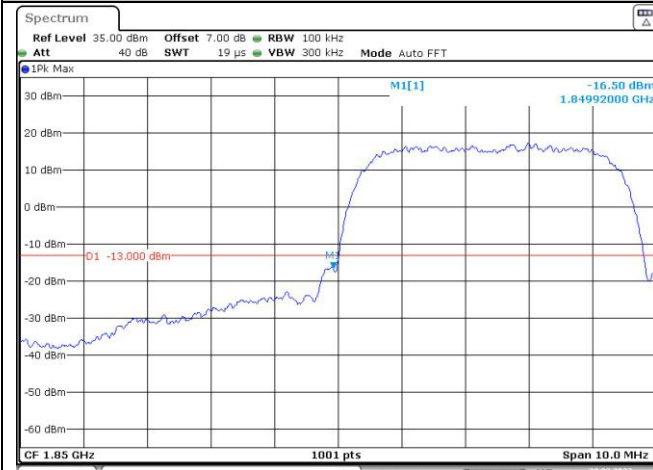

Date: 23.MAR.2022 11:32:48

UMTS/TM1/WCDMA Band IV

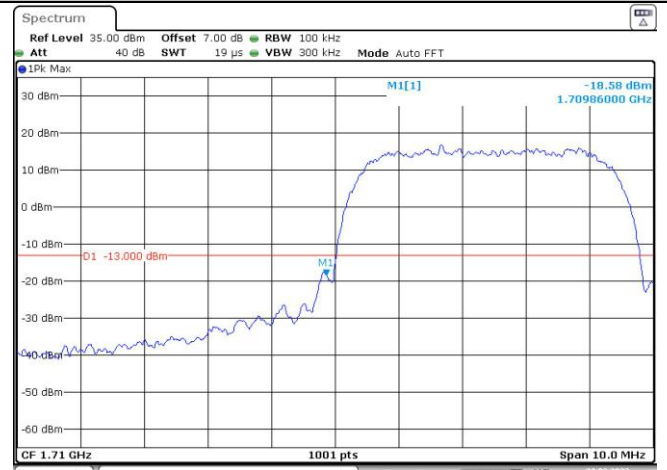

Date: 23.MAR.2022 11:38:16

Channel 9262 / 1852.4 MHz

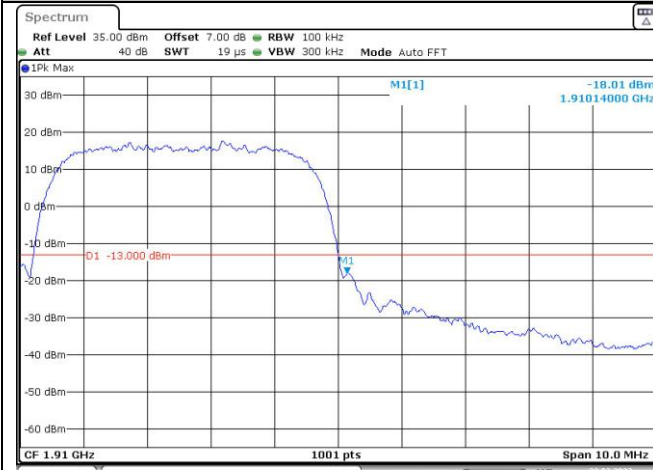

Date: 23.MAR.2022 11:36:06

Channel 8562 / 1712.4 MHz

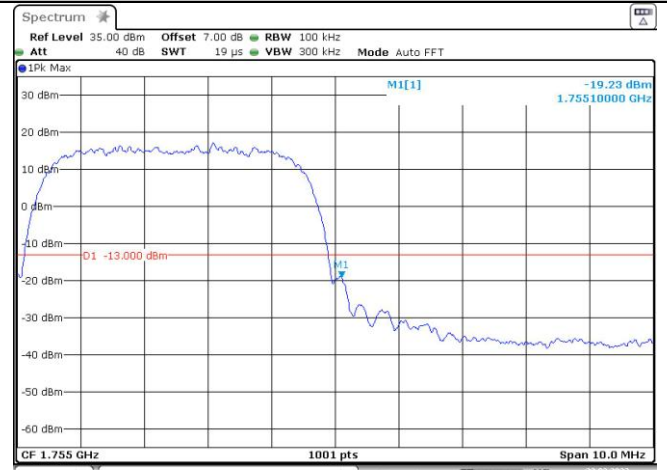

Date: 23.MAR.2022 11:41:43

Channel 9538 / 1907.6 MHz

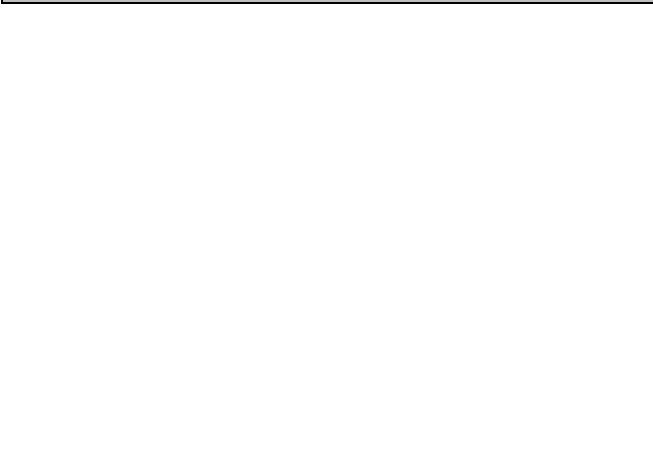

Date: 23.MAR.2022 11:36:06

Channel 8763 / 1752.6 MHz

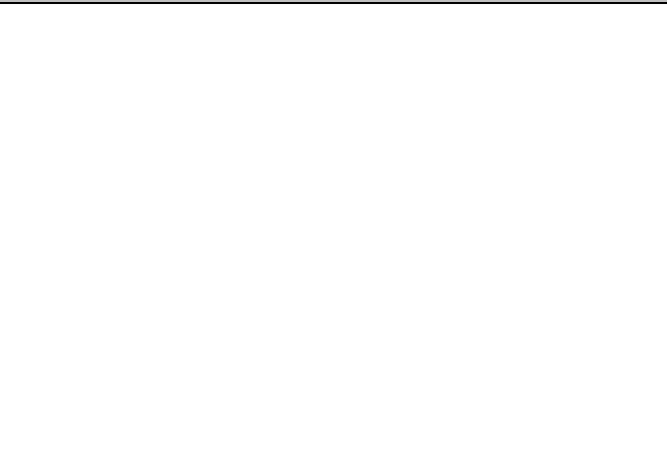

Date: 23.MAR.2022 11:41:43

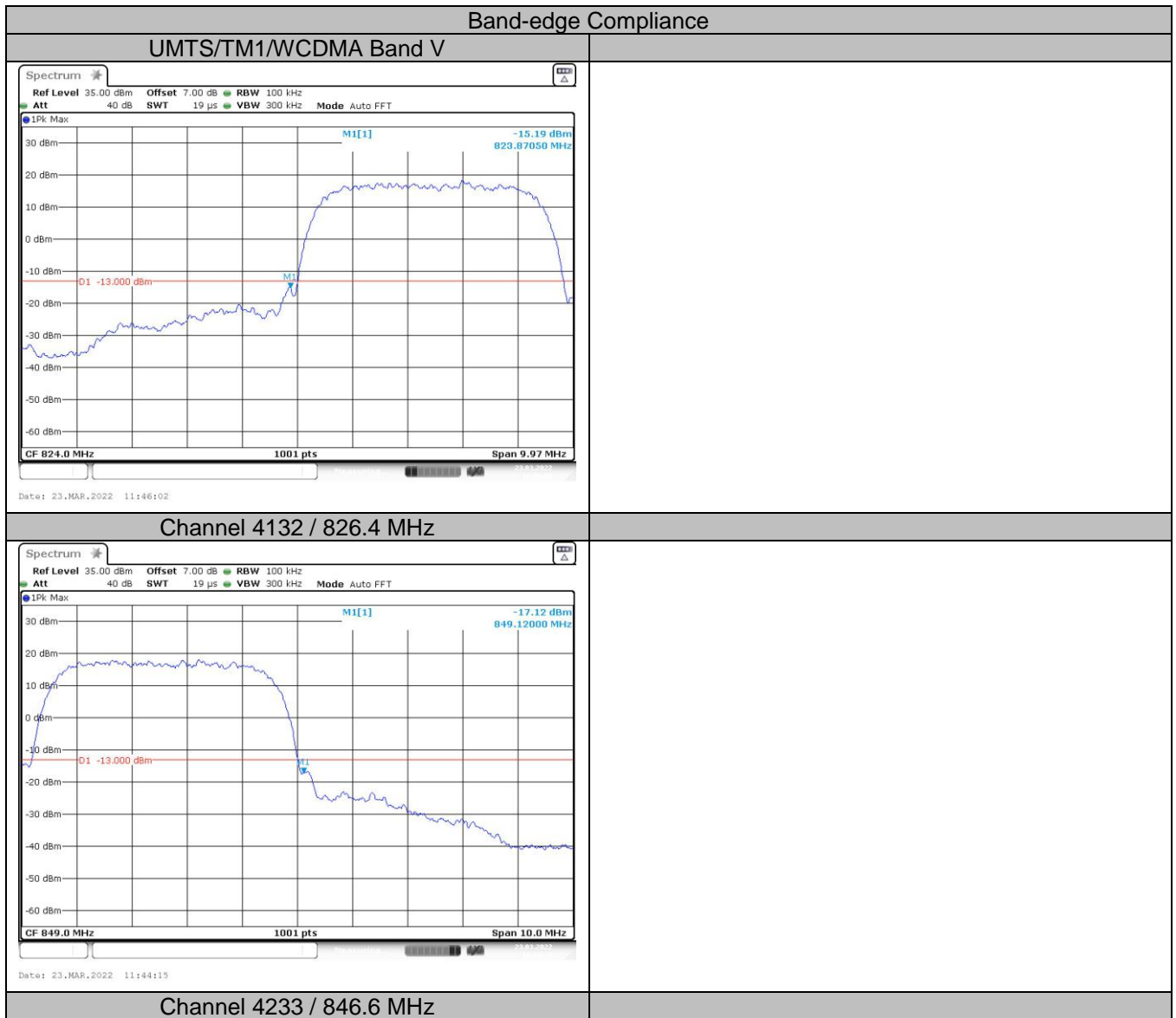

NOTE:We measured all modes and only recorded the worst case.

4.5 Spurious Emission

LIMIT

FCC § 2.1053, §22.917, § 24.238 and § 27.53.

TEST CONFIGURATION

Conducted Spurious Measurement:

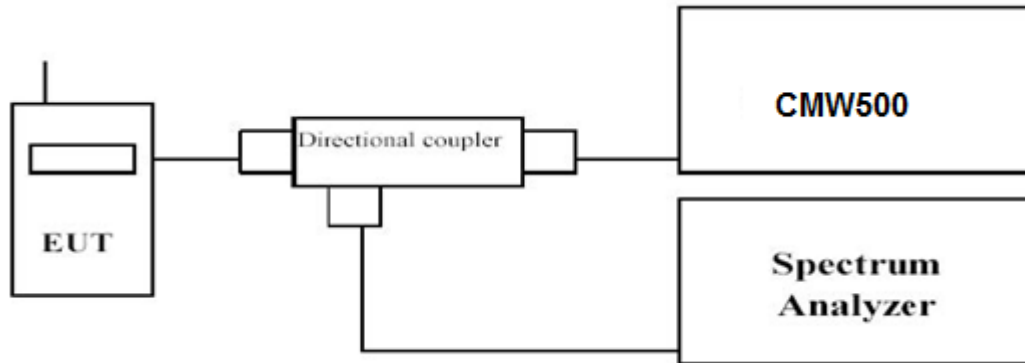

Radiated Spurious Measurement:

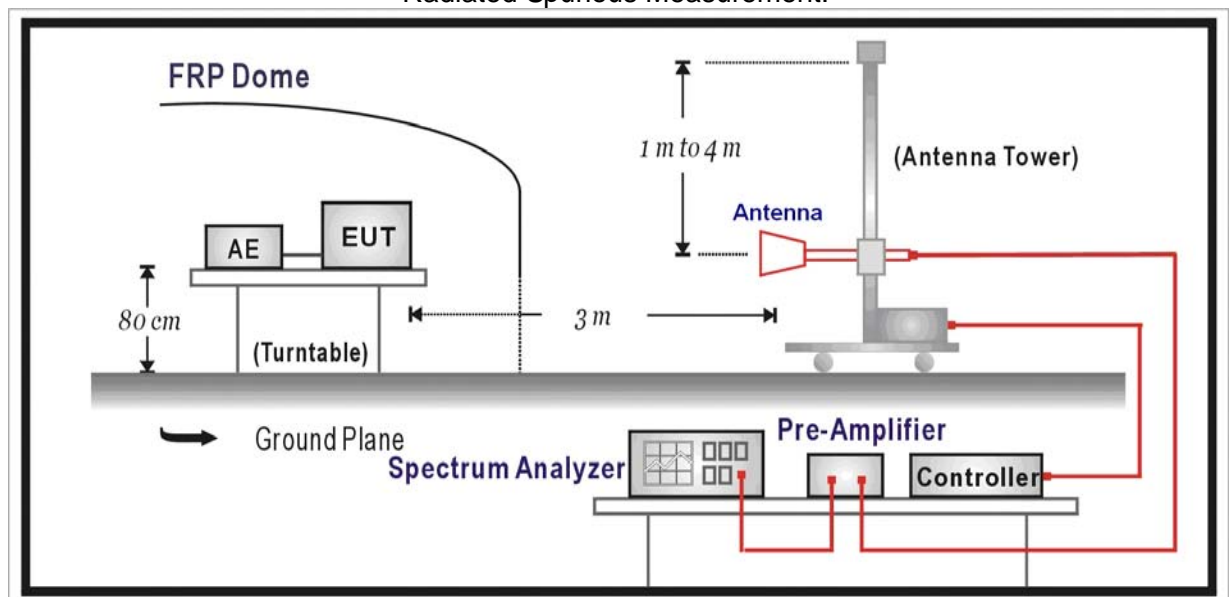

TEST PROCEDURE

The EUT was setup according to EIA/TIA 603-E

Conducted Spurious Measurement:

- Place the EUT on a bench and set it in transmitting mode.
- Connect a low loss RF cable from the antenna port to a spectrum analyzer and CMW500 by a Directional Coupler.
- EUT Communicate with CMW500, then select a channel for testing.
- Add a correction factor to the display of spectrum, and then test.
- The resolution bandwidth of the spectrum analyzer was set sufficient scans were taken to show the out of band Emission if any up to 10th harmonic.
- Please refer to following tables for test antenna conducted emissions.

Radiated Spurious Measurement:

- a. The EUT shall be placed at the specified height on a support, and in the position closest to normal use as declared by provider.
- b. The test antenna shall be oriented initially for vertical polarization and shall be chosen to correspond to the frequency of the transmitter
- c. The output of the test antenna shall be connected to the measuring receiver.
- d. The transmitter shall be switched on and the measuring receiver shall be tuned to the frequency of the transmitter under test.
- e. The test antenna shall be raised and lowered through the specified range of height until a maximum signal level is detected by the measuring receiver.
- f. The transmitter shall then be rotated through 360° in the horizontal plane, until the maximum signal level is detected by the measuring receiver.
- g. The test antenna shall be raised and lowered again through the specified range of height until a maximum signal level is detected by the measuring receiver.
- h. The maximum signal level detected by the measuring receiver shall be noted.
- i. The transmitter shall be replaced by a substitution antenna.
- j. The substitution antenna shall be orientated for vertical polarization and the length of the substitution antenna shall be adjusted to correspond to the frequency of the transmitter.
- k. The substitution antenna shall be connected to a calibrated signal generator.
- l. If necessary, the input attenuator setting of the measuring receiver shall be adjusted in order to increase the sensitivity of the measuring receiver.
- m. The test antenna shall be raised and lowered through the specified range of height to ensure that the maximum signal is received.
- n. The input signal to the substitution antenna shall be adjusted to the level that produces a level detected by the measuring receiver, that is equal to the level noted while the transmitter radiated power was measured, corrected for the change of input attenuator setting of the measuring receiver.
- o. The measurement shall be repeated with the test antenna and the substitution antenna orientated for horizontal polarization.
- p. The measure of the effective radiated power is the larger of the two levels recorded at the input to the substitution antenna, corrected for gain of the substitution antenna if necessary.
- q. The resolution bandwidth of the spectrum analyzer was set at 100 kHz for Part 22 and 1MHz for Part 24. The frequency range was checked up to 10th harmonic.
- r. Test site anechoic chamber refer to ANSI C63.4:2014.

TEST RESULTS

Temperature	24.5°C	Humidity	53.7%
Test Engineer	Jenny Zeng	Configurations	WCDMA

Conducted Measurement:

Remark:

We were tested all RB Configuration refer 3GPP TS134 121 for each Channel Bandwidth of WCDMA Band II, WCDMA Band IV, WCDMA Band V; recorded worst case for each Channel Bandwidth of WCDMA Band II, WCDMA Band IV, WCDMA Band V.

Test Mode	Channel	Frequency (MHz)	Spurious RF Conducted Emission (dBm)	Limits (dBm)	Verdict
UMTS/TM1/WCDMA Band II	9262	1852.4	<-13dBm	-13dBm	PASS
	9400	1880.0	<-13dBm	-13dBm	
	9538	1907.6	<-13dBm	-13dBm	
UMTS/TM1/WCDMA Band IV	1312	1712.40	<-13dBm	-13dBm	PASS
	1413	1732.60	<-13dBm	-13dBm	
	1513	1752.60	<-13dBm	-13dBm	
UMTS/TM1/WCDMA Band V	4132	826.4	<-13dBm	-13dBm	PASS
	4182	836.4	<-13dBm	-13dBm	
	4233	846.6	<-13dBm	-13dBm	

Remark:

1. Test results including cable loss;
2. Please refer to following plots;
3. We measured all modes and only recorded the worst case.

Spurious Emission on Antenna Port UMTS/TM1/WCDMA Band II

Channel 9262 / 1852.4 MHz

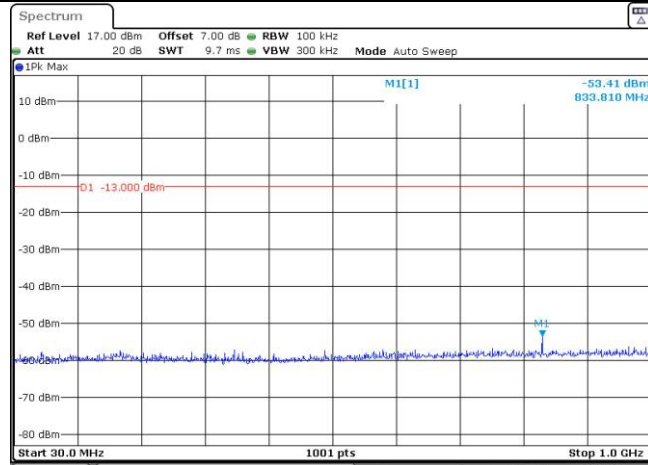

Date: 23.MAR.2022 11:51:43

Channel 9400 / 1880 MHz

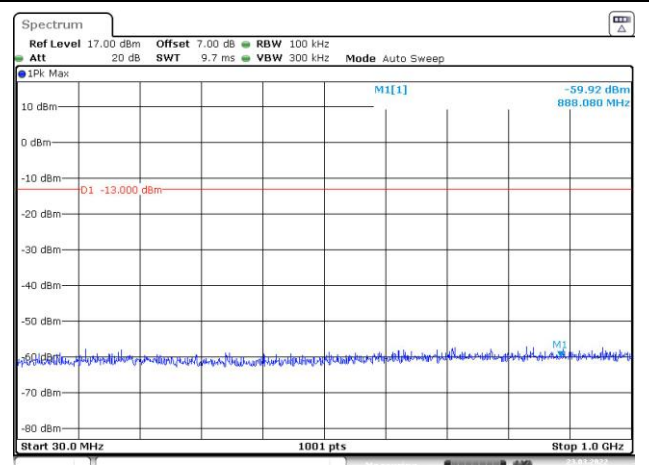

Date: 23.MAR.2022 11:57:01

30 MHz – 1000 MHz

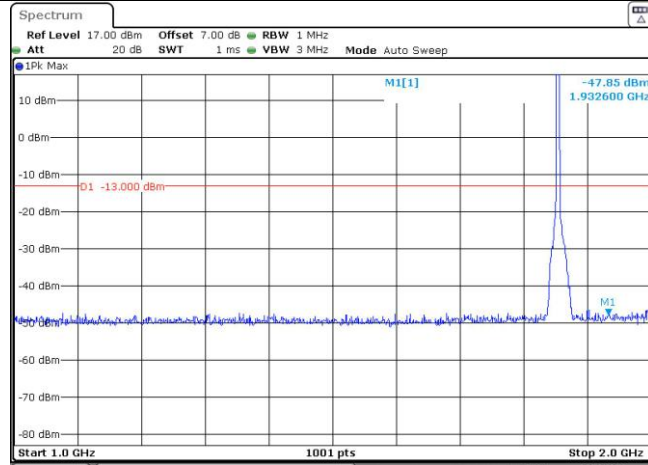

Date: 23.MAR.2022 11:52:52

30 MHz – 1000 MHz

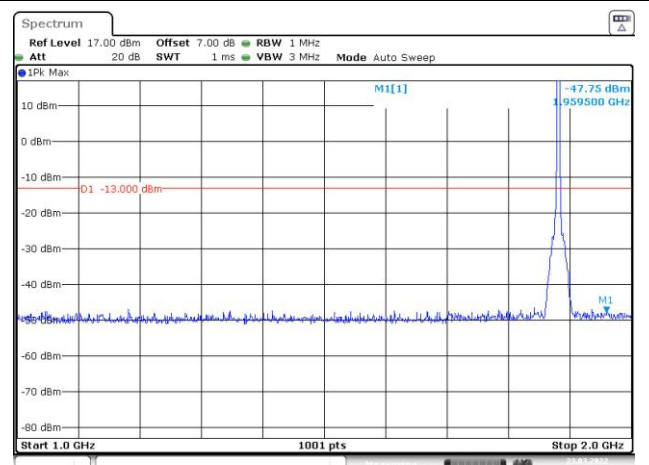

Date: 23.MAR.2022 11:56:04

1 GHz – 2 GHz

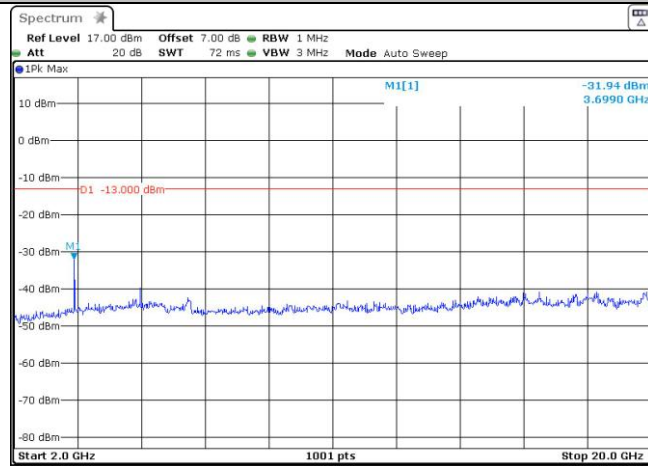

Date: 23.MAR.2022 11:53:41

1 GHz – 2 GHz

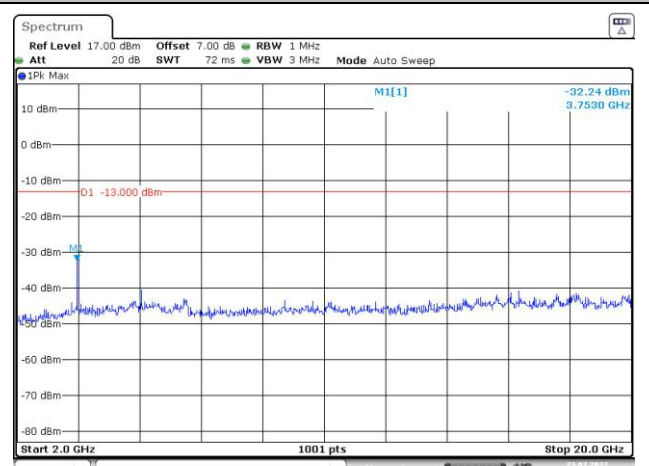

Date: 23.MAR.2022 11:55:03

2 GHz – 20 GHz

2 GHz – 20 GHz

Spurious Emission on Antenna Port

UMTS/TM1/WCDMA Band II
Channel 9538 / 1907.6 MHz

UMTS/TM1/WCDMA Band IV
Channel 1312 / 1712.4 MHz

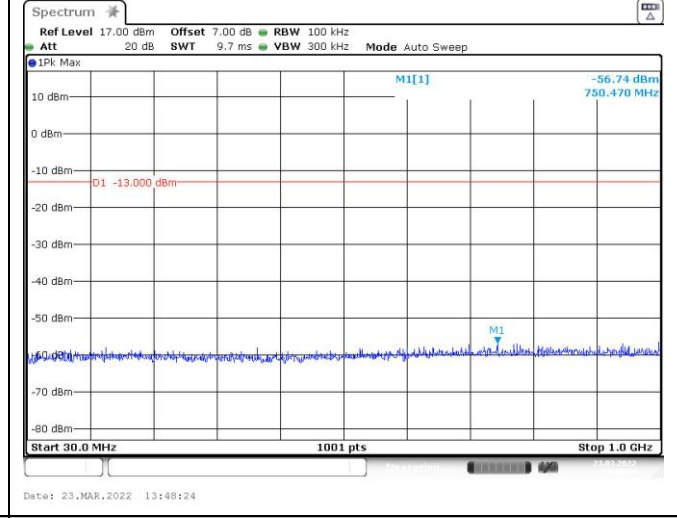
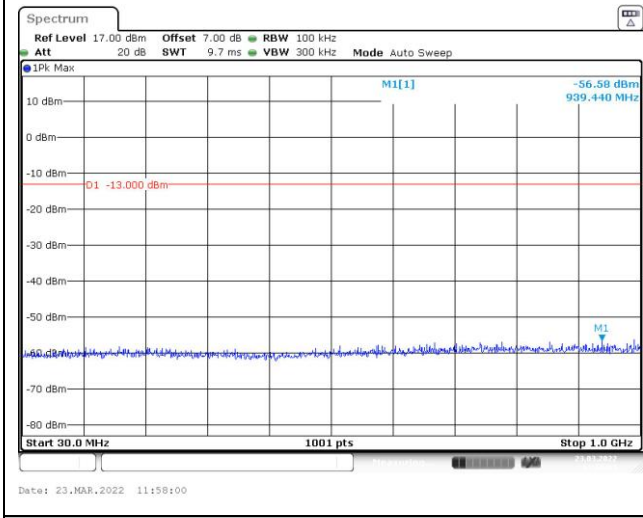

30 MHz – 1000 MHz

30 MHz – 1000 MHz

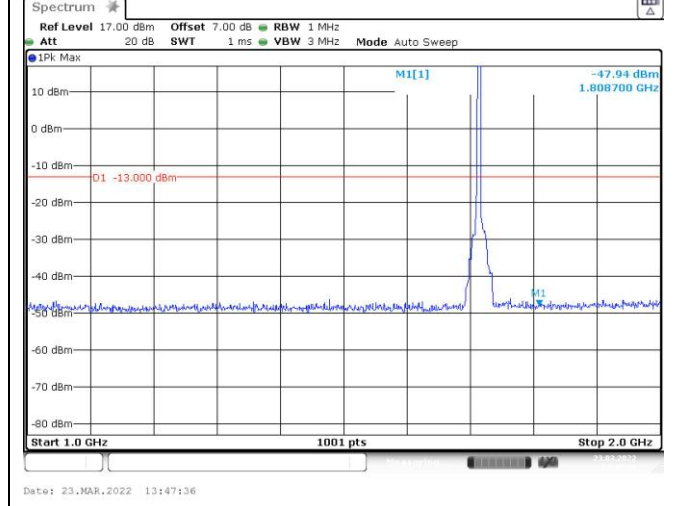
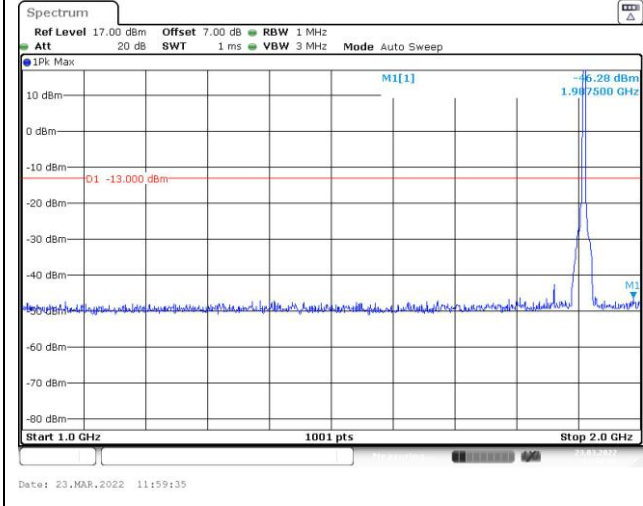

1 GHz – 2 GHz

1 GHz – 2 GHz

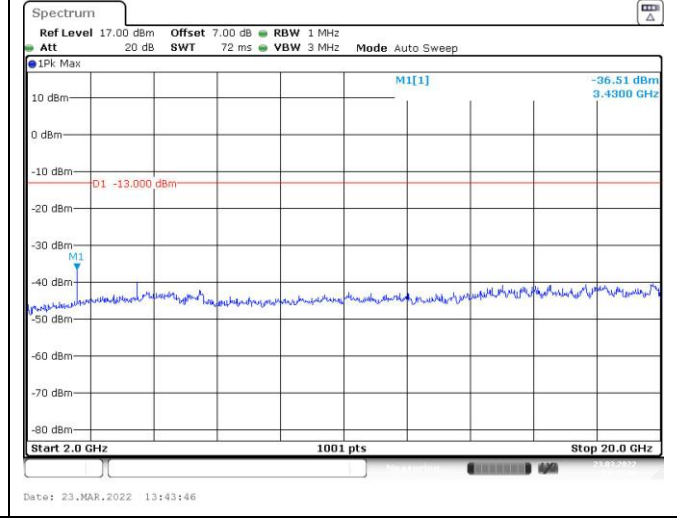
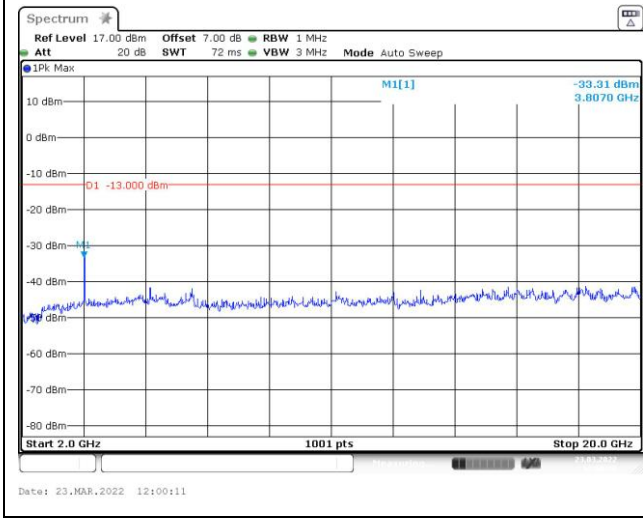

2 GHz – 20 GHz

2 GHz – 20 GHz

Spurious Emission on Antenna Port
UMTS/TM1/WCDMA Band IV

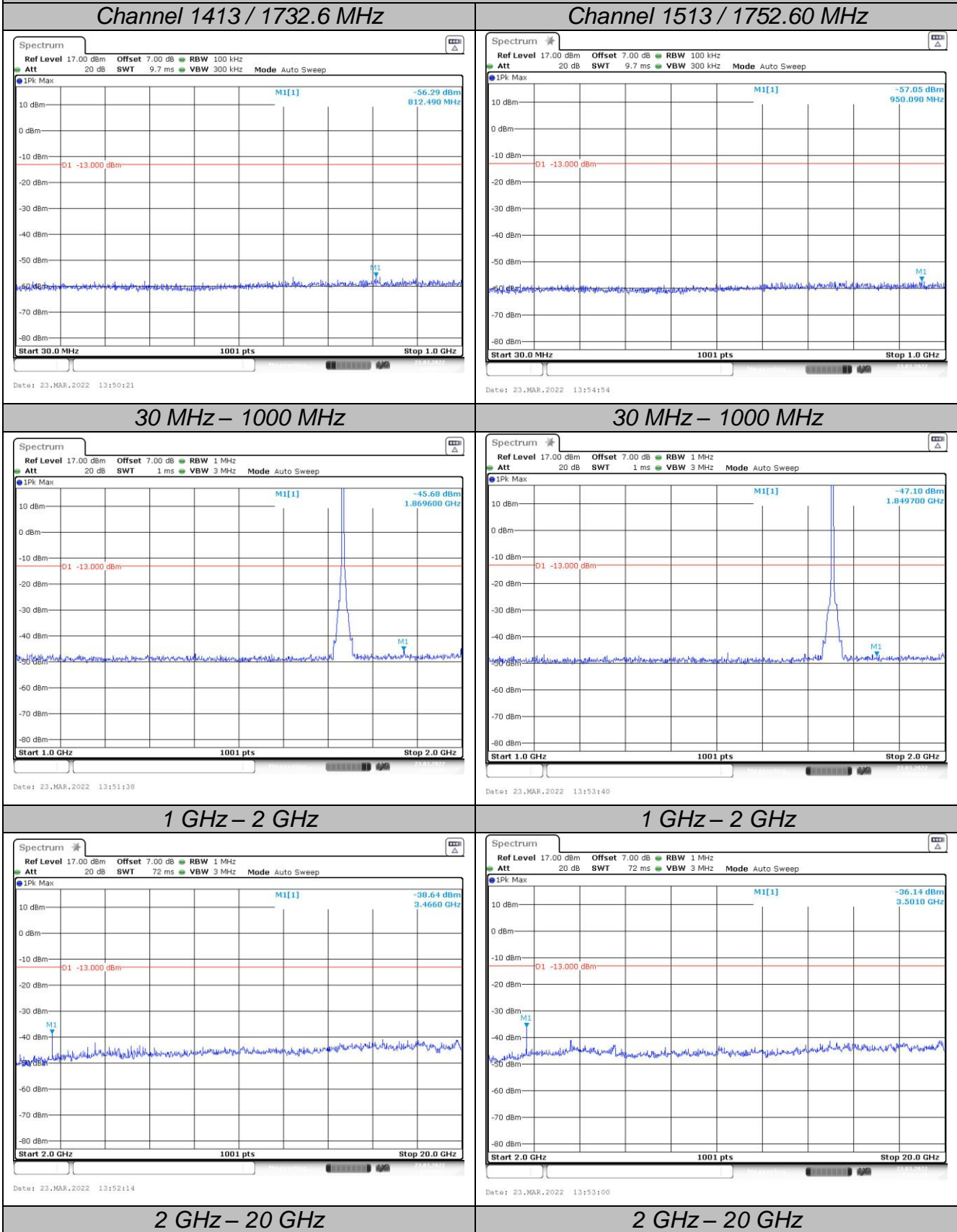

Spurious Emission on Antenna Port
UMTS/TM1/WCDMA Band V

Channel 4132 / 826.4 MHz

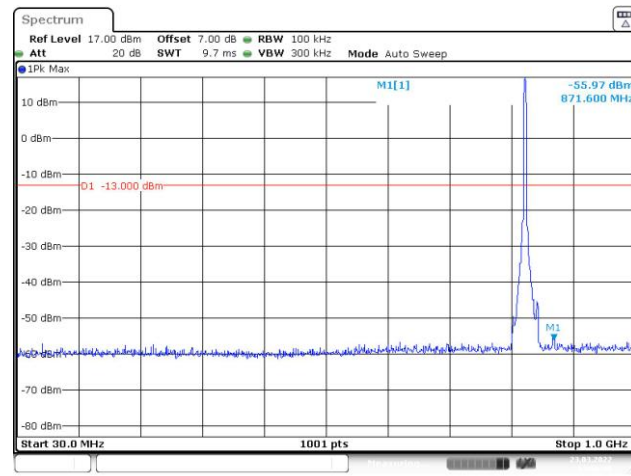

Channel 4182 / 836.4 MHz

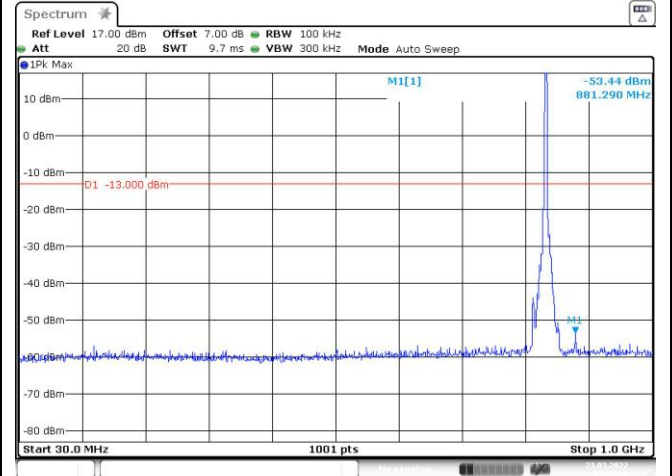

30 MHz – 1000 MHz

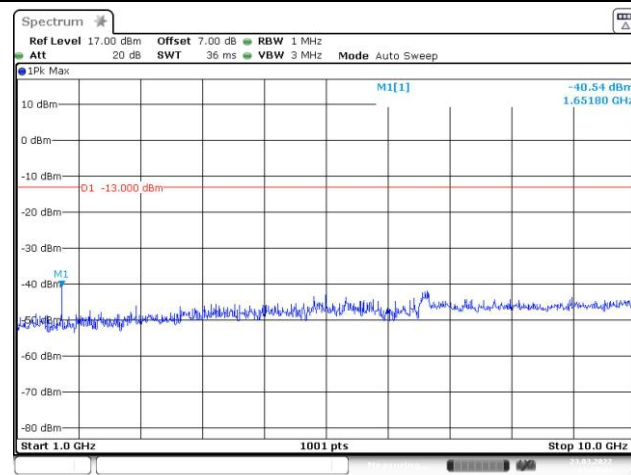

30 MHz – 1000 MHz

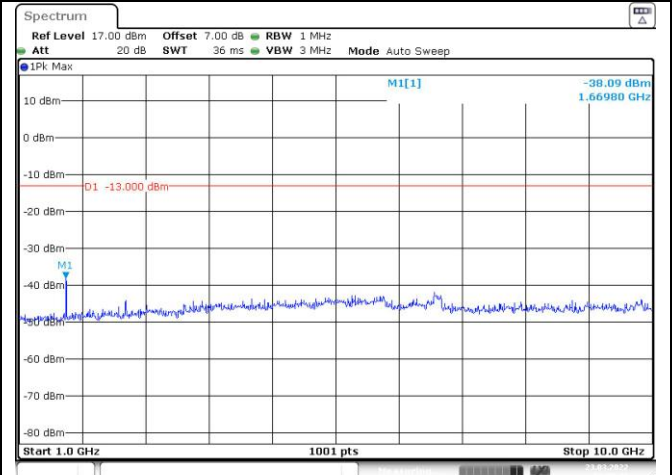

1 GHz – 10 GHz

1 GHz – 10 GHz

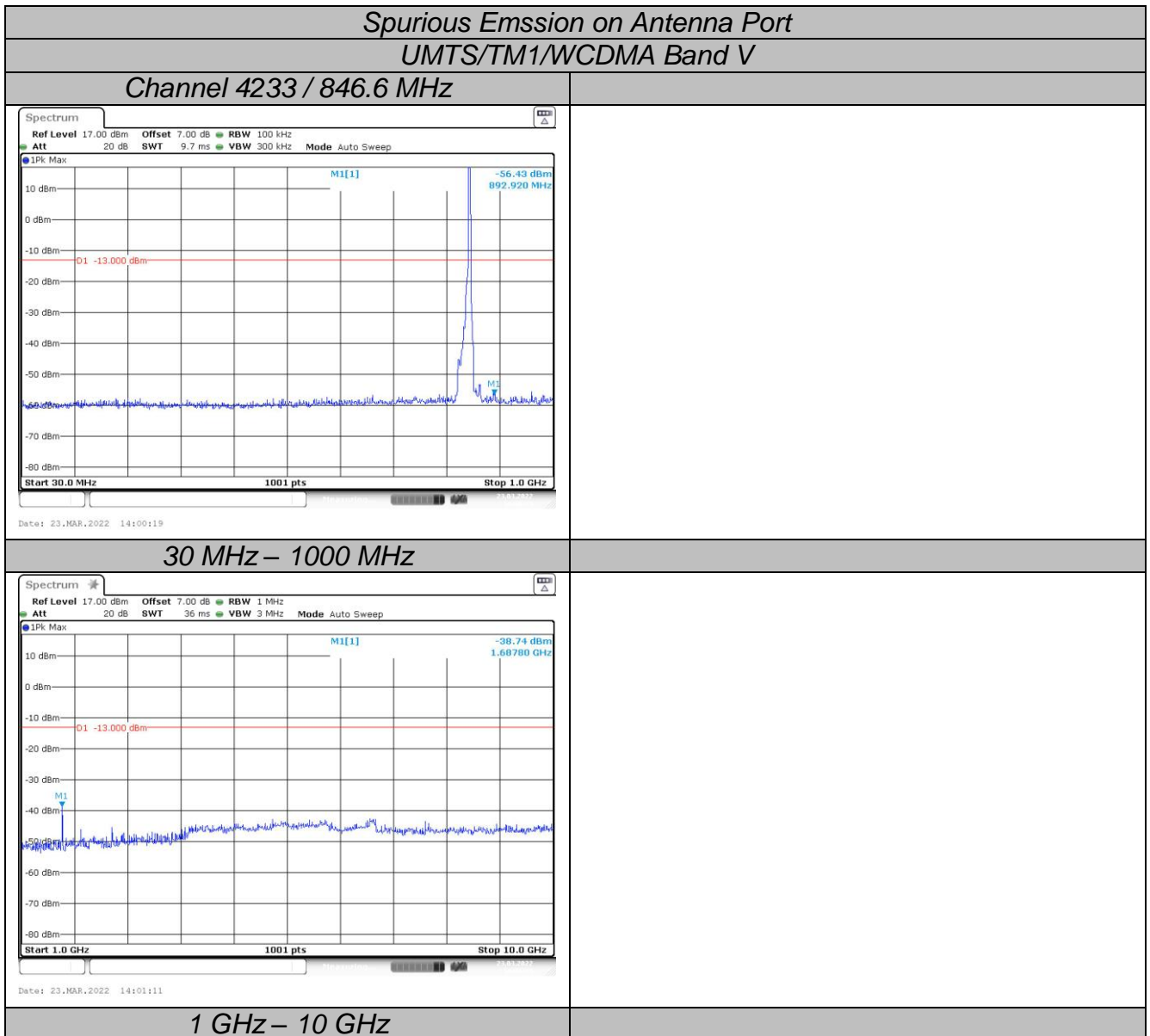

NOTE:We measured all modes and only recorded the worst case.

Radiated Measurement:

Remark:

We were tested all RB Configuration refer 3GPP TS134 121 for each Channel Bandwidth of WCDMA Band II, WCDMA Band IV, WCDMA Band V; recorded worst case for each Channel Bandwidth of WCDMA Band II, WCDMA Band IV, WCDMA Band V.

Temperature	24.5°C	Humidity	53.7%
Test Engineer	Jenny Zeng	Configurations	WCDMA

For Less than 1 GHz:*UMTS/TM1/ WCDMA Band II _ Low Channel*

Frequency (MHz)	P _{Mea} (dBm)	P _{cl} (dB)	Diatance	G _a Antenna Gain(dB)	Peak EIRP (dBm)	Limit (dBm)	Margin (dB)	Polarization
148.57	-45.83	3.70	3.00	8.52	-41.01	-13.00	-28.01	H
241.78	-45.77	4.48	3.00	6.89	-43.37	-13.00	-30.37	H
556.67	-41.72	3.88	3.00	8.66	-36.94	-13.00	-23.94	V
898.94	-43.41	4.38	3.00	7.18	-40.62	-13.00	-27.62	V

UMTS/TM1/ WCDMA Band II _ Middle Channel

Frequency (MHz)	P _{Mea} (dBm)	P _{cl} (dB)	Diatance	G _a Antenna Gain(dB)	Peak EIRP (dBm)	Limit (dBm)	Margin (dB)	Polarization
157.96	-45.78	4.00	3.00	8.60	-41.18	-13.00	-28.18	H
242.67	-46.66	4.20	3.00	7.09	-43.77	-13.00	-30.77	H
555.78	-42.89	4.00	3.00	8.60	-38.29	-13.00	-25.29	V
902.17	-44.68	4.37	3.00	7.14	-41.91	-13.00	-28.91	V

UMTS/TM1/ WCDMA Band II _ High Channel

Frequency (MHz)	P _{Mea} (dBm)	P _{cl} (dB)	Diatance	G _a Antenna Gain(dB)	Peak EIRP (dBm)	Limit (dBm)	Margin (dB)	Polarization
149.43	-47.55	3.95	3.00	8.54	-42.97	-13.00	-29.97	H
237.95	-45.95	4.18	3.00	6.98	-43.15	-13.00	-30.15	H
555.31	-44.57	4.06	3.00	8.45	-40.18	-13.00	-27.18	V
902.29	-45.03	4.44	3.00	6.85	-42.62	-13.00	-29.62	V

UMTS/TM1/ WCDMA Band IV _ Low Channel

Frequency (MHz)	P _{Mea} (dBm)	P _{cl} (dB)	Diatance	G _a Antenna Gain(dB)	Peak EIRP (dBm)	Limit (dBm)	Margin (dB)	Polarization
154.61	-45.85	3.87	3.00	8.73	-41.00	-13.00	-28.00	H
241.86	-45.93	4.22	3.00	6.82	-43.32	-13.00	-30.32	H
551.75	-42.03	3.92	3.00	8.74	-37.21	-13.00	-24.21	V
904.08	-43.47	4.33	3.00	6.85	-40.94	-13.00	-27.94	V

UMTS/TM1/ WCDMA Band IV _ Middle Channel

Frequency (MHz)	P _{Mea} (dBm)	P _{cl} (dB)	Diatance	G _a Antenna Gain(dB)	Peak EIRP (dBm)	Limit (dBm)	Margin (dB)	Polarization
151.71	-45.90	3.78	3.00	8.62	-41.06	-13.00	-28.06	H
238.15	-46.47	4.09	3.00	6.82	-43.74	-13.00	-30.74	H
556.07	-42.84	3.99	3.00	8.74	-38.08	-13.00	-25.08	V
897.41	-44.54	4.14	3.00	6.84	-41.84	-13.00	-28.84	V

UMTS/TM1/ WCDMA Band IV _ High Channel

Frequency (MHz)	P _{Mea} (dBm)	P _{cl} (dB)	Diatance	G _a Antenna Gain(dB)	Peak EIRP (dBm)	Limit (dBm)	Margin (dB)	Polarization
149.93	-47.50	3.94	3.00	8.71	-42.72	-13.00	-29.72	H
239.65	-45.96	4.38	3.00	6.93	-43.41	-13.00	-30.41	H
557.89	-44.52	3.88	3.00	8.62	-39.78	-13.00	-26.78	V
899.26	-45.13	4.22	3.00	6.80	-42.55	-13.00	-29.55	V

UMTS/TM1/ WCDMA Band V _ Low Channel

Frequency (MHz)	P _{Mea} (dBm)	P _{cl} (dB)	Diatance	G _a Antenna Gain(dB)	Peak EIRP (dBm)	Limit (dBm)	Margin (dB)	Polarization
151.45	-45.69	4.00	3.00	8.53	-41.16	-13.00	-28.16	H
234.91	-45.72	4.40	3.00	7.16	-42.96	-13.00	-29.96	H
554.85	-41.94	3.85	3.00	8.40	-37.40	-13.00	-24.40	V
897.45	-43.70	4.13	3.00	7.13	-40.70	-13.00	-27.70	V

UMTS/TM1/ WCDMA Band V _ Middle Channel

Frequency (MHz)	P _{Mea} (dBm)	P _{cl} (dB)	Diatance	G _a Antenna Gain(dB)	Peak EIRP (dBm)	Limit (dBm)	Margin (dB)	Polarization
156.16	-45.93	3.88	3.00	8.46	-41.36	-13.00	-28.36	H
243.22	-46.69	4.37	3.00	6.99	-44.08	-13.00	-31.08	H
557.85	-42.56	4.05	3.00	8.57	-38.04	-13.00	-25.04	V
902.72	-44.48	4.13	3.00	7.13	-41.48	-13.00	-28.48	V

UMTS/TM1/ WCDMA Band V _ High Channel

Frequency (MHz)	P _{Mea} (dBm)	P _{cl} (dB)	Diatance	G _a Antenna Gain(dB)	Peak EIRP (dBm)	Limit (dBm)	Margin (dB)	Polarization
156.33	-47.40	3.67	3.00	8.36	-42.71	-13.00	-29.71	H
240.01	-45.82	4.46	3.00	6.82	-43.46	-13.00	-30.46	H
553.94	-44.62	3.89	3.00	8.65	-39.86	-13.00	-26.86	V
904.01	-45.22	4.23	3.00	6.90	-42.54	-13.00	-29.54	V

For More than 1 GHZ:*UMTS/TM1/ WCDMA Band II _ Low Channel*

Frequency (MHz)	P _{Mea} (dBm)	P _{cl} (dB)	Diatance	G _a Antenna Gain(dB)	Peak EIRP (dBm)	Limit (dBm)	Margin (dB)	Polarization
3,704.44	-43.56	5.26	3.00	9.88	-38.94	-13.00	-25.94	H
5,557.18	-47.74	6.11	3.00	11.36	-42.49	-13.00	-29.49	H
3,705.71	-47.11	5.26	3.00	9.88	-42.49	-13.00	-29.49	V
5,557.30	-51.02	6.11	3.00	11.36	-45.77	-13.00	-32.77	V

UMTS/TM1/ WCDMA Band II _ Middle Channel

Frequency (MHz)	P _{Mea} (dBm)	P _{cl} (dB)	Diatance	G _a Antenna Gain(dB)	Peak EIRP (dBm)	Limit (dBm)	Margin (dB)	Polarization
3704.80	-43.56	5.26	3.00	9.88	-38.94	-13.00	-25.94	H
5557.20	-47.74	6.11	3.00	11.36	-42.49	-13.00	-29.49	H
3704.80	-47.11	5.26	3.00	9.88	-42.49	-13.00	-29.49	V
5557.20	-51.02	6.11	3.00	11.36	-45.77	-13.00	-32.77	V

UMTS/TM1/ WCDMA Band II _ High Channel

Frequency (MHz)	P _{Mea} (dBm)	P _{cl} (dB)	Diatance	G _a Antenna Gain(dB)	Peak EIRP (dBm)	Limit (dBm)	Margin (dB)	Polarization
3760.00	-42.96	5.32	3.00	10.03	-38.25	-13.00	-25.25	H
5640.00	-46.05	6.19	3.00	11.41	-40.83	-13.00	-27.83	H
3760.00	-46.89	5.32	3.00	10.03	-42.18	-13.00	-29.18	V
5640.00	-51.35	6.19	3.00	11.41	-46.13	-13.00	-33.13	V

UMTS/TM1/ WCDMA Band IV _ Low Channel

Frequency (MHz)	P _{Mea} (dBm)	P _{cl} (dB)	Diatance	G _a Antenna Gain(dB)	Peak EIRP (dBm)	Limit (dBm)	Margin (dB)	Polarization
3424.80	-50.16	4.62	3.00	9.81	-44.97	-13.00	-31.97	H
5137.20	-51.17	5.94	3.00	10.86	-46.25	-13.00	-33.25	H
3424.80	-52.11	4.62	3.00	9.81	-46.92	-13.00	-33.92	V
5137.20	-54.13	5.94	3.00	10.86	-49.21	-13.00	-36.21	V

UMTS/TM1/ WCDMA Band IV _ Middle Channel

Frequency (MHz)	P _{Mea} (dBm)	P _{cl} (dB)	Diatance	G _a Antenna Gain(dB)	Peak EIRP (dBm)	Limit (dBm)	Margin (dB)	Polarization
3465.20	-49.40	4.63	3.00	9.84	-44.19	-13.00	-31.19	H
5197.80	-51.25	5.94	3.00	10.86	-46.33	-13.00	-33.33	H
3465.20	-53.09	4.63	3.00	9.84	-47.88	-13.00	-34.88	V
5197.80	-54.66	5.94	3.00	10.86	-49.74	-13.00	-36.74	V

UMTS/TM1/ WCDMA Band IV _ High Channel

Frequency (MHz)	P _{Mea} (dBm)	P _{cl} (dB)	Diatance	G _a Antenna Gain(dB)	Peak EIRP (dBm)	Limit (dBm)	Margin (dB)	Polarization
3505.20	-51.88	4.65	3.00	9.90	-46.63	-13.00	-33.63	H
5257.80	-52.96	5.95	3.00	10.91	-48.00	-13.00	-35.00	H
3505.20	-53.75	4.65	3.00	9.90	-48.50	-13.00	-35.50	V
5257.80	-54.92	5.95	3.00	10.91	-49.96	-13.00	-36.96	V

UMTS/TM1/ WCDMA Band V _ Low Channel

Frequency (MHz)	P _{Mea} (dBm)	P _{cl} (dB)	Diatance	G _a Antenna Gain(dB)	Peak EIRP (dBm)	Limit (dBm)	Margin (dB)	Polarization
1652.80	-45.99	3.86	3.00	8.56	-41.29	-13.00	-28.29	H
2479.20	-47.12	4.29	3.00	6.98	-44.43	-13.00	-31.43	H
1652.80	-45.50	3.86	3.00	8.56	-40.80	-13.00	-27.80	V
2479.20	-48.70	4.29	3.00	6.98	-46.01	-13.00	-33.01	V

UMTS/TM1/ WCDMA Band V _ Middle Channel

Frequency (MHz)	P _{Mea} (dBm)	P _{cl} (dB)	Diatance	G _a Antenna Gain(dB)	Peak EIRP (dBm)	Limit (dBm)	Margin (dB)	Polarization
1672.80	-46.11	3.90	3.00	8.58	-41.43	-13.00	-28.43	H
2509.20	-46.69	4.32	3.00	6.80	-44.21	-13.00	-31.21	H
1672.80	-46.38	3.90	3.00	8.58	-41.70	-13.00	-28.70	V
2509.20	-49.56	4.32	3.00	6.80	-47.08	-13.00	-34.08	V

UMTS/TM1/ WCDMA Band V _ High Channel

Frequency (MHz)	P _{Mea} (dBm)	P _{cl} (dB)	Diatance	G _a Antenna Gain(dB)	Peak EIRP (dBm)	Limit (dBm)	Margin (dB)	Polarization
1693.20	-44.37	3.91	3.00	9.06	-39.22	-13.00	-26.22	H
2539.80	-45.55	4.32	3.00	6.65	-43.22	-13.00	-30.22	H
1693.20	-46.13	3.91	3.00	9.06	-40.98	-13.00	-27.98	V
2539.80	-47.98	4.32	3.00	6.65	-45.65	-13.00	-32.65	V

Notes:

- 1.All channel bandwidth were tested,the report recorded the worst data.
2. $EIRP = P_{Mea}(dBm) - P_{cl}(dB) + P_{Ag}(dB) + G_a(dBi)$
3. $ERP = EIRP - 2.15dBi$ as EIRP by subtracting the gain of the dipole.
4. Margin = EIRP – Limit
5. We measured all modes and only recorded the worst case.

4.6 Frequency Stability under Temperature & Voltage Variations

LIMIT

FCC § 2.1055 (a), § 2.1055 (d), §22.355, §24.235,§27.54.

TEST CONFIGURATION

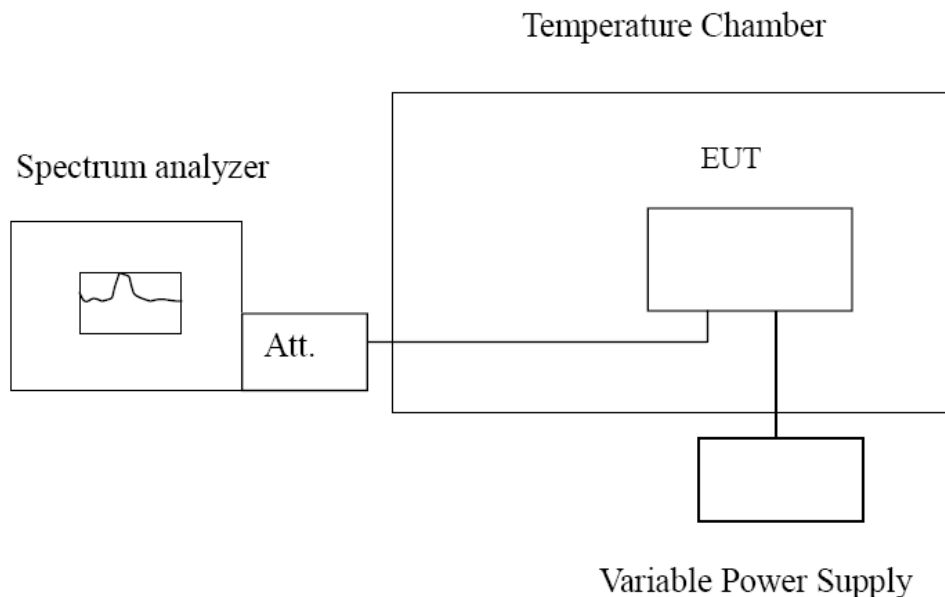

TEST PROCEDURE

The EUT was setup according to EIA/TIA 603D

Frequency Stability Under Temperature Variations:

In order to measure the carrier frequency under the condition of AFC lock, it is necessary to make measurements with the EUT in a "call mode". This is accomplished with the use of R&S CMW500 DIGITAL RADIO COMMUNICATION TESTER.

1. Measure the carrier frequency at room temperature.
2. Subject the EUT to overnight soak at -30°C.
3. With the EUT, powered via nominal voltage, connected to the CMW500 and in a simulated call on middle channel for LTE band 5, measure the carrier frequency. These measurements should be made within 2 minutes of Powering up the EUT, to prevent significant self-warming.
4. Repeat the above measurements at 10°C increments from -30°C to +50°C. Allow at least 1.5 hours at each temperature, unpowered, before making measurements.
5. Re-measure carrier frequency at room temperature with nominal voltage. Vary supply voltage from minimum voltage to maximum voltage, in 0.1Volt increments re-measuring carrier frequency at each voltage. Pause at nominal voltage for 1.5 hours unpowered, to allow any self-heating to stabilize, before continuing.
6. Subject the EUT to overnight soak at +50°C.
7. With the EUT, powered via nominal voltage, connected to the CMW500 and in a simulated call on the centre channel, measure the carrier frequency. These measurements should be made within 2 minutes of Powering up the EUT, to prevent significant self-warming.
8. Repeat the above measurements at 10 °C increments from +50°C to -30°C. Allow at least 1.5 hours at each temperature, unpowered, before making measurements
9. At all temperature levels hold the temperature to +/- 0.5°C during the measurement procedure.

Frequency Stability Under Voltage Variations:

Set chamber temperature to 20°C. Use a variable AC power supply / DC power source to power the EUT and set the voltage to rated voltage. Set the spectrum analyzer RBW low enough to obtain the desired frequency resolution and recorded the frequency.

Reduce the input voltage to specify extreme voltage variation ($\pm 15\%$) and endpoint, record the maximum frequency change.

TEST RESULTS

Remark:

We were tested all RB Configuration refer 3GPP TS134 121 for each Channel Bandwidth of WCDMA Band II, WCDMA Band IV, WCDMA Band V; recorded worst case for each Channel Bandwidth of WCDMA Band II, WCDMA Band IV, WCDMA Band V.

Temperature	24.5°C	Humidity	53.7%
Test Engineer	Jenny Zeng	Configurations	WCDMA

UMTS/TM1/WCDMA Band II					
DC Power	Temperature (°C)	Frequency error(Hz)	Frequency error(ppm)	Limit (ppm)	Verdict
DC 4.24V	25	-14	-0.007	±2.50	PASS
DC 3.47V	25	-18	-0.010	±2.50	PASS
DC 3.85V	25	12	0.006	±2.50	PASS
DC 3.85V	-30	-19	-0.010	±2.50	PASS
DC 3.85V	-20	14	0.007	±2.50	PASS
DC 3.85V	-10	7	0.004	±2.50	PASS
DC 3.85V	0	-1	-0.001	±2.50	PASS
DC 3.85V	10	14	0.007	±2.50	PASS
DC 3.85V	20	18	0.010	±2.50	PASS
DC 3.85V	30	-8	-0.004	±2.50	PASS
DC 3.85V	40	1	0.001	±2.50	PASS
DC 3.85V	50	-13	-0.007	±2.50	PASS

UMTS/TM1/WCDMA Band IV					
DC Power	Temperature (°C)	Frequency error(Hz)	Frequency error(ppm)	Limit (ppm)	Verdict
3.30	25	-8	-0.005	±2.50	PASS
3.70	25	-13	-0.007	±2.50	PASS
4.20	25	-7	-0.004	±2.50	PASS
3.70	-30	2	0.001	±2.50	PASS
3.70	-20	-4	-0.002	±2.50	PASS
3.70	-10	-13	-0.007	±2.50	PASS
3.70	0	-15	-0.009	±2.50	PASS
3.70	10	-5	-0.003	±2.50	PASS
3.70	20	-6	-0.003	±2.50	PASS
3.70	30	-9	-0.005	±2.50	PASS
3.70	40	-6	-0.003	±2.50	PASS
3.70	50	20	0.011	±2.50	PASS

UMTS/TM1/WCDMA Band V					
DC Power	Temperature (°C)	Frequency error(Hz)	Frequency error(ppm)	Limit (ppm)	Verdict
DC 4.24V	25	0	0.000	±2.50	PASS
DC 3.47V	25	-19	-0.023	±2.50	PASS
DC 3.85V	25	-4	-0.005	±2.50	PASS
DC 3.85V	-30	-7	-0.008	±2.50	PASS
DC 3.85V	-20	3	0.004	±2.50	PASS
DC 3.85V	-10	6	0.007	±2.50	PASS
DC 3.85V	0	-17	-0.021	±2.50	PASS
DC 3.85V	10	-14	-0.017	±2.50	PASS
DC 3.85V	20	2	0.002	±2.50	PASS
DC 3.85V	30	13	0.016	±2.50	PASS
DC 3.85V	40	-12	-0.015	±2.50	PASS
DC 3.85V	50	10	0.012	±2.50	PASS

NOTE:We measured all modes and only recorded the worst case.

5 TEST SETUP PHOTOS OF THE EUT

Reference to the Test Report: GTS20220307015-1-5.

6 EXTERNAL AND INTERNAL PHOTOS OF THE EUT

Reference to the Test Report: GTS20220307015-1-1.

.....**End of Report**.....