

SEUIC Reference Manual

Instruction for Use of UTouch RFID Handheld Terminal

Version 1.5

Copyright Announcement

The information in this Manual is provided in the way of “maintaining its original form” and subject to change without prior notice.

SEUIC Company makes no warranty for the contents of this Manual, including but not limited to the warranty of implied merchantability and applicability for a particular purpose. SEUIC Company is not responsible for errors contained in this Manual and for accidental or incidental losses caused by the supply, implementation or use of this Manual or the examples in it.

Software copyright © 2019 -2021 SEUIC Company

This Manual contains ownership information protected by copyright. Copyright is reserved. Except as permitted by copyright law, no part of this Manual may be photocopied, reprinted, adapted or translated without the prior written permission of SEUIC company.

The copyright of this Manual and related application software is owned by SEUIC Company and protected by the Republic of China and international copyright law.

The brand names and product names mentioned in this Manual are the trade names, service marks, trademarks or registered trademarks of their respective owners.

If you need more product information and support, please contact our sales representative or inquire directly on our website.

SEUIC Technologies Co., Ltd.
No. 15, Xinghuo Road, High-tech Industrial Development Zone, Jiangsu Province
Post Code: 210061
Tel: 86-25-52261298
Fax: 86-25-52268995
Official Website of Enterprise: www.Seuic.com
Official Website of Products: www.ChinaAUTOID.com
Service Hotline: 400-677-0876
Service Email: AUTOID@seuic.com

- Document Release History

Version No.	Modification Content	Date of Modification	Modified by
V1.0	Initial release of Instruction in Chinese	20191104	
V1.1	Modify six views	20200401	Yao Guobao
V1.2	Modify the name	20200413	Yao Guobao
V1.3	Update picture	20200718	Kai Wang
V1.4	Update picture	20210803	Raining
V1.5	Update picture	20210812	Raining

Contents

Chapter I Instructions for Use.....	3
1.1 Precautions for Laser Scanning Engine.....	3
1.2 Safety Precautions.....	3
1.3 Maintenance Precautions.....	3
Chapter II Appearance Introduction.....	5
Chapter III Keyboard.....	8
Chapter IV Quick Start.....	10
4.1 First Use.....	10
4.2 Startup.....	10
4.3 Shutdown.....	10
4.4 Restart.....	10
4.5 Install SIM Card.....	10
4.6 Install Micro SD Card.....	11
4.7 Install Battery.....	11
Chapter V About Charging.....	13
5.1 Charging Time.....	13
5.2 Charging Temperature.....	13
5.3 Battery Power Supply.....	13
5.4 Precautions for Use of Battery.....	13
5.5 LED Indicator Lamp.....	14
Chapter VI Main Screen.....	15
6.1 Status Bar Icon.....	15
Chapter VII Settings.....	17
7.1 WLAN.....	17
7.2 Bluetooth.....	19
7.3 SIM Card.....	22
7.4 Traffic Usage Status.....	22
7.5 More.....	23
7.5.1 Flight Mode.....	24
7.5.2 NFC.....	24
7.5.3 Android Beam.....	24
7.5.4 Network Sharing and Portable Hotspot.....	24
7.5.5 VPN.....	25
7.5.6 Mobile Network.....	26
7.5.7 Reset Network Settings.....	28
7.6 Display.....	29
7.7 Notification.....	32

7.8 Sound.....	32
7.9 Application.....	33
7.10 Storage.....	34
7.11 Battery.....	35
7.12 Location Information.....	36
7.13 Security.....	36
7.14 Account.....	37
7.15 Language and Input Method.....	38
7.16 Backup and Resetting.....	39
7.17 Date and Time.....	40
7.18 Barrier Free.....	40
7.20 Developer Option.....	41
7.21 About Cell Phone.....	42
Chapter VIII Introduction to Typical Application.....	44
8.1 Scanning Tools.....	44
8.2 UHF.....	49
8.3 System Upgrade.....	55
8.4 Quick Configuration.....	57
8.4.1 Import.....	58
8.4.2 Export.....	62
8.5 Feature Settings.....	64
8.5.1 Touch Screen Glove Mode.....	65
8.5.2 Disable Status Drop-down.....	65
8.5.3 Shield Virtual Key 1.....	65
8.5.4 Shield Virtual Key 2.....	66
Shield Virtual Key 3.....	66
8.5.6 Disable Transferring the Key Value of Scan Key to Application.....	66
8.5.7 Display Scan Hover Button.....	66
8.5.8 Disable Drop Detection.....	67
8.6 Digital Certificate White List.....	67
Chapter IX Troubleshooting.....	71
Introduction to Optional Accessories.....	73

Chapter I Instructions for Use

1.1 Precautions for Laser Scanning Engine



Laser radiation. Please do not look directly at the laser beam.

1.2 Safety Precautions

- Only the battery and charger designated by our company can be used for your device; the use of other products may cause battery liquid leakage, overheating, burst and fire.
- It is forbidden to short-circuit the charger; otherwise, it will cause electric shock, smoking and damage to the charger.
- Please do not use the charger when the power cord is damaged, or it will cause fire and electric shock.
- Please do not disassemble or modify the charger; otherwise, personal injury, electric shock, fire and charger damage will be caused.
- When pulling the plug, hold the charger. Pulling the power cord will damage the wire and cause electric shock and fire.
- Clean the device, battery and charger with a soft dry cloth.
- Please do not use alcohol, diluent, benzene or other solution to wipe the device.

1.3 Maintenance Precautions

- The product has the waterproof and dustproof function, but it shall be avoided to operate in extremely high-temperature, extremely low-temperature or wet environment. Please refer to the temperature and humidity standard of product specification.

- Press the screen hard, and the screen may be damaged. Please do not use the resistive touchscreen touch pen to click on the screen to avoid scratching or damaging the screen. To clean the screen, spray a small amount of commercial LCD screen cleaner on a soft cloth. Avoid spraying the cleaner directly on the screen.
- Please do not use any chemical cleaner to wipe the LCD screen.
- Keep the scanning window clean and free of stains, and do not use sharp objects to carve on it.
- If the product is not used for a long time, please download the data to the computer for storage.
- It takes quite a long time for the battery of the machine to complete charging when it is first used or recovered after storage.
- If any machine fault is found, please record the occurrence information and contact the maintenance personnel.

Chapter II Appearance Introduction

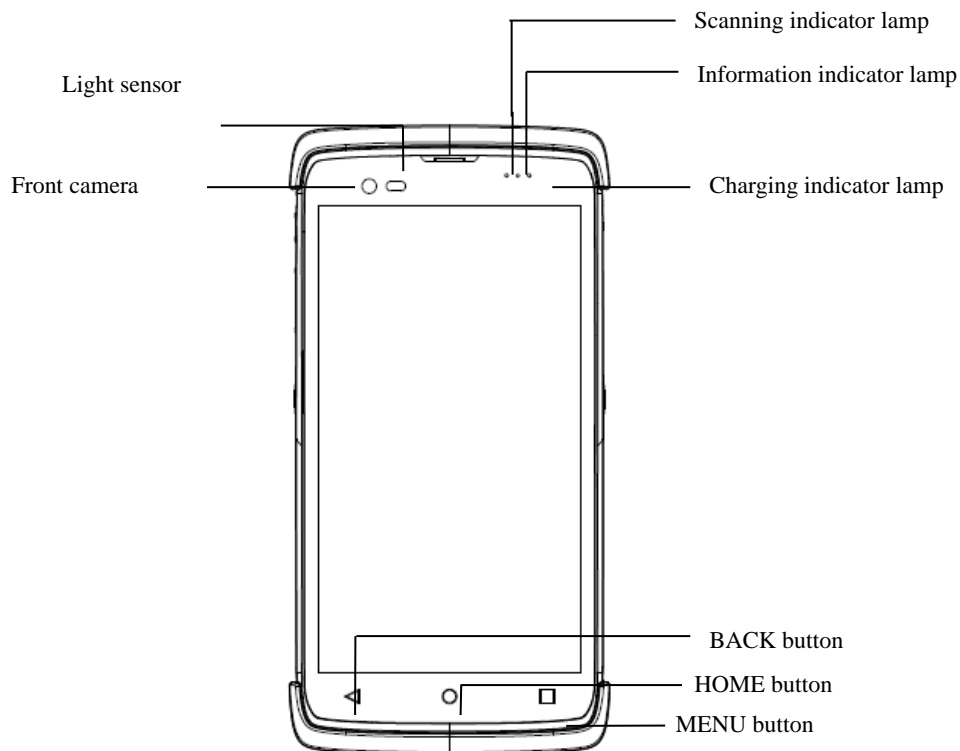

Figure 2-1 Front View

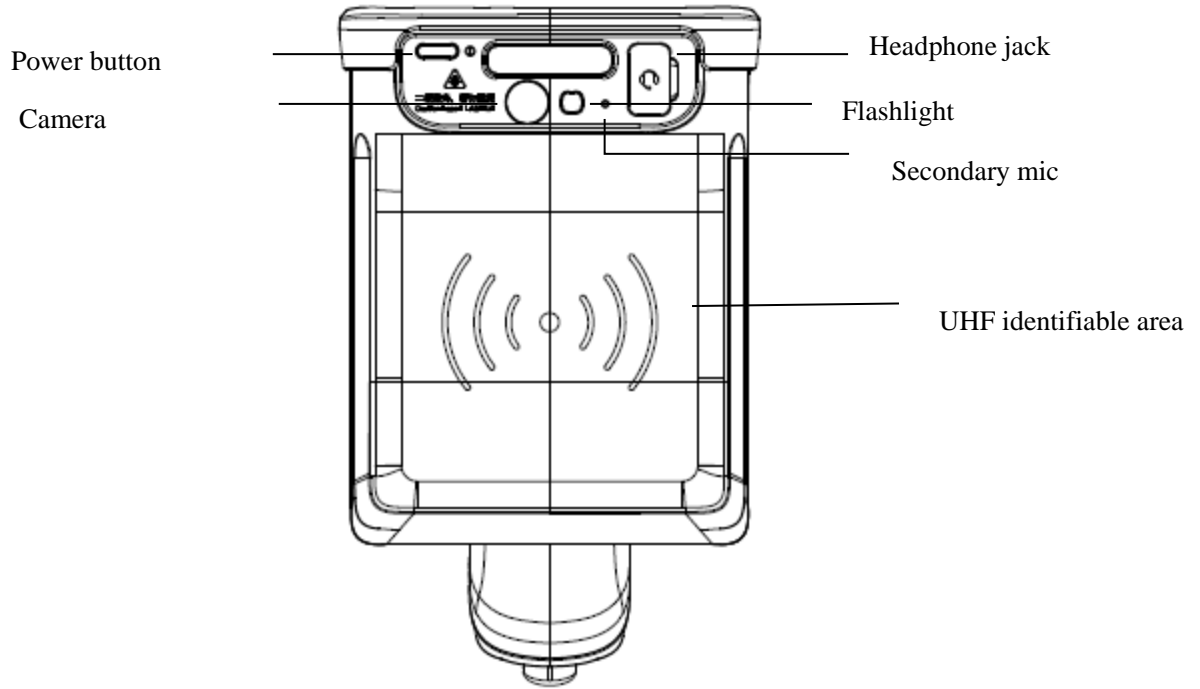

Figure 2-2 Front View

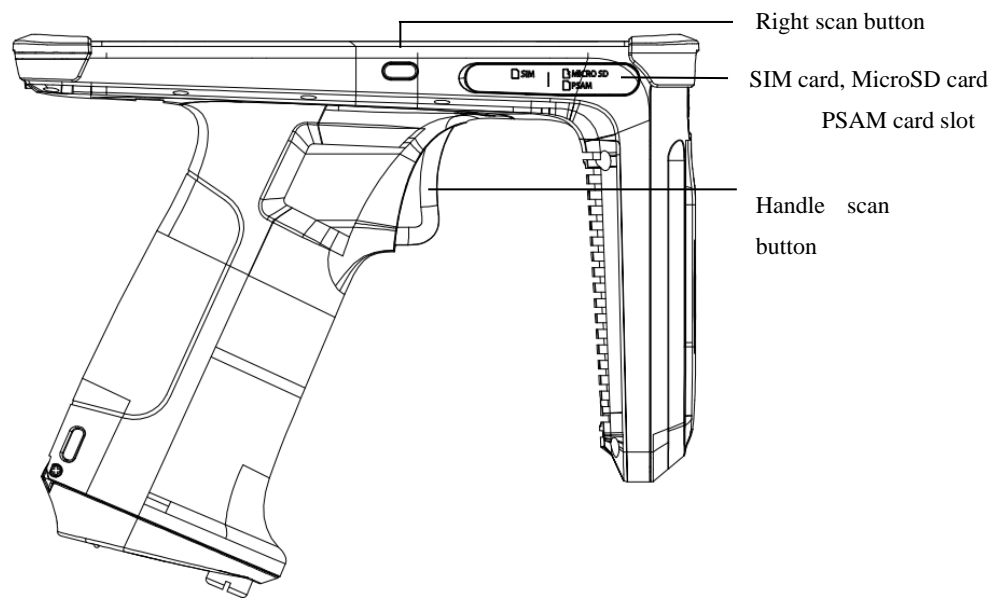

Figure 2-3 Side View

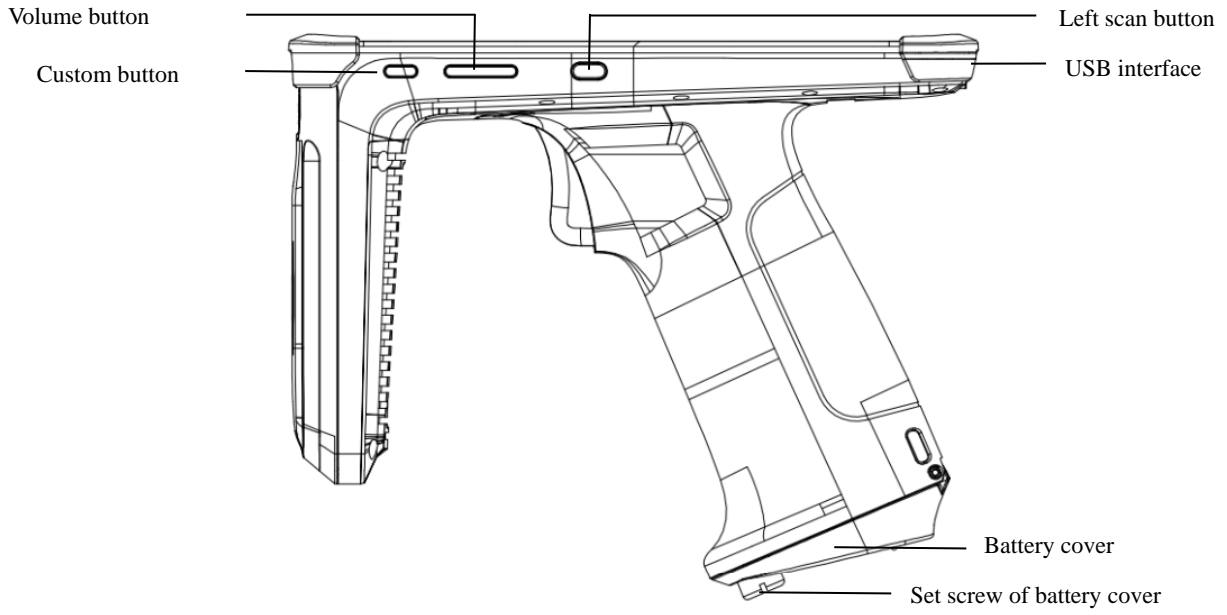

Figure 2-4 Side View

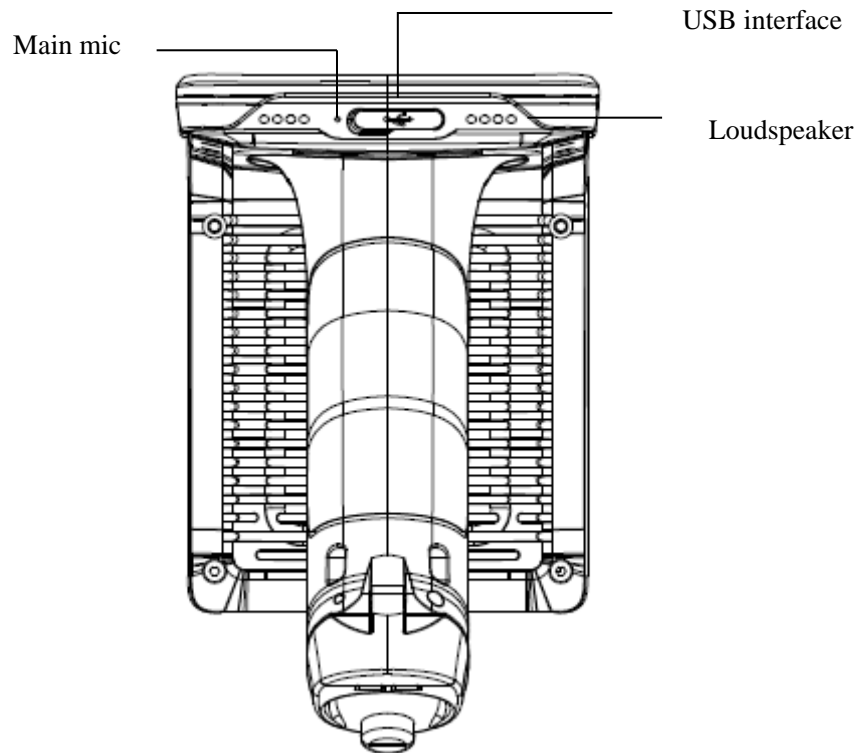

















Figure 2-5 Rear View

Chapter III Keyboard

UTouch RFID handheld terminal has 8 buttons in total, including 3 virtual buttons (Back, Home, Menu) on the screen touchpad, 4 buttons on the side (PPT button, volume button, left scan button and right scan button), and 1 scan button on the handle.

Description of buttons:

Table 3-1 Introduction to Buttons

Button	Main Function	Function Introduction
	Home button	Click  to go back to main screen.
	Menu button	Click  to open the task manager.
	Back button	Click  to go back to previous interface or exit the application. In the character input interface, click  to close the screen keyboard.
	Power button	Momentarily press  button in the standby state to put the device in sleep/wakeup mode; press and hold  button for 3S in shutdown state to start the device.
	Volume button	Press the upper half part of  button to increase the system volume; press the lower half part of  button to decrease the system volume.
	Left scan button	UHFscanning
	Right scan button	Barcode scanning
	Custom button	Reserve the custom button

	Handle scan button	In barcode mode, start barcode scanning In UHF mode, start/stop label stock-taking.
1. Screenshot shortcut key: Press power + volume down buttons at the same time.		

Chapter IV Quick Start

4.1 First Use

- Press and hold the power button for 3S to start the machine. In the working state of the system, press the Power button momentarily, and the device will enter the sleep state; in the sleep state, press the Power button momentarily, and the system will wake up and light up the screen.

4.2 Startup

- You can start the machine by pressing the Power button. In deep sleep mode, press the Power button momentarily to wake up the system. If the machine is powered by battery, it must be ensured that it has reliable contact with the battery.

4.3 Shutdown

- When the machine is started, in non-sleep state, press and hold the Power button for 2s, open the option menu, select Shutdown, click OK and the machine will be shut down normally.

4.4 Restart

- When the machine is started, in non-sleep state, press and hold the Power button for 2s, open the option menu, select Restart, click OK and the machine will be restarted normally.

4.5 Install SIM Card

- Please follow the following instructions to install SIM card:

- Insert SIM card in the direction shown in the figure below.

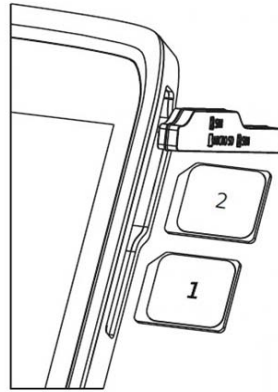

Figure 4-1 Insert SIM Card (1: SIM card, 2: PSAM card)

4.6 Install Micro SD Card

- Please follow the following instructions to install Micro SD card:
 - Insert SD card (microSD or microSDHC) in the direction shown in the figure below.

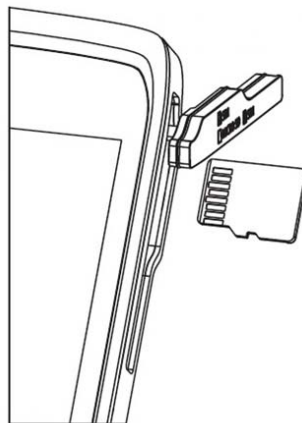

Figure 4-2 Insert SD Card

Note: The machine supports hot swapping of SD card.

4.7 Install Battery

- The battery of this product is of detachable design. Please follow the following steps to install the battery:
 - Unscrew the battery cover screw, open the battery cover and replace the

battery.

- Frequent battery replacement is not recommended.

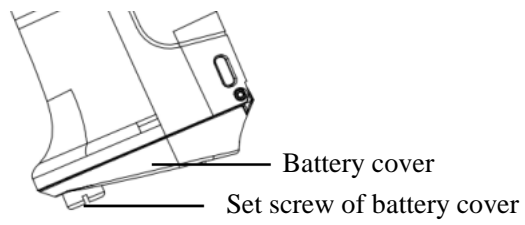

Figure 4-3 Battery Cover

Chapter V About Charging

- Since the battery only has a small amount of electricity for test when leaving the factory, you must charge the machine before use.

5.1 Charging Time

- Battery: It takes about 3 hours to charge the battery through the adapter at the first time. During charging, the LED light will be on in red, and when the battery is fully charged, the LED light will be on in green.

5.2 Charging Temperature

- The best operating temperature is room temperature, 18 ~ 25 °C.
- The battery will not be charged when the temperature is lower than - 10°C or higher than 55°C.

5.3 Battery Power Supply

- If the wireless network service or data acquisition program is opened, the battery power will be greatly lost. When these functions are not used, the power supply of these programs must be turned off to save electricity.
- Prompt: If the product is not used for a long time, please charge the whole machine at least once every two months.

5.4 Precautions for Use of Battery

- If the battery runs out, the machine may not be started immediately when the charger is just plugged in, which is a normal phenomenon. Please keep charging for a period of time, and then start the machine.
- The battery can be recharged, but the battery is consumable. If the standby time

of the device is greatly reduced, please replace it with a new battery.

- Battery charging time varies with temperature conditions and battery service conditions. Please charge the battery within a reasonable temperature range.
- When the battery power is insufficient, the low battery prompt will pop up by the device. When the battery level is too low, the device will automatically shut down.

5.5 LEDIndicator Lamp

- The LED indicator lamp in the middle of the upper right corner of the machine indicates the battery level and charging state of the machine by different colors:
 - ✧ When the USB, power adapter and charging connector are not plugged in, the red light will flash, indicating that the battery level is too low; please charge in time;
 - ✧ When the USB, power adapter and charging connector are plugged in, the red light will be on, indicating that the battery is charging;
 - ✧ When the USB, power adapter and charging connector are plugged in, the green light will be on, indicating that the battery has been fully charged.
- If the LED indicator lamp in the middle of the upper right corner of the machine flashes in blue (in the form of breathing light), it indicates that there is information not read; please check it in time.
- When scanning a barcode, the LED indicator lamp on the left of the upper right corner of the machine, it will flash once in red; if not scanning any barcode, it will not be on.

Remarks: When the system is charging, the blue indicator lamp will not give prompts.

Chapter VI Main Screen



Find the icon, Settings – Application, click the Set button in the upper right corner of the interface to enter the main screen of settings; there are two main screens by default, which can be set at will.

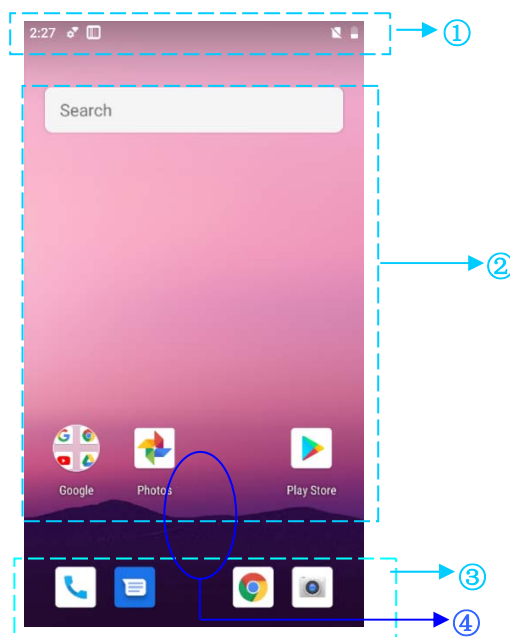

Figure 6-1 Main Screen (Trebuchet)

Table 6-1 Items on Main Screen

① Status bar: Display the notification and status icons.
② Display area: Used to place application icons, desktop folders and window widgets.
③ Shortcut bar: Click it to enter the corresponding application.
④ Application tray: Click it or slide up to enter the main interface to view all programs.

6.1 Status Bar Icon

The status icon and notification bar icon are located in the status bar at the top of the screen to display the device status information and notification, as shown in the

table below.























Icon	Description	Icon	Description
	Detected available WLAN network		Signal intensity
	Connected to WLAN network		No SIM card inserted
	Uploading data		Downloading data
	Enabled portable WLAN		Mobile network connected
	Do not disturb mode		Flight mode
	Vibration mode		Scan on
	Missed calls		Battery charging
	New message		Battery fully charged
	Captured screen shot		Low battery level
	Alarm clock		Headphone plugged in
	Preparing microSD card		Bluetooth
	USB debugging, USB connection		

Table 6-2 Status Icon and Notification Bar Icon

Chapter VII Settings

7.1 WLAN

Find the icon:



->Settings

->Network and internet

->WLAN

Wi-Fi 2.4G provides wireless network access range of up to 450 feet (150m), and 5G provides wireless network access range of up to 300 feet (100m) (note: industrial AP, in open area). To use Wi-Fi on your device, you must connect to a wireless access point or [Hotspot].

Note: The availability and coverage of Wi-Fi signals depend on its number, infrastructure, and other objects penetrated by signals.

Open Wi-Fi and connect to a wireless network.

1. Click WLAN Off/On button to open Wi-Fi. Automatically scan available wireless networks.

2. Then the Wi-Fi network list will display the network name and security settings (open network or encrypted network) of the found Wi-Fi network.

3. Touch one of the Wi-Fi networks to connect to it. When you select an open network, the device will automatically connect to the network. If an encrypted network is selected, it's required to enter the corresponding password before touching the connection.

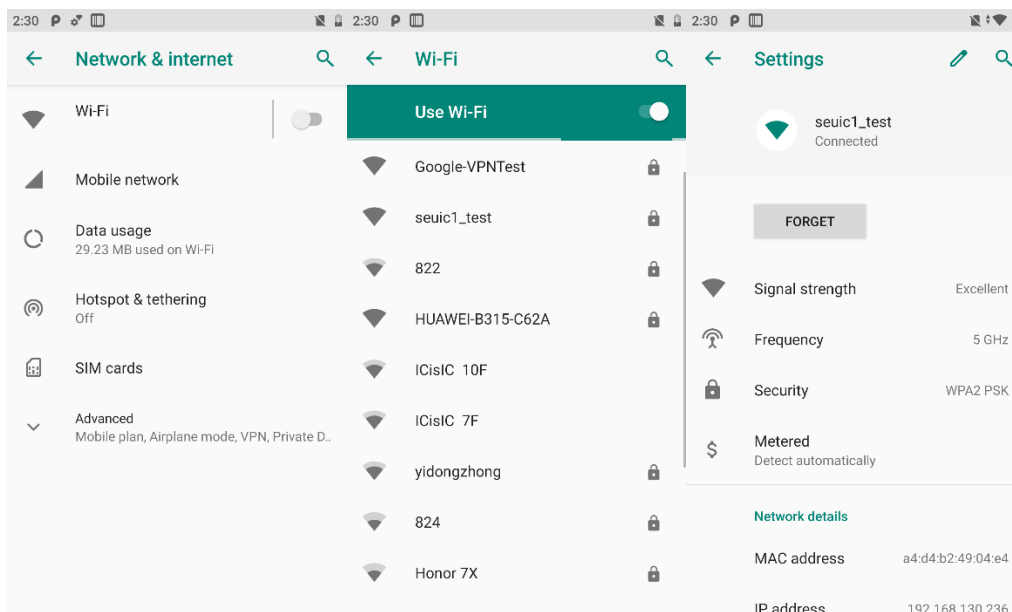

Figure 7-1 Wi-Fi Menu

4. WLAN band setting (at the bottom of WLAN, click WLAN preferences - click Advanced - WLAN Advanced Settings - WLAN Band Settings). When you select only to use 5GHz/2.4GHz frequency band, only the AP in 5GHz / 2.4GHz band can be searched.

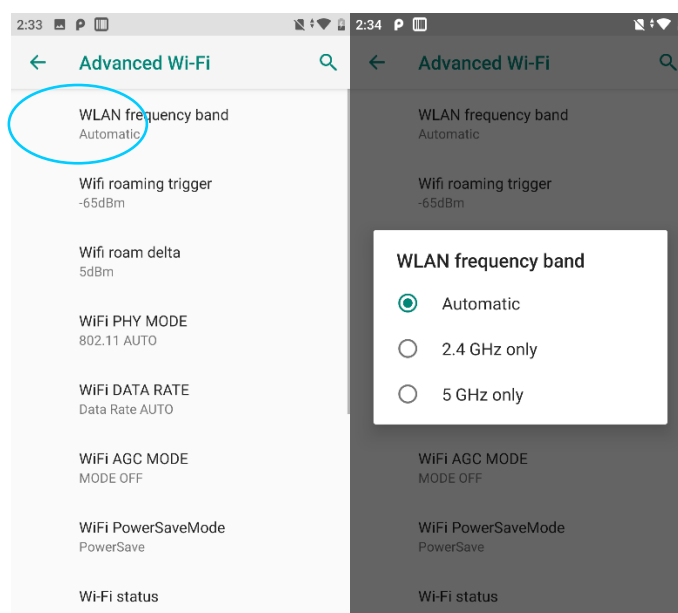



Figure 7-2 WLAN Band

- Open the interface on wireless Wi-Fi and touch scan. The found Wi-Fi network will be displayed in the Wi-Fi network list.
- Click other Wi-Fi networks to connect to the network.

7.2 Bluetooth

Find the icon: 

- >Settings
- >Connected device
- >Connect to preferences
- >Bluetooth

1. Click Bluetooth Off/On button, then click Pair with New Device, turn on and search for other Bluetooth devices;

2. In the found device list, click the device to be connected for pairing;

3. After inputting PIN code in the pop-up pairing request dialog box, click OK to connect the device;

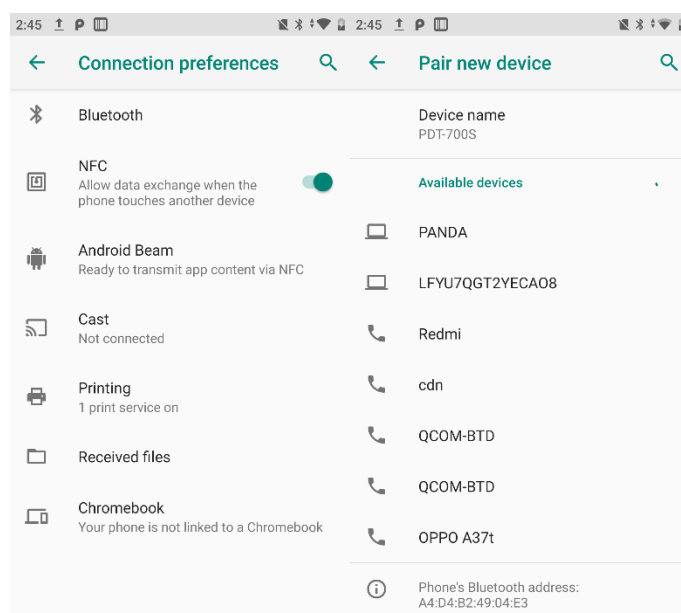

Figure 7-3 Bluetooth Menu

4. For the successfully paired device, click the Set button on the right to perform corresponding operation as required such as renaming the device or canceling the pairing.

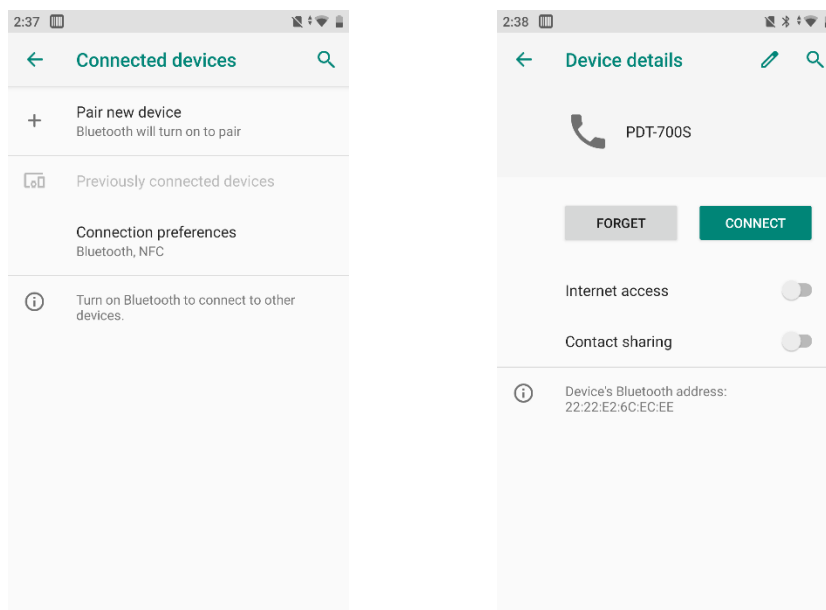

Figure 7-4 Setting of Paired Bluetooth Device

5. Bluetooth transmission: You can choose the files, pictures, videos, MP3 and other files to be sent and send them through Bluetooth, such as: to share a MP3, select the MP3, press and hold the MP3 to be shared, select the paired Bluetooth in the sharing interface, and in the appearing detail interface, click Send, as shown in the following figure:

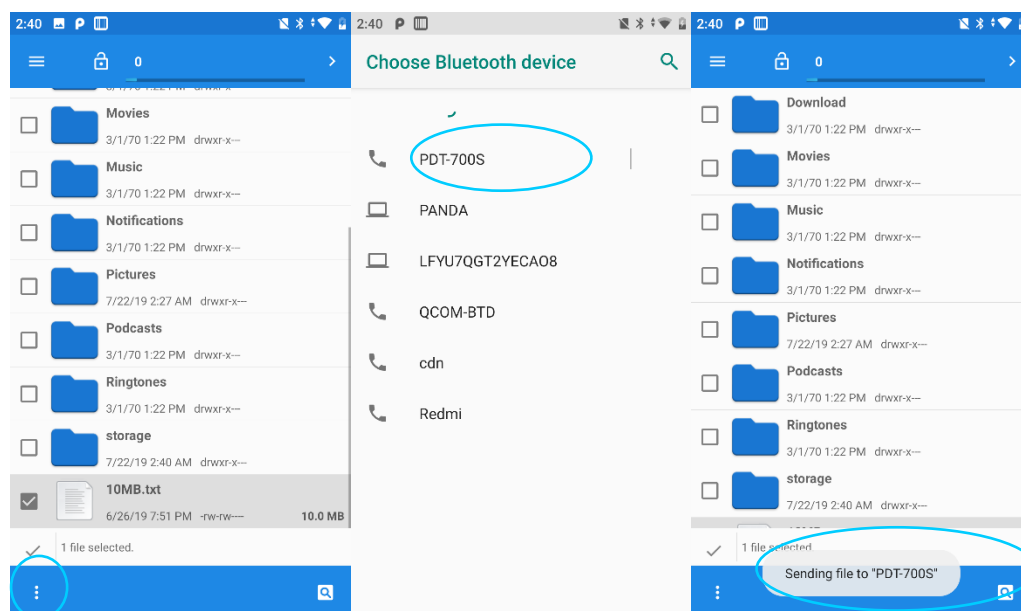



Figure 7-5 Bluetooth Transmission

6. When sending, there is an up arrow mark  on the top of the left screen,

which can be pulled down to observe the transmission, as shown in the following figure:

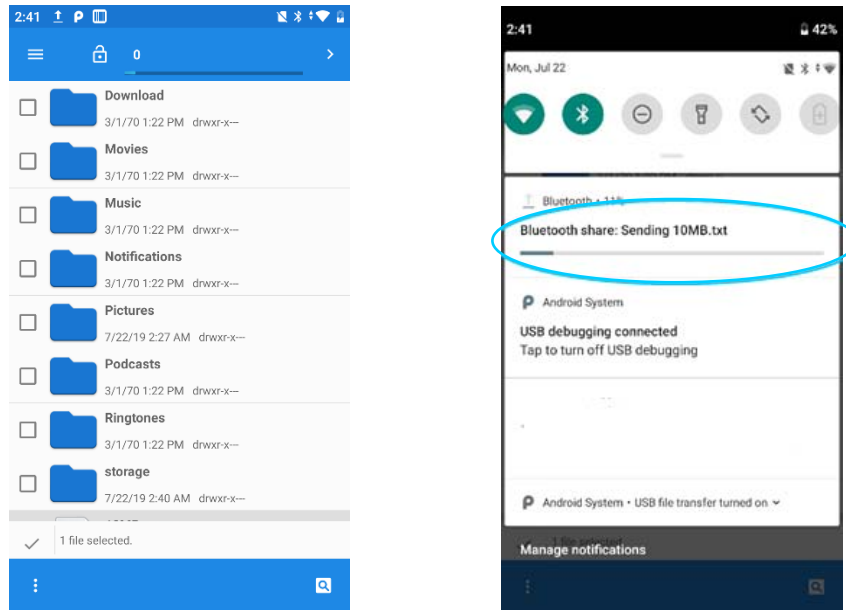

Figure 7-6 Bluetooth Transmission Progress Bar

7. After the file is sent, there will be corresponding prompt.

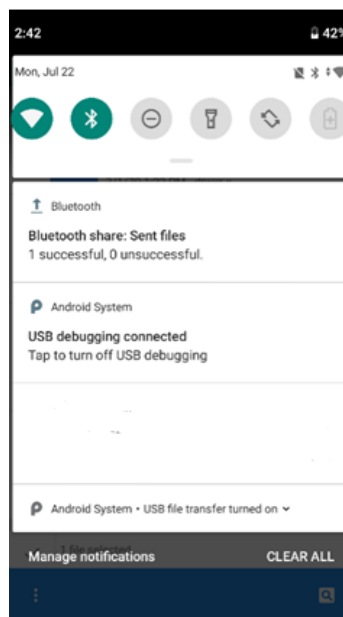



Figure 7-7 Viewing Bluetooth Sharing Result

8. Bluetooth earphone is the same as normal Bluetooth pairing, and can be used for voice communication, multimedia play, etc.

7.3 SIMCard

Find the icon: 

- >Settings
- >Network and internet
- >SIM card

In the SIM card interface, you can set the preferred SIM card (including data traffic, call, SMS) and disable SIM function. The main interface is shown in the following figure:

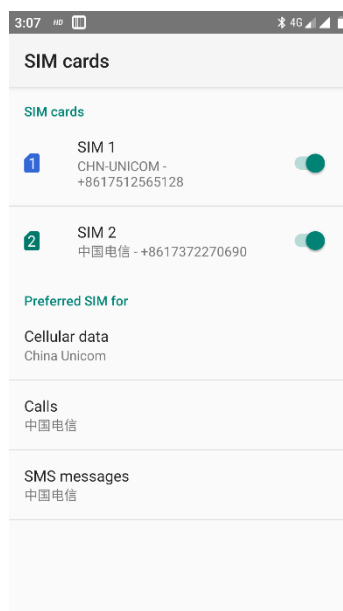



Figure 7-8 Main Interface of SIM Card

7.4 Traffic Usage Status

Find the icon: 

- >Settings
- >Network and internet
- >Traffic usage status

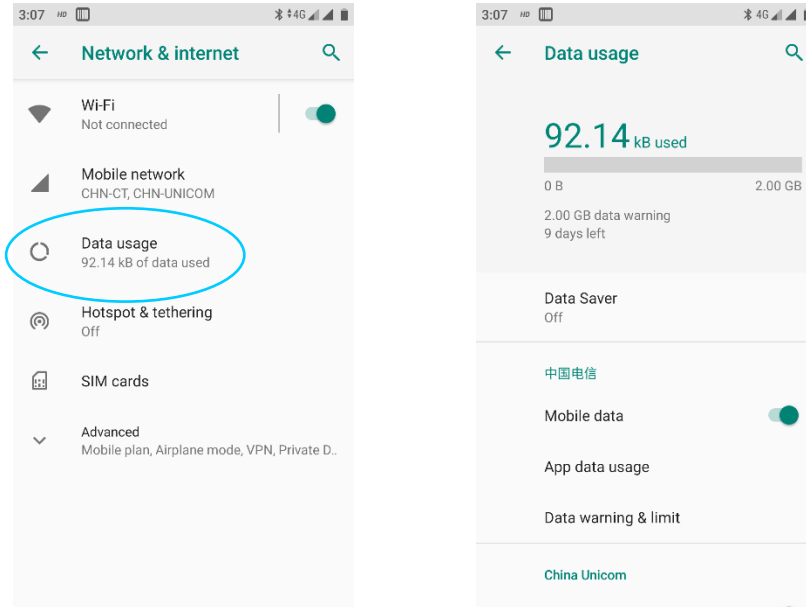



Figure 7-9 Traffic Usage Status

7.5 More

Find the icon: 

- >Settings
- >Network and internet
- >Advanced

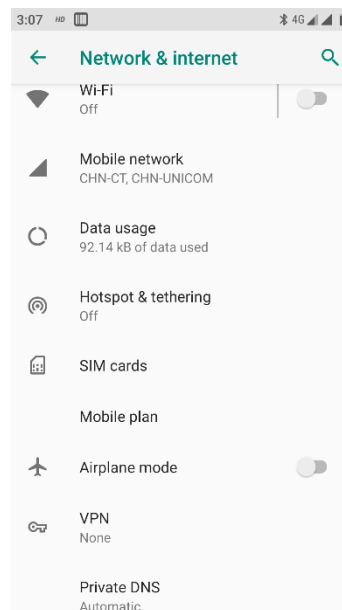

Figure 7-10 More Menus

7.5.1 Flight Mode

When flight mode is checked, the wireless module will be automatically closed.

7.5.2 NFC

NFC function: Enable this function, the mobile phone will be allowed to exchange data when contacting other devices. As long as you put your device close to other device that supports NFC, you can share the application content in your device with the other synchronously. At the same time, a third-party NFC software can be installed to read and write NFC card.

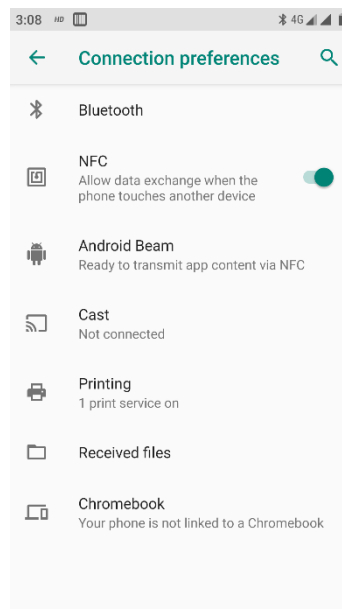

Figure 7-11 NFC Function

7.5.3 Android Beam

Enable the Android Beam function, and the device can share files through the Android beam. (Not yet implemented)

7.5.4 Network Sharing and Portable Hotspot

(1) Portable hotspot function: Taking this machine as a Wi-Fi hotspot, provide

signal access for mobile phones and computers equipped with Wi-Fi module within a certain range of perimeter.

(2) Settings --- >Network and Internet --- >Hotspot and network sharing --- >WLAN hotspot --- >Enable, as shown in the figure below:

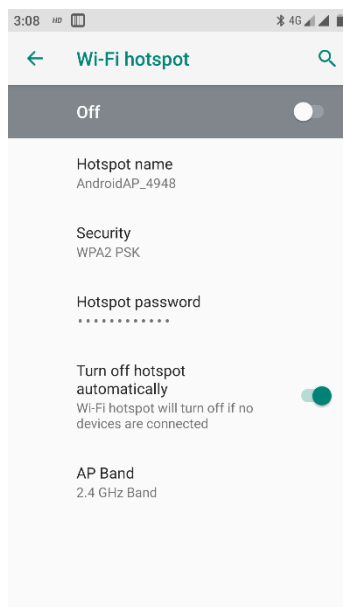

Figure 7-12 Modify WLAN Hotspot

Modification can be conducted in this interface by clicking the option to be modified.

7.5.5 VPN

After VPN is enabled, you need to add VPN private network (for example, you want to access the shared network resources such as the internal file server of the company). No matter where you are, you can connect to the company's VPN server through the VPN client. After obtaining the VPN account, you can dial through the VPN client. After dialing successfully, you can access the shared resources of the company.

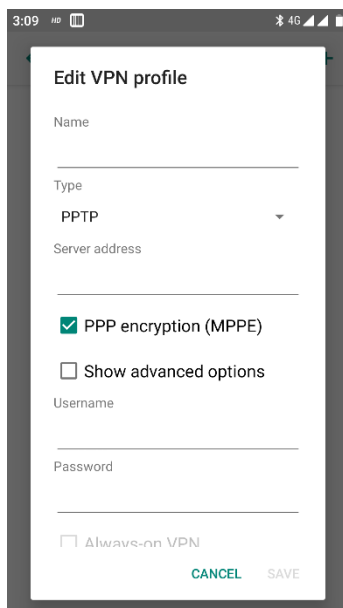

Figure 7-13 VPN Setting

7.5.6 Mobile Network

1. Enable: After entering roaming environment, data communication can be switched to roaming state directly.

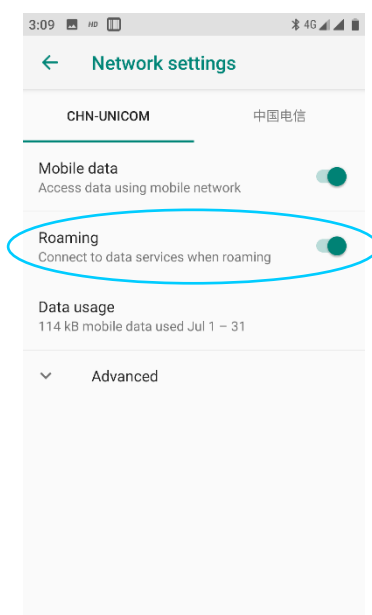

Figure 7-14 Mobile Data Network Roaming

2. Preferred network type: After the corresponding network type priority is selected, the task bar will display the corresponding network signal indication, G = 2G priority, 3G = 3G priority, 4G = 4G priority. If China Unicom card selects the network type 2G priority, the device will forcibly request to be degraded to 2G network even in the area covered by 3G signal.

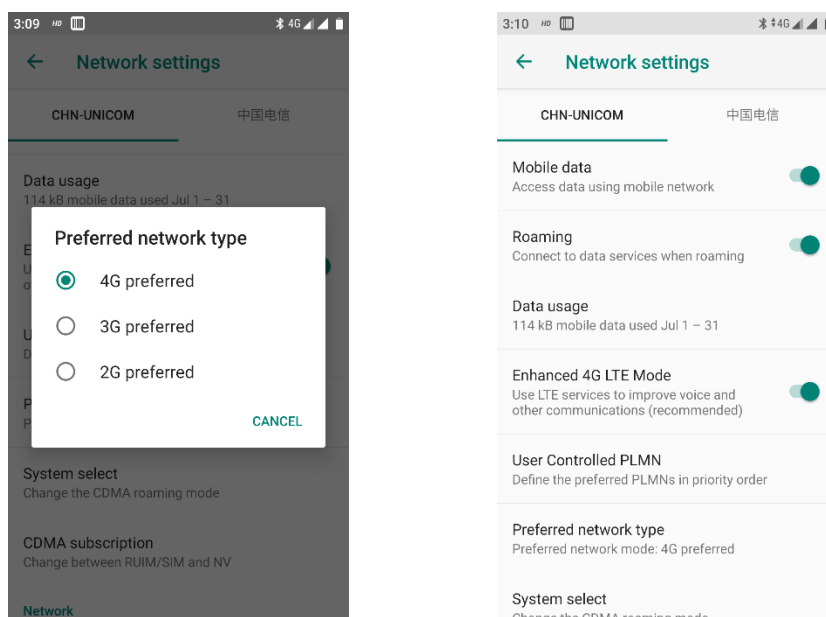

Figure 7-15 Network Mode Selection

3. Access point name: The default name is cmnet for China mobile, 3gnet for China Unicom and ctnet for China Telecom, as shown in the figure below:

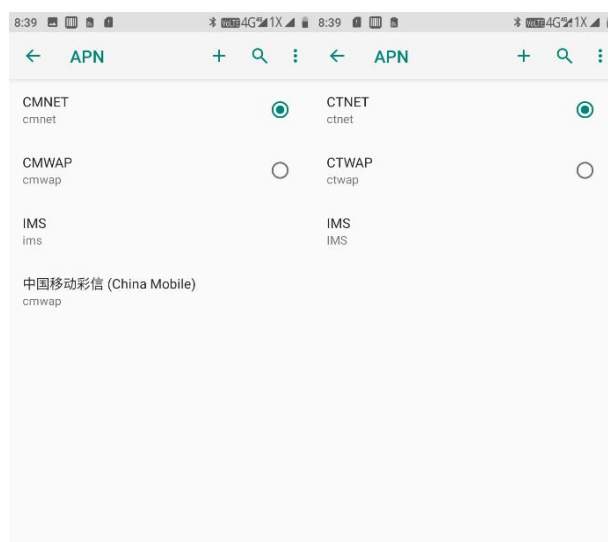



Figure 7-16 Access Point APN

4. Add a dedicated APN. Click the button  and the interface as shown in the figure below will pop up, and in this interface, generally add the name (custom), APN (network access point), user name, password, etc. and press Menu button to select Save to complete addition; press Menu button to select to give up or press Back button to return directly to give up. If you want to modify or delete the added APN, click Enter to modify it, and press Menu button to save or delete.

Note: When adding APN, users can set other options according to their own access point requirements.

5. Network operator: Search the network operator resources in the current environment.

7.5.7 Reset Network Settings

This function can reset some settings of WLAN, mobile data network and Bluetooth of the device. Click [Reset Settings] button to jump to the interface of confirming whether to reset network settings; click [Reset Settings] and there is the prompt of successful resetting, as shown in the following figure:

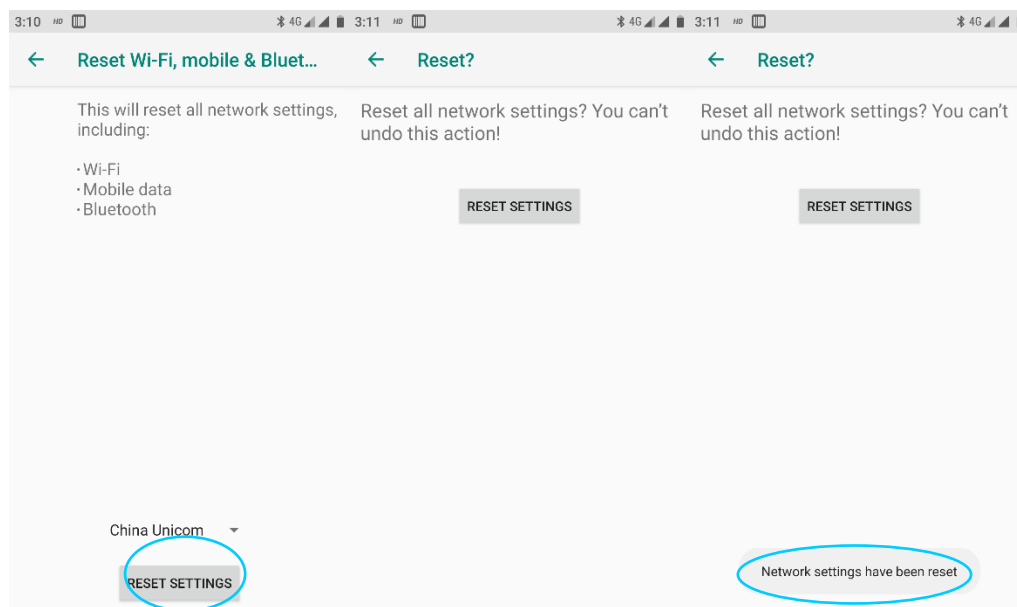

Figure 7-17 Reset Network Settings

Note: 1. If the device is connected to wifi, after the network settings are reset, the device will clear the AP password and disconnect wifi.

2. In the mobile data network, if the enhanced 4G LTE mode is disabled, after the network is reset, the device will enable the enhanced 4G LTE mode by default.
3. If the default name of Bluetooth is modified and it has been paired, after the network is reset, the Bluetooth name of the device will be restored and the Bluetooth pairing will be disconnected.

7.6 Display

Find the icon:



->Settings

->Display

1. Brightness: The backlight can be adjusted by moving the cursor bar left and right.

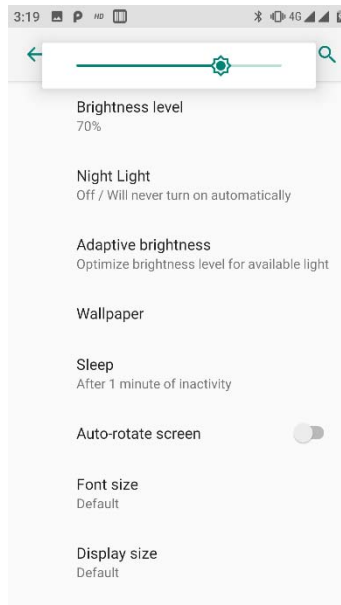

Figure 7-18 Display

2. Wallpaper: After entering, you can modify the wallpaper source you want to set, such as pictures in gallery, photo album or memory card; wallpaper: the system contains pictures by default.

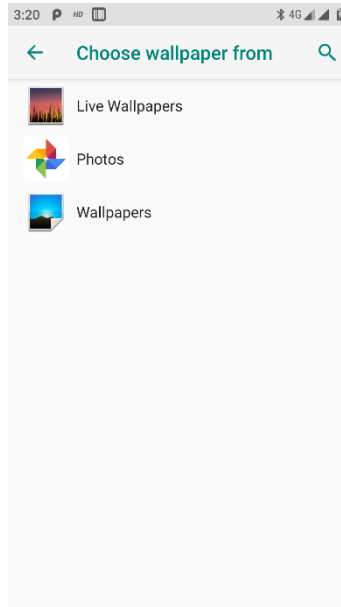

Figure 7-19 Wallpaper

3. Automatically rotate the screen: Select the content and direction of screen rotating, and the device will rotate horizontally and vertically according to the rotation angle.

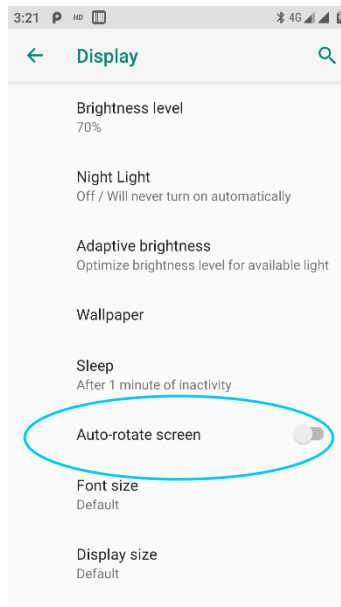

Figure 7-20 Automatically Rotate the Screen

4. Sleep: Change and set the system sleep time, and the system will sleep automatically when the set time is up.

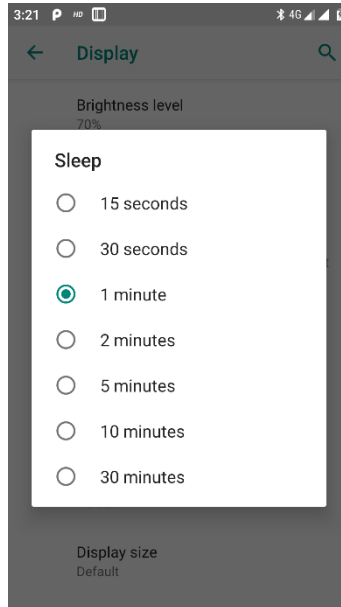

Figure 7-21 Sleep

5. Font size: Adjust the font size of the system according to your own needs, which can be set to small, default, big and maximum.



Figure 7-22 Font

7.7 Notification

Find the icon:



->Settings

->Application and notification

The settings of application notification message include notification, default application, application permission and special application permission, as shown in the figure below:

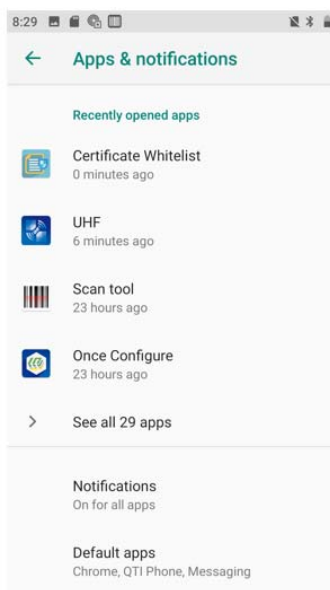

Figure 7-23 Notification

7.8 Sound

Find the icon:



->Settings

->Sound

Settings of sound volume, mobile phone ringtone and default notification prompt tone: You can also select or cancel vibration when the bell rings, touch tone when dialing keyboard, touch prompt tone, charging prompt tone, lock screen prompt tone

and vibration when touching, as shown in the figure below:

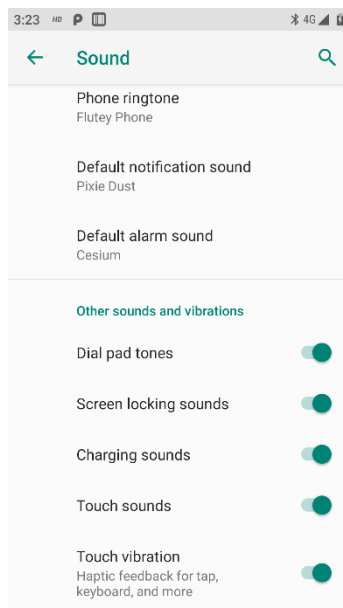

Figure 7-24 Sound

7.9 Application

Find the icon:



->Settings

->Application and notification

Manage applications. Enter the interface, click the application you want to uninstall, and you will enter the following application information interface; click Uninstall, and you can remove the application from the device.

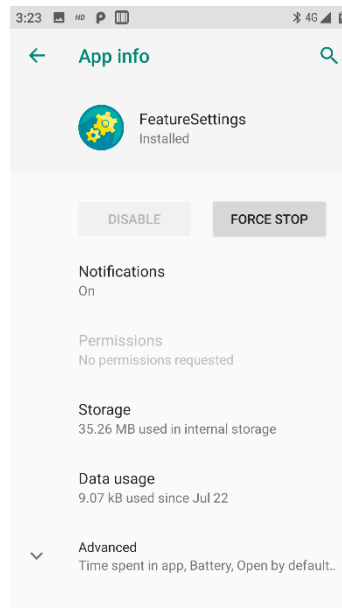

Figure 7-25 Application

7.10 Storage

Find the icon:



->Settings

->Storage

View the available memory space, clear the memory card (format the internal memory) and select the option to scan media for external memory cards or external USB devices.

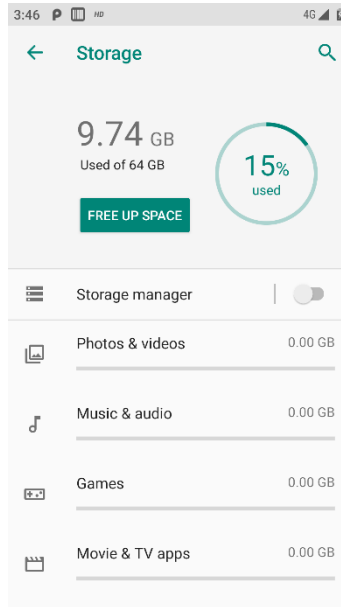



Figure 7-26 Storage

7.11 Battery

Find the icon: 

->Settings

->Battery

View the current capacity of the battery and whether the power is displayed in the on/off status bar.

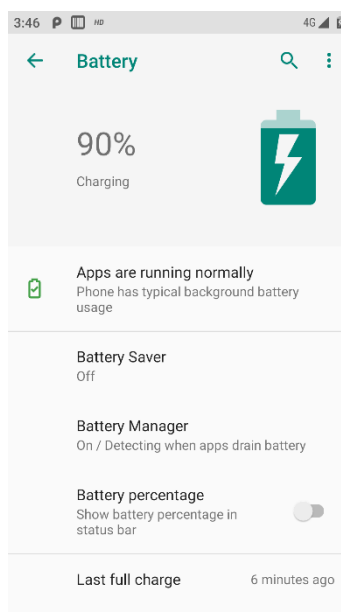



Figure 7-27 Battery

7.12 Location Information

Find the icon: 

->Settings

->Security and location information

Check Google location service, enable the GPS positioning function, and you can download the third-party positioning software by yourself.

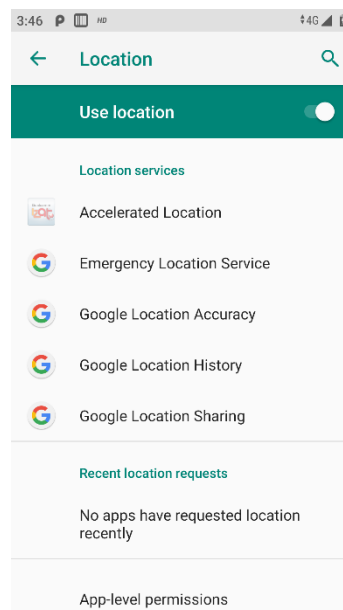



Figure 7-28 Right to Use Location Information

7.13 Security

Find the icon: 

->Settings

->Security and location information

Set screen lock mode, display password, device manager, application operation, unknown source, unknown source application installation password setting, trusted credentials, etc.

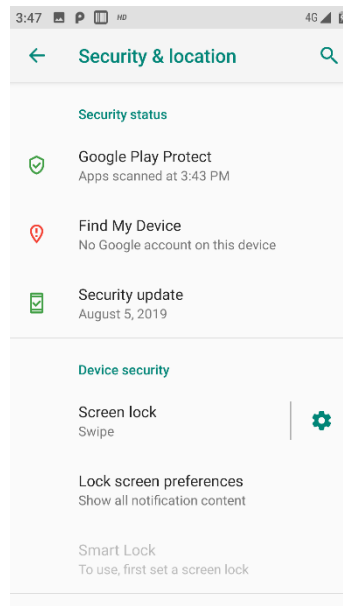



Figure 7-29 Security

7.14 Account

Find the icon: 

->Settings

->Account

Establish an account and synchronize information (contact information, calendar, etc. can be synchronized to other product cloud; account and server need to be set).

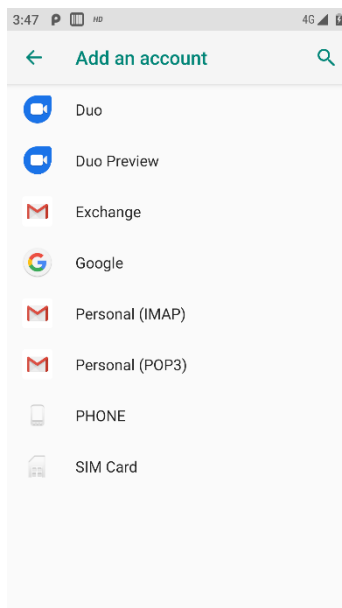



Figure 7-31 Add Account

7.15 Language and Input Method

Find the icon: 

->Settings

->Language and input method

Language selection, text input and automatic error correction options: Select your favorite keyboard and input method, and set text-to-language output and pointer speed. If other input method is installed, it will be displayed in this interface.

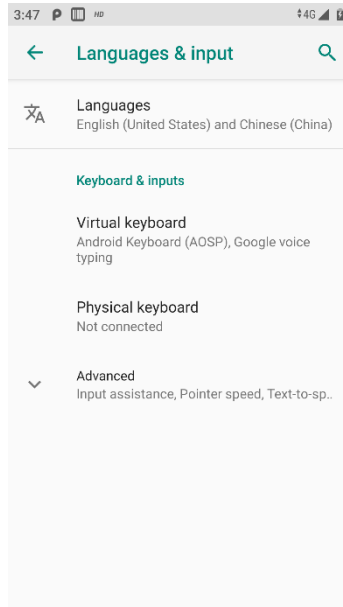

Figure 7-32 Language and Input Method

7.16 Backup and Resetting

Find the icon:



->Settings

->Backup and resetting

Backup or restore data and restore the factory settings.

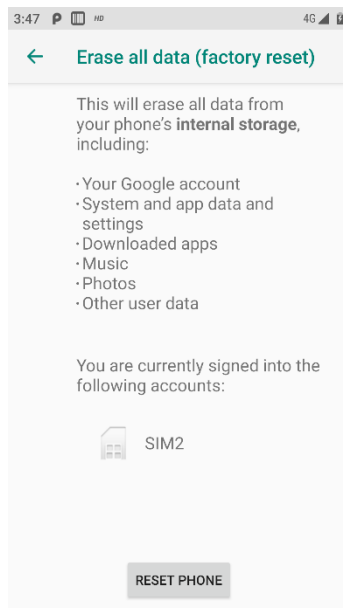



Figure 7-33 Restore Factory Settings

7.17 Date and Time

Find the icon: 

->Settings

->Date and time

You can use the time or time zone provided by the network, or manually set the date and time and select the time zone. You can also select the display format of the time and date.

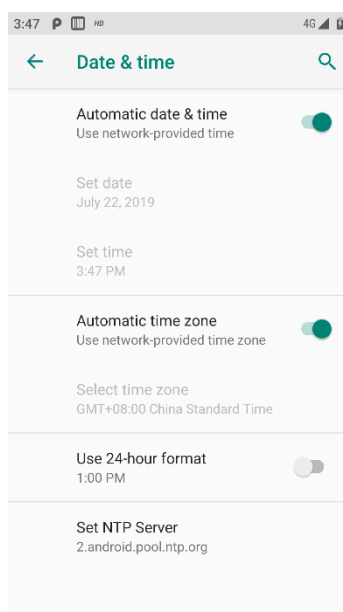



Figure 7-34 Date and Time

7.18 Barrier Free

Find the icon: 

->Settings

->Barrier free

Here you can set zooming in of gestures, high-contrast text, pressing the power button to end a call, mono audio, color reversal, color calibration, and touch and hold for delay.

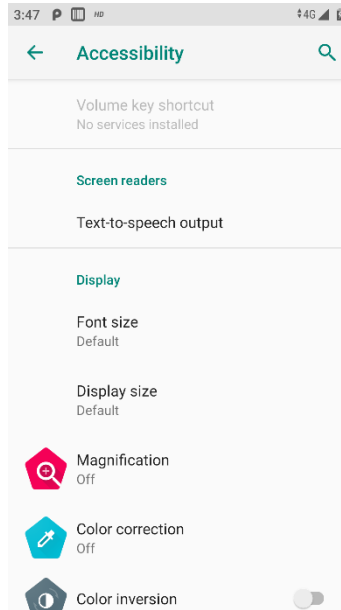



Figure 7-35 Barrier Free

7.20 Developer Option

Find the icon: 

->Settings

->Developer option

Settings --> About cell phone --> Version number. Click the version number for several times to enable the developer option, and then you can get some other information on the device, general for Android.

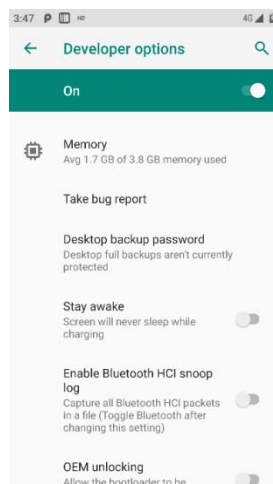

Figure 7-36 Developer Option

7.21 About Cell Phone

Find the icon:



->Settings

->About cell phone

Device details:

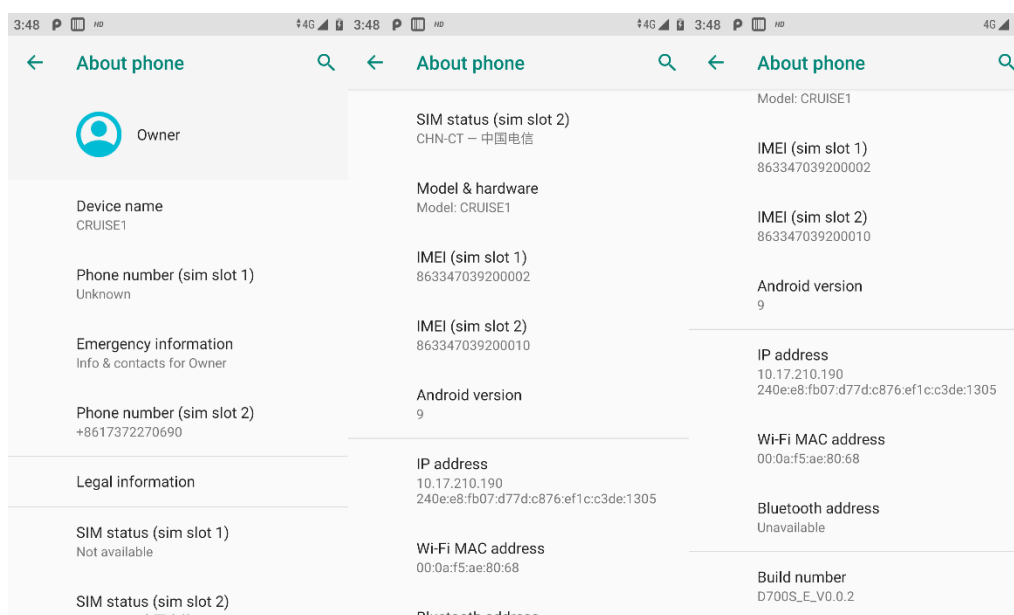

Figure 7-37 About Cell Phone

1. SIM status information can show the current network, signal intensity, IMEI number, etc., as shown in Figure 7-39;
2. Model: Display the model of the machine;
3. Function number: Display the function number of the machine;
4. Android version: Android system version;
5. Baseband version: Module version number;
6. Touch screen firmware version number: Touch screen version number;
7. Device serial number: Display the S / N number of the machine;
8. Kernel version: Device kernel information;
9. Version number: System software version of device.

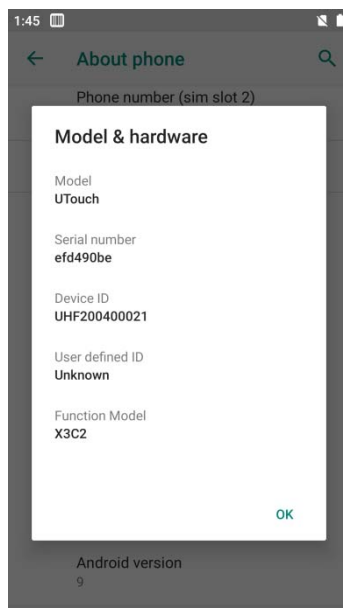



Figure 7-38 Model & Hardware

Chapter VIII Introduction to Typical Application

8.1 Scanning Tools

1. Find the icon , click it to enter this interface, and press Scan button to scan normally.

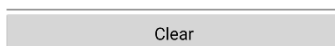
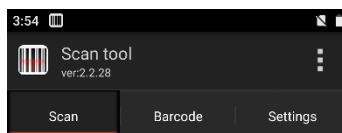

Figure 8-1 Main Interface of Scanning Tool

2. Select [Barcode setting] to enter the barcode type setting interface to set the required barcode type;

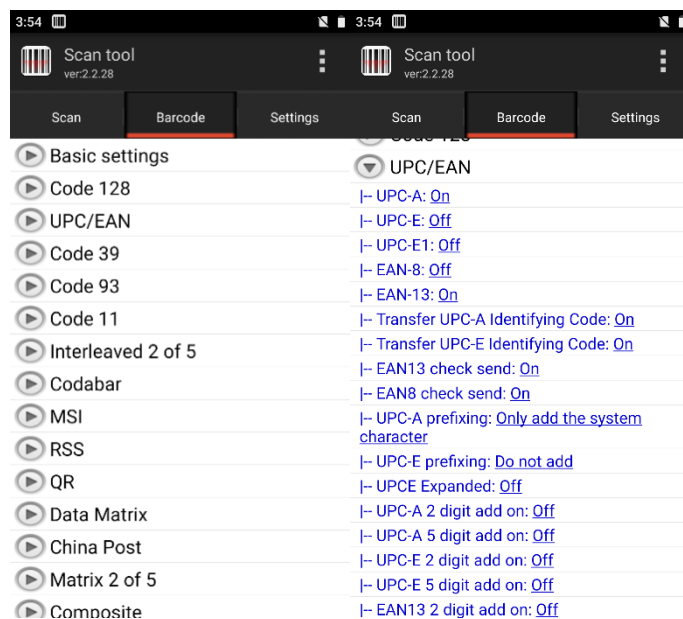

Figure 8-2 Barcode Setting

3. Open [Basic settings] to set the scanning duration, angle, timeout, etc.:

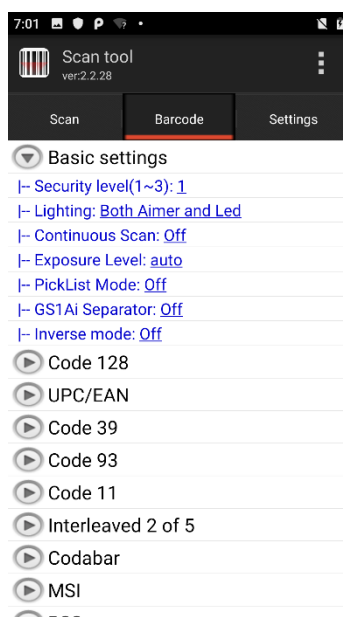

Figure 8-3 Basic Settings

4. Open [Application settings] to set the basic switches of scanning, as shown in Figure 8-4:

- (1) Scanning sound: When it is enabled, there will be voice prompt for scanning;
- (2) Vibration: When it is enabled, there will be vibration prompt for scanning;
- (3) Barcode addition: When it is enabled, the barcodes can output continuously;
- (4) Automatic clearing: When it is enabled, the last barcode will be cleared

automatically after finishing scanning barcodes;

(5) Power-on self-starting: When it is enabled, the scanning program will be enabled automatically when the machine is powered on;

(6) Display barcode type: When it is enabled, the barcode type will be displayed when scanning barcodes;

(7) Lift to stop scanning: When it is enabled, lift the scan button and the scanning light will go out immediately; when it is disabled, lift the scan button and the scanning light will go out after [Scanning duration];

(8) Cycle scanning: When it is enabled, scanning will be carried out automatically and continuously;

(9) Interval time: Set the time by yourself; it is the interval time between the completion of barcode scanning and the scanning of next barcode;

(10) Restore default barcode settings: You can restore the default barcode settings, as shown in Figure 8-5;

(11) Barcode suffix: You can add barcode output suffix (it can be numbers, letters, special characters, etc.);

(12) Barcode prefix: You can add barcode output prefix (it can be numbers, letters, special characters, etc.);

(13) Ending character: You can select the barcode ending output character, including Enter, Tab, Space, None;

(14) Bar code sending mode: You can choose to send by focus input, broadcasting, simulation keyboard or clipboard (input method supporting hardware keyboard shall be selected for simulation keyboard), as shown in Figure 8-6;

(15) Developer option: Enter the password 888888 to modify the developer option (it is not recommended to change it at will), as shown in Figure 8-7.

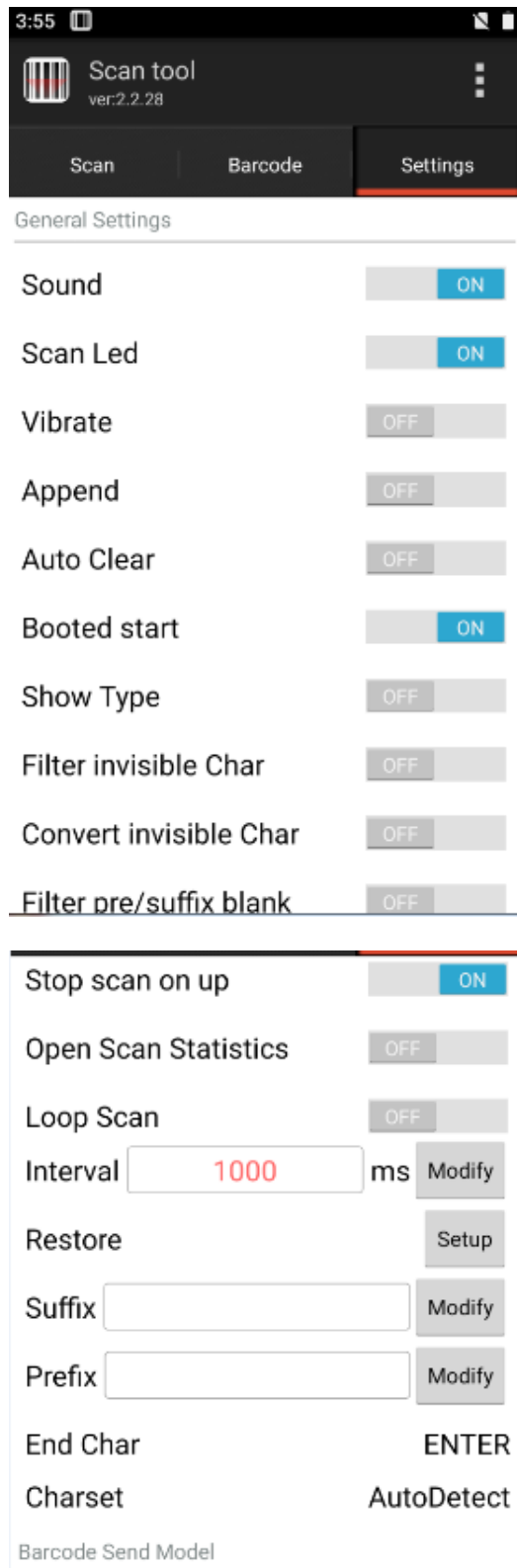

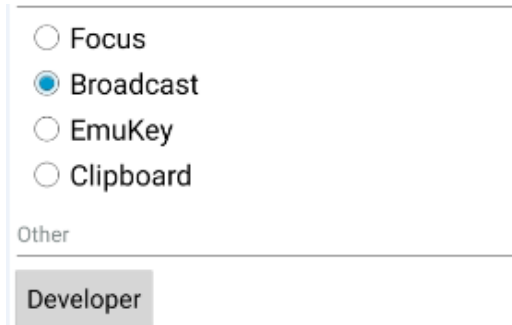

Figure 8-4 Application Settings

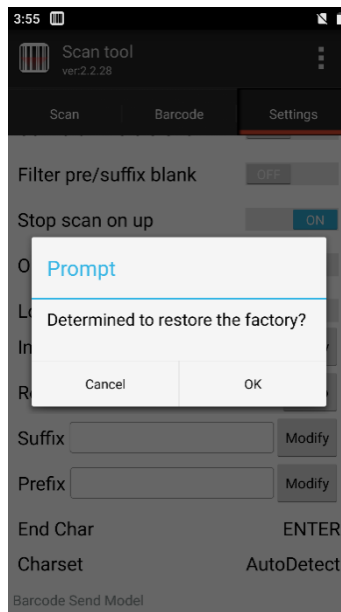

Figure 8-5 Restore Default Barcode Settings

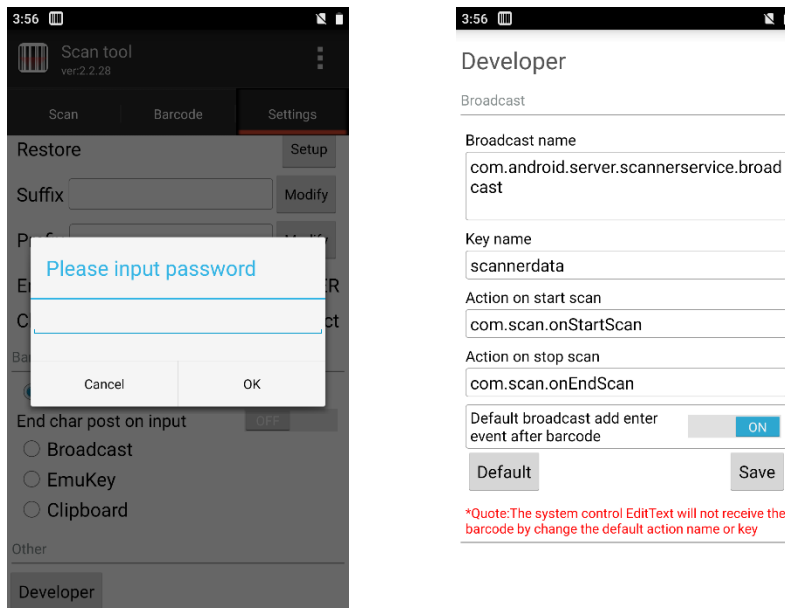

Figure 8-6 Developer Option

5. Program hide or exit

(1) If you select [Hide], the program will run in the background, and you can scan by pressing Scan button in any editing interface;

(2) Select [Exit] and the program will exit and be closed.

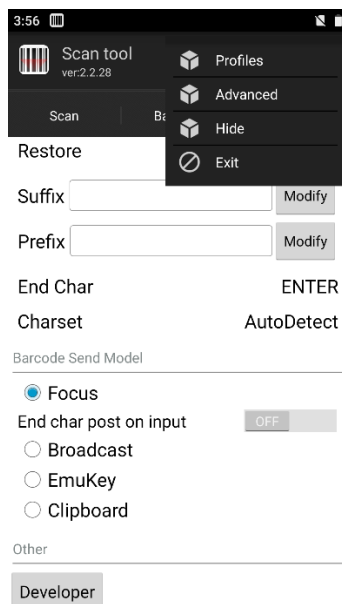



Figure 8-7 Hide and Exit

8.2 UHF

1. Find the icon , open it to enter this interface, and press Scan button to find the card.

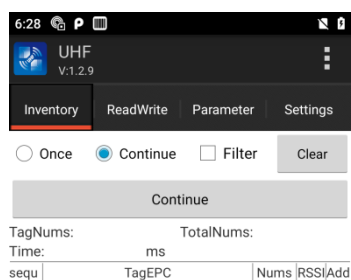

Figure 8-9 Access Label

- (1) Card searching method: There is no filtering mode by default. If you want to select the filtering mode, please enter the filtering condition. The labels that do not meet the screening conditions will be filtered out according to the filtering conditions after card searching;
- (2) Single card searching: Click to execute a single card searching;
- (3) Continuous card searching: Click to execute continuous card searching;
- (4) BANK: It is used together with card reading / writing to conveniently select password area, User area, EPC area and TID area;
- (5) Address: It is used together with card reading / writing to select the address bit of reading or writing;
- (6) Length: It is used together with card reading / writing to select the length of reading or writing;
- (7) Password: It is used together with card reading / writing and is the password used in card reading / writing;
- (8) Card reading: Read the data of the set position, and the data read is displayed in the text box below the card reading button;
- (9) Card writing: Write the data of the set position. For the data to be written, please input it in the text box below the card writing button;
- (10) Clear: Clear the contents of the text box below the card reading / writing;
- (11) Lock: lock a certain area of the label, and select EPC, TID, USER, RESERVED;
- (12) Unlock: Unlock a certain area of the label, and select EPC, TID, USER and RESERVED;

2. Select [Hardware Settings] to enter the UHF module hardware settings interface, and in this interface, you can set the card searching power (1 ~ 30) and read the UHF module temperature.

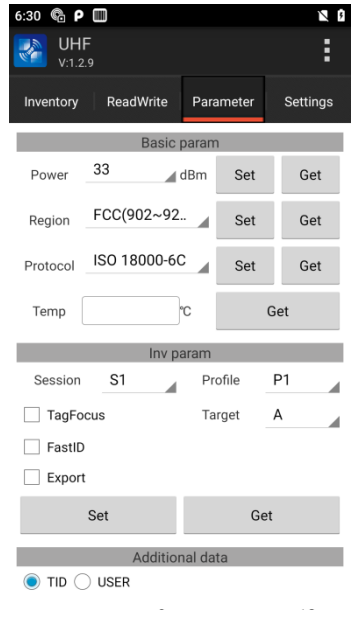
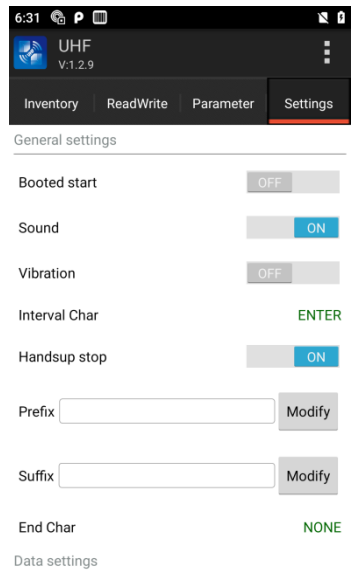

Figure 8-10 Hardware Settings

2. Select [Application Settings] to set the basic UHF switches, as shown in the figure below.



Region EPC

Data start

Data length

Send Mode

Focus

Broadcast

Other

Customized broadcast

Broadcast name

Data Key value

Start seek broadcaast

Stop seek broadcaast

Add Enter with broadcast mode

Figure 8-11 Application Settings

- (1) Power-on self-starting: When it is enabled, the UHF program will be enabled automatically when the device is powered on;
- (2) Card searching sound: When it is enabled, there will be voice prompt when the device is searching the card;
- (3) Card searching vibration: When it is enabled, there will be vibration prompt when the device is searching the card;
- (4) Continuous card searching: When it is enabled, and the [Lift to stop] switch is on: press Scan button, hold it, and the device will continue to search for the card, and after releasing the button, the card searching will end; when the [Lift to stop] is disabled, just press Scan button once, and the card searching will continue even after the button is released. In the continuous card searching state, press Scan button again, then release it and the card searching will stop;
- (5) Spacecharacter: When it is enabled, the space character selected here will be inserted between every two pieces of card searching data;

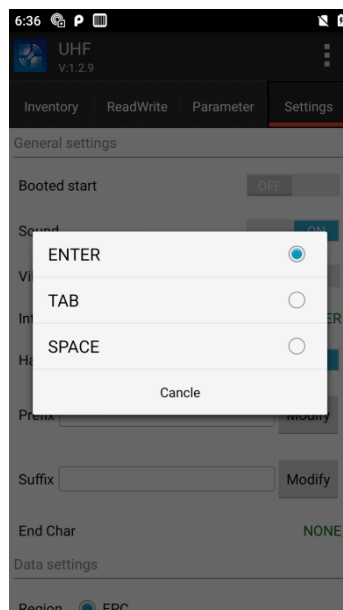

Figure 8-11 Space Character

- (6) Lift to stop: When it is enabled, and [Continuous card searching] switch is on: press Scan button, hold it, and the device will continue to search for the card, and after releasing the button, the card searching will end;
- (7) Scan button: After clicking it, press any button (except Power button, Home button, Menu button and Back button) on the keyboard and it will automatically replace the default Scan button. After setting successfully, return to the card searching interface, and press the above set button to conduct card searching and other operations;
- (8) Barcode prefix: You can add the set prefix content before the obtained label ID, and the prefix content can be numbers, letters, special characters, etc.;
- (9) Barcode suffix: You can add the set suffix content after the obtained label ID, and the suffix content can be numbers, letters, special characters, etc.;
- (10) Ending character: The character following the obtained label ID (it can be a set of labels), including: ENTER, TAB, SPACE, and NONE (NONE means no ending character);

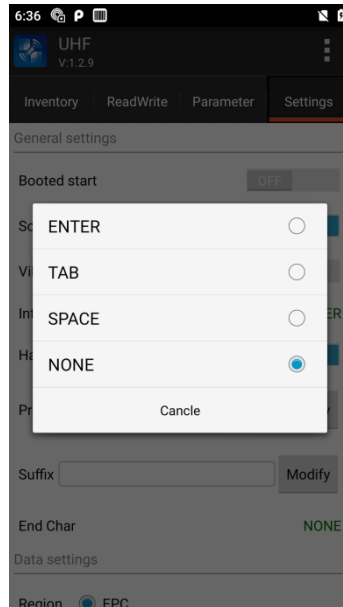

Figure 8-12 Ending Character

- (11) Card searching area: EPC and TID are optional respectively;
- (12) Data start: Enter the starting reading length of the card searching ID (for example, if the ID is 012345678, when it is set to 3, the data will be read from the fourth digit);
- (13) Data length: The total length of data read;
- (14) Focus input: The card searching data will be sent to any input interface with focus;
- (15) Broadcast: The card searching data will be sent in the form of broadcast;
- (16) Developer option: After clicking it, the password input interface will pop up. After entering the password, enter the developer settings interface (default password: 888888);

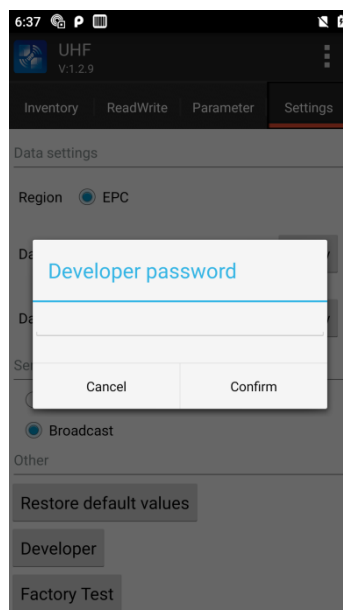



Figure 8-13 Developer Option

- (17) Broadcast name: Set the name of the broadcast to be sent;

- (18) Data key value: Set the key value when data are received;
- (19) Start card searching broadcast: Set the broadcast name of starting card searching;
- (20) Stop card searching broadcast: Set the broadcast name of stopping card searching;
- (21) Add enter event after data in default broadcast: Enter event followed when data is sent through broadcast;
- (22) Restore default: After clicking it, the setting items 17, 18, 19, 20 and 21 will be restored to the initialization state of the device;

4. In UHF application interface, click the icon  in the upper right corner and in the pop-up menu, select Hide, and the application will be hidden in the background; select Exit and the application will exit.

8.3 System Upgrade

This application is convenient for customers to realize remote upgrade.

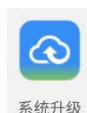

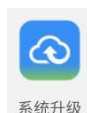
1. Find the icon  to enter [System Upgrade], as shown in the following figure:

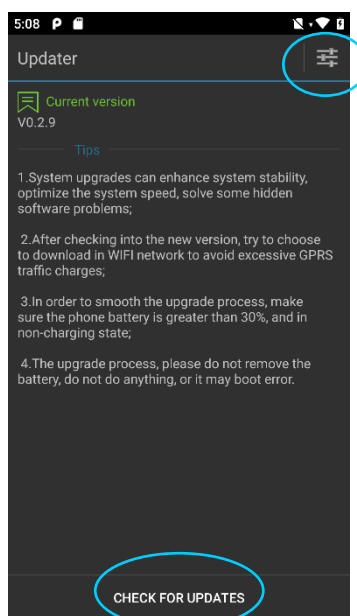

Figure 8-9 System Upgrade

2. When the network is smooth, click Check Update button. If there is no update, it will prompt that the current version is the latest version; if there is update, it will be prompt that a new version is found. Click to enter the download interface, as shown in

the figure below.

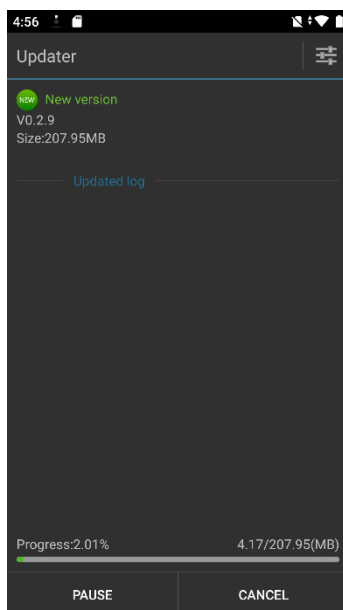

Figure 8-10 Check Update and Download

3. Click Download; after downloading successfully, click Update Now and the device will automatically restart and enter the upgrade status, as shown in the figure below:

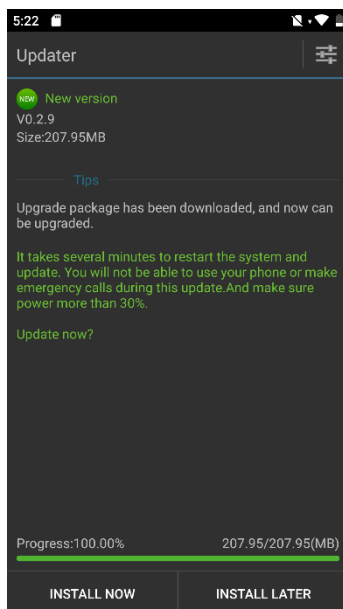

Figure 8-11 Update Now

When the battery level is lower than 30%, the following prompt will appear, and the device cannot be upgraded.

4. System upgrade settings, as shown in the figure below:

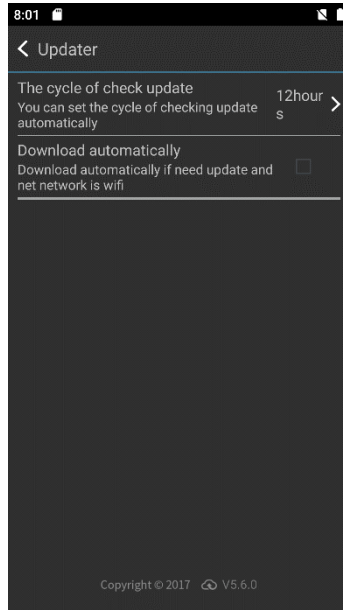



Figure 8-12 System Upgrade

8.4 Quick Configuration

This application is designed to realize quick copying of configuration information from one device to other device of the same model so that these two devices have the same related configuration.

Configuration import operation cannot be implemented among devices of different models.



Find the icon  to enter the quick configuration interface;

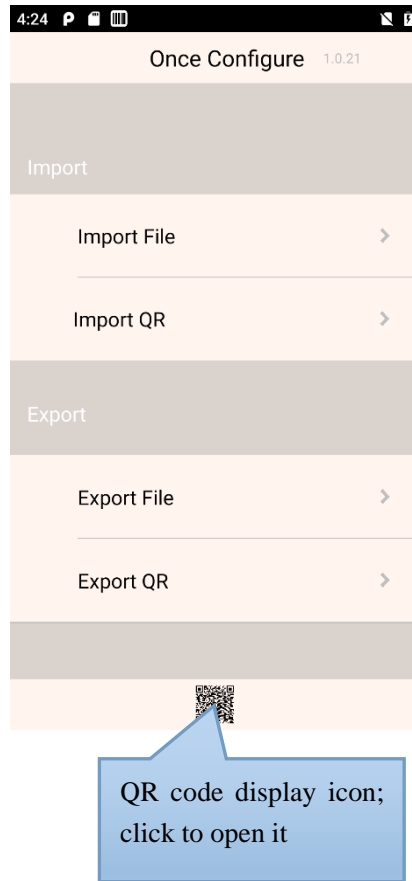

Figure 8-13 Main Interface of Quick Configuration

8.4.1 Import

1. File import

Put the qualified configuration compression package in the specified directory of external SD card and the file will be imported. The system path of external SD card is: external SD card / SysSetting/ Setinfo.tar.gz.

(1) Manual import:

1) Put the configurationcompression package (file name is Setinfo.tar.gz) under the directory of external SD card / SysSsetting, as shown in the figure below:

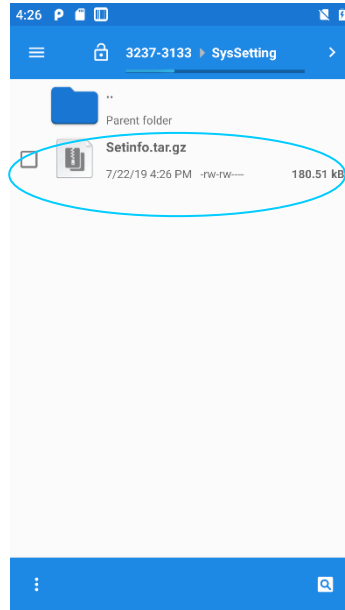

Figure 8-14 Directory of Configuration Compression Package

2) Enter the Quick Configuration, click [File import], and the following prompt will pop up. Click [OK];

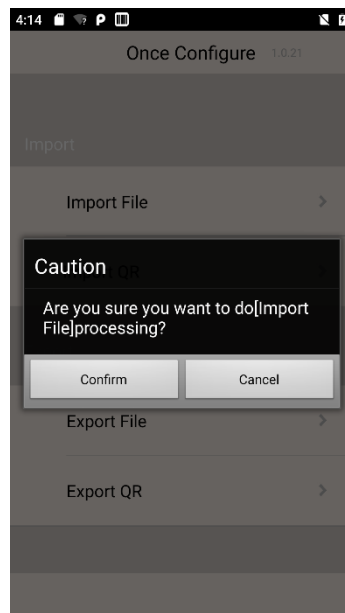

Figure 8-15 File Import

3) After importing successfully, the items and status of the file import will pop up. After clicking OK, a restart prompt will pop up. Click [Restart now] to complete it (if you do not restart, some configurations will not take effect immediately).

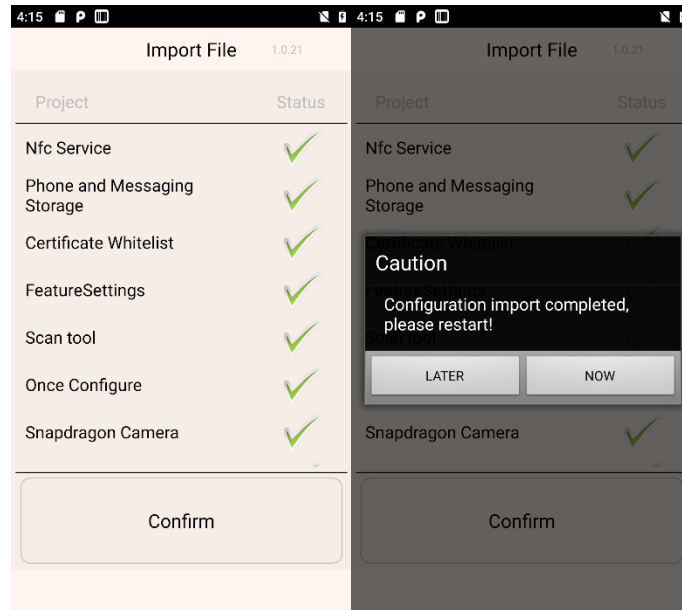

Figure 8-16 Successful File Configuration Import

2. QR code import

This function can realize the import of external configuration files by scanning QR code, and can call camera to scan other external QR code to import configuration files.

(1) Enter the Quick Configuration, click [QR code import] and put the QR code to be imported into the scanning box, as shown in the following figure:



Figure 8-17 QR Code Import Window

(2) After scanning and transmitting successfully, the items and status of QR code import will pop up. After clicking OK, a restart prompt will pop up. Click [Restart now] to complete it (if you do not restart, some configurations will not take effect immediately).

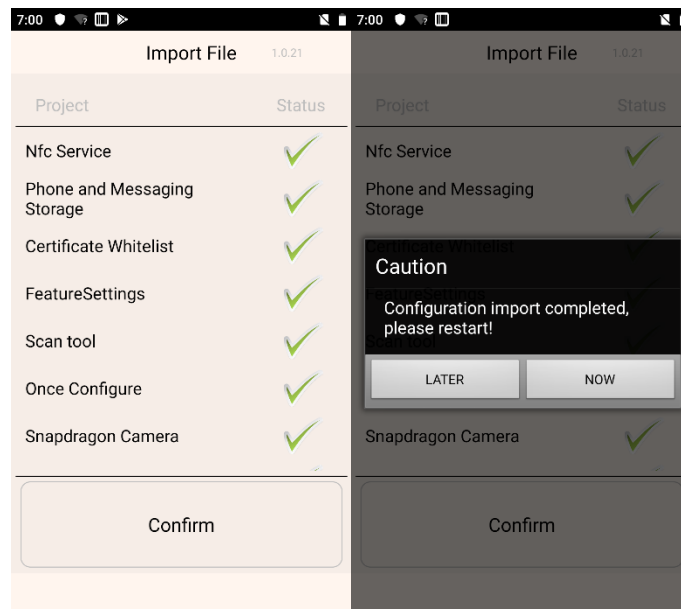

Figure 8-18 Successful QR Code Import

8.4.2 Export

1. File export

This function can be used to export all the configuration items in the configuration import and export tool to the directory specified in the internal SD card of the device or external SD card. The name of the export file is Setinfo.tar.gz. The path of the export file is: a) external SD card / SysSetting/

b) Internal SD card / SysSetting/

When the device has an external SD card, the exported file will be put preferentially in the external SD card.

(1) Enter the Quick Configuration, click [File export], and if the following interface pops up, it indicates successful export. When there is a configuration document in the external SD card, an export prompt will be given, and the file will be exported again to cover the original:

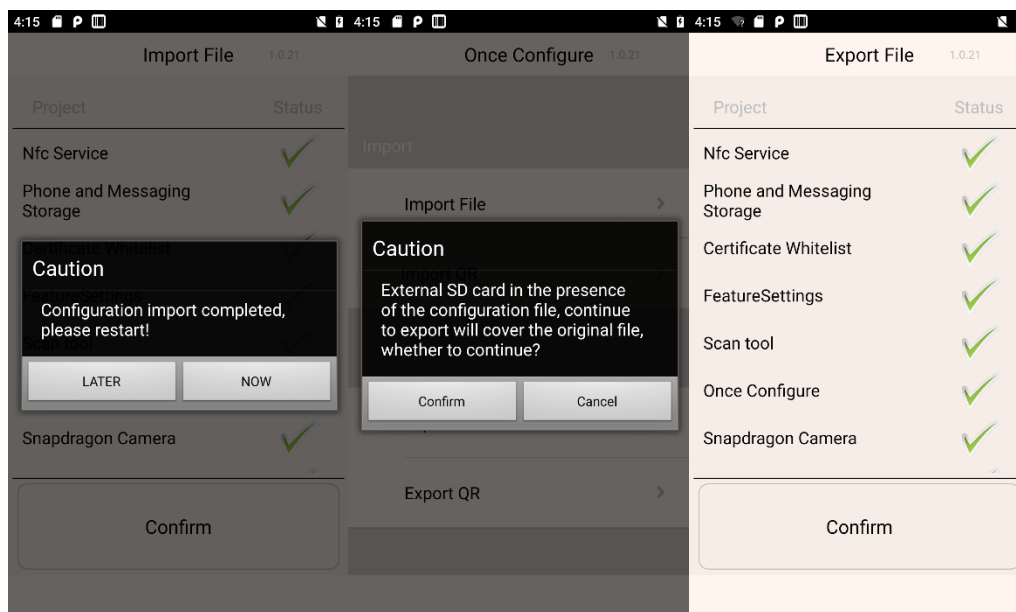

Figure 8-19 File Export

(2) The exported file name is Setinfo.tar.gz; enter [File management] ----> [Cell phone memory] OR [External memory card] ----> [SysSetting] to view it:

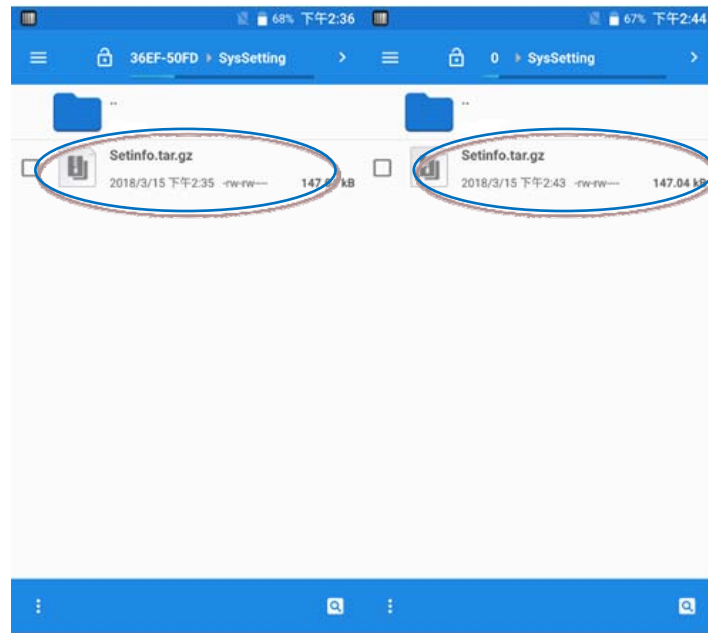

Figure 8-20 File Export Path

2. QR code export

The QR code is exported to generate the QR code, and the Bluetooth channel can be connected by scanning the QR code, to transmit the configuration file.

(1) Enter the Quick Configuration, click [QR code export], and if the following interface pops up, it indicates successful export. Click OK:

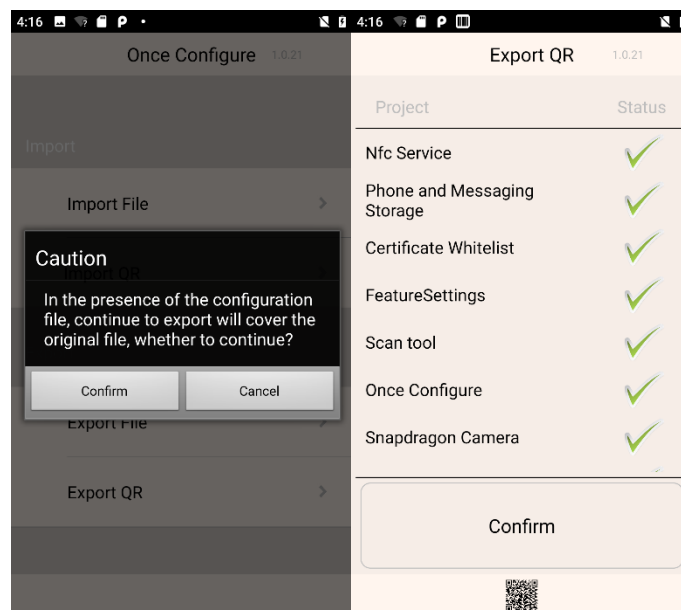

Figure 8-21 QR Code Export

(2) The generated QR code image is at the bottom of the application. Click the small QR code icon to view it.



Figure 8-22 QR Code Image

8.5 Feature Settings

This application is used for the rapid realization of special needs of customers, to make it convenient for customers to use quickly.

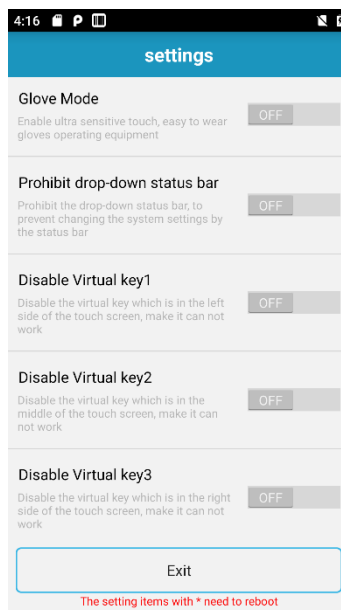

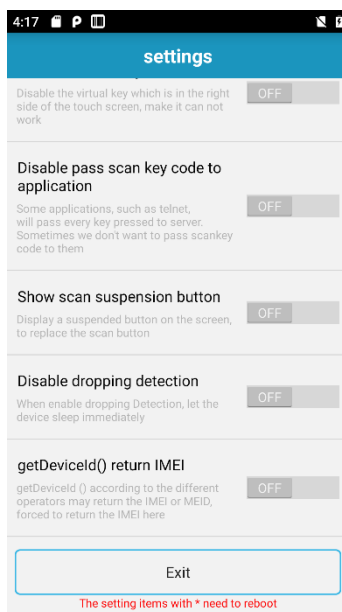

Figure 8-23 Feature Settings

8.5.1 Touch Screen Glove Mode

Enable this function, the touch screen can be operated with gloves, and the sensitivity of the touch screen is high;

8.5.2 Disable Status Drop-down

Enable this function

This function will take effect immediately and the menu cannot be dropped down.

Disable this function

This function will take effect immediately and the menu can be dropped down normally.

8.5.3 Shield Virtual Key 1

Enable this function: The virtual return key on the left side of the screen is not available

Disable this function: The virtual Return key on the left side of the screen can be executed normally

8.5.4 Shield Virtual Key 2

Enable this function: The virtual key in the middle of the screen is not available

Disable this function: The virtual Home key in the middle of the screen can be executed normally

Shield Virtual Key 3

Enable this function: The virtual return key on the right side of the screen is not available

Disable this function: The virtual Menu key on the right side of the screen can be executed normally

8.5.6 Disable Transferring the Key Value of Scan Key to Application

Enable this function

Some applications such as Telnet program will transfer all the key values pressed to the server

Disable this function

In some cases, disable the applications such as Telnet program to transfer all the key values pressed to the server

8.5.7 Display Scan Hover Button

Disable this function

The scan hover button is not displayed at the bottom of the screen

This feature is enabled

The scan hover button hovers at the bottom of any interface of the device. Click the scanning head to light up and scan the barcode normally

8.5.8 Disable Drop Detection

Disable this function

If the device falls down accidentally, the system will automatically detect it and enter the screen-off sleep state

Enable this function

If the device falls down accidentally, the system will not close the screen and sleep

8.6 Digital Certificate White List

This software is used to add the specified digital certificate to the white list, and use the digital certificate in the white list in signature application. It is allowed to be installed directly when the system item “unknown source” is not opened. The default application password is: 4007770876.

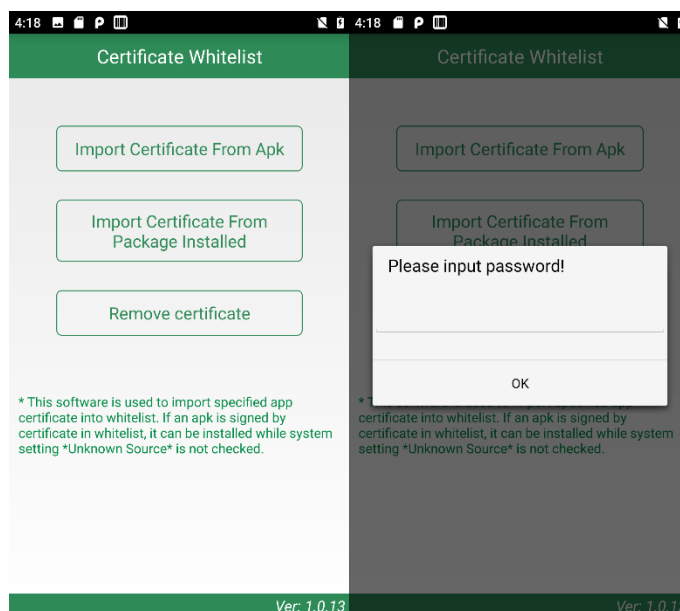

Figure 8-24 Digital Certificate White List

1. Import the certificate in APK file

The application will search all APK files under the internal storage device

directory, and display their file name and directory. After checking single or multiple display items, the user can click [Import] button to import the certificate in the selected APK file into the system.

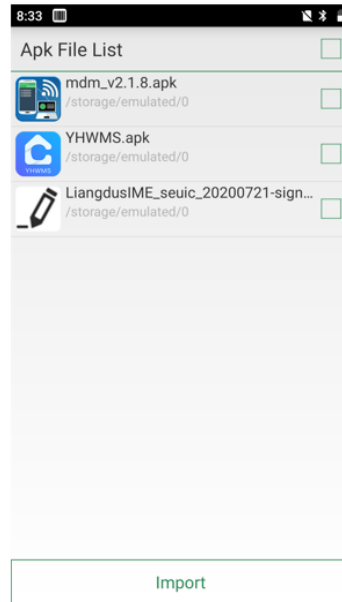

Figure 8-25 APK File Import List

2. Import the certificate in the installed package

The application will display the name of the third-party APP installed in the system and its package name. After checking single or multiple display items, the user can click [Import] button to import the certificate in the selected APK file into the system.

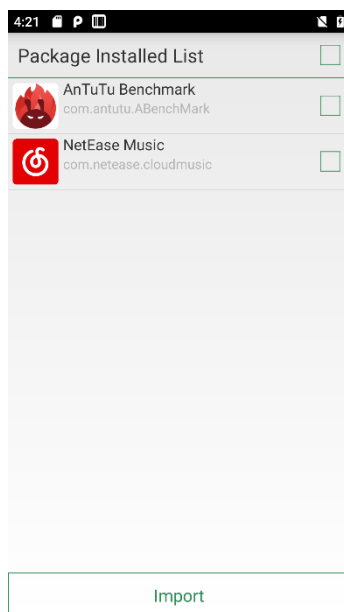

Figure 8-26 List of Installed Package Names

3. Remove the certificate from the whitelist

The application will display the name of the certificate that has been added. Check single or multiple display items and click [Remove] to delete the corresponding certificate from the system white list. The items displayed in gray and without check box are default system certificates and cannot be deleted.

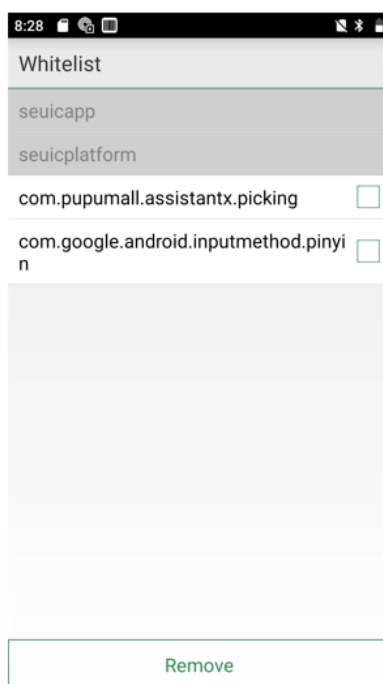

Figure 8-27 Signature White List Category

Precautions:

The added certificate will be named after the package name of the APP.

For certificates with the same content but different package names, only one record is saved and named after the first record.

Chapter IX Troubleshooting

Problem	Causes	Solutions
After pressing the Power button, the device is not powered on	The battery is too low or not charged	Charge the battery or replace it
	The button is pressed momentarily	Press and hold the button for 3S
	Incorrect battery installation	Install the battery correctly
	System crashes	Perform soft resetting
The rechargeable battery is no longer charged	Battery failure	Replace the battery
	Battery temperature is too high / low	Put the battery in room-temperature environment
There is no sound	The volume is set to be too low or has been turned off	Adjust the volume
The device is closed by itself	The device is in inactive state	When the device has been in inactive state for a period of time, the mobile data terminal will shut down. You can set this time period to be from 15S to 30Min, or never sleep.
	The battery runs out	Charge the battery or replace it
The barcode is not encoded when reading	Scan tool program is not enabled	Load the scan application program
	The device is in the barcode setting or application setting interface	Set the scanner program to the scan interface, or hide the scanner program
	The barcode is not readable	Make sure there are no defects in the barcode
	Barcode decoding function is not enabled	Enter the barcode setting and enable the corresponding decoding
	The device does not support decoding of this barcode type	
	The distance between the	Place the device within the

	device and the barcode is not appropriate.	correct scanning range.
No Bluetooth device is found nearby	Too far away from other Bluetooth devices	Move the device closer to other Bluetooth devices, within 10 meters (32.8 feet).
	The nearby Bluetooth device is not turned on	Turn on the Bluetooth device you want to find
	The Bluetooth device is not in discoverable mode	Set the Bluetooth device in discoverable mode
Unable to connect to AP	Show “There is a problem in identity authentication”	Wrong WLAN password
Unable to take pictures	Prompt “no storage device”	Exit USB storage mode
	Prompt “Camera failure”	Turn off the QR code. The camera cannot be enabled when lightening the QR code
	Prompt “SD card space is insufficient”	Clear memory or switch the storage location
Unable to access the Internet with mobile data	Mobile data is disabled	Enter the settings and enable the data network
	The network mode selection is incorrect, and SIM card is not registered	Enter the settings and select the correct network mode
	SIM card arrears	Recharge the SIM card in time

Introduction to Optional Accessories

Please keep the original packing box and packing materials for use in future maintenance or storage. The following accessories can better improve your work, and you can choose according to your needs.

- ▶ USB cable
- ▶ Power adapter
- ▶ Removable battery

This device complies with part 15 of the FCC rules. Operation is subject to the following two conditions:

- (1) this device may not cause harmful interference, and
- (2) this device must accept any interference received, including interference that may cause undesired operation.

The manufacturer is not responsible for any radio or TV interference caused by unauthorized modifications or changes to this equipment. Such modifications or changes could void the user's authority to operate the equipment.

This equipment has been tested and found to comply with the limits for a Class B digital device, pursuant to part 15 of the FCC Rules. These limits are designed to provide reasonable protection against harmful interference in a residential installation. This equipment generates uses and can radiate radio frequency energy and, if not installed and used in accordance with the instructions, may cause harmful interference to radio communications. However, there is no guarantee that interference will not occur in a particular installation. If this equipment does cause harmful interference to radio or television reception, which can be determined by turning the equipment off and on, the user is encouraged to try to correct the interference by one or more of the following measures:

- Reorient or relocate the receiving antenna.
- Increase the separation between the equipment and receiver.
- Connect the equipment into an outlet on a circuit different from that to which the receiver is connected.
- Consult the dealer or an experienced radio/TV technician for help.

The SAR limit of USA (FCC) is 1.6 W/kg averaged over one gram of tissue. Device types Handheld RFID Reader (FCC ID: 2AC68-AUTOIDUTOUCH) has also been tested against this SAR limit. The highest SAR value reported under this standard during product certification for use when properly worn on the body is 1.147 W/kg and for head is 1.272 W/kg. Simultaneous RF exposure is 1.532W/Kg. This device was tested for typical body-worn operations with the back of the handset kept 10mm from the body. To maintain compliance with FCC RF exposure requirements, use accessories that maintain a 10mm separation distance between the user's body and the back of the handset. The use of belt clips, holsters and similar accessories should not contain metallic components in its assembly. The use of accessories that do not satisfy these requirements may not comply with FCC RF exposure requirements, and should be avoided.