



TEST REPORT

APPLICANT : SEUIC Technologies Co., Ltd.
PRODUCT NAME : Handheld RFID Reader
MODEL NAME : AUTOID UTouch
BRAND NAME : Seuic
FCC ID : 2AC68-AUTOIDUTOUCH
STANDARD(S) : 47 CFR Part 15 Subpart E
RECEIPT DATE : 2021-10-27
TEST DATE : 2021-11-01 to 2021-11-10
ISSUE DATE : 2021-12-20

Edited by: Peng Mi
Peng Mi (Rapporteur)
Approved by: Shen Junsheng
Shen Junsheng (Supervisor)

NOTE: This document is issued by Shenzhen Morlab Communications Technology Co., Ltd., the test report shall not be reproduced except in full without prior written permission of the company. The test results apply only to the particular sample(s) tested and to the specific tests carried out which is available on request for validation and information confirmed at our website.





DIRECTORY

- 1. Technical Information..... 3**
- 1.1. Applicant and Manufacturer Information 3**
- 1.2. Equipment Under Test (EUT) Description 3**
- 1.3. Companion Equipment(Master) Description 4**
- 1.4. The Channel Number and Frequency..... 5**
- 1.5. Test Standards and Results..... 6**
- 1.6. Environmental Conditions..... 6**
- 2. 47 CFR Part 15E Requirements..... 7**
- 2.1. Transmit Power Control (TPC) and Dynamic Frequency Selection (DFS) 7**
- Annex A Test Uncertainty 19**
- Annex B Testing Laboratory Information 20**

Change History		
Version	Date	Reason for change
1.0	2021-12-20	First edition



1. Technical Information

Note: Provide by applicant.

1.1. Applicant and Manufacturer Information

Applicant:	SEUIC Technologies Co., Ltd.
Applicant Address:	NO.15 Xinghuo Road, Nanjing New & High Technology Industry Development Zone, 210061, Nanjing City, Jiangsu Province, China
Manufacturer:	SEUIC Technologies Co., Ltd.
Manufacturer Address:	NO.15 Xinghuo Road, Nanjing New & High Technology Industry Development Zone, 210061, Nanjing City, Jiangsu Province, China

1.2. Equipment Under Test (EUT) Description

Product Name:	Handheld RFID Reader
Sample No.:	5#
Hardware Version:	SLB761XC-64B_MB_PCBA_V1.00
Software Version:	V0.2.6.1
Modulation Type:	OFDM
Modulation Mode:	802.11a, 802.11n (HT20), 802.11n (HT40) 802.11ac (VHT20), 802.11ac (VHT40), 802.11ac (VHT80)
Operating Frequency Range:	5180MHz-5240MHz; 5260MHz-5320MHz; 5500MHz-5720MHz; 5745MHz-5825MHz
Channel Number:	Refer to 1.4
Antenna Type:	Dipole Antenna
Antenna Gain:	2.50dBi



Accessory Information:	Battery 1	
	Brand Name:	N/A
	Model No.:	D500HB-V1(1S2P)
	Serial No.:	N/A
	Capacity:	6200mAh
	Rated Voltage:	3.6V
	Charge Limit:	4.2V
	Manufacturer:	Suzhou Xinfeibo Electronic Technology Co.,Ltd.
	Battery 2	
	Brand Name:	N/A
	Model No.:	BOB320724
	Serial No.:	N/A
	Capacity:	57mAh
	Rated Voltage:	3.8V
	Charge Limit:	4.35V
	Manufacturer:	DONGGUAN BOB ELECTRONICS CO.,LTD
	AC Adapter	
	Brand Name:	Tianyin
	Model No.:	TPA-23A050200UU01
	Serial No.:	N/A
	Rated Output:	5V \Rightarrow 2A
Rated Input:	100-240V \sim 50/60Hz, 0.3A	
Manufacturer:	Shenzhen Tianyin Electronics Co.,Ltd	

Note 1: WiFi hotspot only support U-NII-1 and U-NII-3 band.

Note 2: For a more detailed description, please refer to Specification or User's Manual supplied by the applicant and/or manufacturer.

1.3. Companion Equipment(Master) Description

Product Name:	Router
Manufacturer:	Cisco
FCC ID:	LDK102091
Serial No:	FGL1848X9S5
Antenna Gain:	2.1dBi

1.4. The Channel Number and Frequency

(U-NII-1) 5180MHz-5240MHz				
Bandwidth	Channel	Frequency (MHz)	Channel	Frequency (MHz)
20MHz	36	5180	40	5200
	44	5220	48	5240
40MHz	38	5190	46	5230
80MHz	42	5210		
(U-NII-2A) 5260MHz-5320MHz				
Bandwidth	Channel	Frequency (MHz)	Channel	Frequency (MHz)
20MHz	52	5260	56	5280
	60	5300	64	5320
40MHz	54	5270	62	5310
80MHz	58	5290		
(U-NII-2C) 5500MHz-5720MHz				
Bandwidth	Channel	Frequency (MHz)	Channel	Frequency (MHz)
20MHz	100	5500	105	5520
	108	5540	112	5560
	116	5580	120	5600
	124	5620	128	5640
	132	5660	136	5680
	140	5700	144	5720
40MHz	102	5510	110	5550
	118	5590	126	5630
	134	5670	142	5710
80MHz	106	5530	122	5610
	138	5690		
(U-NII-3) 5745MHz-5825MHz				
Bandwidth	Channel	Frequency (MHz)	Channel	Frequency (MHz)
20MHz	149	5745	153	5765
	157	5785	161	5805
	165	5825		
40MHz	151	5775	159	5795
80MHz	155	5775		

Note 1: The black bold channels were selected for test.



1.5. Test Standards and Results

The objective of the report is to perform testing according to 47 CFR Part 15 Subpart E (U-NII band) for the EUT FCC ID Certification:

No.	Identity	Document Title
1	47 CFR Part 15 (5-1-14 Edition)	Radio Frequency Devices

Test detailed items/section required by FCC rules and results are as below:

No.	Section	Description	Test Date	Test Engineer	Result	Method Determination /Remark
1	15.407(h)	TPC and DFS	Nov 10, 2021	Meng Shurui	PASS	No deviation

Note 1: The DFS section for U-NII band is applicable to this report; the other test items are documented in a separate report.

Note 2: These RF tests were performed according to the method of measurements prescribed in KDB 905462 D02 UNII DFS Compliance Procedures New Rules v02.

Note 3: Additions to, deviation, or exclusions from the method shall be judged in the "method determination" column of add, deviate or exclude from the specific method shall be explained in the "Remark" of the above table.

Note 4: When the test result is a critical value, we will use the measurement uncertainty give the judgment result based on the 95% confidence intervals.

1.6. Environmental Conditions

During the measurement, the environmental conditions were within the listed ranges:

Temperature (°C):	15-35
Relative Humidity (%):	30-60
Atmospheric Pressure (kPa):	86-106



2. 47 CFR Part 15E Requirements

2.1. Transmit Power Control (TPC) and Dynamic Frequency Selection (DFS)

2.1.1. Requirement

According to FCC section 15.407(h), (1) Transmit power control (TPC). U-NII devices operating in the 5.25-5.35 GHz band and the 5.47-5.725 GHz band shall employ a TPC mechanism. The U-NII device is required to have the capability to operate at least 6 dB below the mean EIRP value of 30 dBm. A TPC mechanism is not required for systems with an e.i.r.p. of less than 500 mW. (2) Radar Detection Function of Dynamic Frequency Selection (DFS). U-NII devices operating with any part of its 26 dB emission bandwidth in the 5.25-5.35 GHz and 5.47-5.725 GHz bands shall employ a DFS radar detection mechanism to detect the presence of radar systems and to avoid co-channel operation with radar systems. Operators shall only use equipment with a DFS mechanism that is turned on when operating in these bands. The device must sense for radar signals at 100 percent of its emission bandwidth. The minimum DFS detection threshold for devices with a maximum e.i.r.p. of 200 mW to 1 W is -64 dBm. For devices that operate with less than 200 mW e.i.r.p. and a power spectral density of less than 10 dBm in a 1 MHz band, the minimum detection threshold is -62 dBm. The detection threshold is the received power averaged over 1 microsecond referenced to a 0 dBi antenna. For the initial channel setting, the manufacturers shall be permitted to provide for either random channel selection or manual channel selection.

A U-NII network will employ a DFS function to detect signals from radar systems and to avoid co-channel operation with these systems. This applies to the 5250-5350 MHz and/or 5470-5725 MHz bands.1

Within the context of the operation of the DFS function, a U-NII device will operate in either Master Mode or Client Mode. U-NII devices operating in Client Mode can only operate in a network controlled by a U-NII device operating in Master Mode.2

Tables 1 and 2 shown below summarize the information contained in sections 5.1.1 and 5.1.2.

Table 1: Applicability of DFS Requirements Prior to Use of a Channel

Requirement	Operational Mode		
	Master	Client Without Radar Detection	Client With Radar Detection
Non-Occupancy Period	Yes	Not required	Yes
DFS Detection Threshold	Yes	Not required	Yes
Channel Availability Check Time	Yes	Not required	Not required
U-NII Detection Bandwidth	Yes	Not required	Yes



Table 2: Applicability of DFS requirements during normal operation

Requirement	Operational Mode	
	Master	Client Without Radar Detection
DFS Detection Threshold	Yes	Not required
Channel Closing Transmission Time	Yes	Yes
Channel Move Time	Yes	Yes
U-NII Detection Bandwidth	Yes	Not required

Additional requirements for devices with multiple bandwidth modes	Master Device or Client with Radar Detection	Client Without Radar Detection
U-NII Detection Bandwidth and Statistical Performance Check	All BW modes must be tested	Not required
Channel Move Time and Channel Closing Transmission Time	Test using widest BW mode available	Test using the widest BW mode available for the link
All other tests	Any single BW mode	Not required
Note: Frequencies selected for statistical performance check (Section 7.8.4) should include several frequencies within the radar detection bandwidth and frequencies near the edge of the radar detection bandwidth. For 802.11 devices it is suggested to select frequencies in each of the bonded 20 MHz channels and the channel center frequency.		

The operational behavior and individual DFS requirements that are associated with these modes are as follows:

Master Devices

- a) The Master Device will use DFS in order to detect Radar Waveforms with received signal strength above the DFS Detection Threshold in the 5250 – 5350 MHz and 5470 – 5725 MHz bands. DFS is not required in the 5150 – 5250 MHz or 5725 – 5825 MHz bands.
- b) Before initiating a network on a Channel, the Master Device will perform a Channel Availability Check for specified time duration (Channel Availability Check Time) to ensure that there is no radar system operating on the Channel, using DFS described under subsection a) above.
- c) The Master Device initiates a U-NII network by transmitting control signals that will enable other U-NII devices to Associate with the Master Device.
- d) During normal operation, the Master Device will monitor the Channel (In-Service Monitoring) to ensure that there is no radar system operating on the Channel, using DFS described under a).
- e) If the Master Device has detected a Radar Waveform during In-Service Monitoring as described under d), the Operating Channel of the U-NII network is no longer an Available Channel. The Master Device will instruct all associated Client Device(s) to stop transmitting on this Channel within the Channel Move Time. The transmissions during the Channel Move Time will be limited to the Channel Closing Transmission Time.



f) Once the Master Device has detected a Radar Waveform it will not utilize the Channel for the duration of the Non-Occupancy Period. 3.

g) If the Master Device delegates the In-Service Monitoring to a Client Device, then the combination will be tested to the requirements described under d) through f) above.

Client Devices

a) A Client Device will not transmit before having received appropriate control signals from a Master Device.

b) A Client Device will stop all its transmissions whenever instructed by a Master Device to which it is associated and will meet the Channel Move Time and Channel Closing Transmission Time requirements. The Client Device will not resume any transmissions until it has again received control signals from a Master Device.

c) If a Client Device is performing In-Service Monitoring and detects a Radar Waveform above the DFS Detection Threshold, it will inform the Master Device. This is equivalent to the Master Device detecting the Radar Waveform and d) through f) of section 5.1.1 apply.

d) Irrespective of Client Device or Master Device detection the Channel Move Time and Channel Closing Transmission Time requirements remain the same.

e) The client test frequency must be monitored to ensure no transmission of any type has occurred for 30 minutes. Note: If the client moves with the master, the device is considered compliant if nothing appears in the client non-occupancy period test. For devices that shut down (rather than moving channels), no beacons should appear.

DFS Detection Thresholds

Table 3 below provides the DFS Detection Thresholds for Master Devices as well as Client Devices incorporating In-Service Monitoring.

Table 3: DFS Detection Thresholds for Master Devices and Client Devices with Radar Detection

Maximum Transmit Power	Value (See Notes 1, 2, and 3)
EIRP \geq 200 mill watt	-64 dBm
EIRP < 200 mill watt and power spectral density < 10 dBm/MHz	-62 dBm
EIRP < 200 mill watt that do not meet the power spectral density requirement	-64 dBm
Note 1: This is the level at the input of the receiver assuming a 0 dBi receive antenna. Note 2: Throughout these test procedures an additional 1 dB has been added to the amplitude of the test transmission waveforms to account for variations in measurement equipment. This will ensure that the test signal is at or above the detection threshold level to trigger a DFS response. Note3: EIRP is based on the highest antenna gain. For MIMO devices refer to KDB Publication 662911 D01.	

Response Requirements

Table 4 provides the response requirements for Master and Client Devices incorporating DFS.

Table 4: DFS Response Requirement Values

Parameter	Value
Non-occupancy period	Minimum 30 minutes
Channel Availability Check Time	60 seconds
Channel Move Time	10 seconds See Note 1.
Channel Closing Transmission Time	200 milliseconds + an aggregate of 60 milliseconds over remaining 10 second period. See Notes 1 and 2.
U-NII Detection Bandwidth	Minimum 100% of the U-NII 99% transmission power bandwidth. See Note 3.
<p>Note 1: Channel Move Time and the Channel Closing Transmission Time should be performed with Radar Type 0. The measurement timing begins at the end of the Radar Type 0 burst.</p> <p>Note 2: The Channel Closing Transmission Time is comprised of 200 milliseconds starting at the beginning of the Channel Move Time plus any additional intermittent control signals required to facilitate a Channel move (an aggregate of 60 milliseconds) during the remainder of the 10 second period. The aggregate duration of control signals will not count quiet periods in between transmissions.</p> <p>Note 3: During the U-NII Detection Bandwidth detection test, radar type 0 should be used. For each frequency step the minimum percentage of detection is 90 percent. Measurements are performed with no data traffic.</p>	

2.1.1. Test Description

According to Section 7.2 of KDB 905462 D02 V01R01

1. Setup for Master with injection at the Master

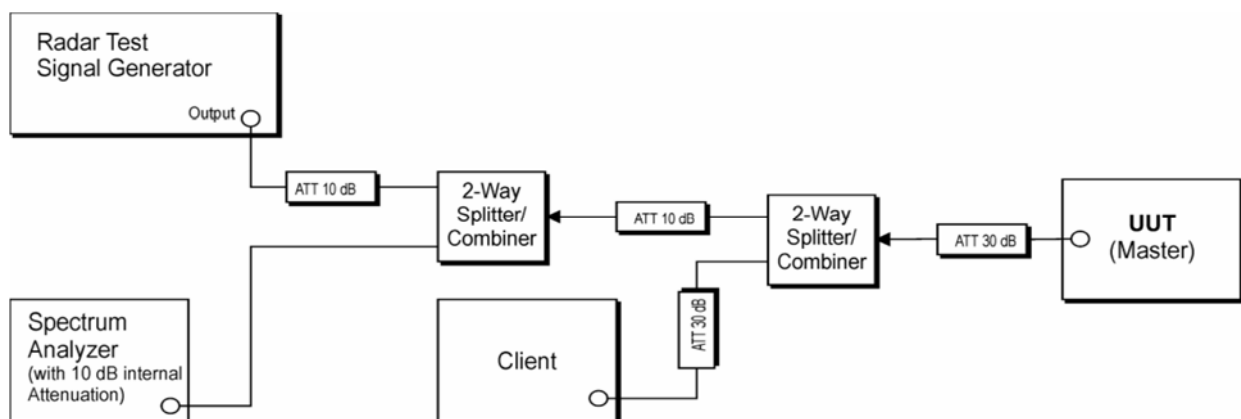

(Example Conducted Setup where UUT is a Master and Radar Test Waveforms are injected into the Master)

2. Setup for Client with injection at the Master

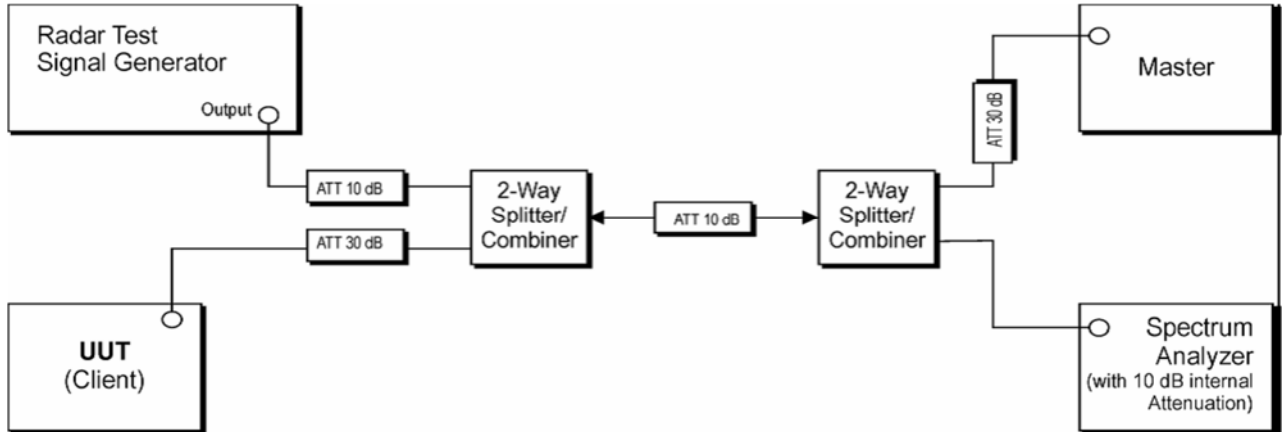

(Example Conducted Setup where UUT is a Client and Radar Test Waveforms are injected into the Master)

3. Setup for Client with injection at the Client

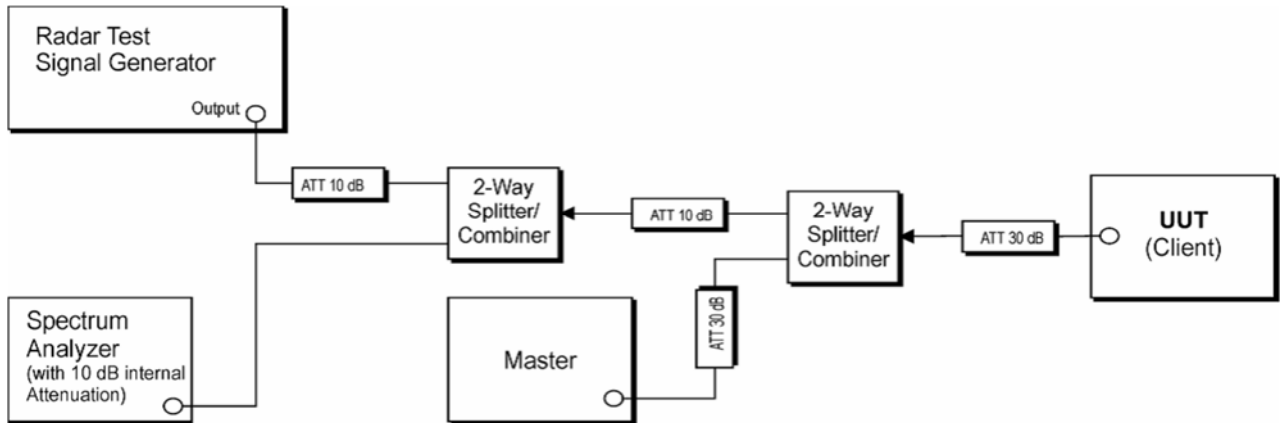

(Example Conducted Setup where UUT is a Client and Radar Test Waveforms are injected into the Client)



2.1.2. Test Result

a. Test sequence and Channel loading between Master and Client

Test Channel	Frequency(MHz)	Payload
62	5310	40.13%

Test Plot

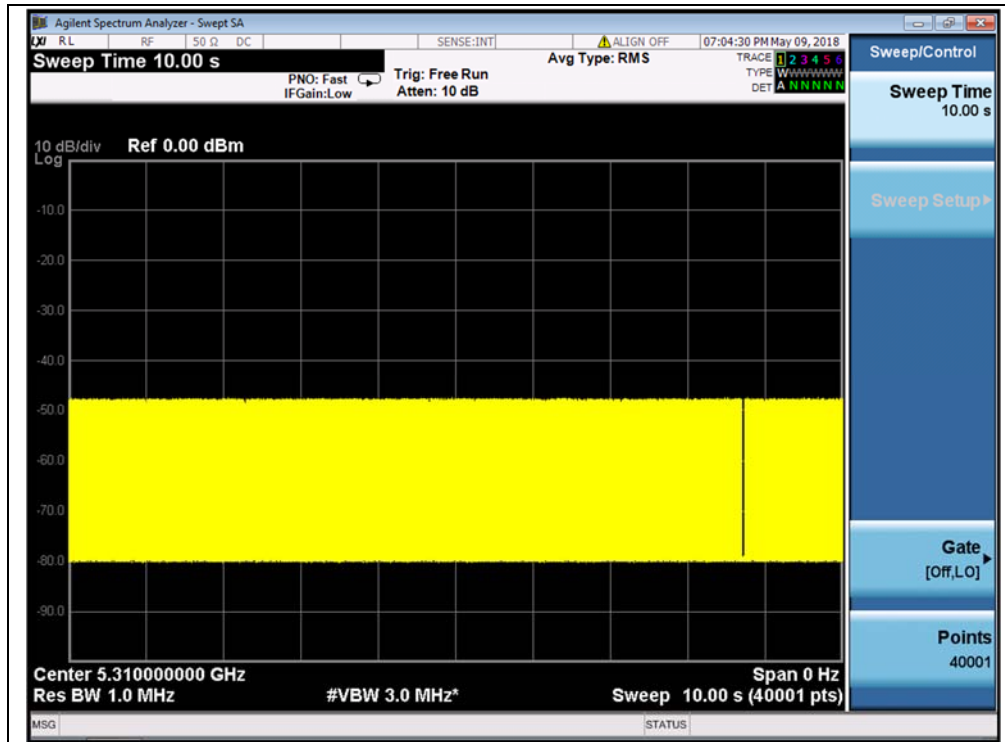

(Test sequence)

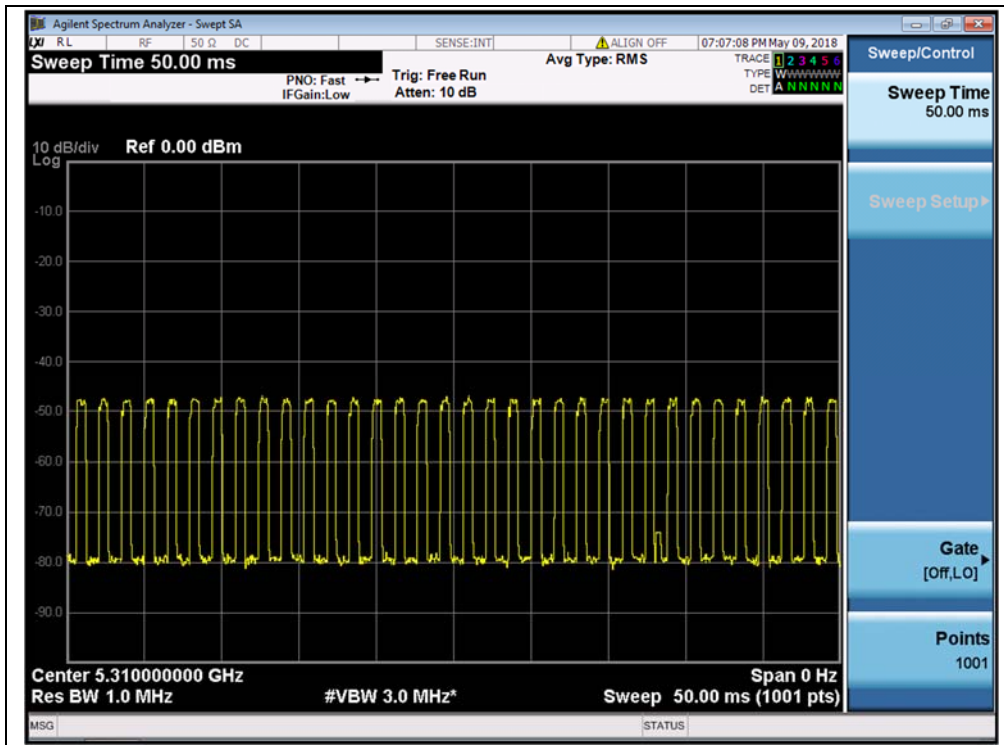

(Payload)



b.Radar Test Waveforms are injected into the Master:

Test Mode	Channel	Radar Type	Result	Limit[dbm]	Verdict
11AC20SISO	5320	Reference	-62.72	-59.00	PASS
	5500	Reference	-63.12	-59.00	PASS
11AC80SISO	5290	Reference	-62.19	-59.00	PASS
	5530	Reference	-62.73	-59.00	PASS

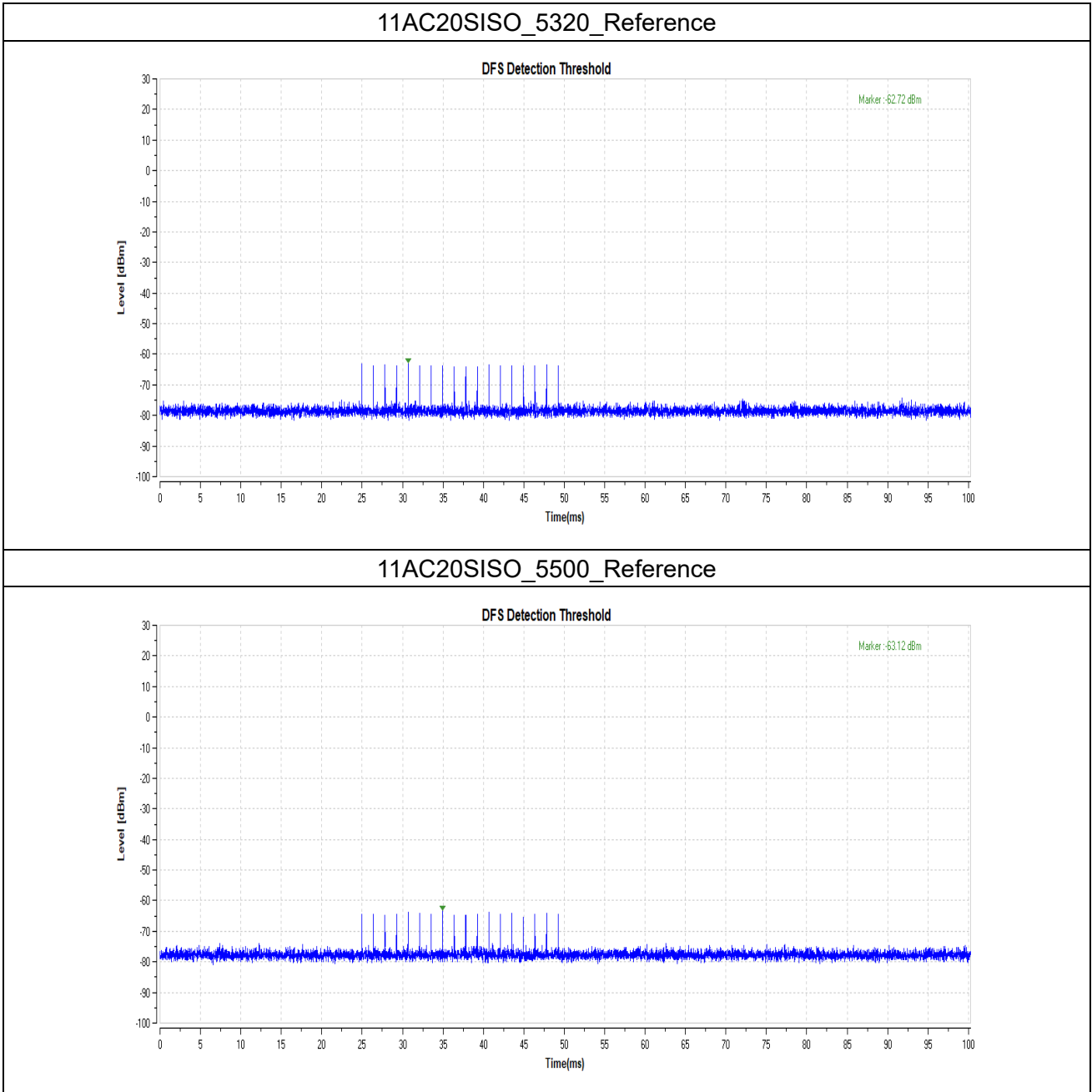



11AC80SISO_5290_Reference

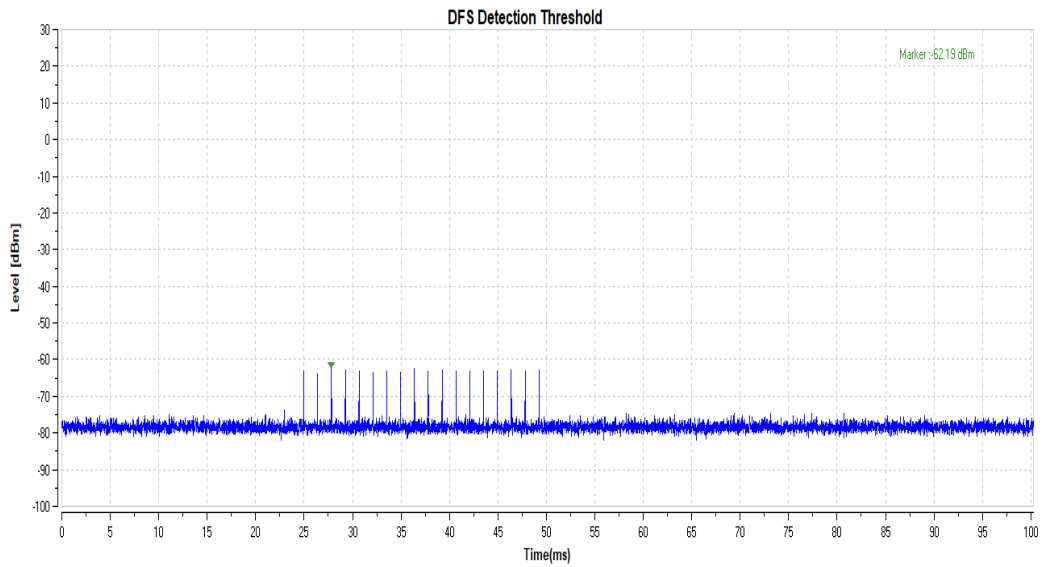

11AC80SISO_5530_Reference

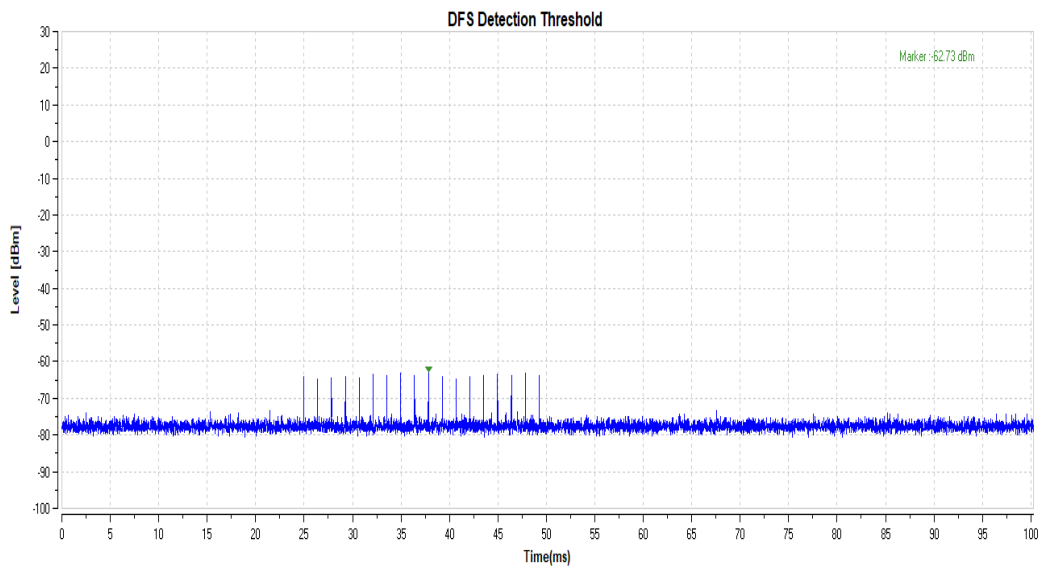



c.EUT is a Client Device Without Radar Detection :

Test Mode	Channel	CCT[ms]	Limit[ms]	CMT[ms]	Limit[ms]	Verdict
11AC20SISO	5320	24.3	260	787.32	10000	PASS
	5500	14.58	260	741.96	10000	PASS
11AC80SISO	5290	21.06	260	785.7	10000	PASS
	5530	35.64	260	829.44	10000	PASS

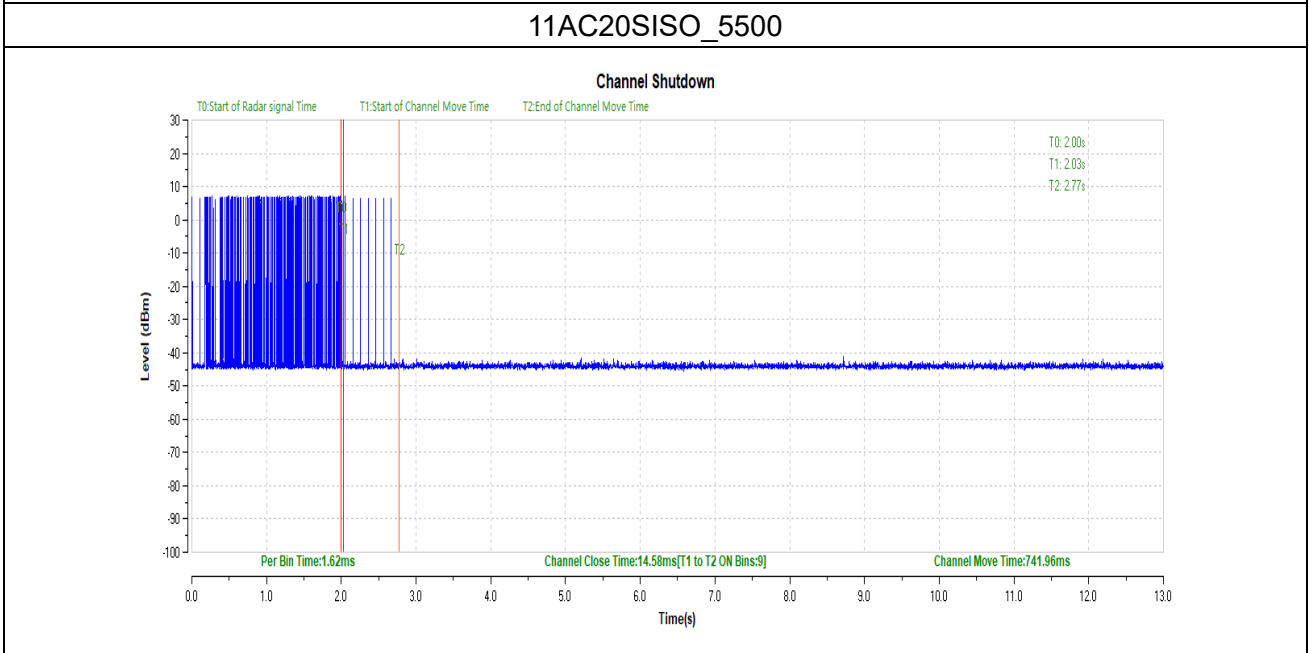
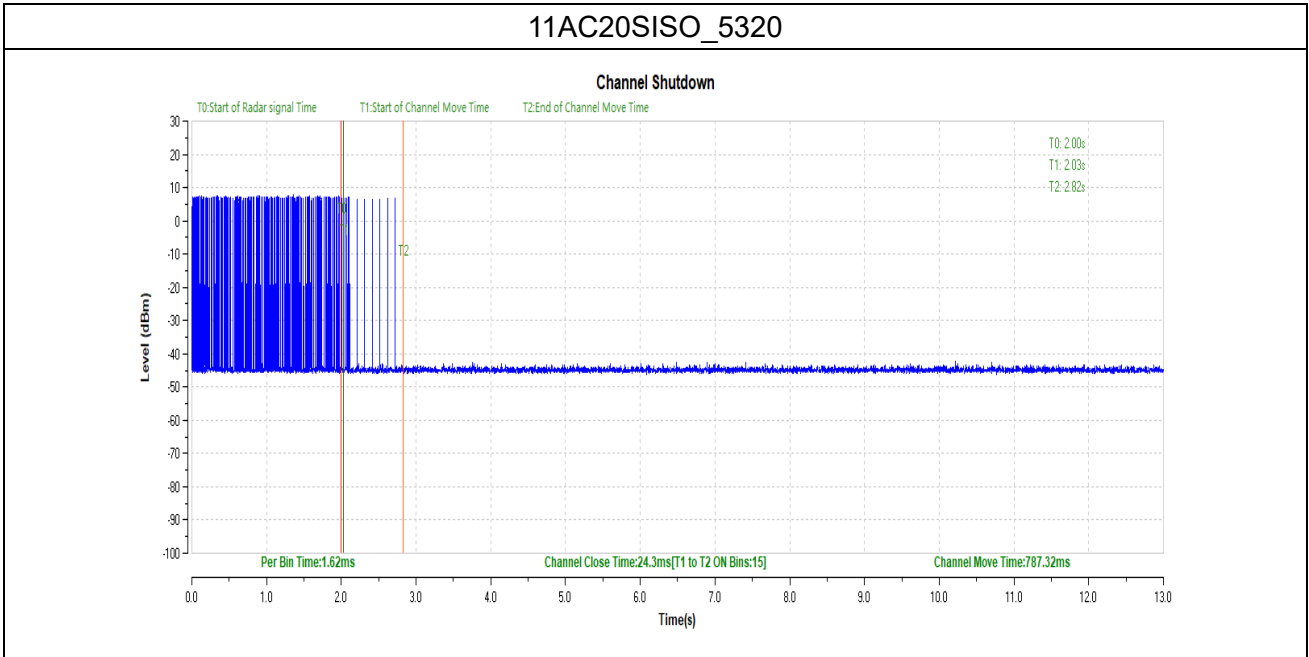



11AC80SISO_5290

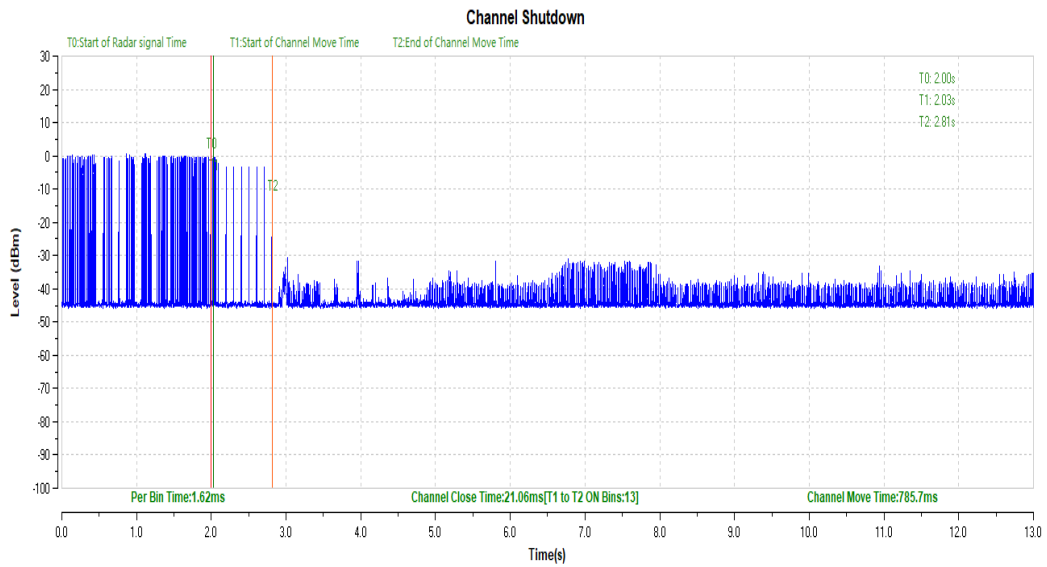

11AC80SISO_5530

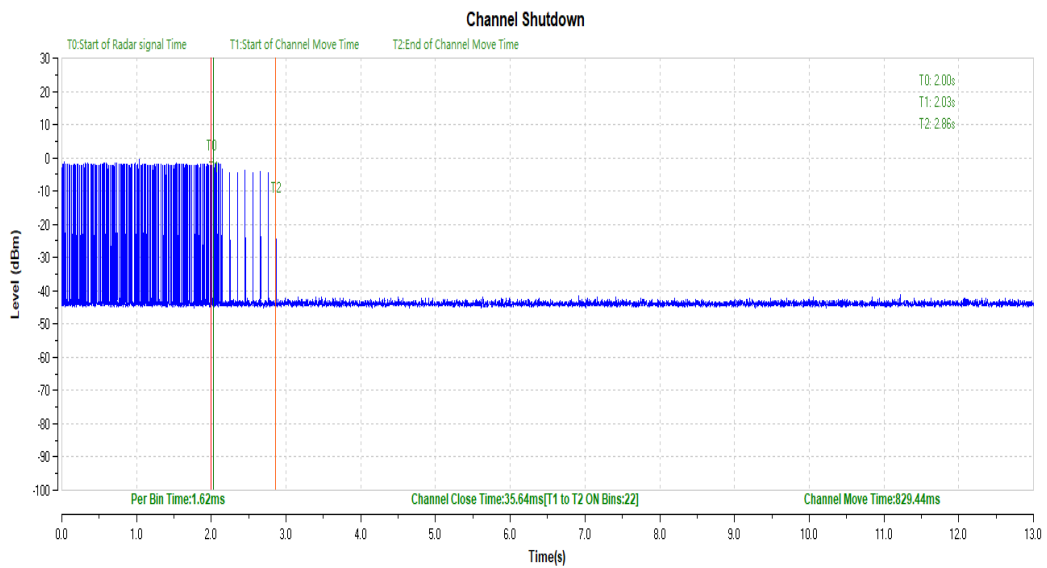



d.verification of Non-occupancy time

Test Mode	Channel	Result	Limit[s]	Verdict
11AC20SISO	5320	See Test Graph	>=1800	PASS
	5500	See Test Graph	>=1800	PASS

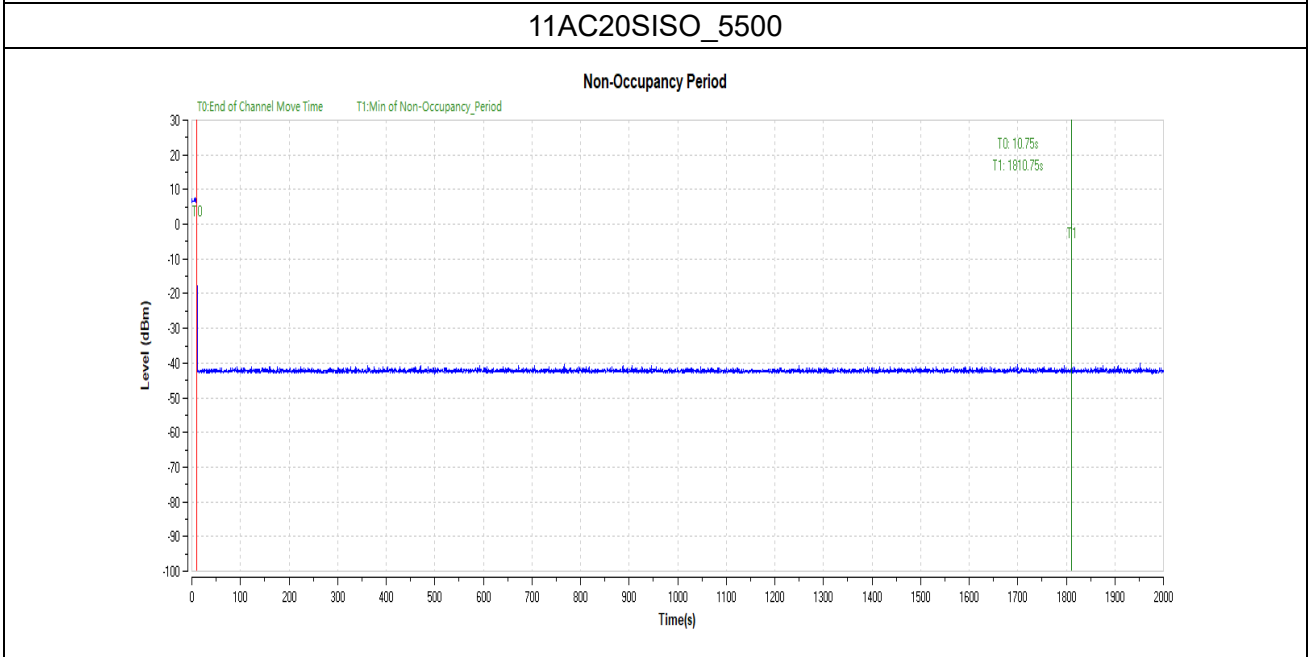
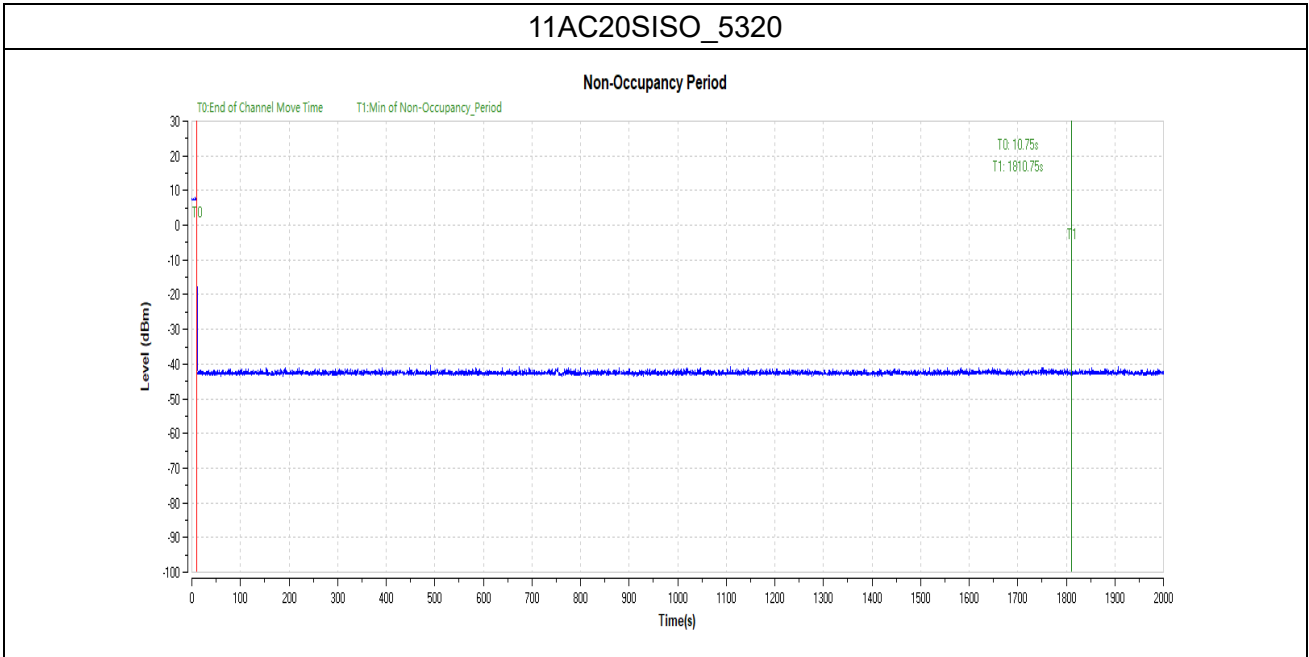



Annex A Test Uncertainty

Where relevant, the following measurement uncertainty levels have been estimated for test performed on the EUT as specified in CISPR 16-1-2:

Test Items	Uncertainty
Bandwidth	±5%
Conducted Emission	±2.44dB

This uncertainty represent an expanded uncertainty expressed at approximately the 95% confidence level using a coverage factor of k=2.



Annex B Testing Laboratory Information

1. Identification of the Responsible Testing Laboratory

Laboratory Name:	Shenzhen Morlab Communications Technology Co., Ltd.
Laboratory Address:	FL.3, Building A, FeiYang Science Park, No.8 LongChang Road, Block 67, BaoAn District, ShenZhen, GuangDong Province, P. R. China
Telephone:	+86 755 36698555
Facsimile:	+86 755 36698525

2. Identification of the Responsible Testing Location

Name:	Shenzhen Morlab Communications Technology Co., Ltd.
Address:	FL.3, Building A, FeiYang Science Park, No.8 LongChang Road, Block 67, BaoAn District, ShenZhen, GuangDong Province, P. R. China

3. Facilities and Accreditations

All measurement facilities used to collect the measurement data are located at FL.3, Building A, FeiYang Science Park, Block 67, BaoAn District, Shenzhen, 518101 P. R. China. The test site is constructed in conformance with the requirements of ANSI C63.10-2013 and CISPR Publication 22; the FCC designation number is CN1192, the test firm registration number is 226174.



4. Test Equipments Utilized

4.1 Conducted Test Equipments

Equipment Name	Serial No.	Type	Manufacturer	Cal. Date	Due Date
Power Splitter	N/A	N/A	N/A	N/A	N/A
Attenuator 1	N/A	N/A	N/A	N/A	N/A
Attenuator 2	N/A	N/A	N/A	N/A	N/A
EXA Signal Analyzer	MY53470836	N9010A	Agilent	2021.03.25	2022.03.24
MXG Vector Signal Generator	MY53050961	N5182B	Agilent	2021.03.25	2022.03.24
RF Cable (30MHz-26GHz)	CB01	RF01	Morlab	N/A	N/A
Coaxial Cable	CB02	RF02	Morlab	N/A	N/A
SMA Connector	CN01	RF03	HUBER-SUHNER	N/A	N/A

————— END OF REPORT —————