



RF TEST REPORT

Report No.: SET2015-03810

Product: Industrial Handheld Terminal

FCC ID: 2AC68-AUTOID9

Model No.: AUTOID9 AUTOID9HC

Applicant: Jiangsu SEUIC Technology Co.,Ltd.

Address: No 23, Wenzhu Road, Yuhuatai District, Nanjing, Jiangsu, China

Dates of Testing: 2015.03.15 to 2015.03.27

Issued by: CCIC-SET

Lab Location: Electronic Testing Building, Shahe Road, Xili, Nanshan District, Shenzhen China

Tel: 86 755 26627338 **Fax:** 86 755 26627238

This test report consists of 73 pages in total. It may be duplicated completely for legal use with the approval of the applicant. It should not be reproduced except in full, without the written approval of our laboratory. The client should not use it to claim product endorsement by CCIC-SET. The test results in the report only apply to the tested sample. The test report shall be invalid without all the signatures of testing engineers, reviewer and approver. Any objections must be raised to CCIC-SET within 15 days since the date when the report is received. It will not be taken into consideration beyond this limit.



Test Report

Product.....: Industrial Handheld Terminal

Brand Name.....: AUTOID

Trade Name.....: SEUIC

Applicant.....: Jiangsu SEUIC Technology Co.,Ltd.

Applicant Address.....: No 23, Wenzhu Road,Yuhuatai District, Nanjing, Jiangsu, China

Manufacturer.....: Jiangsu SEUIC Technology CO.,Ltd.

Manufacturer Address.....: Nanjing High-tech Development Zone software center 406#

Test Standards.....: 47 CFR FCC Part 2: 2013
47 CFR FCC Part 22(H): 2013
47 CFR FCC Part 24(E): 2013

Test Result.....: PASS

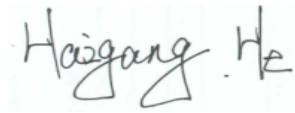
Tested by.....: 
2015.03.27
Haigang He, Test Engineer

Reviewed by.....: 
2015.03.27
Zhu Qi, Senior EGINEER

Approved by.....: 
2015.03.27
Wu Li'an, Manager



Table of Contents

- 1. GENERAL INFORMATION4**
- 1.1 EUT Description4**
- 1.2 Maximum ERP/EIRP Power, Frequency Tolerance, and Emission Designator4**
- 1.3 Test Standards and Results.....5**
- 1.4 Test Configuration of Equipment under Test.....6**
- 1.5 Measurement Results Explanation Example6**
- 1.6 Facilities and Accreditations7**
- 2. 47 CFR PART 2, PART 22H & 24E REQUIREMENTS8**
- 2.1 Conducted RF Output Power8**
- 2.2 Peak to Average Ratio 11**
- 2.3 99% Occupied Bandwidth19**
- 2.4 Frequency Stability.....36**
- 2.5 Conducted Out of Band Emissions40**
- 2.6 Band Edge57**
- 2.7 Transmitter Radiated Power (EIRP/ERP)63**
- 2.8 Radiated Out of Band Emissions67**

Change History		
Issue	Date	Reason for change
1.0	2015-03-27	First edition



1. GENERAL INFORMATION

1.1 EUT Description

EUT Type	Industrial Handheld Terminal
Hardware Version	D500_Main
Software Version	3.4.0
EUT supports Radios application	GSM/GPRS/EDGE/WCDMA/HSPA/HSPA+ WLAN2.4GHz 802.11a/b/g/n (HT20/HT40) Bluetooth v3.0+EDR Bluetooth v4.0 LE RFID
Frequency Range	GSM 850MHz: Tx: 824.2 - 848.8MHz (at intervals of 200kHz); Rx: 869.2 - 893.8MHz (at intervals of 200kHz) GSM 1900MHz: Tx: 1850.2 - 1909.8MHz (at intervals of 200kHz); Rx: 1930.2 - 1989.8MHz (at intervals of 200kHz) WCDMA 850MHz Tx: 826.4 - 846.6MHz (at intervals of 200kHz); Rx: 871.4 - 891.6MHz (at intervals of 200kHz)
Multislot Class.....:	GPRS: Multislot Class12,EGPRS: Multislot Class12
Maximum Output Power to Antenna	GSM 850: 33.43dBm GSM 1900: 30.46dBm EDGE 850: 30.34dBm EDGE 1900: 30.31dBm WCDMA 850: 23.37dBm
Antenna Type.....:	PIFA Antenna
Type of Modulation	GSM / GPRS:GMSK EDGE:GMSK / 8PSK WCDMA/HSPA/HSPA+: QPSK

1.2 Maximum ERP/EIRP Power, Frequency Tolerance, and Emission Designator

System	Type of Modulation	Emission Designator	Frequency Tolerance (ppm)	Maximum ERP/EIRP(W)
GSM 850	GMSK	246KGXW	0.05	2.183



GSM 1900	GMSK	246KGXW	0.03	1.084
EDGE 850	8PSK	244KG7W	0.05	1.782
EDGE 1900	8PSK	248KG7W	0.03	1.059
WCDMA 850 RMC 12.2Kbps	QPSK	4M17F9W	0.06	0.369

1.3 Test Standards and Results

1. 47 CFR Part 2, 22(H), 24(E)
2. ANSI / TIA / EIA-603-D-2010
3. FCC KDB 971168 D01 Power Meas. License Digital Systems v02r02

Remark:

1. All test items were verified and recorded according to the standards and without any deviation during the test.
2. This EUT has also been tested and complied with the requirements of FCC Part 15, Subpart B, recorded in a separate test report.

Test detailed items/section required by FCC/IC rules and results are as below:

No.	Section	Description	Limit	Result
	FCC			
1	2.1046	Conducted Output Power	Reporting Only	PASS
2	24.232(d)	Peak to Average Ratio	< 13dBm	PASS
3	2.1049 22.917(b) 24.238(b)	Occupied Bandwidth	Reporting Only	PASS
4	2.1055 22.355 24.235	Frequency Stability	$\leq \pm 2.5\text{ppm}$	PASS
5	2.1051 22.917 24.238	Conducted Out of Band Emissions	$< 43+10\log_{10}$ (P[Watts])	PASS
6	2.1051 22.917 24.238	Band Edge	$< 43+10\log_{10}$ (P[Watts])	PASS
7	22.913	Effective Radiated Power	< 7Watts	PASS
	24.232	Equivalent Isotropic Radiated Power	< 2Watts	PASS
8	2.1053	Radiated Spurious	$< 43+10\log_{10}$	PASS



	22.917	Emissions	(P[Watts])	
	24.238			

1.4 Test Configuration of Equipment under Test

Antenna port conducted and radiated test items were performed according to KDB 971168 D01 Power Meas. License Digital Systems v02r02 with maximum output power.

Radiated measurements were performed with rotating EUT in different three orthogonal test planes to find the maximum emission.

Radiated emissions were investigated as following frequency range:

1. 30 MHz to 9000 MHz for GSM850 and WCDMA Band V.

All modes and data rates and positions were investigated.

Test modes are chosen to be reported as the worst case configuration below:

Test Modes		
Band	Radiated TCs	Conducted TCs
GSM 850	GSM Link EDGE Link	GSM Link EDGE Link
GSM 1900	GSM Link EDGE Link	GSM Link EDGE Link
WCDMA Band V	RMC 12.2Kbps Link	RMC 12.2Kbps Link

Note: The maximum power levels are chosen to test as the worst case configuration as follows:
 GSM mode for GMSK modulation,
 EDGE multi-slot class 8 mode for 8PSK modulation,
 RMC 12.2Kbps mode for WCDMA band V,
 only these modes were used for all tests.

1.5 Measurement Results Explanation Example

For all conducted test items:

The offset level is set in the spectrum analyzer to compensate the RF cable loss and attenuator factor between EUT conducted output port and spectrum analyzer. With the offset compensation, the spectrum analyzer reading level is exactly the EUT RF output level.

The spectrum analyzer offset is derived from RF cable loss and attenuator factor.

Offset = RF cable loss + attenuator factor.

Following shows an offset computation example with cable loss 7dB and 10dB attenuator.

Example:

$$\begin{aligned} \text{Offset (dB)} &= \text{RF cable loss(dB)} + \text{attenuator factor(dB)}. \\ &= 7 + 10 = 17 \text{ (dB)} \end{aligned}$$



1.6 Facilities and Accreditations

1.6.1 Test Facilities

CNAS-Lab Code: L1659

CCIC Southern Electronic Product Testing (Shenzhen) Co., Ltd. CCIC is a third party testing organization accredited by China National Accreditation Service for Conformity Assessment (CNAS) according to ISO/IEC 17025. The accreditation certificate number is L1659. A 12.8*6.8*6.4 (m) fully anechoic chamber was used for the radiated spurious emissions test.

FCC-Registration No.: 406086

CCIC Southern Electronic Product Testing (Shenzhen) Co., Ltd. EMC Laboratory has been registered and fully described in a report filed with the FCC (Federal Communications Commission). The acceptance letter from the FCC is maintained in our files. Registration 406086, Renewal date Nov. 19, 2011, valid time is until Nov. 18, 2014.

IC-Registration No.: 11185A-1

CCIC Southern Electronic Product Testing (Shenzhen) Co., Ltd. EMC Laboratory has been registered by Certification and Engineering Bureau of Industry Canada for the performance of radiated measurements with Registration No. 11185A-1 on July. 15, 2013, valid time is until July. 15, 2016.

1.6.2 Test Environment Conditions

During the measurement, the environmental conditions were within the listed ranges:

Temperature (°C):	15°C- 35°C
Relative Humidity (%):	30% -60%
Atmospheric Pressure (kPa):	86KPa-106KPa

2. 47 CFR PART 2, PART 22H & 24E REQUIREMENTS

2.1 Conducted RF Output Power

2.1.1 Requirement

For transmitters other than single sideband, independent sideband and controlled carrier radiotelephone, power output shall be measured at the RF output terminals when the transmitter is adjusted in accordance with the tune-up procedure to give the values of current and voltage on the circuit elements specified in FCC section 2.1033(c)(8).

2.1.2 Test Description

1. Test Setup:

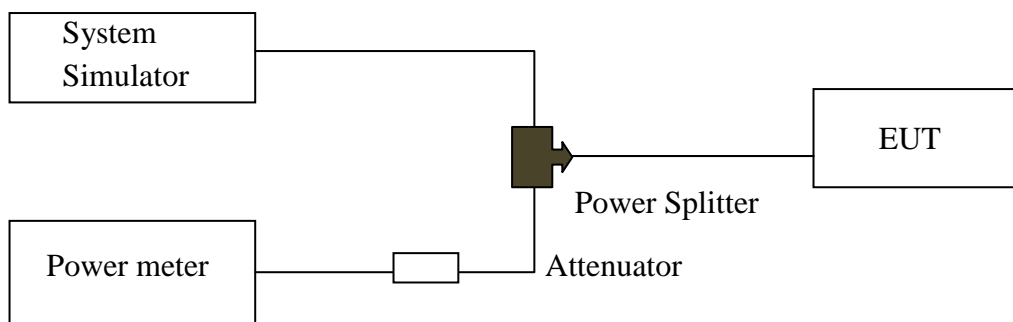

The EUT, which is powered by the Battery, is coupled to the Power meter and the System Simulator (SS) with Attenuators through the Power Splitter; the RF load attached to the EUT antenna terminal is 50Ohm; the path loss as the factor is calibrated to correct the reading. The EUT is commanded by the SS to operate at the maximum output power i.e. Power Control Level (PCL) = 5 and Power Class = 4. A call is established between the EUT and the SS.

2. Equipments List:

Description	Manufacturer	Model	Serial No.	Cal. Date	Cal. Due Date
System Simulator	Agilent	E5515C	MY47510547	2014.06.11	2015.06.10
Power Meter	R&S	NRV2	1020.1809.02	2014.06.08	2015.06.07
Power Sensor	R&S	NRV-Z4	823.3618.03	2014.06.08	2015.06.07
Attenuator	MCE	10dB	BN3693	2014.06.11	2015.06.10



2.1.3 Test Results

Here the lowest, middle and highest channels are selected to perform testing to verify the conducted RF output power of the EUT.

1. GSM Model Test Verdict:

Band	Channel	Frequency (MHz)	Measured Output Power dBm	Verdict
GSM 850MHz	128	824.2	33.38	PASS
	190	836.6	33.43	PASS
	251	848.8	33.41	PASS
GSM 1900MHz	512	1850.2	30.44	PASS
	661	1880.0	30.46	PASS
	810	1909.8	30.37	PASS
GPRS 850MHz	128	824.2	33.13	PASS
	190	836.6	33.14	PASS
	251	848.8	33.15	PASS
GPRS 1900MHz	512	1850.2	30.12	PASS
	661	1880.0	30.17	PASS
	810	1909.8	30.13	PASS
EDGE 850MHz	128	824.2	30.32	PASS
	190	836.6	30.34	PASS
	251	848.8	30.31	PASS
EDGE 1900MHz	512	1850.2	30.24	PASS
	661	1880.0	30.31	PASS
	810	1909.8	30.26	PASS

Note 1: For the GPRS and EDGE model, all the slots were tested and just the worst data was record in this report.



2. WCDMA Model Test Verdict:

Item	band	WCDMA 850		
	Frequency	4132	4183	4233
	Subtest	dBm		
WCDMA	RMC 12.2Kbps	23.34	23.37	23.35
HSDPA	1	22.73	22.81	22.84
	2	22.69	22.71	22.59
	3	21.68	21.82	21.75
	4	21.59	21.64	21.61
HSUPA	1	22.24	22.37	22.42
	2	22.27	22.34	22.28
	3	21.27	22.04	22.07
	4	22.05	22.07	22.13
	5	22.13	22.16	22.12
HSPA+	1	22.23	22.28	22.25

2.2 Peak to Average Ratio

2.2.1 Definition

The peak-to-average ratio (PAR) of the transmission may not exceed 13 dB.

2.2.2 Test Description

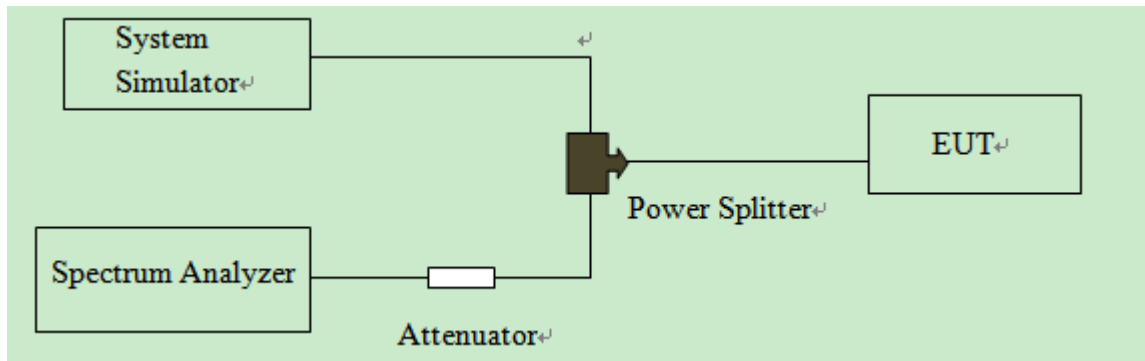

Description	Manufacturer	Model	Serial No.	Cal. Date	Cal. Due Date
System Simulator	R&S	CMW500	149333	2014.07.21	2015.07.20
Spectrum Analyzer	R&S	FSP40	100341	2014.07.07	2015.07.06
Attenuator 1	Resent	10dB	(n.a.)	2014.06.11	2015.06.10
Attenuator 2	Resent	3dB	(n.a.)	2014.06.11	2015.06.10

2.2.3 Test Verdict

Here the lowest, middle and highest channels are selected to perform testing to verify the peak-to-average ratio.

Test procedures:

A. For GSM operating mode:

- Set RBW=1MHz, VBW=3MHz, Peak detector on spectrum analyzer for first trace.
- Set the RBW = 1MHz, VBW = 3MHz, RMS detector on spectrum analyzer for second trace.
- The wanted burst signal is triggered by spectrum analyzer, and measured respectively the peak level and Mean level without burst-off time, after system simulator has synchronized with the spectrum analyzer.

B. For UMTS operating mode:

- Set the CCDF (Complementary Cumulative Distribution Function) option in spectrum analyzer.
- The highest RF powers were measured and recorded the maximum PAPR level associated with a probability of 0.1%.
- Record the deviation as Peak to Average Ratio.



1. Test Verdict:

Band	Channel	Frequency (MHz)	Peak to Average ratio		Limit	Verdict
			dBm	Refer to Plot	dBm	
GSM 1900MHz	512	1850.2	0.08	Plot A1 to A3	13	PASS
	661	1880.0	0.08			PASS
	810	1909.8	0.06			PASS
EDGE 1900MHz	512	1850.2	0.10	Plot B1 to B3	13	PASS
	661	1880.0	0.12			PASS
	810	1909.8	0.05			PASS



2. GSM Model Test Plots:

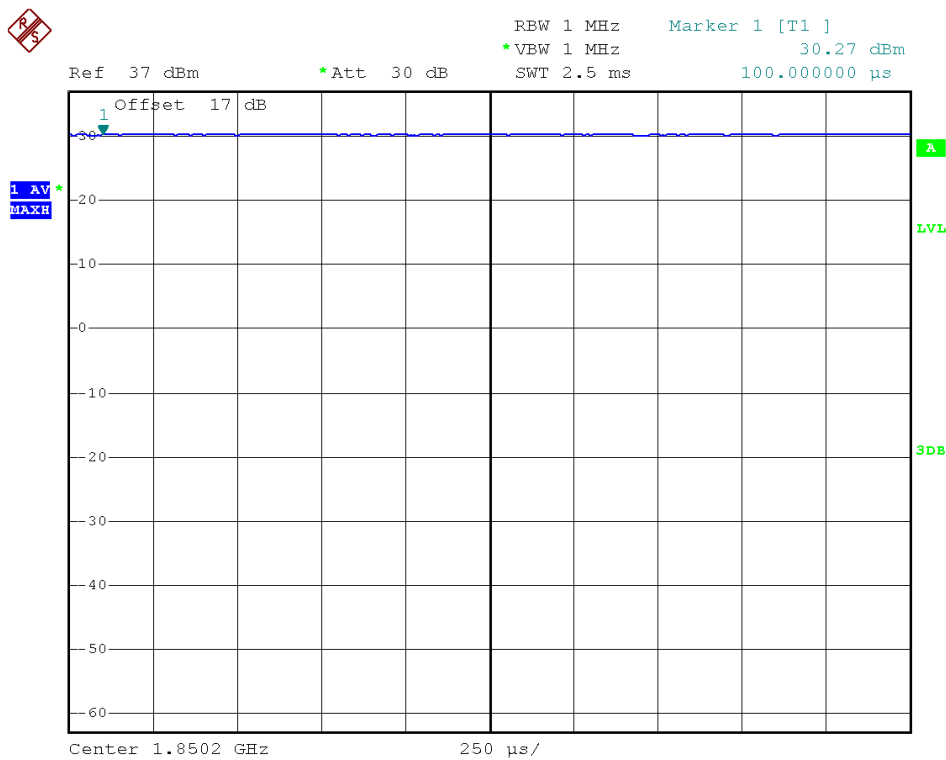
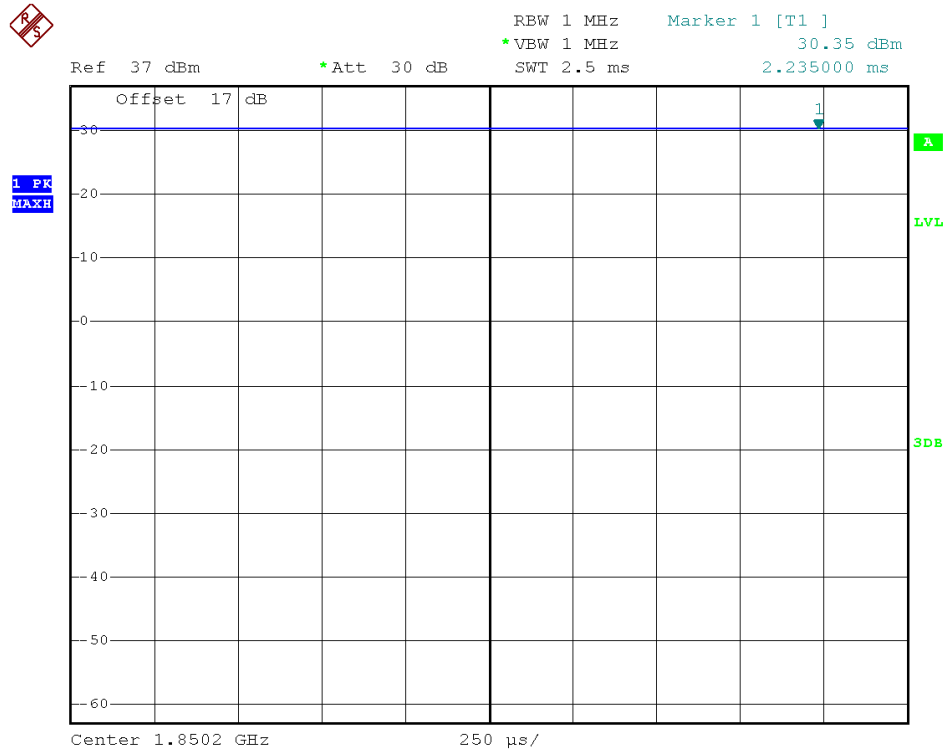

(Plot A1: GSM 1900 MHz Channel = 512)

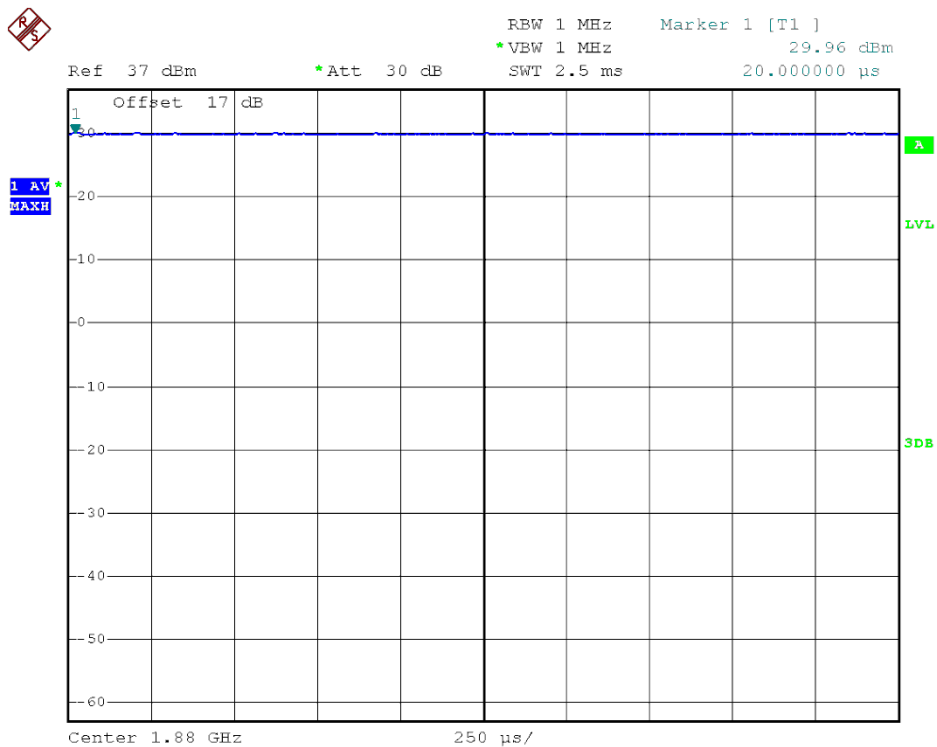
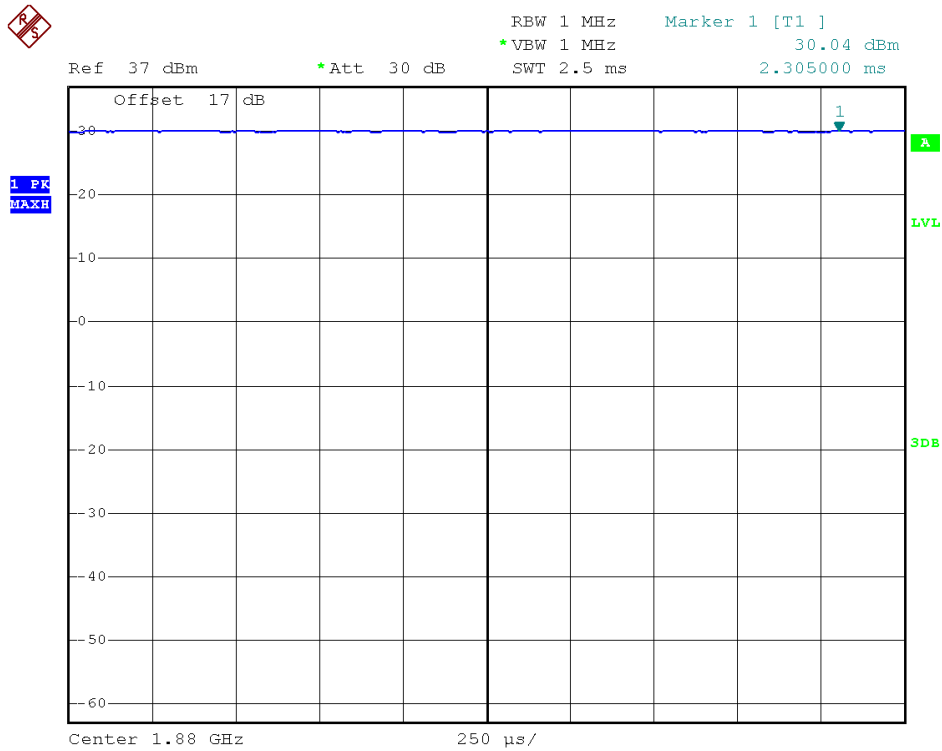

(Plot A2: GSM 1900 MHz Channel = 661)

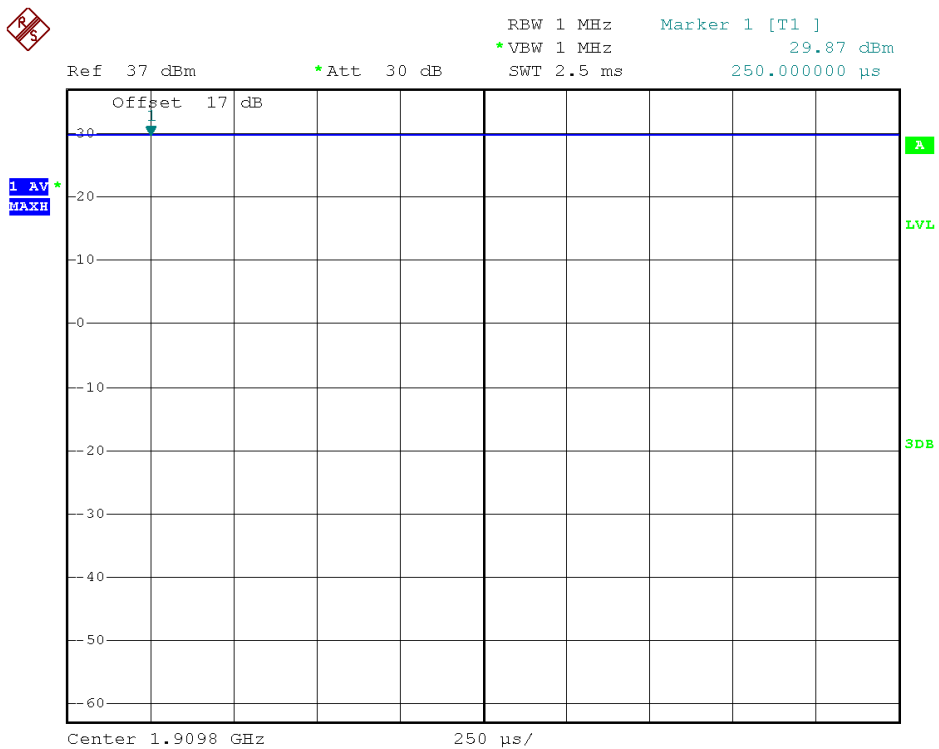
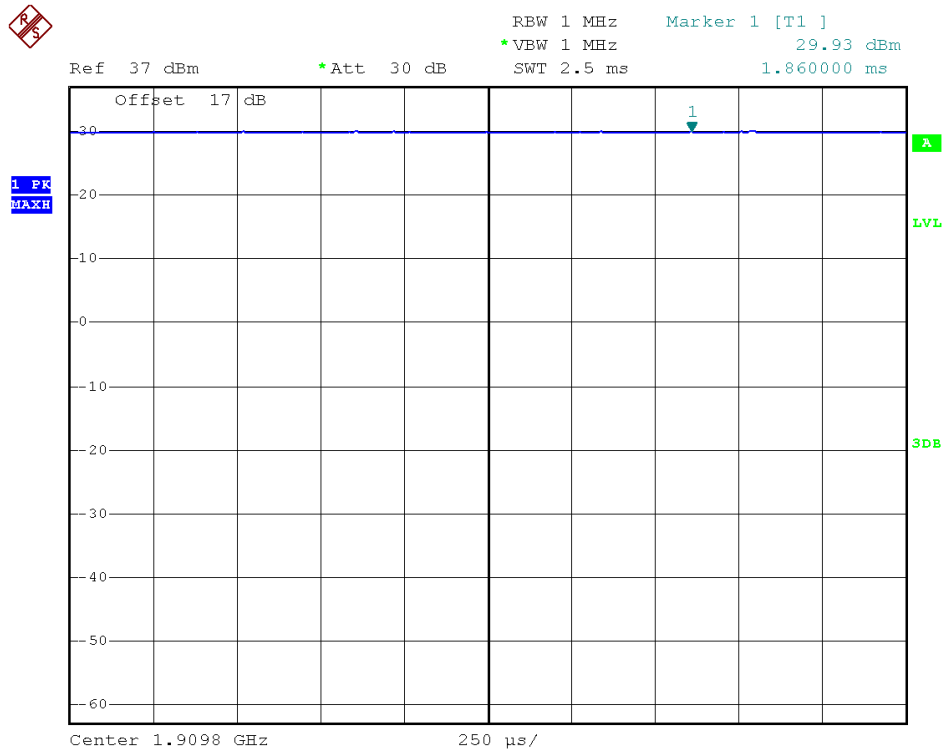

(Plot A3: GSM 1900MHz Channel = 810)



Ref 37 dBm *Att 30 dB RBW 1 MHz Marker 1 [T1]
*VBW 1 MHz 30.32 dBm
SWT 2.5 ms 2.155000 ms

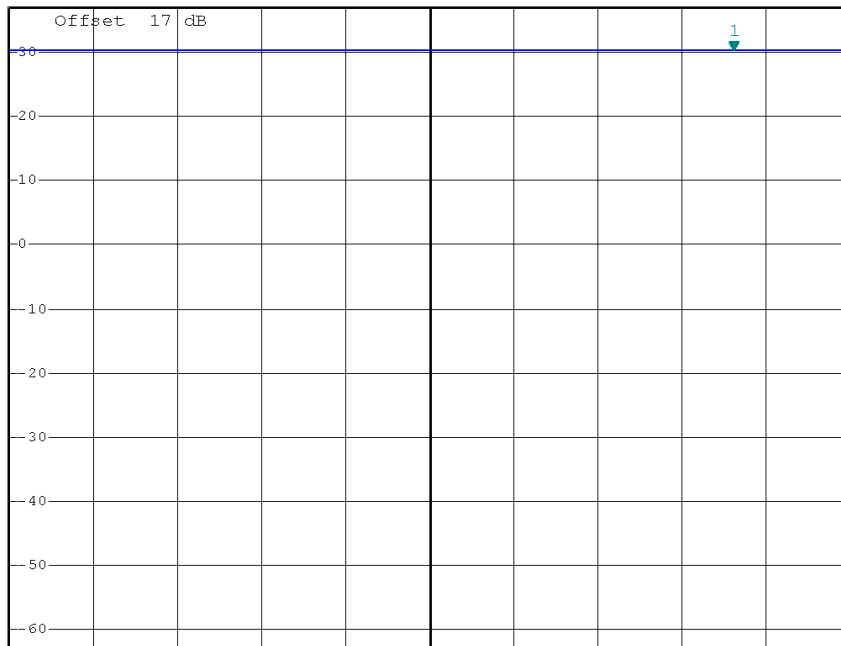

Ref 37 dBm *Att 30 dB RBW 1 MHz Marker 1 [T1]
*VBW 1 MHz 30.22 dBm
SWT 2.5 ms 2.235000 ms

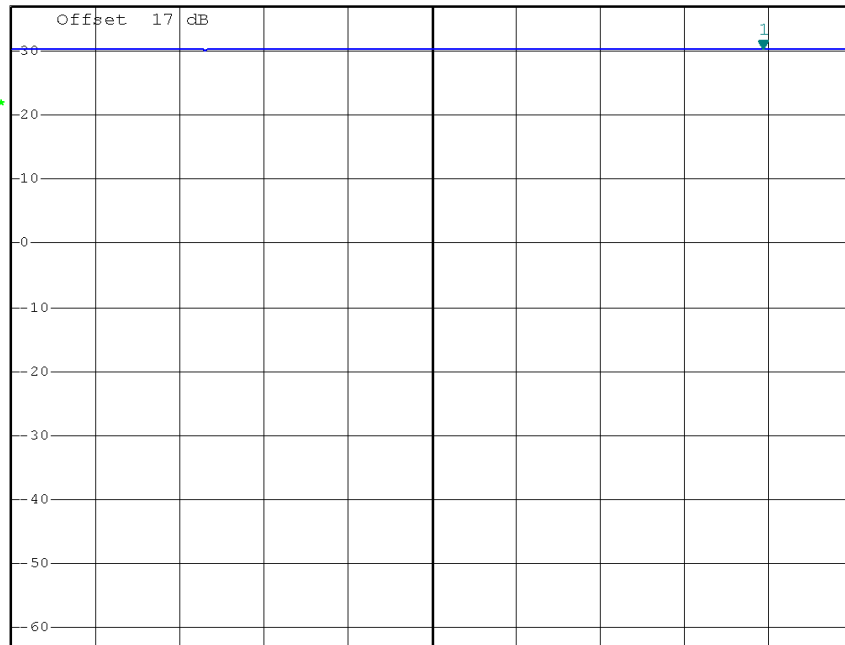

(Plot B1: EDGE 1900 MHz Channel = 512)

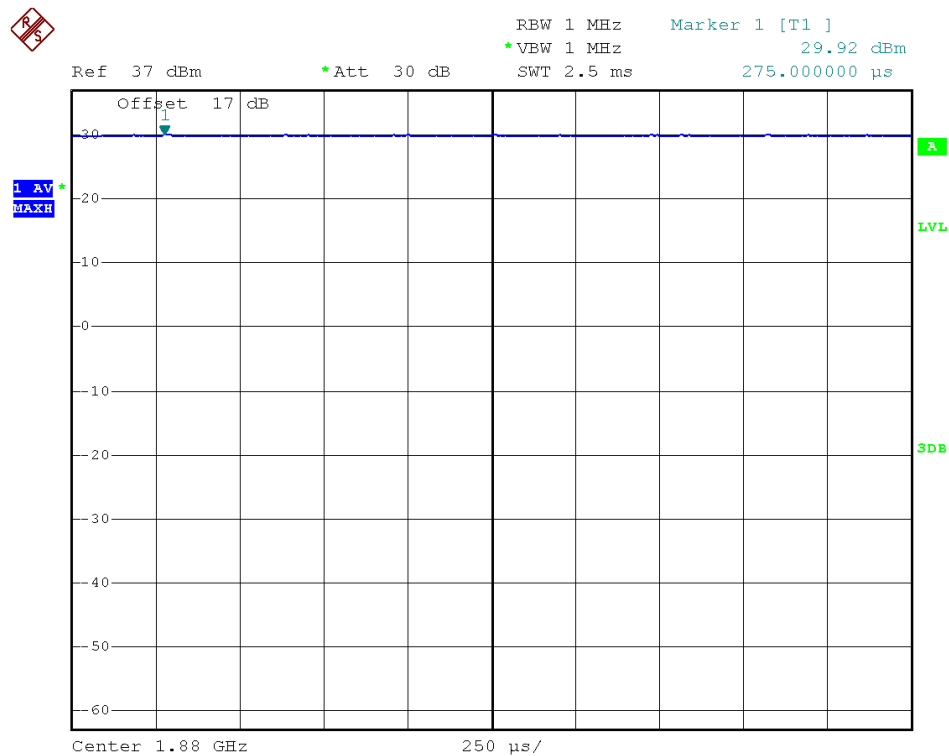
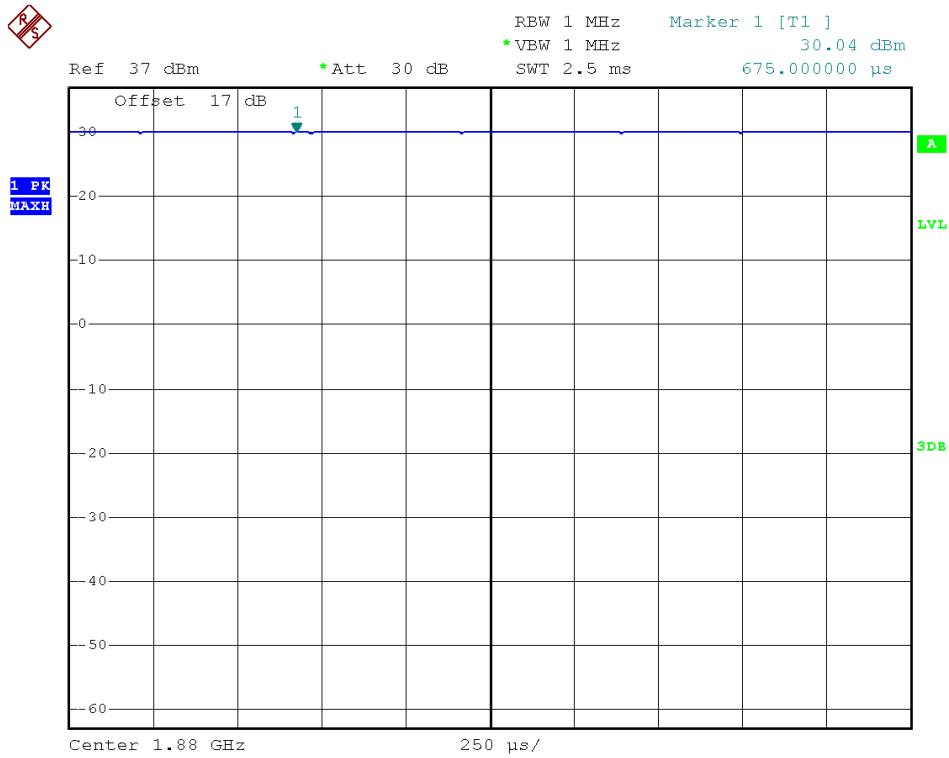

(Plot B2: EDGE 1900 MHz Channel = 661)

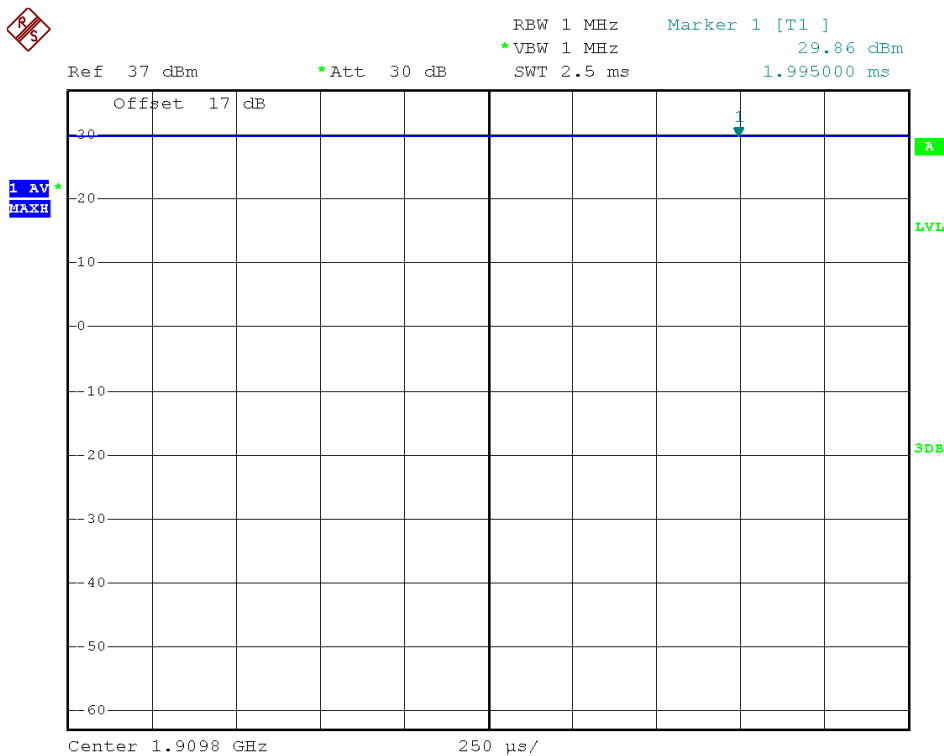
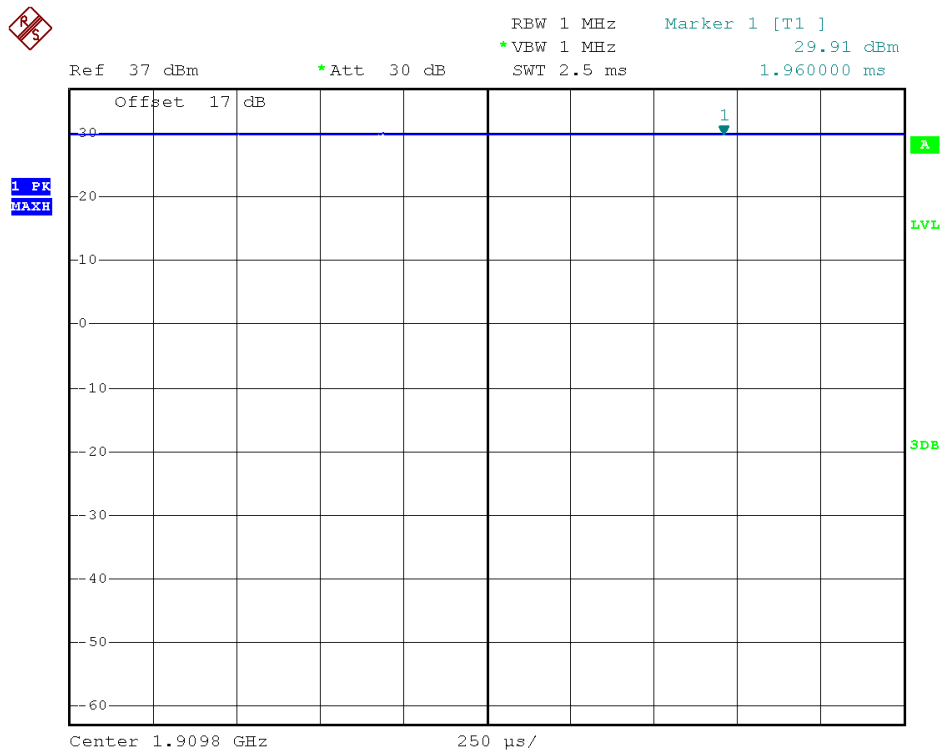

(Plot B3: EDGE 1900MHz Channel = 810)

2.3 99% Occupied Bandwidth

2.3.1 Definition

The 99% occupied bandwidth is the width of a frequency band such that, below the lower and above the upper frequency limits, the mean powers emitted are each equal to a specified percentage 0.5% of the total mean transmitted power.

The emission bandwidth is defined as the width of the signal between two points, located at the 2 sides of the carrier frequency, outside of which all emissions are attenuated at least 26 dB below the transmitter power.

2.3.2 Test Description

See section 2.1.2 of this report.

2.3.3 Test Procedures

1. The testing follows FCC KDB 971168 v02r02 Section 4.2.
2. The EUT was connected to the spectrum analyzer and system simulator via a power divider.
3. The RF output of the EUT was connected to the spectrum analyzer by RF cable and attenuator.

The path loss was compensated to the results for each measurement.

4. The 99% occupied bandwidth were measured, set RBW= 1% of span, VBW= 3*RBW, sample detector, trace maximum hold.
5. The 26dB bandwidth were measured, set RBW= 1% of EBW, VBW= 3*RBW, peak detector, trace maximum hold.

2.3.4 Test Verdict

Here the lowest, middle and highest channels are selected to perform testing to verify the 99% occupied bandwidth.

1. Test Verdict:

Band	Channel	Frequency (MHz)	26dB bandwidth	99% Occupied Bandwidth	Refer to Plot
GSM 850MHz	128	824.2	308 KHz	246 KHz	Plot A1-A2
	190	836.6	304 KHz	246 KHz	Plot A3-A4
	251	848.8	304 KHz	246 KHz	Plot A5-A6
GSM 1900MHz	512	1850.2	308 KHz	246 KHz	Plot B1-B2
	661	1880.0	312 KHz	242 KHz	Plot B3-B4
	810	1909.8	310 KHz	244 KHz	Plot B5-B6



Band	Channel	Frequency (MHz)	26dB bandwidth	99% Occupied Bandwidth	Refer to Plot
EDGE 850MHz	128	824.2	310 KHz	244 KHz	Plot C1-C2
	190	836.6	304 KHz	242 KHz	Plot C3-C4
	251	848.8	298 KHz	242 KHz	Plot C5-C6
EDGE 1900MHz	512	1850.2	308 KHz	246 KHz	Plot D1-D2
	661	1880.0	308 KHz	242 KHz	Plot D3-D4
	810	1909.8	312 KHz	248 KHz	Plot D5-D6
WCDMA 850MHz	4132	826.4	4.68MHz	4.15MHz	Plot E1-E2
	4183	836.6	4.69MHz	4.17MHz	Plot E3-E4
	4233	846.6	4.68MHz	4.16MHz	Plot E5-E6

2. Test Plots:

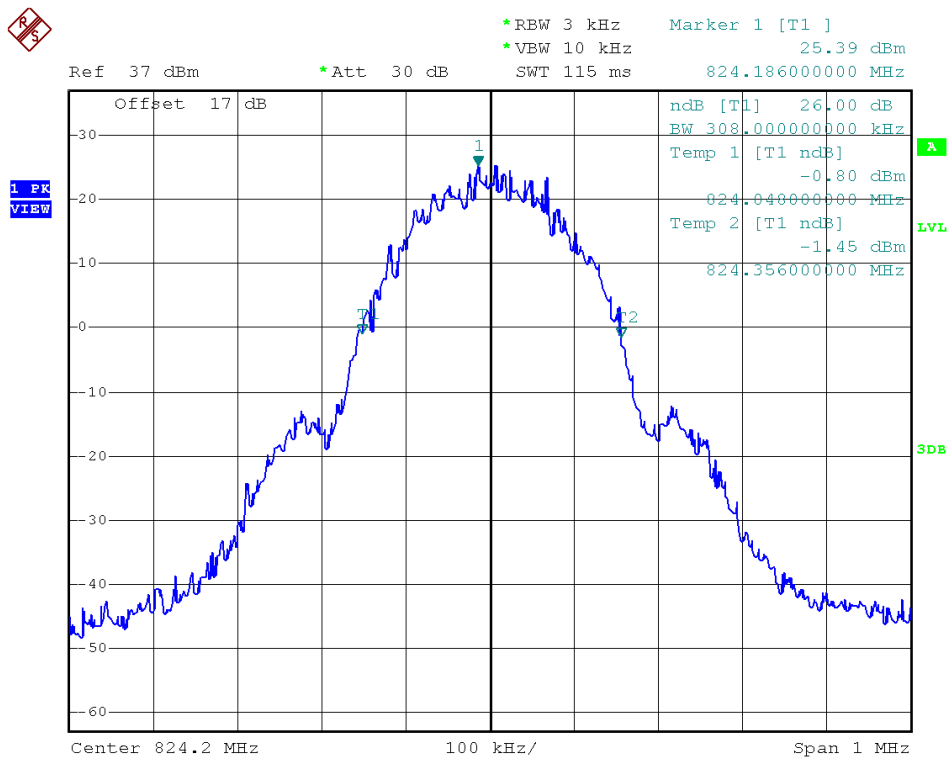

(Plot A1: GSM 850MHz Channel = 128 26dB bandwidth)

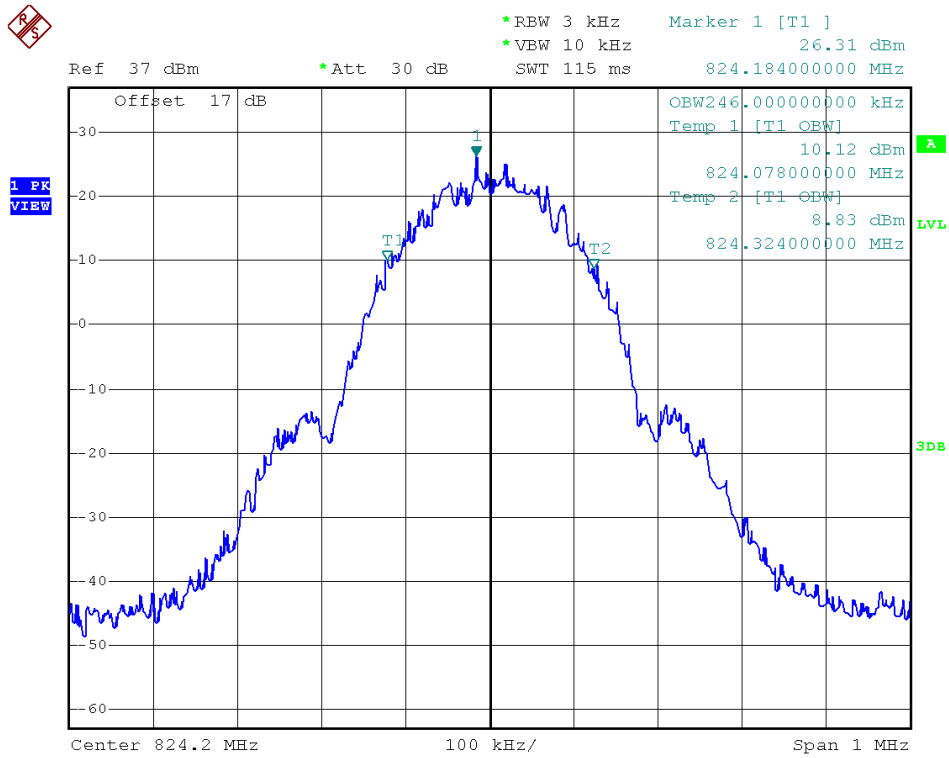

(Plot A2: GSM 850MHz Channel = 128 99% Occupied Bandwidth)

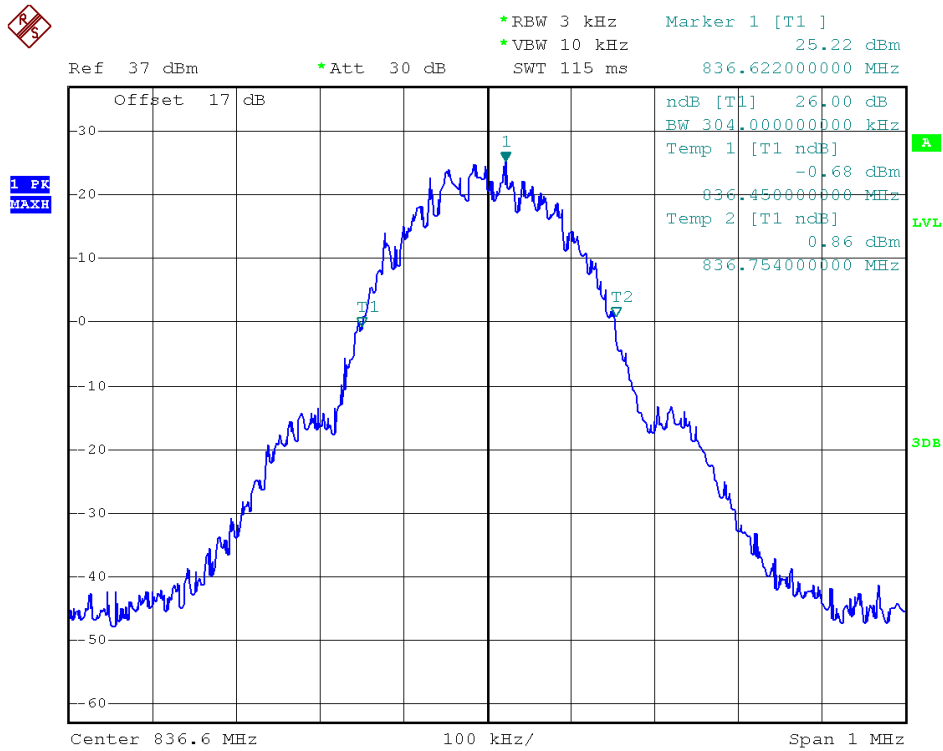

(Plot A3: GSM 850MHz Channel = 190 26dB bandwidth)

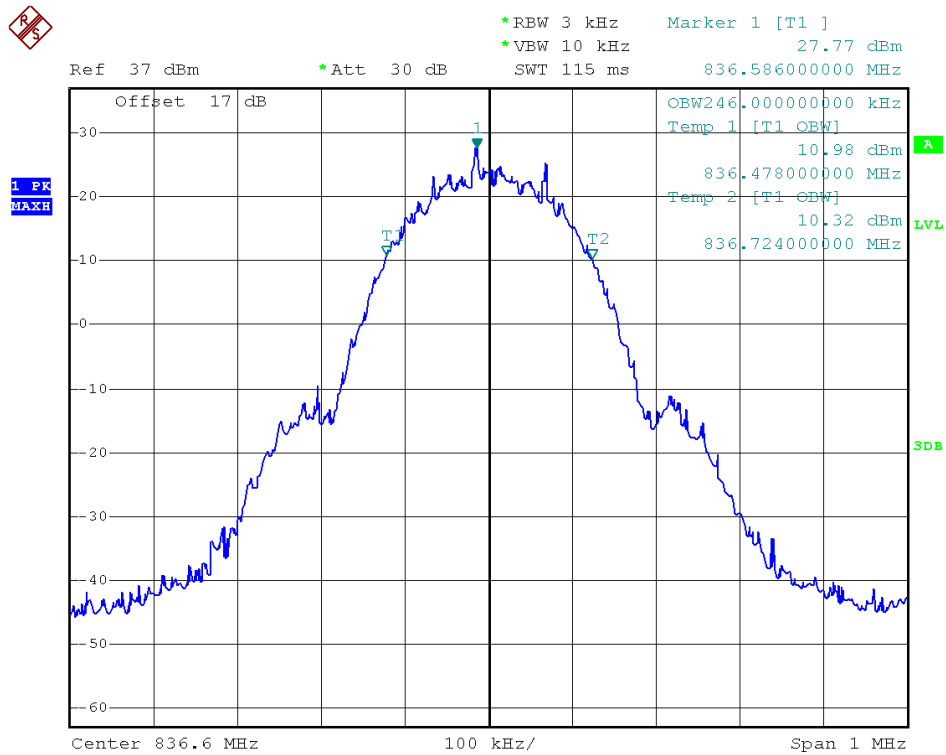

(Plot A4: GSM 850MHz Channel = 190 99% Occupied Bandwidth)

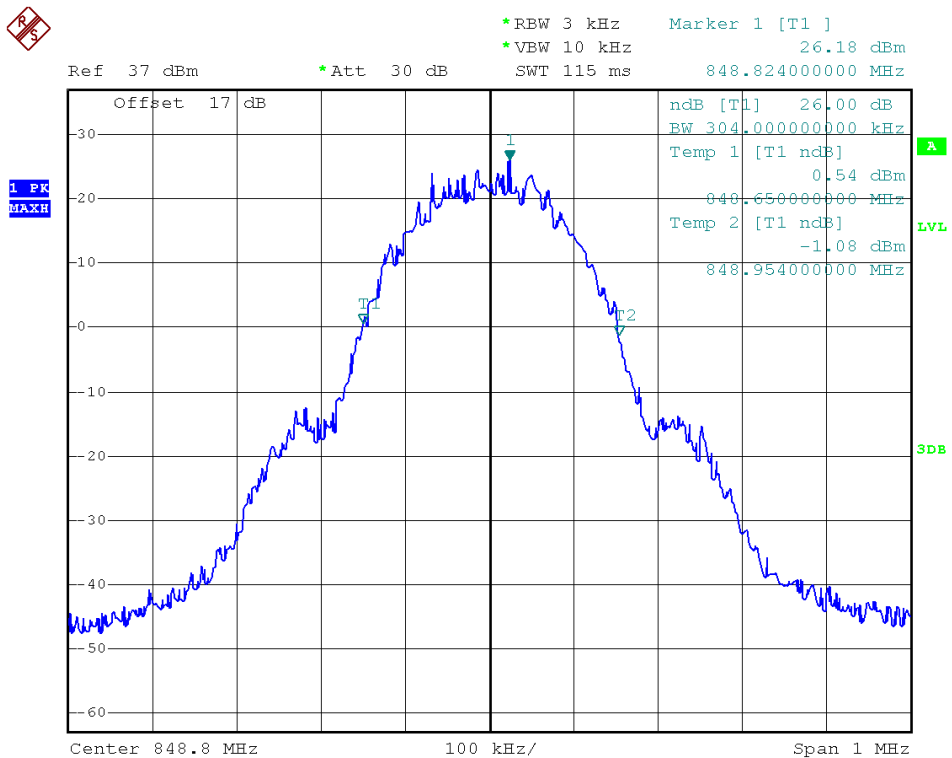

(Plot A5: GSM 850MHz Channel = 251 26dB bandwidth)

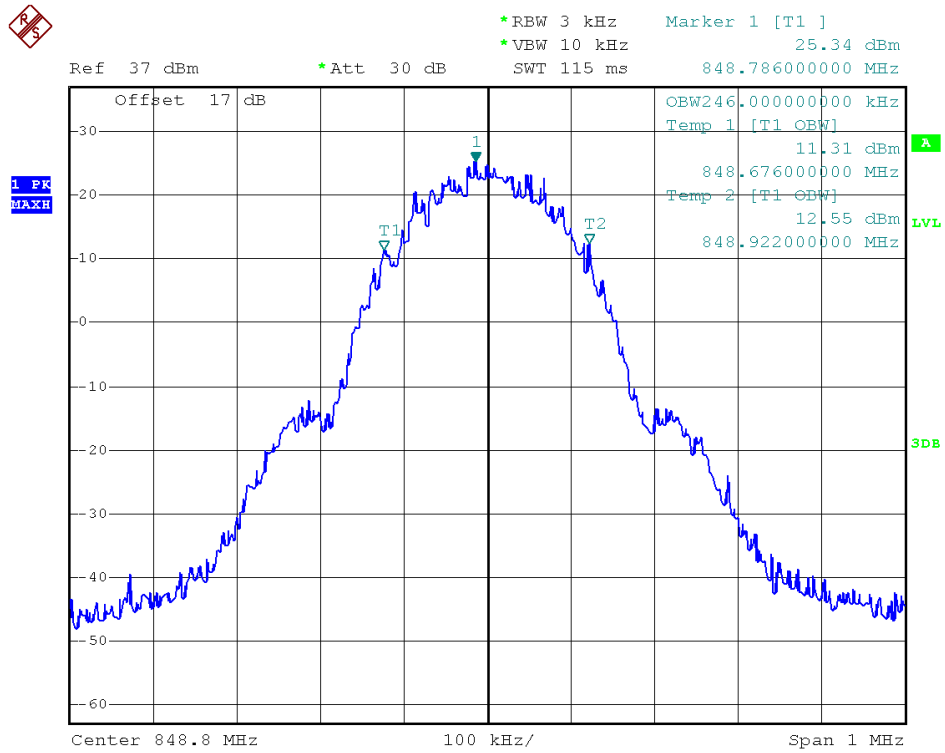

(Plot A6: GSM 850MHz Channel = 251 99% Occupied Bandwidth)

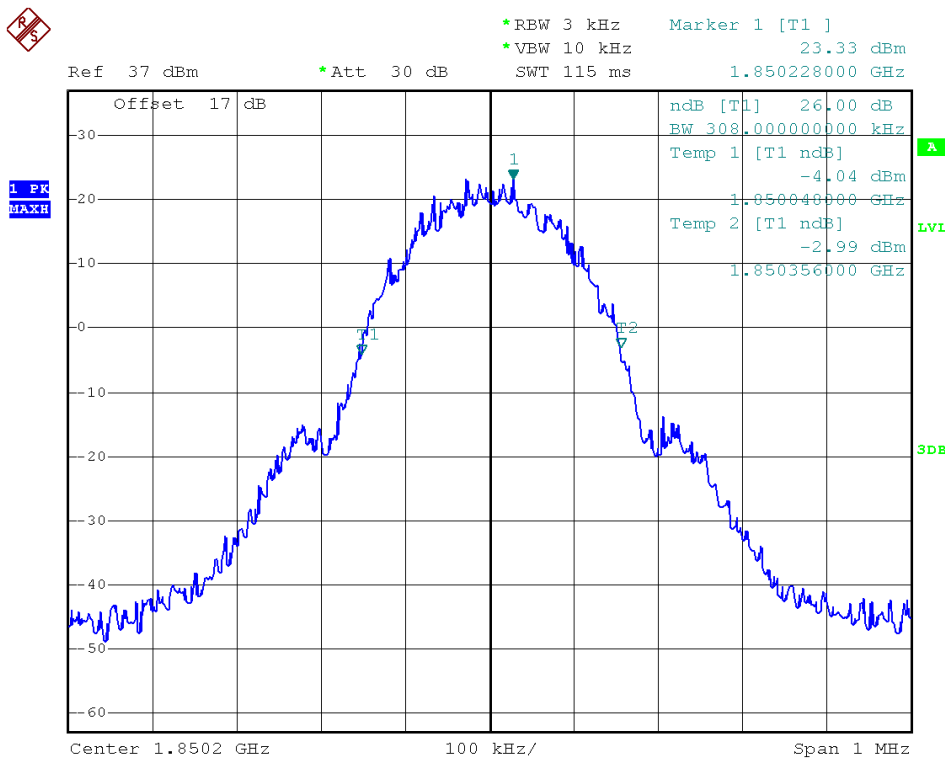

(Plot B1: GSM 1900MHz Channel = 512 26dB bandwidth)

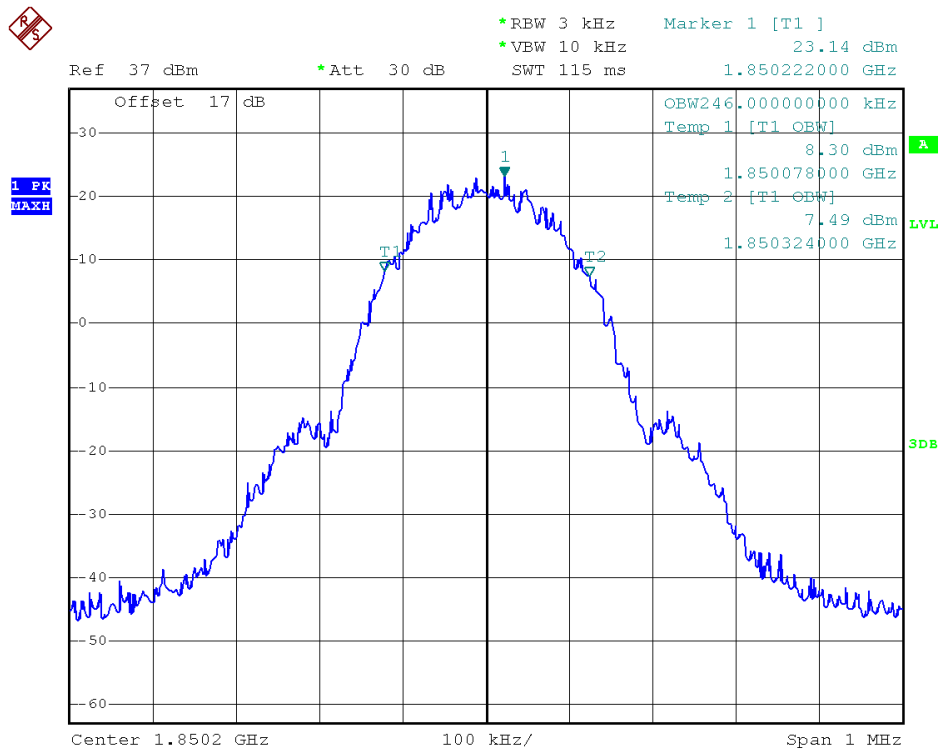

(Plot B2: GSM 1900MHz Channel = 512 99% Occupied Bandwidth)

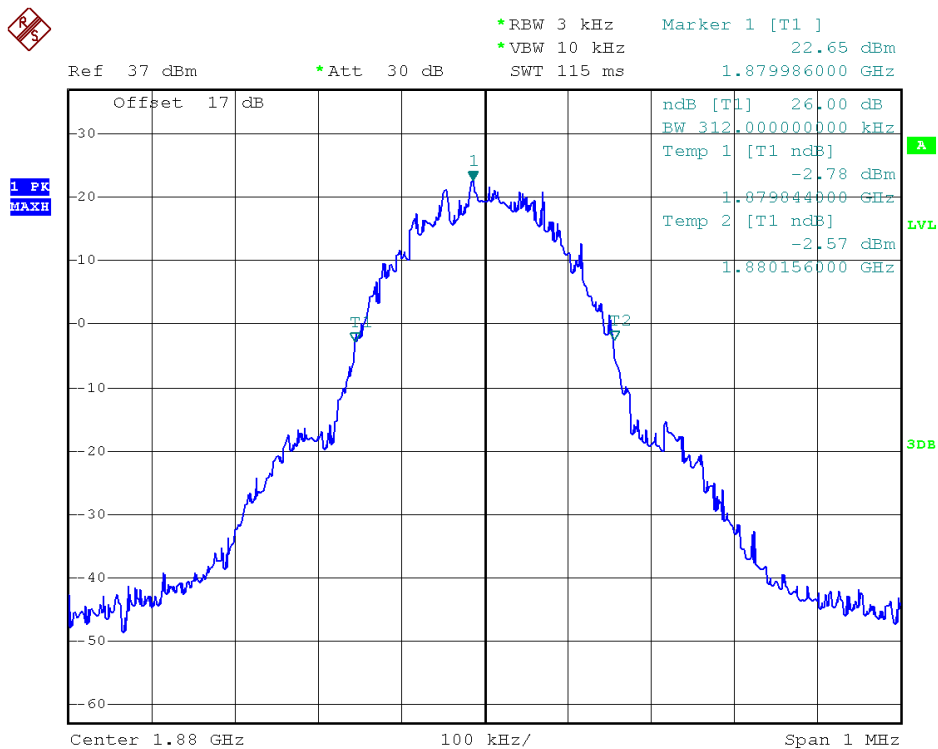

(Plot B3: GSM 1900MHz Channel = 661 26dB bandwidth)

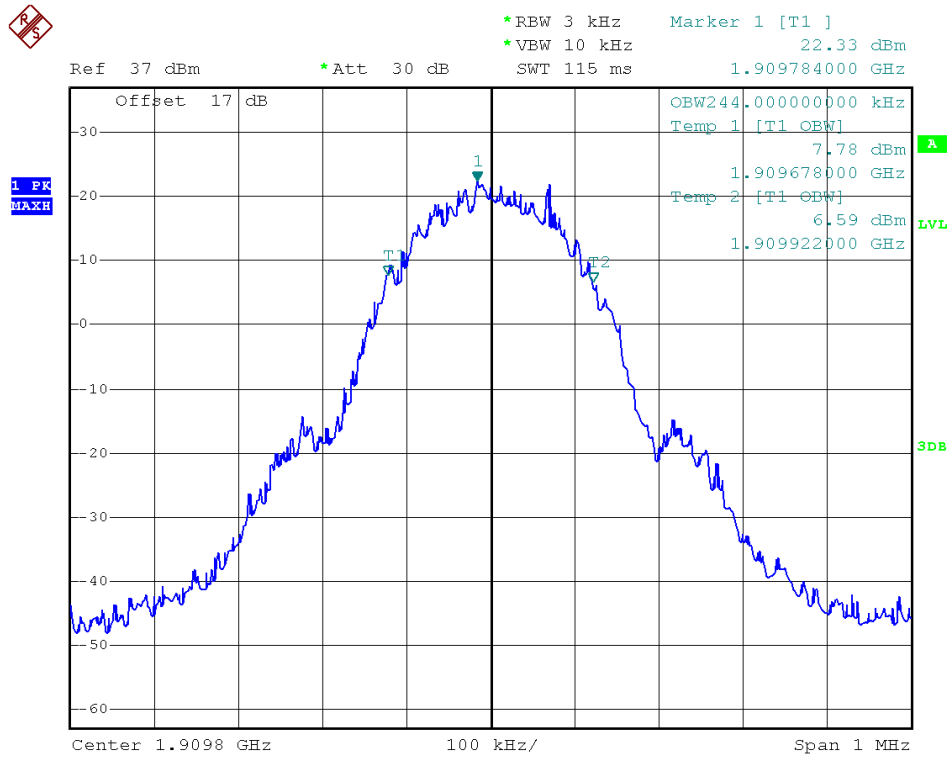

(Plot B6: GSM 1900MHz Channel = 810 99% Occupied Bandwidth)

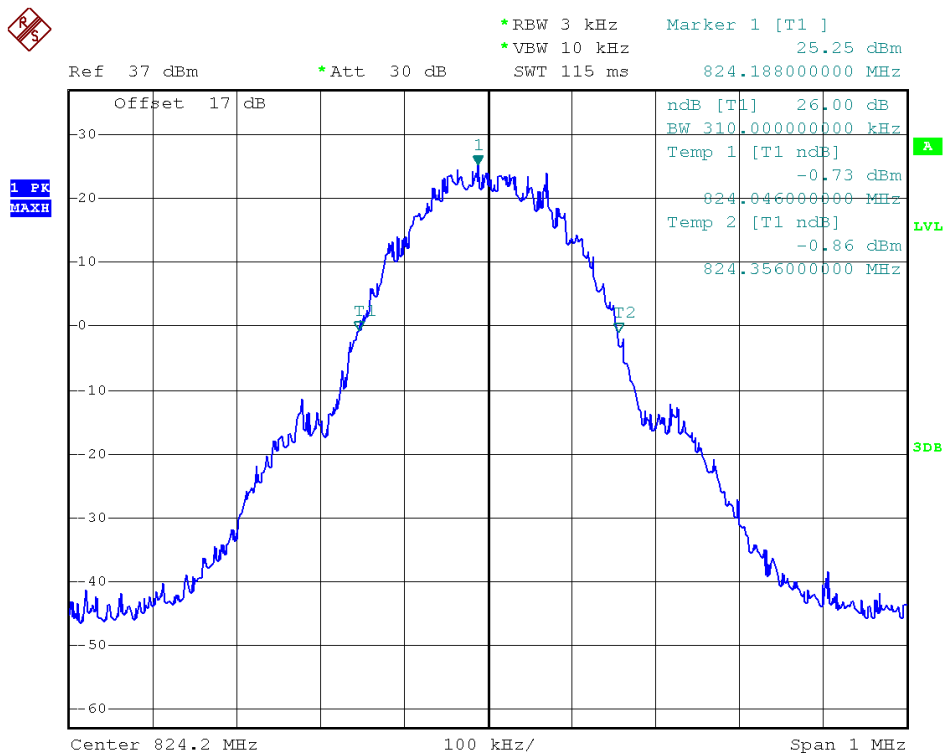

(Plot C1: EDGE 850MHz Channel = 128 26dB bandwidth)

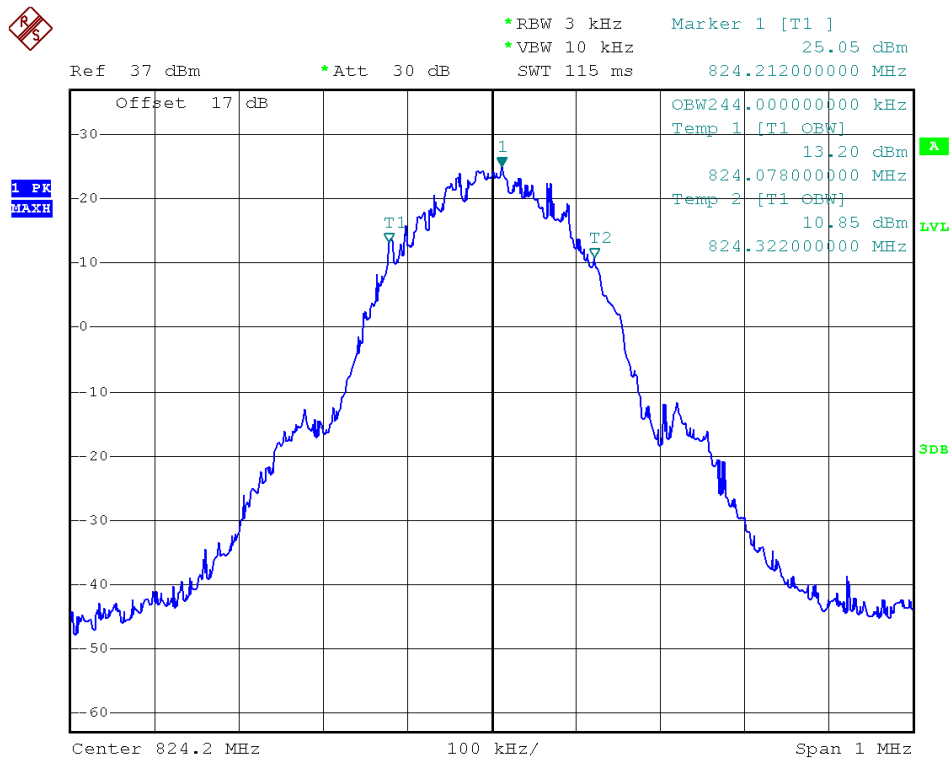

(Plot C2: EDGE 850MHz Channel = 128 99% Occupied Bandwidth)

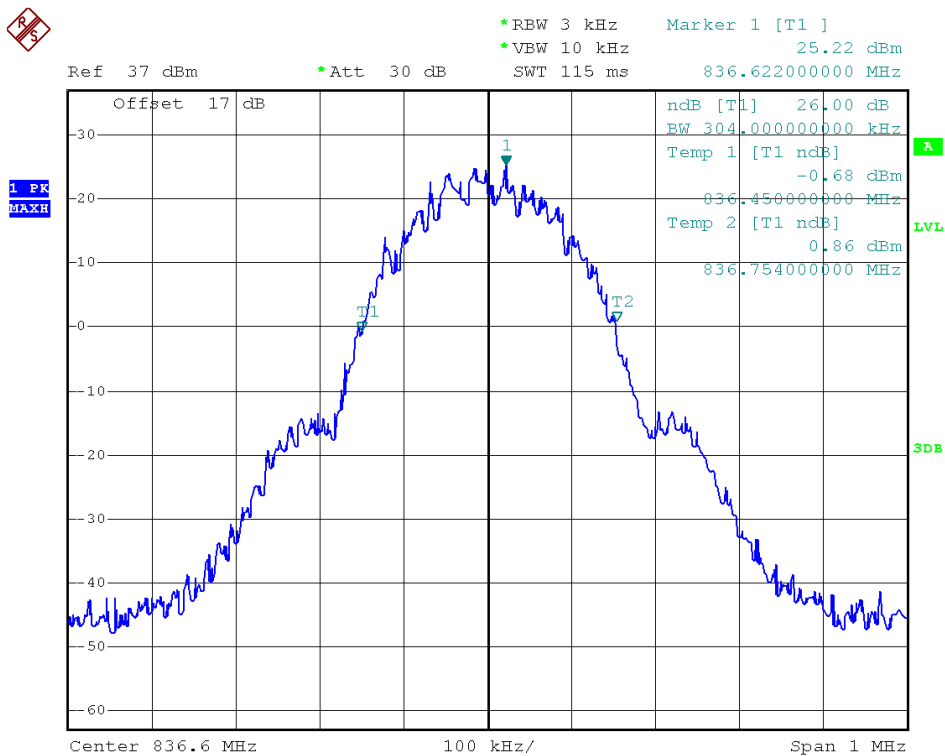

(Plot C3: EDGE 850MHz Channel = 190 26dB bandwidth)

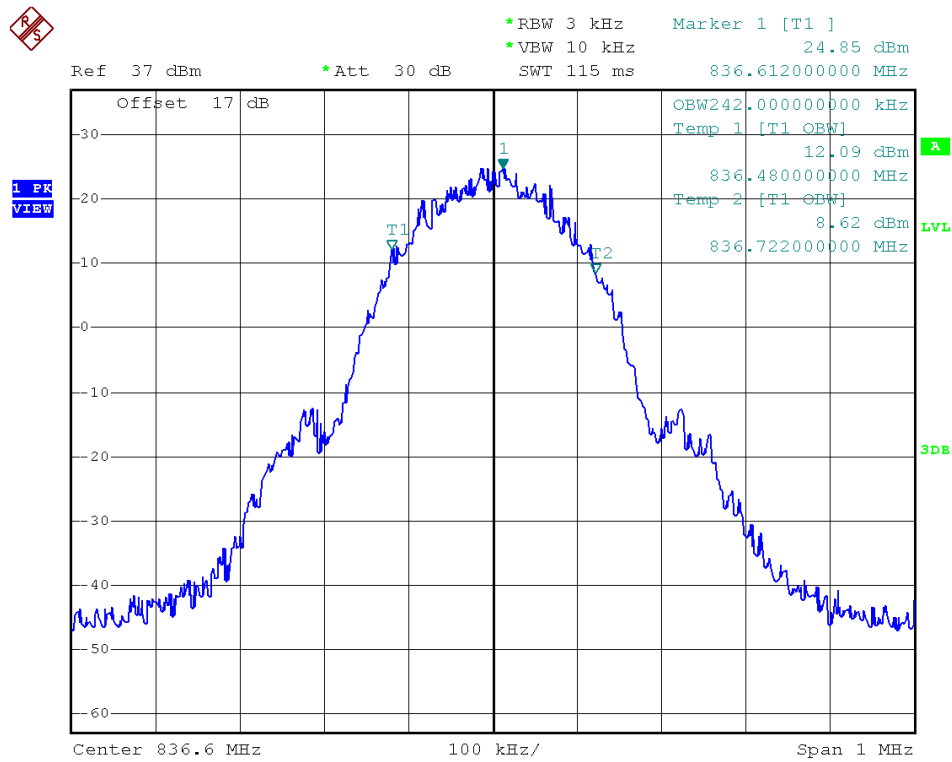

(Plot C4: EDGE 850MHz Channel = 190 99% Occupied Bandwidth)

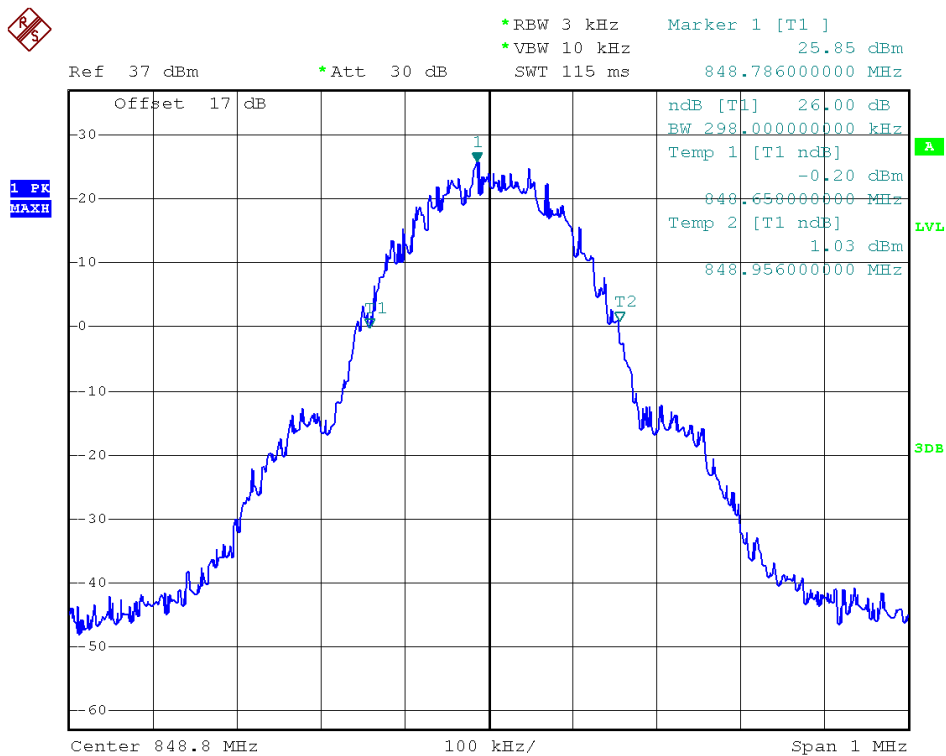

(Plot C5: EDGE 850MHz Channel = 251 26dB bandwidth)

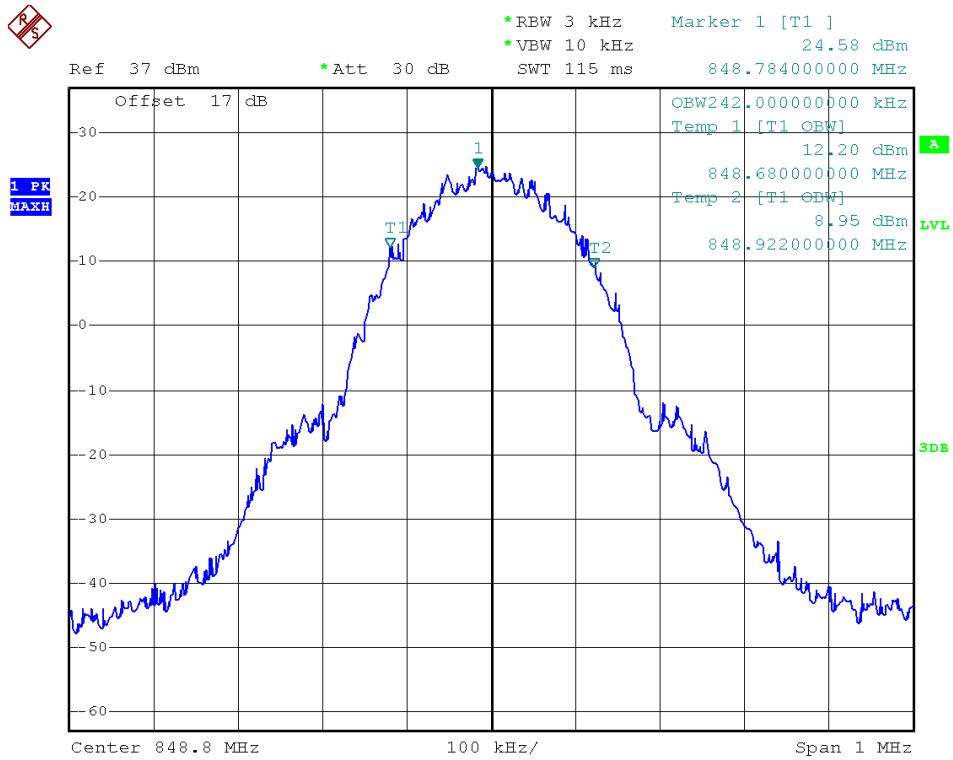

(Plot C6: EDGE 850MHz Channel = 251 99% Occupied Bandwidth)

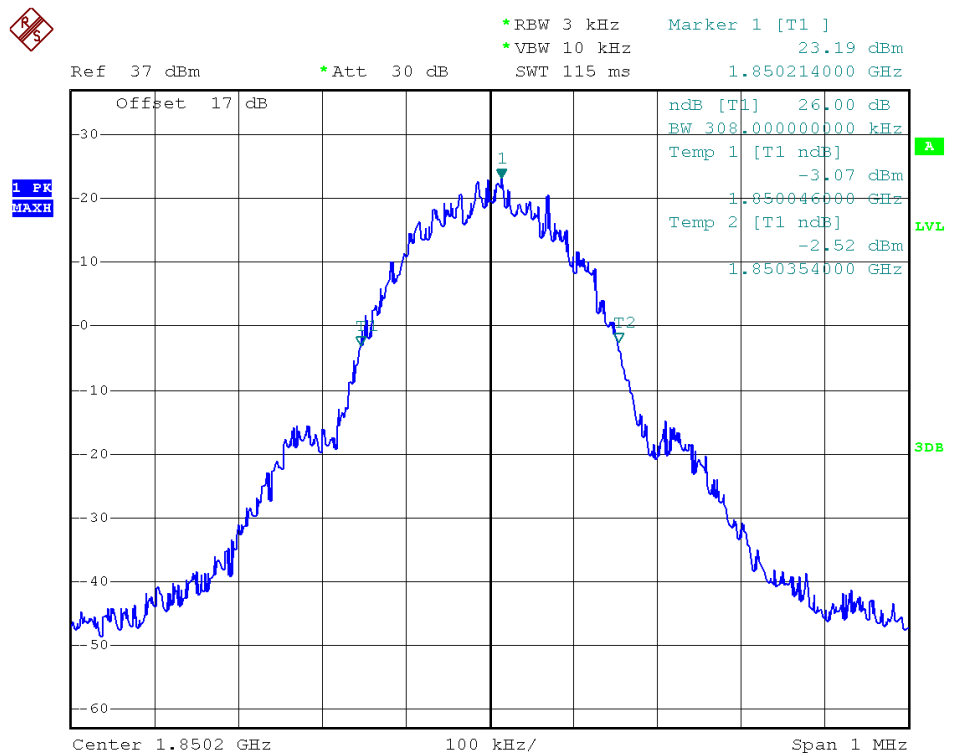

(Plot D1: EDGE 1900MHz Channel = 512 26dB bandwidth)

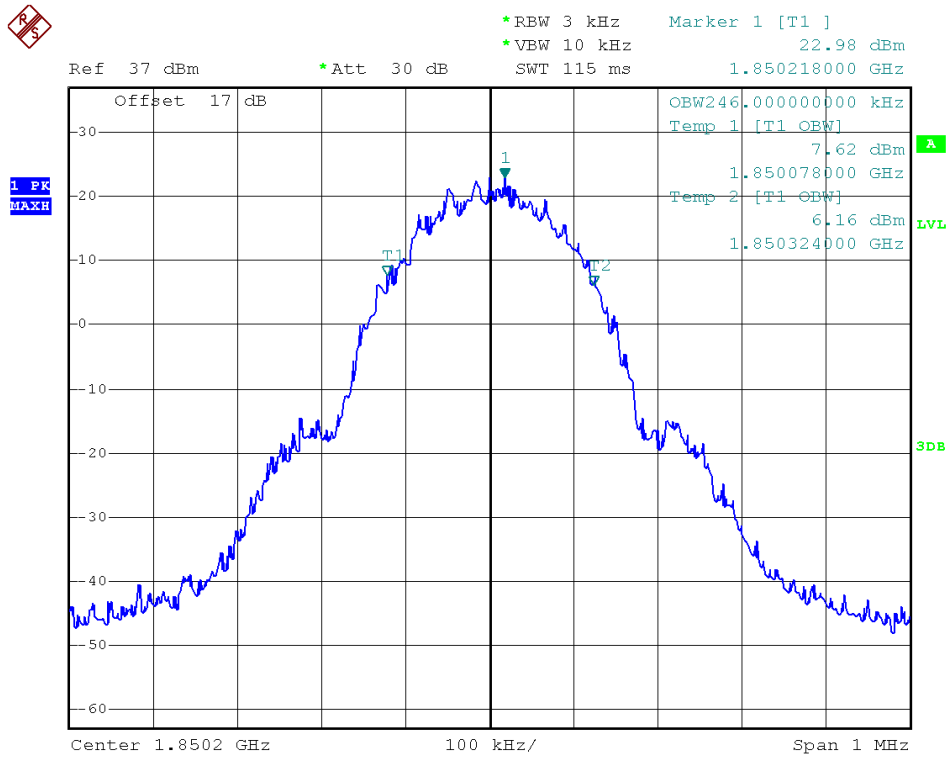

(Plot D2: EDGE 1900MHz Channel = 512 99% Occupied Bandwidth)

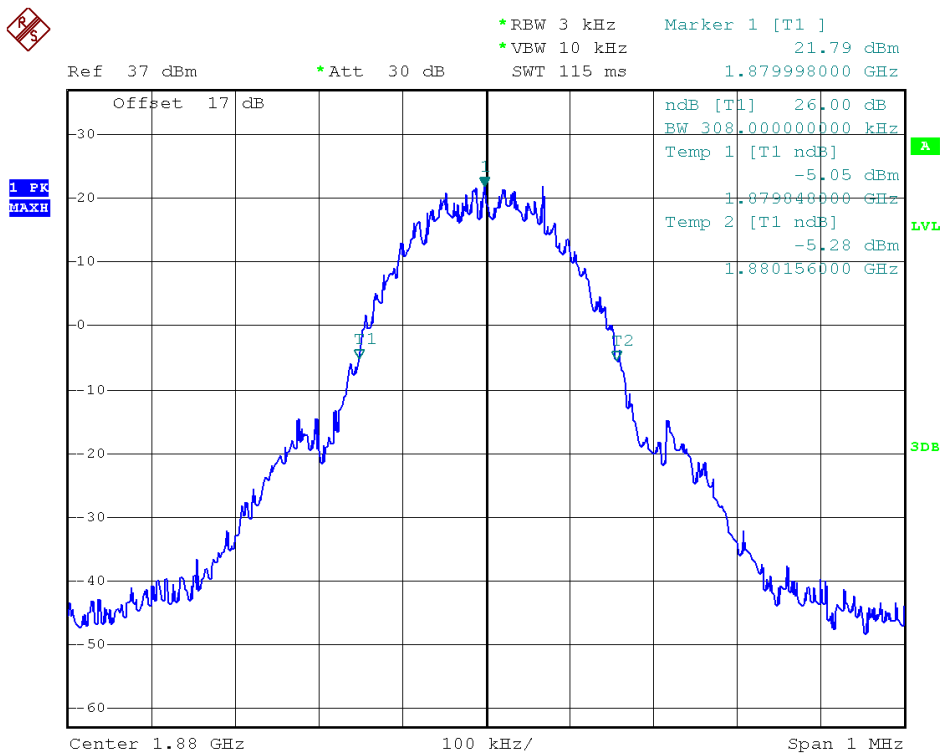

(Plot D3: EDGE 1900MHz Channel = 661 26dB bandwidth)

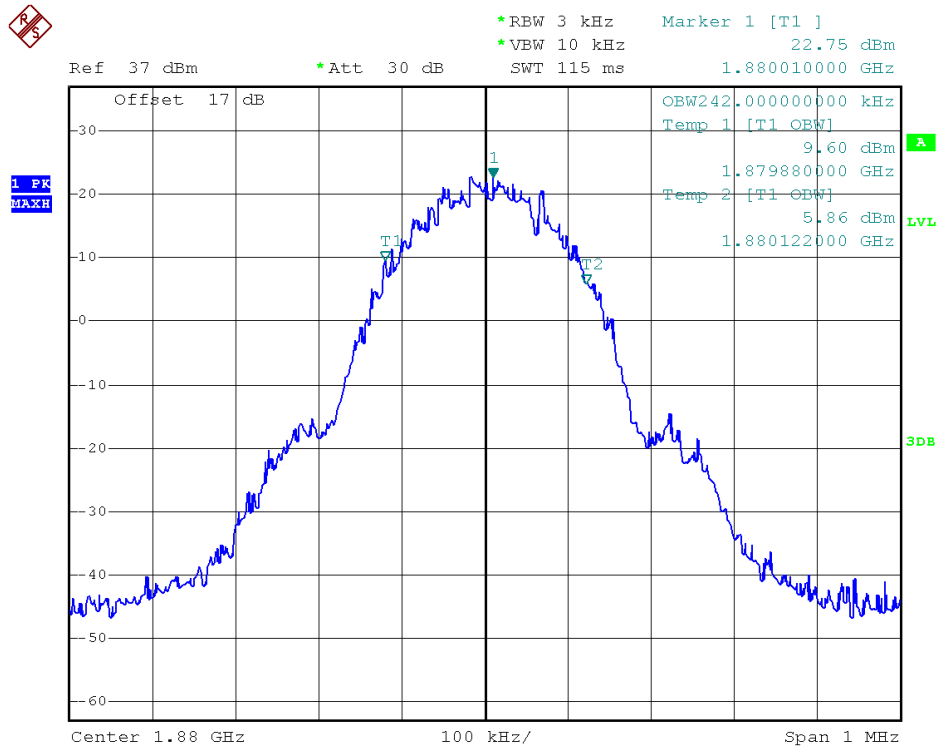

(Plot D4: EDGE 1900MHz Channel = 661 99% Occupied Bandwidth)

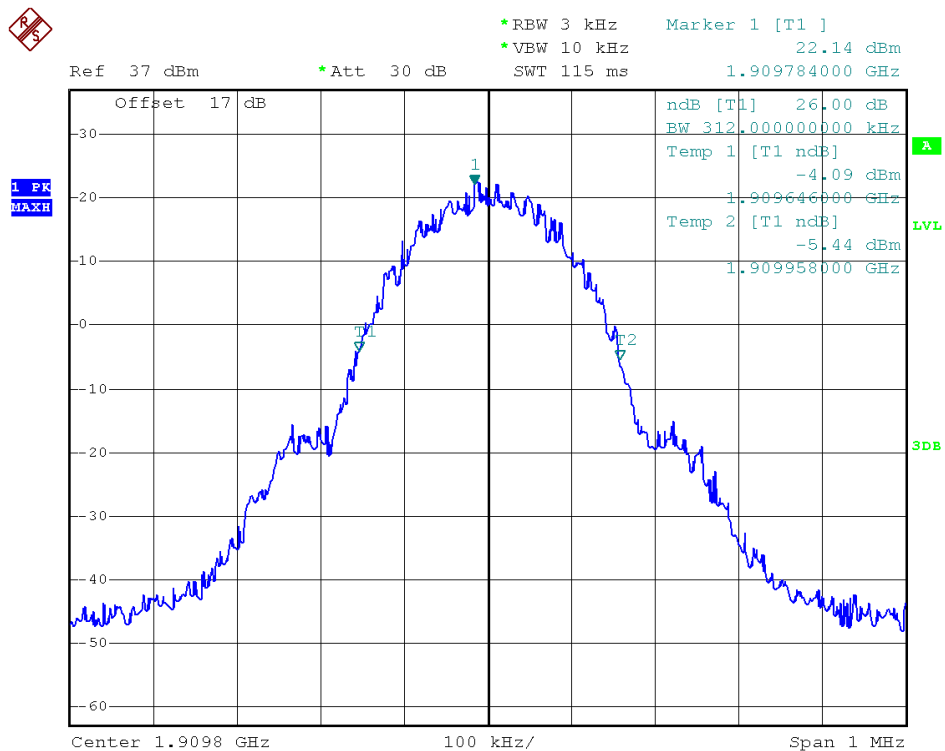

(Plot D5: EDGE 1900MHz Channel = 810 26dB bandwidth)

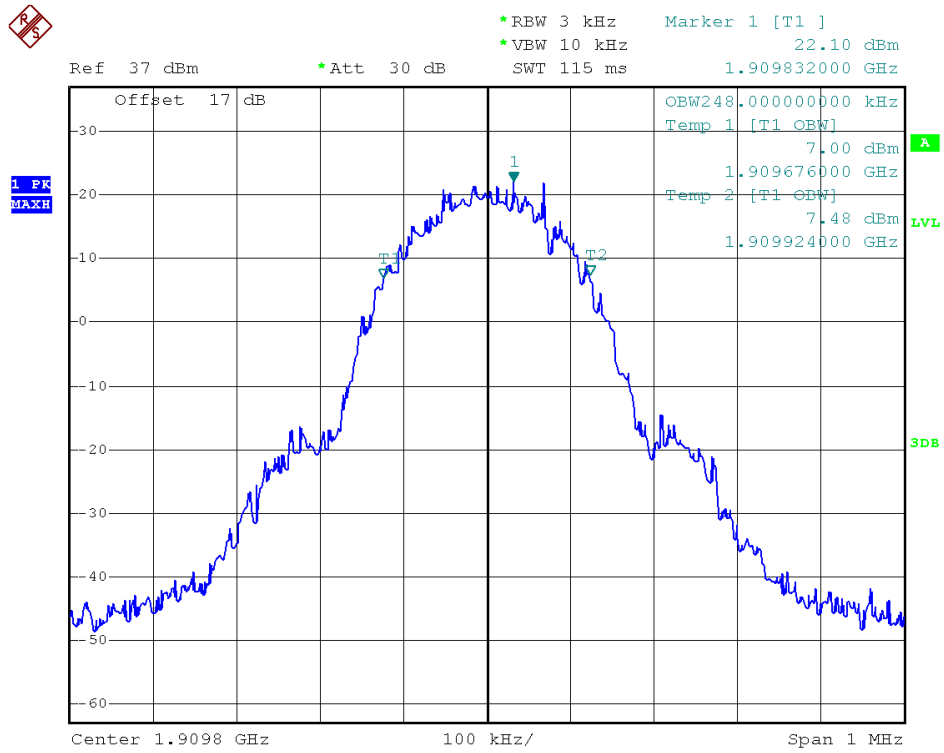

(Plot D6: EDGE 1900MHz Channel = 810 99% Occupied Bandwidth)

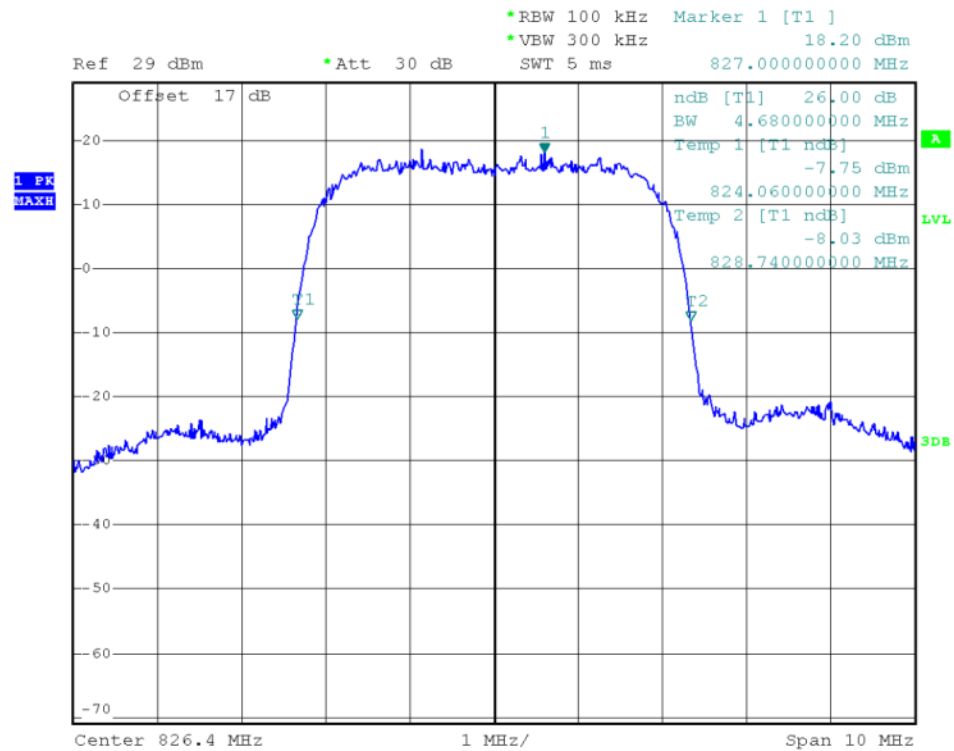

(Plot E1: WCDMA 850MHz Channel = 4132 26dB bandwidth)

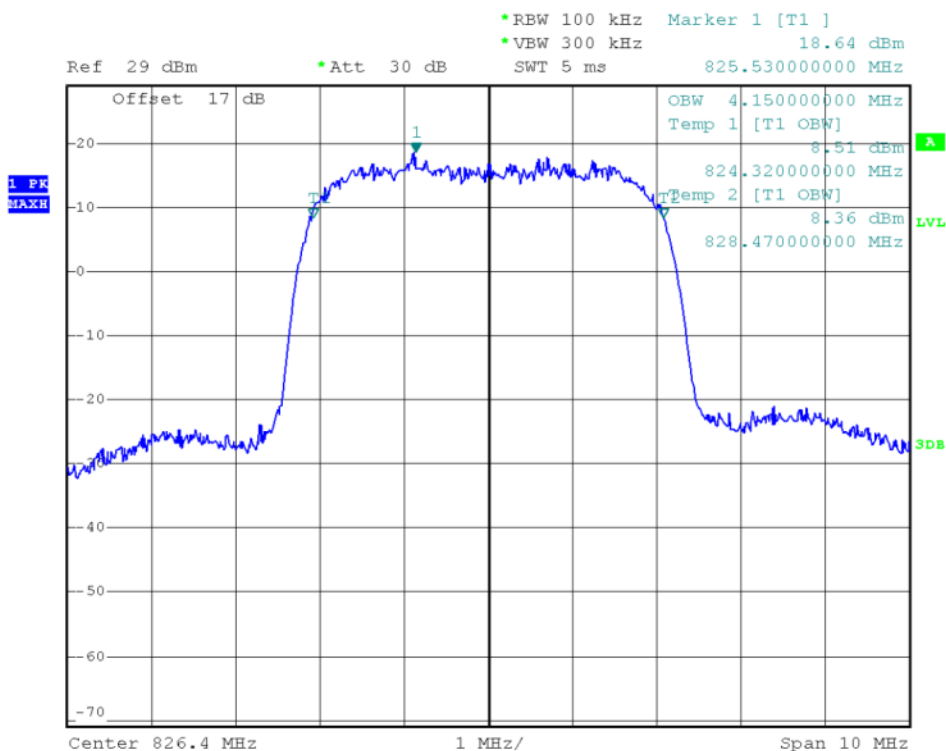

(Plot E2: WCDMA 850MHz Channel = 4132 99% Occupied Bandwidth)

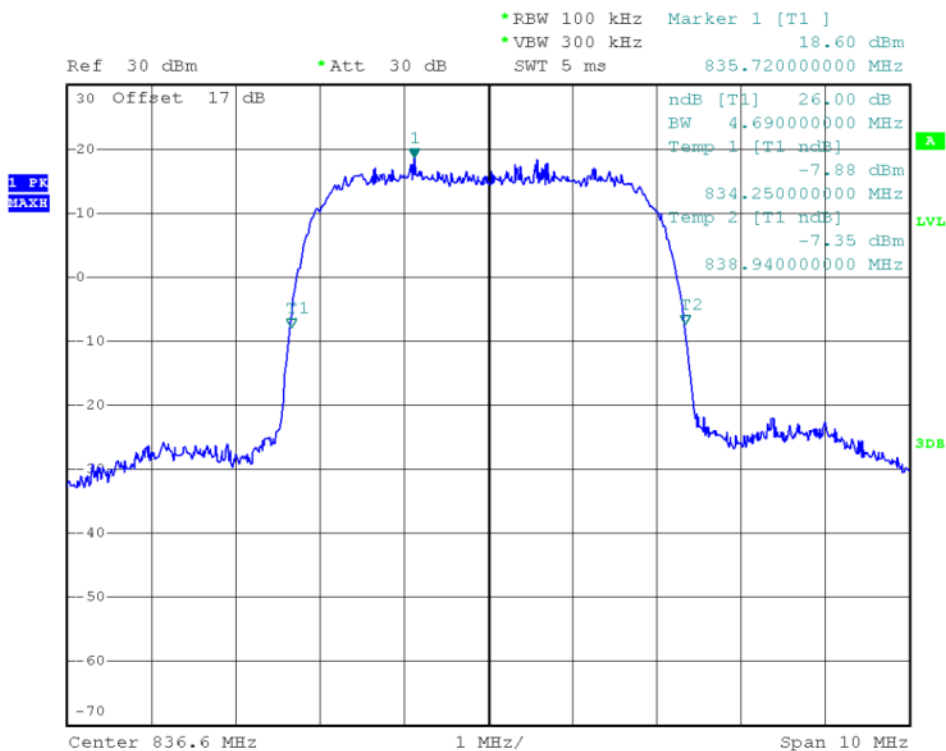

(Plot E3: WCDMA 850MHz Channel = 4183 26dB bandwidth)

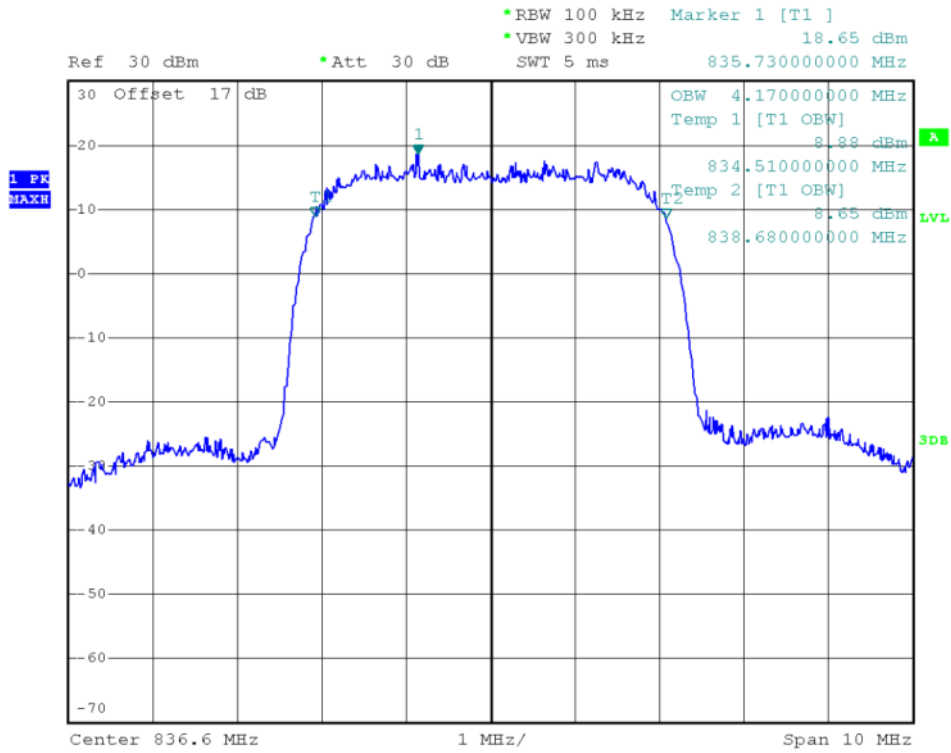

(Plot E4: WCDMA 850MHz Channel = 4183 99% Occupied Bandwidth)

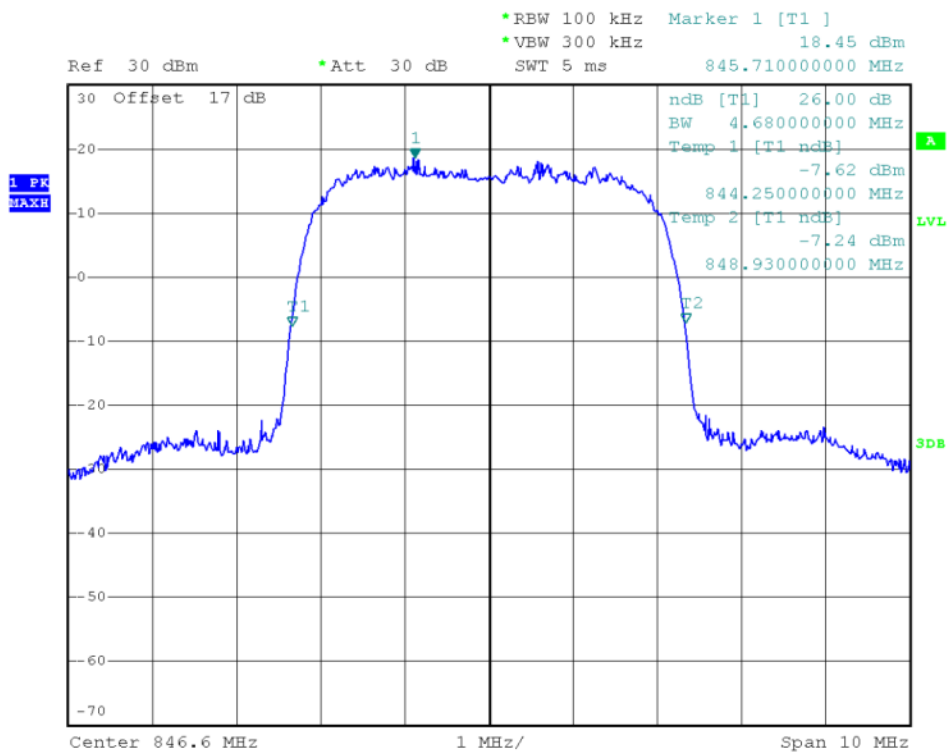

(Plot E5: WCDMA 850MHz Channel = 4233 26dB bandwidth)

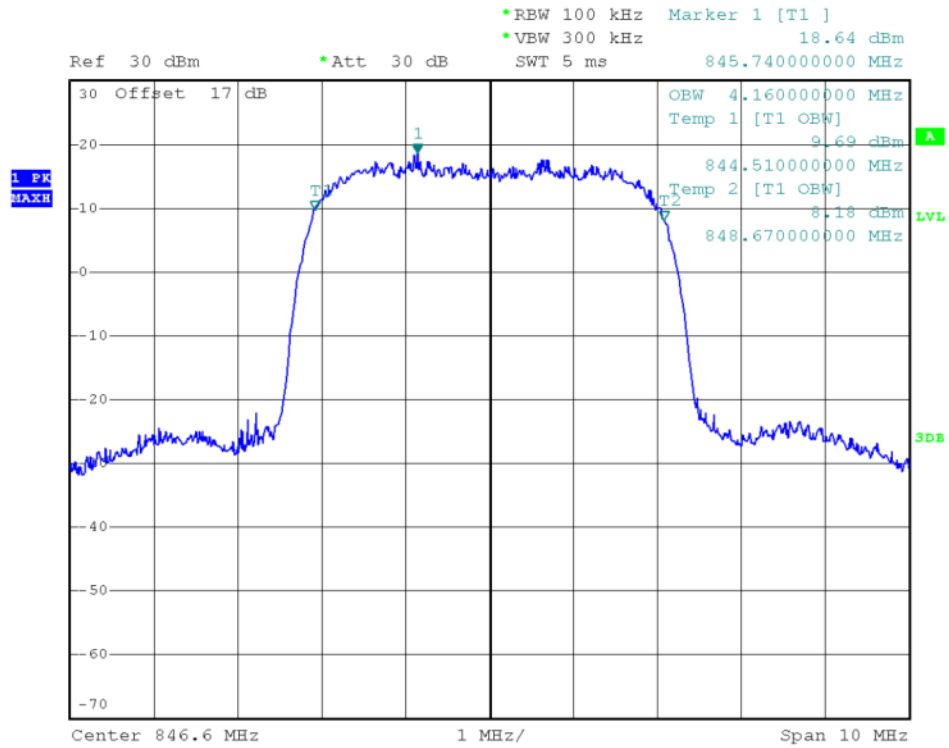

(Plot E6: WCDMA 850MHz Channel = 4233 99% Occupied Bandwidth)

2.4 Frequency Stability

2.4.1 Requirement

The frequency stability shall be measured by variation of ambient temperature and variation of primary supply voltage to ensure that the fundamental emission stays within the authorized frequency block. The frequency stability of the transmitter shall be maintained within $\pm 0.00025\%$ ($\pm 2.5\text{ppm}$) of the center frequency.

2.4.2 Test Description

1. Test Setup:

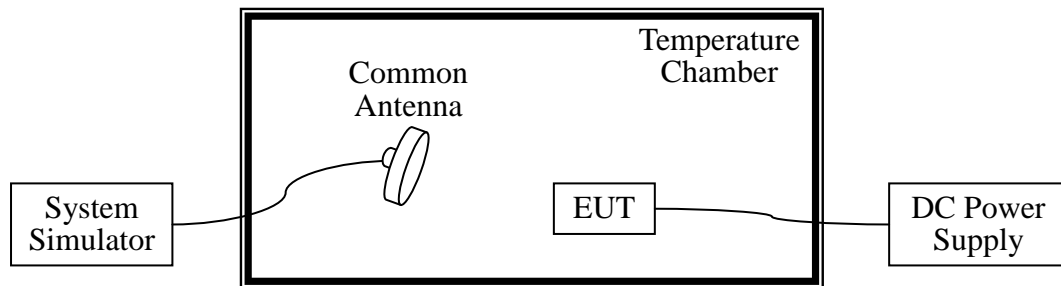

The EUT, which is powered by the DC Power Supply directly, is located in the Temperature Chamber. The EUT is commanded by the System Simulator (SS) to operate at the maximum output power i.e. Power Control Level (PCL) = 5 and Power Class = 4. A call is established between the EUT and the SS via a Common Antenna.

2. Equipments List:

Description	Manufacturer	Model	Serial No.	Cal. Data	Cal. Due Data
System Simulator	Agilent	E5515C	GB43130131	2014.06.11	2015.06.10
DC Power Supply	Good Will	GPS-3030DD	EF920938	2014.06.11	2015.06.10
Temperature Chamber	YinHe Experimental Equip.	HL4003T	(n.a.)	2014.06.11	2015.06.10
Cable	SUNHNER	SUCOFLEX 100	/	2014.06.05	2015.06.04

2.4.3 Test Procedures for Temperature Variation

1. The testing follows FCC KDB 971168 v02r02 Section 9.0.
2. The EUT was set up in the thermal chamber and connected with the system simulator.

3. With power OFF, the temperature was decreased to -30 °C and the EUT was stabilized before testing. Power was applied and the maximum change in frequency was recorded within one minute.
4. With power OFF, the temperature was raised in 10 °C steps up to 50 °C. The EUT was stabilized at each step for at least half an hour. Power was applied and the maximum frequency change was recorded within one minute.

2.4.4 Test Procedures for Voltage Variation

1. The testing follows FCC KDB 971168 v02r02 Section 9.0.
2. The EUT was placed in a temperature chamber at 25 ± 5 °C and connected with the system simulator.
3. The power supply voltage to the EUT was varied from BEP to 115% of the nominal value measured at the input to the EUT.
4. The variation in frequency was measured for the worst case.

2.4.5 Test Verdict

The nominal, highest and lowest extreme voltages are separately 3.8VDC, 4.2VDC and 3.6VDC, which are specified by the applicant; the normal temperature here used is 25 °C.

1. GSM 850MHz Band

Test Conditions		Frequency Deviation						Verdict
Power (VDC)	Temperature (°C)	Channel = 128 (824.2MHz)		Channel = 190 (836.6MHz)		Channel = 251 (848.8MHz)		
		Hz	Limits	Hz	Limits	Hz	Limits	
3.8	-30	-4.32	±2060.5	27.18	±2091.5	5.05	±2122	PASS
	-20	35.25		30.07		7.49		
	-10	-19.21		5.48		0.19		
	0	27.75		-1.82		34.30		
	+10	-13.73		19.02		43.11		
	+20	-6.95		44.78		-16.51		
	+30	38.07		21.99		19.46		
	+40	42.07		17.67		-6.80		
	+50	38.85		-19.44		7.58		
4.2	+25	31.42		-6.76		3.11		
3.6	+25	4.49		14.09		-4.93		

2. GSM 1900MHz Band

Test Conditions		Frequency Deviation						Verdict
Power (VDC)	Temperature (°C)	Channel = 512 (1850.2MHz)		Channel = 661 (1880.0MHz)		Channel = 810 (1909.8MHz)		
		Hz	Limits	Hz	Limits	Hz	Limits	
3.8	-30	-0.97	±1850.2	51.25	±1880.0	1.12	±1909.8	PASS
	-20	35.71		51.56		8.81		
	-10	54.73		48.10		22.21		
	0	25.45		43.19		47.37		
	+10	18.46		6.50		14.85		
	+20	20.42		3.76		33.63		
	+30	0.36		7.11		38.27		
	+40	26.25		5.70		57.38		
+50	24.14	-5.74	21.22					
4.2	+25	12.46	42.11	50.98				
3.6	+25	46.55	5.31	0.95				

3. EDGE 850MHz Band

Test Conditions		Frequency Deviation						Verdict
Power (VDC)	Temperature (°C)	Channel = 128 (824.2MHz)		Channel = 190 (836.6MHz)		Channel = 251 (848.8MHz)		
		Hz	Limits	Hz	Limits	Hz	Limits	
3.7	-30	-21.55	±2060.5	20.32	±2091.5	17.44	±2122	PASS
	-20	19.15		16.31		-11.07		
	-10	-2.15		-17.56		15.22		
	0	30.16		32.11		7.05		
	+10	21.99		-25.03		3.02		
	+20	-19.16		-17.19		10.52		
	+30	35.26		19.36		-13.21		
	+40	42.63		19.64		-2.11		
+50	35.28	22.27	-12.99					
4.2	+25	-14.73	28.95	-41.58				
3.4	+25	-17.02	31.09	16.11				

4. EDGE 1900MHz Band

Test Conditions		Frequency Deviation						Verdict
Power (VDC)	Temperature (°C)	Channel = 512 (1850.2MHz)		Channel = 661 (1880.0MHz)		Channel = 810 (1909.8MHz)		
		Hz	Limits	Hz	Limits	Hz	Limits	
3.7	-30	-0.59	±1850.2	-15.27	±1880.0	11.24	±1909.8	PASS
	-20	21.45		19.32		-15.71		
	-10	13.45		25.31		-16.22		
	0	1.31		30.26		19.32		
	+10	-12.52		-29.21		25.31		
	+20	30.62		19.33		30.26		
	+30	13.45		-19.27		-59.21		
	+40	-12.52		26.29		19.33		
	+50	30.62		18.97		-19.27		
4.2	+25	-0.59		-16.28		26.29		
3.4	+25	21.01		19.32		18.97		

5. WCDMA 850MHz Band

Test Conditions		Frequency Deviation						Verdict
Power (VDC)	Temperature (°C)	Channel = 4123 (826.4MHz)		Channel = 4183 (836.6MHz)		Channel = 4233 (846.6MHz)		
		Hz	Limit	Hz	Limit	Hz	Limit	
3.8	-30	20.79	±2066	46.68	±2091.5	22.69	±2116.5	PASS
	-20	44.54		28.10		2.39		
	-10	10.45		-4.27		44.53		
	0	10.88		36.69		12.66		
	+10	34.76		13.61		40.37		
	+20	2.46		12.15		-5.39		
	+30	27.07		23.94		35.13		
	+40	-8.66		13.56		-0.53		
	+55	14.23		47.64		37.40		
4.2	+25	43.35		52.86		31.75		
3.6	+25	35.82		3.68		38.60		

2.5 Conducted Out of Band Emissions

2.5.1 Requirement

The power of any emission outside of the authorized operating frequency ranges must be lower than the transmitter power (P) by a factor of at least $43 + 10 \log (P)$ dB.

It is measured by means of a calibrated spectrum analyzer and scanned from 30 MHz up to a frequency including its 10th harmonic.

2.5.2 Test Description

See section 2.1.2 of this report.

2.5.3 Test Procedures

1. The testing follows FCC KDB 971168 v02r02 Section 6.0.
2. The EUT was connected to the spectrum analyzer and system simulator via a power divider.
3. The RF output of EUT was connected to the spectrum analyzer by an RF cable and attenuator. The path loss was compensated to the results for each measurement.
4. The middle channel for the highest RF power within the transmitting frequency was measured.
5. The conducted spurious emission for the whole frequency range was taken.
6. The RF fundamental frequency should be excluded against the limit line in the operating frequency band.
7. The limit line is derived from $43 + 10\log(P)$ dB below the transmitter power P(Watts)
 - = $P(W) - [43 + 10\log(P)]$ (dB)
 - = $[30 + 10\log(P)]$ (dBm) - $[43 + 10\log(P)]$ (dB)
 - = -13dBm.

2.5.4 Test Result

The measurement frequency range is from 30MHz to the 10th harmonic of the fundamental frequency. The lowest, middle and highest channels are tested to verify the out of band emissions.

1. Test Verdict:

Band	Channel	Frequency (MHz)	Measured Max. Spurious Emission (dBm)	Refer to Plot	Limit (dBm)	Verdict
GSM 850MHz	128	824.2	-27.57	Plot A1toA1.1	-13	PASS
	190	836.6	-28.66	Plot A2toA2.1		PASS
	251	848.8	-28.63	Plot A3toA3.1		PASS
GSM 1900MHz	512	1850.2	-20.24	Plot B1toB1.1	-13	PASS
	661	1880.0	-20.56	Plot B2toB2.1		PASS
	810	1909.8	-19.81	Plot B3toB3.1		PASS



Band	Channel	Frequency (MHz)	Measured Max. Spurious Emission (dBm)	Refer to Plot	Limit (dBm)	Verdict
EDGE 850MHz	128	824.2	-27.88	Plot C1toC1.1	-13	PASS
	190	836.6	-28.21	Plot C2toC2.1		PASS
	251	848.8	-28.05	Plot C3toC3.1		PASS
EDGE 1900MHz	512	1850.2	-20.12	Plot D1toD1.1	-13	PASS
	661	1880.0	-19.91	Plot D2toD2.1		PASS
	810	1909.8	-20.54	Plot D3toD3.1		PASS
WCDMA 850MHz	4132	826.4	-28.18	Plot E1toE1.1	-13	PASS
	4183	836.6	-27.95	Plot E2toE2.1		PASS
	4233	846.6	-27.81	Plot E3toE3.1		PASS

2. Test Plots for the Whole Measurement Frequency Range:

Note: the power of the EUT transmitting frequency should be ignored.

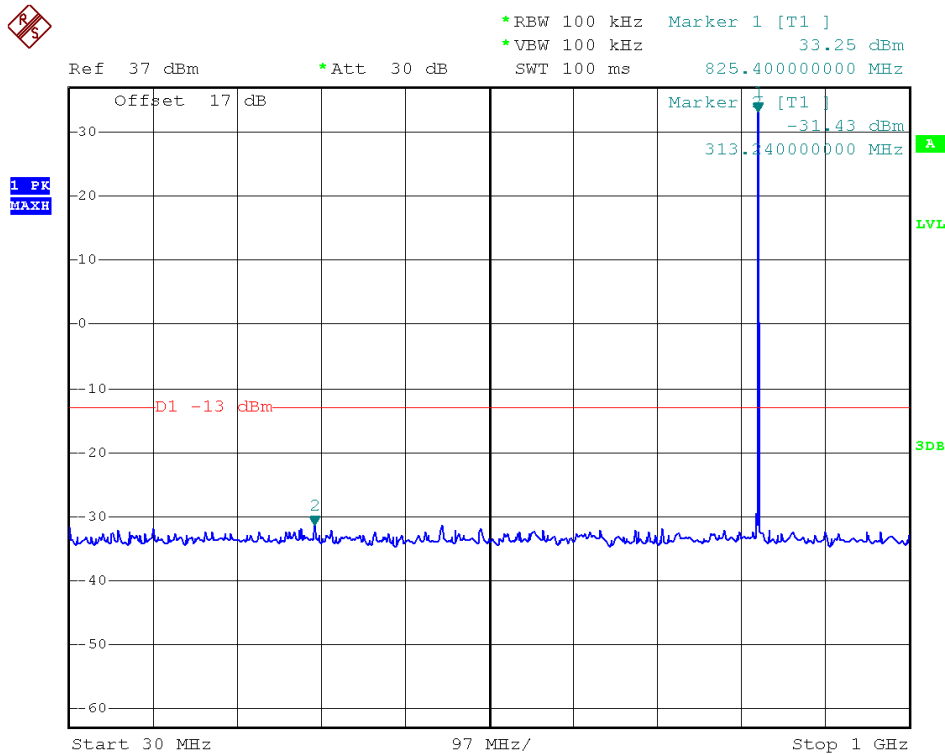

(Plot A1: GSM 850MHz Channel = 128, 30MHz to 1GHz)

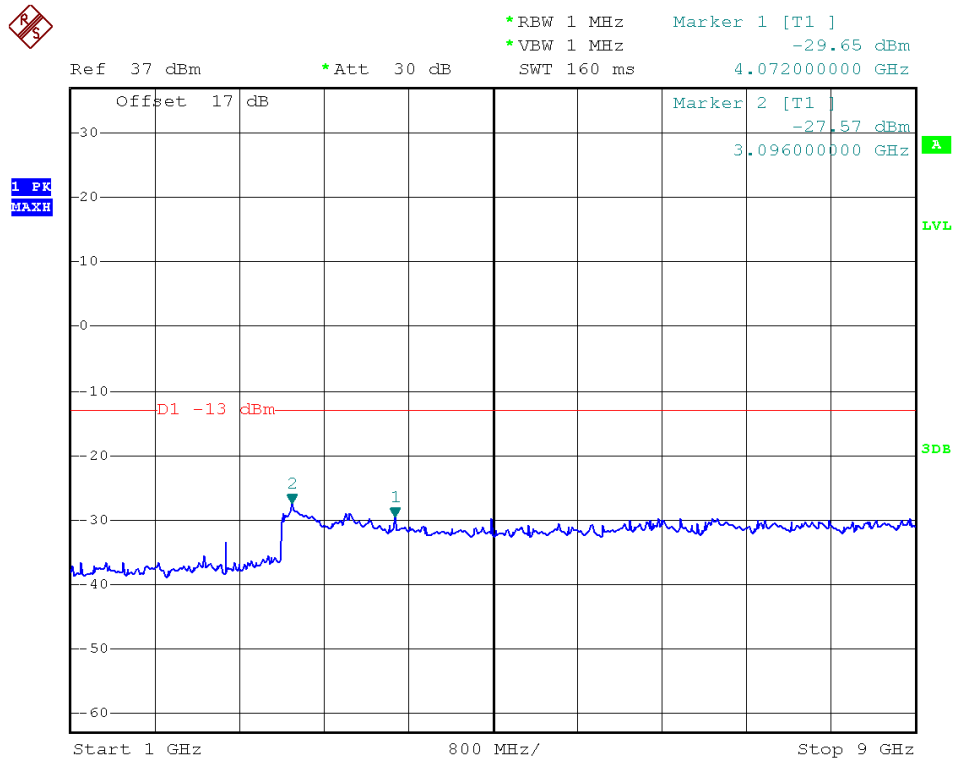

(Plot A1.1: GSM 850MHz Channel = 128, 1GHz to 9GHz)

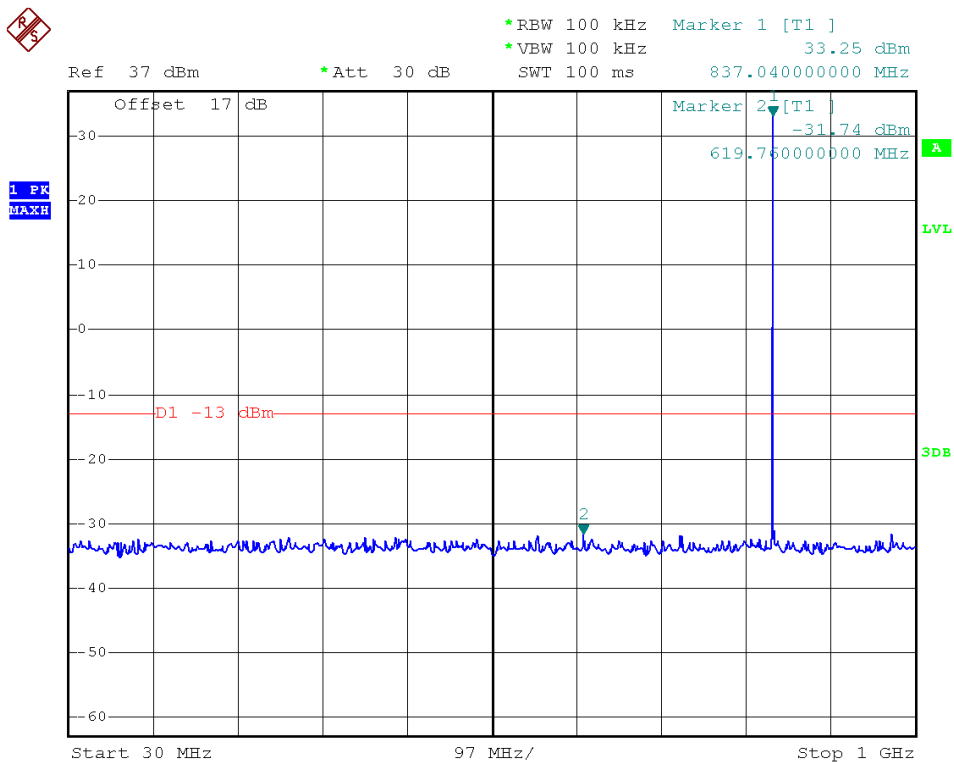

(Plot A2: GSM 850MHz Channel = 190, 30MHz to 1GHz)

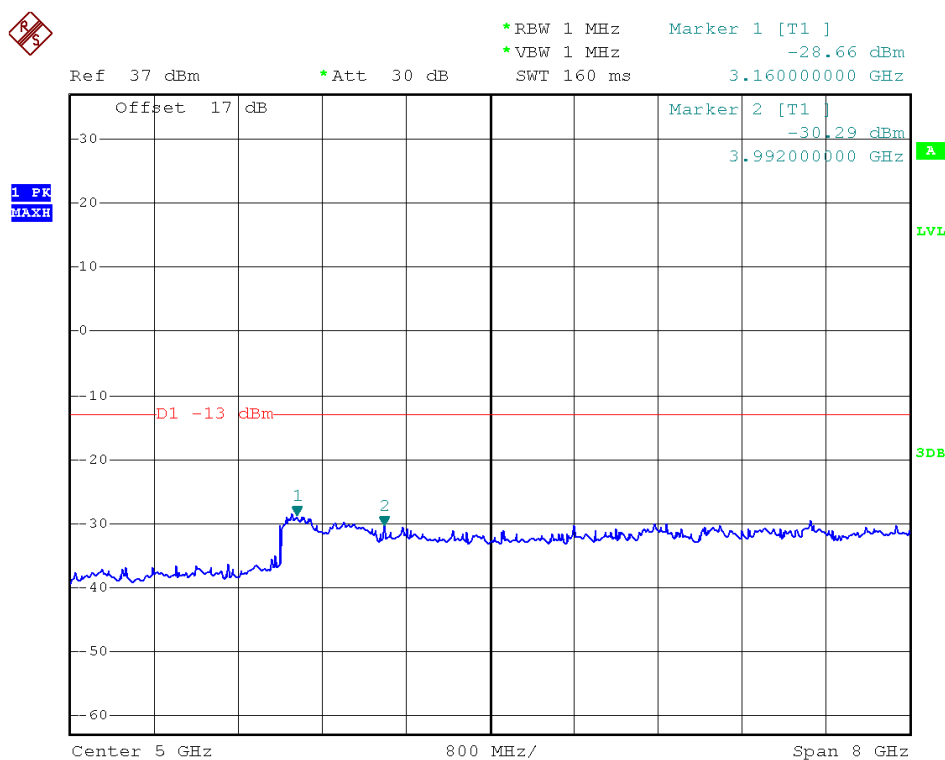

(Plot A2.1: GSM 850MHz Channel = 190, 1GHz to 9GHz)

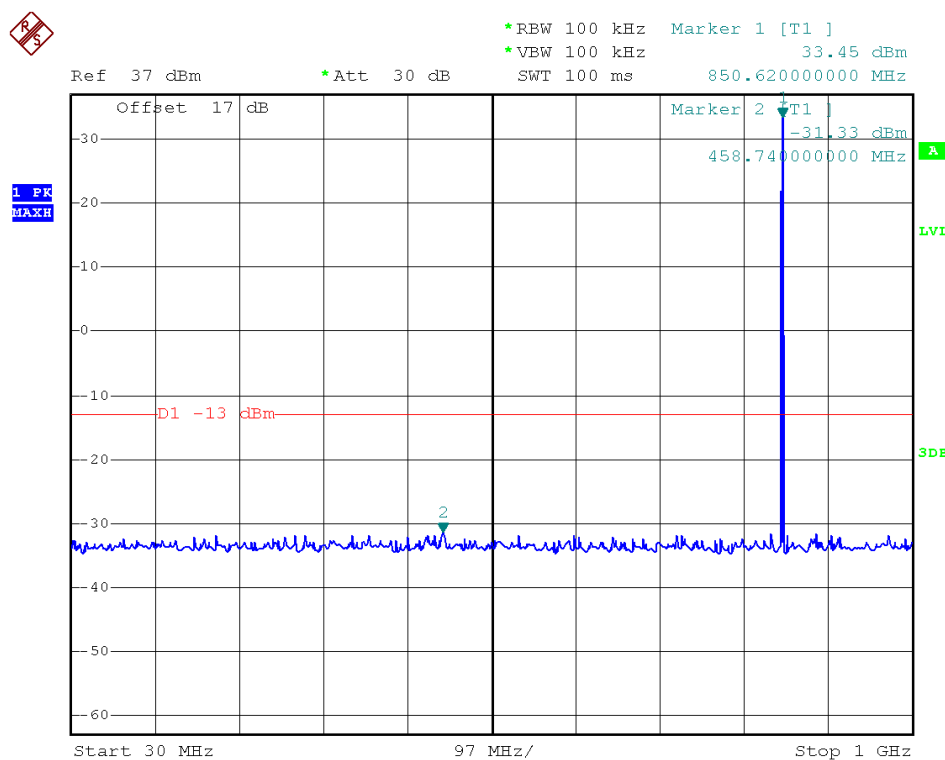

(Plot A3: GSM 850MHz Channel = 251, 30MHz to 1GHz)

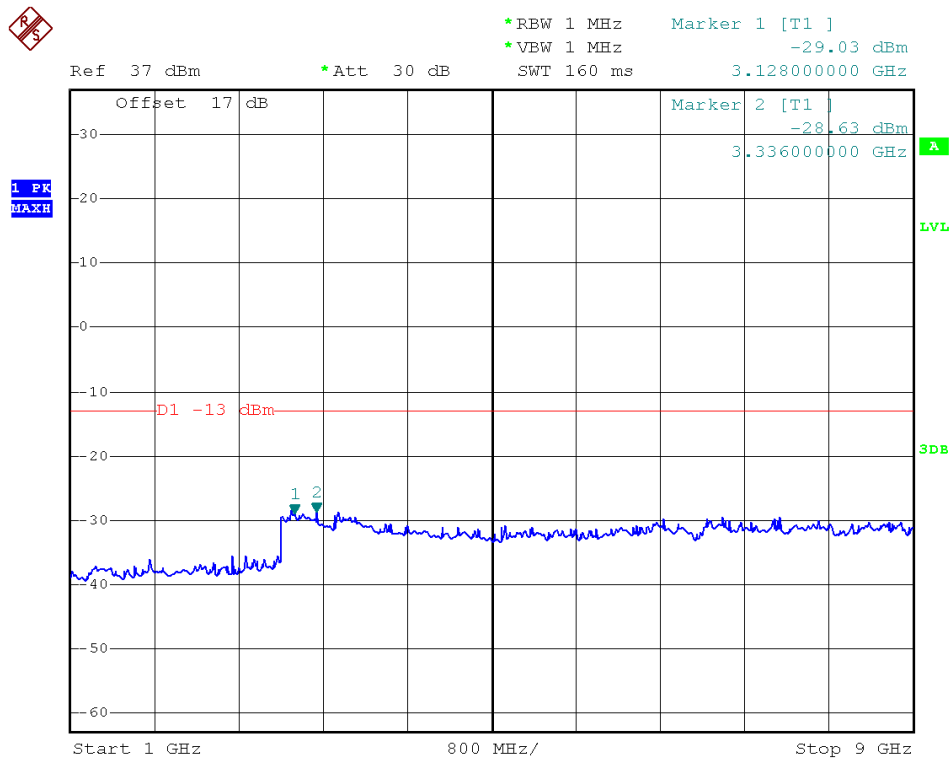

(Plot A3.1: GSM 850MHz Channel = 251, 1GHz to 9GHz)

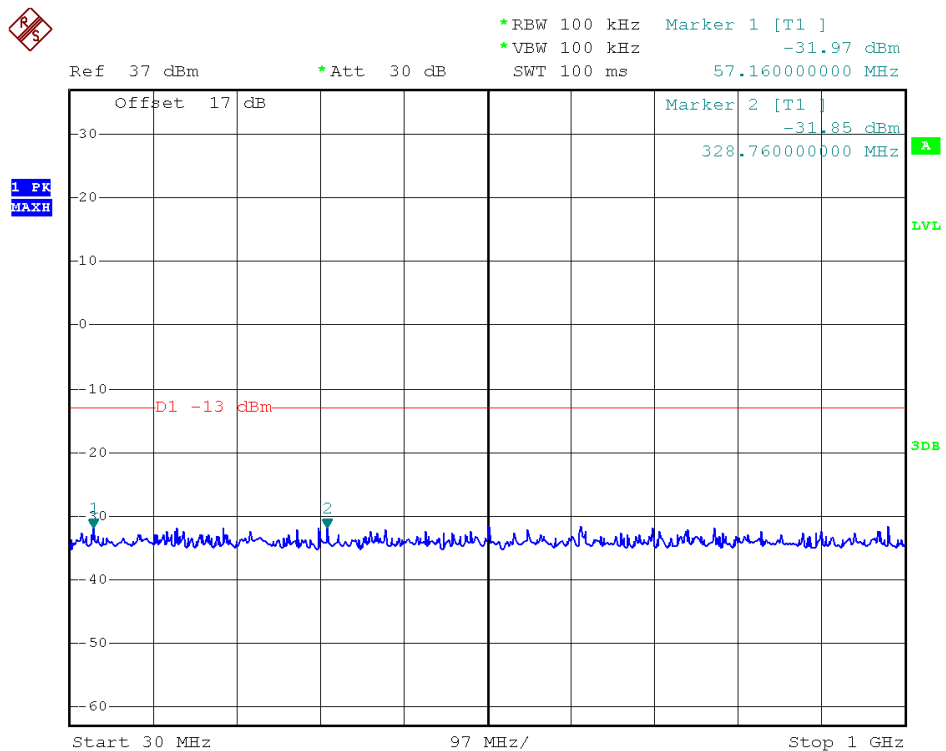

(Plot B1: GSM 1900MHz Channel = 512, 30MHz to 1GHz)

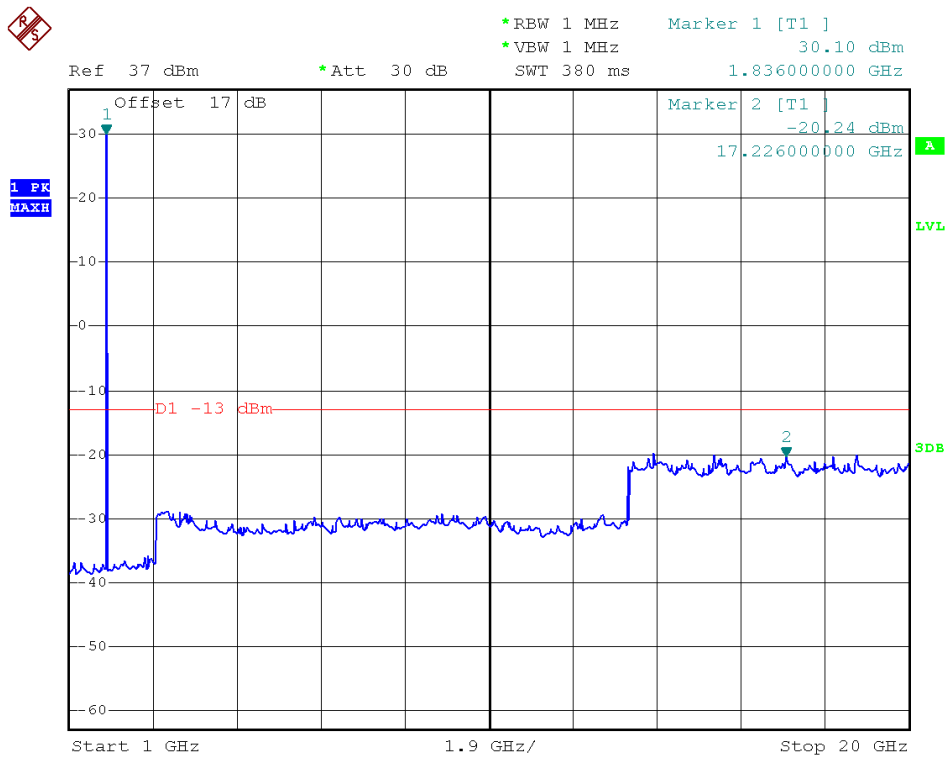

(Plot B1.1: GSM 1900MHz Channel = 512, 1GHz to 20GHz)

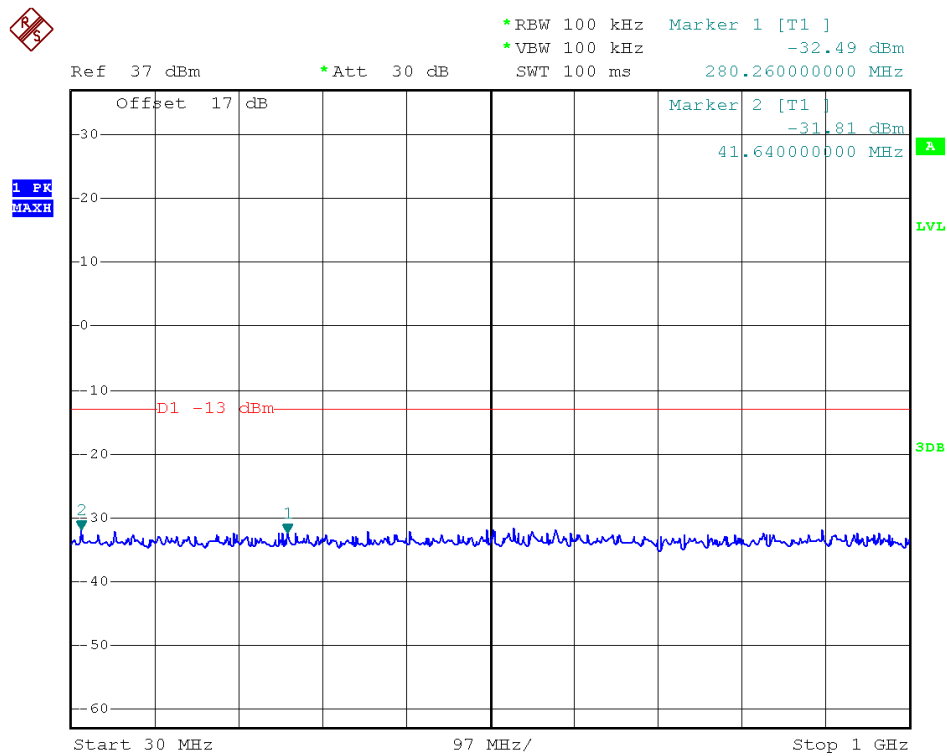

(Plot B2: GSM 1900MHz Channel = 661, 30MHz to 1GHz)

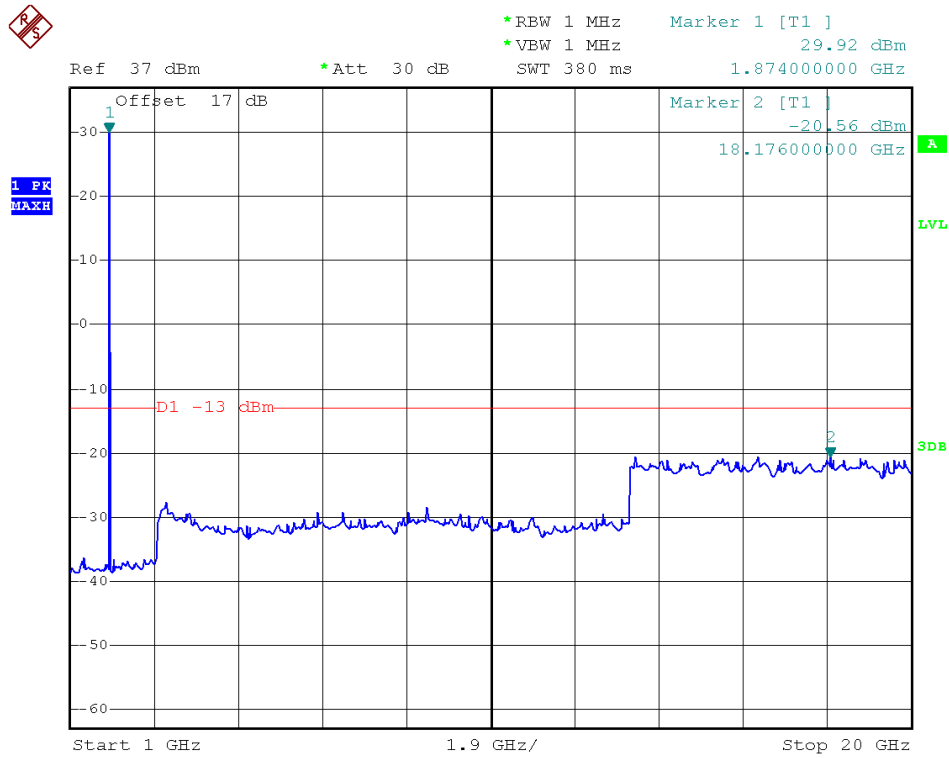

(Plot B2.1: GSM 1900MHz Channel = 661, 1GHz to 20GHz)

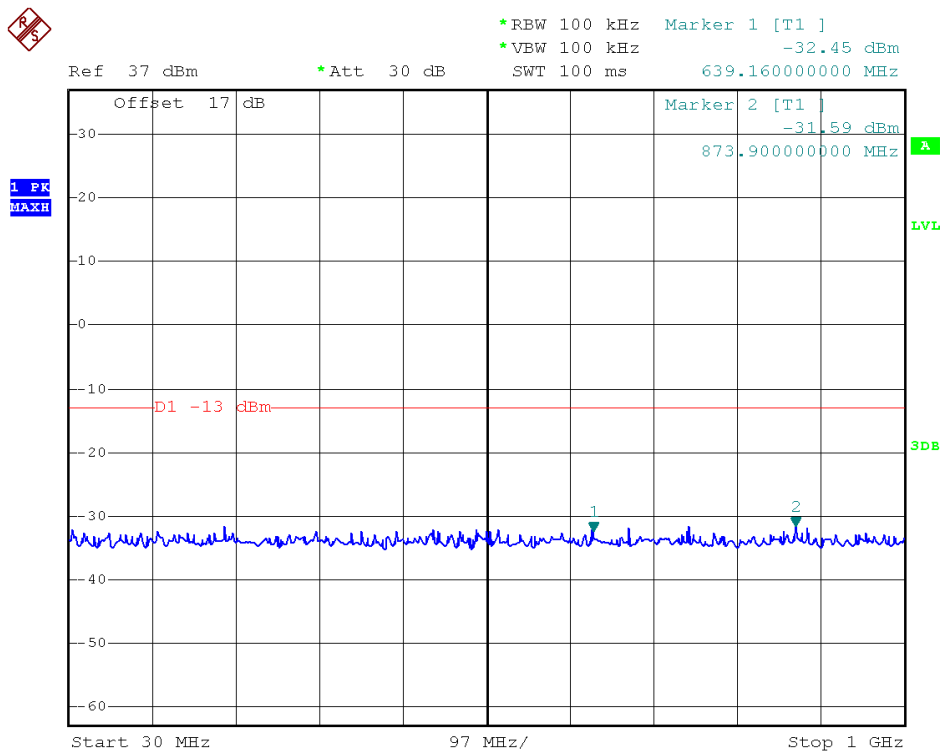

(Plot B3: GSM 1900MHz Channel = 810, 30MHz to 1GHz)

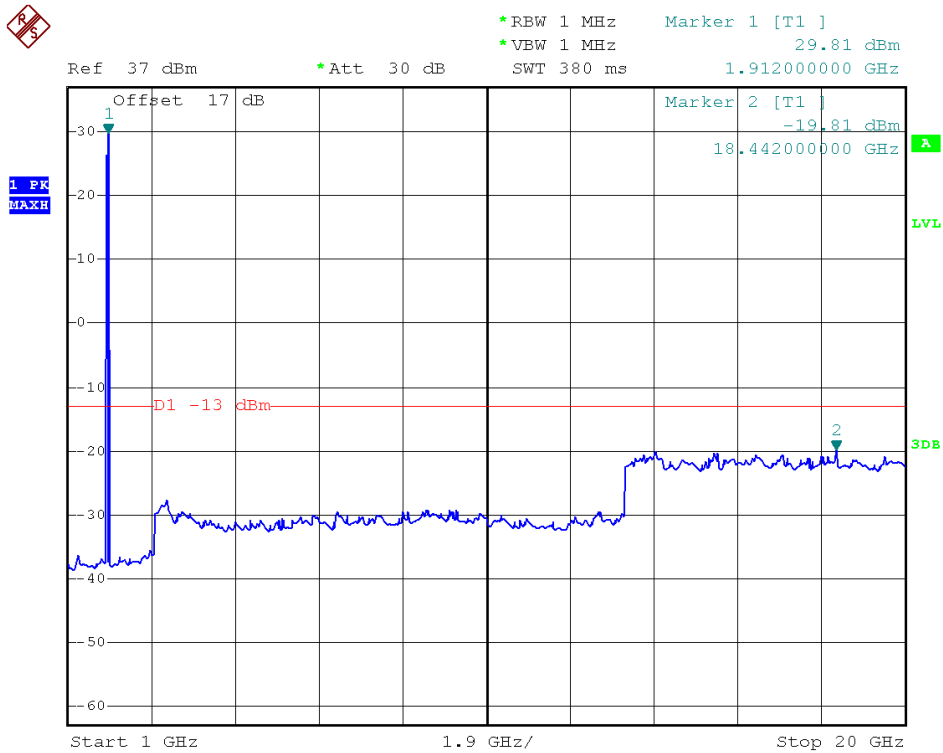

(Plot B3.1: GSM 1900MHz Channel = 810, 1GHz to 20GHz)

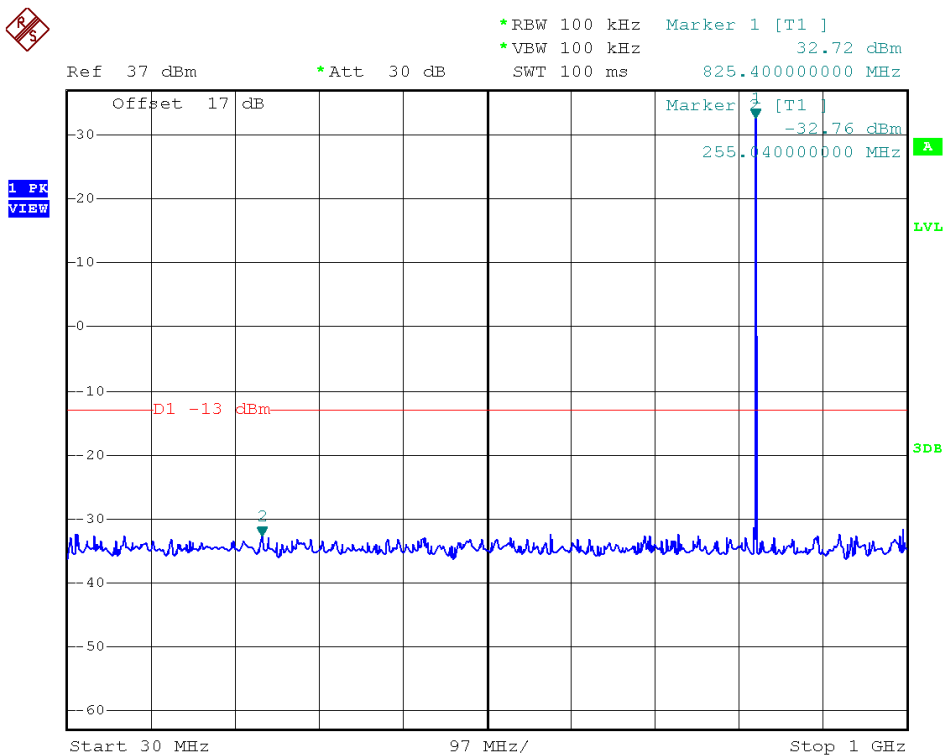

(Plot C1: EDGE 850MHz Channel = 128, 30MHz to 1GHz)

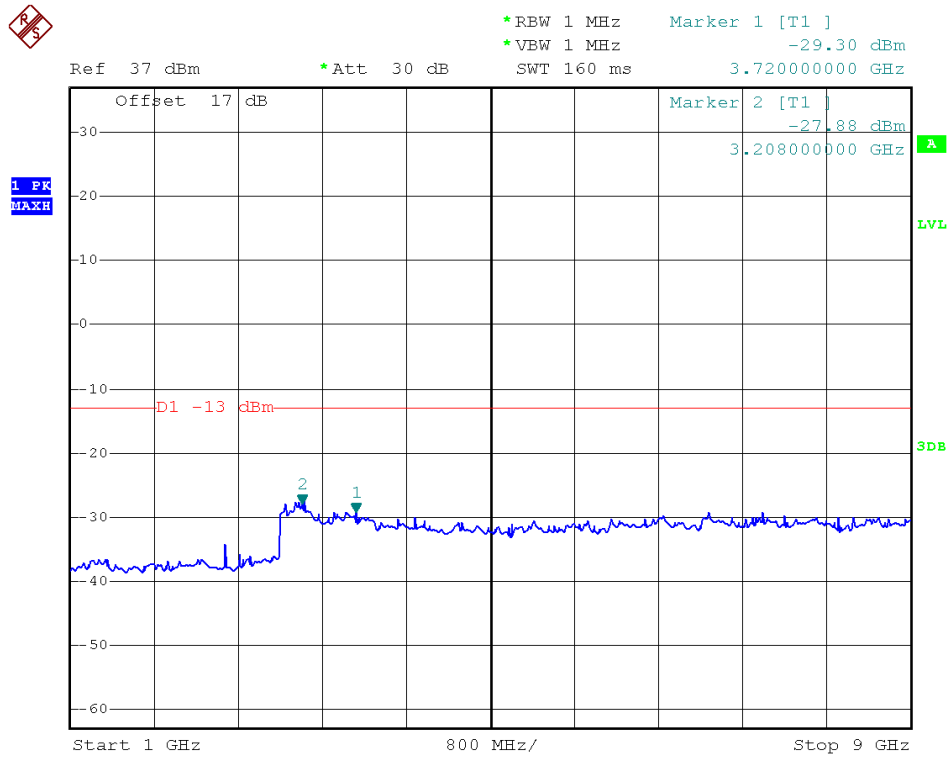

(Plot C1.1: EDGE 850MHz Channel = 128, 1GHz to 9GHz)

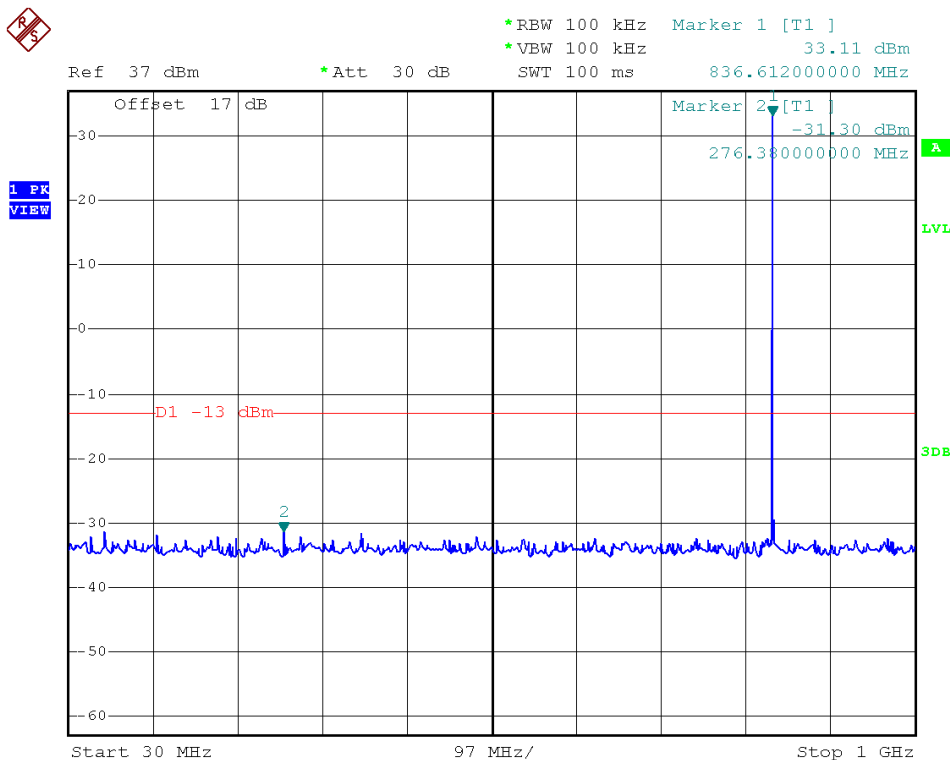

(Plot C2: EDGE 850MHz Channel = 190, 30MHz to 1GHz)

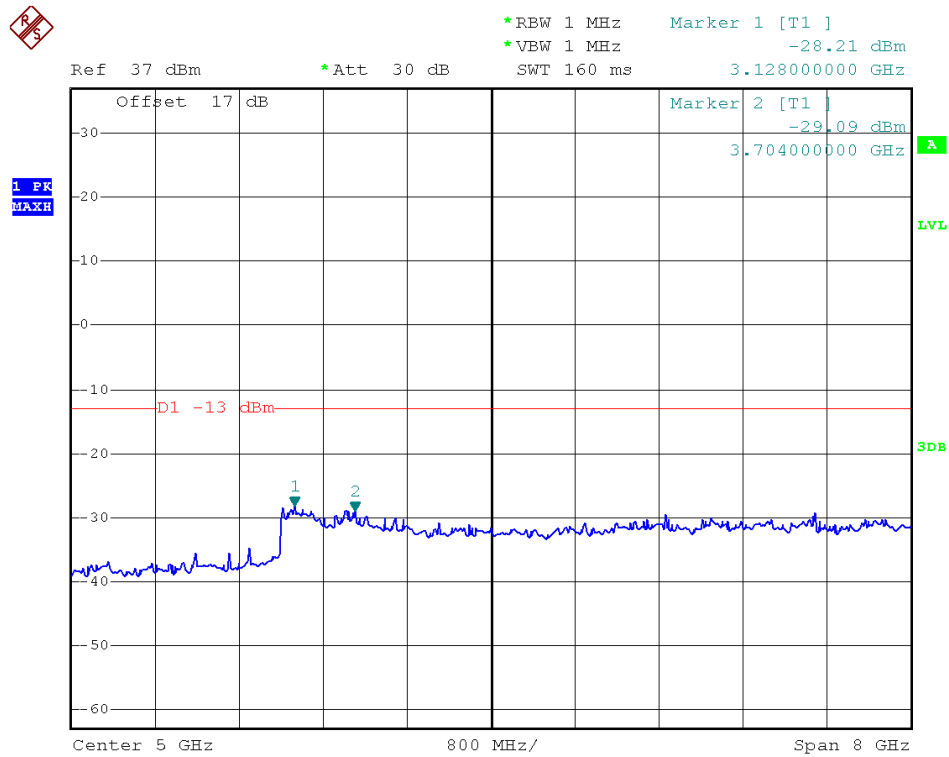

(Plot C2.1: EDGE 850MHz Channel = 190, 1GHz to 9GHz)

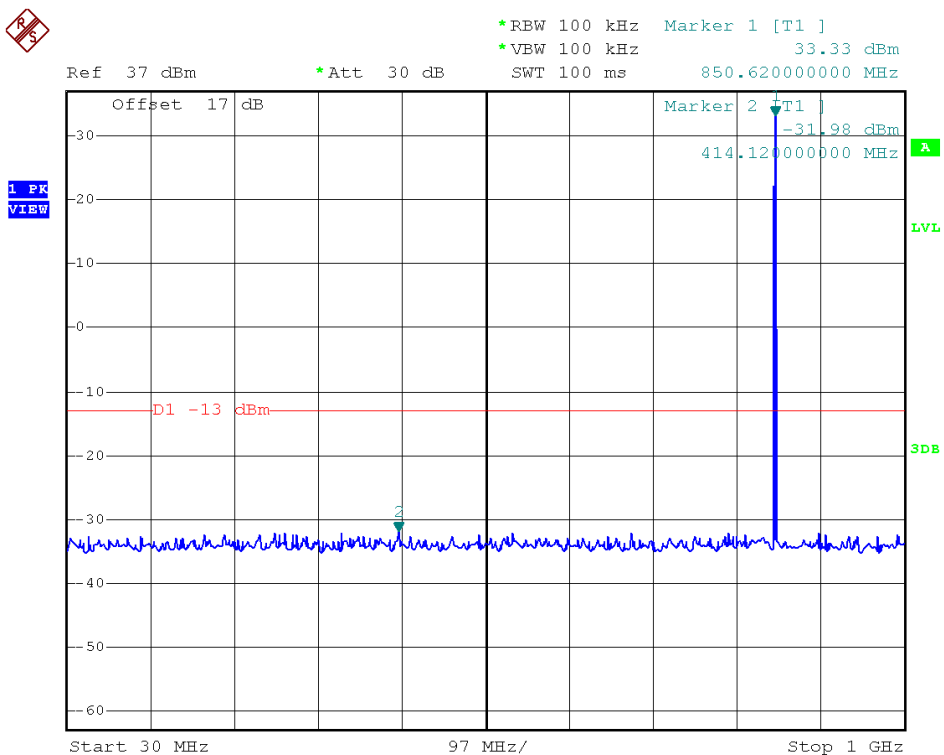

(Plot C3: EDGE 850MHz Channel = 251, 30MHz to 1GHz)

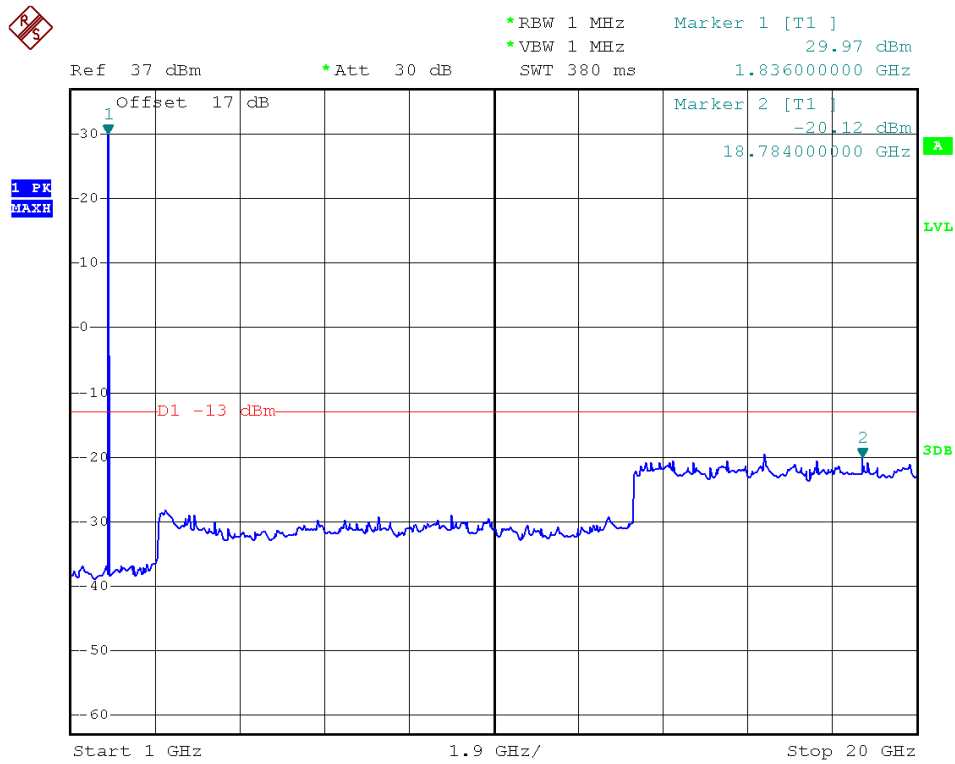

(Plot D1.1: EDGE 1900MHz Channel = 512, 1GHz to 20GHz)

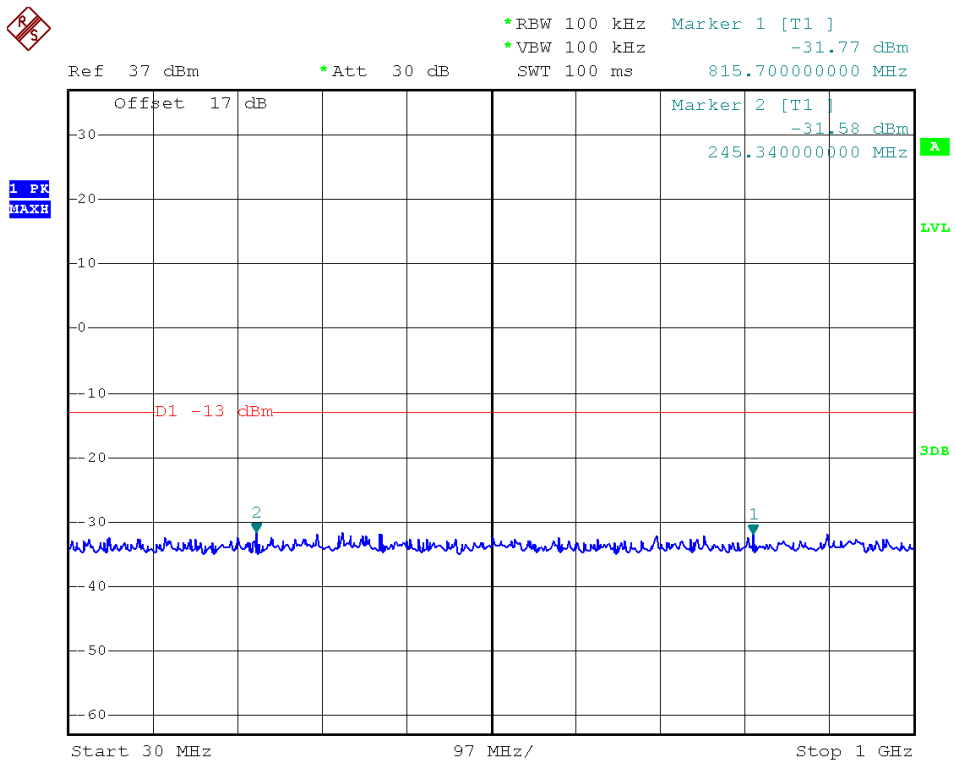

(Plot D2: EDGE 1900MHz Channel = 661, 30MHz to 1GHz)

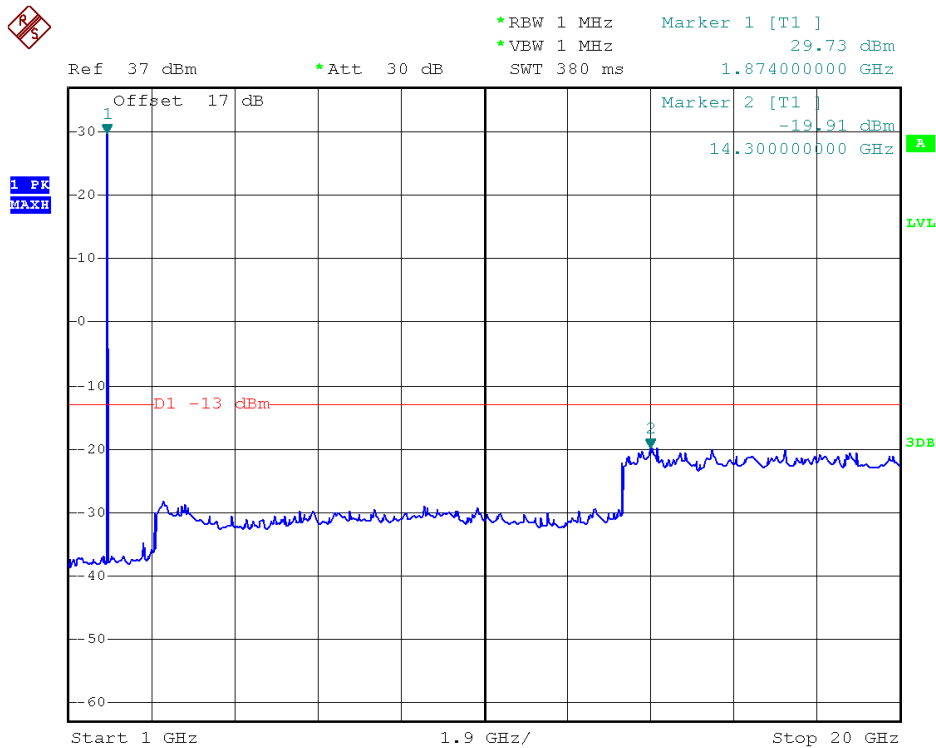

(Plot D2.1: EDGE 1900MHz Channel = 661, 1GHz to 20GHz)

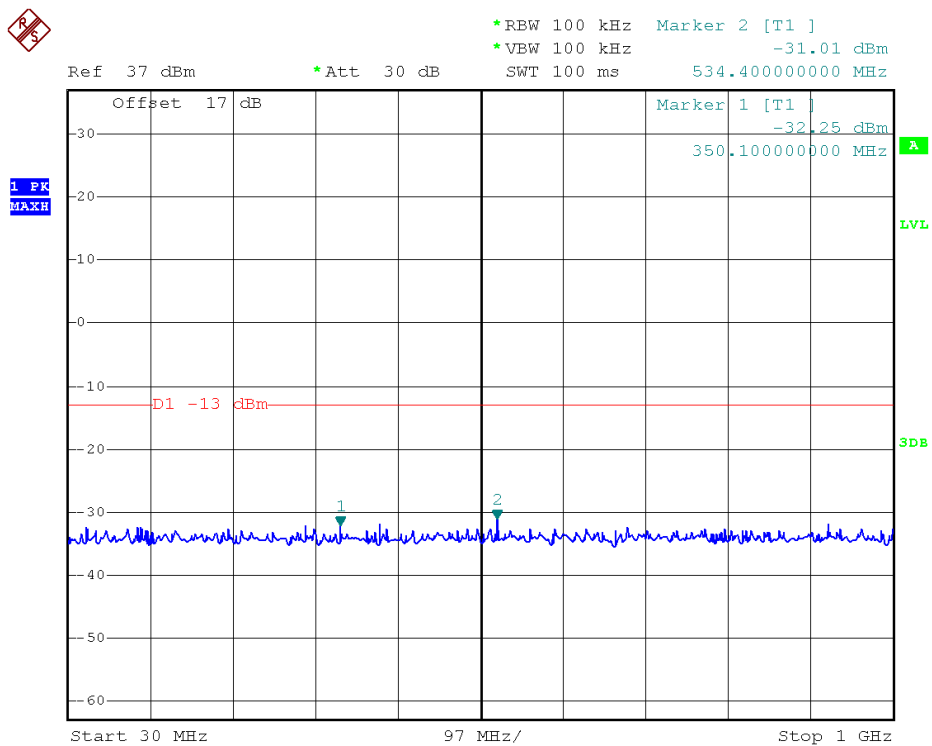

(Plot D3: EDGE 1900MHz Channel = 810, 30MHz to 1GHz)

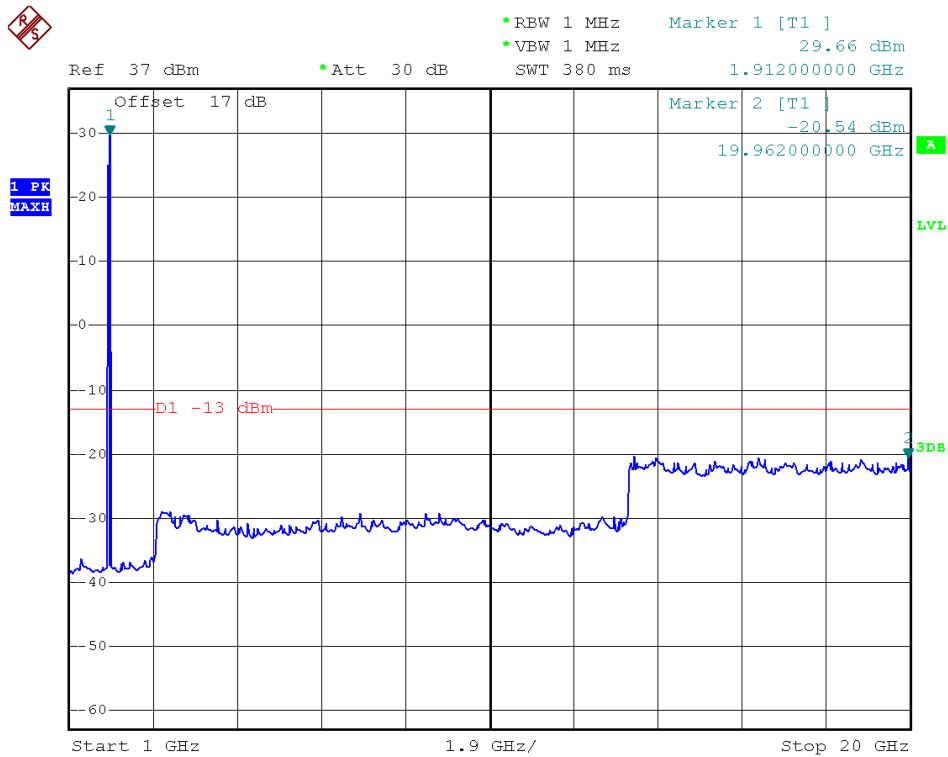

(Plot D3.1: EDGE 1900MHz Channel = 810, 1GHz to 20GHz)

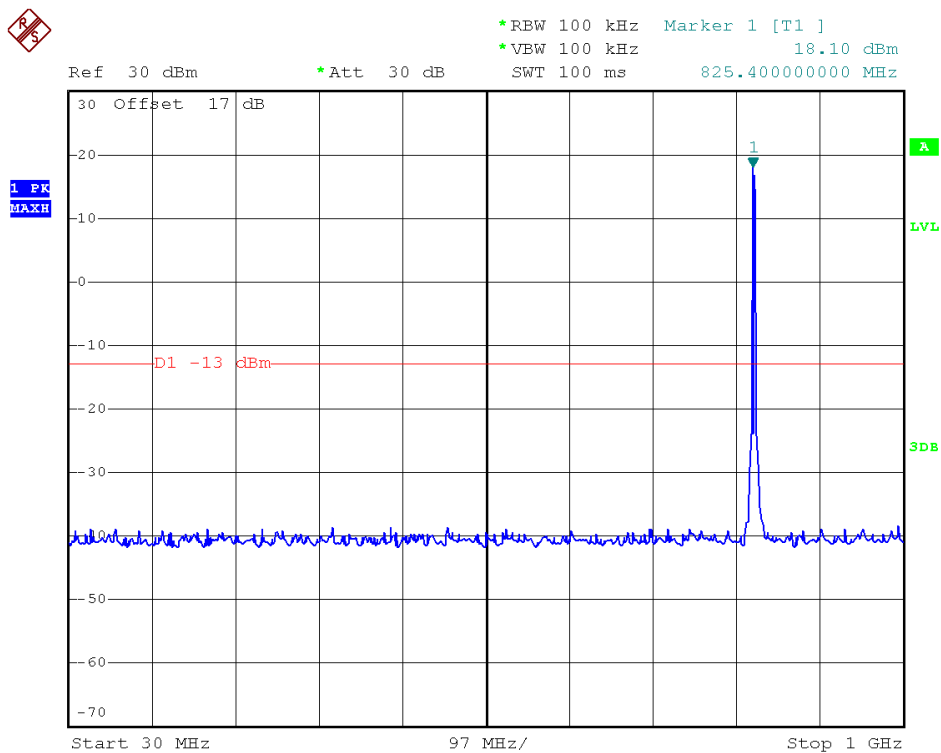

(Plot E1: WCDMA850MHz Channel = 4132, 30MHz to 1GHz)

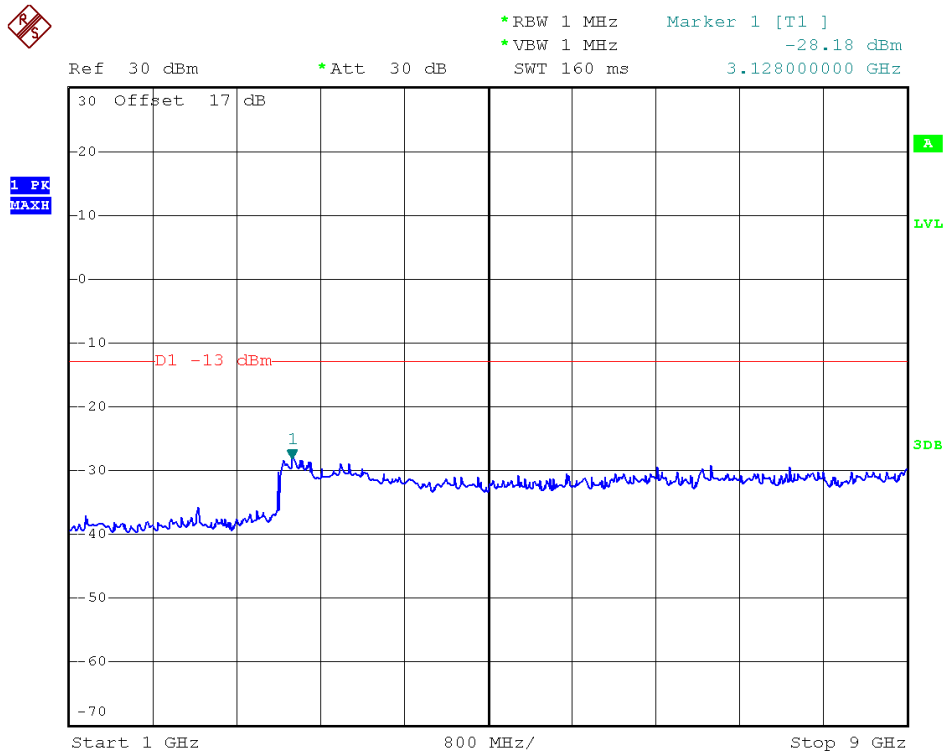

(Plot E1.1: WCDMA850MHz Channel = 4132, 1GHz to 9GHz)

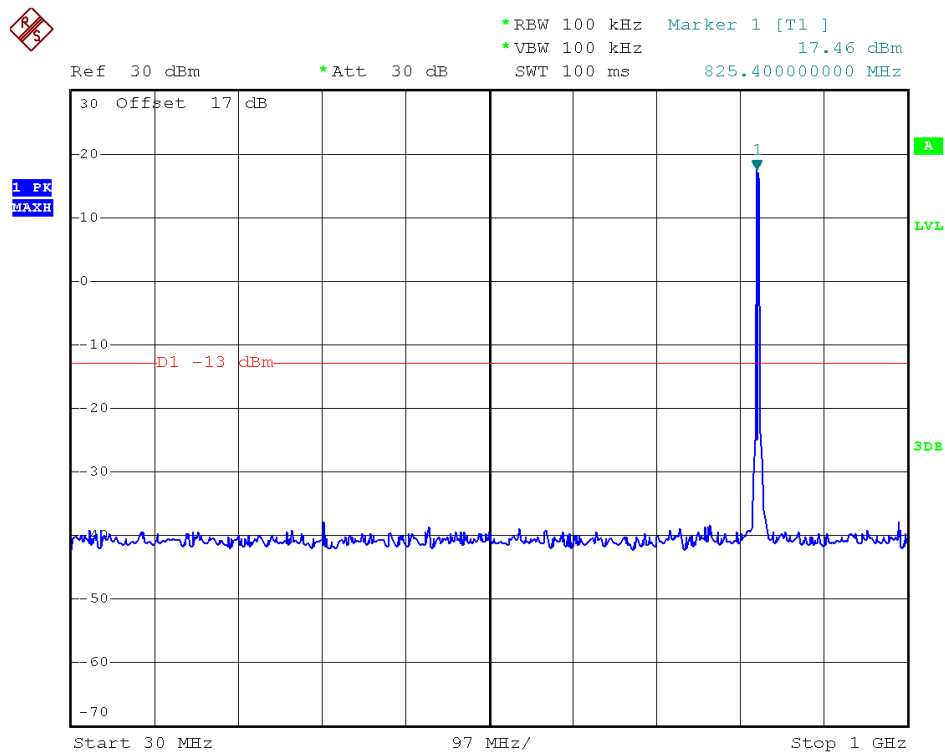

(Plot E2: WCDMA850MHz Channel = 4183, 30MHz to 1GHz)

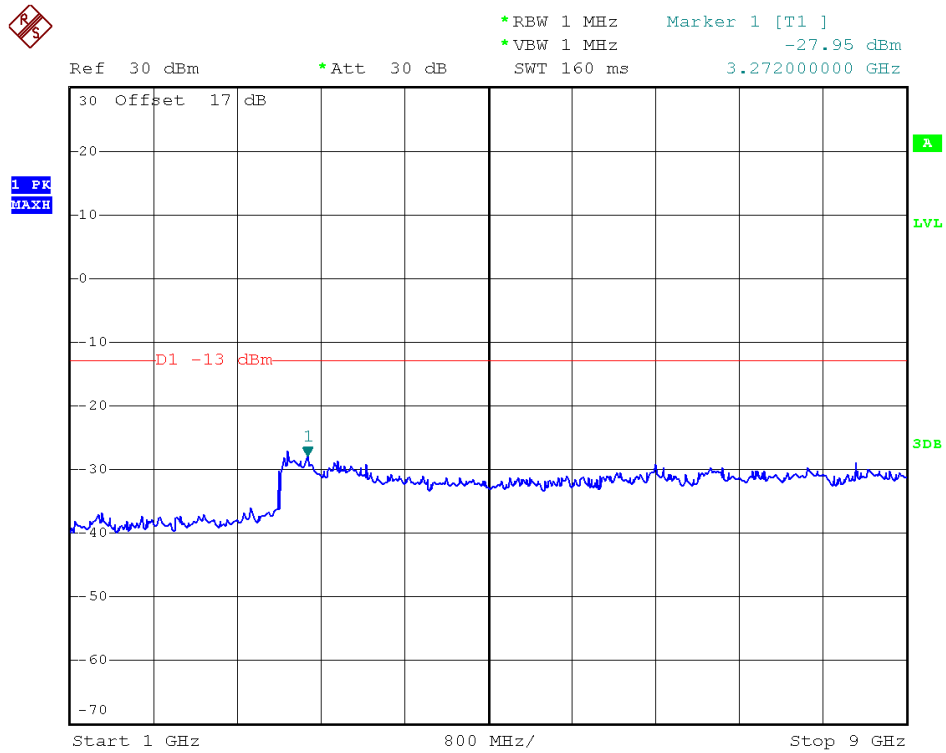

(Plot E2.1: WCDMA850MHz Channel = 4183, 1GHz to 9GHz)

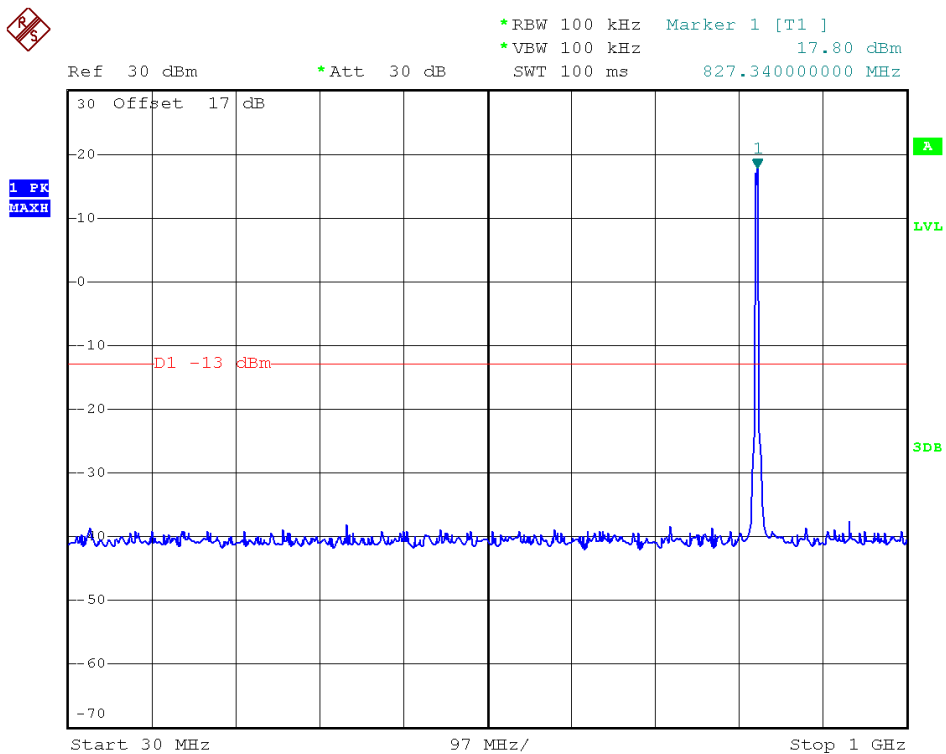

(Plot E3: WCDMA850MHz Channel = 4233, 30MHz to 1GHz)

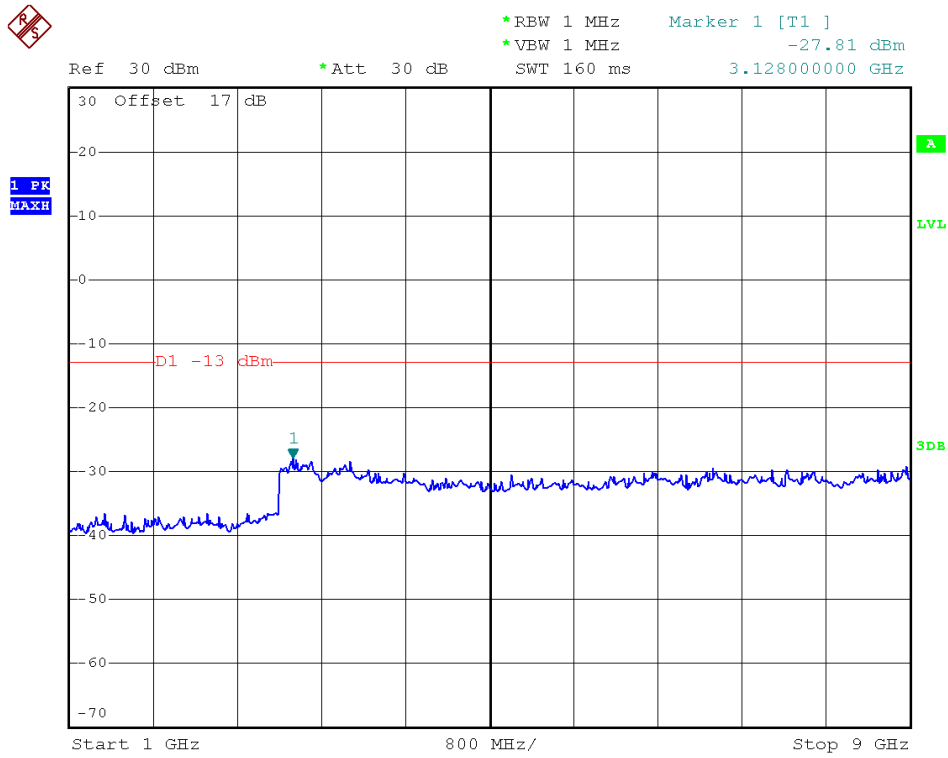

(Plot E3.1: WCDMA850MHz Channel = 4233, 1GHz to 9GHz)



2.6 Band Edge

2.6.1 Requirement

According to FCC section 22.917(b) and FCC section 24.238(b), in the 1MHz bands immediately outside and adjacent to the frequency block a resolution bandwidth of at least one percent of the emission bandwidth (26dB emission bandwidth) of the fundamental emission of the transmitter may be employed.

2.6.2 Test Description

See section 2.1.2 of this report.

2.6.3 Test Procedures

1. The testing follows FCC KDB 971168 v02r02 Section 6.0.
2. The EUT was connected to the spectrum analyzer and system simulator via a power divider.
3. The RF output of EUT was connected to the spectrum analyzer by an RF cable and attenuator. The path loss was compensated to the results for each measurement.
4. The band edges of low and high channels for the highest RF powers were measured.
5. The RF fundamental frequency should be excluded against the limit line in the operating frequency band.
6. The limit line is derived from $43 + 10\log(P)$ dB below the transmitter power P(Watts)

$$= P(W) - [43 + 10\log(P)] \text{ (dB)}$$

$$= [30 + 10\log(P)] \text{ (dBm)} - [43 + 10\log(P)] \text{ (dB)}$$

$$= -13\text{dBm}.$$

2.6.4 Test Result

The lowest and highest channels are tested to verify the band edge emissions.

1. Test Verdict:

Band	Channel	Frequency (MHz)	Measured Max. Band Edge Emission (dBm)	Refer to Plot	Limit (dBm)	Verdict
GSM 850MHz	128	824.2	-15.02	Plat A	-13	PASS
	251	848.8	-15.44	Plot B		PASS
GSM 1900MHz	512	1850.2	-14.85	Plat C	-13	PASS
	810	1909.8	-15.64	Plot D		PASS
EDGE 850MHz	128	824.2	-14.96	Plat E	-13	PASS
	251	848.8	-15.29	Plot F		PASS
EDGE 1900MHz	512	1850.2	-13.96	Plat G	-13	PASS
	810	1909.8	-16.43	Plot H		PASS
WCDMA 850MHz	4132	826.4	-14.47	Plot I	-13	PASS
	4233	846.6	-15.18	Plot J		PASS



2. Test Plots:

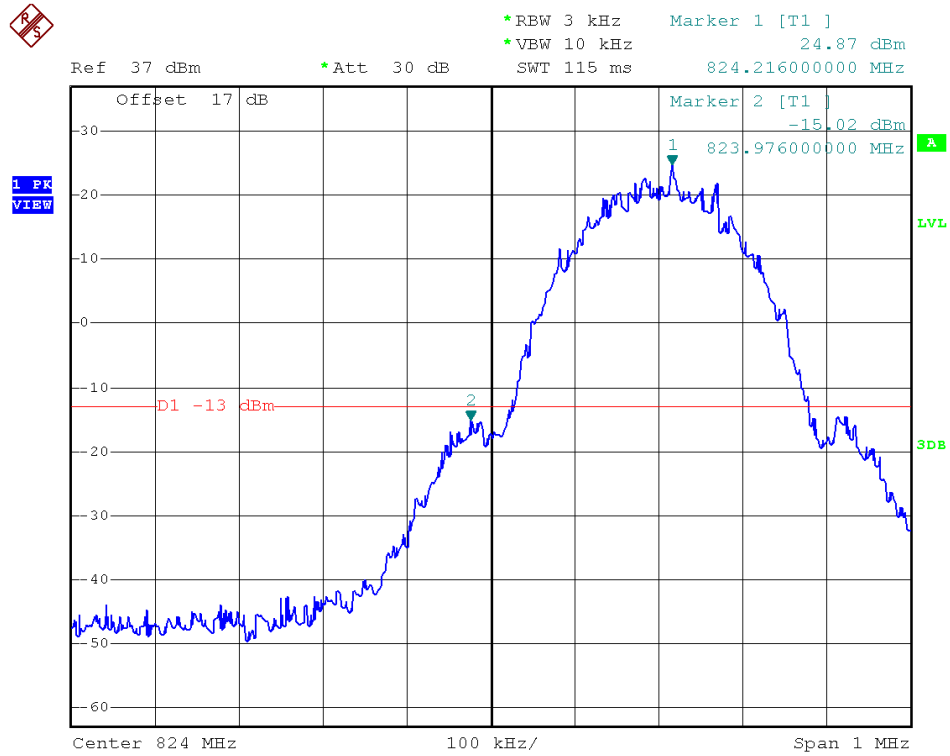

(Plot A: GSM 850 Channel = 128)

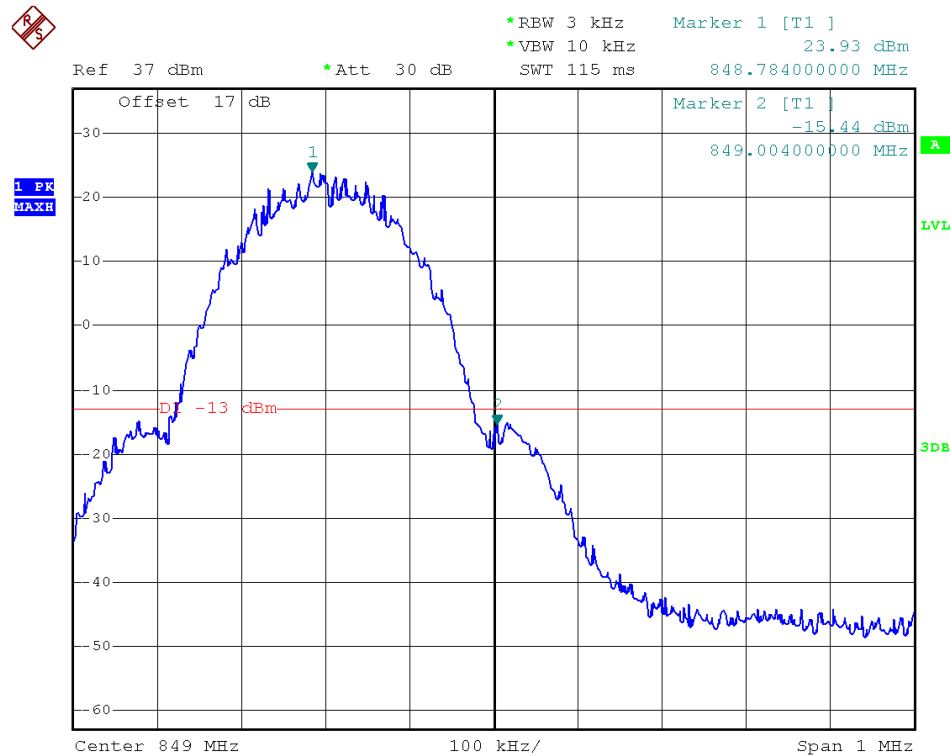

(Plot B: GSM 850 Channel = 251)

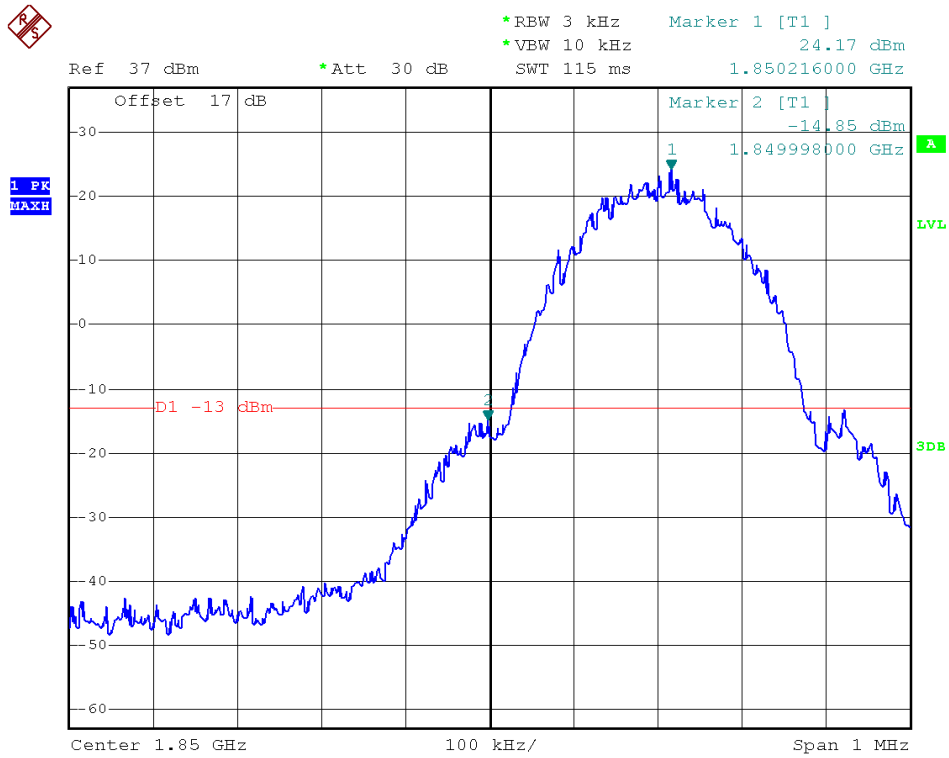

(Plot C: GSM 1900 Channel = 512)

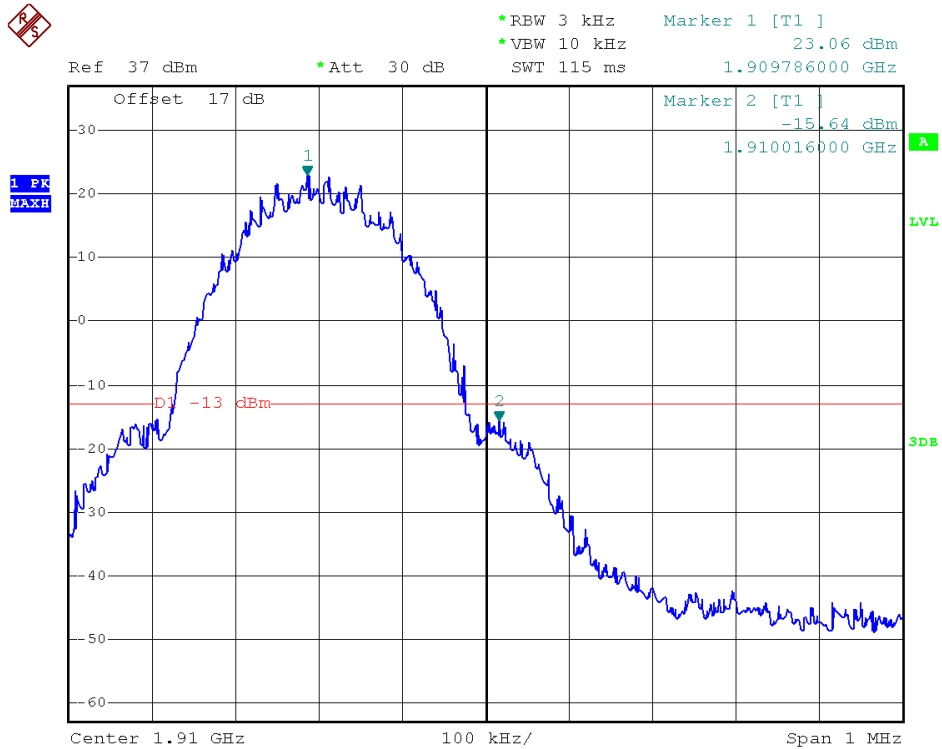

(Plot D: GSM 1900 Channel = 810)

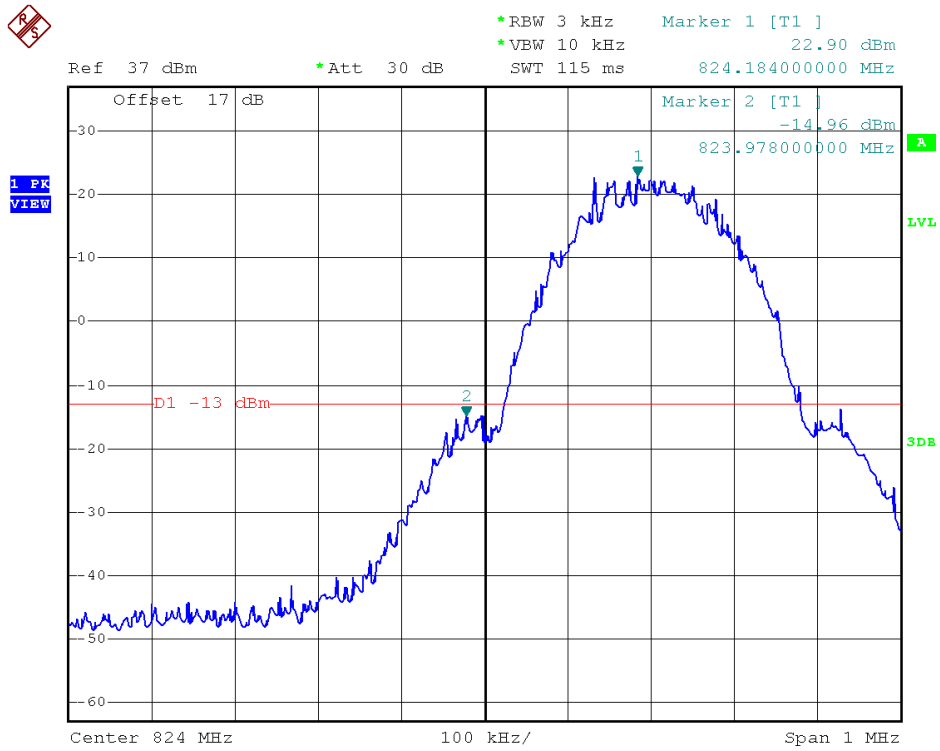

(Plot E: EDGE 850 Channel = 128)

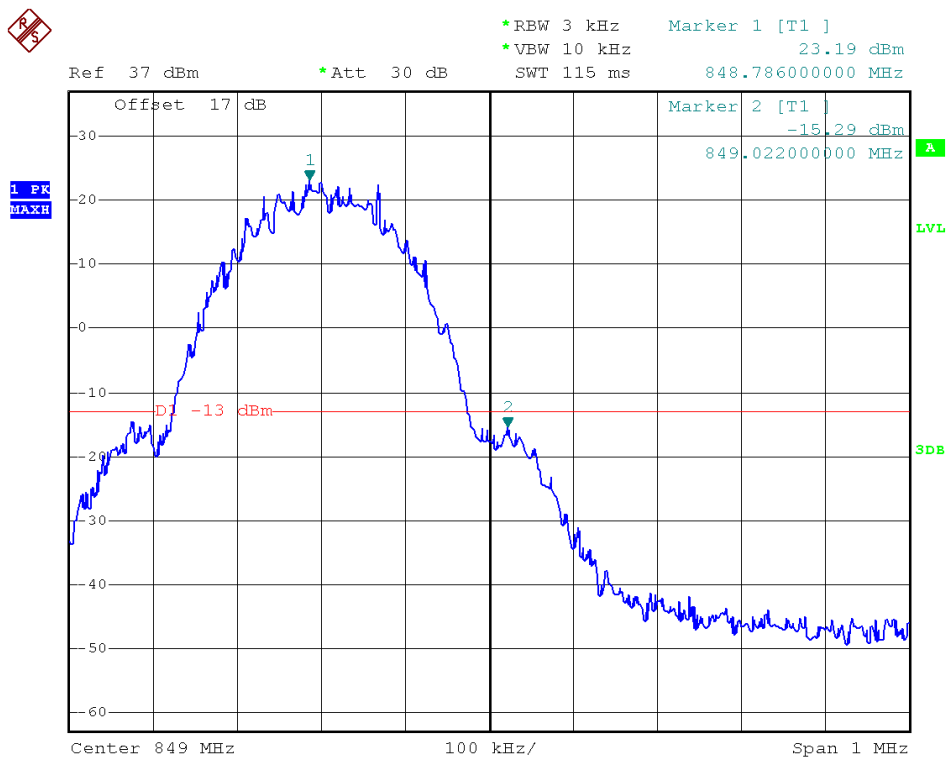

(Plot F: EDGE 850 Channel = 251)

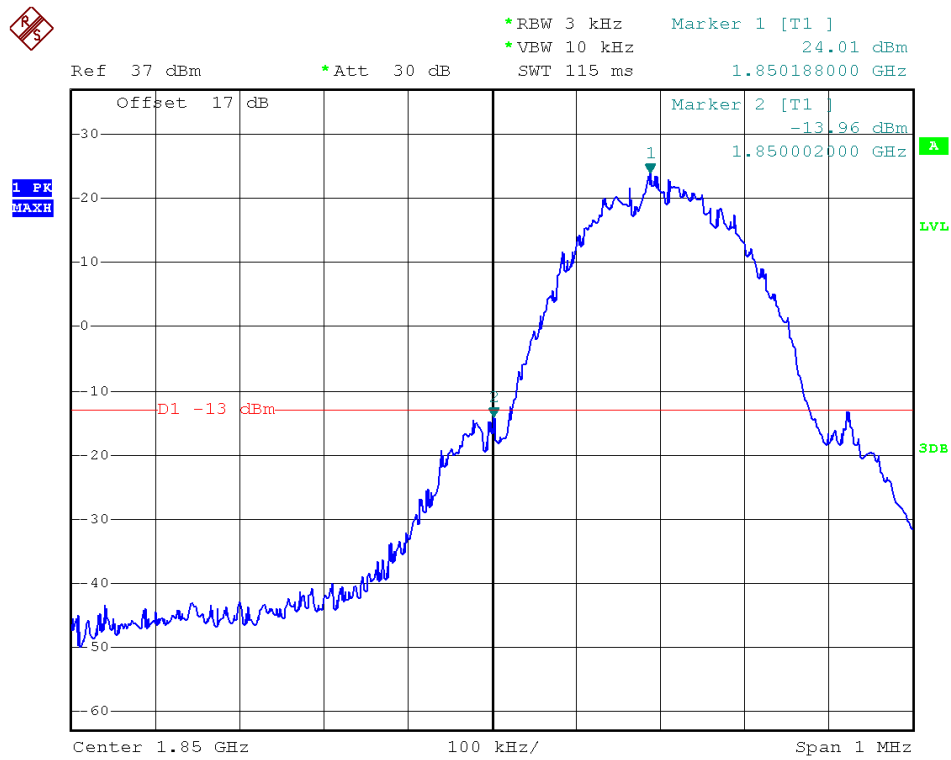

(Plot G: EDGE 1900 Channel = 512)

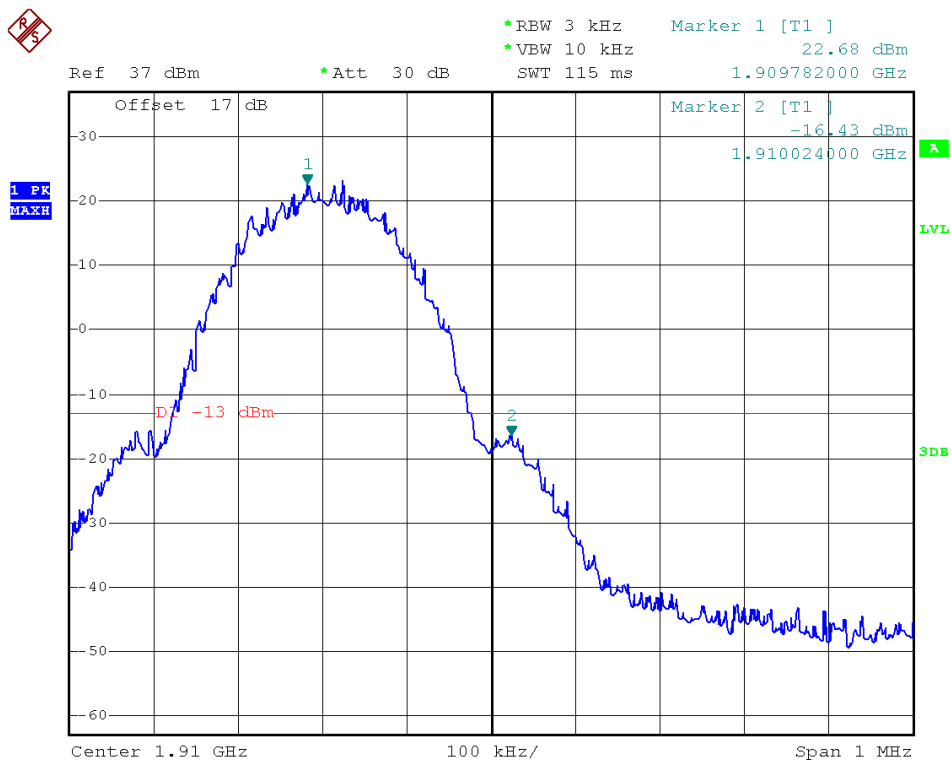

(Plot H: EDGE 1900 Channel = 810)

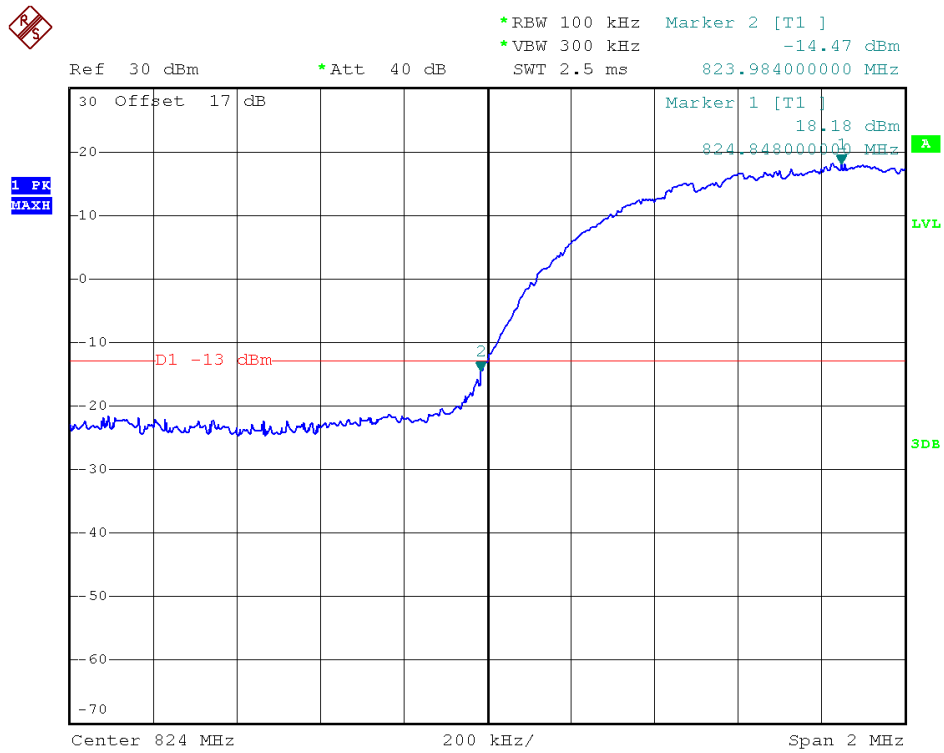

(Plot I: WCDMA 850 Channel = 4132)

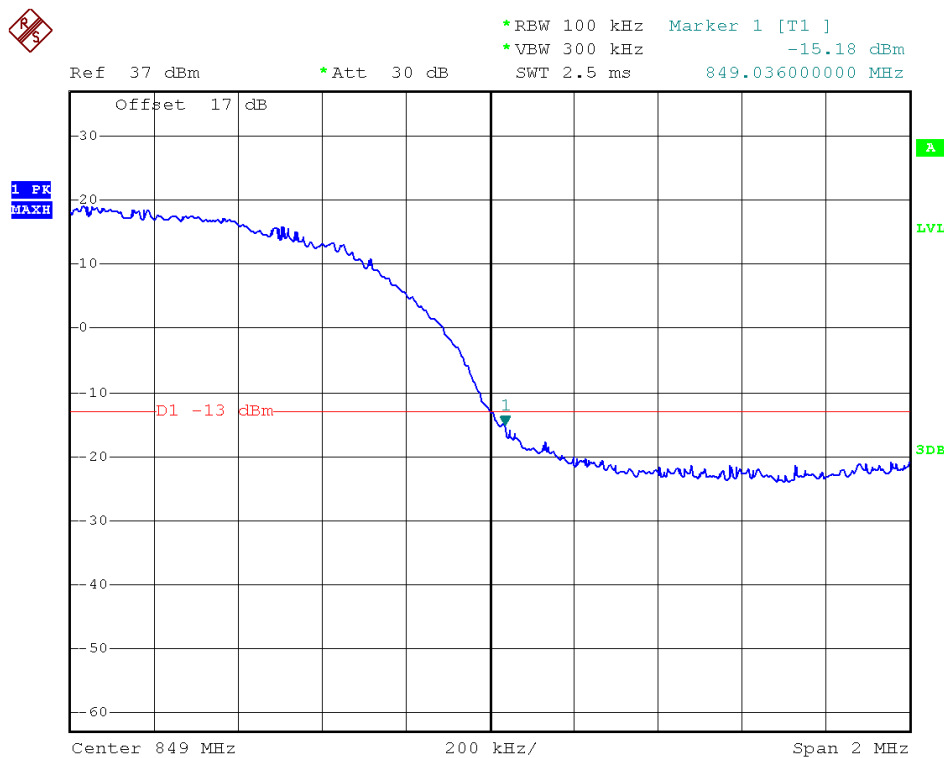

(Plot J: WCDMA 850 Channel = 4233)

2.7 Transmitter Radiated Power (EIRP/ERP)

2.7.1 Requirement

The substitution method, in ANSI / TIA / EIA-603-C-2004, was used for ERP/EIRP measurement, and the spectrum analyzer configuration follows KDB 971168 D01 Power Meas. License Digital Systems v02r02. The ERP of mobile transmitters must not exceed 7 Watts (Cellular Band) and the EIRP of mobile transmitters are limited to 2 Watts (PCS Band) and 1 Watts (AWS Band).

2.7.2 Test Description

1. Test Setup:

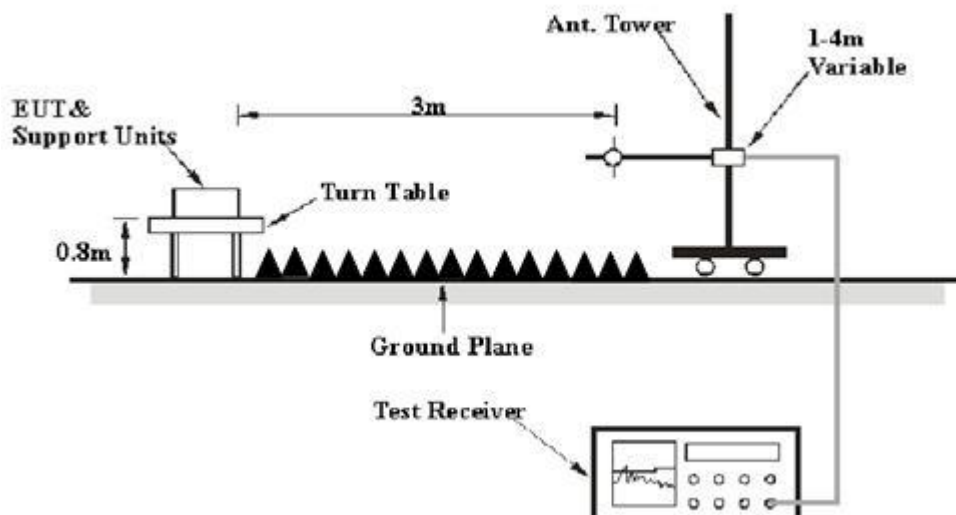

The EUT, which is powered by the DC 3.8V Power Supply directly, is located in a 3m Full-Anechoic Chamber; the cable loss, air loss and so on of the site as factors are pre-calibrated using the "Substitution" method, and calculated to correct the reading.

A call is established between the EUT and the SS via a Common Antenna. The EUT is commanded by the SS to operate at the maximum and minimum output power, and only the test result of the maximum output power was recorded.

2. Equipments List:

Description	Manufacturer	Model	Serial No.	Cal. Date	Cal. Due Date
Spectrum Analyzer	R&S	FSP40	1164.4391.40	2014.07.07	2015.07.06
EMI Test Receiver	R&S	ESIB26	100130	2014.07.07	2015.07.06
Full-Anechoic Chamber	Albatross~ Projects	12.8m*6.8m *6.4m	A0412372	2015.01.05	2016.01.04



Description	Manufacturer	Model	Serial No.	Cal. Date	Cal. Due Date
Double ridge horn antenna	R&S	HF906	A0304225	2014.06.11	2015.06.10
Ultra-wideband antenna	R&S	HL562	A0304224	2014.06.11	2015.06.10
Loop antenna	R&S	HFH2-Z2	A0304226	2014.06.11	2015.06.10
Cable	SUNHNER	SUCOFLEX 100	/	2014.06.05	2015.06.04
Cable	SUNHNER	SUCOFLEX 104	/	2014.06.05	2015.06.04

2.7.3 Test Procedures

- The testing follows FCC KDB 971168 v02r02 Section 5.2.1. (for CDMA/WCDMA), Section 5.2.2.2 (for GSM/GPRS/EDGE) and ANSI / TIA-603-C-2004 Section 2.2.17.
- The EUT was placed on a turntable 1.5 meters high in a fully anechoic chamber.
- The EUT was placed 3 meters from the receiving antenna, which was mounted on the antenna tower.
- GSM operating modes: Set RBW= 1MHz, VBW= 3MHz, RMS detector over burst;
UMTS operating modes: Set RBW= 100 kHz, VBW= 300 kHz, RMS detector over frame, and use channel power option with bandwidth=5MHz, per KDB 971168 D01.
- The table was rotated 360 degrees to determine the position of the highest radiated power.
- The height of the receiving antenna is adjusted to look for the maximum ERP/EIRP.
- Taking the record of maximum ERP/EIRP.
- A dipole antenna was substituted in place of the EUT and was driven by a signal generator.
- The conducted power at the terminal of the dipole antenna is measured.
- Repeat step 3 to step 5 to get the maximum ERP/EIRP of the substitution antenna.
- $ERP/EIRP = P_s + E_t - E_s + G_s = P_s + R_t - R_s + G_s$
 P_s (dBm): Input power to substitution antenna.
 G_s (dBi or dBd): Substitution antenna Gain.
 $E_t = R_t + AF$ $E_s = R_s + AF$
 AF (dB/m): Receive antenna factor
 R_t : The highest received signal in spectrum analyzer for EUT.



Rs: The highest received signal in spectrum analyzer for substitution antenna.

2.7.4 Test Result

Test Notes:

1. This device employs GMSK technology with GSM and GPRS capabilities. All configurations were investigated and the worst case emissions were found in GSM mode.
2. This device employs UMTS technology with WCDMA (AMR/RMC), HSDPA, HSUPA and HSPA+ capabilities. All configurations were investigated and the worst case UMTS emissions were found in RMC WCDMA mode at 12.2Kbps.
3. This unit was tested with its standard battery.
4. The worst case test configuration was found in the vertical positioning where the EUT is laying on its side. The data reported in the tables below were measured in this test setup.

Band	Channel	Frequency (MHz)	PCL	Antenna Pol (H/V)	Measured ERP dBm	Limit dBm	Verdict
GSM 850MHz	128	824.20	5	V	33.24	38.5	PASS
				H	33.25		
	190	836.60	5	V	33.35		PASS
				H	33.27		
	251	848.80	5	V	33.37		PASS
				H	33.39		

Band	Channel	Frequency (MHz)	PCL	Antenna Pol (H/V)	Measured EIRP dBm	Limit dBm	Verdict
GSM 1900MHz	512	1850.2	0	V	30.22	33	PASS
				H	30.32		
	661	1880.0	0	V	30.31		PASS
				H	30.35		
	810	1909.8	0	V	30.33		PASS
				H	30.29		



Band	Channel	Frequency (MHz)	PCL	Antenna Pol (H/V)	Measured ERP dBm	Limit dBm	Verdict
EDGE 850MHz	128	824.20	5	V	32.31	38.5	PASS
				H	32.37		
	190	836.60	5	V	32.45		PASS
				H	32.51		
	251	848.80	5	V	32.43		PASS
				H	32.40		

Band	Channel	Frequency (MHz)	PCL	Antenna Pol (H/V)	Measured EIRP dBm	Limit dBm	Verdict
EDGE 1900MHz	512	1850.2	0	V	30.23	33	PASS
				H	30.25		
	661	1880.0	0	V	30.19		PASS
				H	30.16		
	810	1909.8	0	V	30.12		PASS
				H	30.20		

Band	Channel	Frequency (MHz)	Antenna Pol (H/V)	Measured ERP dBm	Limit dBm	Verdict
WCDMA 850MHz	4132	826.4	V	25.63	38.5	PASS
			H	25.52		
	4175	835	V	25.67		PASS
			H	25.54		
	4233	846.6	V	25.64		PASS
			H	25.61		



2.8 Radiated Out of Band Emissions

2.8.1 Requirement

According to FCC section 22.917(a) and section 24.238(a), the power of any emission outside of the authorized operating frequency ranges must be attenuated below the transmitting power (P) by a factor of at least $43+10*\log(P)$ dB. This calculated to be -13dBm.

2.8.2 Test Description

See section 0 of this report.

Equipment List:

Description	Manufacturer	Model	Serial No.	Cal. Date	Cal.Due Date
System Simulator	R&S	CMW500	149333	2014.07.21	2015.07.20
EMI Test Receiver	R&S	ESIB26	100130	2014.07.07	2015.07.06
Full-Anechoic Chamber	Albatross~ Projects	12.8m*6.8m *6.4m	A0412372	2015.01.05	2016.01.04
Double ridge horn antenna(1GHz~18G Hz)	R&S	HF906	100150	2014.06.11	2015.06.10
Broadband antenna (30MHz~1GHz)	R&S	HL562	101341	2014.06.11	2015.06.10
Horn antenna (18GHz~26.5GHz)	R&S	HM118	101286	2014.06.11	2015.06.10
Cable	SUNHNER	SUCOFLEX 100	/	2014.06.05	2015.06.04
Cable	SUNHNER	SUCOFLEX 104	/	2014.06.05	2015.06.04

Note: when doing measurements above 1GHz, the EUT has been within the 3dB cone width of the horn antenna during horizontal antenna.

2.8.3 Test Result

Test Notes:

1. This device employs GMSK technology with GSM and GPRS capabilities. All configurations were investigated and the worst case emissions were found in GSM mode.
2. This device employs UMTS technology with WCDMA (AMR/RMC), HSDPA, HSUPA



capabilities. All configurations were investigated and the worst case UMTS emissions were found in RMC WCDMA mode at 12.2Kbps.

3. This unit was tested with its standard battery.

4. The worst case test configuration was found in the vertical positioning where the EUT is laying on its side. The data reported in the tables below were measured in this test setup.

5. The spectrum is measured from 30MHz to the 10th harmonic of the fundamental frequency of the transmitter using CISPR quasi peak detector below 1GHz. The worst case emissions are reported however emissions whose levels were not within 20dB of the respective limits were not reported.

6. Emissions below 18GHz were measured at a 3 meter test distance while emissions above 18GHz were measured at a 1 meter test distance with the application of a distance correction factor.

1. Test Verdict:

Band	Channel	Frequency (MHz)	Measured Max. Spurious Emission (dBm)		Limit (dBm)	Verdict
			Test Antenna Horizontal	Test Antenna Vertical		
GSM 850MHz	128	824.2	< -25	< -25	-13	PASS
	190	836.6	< -25	< -25		PASS
	251	848.8	< -25	< -25		PASS
GSM 1900MHz	512	1850.2	< -25	< -25	-13	PASS
	661	1880.0	< -25	< -25		PASS
	810	1909.8	< -25	< -25		PASS
EDGE 850MHz	128	824.2	< -25	< -25	-13	PASS
	190	836.6	< -25	< -25		PASS
	251	848.8	< -25	< -25		PASS
EDGE 1900MHz	512	1850.2	< -25	< -25	-13	PASS
	661	1880.0	< -25	< -25		PASS
	810	1909.8	< -25	< -25		PASS
WCDMA 850MHz	4132	826.4	< -25	< -25	-13	PASS
	4183	836.6	< -25	< -25		PASS
	4233	846.6	< -25	< -25		PASS

2. Test Plots for the Whole Measurement Frequency Range:

Note1: the power of the EUT transmitting frequency should be ignored.

Note2: All Spurious Emission tests were performed in X, Y, Z axis direction and low, middle, high channel. And only the worst axis test condition was recorded in this test report.

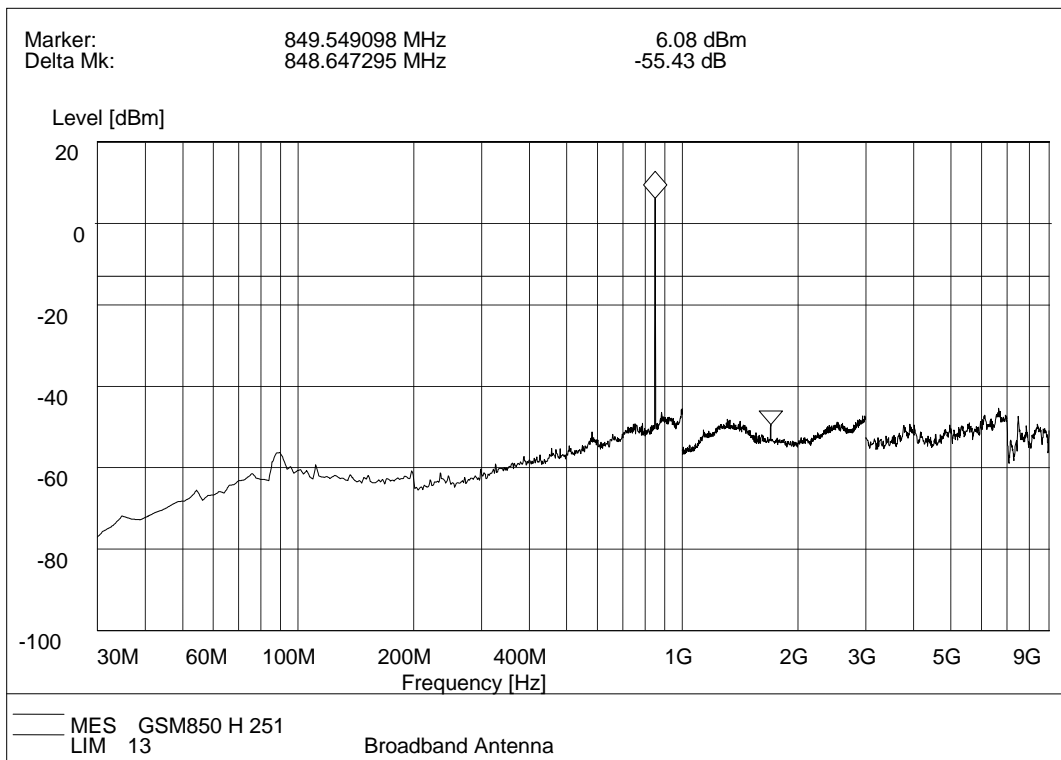

GSM 850MHz , Test Antenna Horizontal

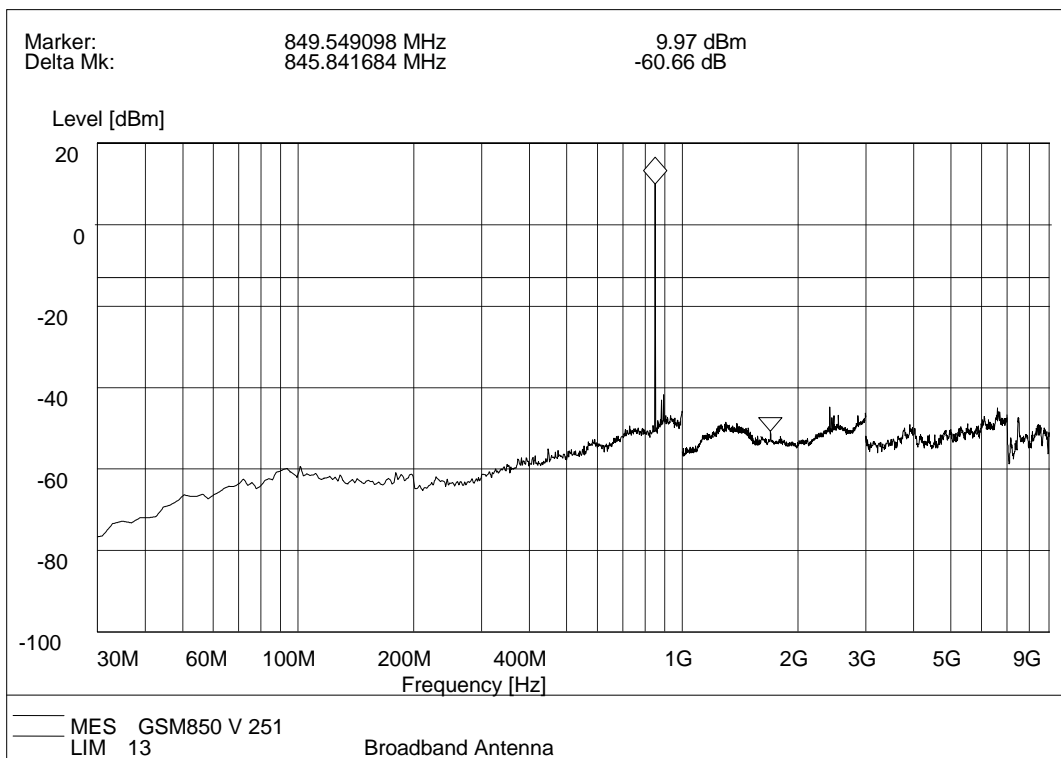

GSM 850MHz , Test Antenna Vertical

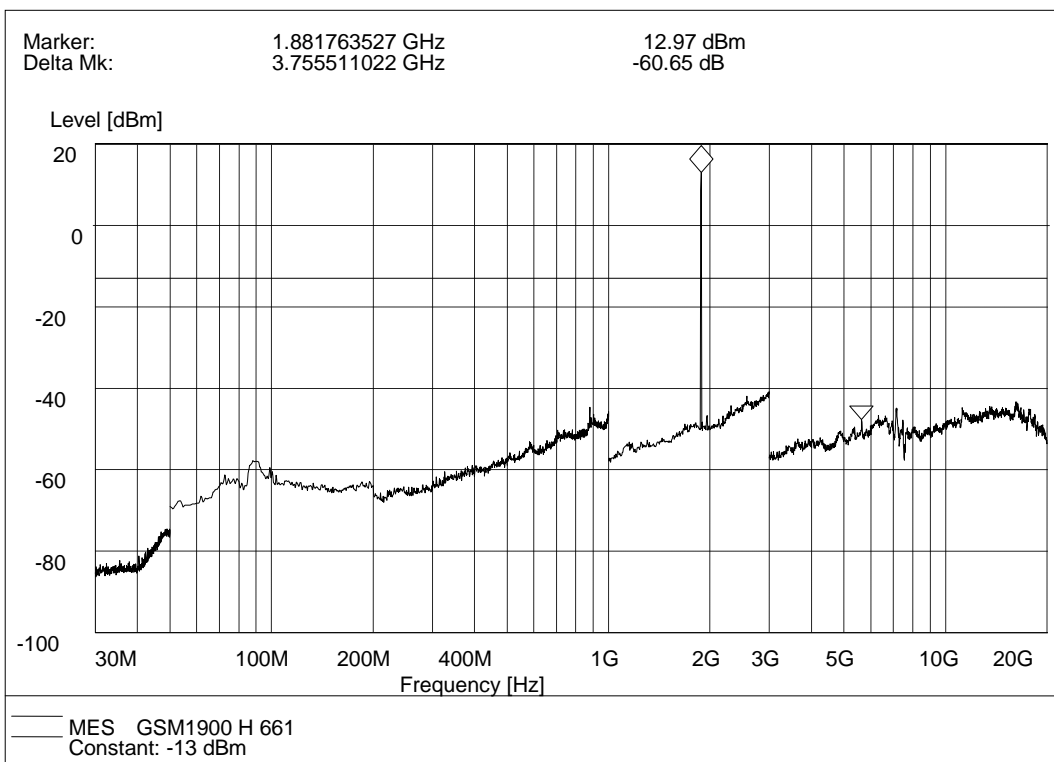

GSM 1900MHz , Test Antenna Horizontal

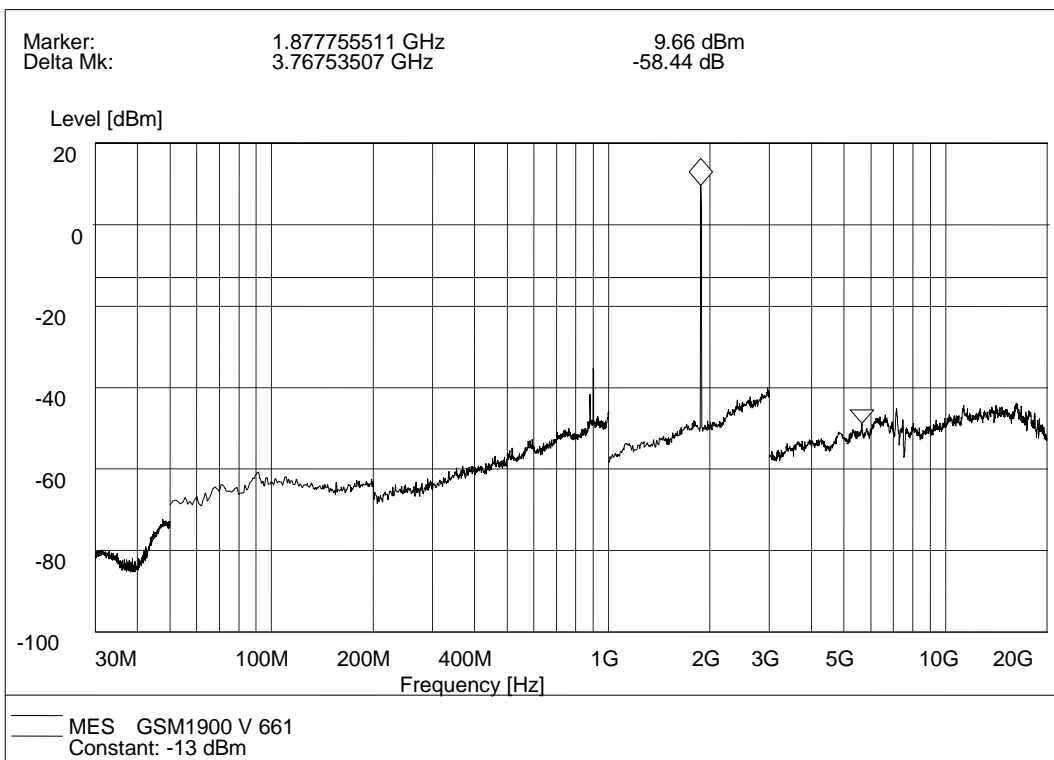

GSM 1900MHz , Test Antenna Vertical

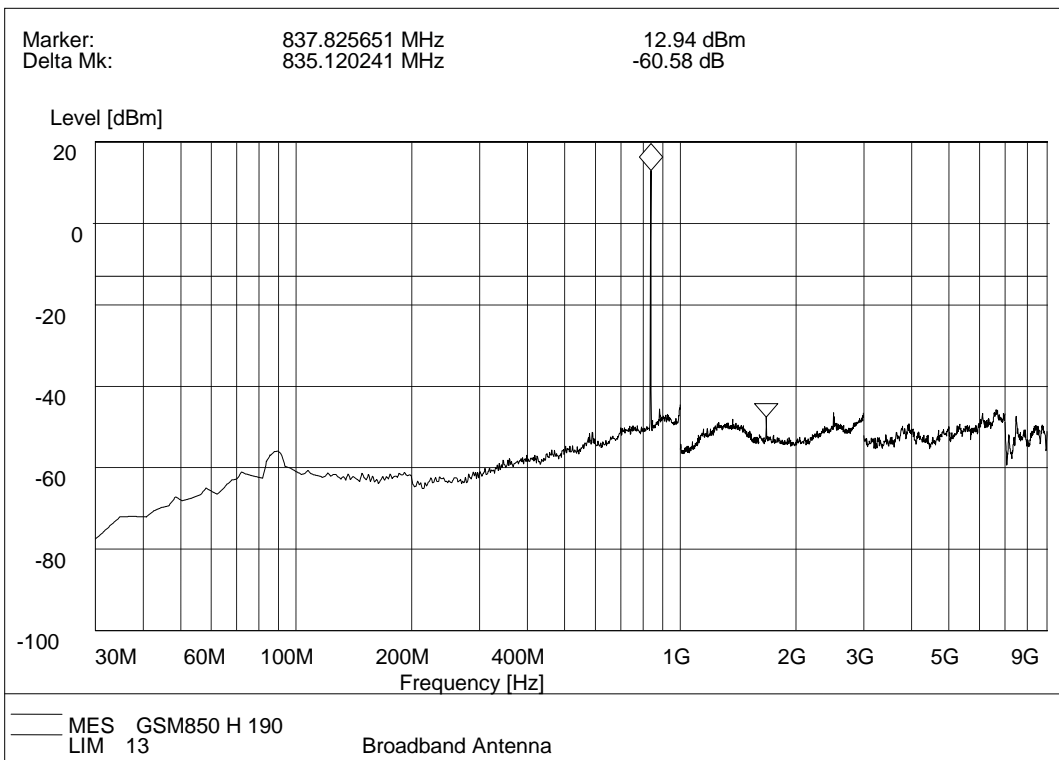

EDGE 850MHz , Test Antenna Horizontal

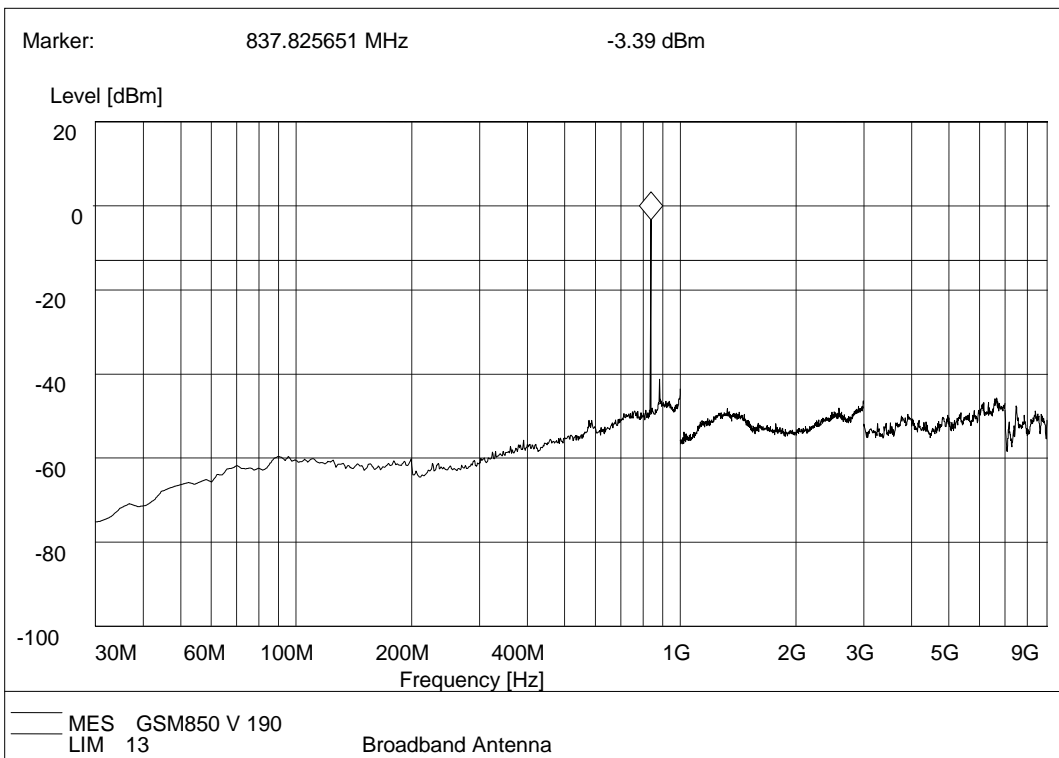

EDGE 850MHz, Test Antenna Vertical

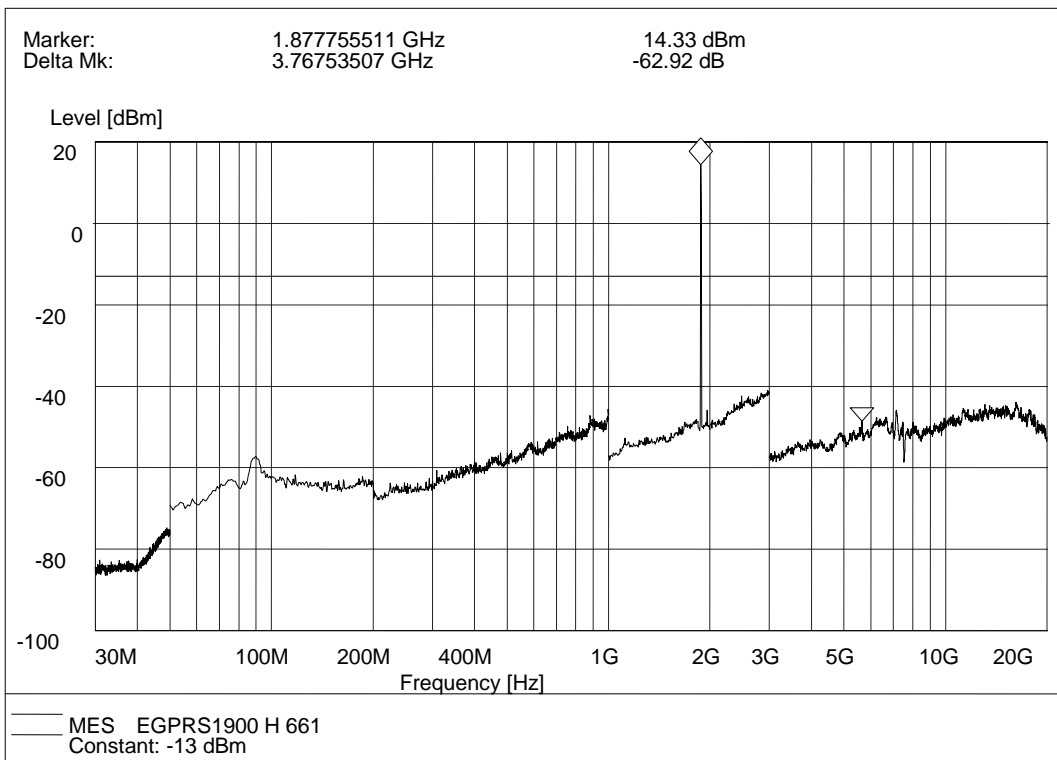

EDGE 1900MHz, Test Antenna Horizontal

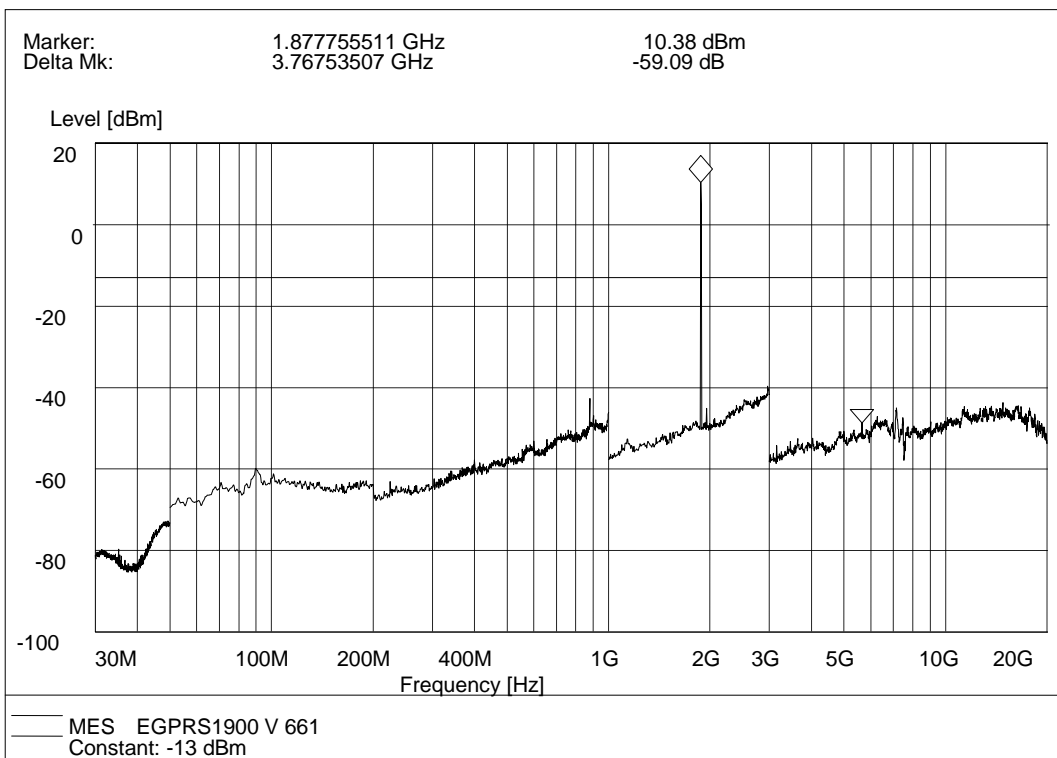

EDGE 1900MHz, Test Antenna Vertical

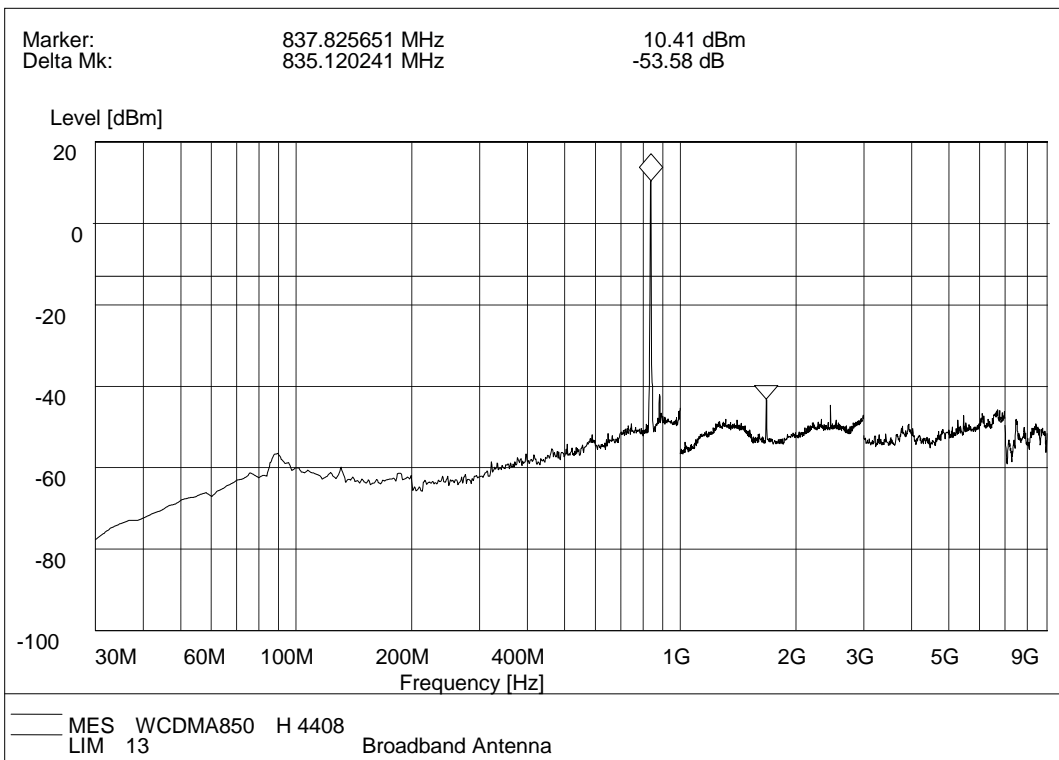

WCDMA 850MHz , Test Antenna Horizontal

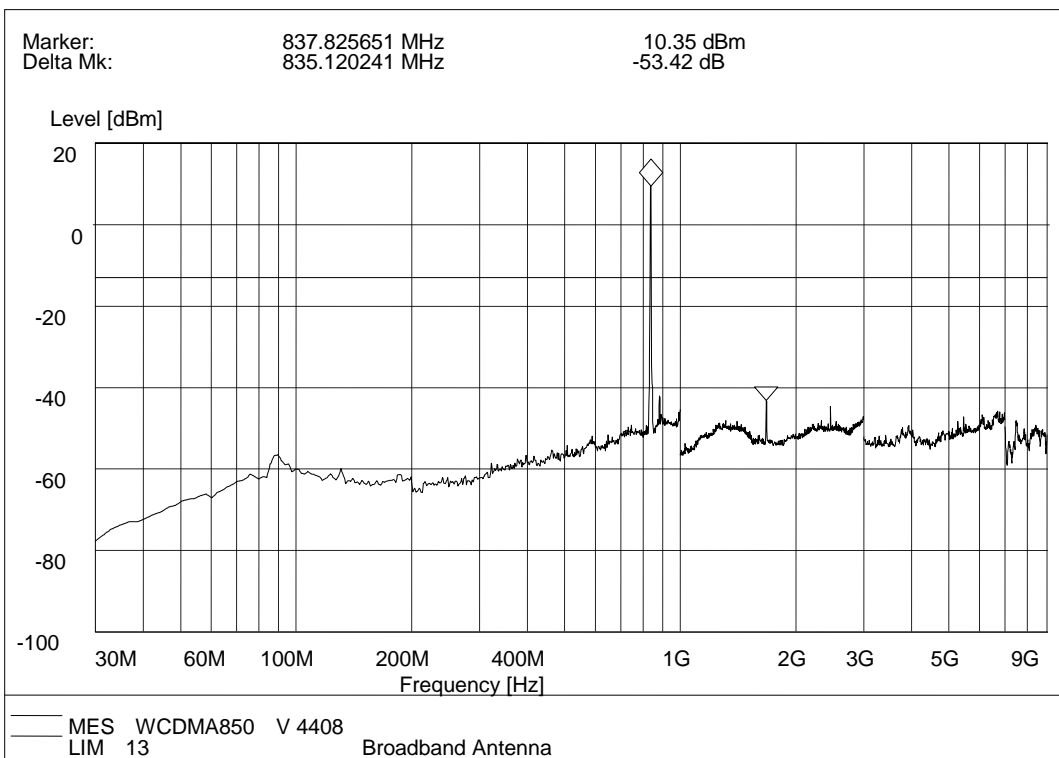

WCDMA 850MHz, Test Antenna Vertical

** END OF REPORT **