



VISICO mobile website



VISICO Facebook

VC-818 E-TTL High-speed Wireless Radio Trigger



User Guide

YUYAO VISTAR ELECTRONIC SCIENCE & TECHNOLOGY CO., Ltd

ADD : No.206 BEIXING ROAD OF WEST CITY INDUSTRIAL DEVELOPMENT ZONE,

YUYAO CITY, ZHEJIANG, CHINA 315450

TEL : 0086-574-62803099 FAX : 0086-574-62803111

EMAIL : info@vistarfoto.com WEB:www.visico.com

FCC ID:2AC48-VC-818TX

Description	Page
Introduction-----	1
Safety Note-----	2
Name of Parts-----	2-3
VC-818TX Radio Transmitter-----	2
VC-818RX Radio Receiver-----	3
VC-818TX Radio Transmitter LCD screen-----	4-5
GR Group Flash-----	4
TTL Auto Flash-----	5
Multi Stroboscopic Flash-----	5
Button Operation-----	6
Install Battery-----	7
How to Use Radio Trigger-----	8-9
Mount on Camera-----	10
Power Switch-----	10
LCD Illumination-----	10
Save Parameters-----	10
Wireless Control-----	11
Set Channel, ID and Group-----	12
Set Channel, ID and Group of Radio Transmitter-----	11
Set Channel, ID and Group of Radio Receiver-----	12
Switch Operation Mode Gr, ETTL, Multi-----	13
Gr Mode: Shoot with a Different Flash Mode for Each Group-----	13-15
Set Shutter Speed in Gr Mode-----	16
ETTL Mode: Flash Ratio Operation-----	17-19
Set High-speed Sync in ETTL Mode-----	20
Multi Mode: Stroboscopic Operation-----	21-22
Operating Modeling Lamp-----	23
Test-----	24
Transmitter Control from Camera' s Menu Screen-----	24-29
Gr Mode Control from Camera-----	25-27
ETTL Mode Control from Camera-----	27-28
Multi Mode control from Camera-----	29
VC-818TX specification-----	30
Features-----	31

Introduction

Thank you very much for selecting VC-818TX ETTL High-speed Wireless Radio Trigger. Please read this instruction carefully and keep them handy for your reference.

VC-818 ETTL radio trigger (for Canon) is engineered to work with Canon ETTL system, and applies to Canon EOS camera. You can use VC-818TX transmitter on camera to trigger remote VISICO5 studio flash or other brand' s E-TTL speedlites and studio flashes attached to VC-818RX receivers.

Whether you are a photographer or amateur, VC-818 multiple independent control, simple operation, and reliable wireless from TTL trigger system provides an unparalleled experience of convenient for the studio and location shooting, greatly improves shooting efficiency. It is perfect tool for shooting portraits, weddings and sports, allowing you to get perfect shot anytime and anyplace.

! Safety Note

Do not use the unit in an environment where moisture or flammable vapor is likely to come in contact with the unit. Failure to observe this precaution could result in fire or electric shock.

Do not explore any components in direct sun for a long time or in other areas subject to high temperature. Failure to observe this precaution could result in fire or electric shock.

Do not attempt to disassemble or service the unit on your own to avoid shock hazard.

Always keep out of reach of children. Consult a physician immediately if a child swallows any part of this device.

1/Name of Parts

VC-818TX Radio Transmitter

- ① -POWER:ON/OFF
- ② -TEST:Test flash button
- ③ -GROUP:Select group
- ④ -MODE : Select mode
- ⑤ -SYNC/CH: Select Sync mode/Channel
- ⑥ -MODEL/AF:Set Modeling lamp/ Turn ON or OFF AF-Assist beam
- ⑦ -Select Dial : adjust parameter
- ⑧ -Ok button : save parameter
- ⑨ -Radio transmission confirmation lamp
- ⑩ -LCD screen
- ⑪ -AF-Assist beam



2

- ⑫ -Battery compartment
- ⑬ -Locking screw
- ⑭ -Hot shoe camera connection



VC-818RX Radio Receiver

- 1 -Mini USB port
- 2 -3.5mm sync jack
- 3 -Hot shoe speedlite connection
- 4 -Select channel
- 5 -Select group
- 6 -Channel LED indicator
- 7 -Group LED indicator



3

2/ VC-818TX Radio Transmitter LCD screen

Gr:Group Flash

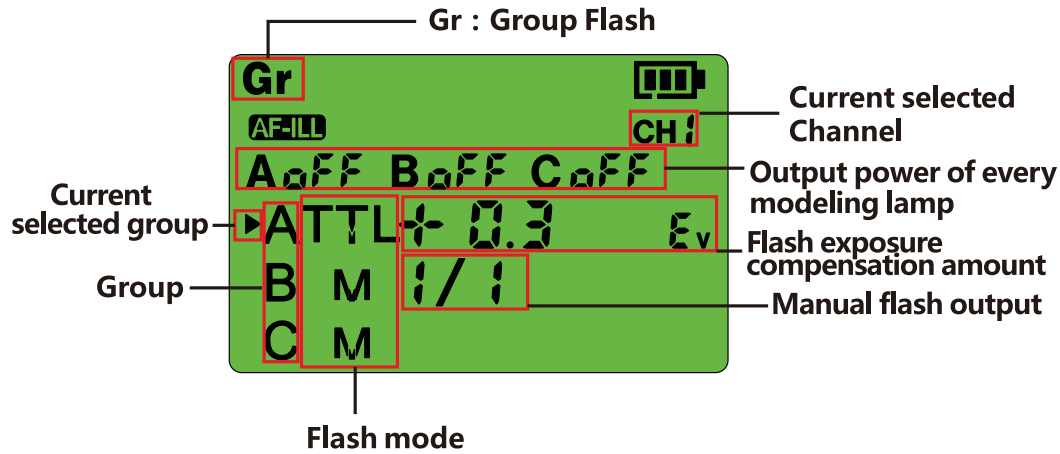

- !** Note: 1. The LCD screen only shows settings of present application.
 2. When press button or rotate dial, the LCD screen illuminates.

ETTL Auto Flash

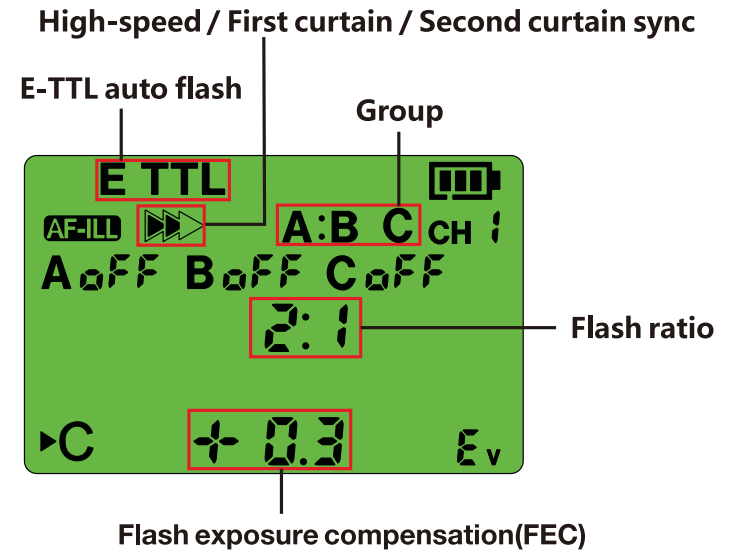

Multi Stroboscopic Flash

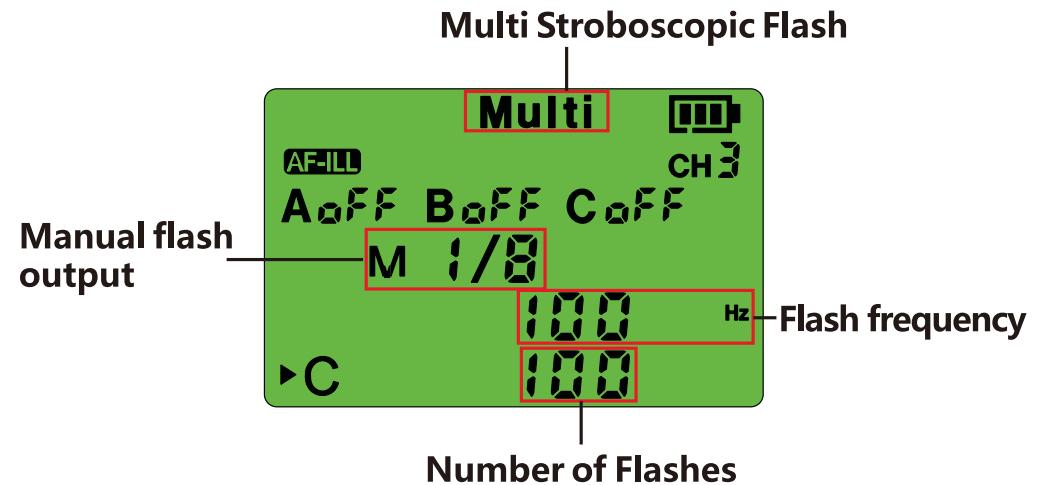

3/ Button Operation

Button	Operation	Function
GROUP	Short press	Select A/B/C group in sequence
MODE	Long press 3s	Gr/ETTL/MULIT
	Short press (Under Gr mode)	Select flash mode for each group in sequence 1. M 1/X: set output power of TTL flash 2. M: Set output power of VISICO manual flash (without TTL feature) 3. TTL Mode; 4. Turn off the group
	Short press (Under ETTL mode)	Select flash ratio mode in sequence 1.A:B 2.A:B C 3.All(no signal on screen)
	Short press (Under Multi mode)	Select flash output / frequency / number of flashes in sequence
SYNC/CH	Short press (Under Gr mode)	Select three flash sync mode in sequence 1.First curtain sync (no signal) 2.Second curtain sync 3.High-speed sync
	Short press (Under ETTL mode)	Turn ON/OFF high-speed sync
	Long press	Set up channel
MODEL/AF	Short press	Set output power of modeling lamp of A/B/C group
	Long press	Turn on/off AF-Assist beam
POWER	Switch to right side	Switch on power
	Switch to left side	Switch off power
TEST	Short press	Test flash
Dial	Rotate the dial	Set parameter

4/ Install Battery

Move battery cover backward, open battery compartment. According to positive and negative indicator on the battery compartment, install two AA batteries (Optional) or two 1.2V charging battery (Optional).

! Caution: If out of service in long period, please take out battery. When battery is in low level, replace two batteries together will prevent from missing fire or no fire.



VC-818TX radio transmitter



VC-818RX radio receiver

5/ How to Use Radio Trigger

1. Wireless trigger studio flash (Fig 1)

1-1 When camera is off, mount the transmitter VC-818TX on camera hotshoe, turn on the camera and transmitter.

1-2 Connect receiver VC-818RX to studio flash by sync cord.

1-3 Set transmitter and receiver to the same channel.

1-4 Press camera shutter button, and the studio flash will be triggered simultaneously.

Note: VISICO brand VCHHLR, VCHH, VE PLUS, VL PLUS, VISICO4, VISICO5 and VL PLUS AC/DC studio flash includes build-in radio receiver. They are compatible with VC-818TX radio transmitter. There is no need to use VC-818RX receiver for these units.



Fig1

2. Trigger hot shoe speedlite (Fig 2)

2-1 When camera is off, mount the transmitter VC-818TX on camera hotshoe, turn on the camera and transmitter.

2-2 Mount hot shoe speedlite on receiver VC-818RX.

2-3 Set transmitter and receiver to the same channel.

2-4 Press camera shutter button, and the camera flash will be triggered simultaneously.

Note: VISICO hot shoe speedlite includes build-in radio receiver. It is compatible with VC-818TX radio transmitter. There is no need to use VC-818RX receiver for these units.

3. Work as a wired shutter release

3-1 When camera is off, connect one terminal of remote cable to the camera, and another terminal of remote cable to the transmitter VC-818TX

3-2 Press TEST button to shoot.



Fig2

6/Mount on camera

Slip the transmitter's mounting foot fully into the camera's hot shoe. Rotate locking ring clockwise, to attach transmitter on camera firmly. Rotate locking ring anticlockwise, to detach the transmitter.



7/Power switch

Switch [POWER] button to right side. The power is ON and the LCD screen illuminates.

Caution: If out of service in long period, please switch off, to prevent power consumption.

8/LCD illumination

Backlight of LCD screen illuminates when press button or rotate dial. Backlight of LCD screen goes out 10 seconds after setting.

9/Save Parameters

1. After select parameter, let it stand 10 seconds, the parameter will be saved.
2. After select parameter, press [OK] button, the parameter will be saved.
3. After select parameter, turn off the power switch, the parameter will be saved.

10/Wireless Control

The radio transmitter attached on camera (Master) can directly adjust flashes (slave) that is wirelessly controlled. Parameters set on radio transmitter will be synchronously reflected on flash that is wirelessly controlled.

11/Set Channel, ID and Group

VC-818TX transmitter has 8 channels and 30 ID. In the same channel, VC-818TX enables you to separately control flashes in three groups simultaneously or independently. You can have as many lights as you want in every group. This is ideal for working with multiply lighting setups. You can work with total control with remote lights, without leaving shooting place.

11-1 Set Channel, ID and Group of Radio Transmitter

Set Channel of Radio Transmitter

1. There are 8 channels on radio transmitter, selectable from CH 1- CH 8.
2. Long press [SYNC/CH] button, only CH shows on the screen. Rotate dial to set up proper channel value. Press [OK] button to save the value.

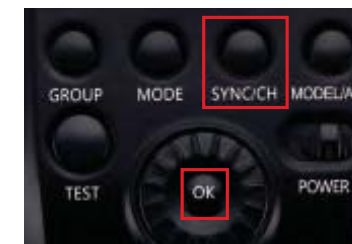

Set ID of Radio Transmitter

1. There are 30 ID on radio transmitter, selectable from 1-30.
2. Long press [SYNC/CH] button, CH shows on the screen. Then, short press [SYNC/CH], ID code shows on screen. Rotate dial to set up proper ID. Press [OK] button to save the value.

Set Group of Radio Transmitter

Press [GROUP] button to choose and set up A /B /C group in sequence.



11-2 Set Channel、ID and Group of Radio Receiver

Set Channel of Radio Receiver

Short press [CH SET] button, the channel value is selectable from CH1- CH4 in sequence. The LED light of current selected channel turns on green. When select the fourth channel, LED light of both CH1 and CH3 turns on green.

Set Group of Radio Receiver

Short press [GR SET] button to choose and set up A /B /C group in sequence. The LED light of current selected channel turns on green.

Note 1: VISICO brand VCHHLR, VCHH, VE PLUS, VL PLUS, VISICO4, VISICO5 and VL PLUS AC/DC studio flash includes build-in radio receiver. They are compatible with VC-818TX radio transmitter. There is no need to use VC-818RX receiver for these units.

If you use VC-818TX to trigger other brand of flashes, must attach VC-818RX radio receiver on the flashes.

Note 2: Only when radio transmitter and radio receiver are at the same channel, the trigger system is workable.



12

12/ Switch Operation Mode Gr, E-TTL, Multi

Long press [MODE] button 3s on radio transmitter, switch <Gr> / <E-TTL> / <Multi> modes in sequence.

13/Gr Mode: Shoot with a Different Flash Mode for Each Group

In Gr mode, you can set different flash mode for A / B / C groups. The selectable modes are <TTL> / <M 1/x> / <M> / <OFF>.

Select <Gr> mode: Long press [MODE] button 3s and set the radio transmitter to <Gr>.

Select flash group: Short press [GROUP] button, to select A or B or C group. The current selected group is pointed by a triangle mark.

Set up flash mode for selected flash group: Short press [MODE] button, <TTL> , <M 1/x> , <M> and <OFF> shows on sequence.

13

1. When use <TTL> mode, set the flash exposure compensation by rotating dial. Flash exposure compensation range is $\pm 3\text{EV}$ and variable in 1/3 EV precise increment.

Caution: Studio flash or hot shoe speedlite should support ETTL.

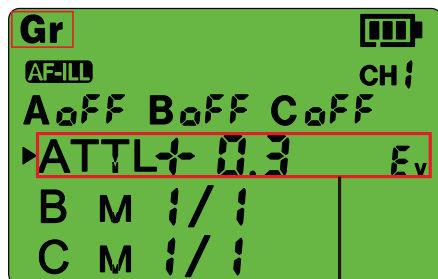

Flash Exposure Compensation

2. When use <M 1/x> mode, manually set flash output power by rotating dial. Flash output power range is adjustable from 1/1 to 1/128 (8 f-stop) and variable in 1/3 precise increment. This Mode is only applicable for flash with ETTL feature.

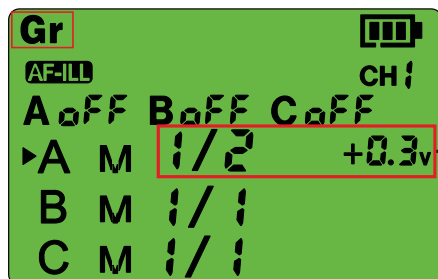

Flash output power

3. When use <M> mode, manually set flash output power by rotating dial. Flash output power doesn't reflect on radio transmitter. This mode is only applicable for VISICO series of flash light, including VCHHLR, VCHH, VE PLUS, VL PLUS AC/DC and VISICO4.

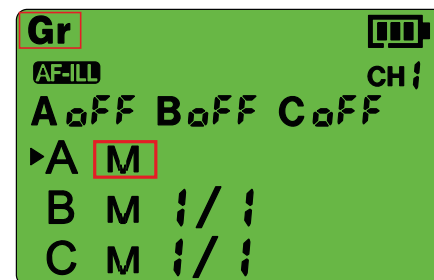

4. When use <OFF> mode, there is no signal on the screen. The selected flash is turned off. Even flash and transmitter are at the same channel, the flash can't be triggered.

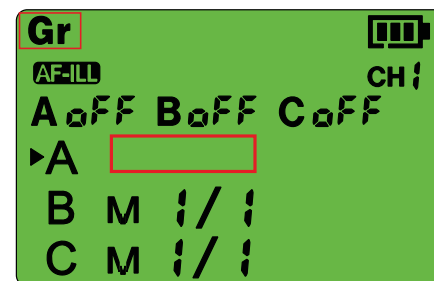

Set Shutter Speed in Gr Mode

In Gr mode, flash shutter speed can be set up to first curtain sync, second curtain sync, or high-speed sync. Short press [SYNC/CH] button, first curtain, second curtain, and high-speed sync are selectable in sequence.

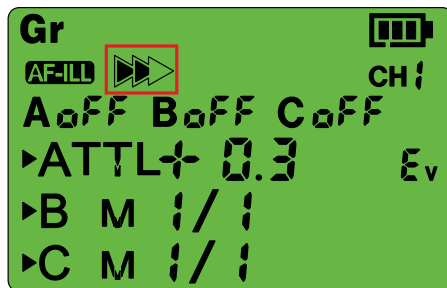

second curtain sync

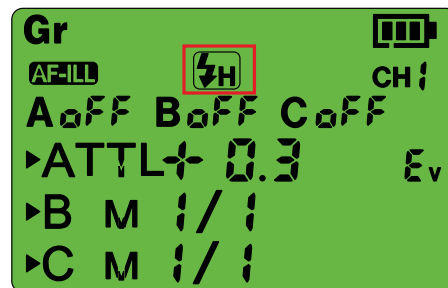

high-speed sync

! Caution:

1. Second curtain sync is only applicable in manual controlled flash.
2. When using second curtain sync, the effective shutter speed range of camera is 1/25s or slower. When shutter speed is 1/30s or faster, the setting is invalid.

ETTL Mode: Flash Ratio operation

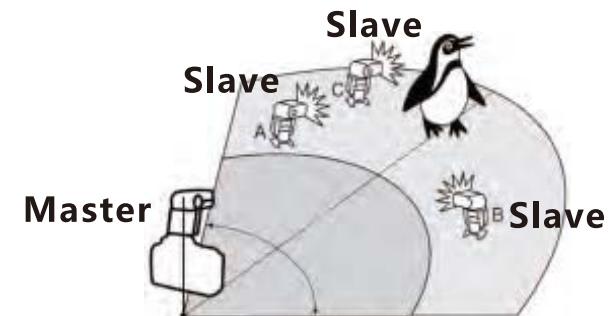

Wireless multiple flash shooting with flash ratio, make total flash output of firing groups result in proper exposure.

Select <ETTL> mode: Long press [MODE] button 3s and set the radio transmitter to <ETTL>.

Choose ratio mode: Short press [MODE] button, select ratio mode <A:B>, <A:B C>, <ALL> in sequence.



1. **Under <A:B> mode**, group A and B fire, and group C doesn't fire. Rotate dial to set up ratio rate between group A and group B. Flash exposure compensation of group A and B can be adjusted through camera, but can't be adjusted by radio transmitter.

The details of the flash ratio settings are as follows:

8 : 1 , 4 : 1 , 2 : 1 , 1 : 1 , 1 : 2 , 1 : 4 , 1 : 8

5.6 : 1 , 2.8 : 1 , 1.4 : 1 , 1 : 2.8 , 1 : 5.6

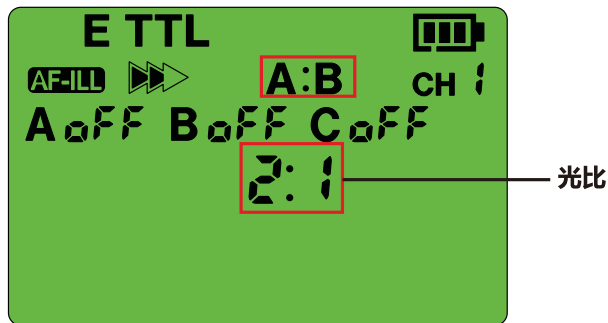

2. **Under <A:B C> mode**, group A and B fire according to flash ratio, and group C fires at the same time without ratio.

The setting of A:B is the same as above.

Set up flash exposure compensation of group C: Short press [group] button, the triangle pointed group C. Rotate dial to set flash exposure compensation of group C. Flash exposure compensation is adjustable from -3 to +3 in 1/3 precise increment.

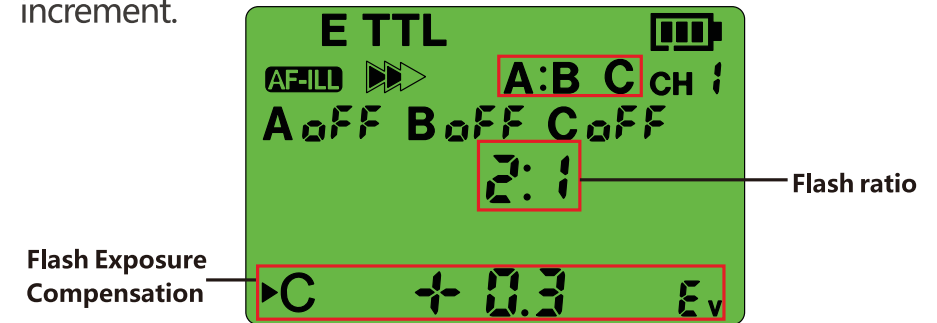

3. **Under <ALL> mode**, group A, B and C are ratio off. All the groups fire with the same flash output. Flash exposure compensation of group A, B and C are adjustable by camera, but can't be adjusted by radio transmitter.

Note: If you need more power, you may use more flashes.

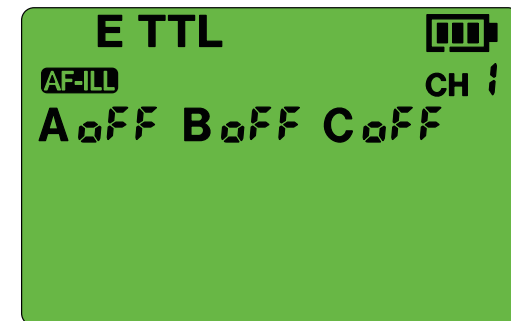

Set High-speed Sync in E TTL Mode

With certain Canon camera, you can achieve sync speed to 1/8000th of a second. When photographers shoot outdoors in bright sun with wide open aperture, fast shutter speed can cut the ambient light, get amazing result as you want.

Shortly press <SYNC/CH> button and set shutter speed to high-speed sync <⚡H>

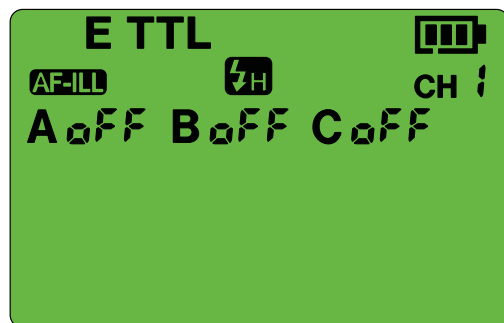

Multi Mode: Stroboscopic Operation

To achieve ideal shooting effect, please only use single flash unit in stroboscopic mode.

Select <Multi> mode: Long press [MODE] button 3s and set the radio transmitter to <Multi>.

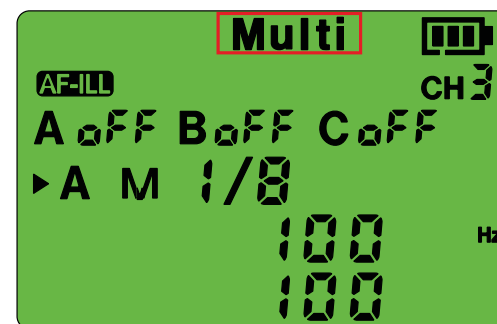

select group: Short press [GROUP] button to select group A or B or C.

Set up flash output power of selected group: Shortly press [MODE], the triangle pointed <M 1/x>. Flash output power is selectable from 1/4 to 1/128. Rotate dial to set up power. Caution: in Multi mode, max. flash output power is 1/4.

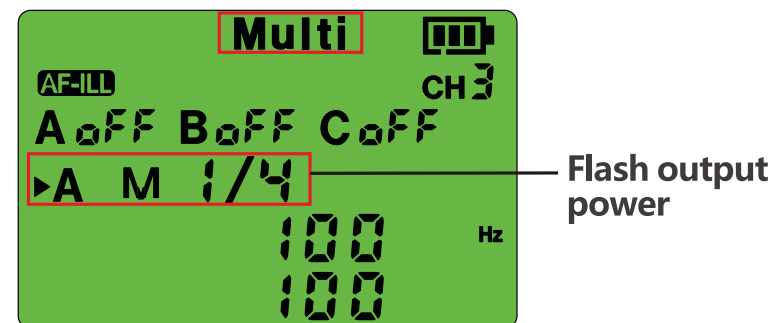

Set up flash frequency of selected group: Shortly press [MODE] button, the triangle pointed Hz. Flash frequency is variable from 1 to 100Hz. Rotate dial to set up proper frequency.

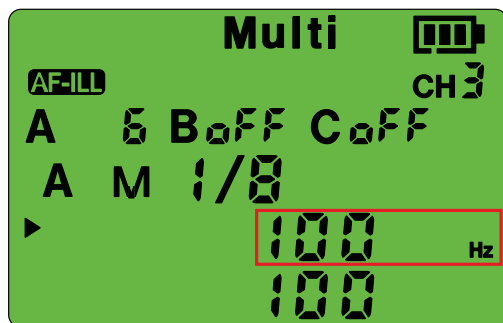

Set up number of flashes of selected group: Shortly press [MODE] button, the triangle pointed numbers of flashes. Numbers of flashes is variable from 1 to 100. Rotate dial to set up proper number of flashes

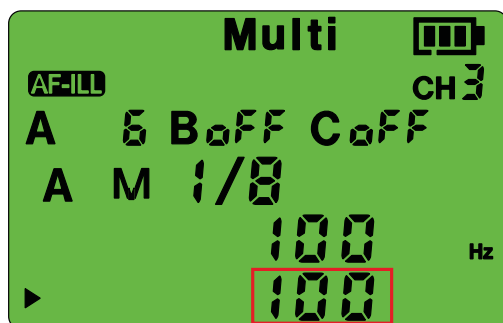

14/Operating Modeling Lamp

Use radio transmitter to remotely control the brightness of modeling lamp, dimmable in six steps.

Shortly press [MODEL/AF] button, to set up modeling lamp of group A, B, and C in sequence.

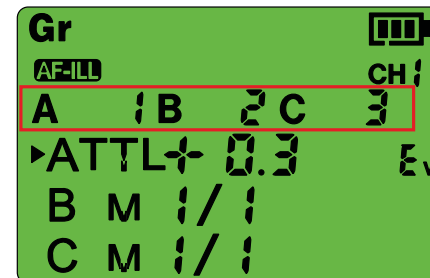

1. **Set modeling lamp of group A:** short press [MODEL/AF] button, the LCD screen only show modeling lamp value of group A. Rotate dial and set up proper modeling lamp output 1/2/3/4/5/6/OFF. Press [OK] button to save setting.

2. **Set modeling lamp of group B:** short press [MODEL/AF] button twice, the LCD screen only show modeling lamp value of group B. Rotate dial and set up proper modeling lamp output 1/2/3/4/5/6/OFF. Press [OK] button to save setting.

3. **Set modeling lamp of group C:** short press [MODEL/AF] button, the LCD screen only show modeling lamp value of group C. Rotate dial and set up proper modeling lamp output 1/2/3/4/5/6/OFF. Press [OK] button to save setting.

Caution: The feature that remotely control modeling lamp is only applicable to a few series of VISICO flashes. It is not applicable to other brand of flashes.

15/Test

Press [TEST] button, radio transmission confirmation lamp light in red, can test whether flash is triggered normally.

16/Transmitter Control from Camera's Menu Screen

Set flash functions, radio transmitter functions from the camera's menu screen.

1. Slip the transmitter's mounting foot fully into the camera's hot shoe. Rotate locking ring clockwise, to attach transmitter on camera firmly. Turn on radio transmitter by turn [POWER] button to the right side.



2. Turn on Camera. Set to M manual. Put your camera in manual mode by turning the mode dial to the "M" setting.



3. Press the [MENU] button on camera and select [External Speedlite Control] or [Flash control], and press [SET] button. The screen accesses to [External Speedlite Control]

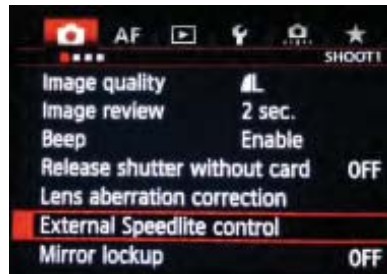

4. Select [Flash function settings], and press [SET] button.

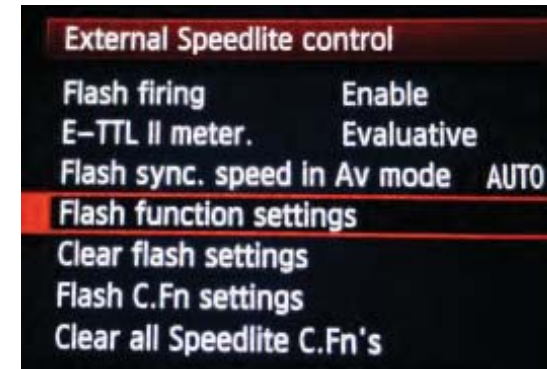

Note: The setting screen varies depending on the camera.

16-1/ Gr Mode Control from Camera

1. Select channel and group on VC-818TX radio transmitter:
When use radio transmitter in Gr mode, please set radio transmitter and flash at the same channel. According to shooting situation, divide flashes into A / B / C groups. Select the group that you are going to set up on radio trigger. When you want to set up flashes in group A, please press [GROUP] button on radio transmitter and select <A>.

2. Select wireless flash function [OFF]:

Under [Flash function settings] menu, set wireless flash function [OFF].



3. Select Flash Mode: Under [Flash function settings] menu, can select flash mode [M] or [ETTL].



When select [ETTL] mode, output power of slave flash is automatically controlled by camera. Flash Exposure Compensation (FEC), Flash Exposure Bracketing (FEB), Shutter Sync mode can be set up by camera.

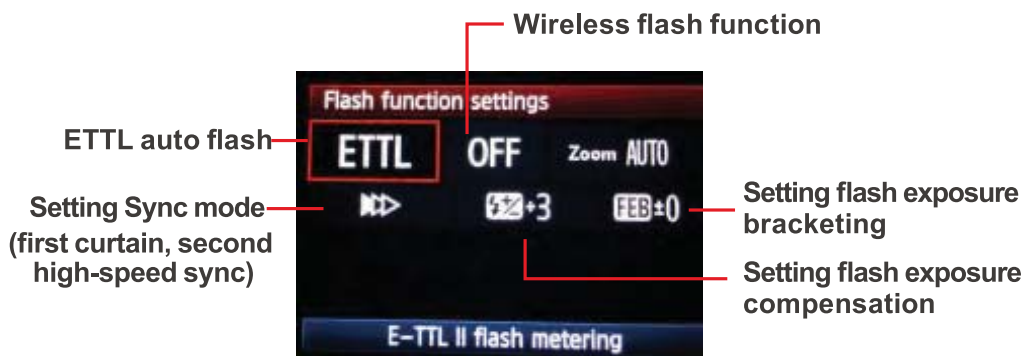

When select [M] mode, output power of slave flash is adjustable manually through camera.

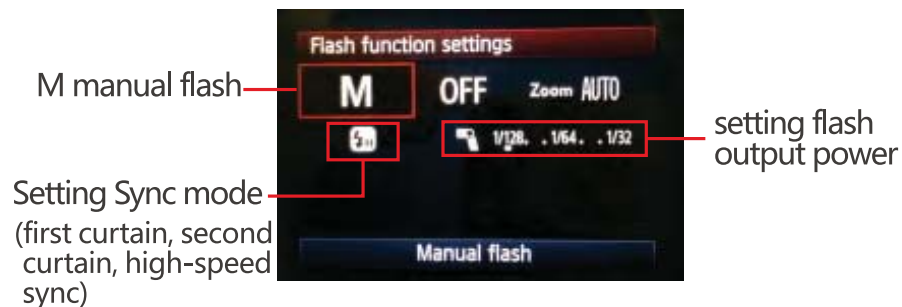

16-2/ E TTL Mode Control from Camera

1. Select wireless flash function [↗]: Under [Flash function setting] menu, set wireless flash function [↗].



optical transmission



2. Select Flash Mode: Under [Flash function setting] menu, select flash mode [ETTL]. Press [SET] to save setting.



3. Select Flash ratio mode: <A:B>, <A:B C>, <ALL>. The flash output power will be automatically controlled by camera.



A:B flash ratio

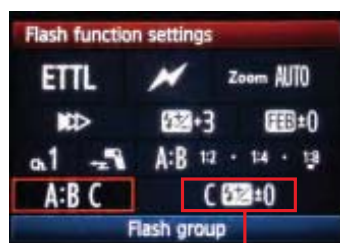

Isolated adjustment of Group C flash exposure compensation

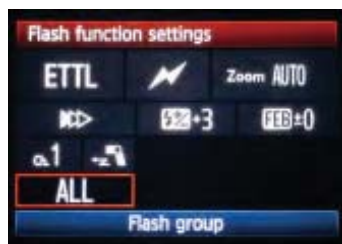

4. Choose flash sync speed: Under <ETTL> mode, there are two shutter speed for choice, first curtain sync or high-speed sync.



16-3/ Multi Mode control from Camera

1. Select wireless flash function [⚡]: Under [Flash function setting] menu, set wireless flash function [⚡].



optical transmission

2. Select Flash Mode: Under [Flash function setting] menu, can select flash mode [MULTI]. Press [SET] to save setting.



3. Adjust flash output power: Adjust output power of selected power. Every groups power is adjustable isolated.

4. Set up number of flashes and flash frequency.

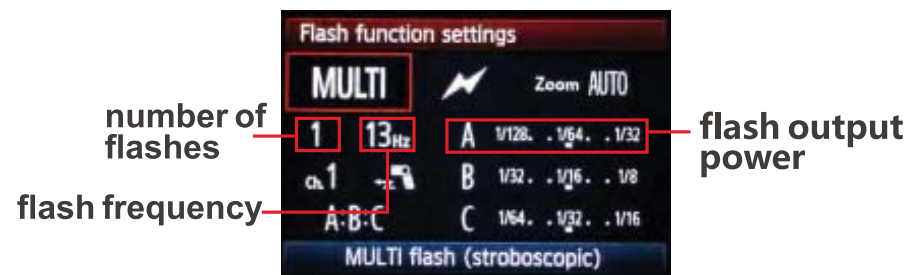



Specification

Model No.	VC-818TX
Compatible camera	Canon EOS camera, supporting E-TTL II/E-TTL autoflash
Exposure control system	E-TTL II/E-TTL autoflash, manual flash, stroboscopic flash
Channel	Ch.1-8
Wireless radio ID	1-30
Slave unit control	Under every channel controls 3 groups of slave units isolately (A,B,C)
Transmission distance	25 meters
Flash ratio control	1:8-1:1-8:1, 1/2 f-stop increment
Flash exposure compensation (FEC)	±3 stops in 1/3 increment
Flash exposure lock	Yes
High speed sync	up to 1/8000s
Manual flash	Output control range from 1/1 -1/128 (in 1/3EV increment)
Stroboscopic flash	up to 20 Flashes, up to 30Hz Frequency
AF assist beam emitter	Yes
Firmware update	Yes
Power Source	Two AA alkaline battery or Ni-MH battery
Size	90*56*40
Weight	105g

Flash Control Fully support wireless E-TTL M manual and Multi flash.

TTL flash Locking VC-818TX transmitter to the hot shoe of a Canon camera, through sending wireless signal, automatically control VISICO5 studio flash or other E-TTL speedlite and studio flashes attached to VC-818RX receivers with proper exposure.

Manual flash VC-818TX transmitter manual control power setting of all VISICO series of studio flash, E-TTL flash from other brands(other brands' flash should attach to VC-818RX).

Channel and group VC-818TX transmitter has 8 channels and 30 ID. In the same channel, VC-818TX enables you to separately control flashes in three groups simultaneously or independently.

Multiple Sync Support front-curtain sync, rear-curtain sync, high speed sync, max 1/8000s sync speed

Flash power adjustment Remotely control flash output, wide adjustment range ±3 EV, increase or reduce by precision 1/3EV, quickly achieve optimal exposure.

High-speed Burst. Supports high-speed Burst, capture splendid moments

AF-Assist beams Humanized AF-assist light, works perfectly for low-light focus

Metal hot shoes Metal hot shoe, locking ring, wear resistant, more durable, solid installation, ease of use

Update Build-in USB port for firmware upgrades, update the latest settings.

FCC WARNING

This device complies with Part 15 of the FCC rules. Operation is subject to the following two conditions:

- 1) this device may not cause harmful interference, and
- 2) this device must accept any interference received, including interference that may cause undesired operation.

Note: This equipment has been tested and found to comply with the limits for a Class B digital device, pursuant to part 15 of the FCC Rules. These limits are designed to provide reasonable protection against harmful interference in a residential installation. This equipment generates, uses and can radiate radio frequency energy and, if not installed and used in accordance with the instructions, may cause harmful interference to radio communications. However, there is no guarantee that interference will not occur in a particular installation. If this equipment does cause harmful interference to radio or television reception, which can be determined by turning the equipment off and on, the user is encouraged to try to correct the interference by one or more of the following measures:

- Reorient or relocate the receiving antenna.
- Increase the separation between the equipment and receiver.
- Connect the equipment into an outlet on a circuit different from that to which the receiver is connected.
- Consult the dealer or an experienced radio/TV technician for help.

Note: changes or modifications not expressly approved by the party responsible for compliance could void your authority to operate the equipment.

Radiation Exposure Statement

The device has been evaluated to meet general RF exposure requirement.

The device can be used in portable exposure condition without restriction.