

TEST REPORT

Test report no.: 1-0981/20-01-05

BNetzA-CAB-02/21-102

Testing laboratory

CTC advanced GmbH
Untertuerkheimer Strasse 6 – 10
66117 Saarbruecken / Germany
Phone: + 49 681 5 98 - 0
Fax: + 49 681 5 98 - 9075
Internet: <https://www.ctcadvanced.com>
e-mail: mail@ctcadvanced.com

Accredited Testing Laboratory:

The testing laboratory (area of testing) is accredited according to DIN EN ISO/IEC 17025 (2018-03) by the Deutsche Akkreditierungsstelle GmbH (DAkkS). The accreditation is valid for the scope of testing procedures as stated in the accreditation certificate starting with the registration number: D-PL-12076-01.

Applicant

Building 36 Technologies, LLC
150 A Street, Suite 104
02494-0249 Needham / UNITED STATES
Phone: 781-474-0500
Contact: Daniel Goodman
e-mail: dan@building36.com

Manufacturer

MEC electronics Entwicklung und Produktion GmbH
Dresdner Straße 45
1200 Wien / AUSTRIA

Test standard/s

FCC - Title 47 CFR Part 15 FCC - Title 47 of the Code of Federal Regulations; Chapter I; Part 15 - Radio frequency devices
RSS - 210 Issue 10 Spectrum Management and Telecommunications Radio Standards Specification - Licence-Exempt Radio Apparatus: Category I Equipment

For further applied test standards please refer to section 3 of this test report.

Test Item

Kind of test item: Display unit
Model name: DM1ALM
FCC ID: 2AC3T-B36T40HDRA
IC: 12323A-B36T40HDRA
Frequency: 24 GHz – 24.25 GHz
Technology tested: FMCW Radar
Antenna: Integrated patch antenna
Power supply: 5 V DC by external power supply
Temperature range: +5°C to +35°C

This test report is electronically signed and valid without handwritten signature. For verification of the electronic signatures, the public keys can be requested at the testing laboratory.

Test report authorized:

p.o.

Meheza Walla
Lab Manager
Radio Communications

Test performed:

p.o.

Sebastian Janoschka
Lab Manager
Radio Communications

1 Table of contents

1	Table of contents	2
2	General information	3
2.1	Notes and disclaimer	3
2.2	Application details	3
2.3	Test laboratories sub-contracted	3
3	Test standard/s and references	4
4	Reporting statements of conformity – decision rule	5
5	Test environment	6
6	Test item	6
6.1	General description.....	6
6.2	Additional information	6
7	Description of the test setup	7
7.1	Shielded semi anechoic chamber.....	8
7.2	Shielded fully anechoic chamber	10
7.3	Radiated measurements > 18 GHz.....	12
7.4	Radiated measurements > 50/85 GHz.....	12
7.5	AC conducted	14
8	Measurement uncertainty	15
9	Sequence of testing	16
9.1	Sequence of testing radiated spurious 9 kHz to 30 MHz.....	16
9.2	Sequence of testing radiated spurious 30 MHz to 1 GHz.....	17
9.3	Sequence of testing radiated spurious 1 GHz to 18 GHz.....	18
9.4	Sequence of testing radiated spurious above 18 GHz	19
9.5	Sequence of testing radiated spurious above 50/85 GHz with external mixers	20
10	Summary of measurement results	21
11	Measurement results	22
11.1	Field strength of fundamental emission.....	22
11.2	Occupied bandwidth (99% bandwidth).....	26
11.3	Field strength of emissions (radiated spurious)	27
11.4	Conducted emissions < 30 MHz	46
11.5	Frequency Stability	49
Annex A	Glossary	62
Annex B	Document history	63
Annex C	Accreditation Certificate – D-PL-12076-01-04	63
Annex D	Accreditation Certificate – D-PL-12076-01-05	64

2 General information

2.1 Notes and disclaimer

The test results of this test report relate exclusively to the test item specified in this test report. CTC advanced GmbH does not assume responsibility for any conclusions and generalizations drawn from the test results with regard to other specimens or samples of the type of the equipment represented by the test item.

The test report may only be reproduced or published in full. Reproduction or publication of extracts from the report requires the prior written approval of CTC advanced GmbH.

The testing service provided by CTC advanced GmbH has been rendered under the current "General Terms and Conditions for CTC advanced GmbH".

CTC advanced GmbH will not be liable for any loss or damage resulting from false, inaccurate, inappropriate or incomplete product information provided by the customer.

Under no circumstances does the CTC advanced GmbH test report include any endorsement or warranty regarding the functionality, quality or performance of any other product or service provided.

Under no circumstances does the CTC advanced GmbH test report include or imply any product or service warranties from CTC advanced GmbH, including, without limitation, any implied warranties of merchantability, fitness for purpose, or non-infringement, all of which are expressly disclaimed by CTC advanced GmbH.

All rights and remedies regarding vendor's products and services for which CTC advanced GmbH has prepared this test report shall be provided by the party offering such products or services and not by CTC advanced GmbH. In no case this test report can be considered as a Letter of Approval.

This test report is electronically signed and valid without handwritten signature. For verification of the electronic signatures, the public keys can be requested at the testing laboratory.

2.2 Application details

Date of receipt of order:	2021-01-27
Date of receipt of test item:	2021-03-24
Start of test:*	2021-03-30
End of test:*	2021-04-01
Person(s) present during the test:	-/-

*Date of each measurement, if not shown in the plot, can be requested. Dates are stored in the measurement software.

2.3 Test laboratories sub-contracted

None

3 Test standard/s and references

Test standard	Date	Description
FCC - Title 47 CFR Part 15		FCC - Title 47 of the Code of Federal Regulations; Chapter I; Part 15 - Radio frequency devices
RSS - 210 Issue 10	December 2019	Spectrum Management and Telecommunications Radio Standards Specification - Licence-Exempt Radio Apparatus: Category I Equipment

Guidance	Version	Description
ANSI C63.4-2014	-/-	American national standard for methods of measurement of radio-noise emissions from low-voltage electrical and electronic equipment in the range of 9 kHz to 40 GHz
ANSI C63.10-2013	-/-	American national standard of procedures for compliance testing of unlicensed wireless devices

Accreditation	Description	
D-PL-12076-01-04	Telecommunication and EMC Canada https://www.dakks.de/as/ast/d/D-PL-12076-01-04e.pdf	  <p>Deutsche Akkreditierungsstelle D-PL-12076-01-04</p>
D-PL-12076-01-05	Telecommunication FCC requirements https://www.dakks.de/as/ast/d/D-PL-12076-01-05e.pdf	  <p>Deutsche Akkreditierungsstelle D-PL-12076-01-05</p>

4 Reporting statements of conformity – decision rule

Only the measured values related to their corresponding limits will be used to decide whether the equipment under test meets the requirements of the test standards listed in chapter 3.

The measurement uncertainty is mentioned in this test report, see chapter 8, but is not taken into account - neither to the limits nor to the measurement results. Measurement results with a smaller margin to the corresponding limits than the measurement uncertainty have a potential risk of more than 5% that the decision might be wrong.

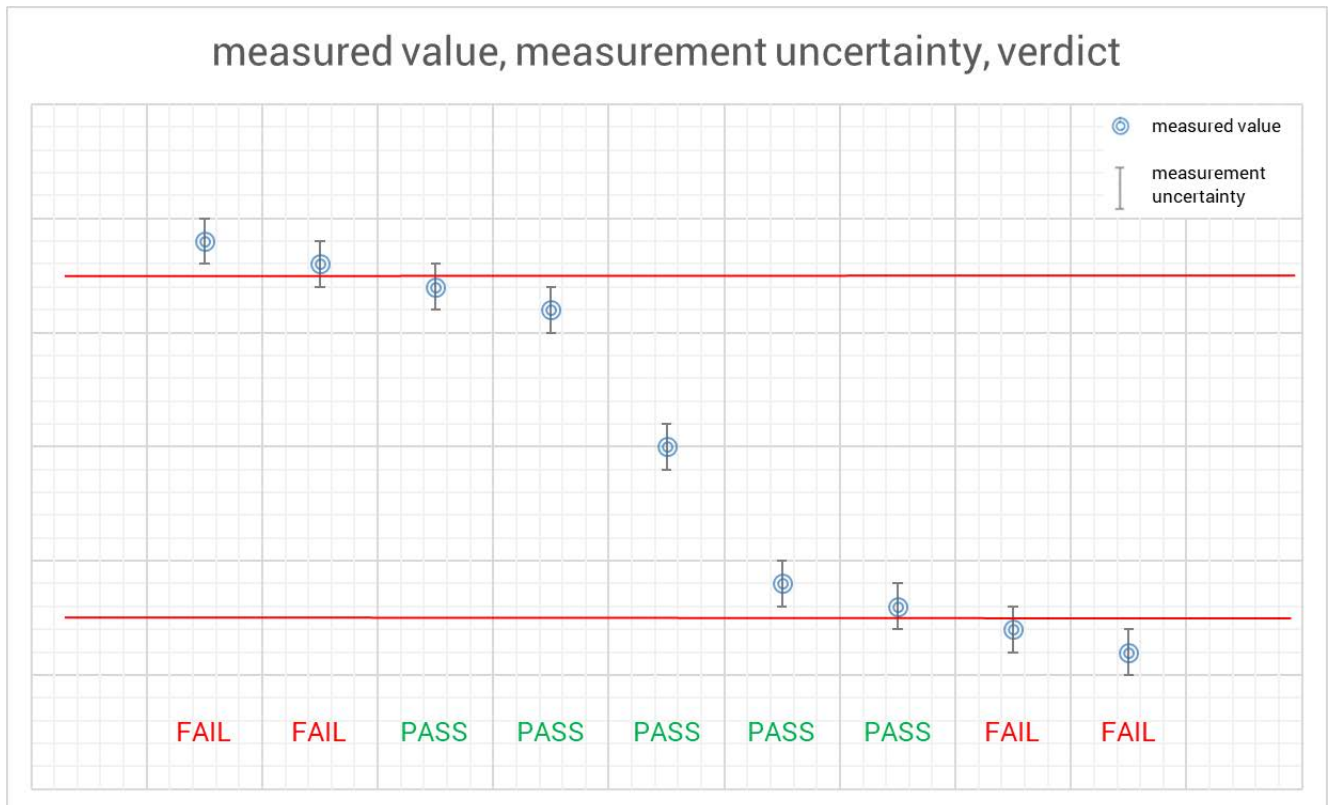

5 Test environment

Temperature	:	T_{nom} T_{max} T_{min}	+20 °C during room temperature tests +35 °C during high temperature tests +5 °C during low temperature tests
Relative humidity content	:		46 %
Barometric pressure	:		1000 hPa – 1012 hPa
Power supply	:	V_{nom} V_{max} V_{min}	5.0 V DC by external power supply 5.75 V 4.25 V

6 Test item

6.1 General description

Kind of test item	:	Display unit
Type identification	:	DM1ALM
S/N serial number	:	Engineering sample
HVIN	:	n/a
PMN	:	Display
FVIN	:	ADC-T40-HD
HMN	:	n/a
HW hardware status	:	B36-T40-HD-Z-A
SW software status	:	v1.0
Frequency band	:	24.0 GHz – 24.25 GHz
Type of modulation	:	FMCW
Number of channels	:	1
Number of modes	:	1
Antenna	:	Integrated patch antenna
Power supply	:	5 V DC by external power supply
Temperature range	:	+5°C to +35°C

6.2 Additional information

The content of the following annexes is defined in the QA. It may be that not all of the listed annexes are necessary for this report, thus some values in between may be missing.

Test setup- and EUT-photos are included in test report:

- 1-0981/20-01-05_AnnexA
- 1-0981/20-01-05_AnnexB
- 1-0981/20-01-05_AnnexD

7 Description of the test setup

Typically, the calibrations of the test apparatus are commissioned to and performed by an accredited calibration laboratory. The calibration intervals are determined in accordance with the DIN EN ISO/IEC 17025. In addition to the external calibrations, the laboratory executes comparison measurements with other calibrated test systems or effective verifications. Weekly chamber inspections and range calibrations are performed. Where possible, RF generating and signaling equipment as well as measuring receivers and analyzers are connected to an external high-precision 10 MHz reference (GPS-based or rubidium frequency standard).

In order to simplify the identification of the equipment used at some special tests, some items of test equipment and ancillaries can be provided with an identifier or number in the equipment list below (Lab/Item).

Agenda: Kind of Calibration

k	calibration / calibrated		EK	limited calibration
ne	not required (k, ev, izw, zw not required)		zw	cyclical maintenance (external cyclical maintenance)
ev	periodic self verification		izw	internal cyclical maintenance
Ve	long-term stability recognized		g	blocked for accredited testing
vkl!	Attention: extended calibration interval			
NK!	Attention: not calibrated		*)	next calibration ordered / currently in progress

7.1 Shielded semi anechoic chamber

The radiated measurements are performed in vertical and horizontal plane in the frequency range from 30 MHz to 1 GHz in semi-anechoic chambers. The EUT is positioned on a non-conductive support with a height of 0.80 m above a conductive ground plane that covers the whole chamber. The receiving antennas are conform to specifications ANSI C63. These antennas can be moved over the height range between 1.0 m and 4.0 m in order to search for maximum field strength emitted from EUT. The measurement distances between EUT and receiving antennas are indicated in the test setups for the various frequency ranges. For each measurement, the EUT is rotated in all three axes until the maximum field strength is received. The wanted and unwanted emissions are received by spectrum analyzers where the detector modes and resolution bandwidths over various frequency ranges are set according to requirement ANSI C63.

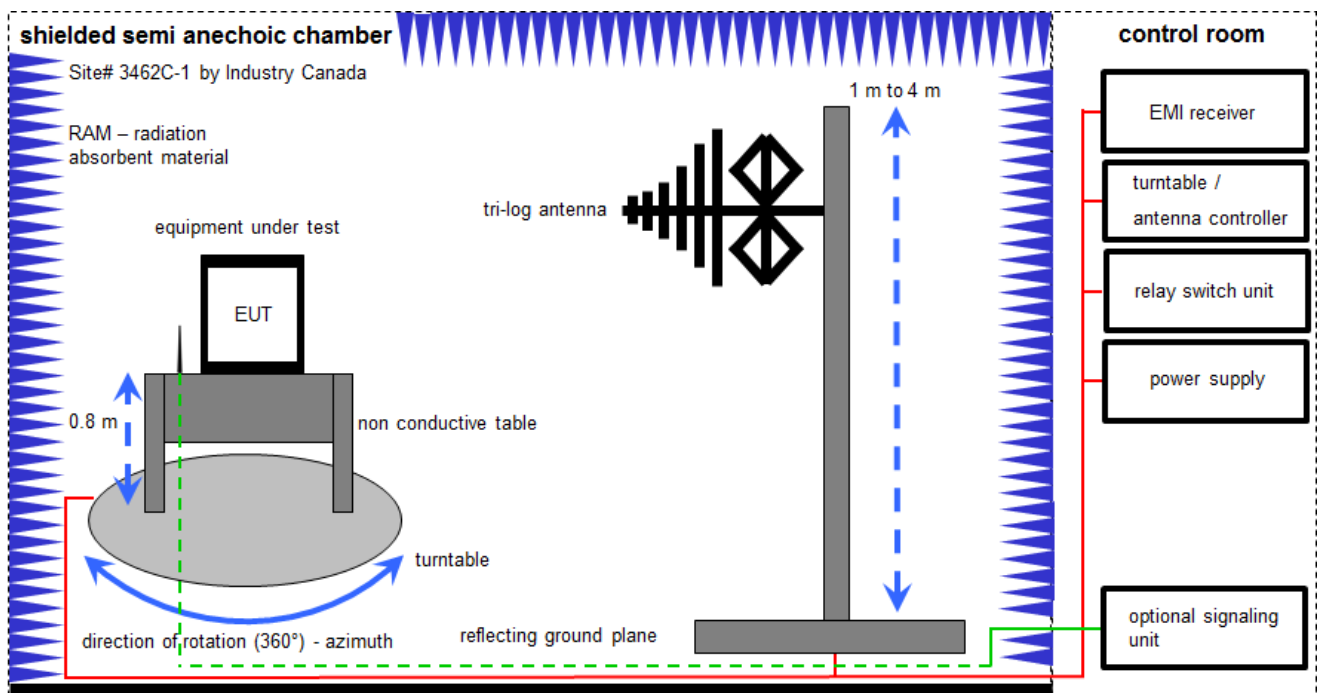

Measurement distance: tri-log antenna 10 meter

$$FS = UR + CL + AF$$

(FS-field strength; UR-voltage at the receiver; CL-loss of the cable; AF-antenna factor)

Example calculation:

$$FS [dB\mu V/m] = 12.35 [dB\mu V/m] + 1.90 [dB] + 16.80 [dB/m] = 31.05 [dB\mu V/m] (35.69 \mu V/m)$$

Equipment table:

No.	Setup	Equipment	Type	Manufact.	Serial No.	INV. No Cetecom	Kind of Calibration	Last Calibration	Next Calibration
1	A	Switch-Unit	3488A	HP	2719A14505	300000368	ev	-/-	-/-
2	A	Meßkabine 1	HF-Absorberhalle	MWB AG 300023	-/-	300000551	ne	-/-	-/-
3	A	Antenna Tower	Model 2175	ETS-Lindgren	64762	300003745	izw	-/-	-/-
4	A	Positioning Controller	Model 2090	ETS-Lindgren	64672	300003746	izw	-/-	-/-
5	A	Turntable Interface- Box	Model 105637	ETS-Lindgren	44583	300003747	izw	-/-	-/-
6	A	TRILOG Broadband Test-Antenna 30 MHz - 3 GHz	VULB9163	Schwarzbeck Mess - Elektronik	318	300003696	vKI!	04.09.2019	03.09.2021
7	A	EMI Test Receiver	ESR3	Rohde & Schwarz	102587	300005771	k	10.12.2020	09.06.2022

7.2 Shielded fully anechoic chamber

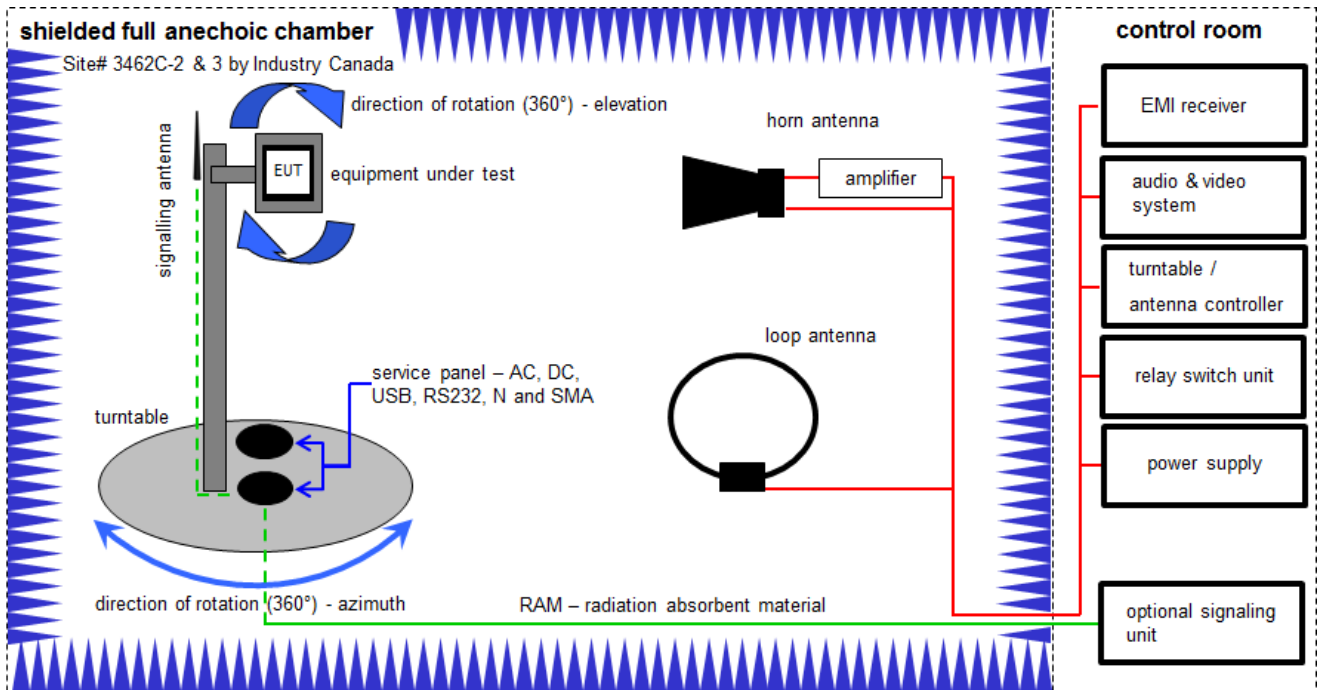

Measurement distance: horn antenna 3 meter; loop antenna 3 meter / 1 meter

$$FS = UR + CA + AF$$

(FS-field strength; UR-voltage at the receiver; CA-loss of the signal path; AF-antenna factor)

Example calculation:

$$FS [dB\mu V/m] = 40.0 [dB\mu V/m] + (-35.8) [dB] + 32.9 [dB/m] = 37.1 [dB\mu V/m] (71.61 \mu V/m)$$

$$OP = AV + D - G + CA$$

(OP-radiated output power; AV-analyzer value; D-free field attenuation of measurement distance; G-antenna gain+amplifier gain; CA-loss signal path)

Example calculation:

$$OP [dBm] = -39.0 [dBm] + 57.0 [dB] - 12.0 [dBi] + (-36.0) [dB] = -30 [dBm] (1 \mu W)$$

Equipment table:

No.	Lab / Item	Equipment	Type	Manufacturer	Serial No.	INV. No.	Kind of Calibration	Last Calibration	Next Calibration
1	A,B,C	DC power supply, 60Vdc, 50A, 1200 W	6032A	HP	2818A03450	300001040	vKI!	09.12.2020	08.12.2023
2	A,B,C	Anechoic chamber	FAC 3/5m	MWB / TDK	87400/02	300000996	ev	-/-	-/-
3	B	Double-Ridged Waveguide Horn Antenna 1-18.0GHz	3115	EMCO	9107-3697	300001605	vKI!	12.03.2021	11.03.2023
4	A,B,C	Switch / Control Unit	3488A	HP	*	300000199	ne	-/-	-/-
5	A,B,C	Variable isolating transformer	MPL IEC625 Bus Variable isolating transformer	Erfi	91350	300001155	ne	-/-	-/-
6	A,B,C	EMI Test Receiver 20Hz- 26,5GHz	ESU26	R&S	100037	300003555	k	11.12.2020	10.12.2021
7	B	Highpass Filter	WHKX7.0/18G-8SS	Wainwright	19	300003790	ne	-/-	-/-
8	B	Broadband Amplifier 0.5-18 GHz	CBLU5184540	CERNEX	22049	300004481	ev	-/-	-/-
9	B	Broadband Amplifier 5-13 GHz	CBLU5135235	CERNEX	22010	300004491	ev	-/-	-/-
10	A,B,C	4U RF Switch Platform	L4491A	Agilent Technologies	MY50000037	300004509	ne	-/-	-/-
11	A,B,C	NEXIO EMV-Software	BAT EMC V3.16.0.49	EMCO		300004682	ne	-/-	-/-
12	A,B,C	PC	ExOne	F+W		300004703	ne	-/-	-/-
13	B	RF-Amplifier	AMF-6F06001800-30-10P-R	NARDA-MITEQ Inc	2011572	300005241	ev	-/-	-/-
14	A	Active Loop Antenna 9 kHz to 30 MHz	6502	EMCO	2210	300001015	vKI!	13.06.2019	12.06.2021

7.3 Radiated measurements > 18 GHz

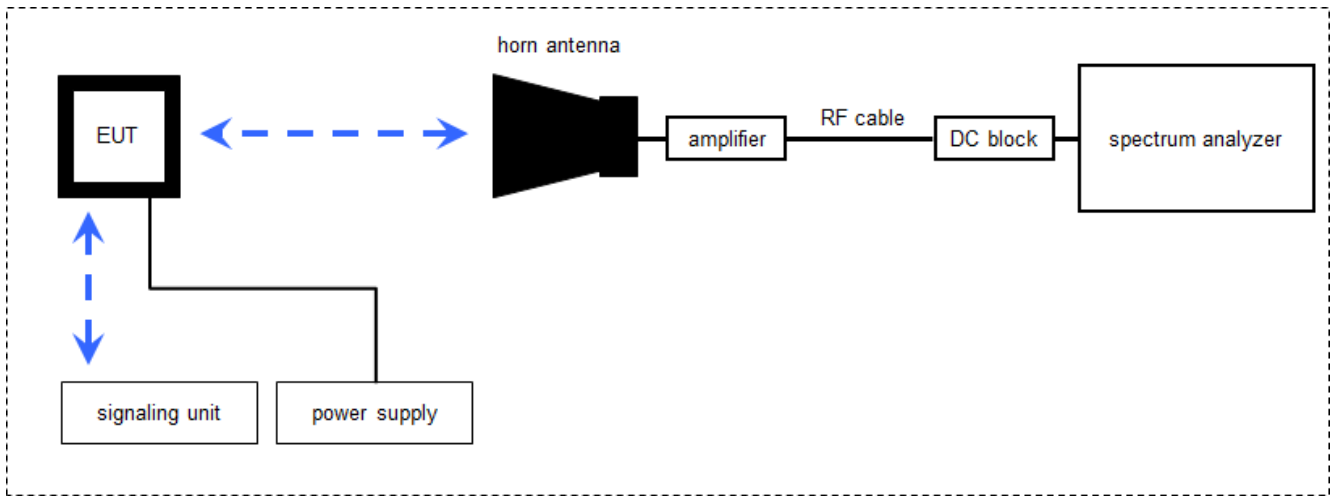

7.4 Radiated measurements > 50/85 GHz

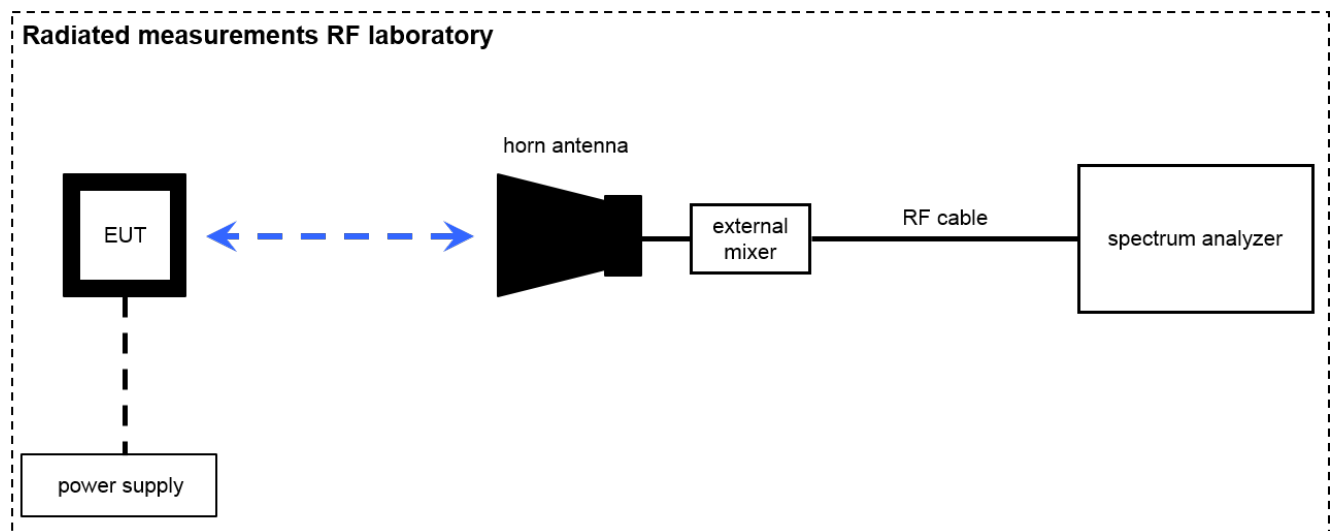

Measurement distance: horn antenna e.g. 25 cm

$$FS = UR + CA + AF$$

(FS-field strength; UR-voltage at the receiver; CA-loss signal path & distance correction; AF-antenna factor)

Example calculation:

$$FS [dB\mu V/m] = 40.0 [dB\mu V/m] + (-60.1) [dB] + 36.74 [dB/m] = 16.64 [dB\mu V/m] (6.79 \mu V/m)$$

$$OP = AV + D - G + CA$$

(OP-radiated output power; AV-analyzer value; D-free field attenuation of measurement distance; G-antenna gain+amplifier gain; CA-loss signal path)

Example calculation:

$$OP [dBm] = -59.0 [dBm] + 44.0 [dB] - 20.0 [dBi] + 5.0 [dB] = -30 [dBm] (1 \mu W)$$

Equipment table:

No.	Lab / Item	Equipment	Type	Manufacturer	Serial No.	INV. No.	Kind of Calibration	Last Calibration	Next Calibration
1	n. a.	Spectrum Analyzer	FSW50	Rohde & Schwarz	101332	300005935	k	05.03.2021	04.03.2022
2	n. a.	Broadband LNA 18-50 GHz	CBL18503070PN	CERNEX	25240	300004948	ev	09.03.2020	08.03.2022
3	n.a.	Horn Antenna 18,0-40,0 GHz	LHAF180	Microw.Devel	39180-103-021	300001747	vKI!	18.02.2019	17.02.2022
4	A027	Std. Gain Horn Antenna 18.0-26.5 GHz	638	Narda	01096	300000486	vKI!	21.01.2020	20.01.2022
5	A031	Std. Gain Horn Antenna 26.5-40.0 GHz	V637	Narda	82-16	300000510	vKI!	23.01.2020	22.01.2022
6	n. a.	Std. Gain Horn Antenna 33.0-50.1 GHz	2324-20	Flann	57	400000683	ne	-/-	-/-
7	n. a.	Harmonic Mixer 3-Port, 50-75 GHz	FS-Z75	Rohde & Schwarz	101578	300005788	k	17.06.2020	16.06.2021
8	A026	Std. Gain Horn Antenna 49.9-75.8 GHz	2524-20	Flann	*	300001986	ne	-/-	-/-
9	n. a.	Harmonic Mixer 3-Port, 75-110 GHz	FS-Z110	R&S	101411	300004959	k	19.06.2020	18.06.2021
10	A027	Std. Gain Horn Antenna 73.8-112 GHz	2724-20	Flann	*	300001988	ne	-/-	-/-

7.5 AC conducted

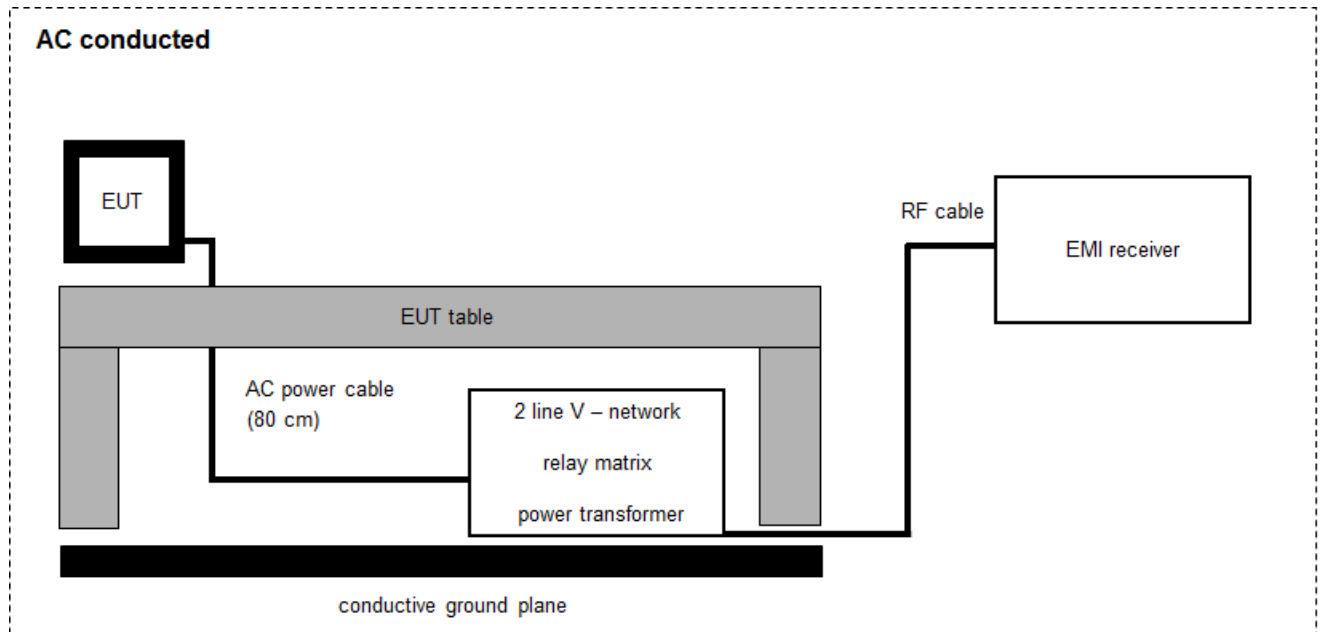

$$FS = UR + CF + VC$$

(FS-field strength; UR-voltage at the receiver; CR-loss of the cable and filter; VC-correction factor of the ISN)

Example calculation:

$$FS [dB\mu V/m] = 37.62 [dB\mu V/m] + 9.90 [dB] + 0.23 [dB] = 47.75 [dB\mu V/m] (244.06 \mu V/m)$$

Equipment table:

No.	Lab / Item	Equipment	Type	Manufacturer	Serial No.	INV. No.	Kind of Calibration	Last Calibration	Next Calibration
1	101	Two-line V-Network (LISN) 9 kHz to 30 MHz	ESH3-Z5	R&S	893045/004	300000584	k	10.12.2020	09.12.2021
2	67	RF-Filter-section	85420E	HP	3427A00162	300002214	k	27.11.2006	-/-
3	27	EM-Injection Clamp	FCC-203i	emv	232	300000626	ev	18.05.2001	-/-
4	n. a.	Magnetfeldantenne	MS 100	EM-Test	-----	300002659	ev	24.04.2000	-/-
5	n. a.	AC-Spannungsquelle variabel	MV2616-V	EM-Test	0397-12	300003259	vKI!	26.05.2020	25.05.2021
6	n. a.	Analyzer-Reference-System (Harmonics and Flicker)	ARS 16/1	SPS	A3509 07/0 0205	300003314	vKI!	17.01.2020	16.01.2022
7	n. a.	Hochpass 150 kHz	EZ-25	R&S	100010	300003798	ev	08.04.2008	-/-
8	n. a.	Power Supply	NGSM 32/10	R&S	3939	400000192	vKI!	11.12.2019	10.12.2022
9	n. a.	EMI Test Receiver	ESCI 3	R&S	100083	300003312	k	09.12.2020	08.12.2021

8 Measurement uncertainty

Test case	Uncertainty
Equivalent isotropically radiated power (e.i.r.p.)	Conducted value ± 1 dB Radiated value ± 3 dB
Permitted range of operating frequencies	± 100 kHz
Conducted unwanted emissions in the spurious domain (up to 18 GHz)	± 1 dB
Radiated unwanted emissions in the spurious domain (up to 18 GHz)	± 3 dB
Conducted unwanted emissions in the spurious domain (18 to 40 GHz)	± 4 dB
Radiated unwanted emissions in the spurious domain (18 to 40 GHz)	± 4 dB
Conducted unwanted emissions in the spurious domain (40 to 50 GHz)	± 4.5 dB
Radiated unwanted emissions in the spurious domain (40 to 50 GHz)	± 4.5 dB
Conducted unwanted emissions in the spurious domain (above 50 GHz)	± 5 dB
Radiated unwanted emissions in the spurious domain (above 50 GHz)	± 5 dB
DC and low frequency voltages	± 3 %
Temperature	± 1 °C
Humidity	± 3 %

9 Sequence of testing

9.1 Sequence of testing radiated spurious 9 kHz to 30 MHz

Setup

- The equipment is set up to simulate normal operation mode as described in the user manual or defined by the manufacturer.
- If the EUT is a tabletop system, it is placed on a table with 0.8 m height.
- If the EUT is a floor standing device, it is placed directly on the turn table.
- Auxiliary equipment and cables are positioned to simulate normal operation conditions as described in ANSI C 63.4.
- The AC power port of the EUT (if available) is connected to a power outlet below the turntable.
- Measurement distance is 3 m (see ANSI C 63.4) – see test details.
- EUT is set into operation.

Premeasurement*

- The turntable rotates from 0° to 315° using 45° steps.
- The antenna height is 1 m.
- At each turntable position the analyzer sweeps with positive-peak detector to find the maximum of all emissions.

Final measurement

- Identified emissions during the pre-measurement are maximized by the software by rotating the turntable from 0° to 360°.
- Loop antenna is rotated about its vertical axis for maximum response at each azimuth about the EUT. (For certain applications, the loop antenna plane may also need to be positioned horizontally at the specified distance from the EUT)
- The final measurement is done in the position (turntable and elevation) causing the highest emissions with quasi-peak (as described in ANSI C 63.4).
- Final levels, frequency, measuring time, bandwidth, turntable position, correction factor, margin to the limit and limit will be recorded. A plot with the graph of the premeasurement and the limit is stored.

*)Note: The sequence will be repeated three times with different EUT orientations.

9.2 Sequence of testing radiated spurious 30 MHz to 1 GHz

Setup

- The equipment is set up to simulate normal operation mode as described in the user manual or defined by the manufacturer.
- If the EUT is a tabletop system, a table with 0.8 m height is used, which is placed on the ground plane.
- If the EUT is a floor standing device, it is placed on the ground plane with insulation between both.
- Auxiliary equipment and cables are positioned to simulate normal operation conditions as described in ANSI C 63.4.
- The AC power port of the EUT (if available) is connected to a power outlet below the turntable.
- Measurement distance is 10 m or 3 m (see ANSI C 63.4) – see test details.
- EUT is set into operation.

Premeasurement

- The turntable rotates from 0° to 315° using 45° steps.
- The antenna is polarized vertical and horizontal.
- The antenna height changes from 1 m to 3 m.
- At each turntable position, antenna polarization and height the analyzer sweeps three times in peak to find the maximum of all emissions.

Final measurement

- The final measurement is performed for at least six highest peaks according to the requirements of the ANSI C63.4.
- Based on antenna and turntable positions at which the peak values are measured the software maximize the peaks by changing turntable position $\pm 45^\circ$ and antenna height between 1 and 4 m.
- The final measurement is done with quasi-peak detector (as described in ANSI C 63.4).
- Final levels, frequency, measuring time, bandwidth, antenna height, antenna polarization, turntable angle, correction factor, margin to the limit and limit are recorded. A plot with the graph of the premeasurement with marked maximum final results and the limit is stored.

9.3 Sequence of testing radiated spurious 1 GHz to 18 GHz

Setup

- The equipment is set up to simulate normal operation mode as described in the user manual or defined by the manufacturer.
- If the EUT is a tabletop system, a 2-axis positioner with 1.5 m height is used.
- If the EUT is a floor standing device, it is placed directly on the turn table.
- Auxiliary equipment and cables are positioned to simulate normal operation conditions as described in ANSI C 63.4.
- The AC power port of the EUT (if available) is connected to a power outlet below the turntable.
- Measurement distance is 3 m (see ANSI C 63.4) – see test details.
- EUT is set into operation.

Premeasurement

- The turntable rotates from 0° to 315° using 45° steps.
- The antenna is polarized vertical and horizontal.
- The antenna height is 1.5 m.
- At each turntable position and antenna polarization the analyzer sweeps with positive peak detector to find the maximum of all emissions.

Final measurement

- The final measurement is performed for at least six highest peaks according to the requirements of the ANSI C63.4.
- Based on antenna and turntable positions at which the peak values are measured the software maximizes the peaks by rotating the turntable from 0° to 360°. This measurement is repeated for different EUT-table positions (0° to 150° in 30°-steps) and for both antenna polarizations.
- The final measurement is done in the position (turntable, EUT-table and antenna polarization) causing the highest emissions with Peak and RMS detector (as described in ANSI C 63.4).
- Final levels, frequency, measuring time, bandwidth, turntable position, EUT-table position, antenna polarization, correction factor, margin to the limit and limit are recorded. A plot with the graph of the premeasurement with marked maximum final results and the limit is stored.

9.4 Sequence of testing radiated spurious above 18 GHz

Setup

- The equipment is set up to simulate normal operation mode as described in the user manual or defined by the manufacturer.
- Auxiliary equipment and cables are positioned to simulate normal operation conditions as described in ANSI C 63.4.
- The AC power port of the EUT (if available) is connected to a power outlet.
- The measurement distance is as appropriate (e.g. 0.5 m).
- The EUT is set into operation.

Premeasurement

- The test antenna is handheld and moved carefully over the EUT to cover the EUT's whole sphere and different polarizations of the antenna.

Final measurement

- The final measurement is performed at the position and antenna orientation causing the highest emissions with Peak and RMS detector (as described in ANSI C 63.4).
- Final levels, frequency, measuring time, bandwidth, correction factor, margin to the limit and limit are recorded. A plot with the graph of the premeasurement and the limit is stored.

9.5 Sequence of testing radiated spurious above 50/85 GHz with external mixers

Setup

- The equipment is set up to simulate normal operation mode as described in the user manual or defined by the manufacturer.
- Auxiliary equipment and cables are positioned to simulate normal operation conditions as described in ANSI C 63.4.
- The AC power port of the EUT (if available) is connected to a power outlet.
- The measurement distance is as appropriate for far field (e.g. 0.25 m).
- The EUT is set into operation.

Premeasurement

- The test antenna with external mixer is handheld and moved carefully over the EUT to cover the EUT's whole sphere and different polarizations of the antenna.
- Caution is taken to reduce the possible overloading of the external mixer.

Final measurement

- The final measurement is performed at the position and antenna orientation causing the highest emissions with Peak and RMS detector (as described in ANSI C 63.4).
- As external mixers may generate false images care is taken to ensure that any emission measured by the spectrum analyzer does indeed originate in the EUT. Signal identification feature of spectrum analyzer is used to eliminate false mixer images (i.e., it is not the fundamental emission or a harmonic falling precisely at the measured frequency).
- Final levels, frequency, measuring time, bandwidth, correction factor, margin to the limit and limit are recorded. A plot with the graph of the premeasurement and the limit is stored.

10 Summary of measurement results

<input checked="" type="checkbox"/>	No deviations from the technical specifications were ascertained
<input type="checkbox"/>	There were deviations from the technical specifications ascertained
<input type="checkbox"/>	This test report is only a partial test report. The content and verdict of the performed test cases are listed below.

TC Identifier	Description	Verdict	Date	Remark
RF-Testing	FCC 47 CFR Part 15 RSS-210 Issue 10	Passed	2021-06-11	-/-

Test specification clause	Test case	Temperature conditions	Power source voltages	C	NC	NA	NP	Results (max.)
§15.249(a) / RSS-210, B.10(a)	Field strength of fundamental emission	Nominal	Nominal	<input checked="" type="checkbox"/>	<input type="checkbox"/>	<input type="checkbox"/>	<input type="checkbox"/>	
§2.1049	Occupied bandwidth (99% bandwidth)	Nominal	Nominal	<input checked="" type="checkbox"/>	<input type="checkbox"/>	<input type="checkbox"/>	<input type="checkbox"/>	
§15.209(a) / §15.249(d) / RSS-210, B.10	Field strength of emissions (radiated spurious)	Nominal	Nominal	<input checked="" type="checkbox"/>	<input type="checkbox"/>	<input type="checkbox"/>	<input type="checkbox"/>	
§15.207(a) RSS-Gen 8.8	Conducted emissions < 30 MHz	Nominal	Nominal	<input checked="" type="checkbox"/>	<input type="checkbox"/>	<input type="checkbox"/>	<input type="checkbox"/>	
§15.215(c) RSS-Gen 8.11	Frequency Stability	Nominal Extreme	Nominal Extreme	<input checked="" type="checkbox"/>	<input type="checkbox"/>	<input type="checkbox"/>	<input type="checkbox"/>	

Note: C = Compliant; NC = Not compliant; NA = Not applicable; NP = Not performed

11 Measurement results

11.1 Field strength of fundamental emission

Description:

Measurement of the maximum radiated field strength of the wanted signal.

Measurement:

Measurement parameter	
Detector:	Pos-Peak / Average
Sweep time:	10 s
Resolution bandwidth:	1 MHz
Video bandwidth:	3 MHz
Span:	300 MHz
Trace-Mode:	Max Hold
Measurement uncertainty	± 3 dB

This test was performed on a shorter test distance. A correction factor of $20 \cdot \log(x \text{ m}/3 \text{ m})$ is already considered in the plots.

Limits:

FCC		IC
CFR Part 15.249(a)		RSS-210, B.10
Field strength of emissions		
The field strength of emissions from intentional radiators operated within these frequency bands shall comply with the following:		
Frequency	Field Strength	Measurement distance
24.0 GHz – 24.25 GHz	108 dB μ V/m (Average) 128 dB μ V/m (PEAK)	3 m

§15.249 (e) As shown in § 15.35(b), for frequencies above 1000 MHz, the field strength limits in paragraphs (a) and (b) of this section are based on average limits. However, the peak field strength of any emission shall not exceed the maximum permitted average limits specified above by more than 20 dB under any condition of modulation.

§15.31 (c) Except as otherwise indicated in §15.256, for swept frequency equipment, measurements shall be made with the frequency sweep stopped at those frequencies chosen for the measurements to be reported.

Measurement results:

Test condition	Maximum field strength (Peak) (dB μ V/m @3m)	Maximum field strength (Average) (dB μ V/m @3m)
f _{low}	98.98	89.42
f _{mid}	97.25	88.49
f _{high}	95.28	88.30

Note:

For the measurements presented in this section, the maximum power setting (highest possible duty cycle) has been used.

Plot No. 1: Field strength, f_{low}

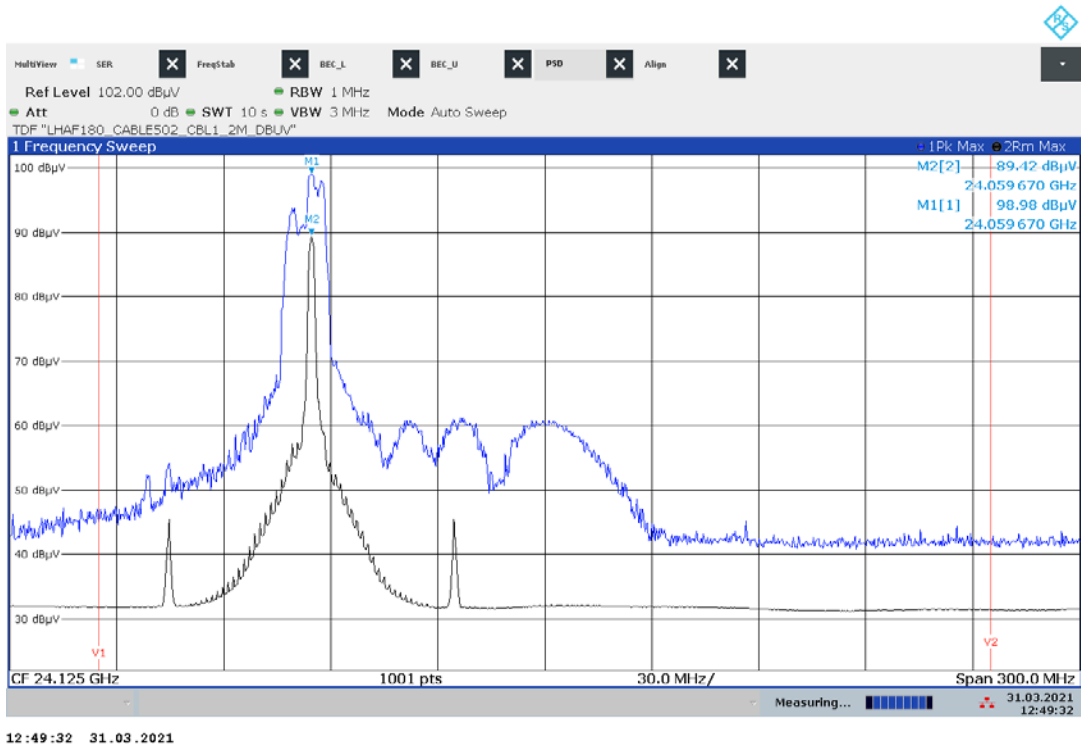

Plot No. 2: Field strength, f_{mid}

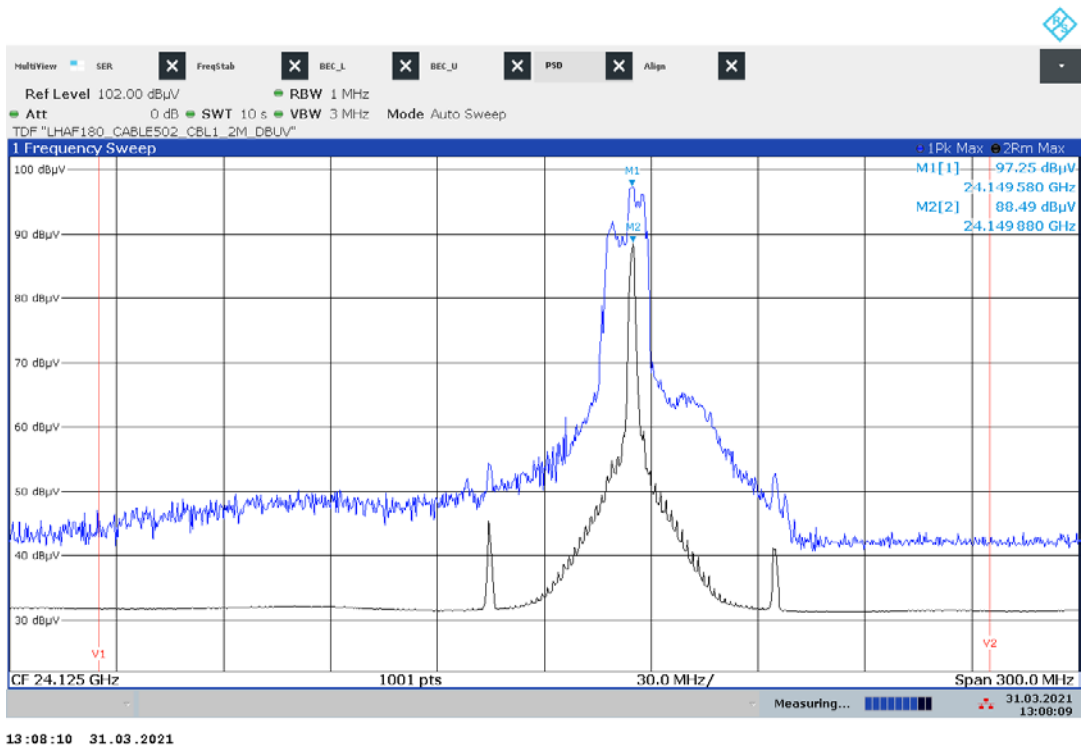

Plot No. 3: Field strength, f_{high}

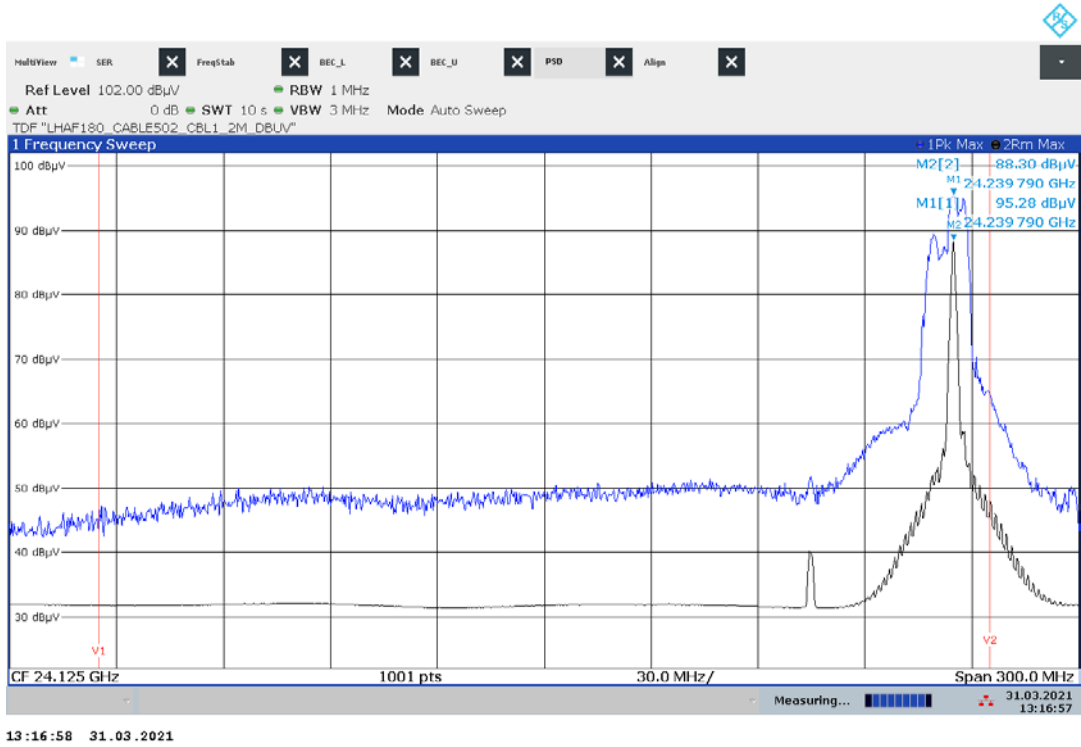

11.2 Occupied bandwidth (99% bandwidth)

Description:

Measurement of the 99% bandwidth of the wanted signal.

Measurement:

Parameter	
Detector:	Pos-Peak
Sweep time:	10 s
Resolution bandwidth:	1 MHz
Video bandwidth:	3 MHz
Span:	350 MHz
Trace-Mode:	Max Hold
Measurement uncertainty	± Span/1000

Limits:

FCC		IC	
CFR Part 15.249(a)		RSS-210, B.10	
The field strength of emissions from intentional radiators operated within the specified frequency band shall comply with the following			
Frequency range	f_L	f_H	
250 MHz	> 24.0 GHz	< 24.25 GHz	

Measurement results:

Test condition	f_L (GHz)	f_H (GHz)	Occupied bandwidth (MHz)
f_{low}	24.0531	24.0633	10.3
f_{mid}	24.1429	24.1533	10.4
f_{high}	24.2329	24.2436	10.7

The corresponding plots are shown in section 11.5.

11.3 Field strength of emissions (radiated spurious)

Description:

Measurement of the radiated spurious emissions in transmit mode.

Measurement:

Parameter	
Detector:	Quasi-Peak / Pos-Peak / Average
Sweep time:	Auto
Resolution bandwidth:	100 kHz / 1 MHz
Video bandwidth:	300 kHz / 3 MHz
Trace-Mode:	Max Hold
Measurement uncertainty	± 3 dB

Limits:

FCC		IC
CFR Part 15.209(a) / CFR Part 15.249(d)		RSS - GEN
Emissions radiated outside of the specified frequency bands, except for harmonics, shall be attenuated by at least 50 dB below the level of the fundamental or to the general radiated emission limits in § 15.209, whichever is the lesser attenuation.		
Frequency (MHz)	Field Strength (µV/m)	Measurement distance (m)
0.009 – 0.490	2400/F(kHz)	300
0.490 – 1.705	24000/F(kHz)	30
1.705 – 30.0	30	30
30 – 88	100	3
88 – 216	150	3
216 – 960	200	3
Above 960	500	3

§15.249 (e) As shown in § 15.35(b), for frequencies above 1000 MHz, the field strength limits in paragraphs (a) and (b) of this section are based on average limits. However, the peak field strength of any emission shall not exceed the maximum permitted average limits specified above by more than 20 dB under any condition of modulation.

§15.31 (c) Except as otherwise indicated in §15.256, for swept frequency equipment, measurements shall be made with the frequency sweep stopped at those frequencies chosen for the measurements to be reported.

Measurement results:

Low / Mid / High frequency			
f [GHz]	Detector	Measured level [dB μ V/m]	Margin
No critical peaks found. For details, please refer to plots.			
1224.4	AVG	35.32	18.68
2035.0	AVG	37.14	16.86
1224.4	PEAK	51.23	22.77
2035.0	PEAK	51.97	22.03
1214.2	AVG	29.06	24.94
2040.4	AVG	43.46	10.54
1214.2	PEAK	46.14	27.86
2040.4	PEAK	61.28	12.72
1022.8	AVG	27.23	26.77
2048.8	AVG	38.43	15.57
1022.8	PEAK	40.52	33.48
2048.8	PEAK	56.87	17.13

Note:

If not stated otherwise, the plots presented below show the maximum detected signals for all frequency modes (f_{low} , f_{mid} , f_{high}).

Measurements above 50 GHz were performed on a short measurement distance (≤ 1 m) to improve the minimum sensitivity of the test system. A correction factor of $20 \cdot \log(d/3m)$ is already considered in the plots.

Plot No. 4: 9 kHz to 30 MHz, horizontal/vertical polarization, f_{low}

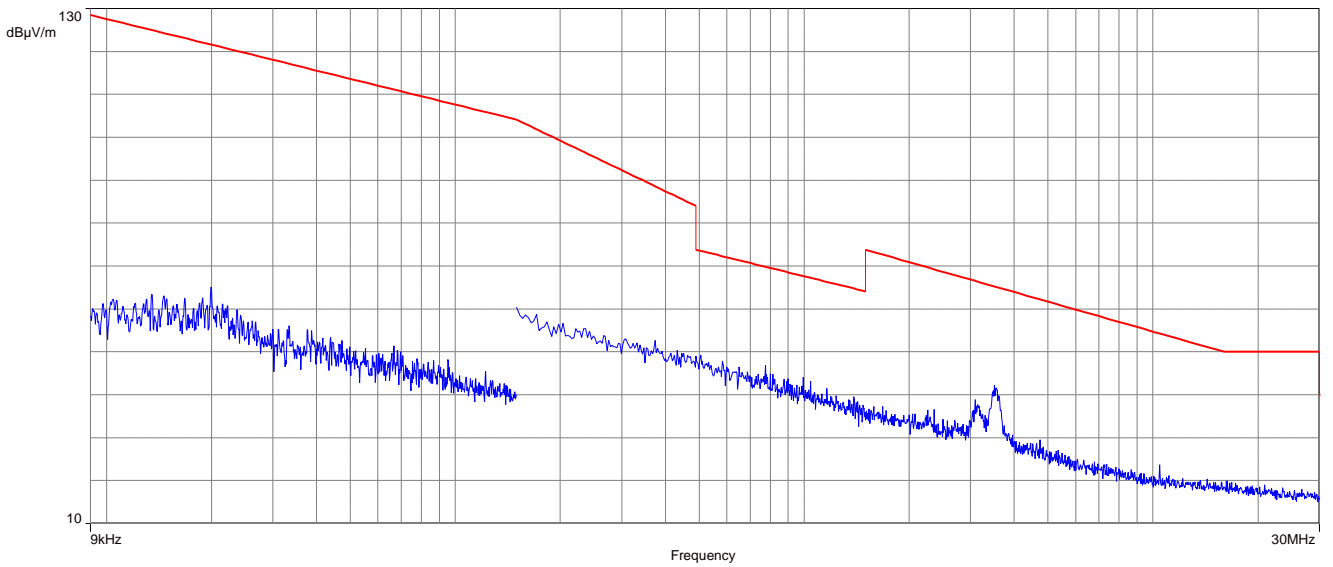

Plot No. 5: 9 kHz to 30 MHz, horizontal/vertical polarization, f_{mid}

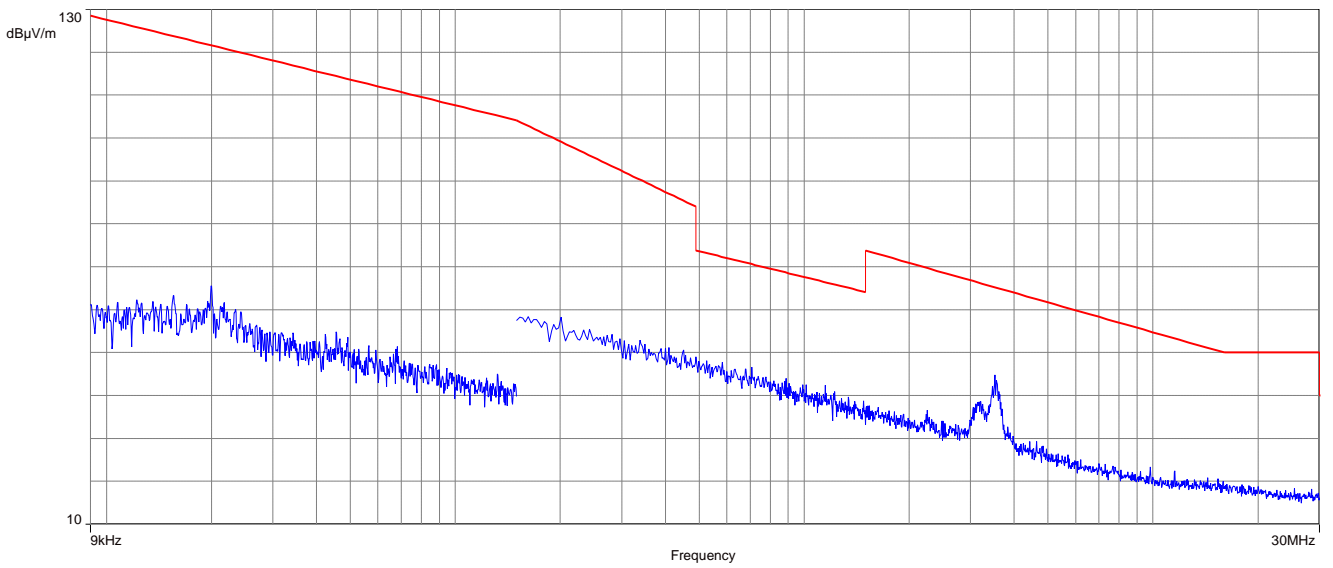

Plot No. 6: 9 kHz to 30 MHz, horizontal/vertical polarization, f_{high}

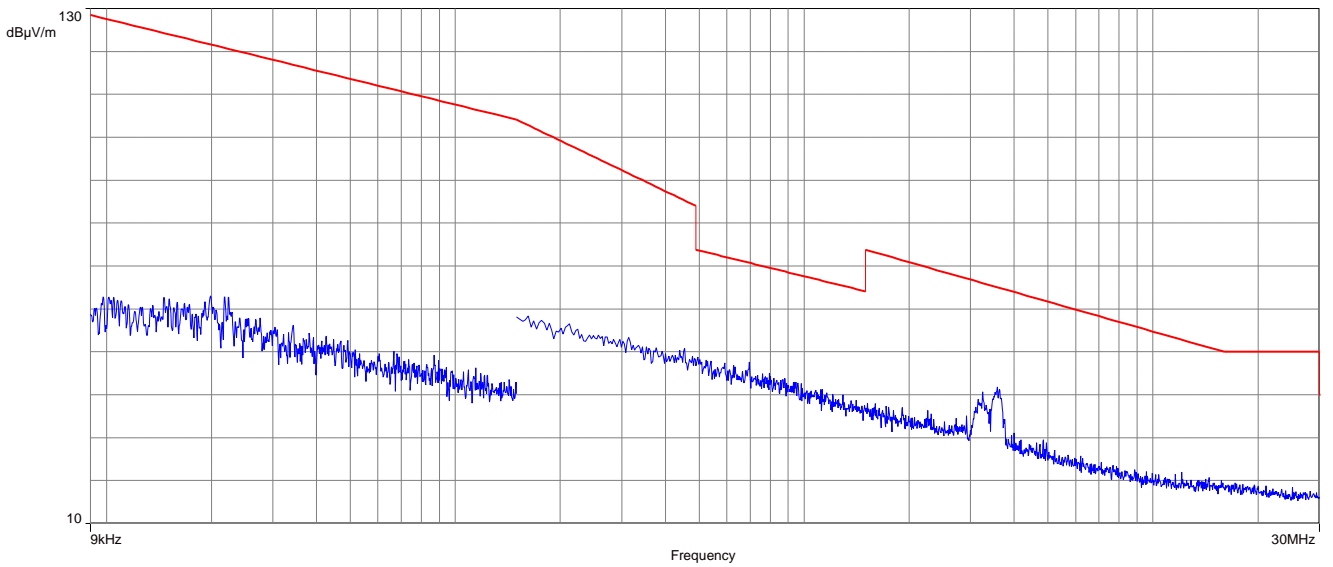

Plot No. 7: 9 kHz to 30 MHz, horizontal/vertical polarization, dBµA, f_{low}

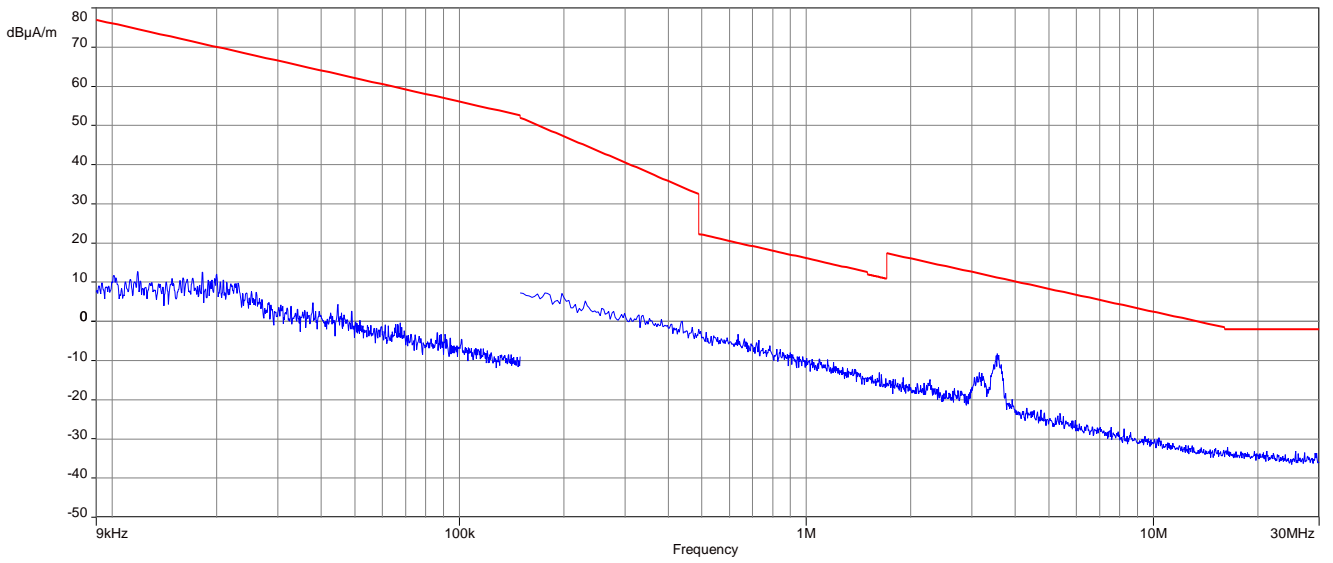

Plot No. 8: 9 kHz to 30 MHz, horizontal/vertical polarization, dB μ A, f_{mid}

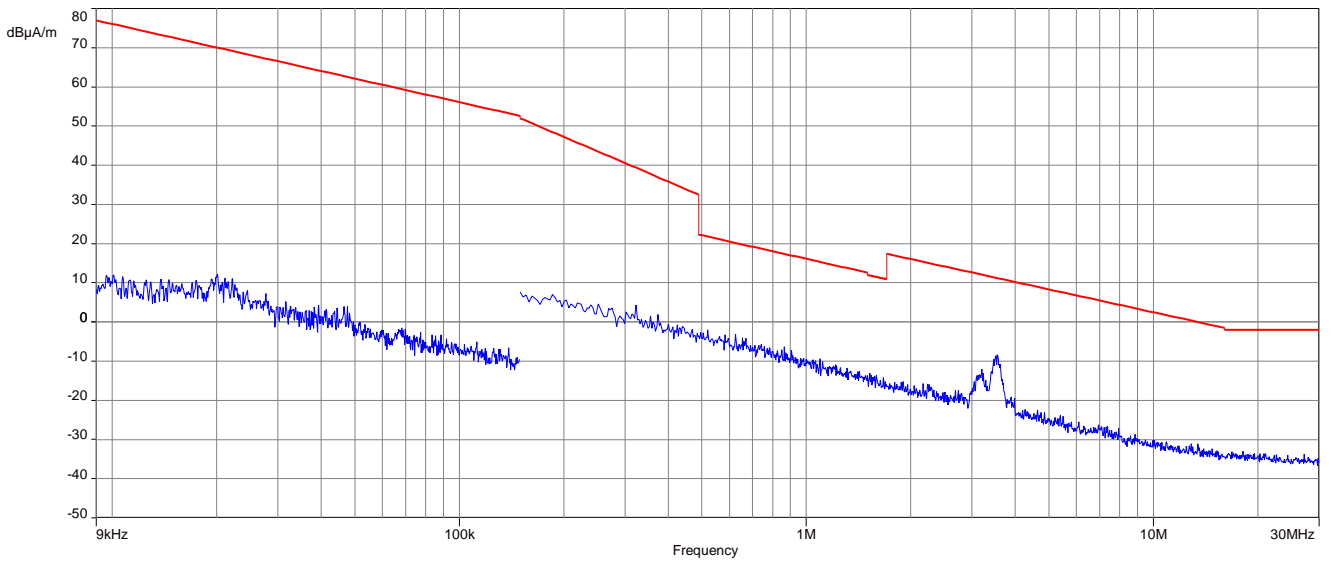

Plot No. 9: 9 kHz to 30 MHz, horizontal/vertical polarization, dB μ A, f_{high}

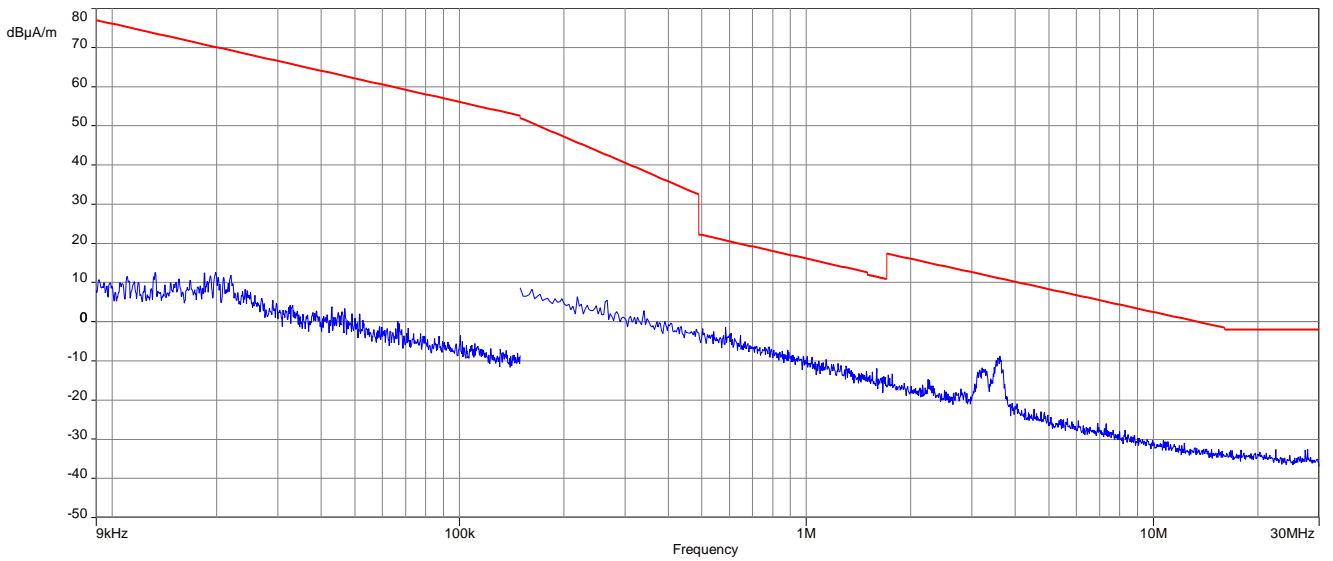

Plot No. 10: 30 MHz to 1 GHz, horizontal/vertical polarization, low channel

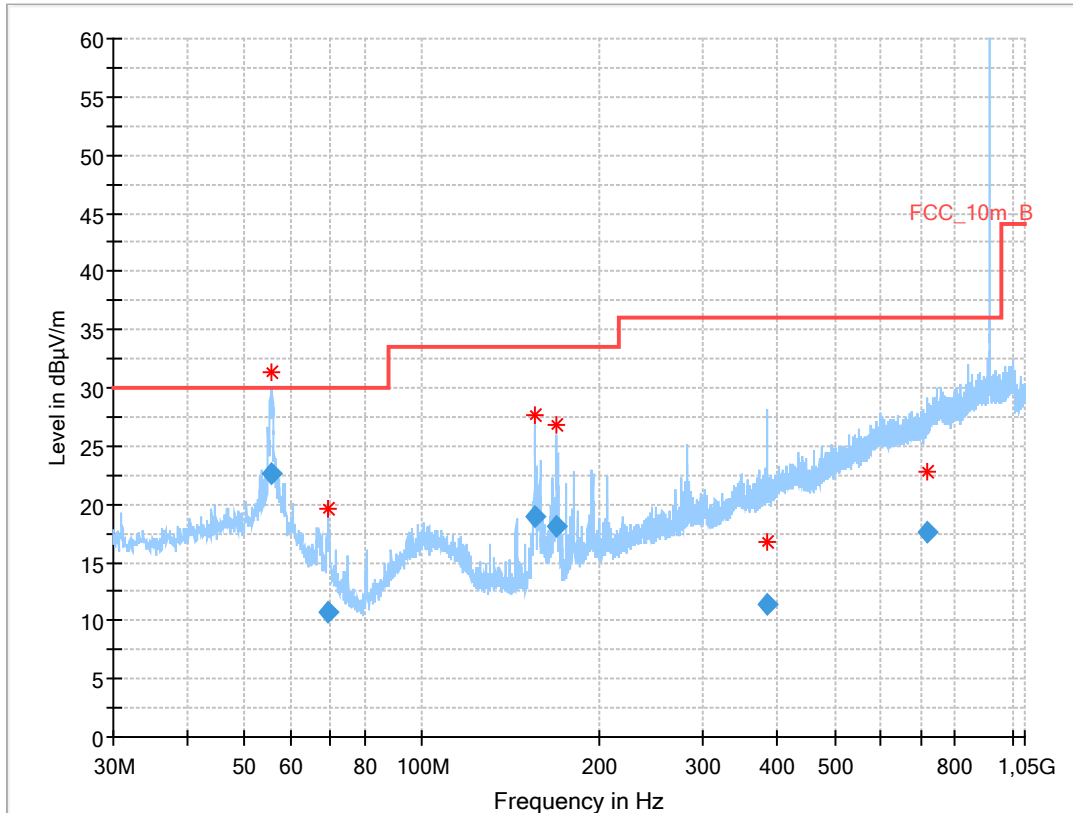

*Z-wave carrier shown at 903 MHz, therefore considered passed
*Red stars = Frequency markers; Blue markers = QuasiPeak values

Final Result

Frequency (MHz)	QuasiPeak (dBµV/m)	Limit (dBµV/m)	Margin (dB)	Meas. Time (ms)	Bandwidth (kHz)	Height (cm)	Pol	Azimuth (deg)	Corr. (dB/m)
55.448	22.70	30.0	7.3	1000	120.0	136.0	V	232	15
69.538	10.69	30.0	19.3	1000	120.0	183.0	V	280	10
155.424	18.96	33.5	14.5	1000	120.0	103.0	V	24	9
169.533	18.08	33.5	15.4	1000	120.0	101.0	V	0	10
384.076	11.44	36.0	24.6	1000	120.0	341.0	H	225	16
717.895	17.55	36.0	18.5	1000	120.0	264.0	V	207	21

Plot No. 11: 30 MHz to 1 GHz, horizontal/vertical polarization, mid channel

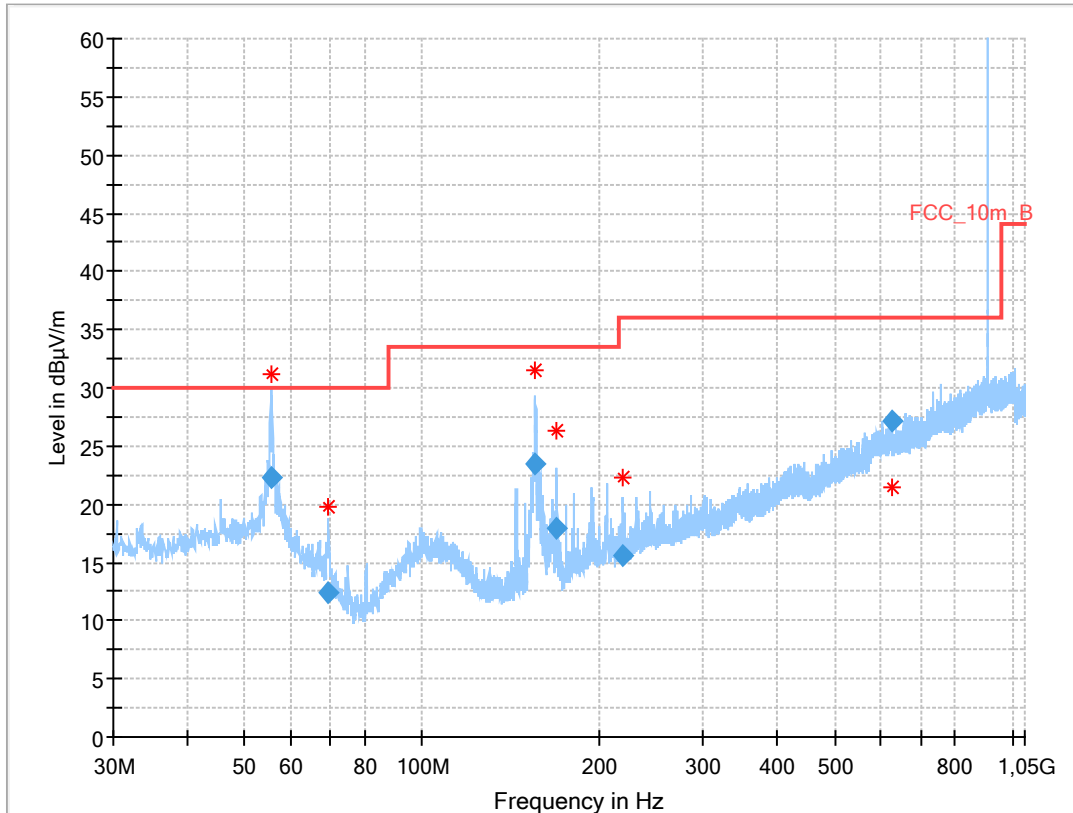

*Z-wave carrier shown at 903 MHz, therefore considered passed
*Red stars = Frequency markers; Blue markers = QuasiPeak values

Final Result

Frequency (MHz)	QuasiPeak (dBµV/m)	Limit (dBµV/m)	Margin (dB)	Meas. Time (ms)	Bandwidth (kHz)	Height (cm)	Pol	Azimuth (deg)	Corr. (dB/m)
55.756	22.25	30.0	7.8	1000	120.0	170.0	V	78	15
69.251	12.45	30.0	17.6	1000	120.0	170.0	V	247	10
155.460	23.38	33.5	10.1	1000	120.0	98.0	V	68	9
169.249	17.97	33.5	15.5	1000	120.0	102.0	V	75	10
219.239	15.65	36.0	20.4	1000	120.0	98.0	V	79	12
624.481	27.19	36.0	8.8	1000	120.0	170.0	H	157	21

Plot No. 12: 30 MHz to 1 GHz, horizontal/vertical polarization, high channel

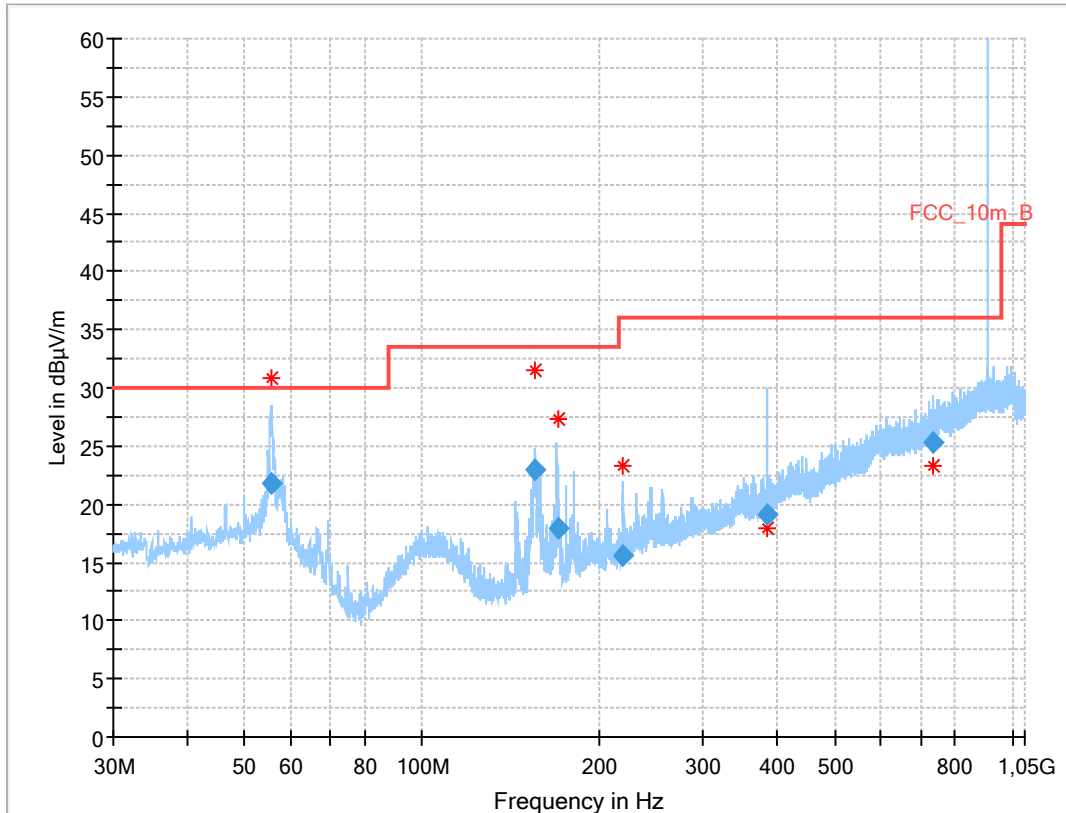

*Z-wave carrier shown at 903 MHz, therefore considered passed
*Red stars = Frequency markers; Blue markers = QuasiPeak values

Final Result

Frequency (MHz)	QuasiPeak (dBµV/m)	Limit (dBµV/m)	Margin (dB)	Meas. Time (ms)	Bandwidth (kHz)	Height (cm)	Pol	Azimuth (deg)	Corr. (dB/m)
55.781	21.77	30.0	8.2	1000	120.0	133.0	V	292	15
155.452	22.98	33.5	10.5	1000	120.0	98.0	V	176	9
169.567	17.93	33.5	15.6	1000	120.0	101.0	V	292	10
219.547	15.51	36.0	20.5	1000	120.0	101.0	V	171	12
383.880	19.11	36.0	16.9	1000	120.0	170.0	H	67	16
734.513	25.23	36.0	10.8	1000	120.0	170.0	V	-22	22

Plot No. 13: 1 GHz to 18 GHz, horizontal/vertical polarization, f_{low}

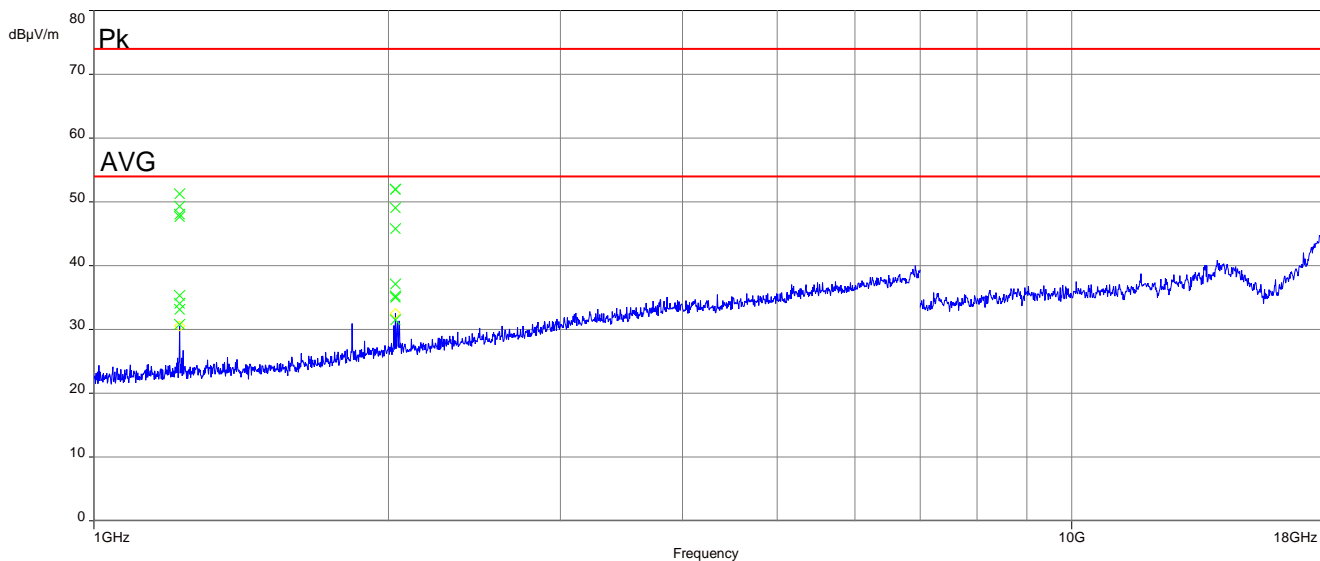

*shown trace: peak-prescan

Plot No. 14: 1 GHz to 18 GHz, horizontal/vertical polarization, f_{mid}

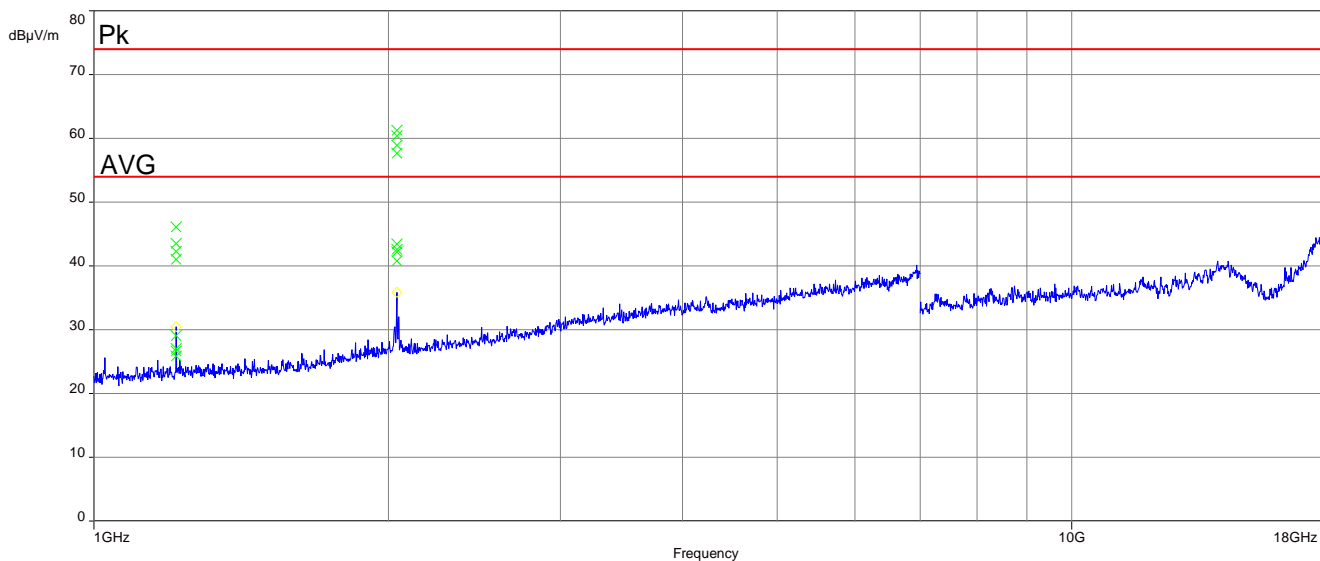

*shown trace: peak-prescan

Plot No. 15: 1 GHz to 18 GHz, horizontal/vertical polarization, f_{high}

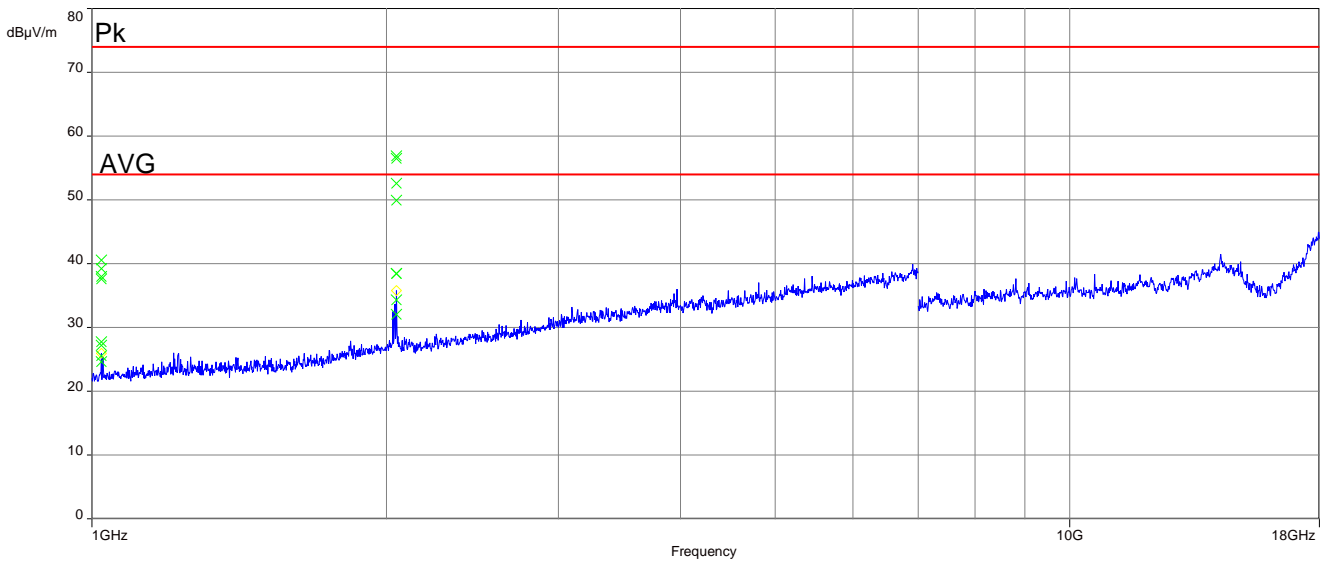

*shown trace: peak-prescan

Plot No. 16: 18 GHz to 40 GHz, horizontal/vertical polarization, low channel

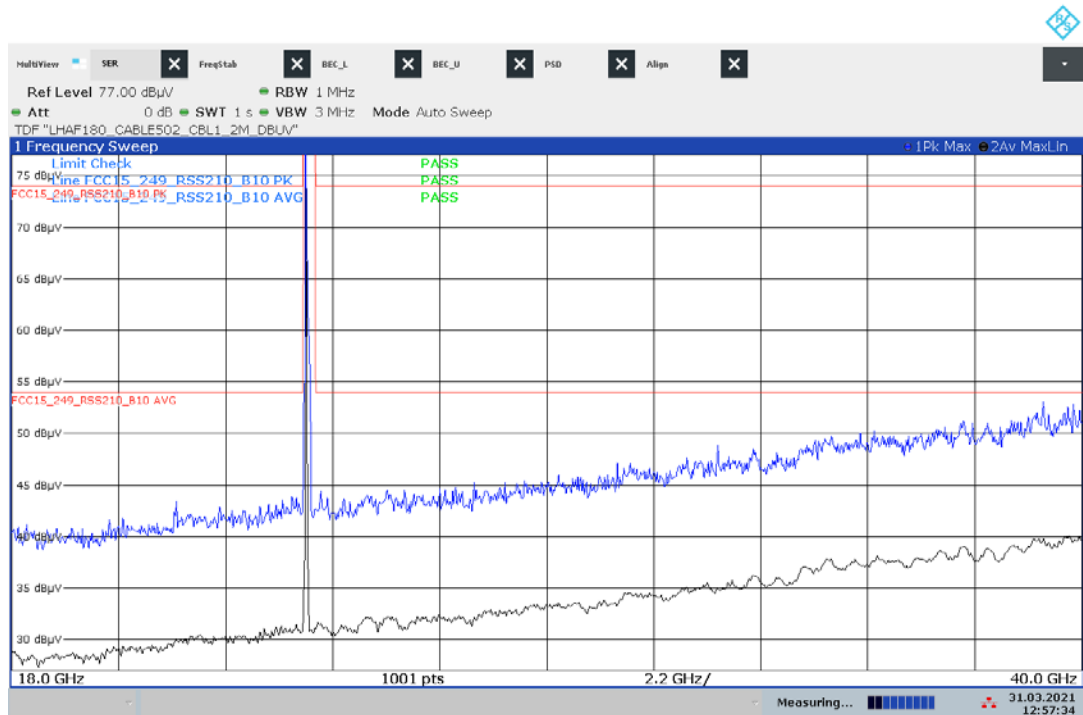

Plot No. 17: 18 GHz to 40 GHz, horizontal/vertical polarization, mid channel

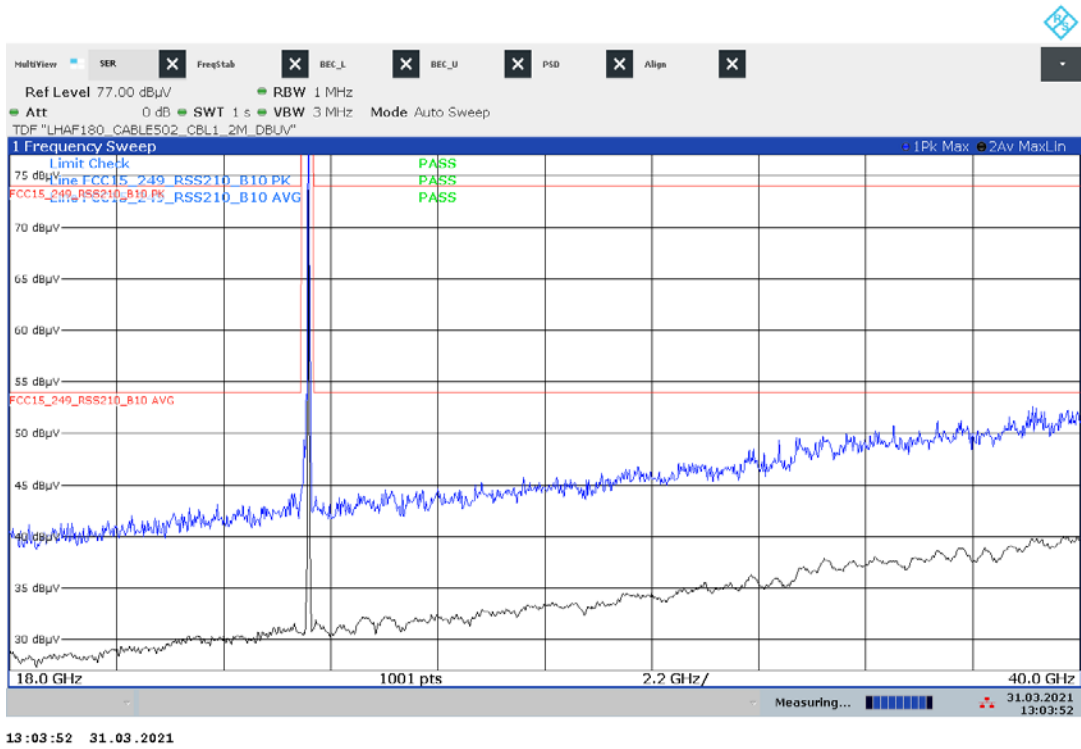

Plot No. 18: 26.5 GHz to 40 GHz, horizontal/vertical polarization, high channel

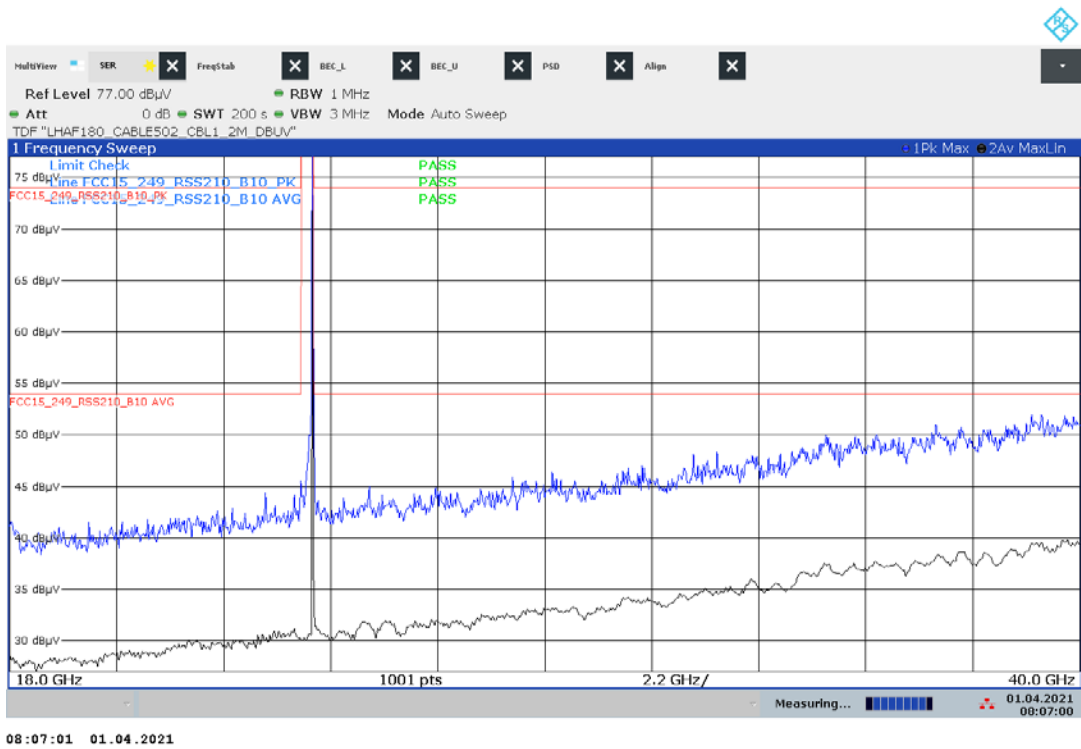

Plot No. 19: 40 GHz to 50 GHz, horizontal/vertical polarization, low channel

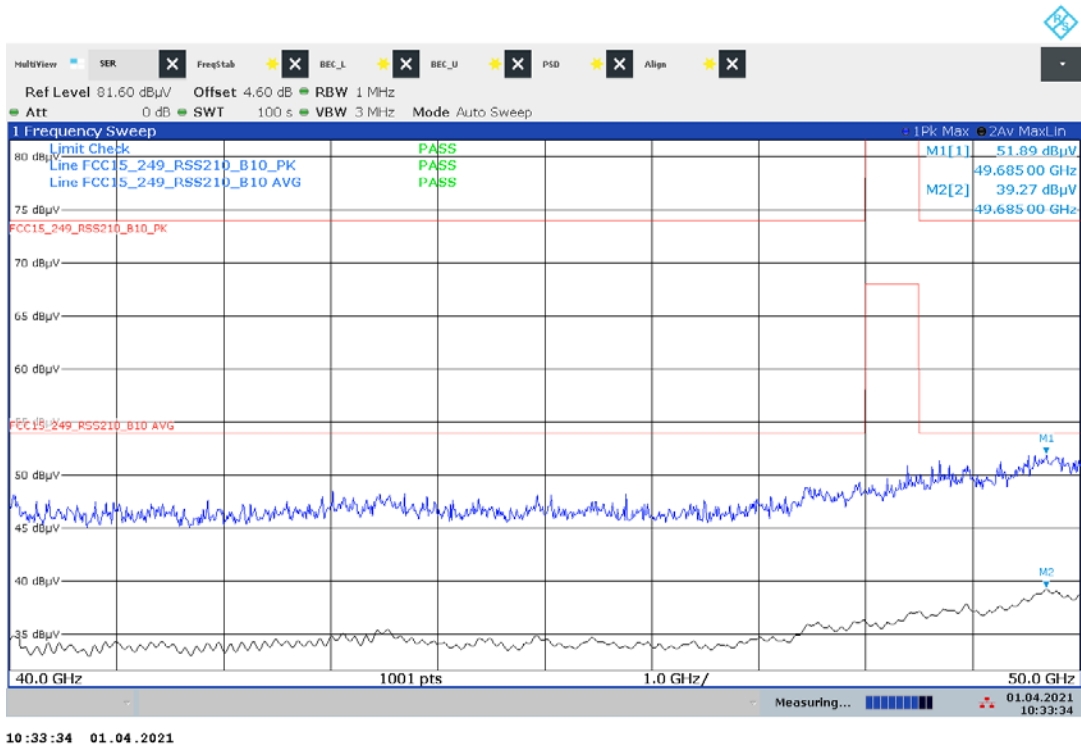

Plot No. 20: 40 GHz to 50 GHz, horizontal/vertical polarization, mid channel

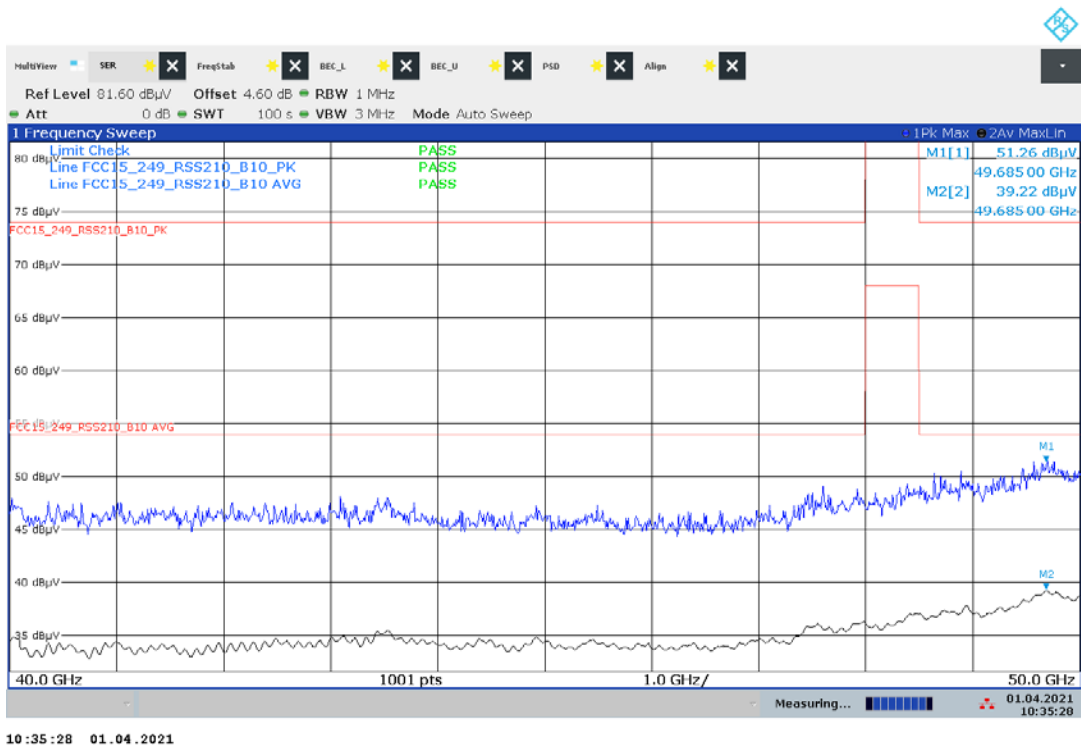

Plot No. 21: 40 GHz to 50 GHz, horizontal/vertical polarization, high channel

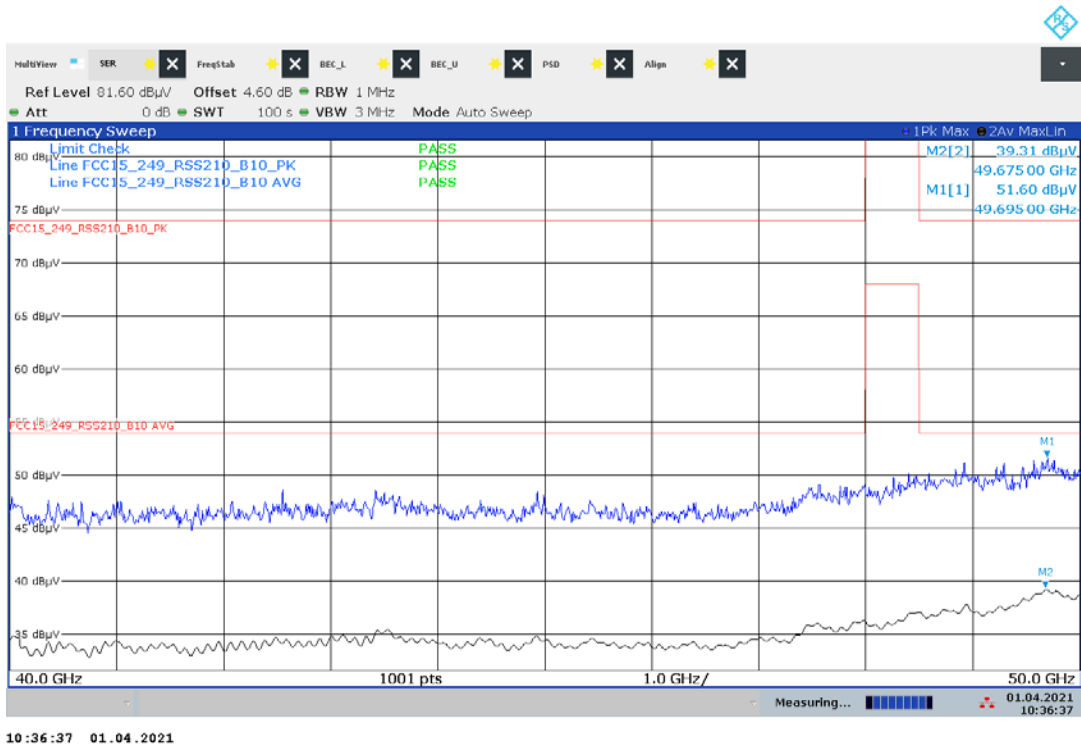

Plot No. 22: 50 GHz to 75 GHz, horizontal/vertical polarization, low channel

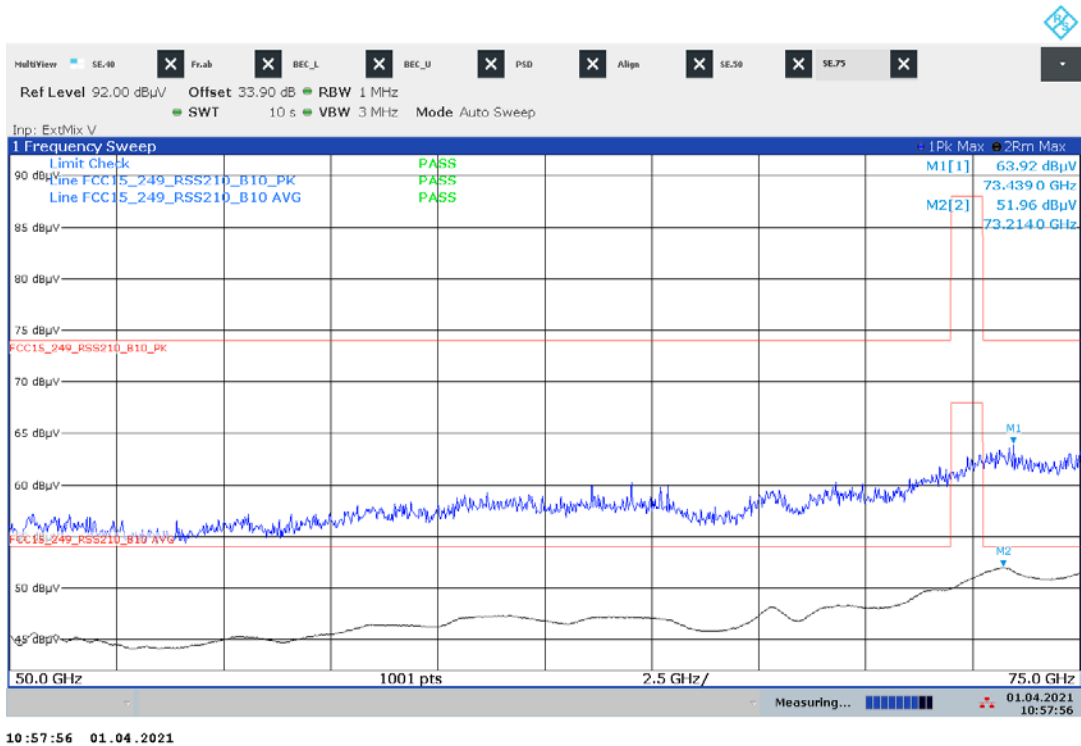

Plot No. 23: 50 GHz to 75 GHz, horizontal/vertical polarization, mid channel



Plot No. 24: 50 GHz to 75 GHz, horizontal/vertical polarization, high channel



Plot No. 25: 75 GHz to 100 GHz, horizontal/vertical polarization, low channel

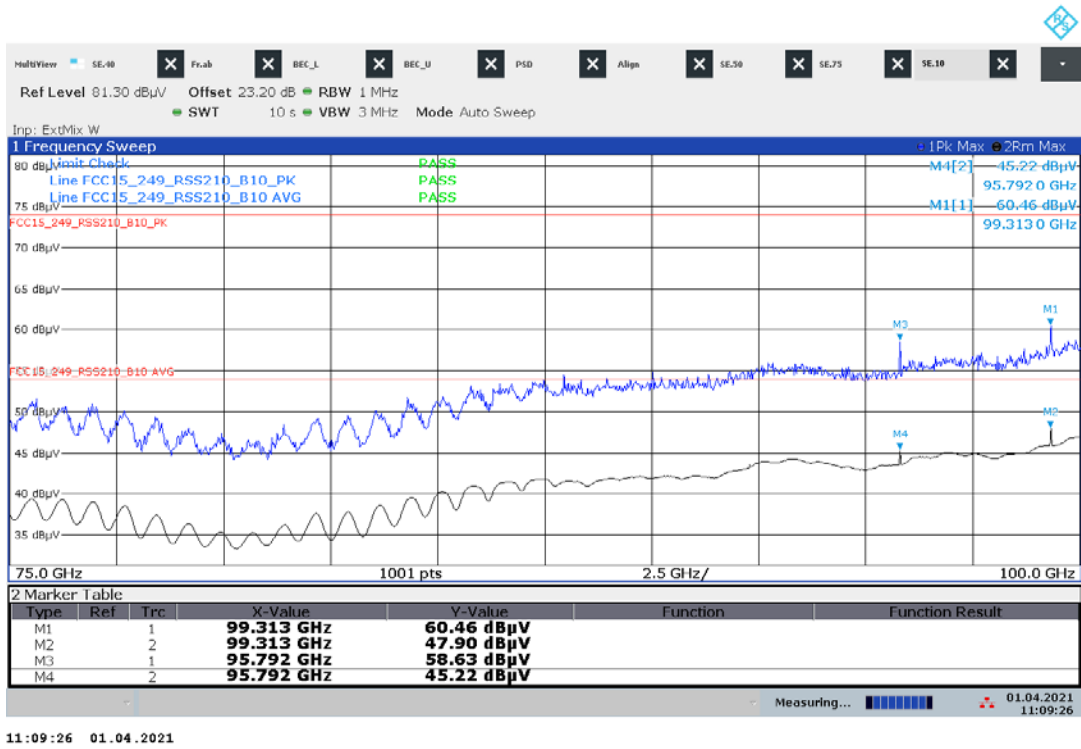

Plot No. 26: 75 GHz to 100 GHz, horizontal/vertical polarization, mid channel

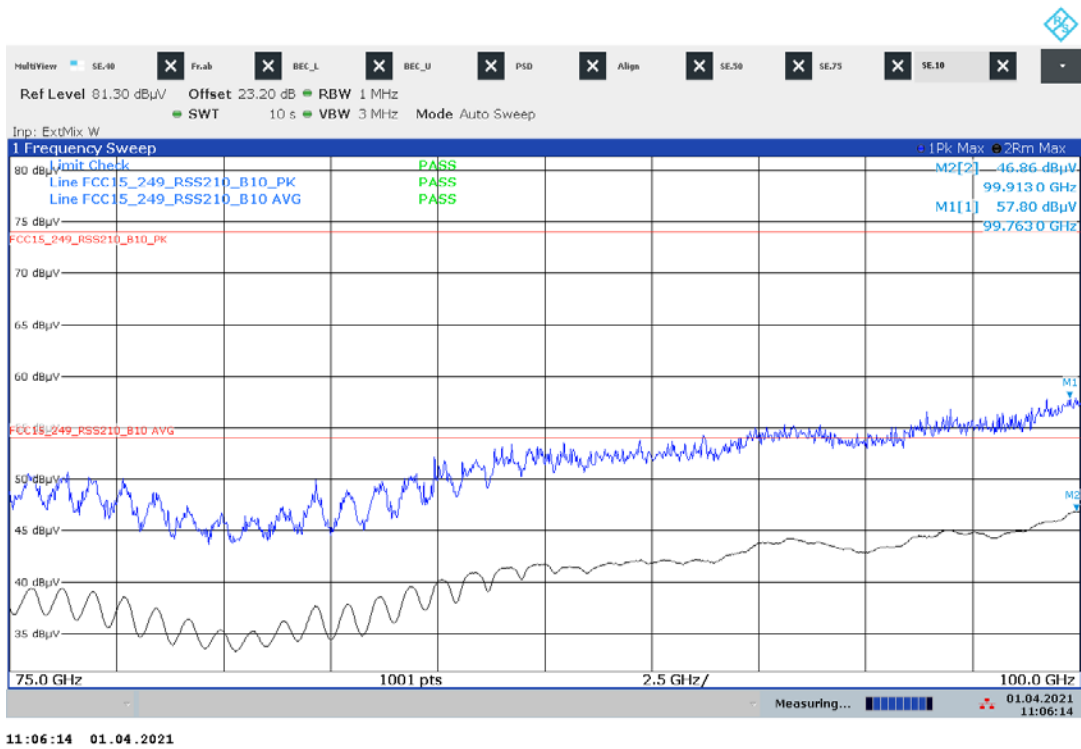

Plot No. 27: 75 GHz to 100 GHz, horizontal/vertical polarization, high channel

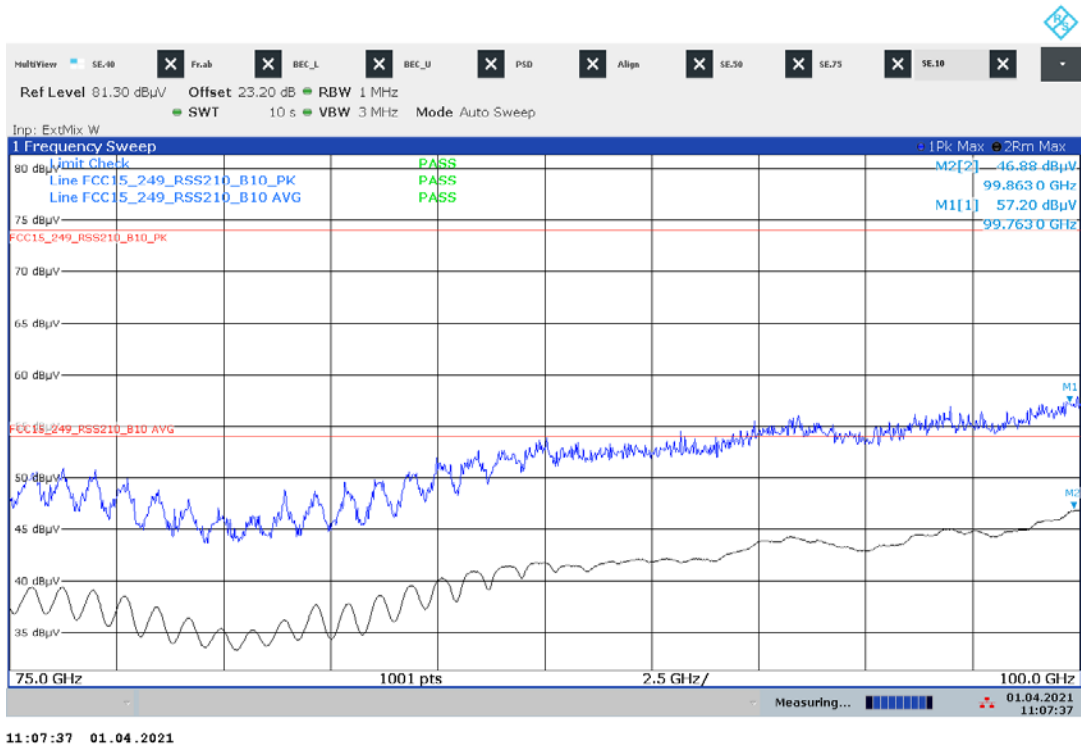

Plot No. 28: Band-Edge-Compliance, low frequency mode, low edge

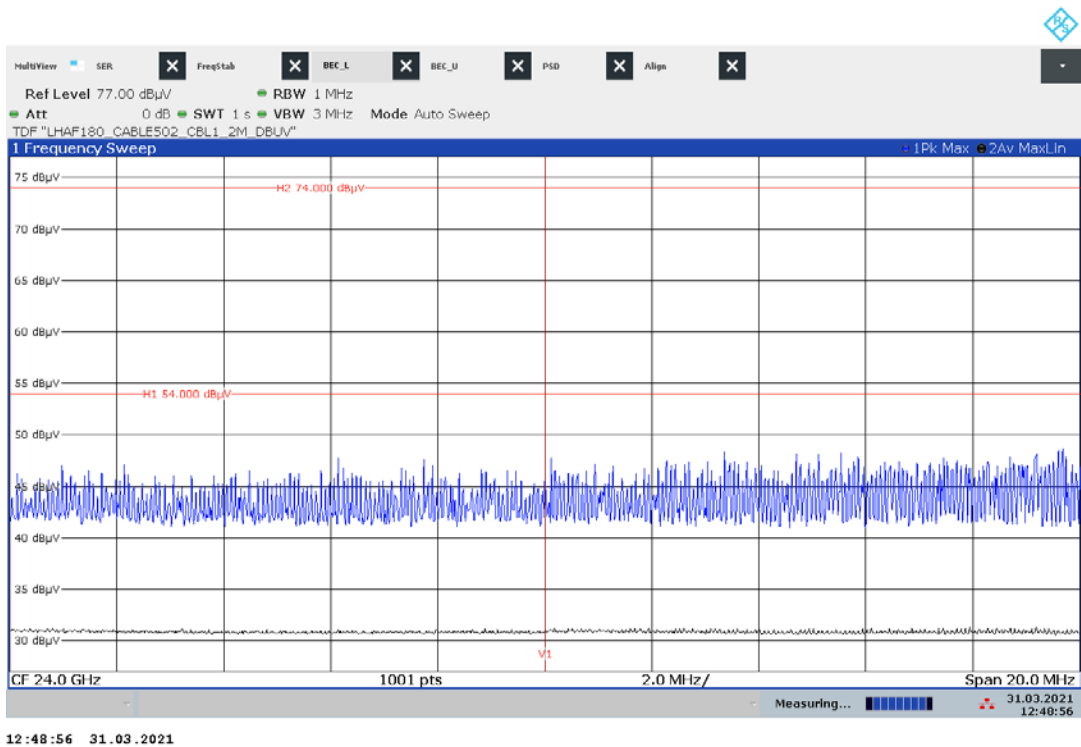

Plot No. 29: Band-Edge-Compliance, low frequency mode, upper edge

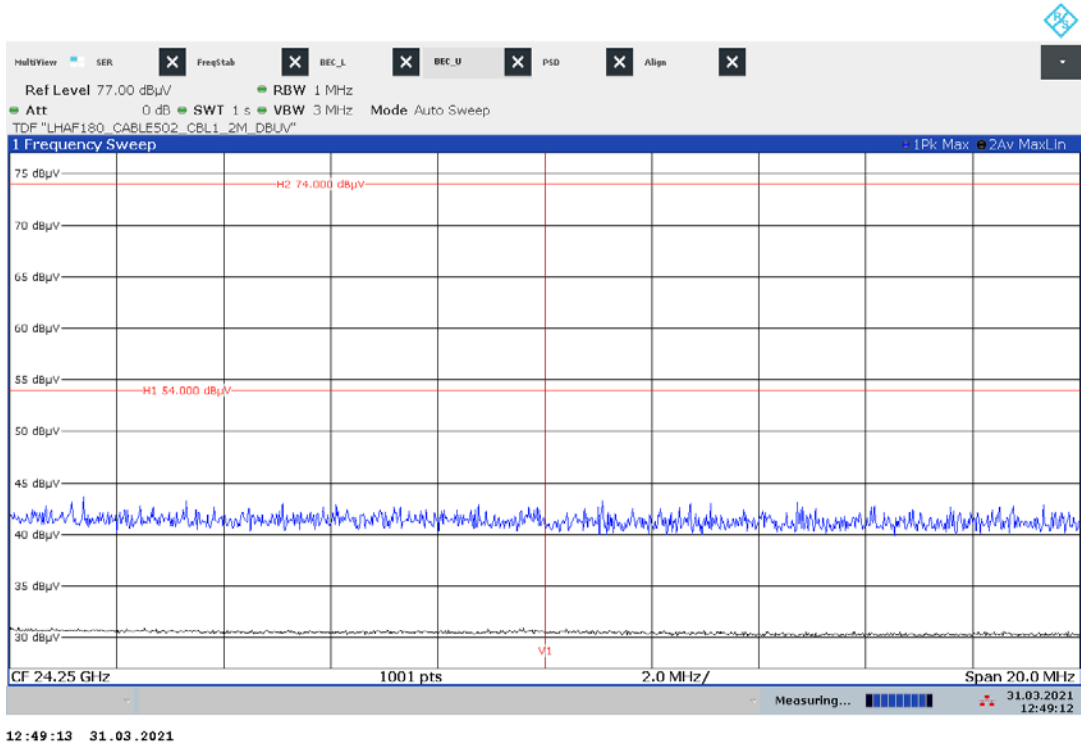

Plot No. 30: Band-Edge-Compliance, middle frequency mode, low edge

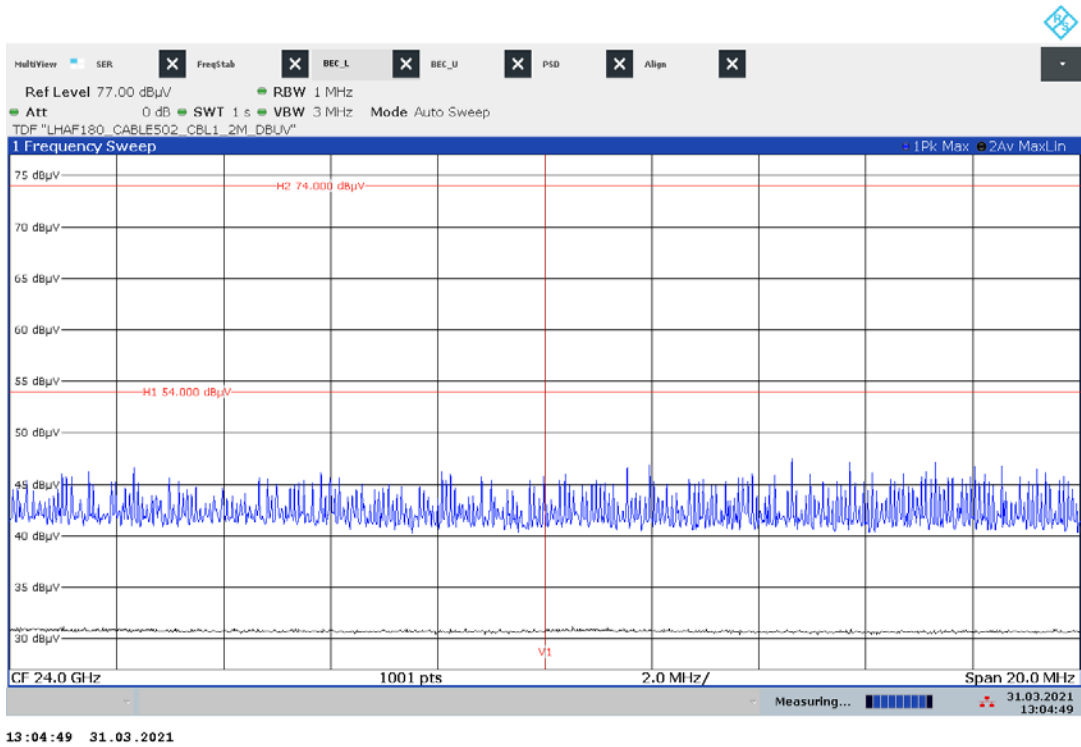

Plot No. 31: Band-Edge-Compliance, middle frequency mode, upper edge

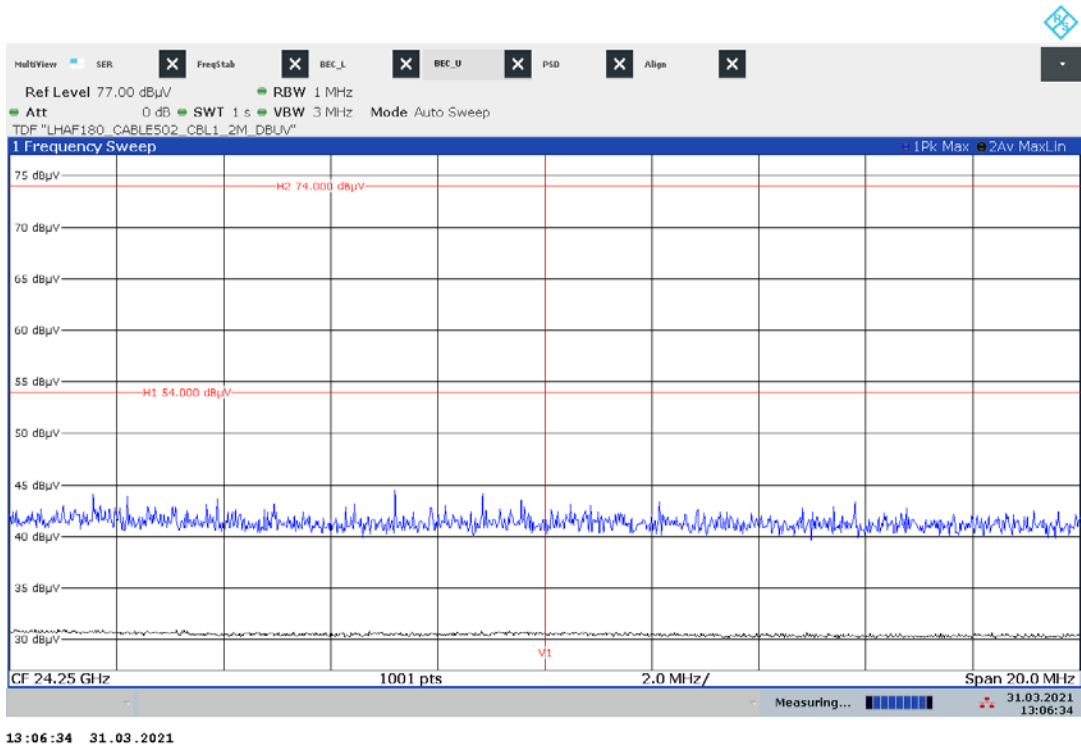

Plot No. 32: Band-Edge-Compliance, high frequency mode, low edge

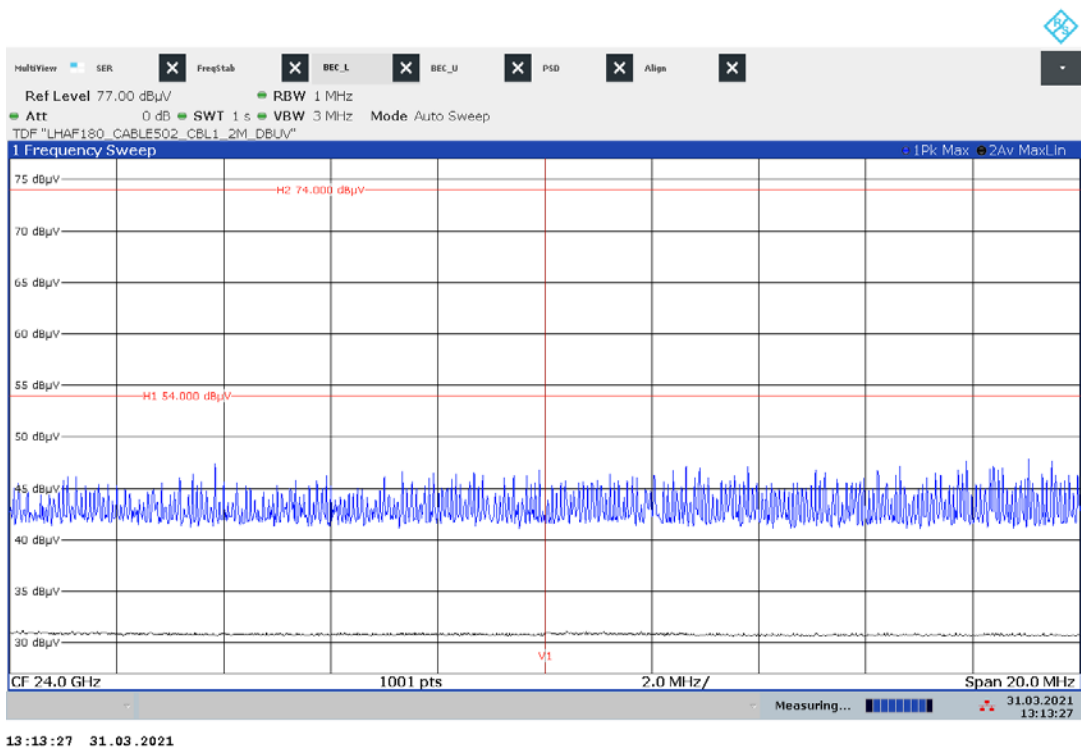

Plot No. 33: Band-Edge-Compliance, high frequency mode, upper edge

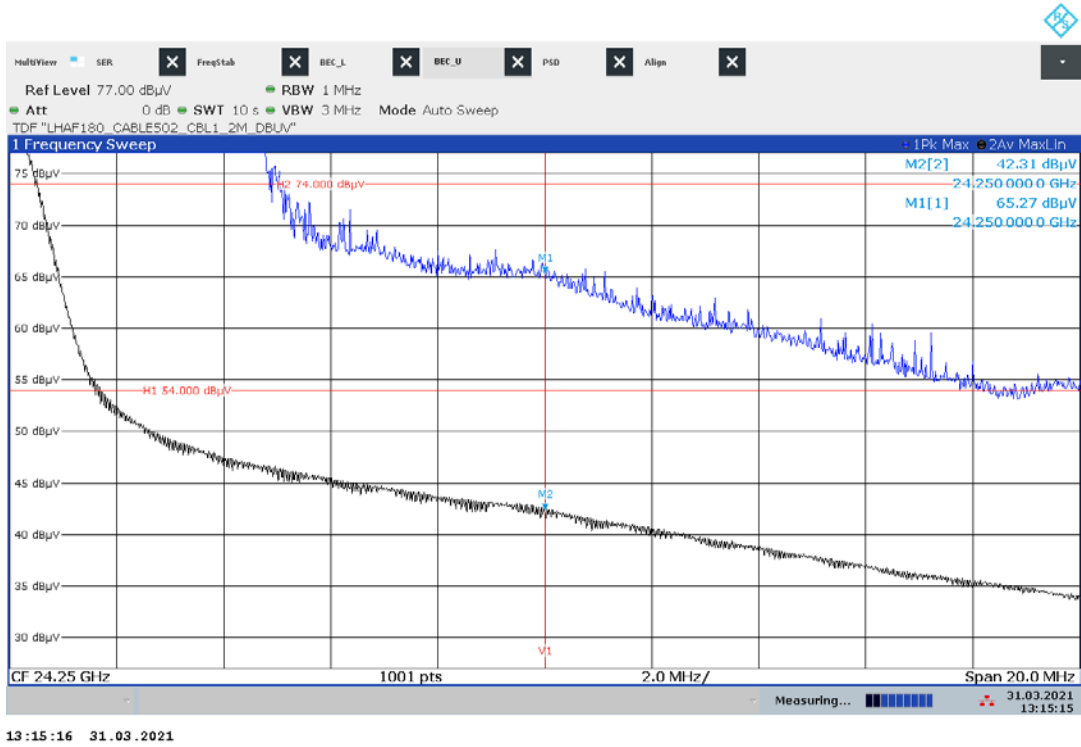

11.4 Conducted emissions < 30 MHz

Description:

Measurement of the conducted spurious emissions in transmit mode below 30 MHz. Both power lines, phase and neutral line, are measured. Found peaks are re-measured with average and quasi peak detection to show compliance to the limits.

Measurement:

Parameter	
Detector:	Peak - Quasi Peak / Average
Sweep time:	Auto
Video bandwidth:	F < 150 kHz: 200 Hz F > 150 kHz: 9 kHz
Resolution bandwidth:	F < 150 kHz: 1 kHz F > 150 kHz: 100 kHz
Span:	9 kHz to 30 MHz
Trace-Mode:	Max Hold

Limits:

FCC	IC	
CFR Part 15.207(a)	RSS-Gen 8.8	
Conducted Spurious Emissions < 30 MHz		
Frequency (MHz)	Quasi-Peak (dBµV/m)	Average (dBµV/m)
0.15 – 0.5	66 to 56*	56 to 46*
0.5 – 5	56	46
5 – 30.0	60	50

*Decreases with the logarithm of the frequency

Measurement results:

See plots below.

Plot 34: Phase line

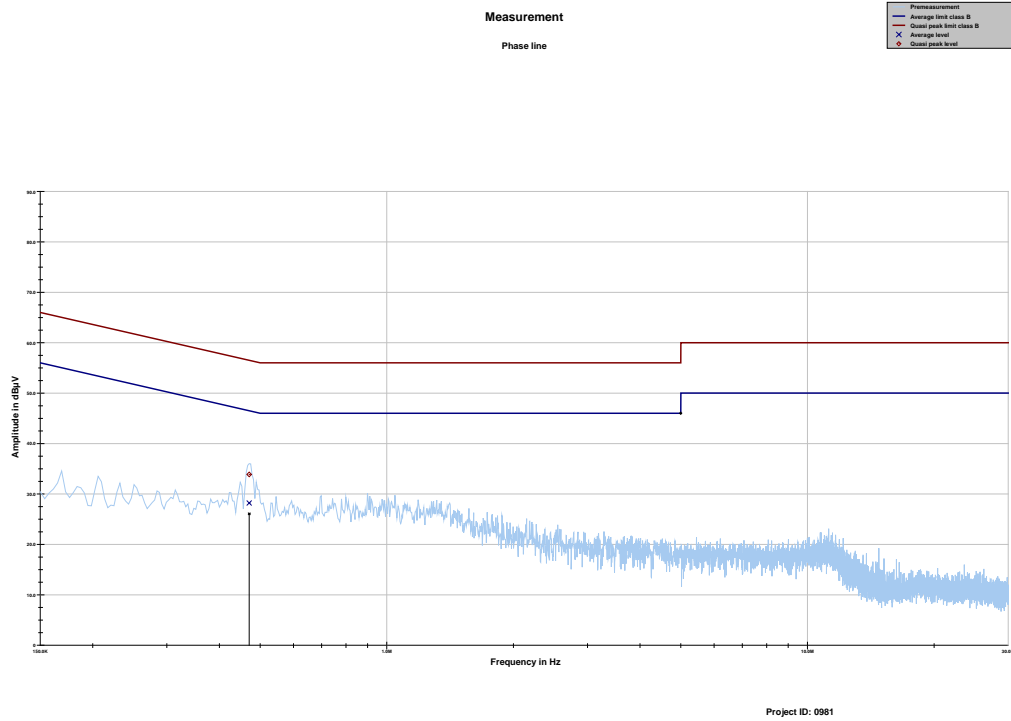

Frequency	Quasi peak level	Margin quasi peak	Limit QP	Average level	Margin average	Limit AV
MHz	dBµV	dB	dBµV	dBµV	dB	dBµV
0.470888	33.87	22.63	56.498	28.20	18.63	46.832

Plot 35: Neutral line

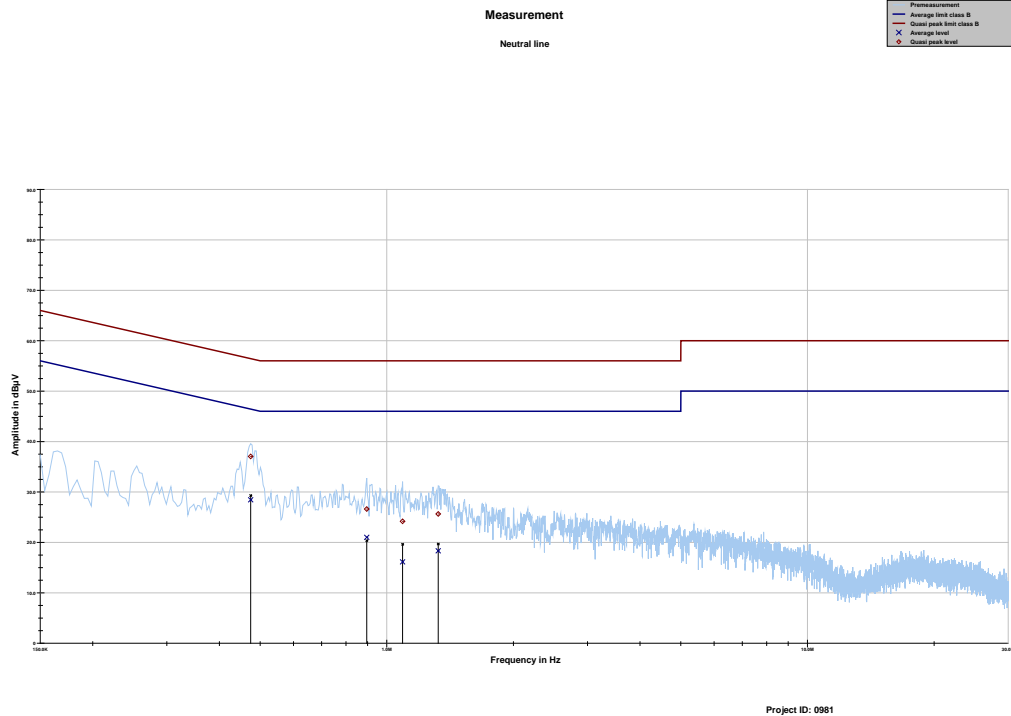

Frequency	Quasi peak level	Margin quasi peak	Limit QP	Average level	Margin Average	Limit AV
MHz	dBµV	dB	dBµV	dBµV	dB	dBµV
0.474619	37.04	19.40	56.433	28.45	18.28	46.725
0.896250	26.61	29.39	56.000	21.00	25.00	46.000
1.090275	24.18	31.82	56.000	16.12	29.88	46.000
1.325344	25.64	30.36	56.000	18.31	27.69	46.000

11.5 Frequency Stability

Description:

§15.215(c) Intentional radiators operating under the alternative provisions to the general emission limits, as contained in §§15.217 through 15.257 and in subpart E of this part, must be designed to ensure that the 20 dB bandwidth of the emission, or whatever bandwidth may otherwise be specified in the specific rule section under which the equipment operates, is contained within the frequency band designated in the rule section under which the equipment is operated. In the case of intentional radiators operating under the provisions of subpart E, the emission bandwidth may span across multiple contiguous frequency bands identified in that subpart. The requirement to contain the designated bandwidth of the emission within the specified frequency band includes the effects from frequency sweeping, frequency hopping and other modulation techniques that may be employed as well as the frequency stability of the transmitter over expected variations in temperature and supply voltage. If a frequency stability is not specified in the regulations, it is recommended that the fundamental emission be kept within at least the central 80% of the permitted band in order to minimize the possibility of out-of-band operation.

Measurement:

Parameter	
Detector:	Pos-Peak
Sweep time:	10 s
Resolution bandwidth:	1 MHz
Video bandwidth:	3 MHz
Trace-Mode:	Max Hold
Measurement uncertainty	Span/1000

Limits:

FCC	IC
CFR Part 15.215(c)	RSS-Gen 8.11
Frequency Stability	
As specified in Section 15.215(c), the bandwidth of the fundamental emission must be contained within the frequency band over the temperature range -20 to +50 degrees Celsius with an input voltage variation of 85% to 115% of rated input voltage.	

Measurement results:

Test Conditions	Frequency (GHz)	Bandwidth (MHz)
+5 °C / F_{low} / V_{nom}	24.054 (f_L), 24.063 (f_H)	9.66
+5 °C / F_{mid} / V_{nom}	24.143 (f_L), 24.154 (f_H)	10.23
+5 °C / F_{high} / V_{nom}	24.233 (f_L), 24.244 (f_H)	10.77
+15 °C / F_{low} / V_{nom}	24.053 (f_L), 24.063 (f_H)	10.20
+15 °C / F_{mid} / V_{nom}	24.143 (f_L), 24.154 (f_H)	10.50
+15 °C / F_{high} / V_{nom}	24.233 (f_L), 24.244 (f_H)	10.59
+20 °C / F_{low} / V_{min}	24.053 (f_L), 24.063 (f_H)	10.42
+20 °C / F_{mid} / V_{min}	24.143 (f_L), 24.153 (f_H)	10.68
+20 °C / F_{high} / V_{min}	24.233 (f_L), 24.244 (f_H)	10.71
+20 °C / F_{low} / V_{nom}	24.053 (f_L), 24.063 (f_H)	10.26
+20 °C / F_{mid} / V_{nom}	24.143 (f_L), 24.153 (f_H)	10.42
+20 °C / F_{high} / V_{nom}	24.233 (f_L), 24.244 (f_H)	10.67
+20 °C / F_{low} / V_{max}	24.253 (f_L), 24.063 (f_H)	10.40
+20 °C / F_{mid} / V_{max}	24.143 (f_L), 24.154 (f_H)	10.90
+20 °C / F_{high} / V_{max}	24.233 (f_L), 24.243 (f_H)	10.54
+25 °C / F_{low} / V_{nom}	24.053 (f_L), 24.063 (f_H)	10.41
+25 °C / F_{mid} / V_{nom}	24.143 (f_L), 24.153 (f_H)	10.31
+25 °C / F_{high} / V_{nom}	24.233 (f_L), 24.244 (f_H)	10.71
+35 °C / F_{low} / V_{nom}	24.053 (f_L), 24.063 (f_H)	10.38
+35 °C / F_{mid} / V_{nom}	24.143 (f_L), 24.154 (f_H)	10.59
+35 °C / F_{high} / V_{nom}	24.233 (f_L), 24.234 (f_H)	10.60

Plot 36: +5 °C, low frequency mode, V_{nom}

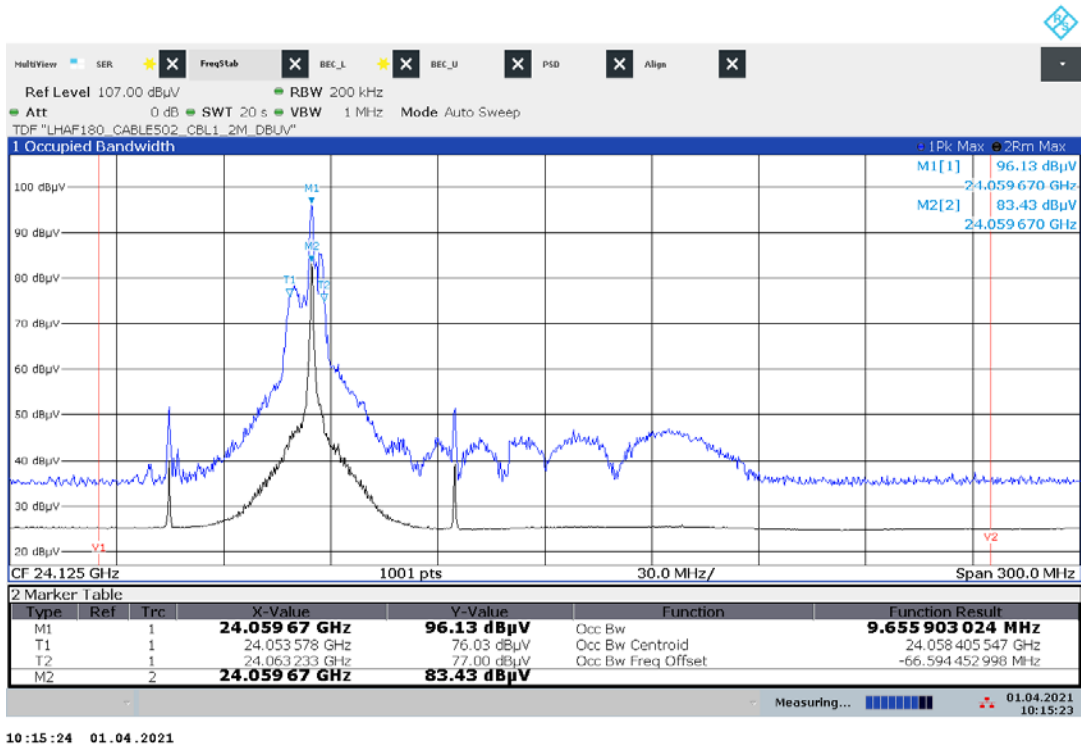

Plot 37: +5 °C, middle frequency mode, V_{nom}

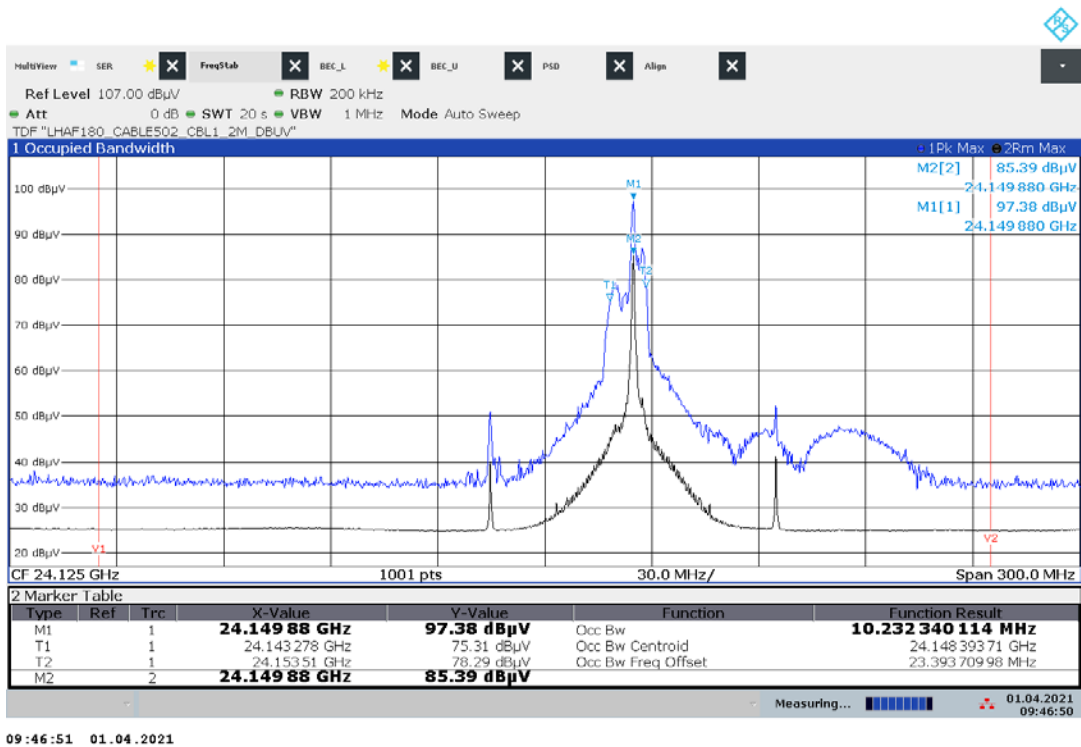

Plot 38: +5 °C, high frequency mode, V_{nom}

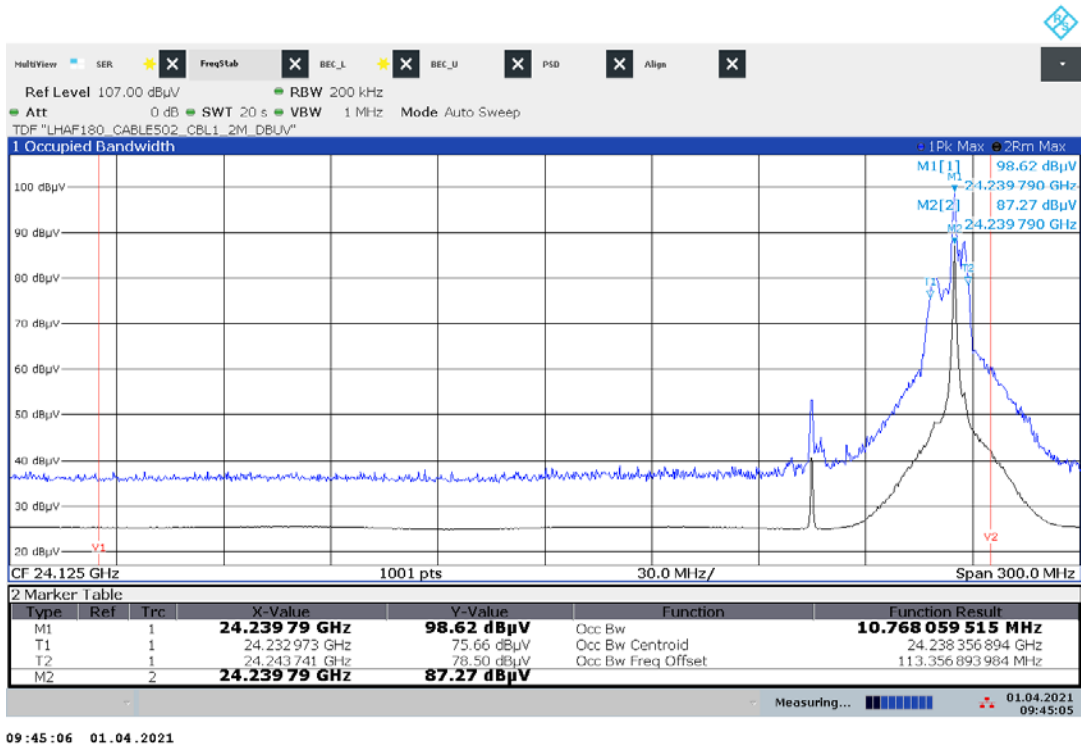

Plot 39: +15 °C, low frequency mode, V_{nom}

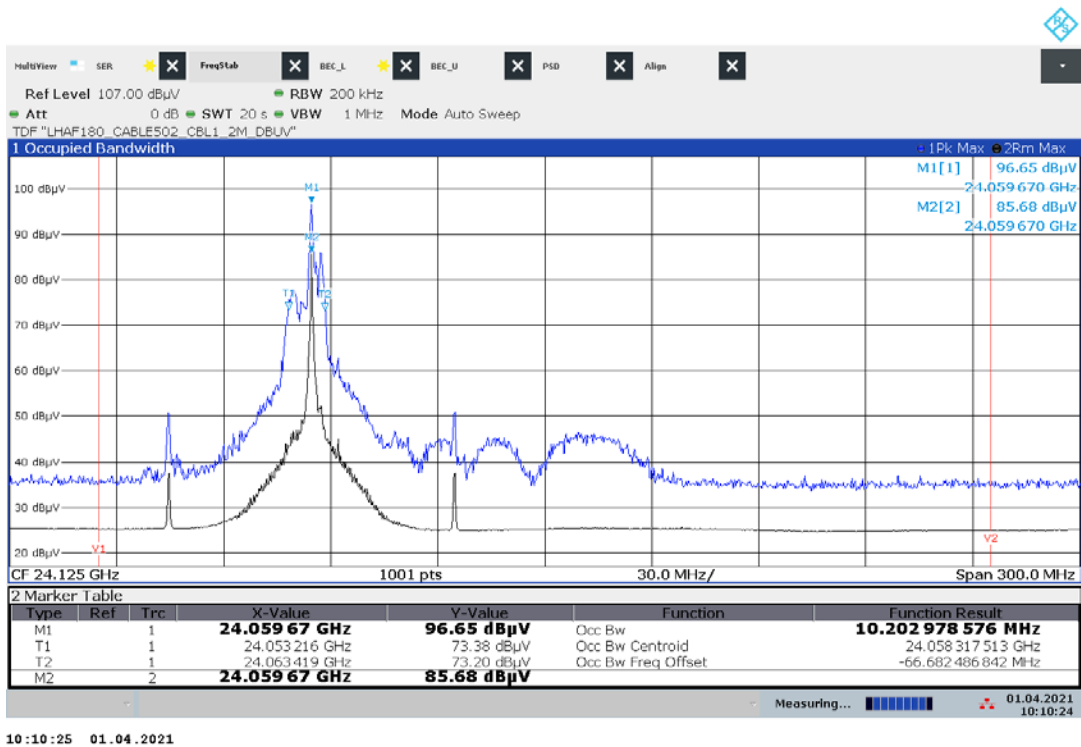

Plot 40: +15 °C, middle frequency mode, V_{nom}

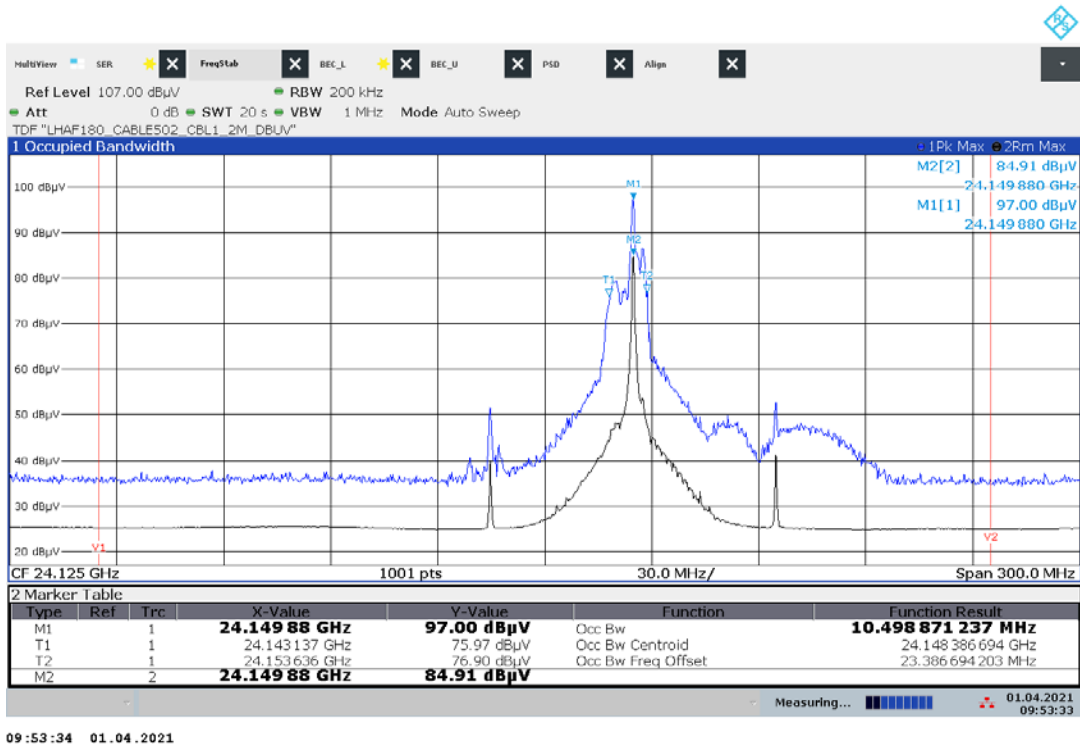

Plot 41: +15 °C, high frequency mode, V_{nom}

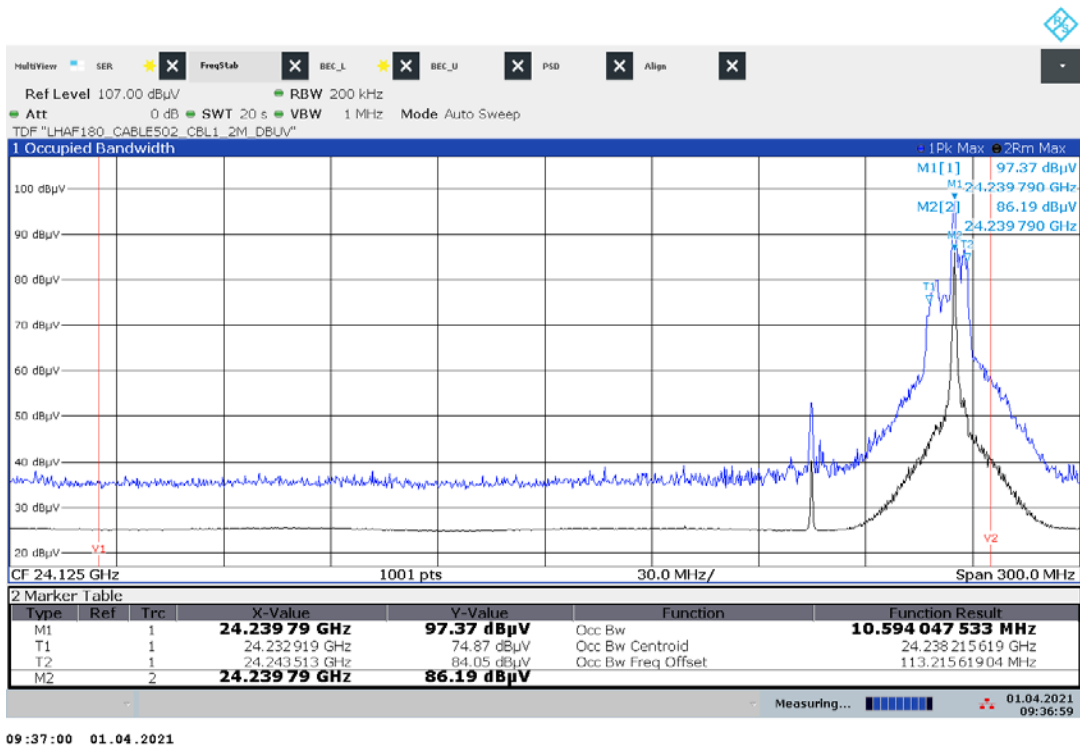

Plot 42: +20 °C, low frequency mode, V_{min}

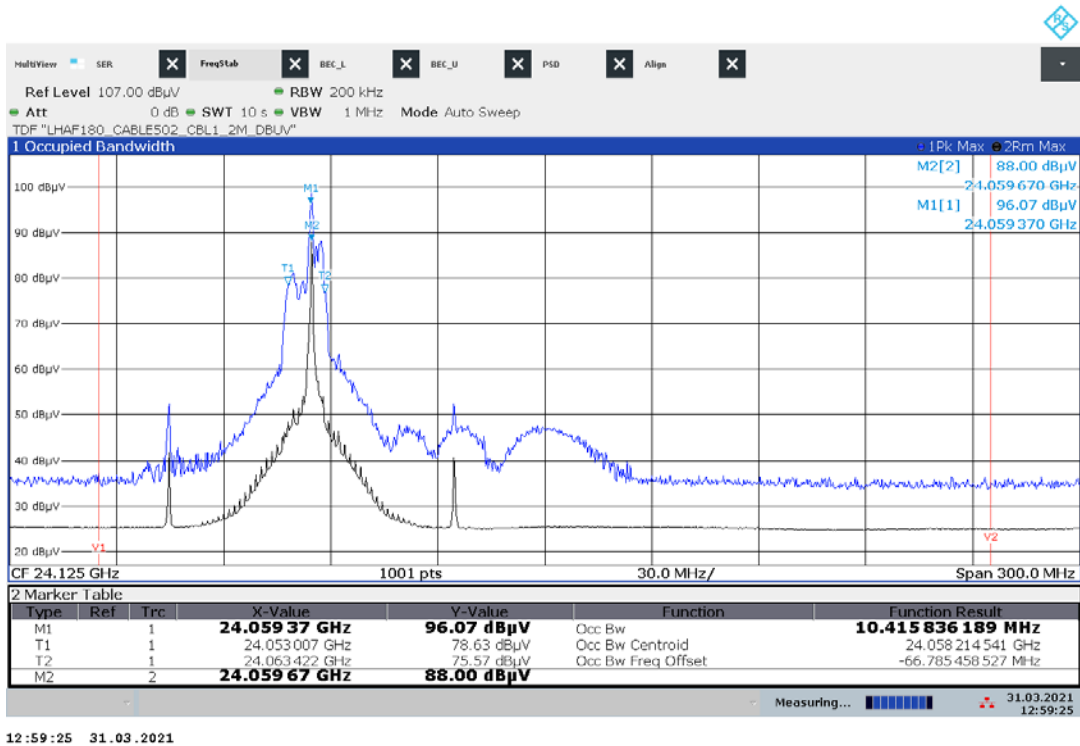

Plot 43: +20 °C, middle frequency mode, V_{min}

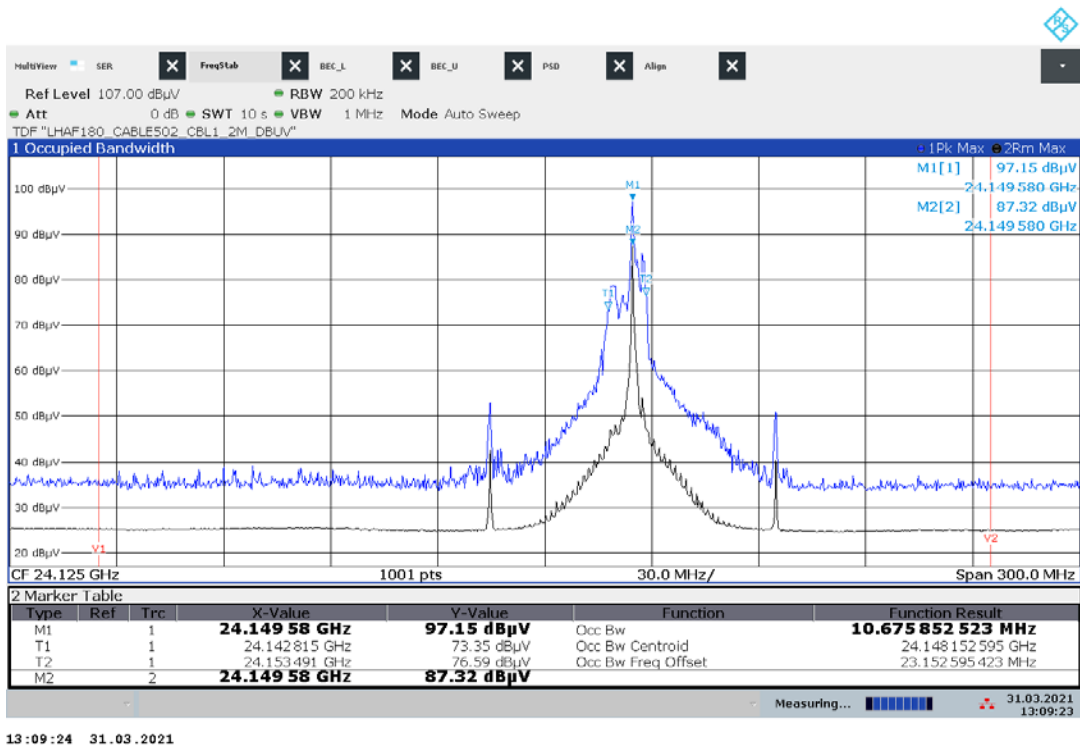

Plot 44: +20 °C, high frequency mode, V_{min}

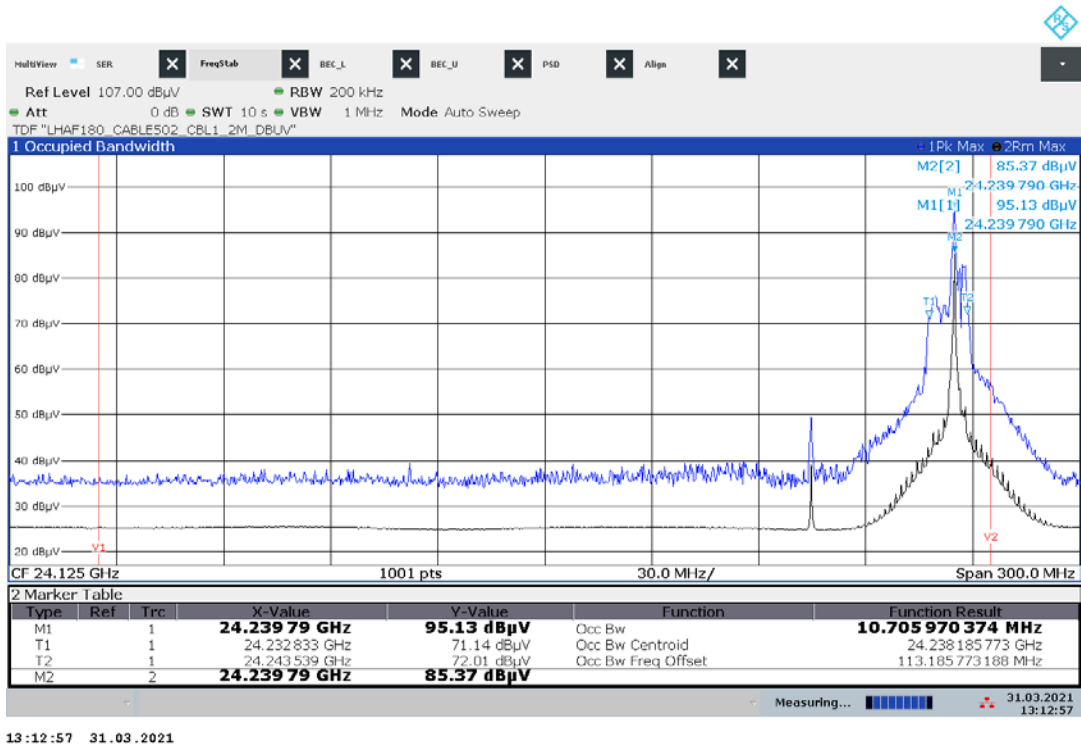

Plot 45: +20 °C, low frequency mode, V_{nom}

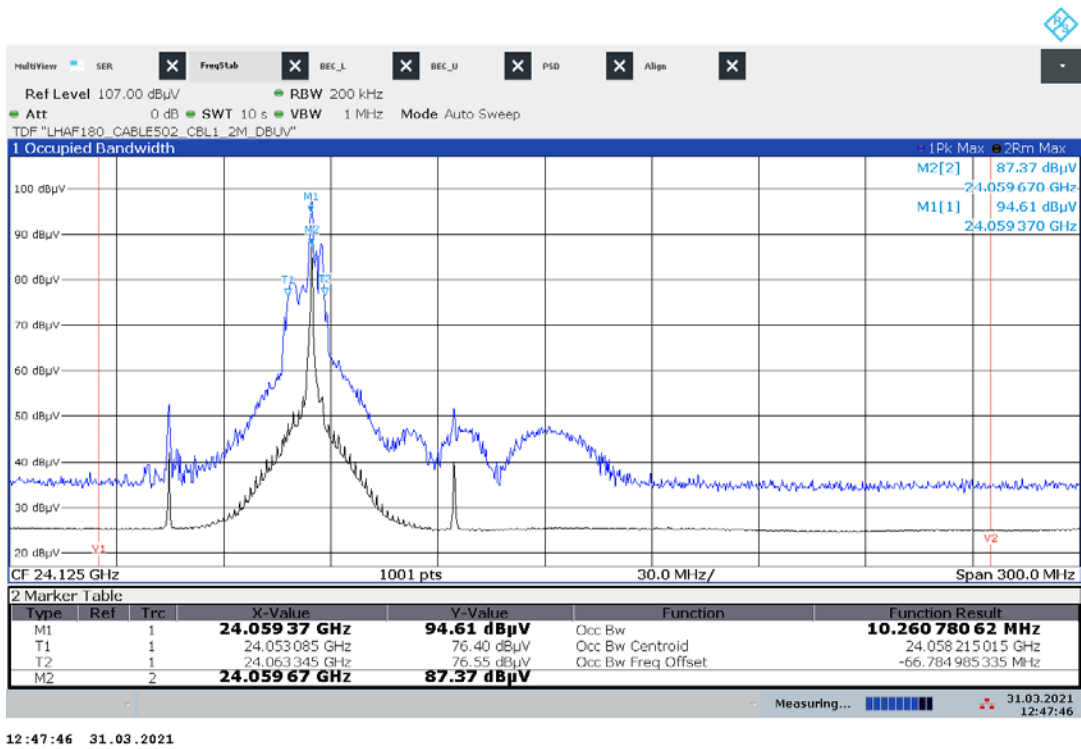

Plot 46: +20 °C, middle frequency mode, V_{nom}

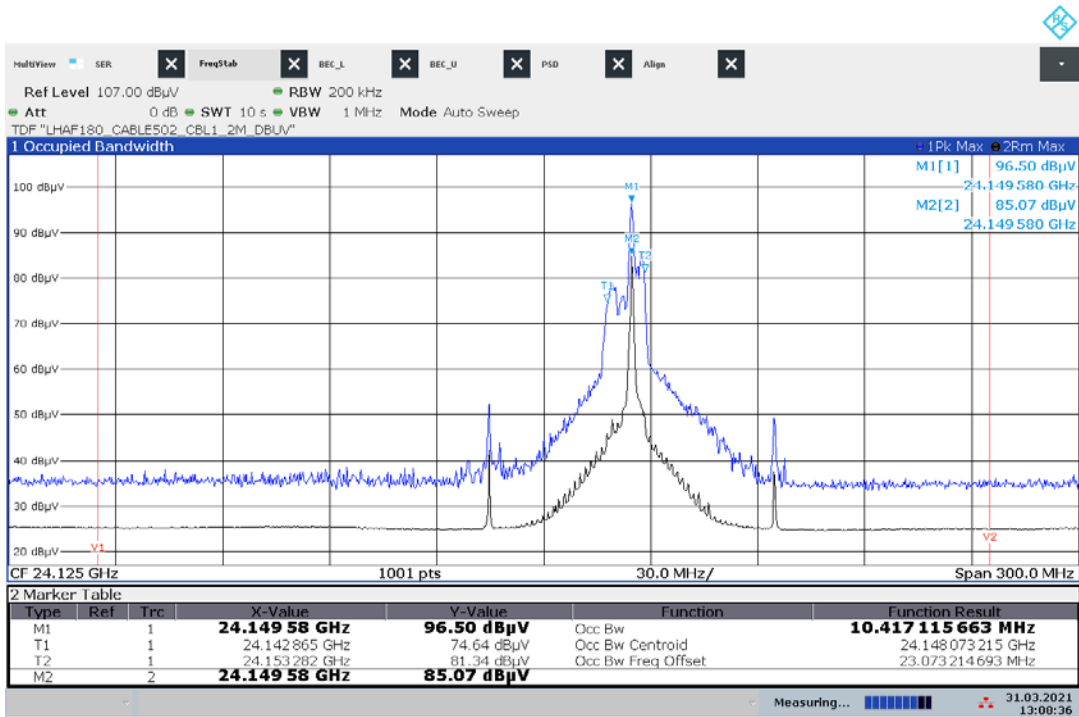

13:08:37 31.03.2021

Plot 47: +20 °C, high frequency mode, V_{nom}

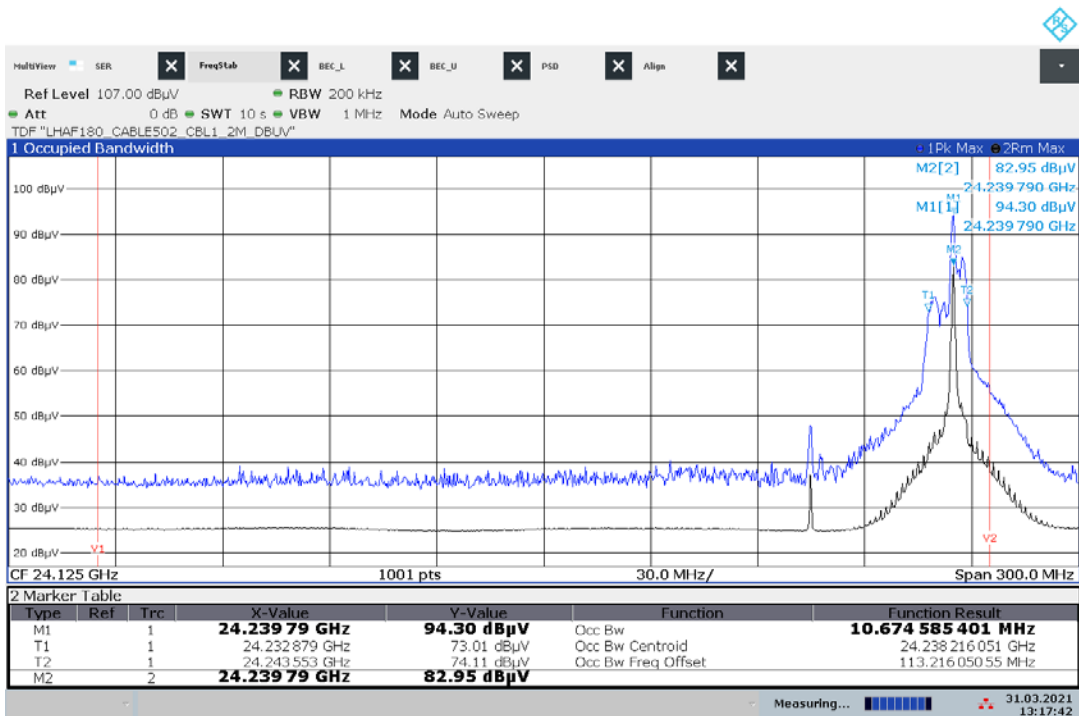

13:17:42 31.03.2021

Plot 48: +20 °C, low frequency mode, V_{max}

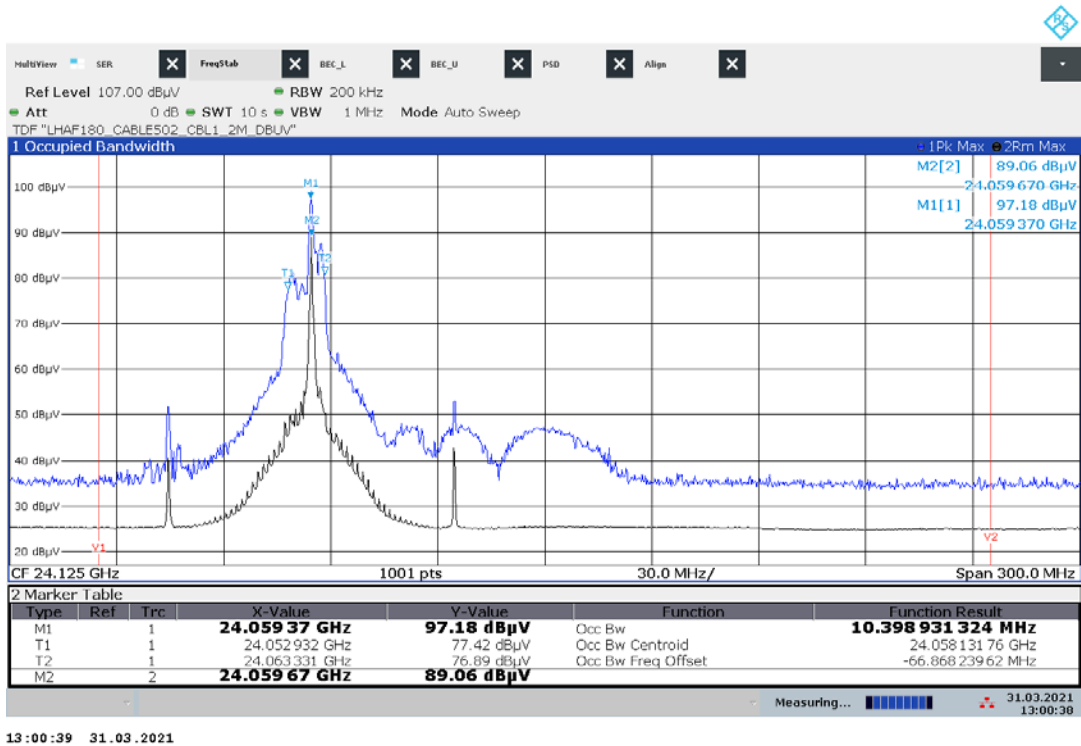

Plot 49: +20 °C, middle frequency mode, V_{max}

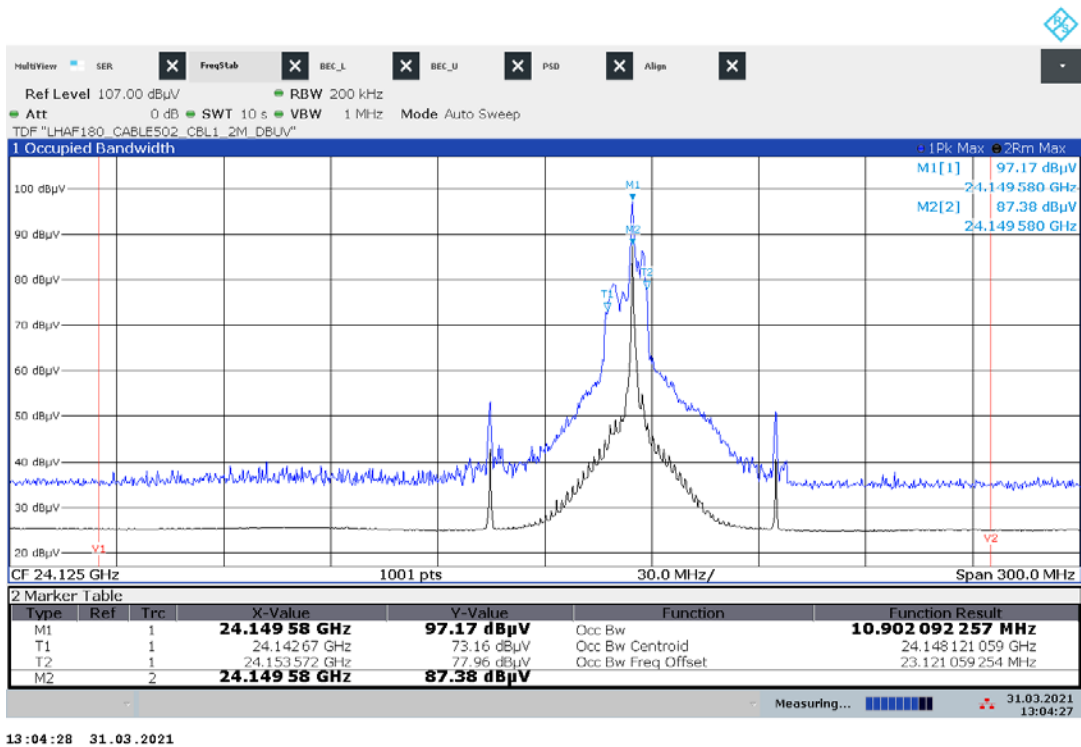

Plot 50: +20 °C, high frequency mode, V_{max}



Plot 51: +25 °C, low frequency mode, V_{nom}

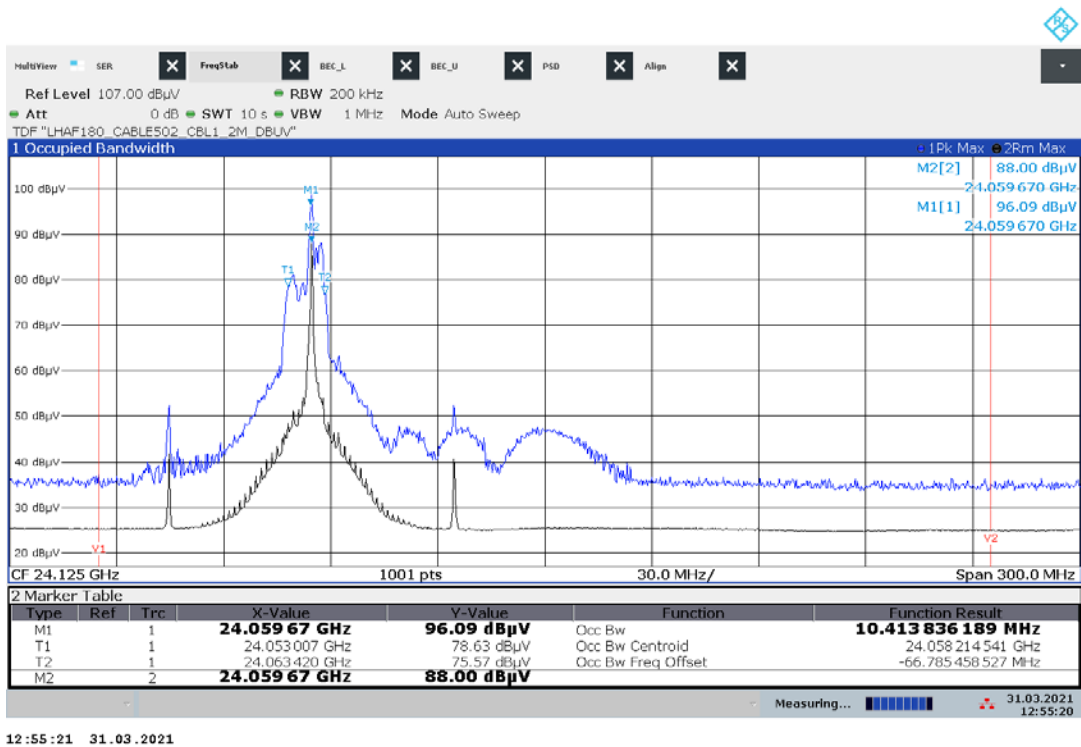

Plot 52: +25 °C, middle frequency mode, V_{nom}

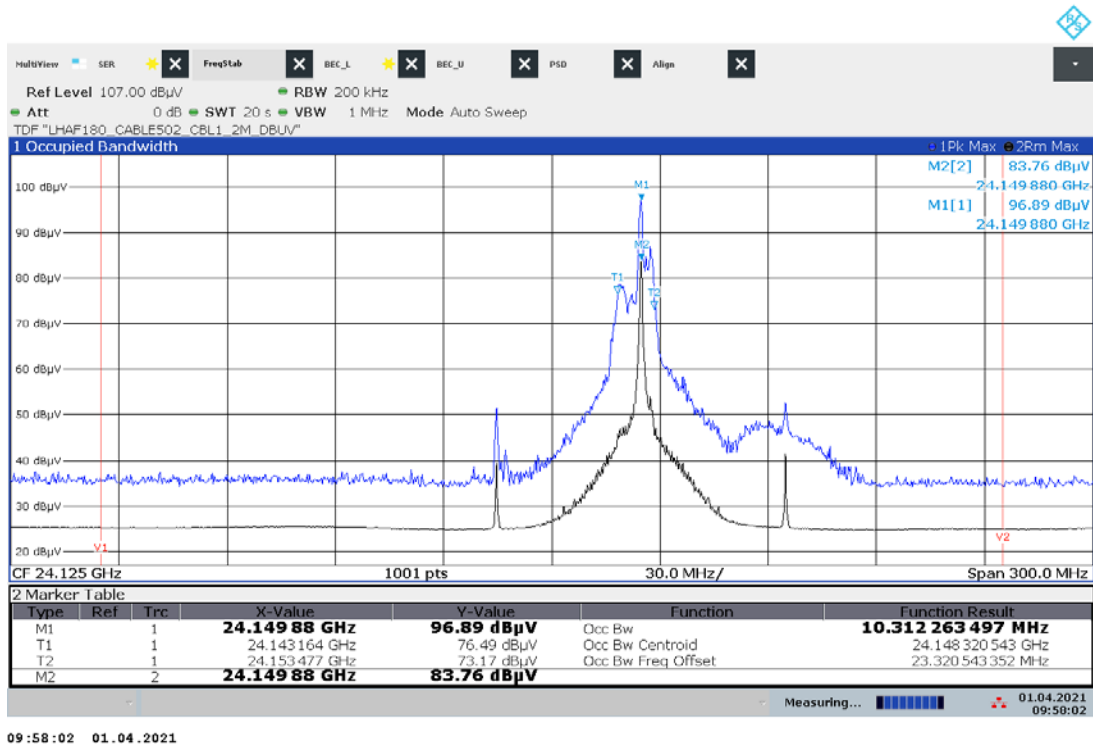

09:58:02 01.04.2021

Plot 53: +25 °C, high frequency mode, V_{nom}

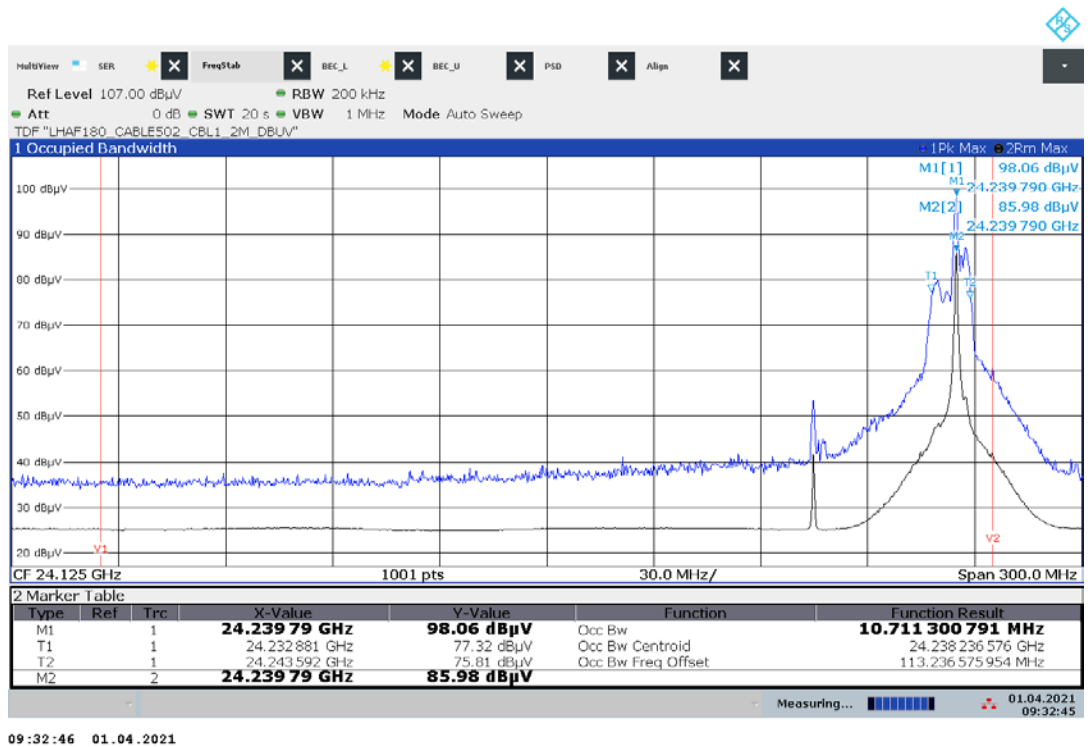

09:32:46 01.04.2021

Plot 54: +35 °C, low frequency mode, V_{nom}

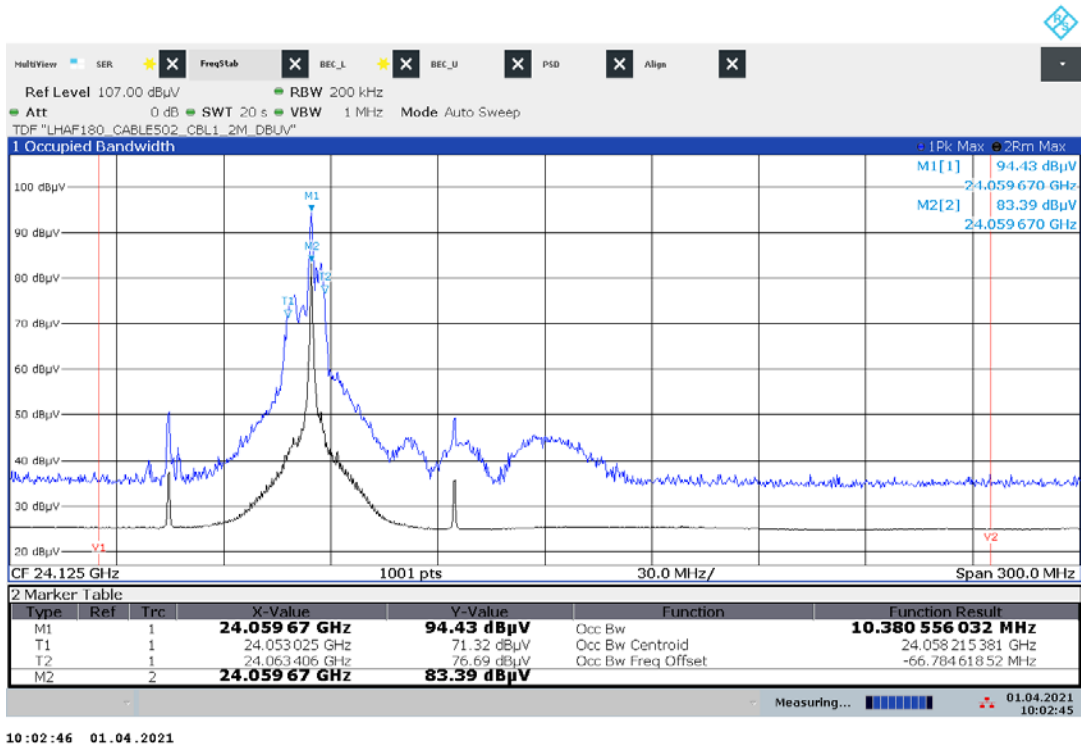

Plot 55: +35 °C, middle frequency mode, V_{nom}

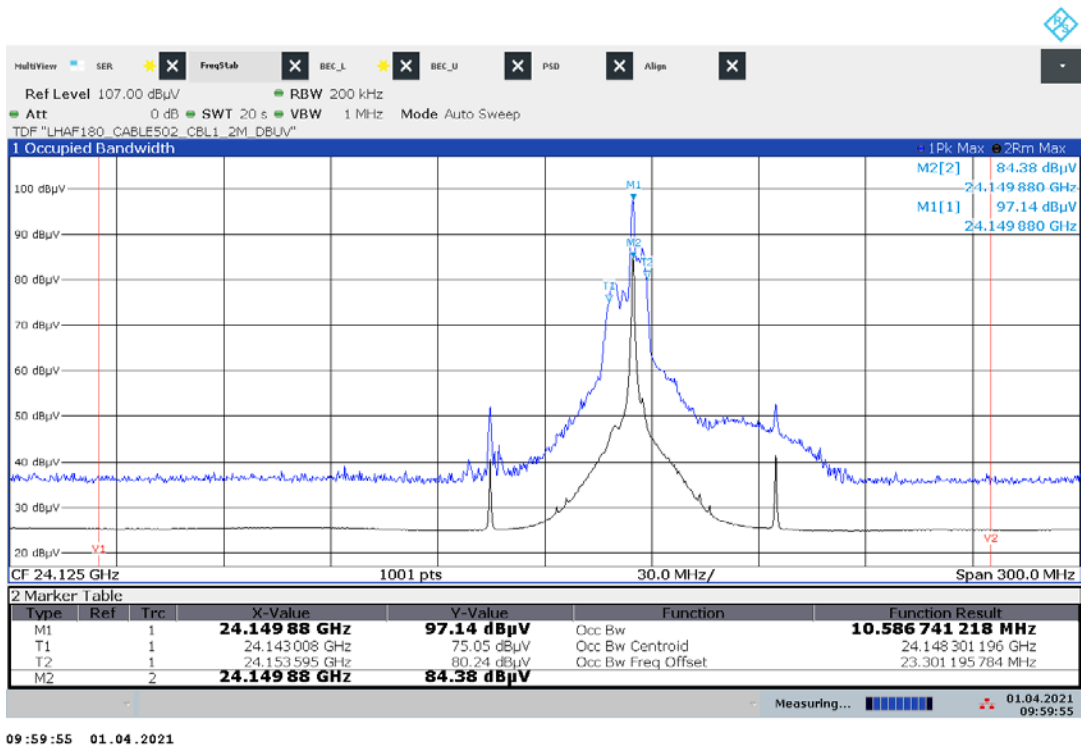

Plot 56: +35 °C, high frequency mode, V_{nom}

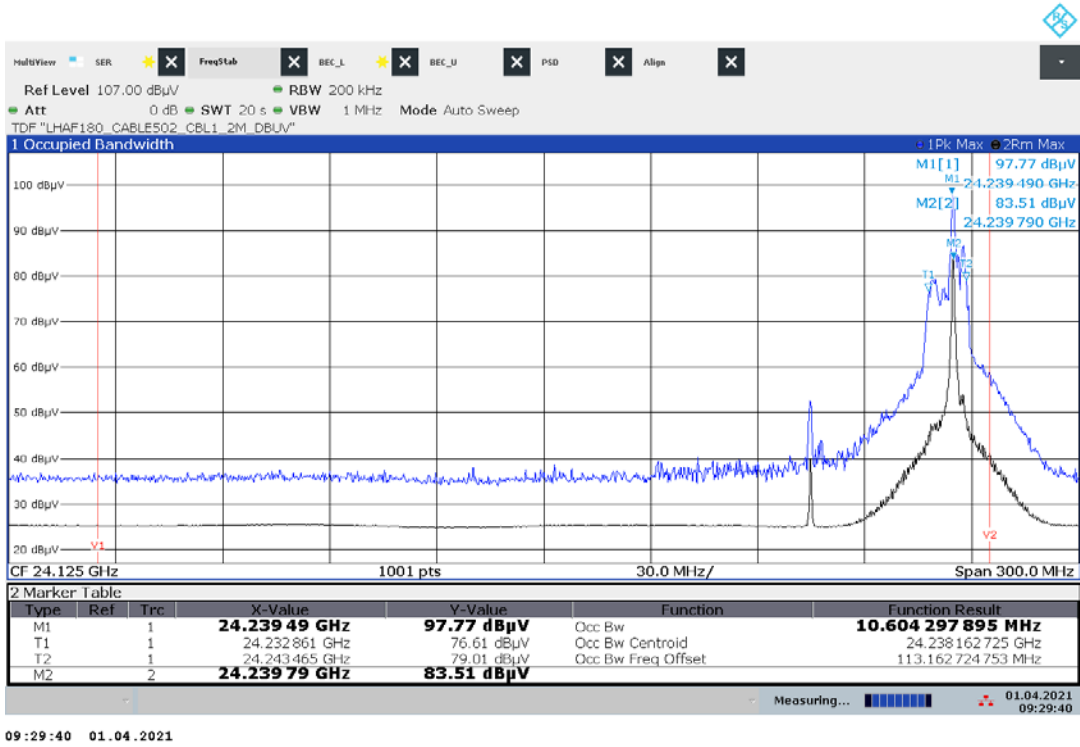

Annex A Glossary

EUT	Equipment under test
DUT	Device under test
UUT	Unit under test
GUE	GNSS User Equipment
ETSI	European Telecommunications Standards Institute
EN	European Standard
FCC	Federal Communications Commission
FCC ID	Company Identifier at FCC
IC	Industry Canada
PMN	Product marketing name
HMN	Host marketing name
HVIN	Hardware version identification number
FVIN	Firmware version identification number
EMC	Electromagnetic Compatibility
HW	Hardware
SW	Software
Inv. No.	Inventory number
S/N or SN	Serial number
C	Compliant
NC	Not compliant
NA	Not applicable
NP	Not performed
PP	Positive peak
QP	Quasi peak
AVG	Average
OC	Operating channel
OCW	Operating channel bandwidth
OBW	Occupied bandwidth
OOB	Out of band
DFS	Dynamic frequency selection
CAC	Channel availability check
OP	Occupancy period
NOP	Non occupancy period
DC	Duty cycle
PER	Packet error rate
CW	Clean wave
MC	Modulated carrier
WLAN	Wireless local area network
RLAN	Radio local area network
DSSS	Dynamic sequence spread spectrum
OFDM	Orthogonal frequency division multiplexing
FHSS	Frequency hopping spread spectrum
GNSS	Global Navigation Satellite System
C/N₀	Carrier to noise-density ratio, expressed in dB-Hz