



---

# Intelligent Thermostat **User Guide**



- Before installing or servicing your thermostat, turn off power to the system at circuit breaker.
- Leave power off until finished installing or servicing.
- Shorting the electric terminals at the control on the heating or cooling system may damage the thermostat. Do not test the system this way.
- You must follow all local codes and ordinances for wiring your system.
- This thermostat should only be powered by 4AA alkaline batteries or a Listed class 2 power supply at 24 VAC (C-Wire or wall transformer).
- An amperage higher than 1 amp to each thermostat relay load may cause damage to the thermostat.
- To avoid electrical shock and to prevent damage to the HVAC system and thermostat, disconnect the power supply before installing or servicing. It is recommended this be done at the circuit breaker.

**Contents:**

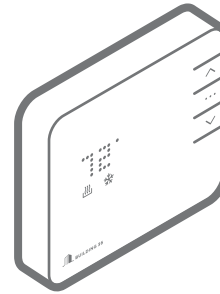

Thermostat

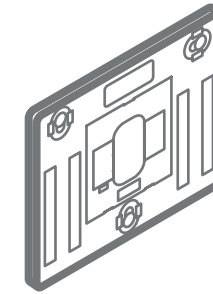

Backplate

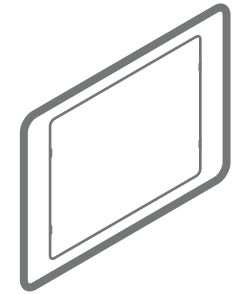

Trim Plate (Optional)

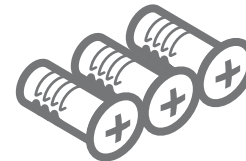

Drywall Screws (3)

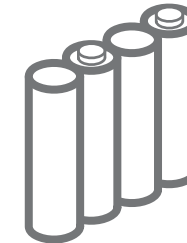

AA Batteries (4)

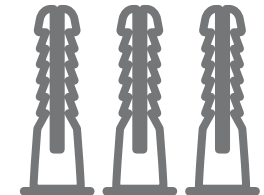

Drywall Anchors (3)

**Recommended Tools:**

- Needlenose Pliers
- Phillips Screwdriver
- Power Drill
- Pencil

## Operation

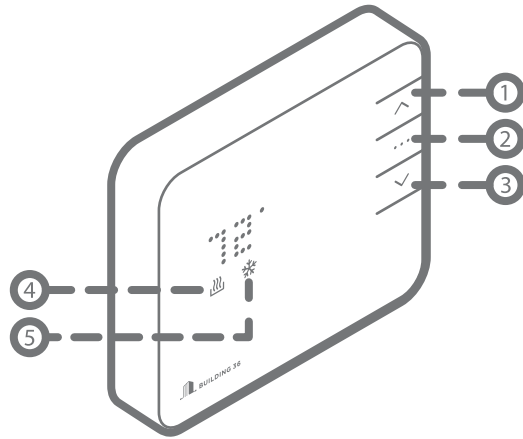

### Buttons

1. UP Button – Adjust target temperature up.
2. MODE Button – Change thermostat from HEAT, COOL, AUTO, and OFF modes.
3. DOWN Button – Adjust target temperature/ (un)Pair to and from network.

### Icons

4. HEAT Icon – Illuminated in HEAT or AUTO mode.
5. COOL Icon – Illuminated in COOL or AUTO mode.

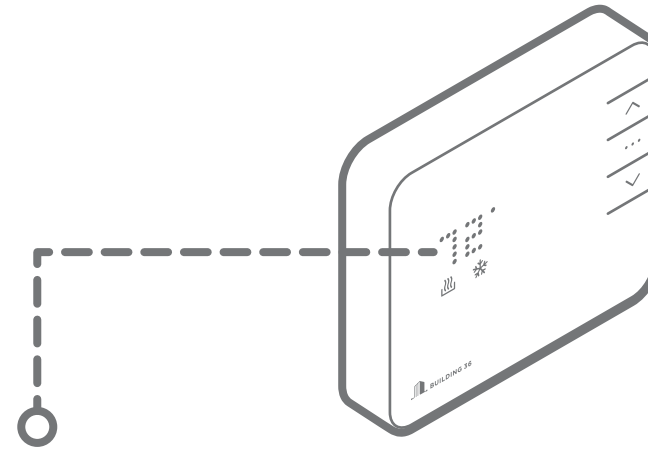

### Display

- Press any button to wake the thermostat up.
- After waking, the display will show the current mode and room temperature.
  - IF the system is running the display will wave up for heating or down for cooling.
- Press the up or down button once to change to display current setpoint.
  - The currently illuminated MODE icon will being to pulse.
- Press the up or down button again to adjust the setpoint.

- Press the mode button at any time to change the mode.
  - The modes are HEAT, COOL, AUTO, and OFF.
  - The thermostat will display the mode appropriate setpoint.
- In AUTO, the brighter icon will indicate which setpoint is currently displayed and active (HEAT or COOL).
- After 5 seconds the display will return to the current room temperature. The MODE icon will become solid to indicate this. After 5 more seconds the display will turn off and the thermostat will sleep.

**Location:**

If replacing an old thermostat, the new thermostat will be mounted in place of the old. If a new location is desired it will be necessary to move your wiring.

New installations and relocation should follow the guidelines below to ensure the most accurate temperature reading and ease of use.

- Mount thermostat on an inside wall, approximately 5 ft. (1.5m) above the floor in a frequently used room.
- Do not install in locations near appliances or devices that affect the local temperature such as televisions, lamps, or dryers.
- Avoid areas that are exposed large temperature variances, such as: direct sunlight, near an AC unit, above or below auxiliary heat and air vents, and drafts from windows.
- Be aware of what is on the other side of the wall the thermostat is being installed on. Do not install on walls adjacent to unheated rooms, stoves, or housing hot water pipes.
- Damp areas will not only affect the humidity reading of your thermostat, but could lead to corrosion shortening the life of your thermostat.
- Install in a location with good air circulation. Stagnant air will not accurately reflect the rate of change of temperature in the room. Avoid areas behind open doors, corners, and alcoves.
- Wait until construction and painting are finished before installing.

**Removing Existing Thermostat:****Test your system**

Verify that your heating and/or cooling system is operating properly before you try to install your new thermostat.

**DO NOT** do so by shorting (jumper) across electric terminals at the furnace or air conditioner. This may damage the thermostat.

**DO NOT REMOVE** your existing thermostat until power has been turned off at the circuit breaker.

Once power to the heating AND cooling systems is off follow these steps:

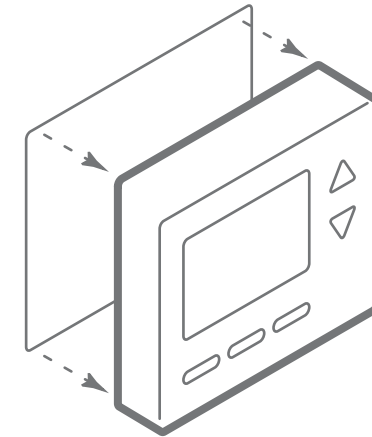

- Remove cover from your existing thermostat. Do not disconnect the wires yet.

**TIP:** Take a picture of the wires before you detach them from the existing thermostat.

- Label all existing wires, one at a time, with the labels provided.

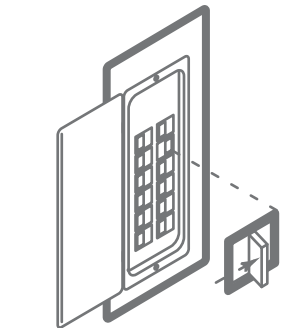

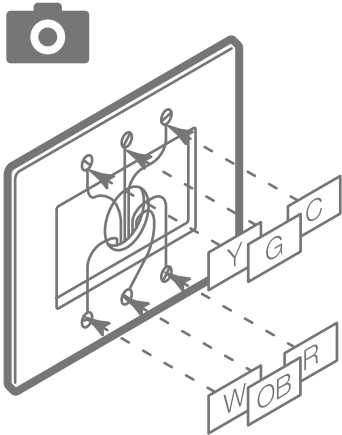
**Removing Existing Thermostat:**

- Disconnect all of the wires and remove the existing thermostat.

**TIP:** Remember to secure the wires so they don't fall into the wall.

**CAUTION:** Wiring can vary for each manufacturer. Label all wiring before removing it from your existing thermostat.

**What wires does your system use?**

Make sure your wires are labeled correctly. It may be necessary to find the 'other end' connection for each wire on your heating or air conditioning equipment and read the label there.

**IMPORTANT:** This thermostat runs on batteries and the C wire. If you do not have a C wire you can run a new wire from the HVAC or use a standard 24VAC wall transformer

**Prepare the wires**

Please follow these guidelines for safe and secure wire connections:

- Ensure the wires are a proper gauge.
- Make sure wires have exposed straight ends about 1/8" long.

**CAUTION:** Verify that your system is 24 VAC. If your old system is labeled as 120 or 240 volts, or has wire nuts your system is high voltage. Do not install your thermostat to a high voltage system. Contact your local HVAC professional for help.

**Install Your New Thermostat****Install the back plate**

Use the bubble level provided on the back plate as a guide. Mark where the screws will go with a pencil through the screw holes on the back plate.

**TIPS:**

- Use the trim plate to cover up any marks or holes left from the old thermostat. Attach the trim plate before securing the back plate to the wall.
- Drill holes with 3/16" drill bit to tap in the drywall anchors for added support.

**Wire your new thermostat**

Go to page 8 to find the wiring diagram that matches your wiring and insert the wires into the back plate.

**TIP:** Anything that wasn't connected to your old thermostat shouldn't be connected to your new thermostat either. You may also have extra wires that do not match. Leave them as is.

**EXCEPTIONS:**

- If you have R, connect it to RH.
- If you have RH & RC remove black jumper in lower left corner of back plate terminal board.
- Z can be used for W3, H, or DH.

**Wiring Diagrams:**

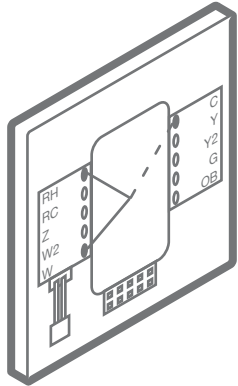

**Configuration 1**  
RH, W

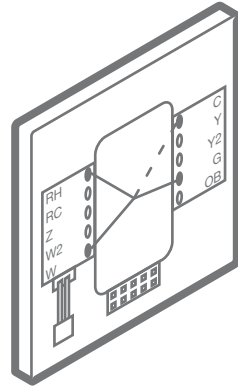

**Configuration 2**  
RH, W, G

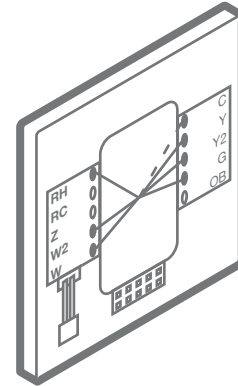

**Configuration 5**  
RH, G, W, W2, Y, Y2

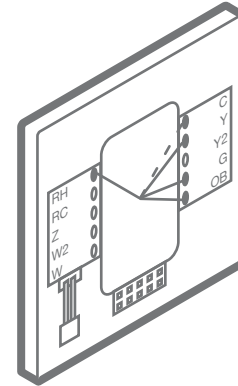

**Configuration 6**  
RH, G, OB, Y

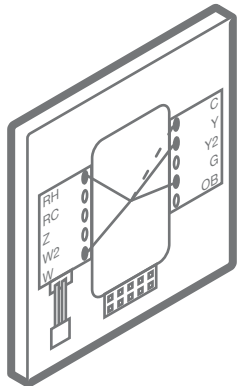

**Configuration 3**  
RH, W, Y, G

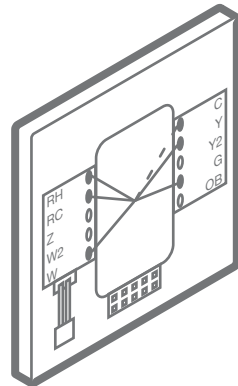

**Configuration 4**  
RH, RC, G, W, Y

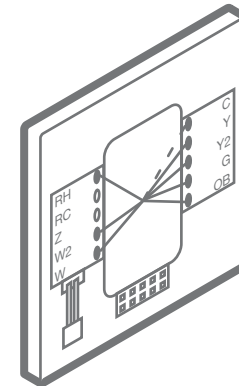

**Configuration 7**  
RH, G, W, W2, Y, Y2, OB

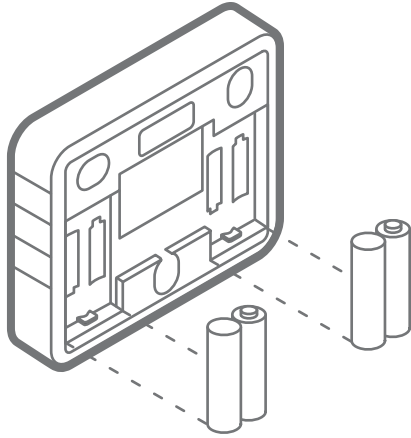
**Insert batteries into Thermostat body**

The thermostat can be powered by battery or 24 VAC. If a wall transformer is used to power your thermostat connect between C and RH.

Ensure the batteries are installed following the specified polarity markings on the thermostat.

**CAUTION: Special Battery Warning**

- Always replace the batteries as soon as Low Battery is indicated. If the batteries die, your thermostat could leave the HVAC system on, overheating or freezing your home.
- Always replace the batteries at least once a year. This will protect your thermostat from damage and corrosion by leaking batteries.
- If your home is unoccupied for a month or more, such as vacation homes, you should replace the batteries as a preventive measure against battery failure while you are away.
- Use only new batteries when changing.

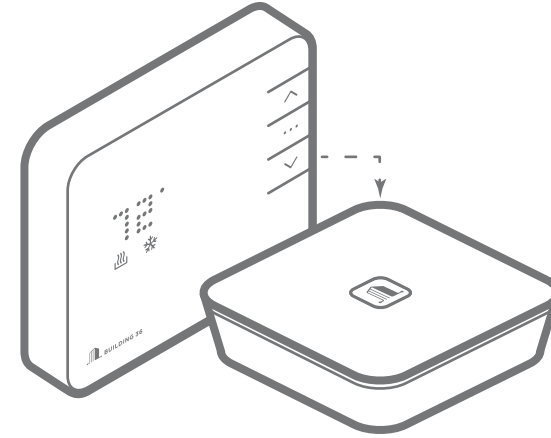
**Connect the Thermostat to the Gateway**

- Bring Gateway to the Thermostat.
- Put the thermostat in OFF mode (No mode icons are lit).
- Press the inclusion button on the Gateway.
- Press and hold the DOWN button the thermostat to begin pairing. The RADIO icon should start blinking.
- When the RADIO icon becomes solid, the thermostat is joined to the network.
- Login to your account to sync your thermostat with the Building 36 system, or contact your local professional for installation setup.

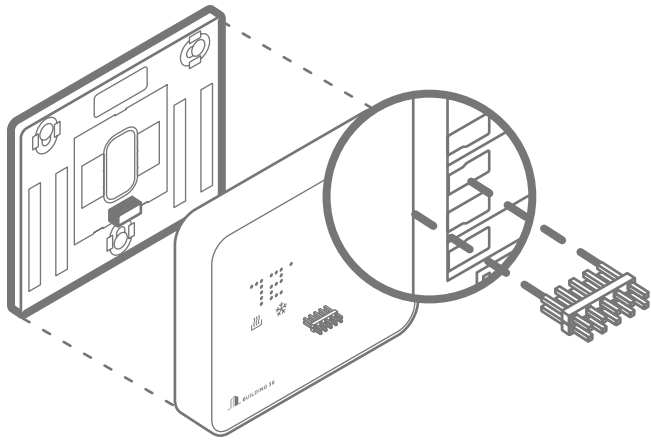
**Install Thermostat body to back plate**

Press the thermostat body firmly into the back plate mounted to the wall. Ensure that the pins on the body are correctly aligned with the header attached to the terminal board on the back plate. Failure to do so could cause damage to the thermostat.

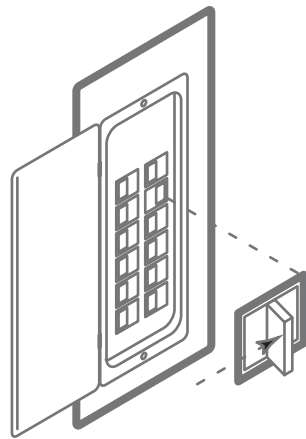
**Turn the power on**

Restore power to your heating and cooling system. This can be done at the circuit breaker.

**Configure Your System**

Your thermostat configuration will be done online at the customer site on your customer account page. Here you will configure the parameters of your system, such as: Heat Pump or Normal, number of heat and cool stages, heating fuel, calibration temperature, and configurable terminal (Z). Refer to your configuration number on the wiring diagrams page to see the values you should enter on the online configuration.

This is also where you have the option to change advanced configuration settings, such as: Swing, Differential, Recovery Setting, Fan Circulation Period and Duty Cycle, Maximum Setpoints, Minimum Setpoints, Thermostat Lock, Demand Response Delay, Demand Response Duty Cycle, and Modes Enabled.

**WARNING:** Use caution when changing advanced configuration settings. These configuration settings should only be changed by those familiar with heating and cooling systems' parameters. Contact your local HVAC professional for help.

For definitions of these settings and more information go to [www.building36.com](http://www.building36.com)

**Check Your System**

By default the thermostat is configured to 2 heat stages and 2 cool stages (2 Heat Pump, 2 Aux).

**To check heating**

Press the MODE button to select HEAT mode.

- Press UP button to raise setpoint above room temperature.
- Wait 10 seconds for system to turn on.
- After verify the heating system is working, raise the setpoint to the desired temperature.

**To check cooling**

Press MODE button to select COOL mode.

- Press DOWN button to lower setpoint below room temperature.
- Wait 10 seconds for system to turn on.
- After verify cooling system is working, lower the setpoint to the desired temperature.



## Troubleshooting

### Batteries die quickly

If a thermostat is paired using a C-Wire, that information is saved in the network and cannot be changed unless removed and paired again without a C-Wire connected. The same applies for inclusions on battery power. If you find your thermostat batteries are dying unusually quick, check and make sure the C-Wire connection is still intact. If a device is paired using C-Wire the Z-Wave communication never sleeps and the thermostat will act a repeater, sending messages for other devices as well. If the C-Wire is removed this kind of activity will drain the battery very quickly.

### Heating or cooling doesn't turn on when the target is set above or below the ambient

The thermostat is configured to have a minimum setting of a half degree difference in temperature from the target before the system turns on to protect the system from damage due to excessive use. The cooling system also has a built in compressor delay. Each time compressor is turned on, a large amount of pressure is built up and must be equalized. This delay time prevents damage to the compressor from not allowing this pressure to equalize before being turned on again.

### Manual configuration of HVAC system on thermostat

The system type (Normal or Heat Pump) can be physically set on the thermostat if necessary by doing the following:

1. Put thermostat in OFF mode.
2. Press and hold the UP button.
3. Press UP or DOWN buttons to select either 'HP' for heat pump configuration or 'NORM' for normal configuration.
4. Press MODE button to confirm your selection.

### Exclusion of thermostat from Z-Wave network

If for some reason the thermostat must be removed from the network, follow the steps below to do so.

1. Press and hold the exclusion button on the gateway.
2. Press and hold the DOWN button the thermostat to enter exclusion mode. The RADIO icon will begin flashing red.
3. When the RADIO icon becomes solid the thermostat has now been successfully removed from the network.

### Heat pump is cooling when it should be heating

Because both types of heat pump reversing valves share a single terminal on your thermostat back plate, you need to be sure you have the thermostat configured for the correct wire. Try switching your O/B selection on the customer thermostat configuration page. Contact your local HVAC professional for further with this issue. The same applies to a heat pump that is heating when it should be cooling.

For more help contact your local HVAC professional or Building 36 Technologies.

**Notices****FCC NOTICE:**

This device complies with part 15 of the FCC Rules. Operation is subject to the following two conditions:

1. This device may not cause harmful interference.

–AND–

2. This device must accept any interference received, including Interference that may cause undesired operation.

**This equipment has been tested and found to comply with the limits for a Class B digital device, pursuant to part 15 of the FCC Rules. These limits are designed to provide reasonable protection against harmful interference in a residential installation. This equipment generates, uses and can radiate radio frequency energy and, if not installed and used in accordance with the instructions, may cause harmful interference to radio communications. However, there is no guarantee that interference will not occur in a particular installation. If this equipment does cause harmful interference to radio or television reception, which can be determined by turning the equipment off and on, the user is encouraged to try to correct the interference by one or more of the following measures:**

Reorient or relocate the receiving antenna.  
Increase the separation between the equipment and receiver. Connect the equipment into an outlet on a circuit different from that to which the receiver is connected. Consult the dealer or an experienced radio/TV technician for help.

Under Industry Canada regulations, this radio transmitter may only operate using an antenna of a type and maximum (or lesser) gain approved for the transmitter by Industry Canada. To reduce potential radio interference to other users, the antenna type and its gain should be so chosen that the equivalent isotropically radiated power (e.i.r.p.) is not more than that necessary for successful communication.

*Conformément à la réglementation d'Industrie Canada, le présent émetteur radio peut fonctionner avec une antenne d'un type et d'un gain maximal (ou inférieur) approuvé pour l'émetteur par Industrie Canada. Dans le but de réduire les risques de brouillage radioélectrique à l'intention des autres utilisateurs, il faut choisir le type d'antenne et son gain de sorte que la puissance isotrope rayonnée équivalente (p.i.r.e.) ne dépasse pas l'intensité nécessaire à l'établissement d'une communication satisfaisante.*

**NOTE:** THE GRANTEE IS NOT RESPONSIBLE FOR ANY CHANGES OR MODIFICATIONS NOT EXPRESSLY APPROVED BY THE PARTY RESPONSIBLE FOR COMPLIANCE. SUCH MODIFICATIONS COULD VOID THE USER'S AUTHORITY TO OPERATE THE EQUIPMENT.

