

RF Test Report

Applicant : Meshreen Technology Ltd.
Product Type : zigbee module
Trade Name : Meshreen
Model Number : MS5168-M14
Applicable Standard : FCC 47 CFR PART 15 SUBPART C
ANSI C63.10:2013
Receive Date : Oct. 07, 2019
Test Period : Oct. 16 ~ Nov. 23, 2019
Issue Date : Nov. 26, 2019

Issue by

A Test Lab Techno Corp.
No. 140-1, Changan Street, Bade District,
Taoyuan City 33465, Taiwan (R.O.C.)
Tel : +886-3-2710188 / Fax : +886-3-2710190



Taiwan Accreditation Foundation accreditation number: 1330
Test Firm MRA designation number: TW0010

Note:

1. The test results are valid only for samples provided by customers and under the test conditions described in this report.
2. This report shall not be reproduced except in full, without the written approval of A Test Lab Technology Corporation.
3. The relevant information is provided by customers in this test report. According to the correctness, appropriateness or completeness of the information provided by the customer, if there is any doubt or error in the information which affects the validity of the test results, the laboratory does not take the responsibility.



Revision History

Rev.	Issue Date	Revisions	Revised By
00	Nov. 08, 2019	Initial Issue	Tobey Cheng
01	Nov. 26, 2019	<ol style="list-style-type: none">1. Page 7 Revised Applicant Address & Manufacturer Address & Frequency Range & Channel Number & Antenna Type & Antenna Gain & RF Output Power.2. Removed Frequency 2475 MHz data and information. Added Frequency 2480 MHz data and information.	Tobey Cheng



Verification of Compliance

Issued Date: Nov. 26, 2019

Applicant : Meshreen Technology Ltd.

Product Type : zigbee module

Trade Name : Meshreen

Model Number : MS5168-M14

FCC ID : 2AC2E-68M14

EUT Rated Voltage : DC 3.3 V

Test Voltage : 120 Vac / 60 Hz, DC 5 V

Applicable Standard : FCC 47 CFR PART 15 SUBPART C
ANSI C63.10:2013

Test Result : Complied

Performing Lab. : A Test Lab Techno Corp.
No. 140-1, Changan Street, Bade District,
Taoyuan City 33465, Taiwan (R.O.C.)
Tel : +886-3-2710188 / Fax : +886-3-2710190
Taiwan Accreditation Foundation accreditation number: 1330
<http://www.atl-lab.com.tw/e-index.htm>

A Test Lab Techno Corp. tested the above equipment in accordance with the requirements set forth in the above standards. All indications of Pass/Fail in this report are opinions expressed by A Test Lab Techno Corp. based on interpretations and/or observations of test results. The test results show that the equipment tested is capable of demonstrating compliance with the requirements as documented in this report.

Approved By : Fly Lu
(Manager) (Fly Lu)



TABLE OF CONTENTS

1	General Information	5
1.1.	Summary of Test Result.....	5
1.2.	Measurement Uncertainty.....	6
2	EUT Description	7
3	Test Methodology	8
3.1.	Mode of Operation.....	8
3.2.	EUT Test Step	8
3.3.	Configuration of Test System Details	9
3.4.	Test Instruments	10
3.5.	Test Site Environment.....	11
4	Measurement Procedure	12
4.1.	AC Power Line Conducted Emission Measurement.....	12
4.2.	Radiated Emission Measurement	14
4.3.	Maximum Conducted Output Power Measurement.....	18
4.4.	6 dB RF Bandwidth and 99 % Occupied Bandwidth Measurement	19
4.5.	Maximum Power Spectral Density Measurement.....	20
4.6.	Out of Band Conducted Emissions Measurement.....	21
4.7.	Antenna Measurement	22
5	Test Results.....	23
	Annex A. Conducted Emission	23
	Annex B. Conducted Test Results	25
	Annex C. Radiated Emission Measurement	32



1 General Information

1.1. Summary of Test Result

Standard	Item	Result	Remark
15.207	AC Power Conducted Emission	PASS	----
15.247(d)	Transmitter Radiated Emissions	PASS	----
15.247(b)(3)	Max. Output Power	PASS	----
15.247(a)(2)	6 dB RF Bandwidth	PASS	----
15.247(e)	Maximum Power Spectral Density	PASS	----
15.247(c)	Out of Band Conducted Spurious Emission	PASS	----
15.203	Antenna Requirement	PASS	----

Standard	Description
CFR47, Part 15, Subpart C	Intentional Radiators
ANSI C63. 10: 2013	American National Standard of Procedures for Compliance Testing of Unlicensed Wireless Devices
KDB 558074 D01 15.247 Meas Guidance v05r02	GUIDANCE FOR COMPLIANCE MEASUREMENTS ON DIGITAL TRANSMISSION SYSTEM, FREQUENCY HOPPING SPREAD SPECTRUM SYSTEM, AND HYBRID SYSTEM DEVICES OPERATING UNDER SECTION 15.247 OF THE FCC RULES

1.2. Measurement Uncertainty

Test Item	Frequency Range	Uncertainty (dB)
Conducted Emission	150 kHz ~ 30 MHz	2.8
Radiated Emission	9 kHz ~ 30 MHz	1.7
	30 MHz ~ 1000 MHz	5.7
	1000 MHz ~ 18000 MHz	5.6
	18000 MHz ~ 26500 MHz	4.9
	26500 MHz ~ 40000 MHz	4.8
Conducted Output Power	+0.27 dB / -0.28 dB	
RF Bandwidth	4.96 %	
Power Spectral Density	+0.71 dB / -0.77 dB	

Decision Rule

- Uncertainty is not included.
- Uncertainty is included.

2 EUT Description

Applicant	Meshreen Technology Ltd. 3F., No.1421, Sec. 2, Wanshou Rd., Guishan Dist., Taoyuan City 33342, Taiwan
Manufacturer	Meshreen Technology Ltd. 3F., No.1421, Sec. 2, Wanshou Rd., Guishan Dist., Taoyuan City 33342, Taiwan
Product Type	zigbee module
Trade Name	Meshreen
Model Number	MS5168-M14
FCC ID	2AC2E-68M14
Frequency Range	2405 MHz ~ 2480 MHz
Modulation Type	O-QPSK
Channel Number	16 CH
Antenna Type	Dipole Antenna
Antenna Gain	2.43 dBi
RF Output Power	0.00293 W / 4.67 dBm
Operate Temp. Range	-40 ~ +85 °C

3 Test Methodology

3.1. Mode of Operation

Decision of Test ATL has verified the construction and function in typical operation. All the test modes were carried out with the EUT in normal operation, which was shown in this test report and defined as:

Test Mode
Mode 1: Transmit mode
Mode 2: ZigBee Continuous TX mod

Software used to control the EUT for staying in continuous transmitting mode was programmed.

After verification, all tests were carried out with the worst case test modes.

ZigBee link mode:

Channel Low (2405MHz), Channel Mid (2440MHz) and Channel High (2480 MHz) were chosen for full testing.

3.2. EUT Test Step

1	Setup the EUT shown on "Configuration of Test System Details".
2	Turn on the power of all equipment.
3	Turn on TX function
4	EUT run test program.

Measurement Software			
No.	Description	Software	Version
1	Conducted Emission	EZ EMC	1.1.4.3
2	Radiated Emission	EZ EMC	1.1.4.4

3.3. Configuration of Test System Details

Conducted Emissions

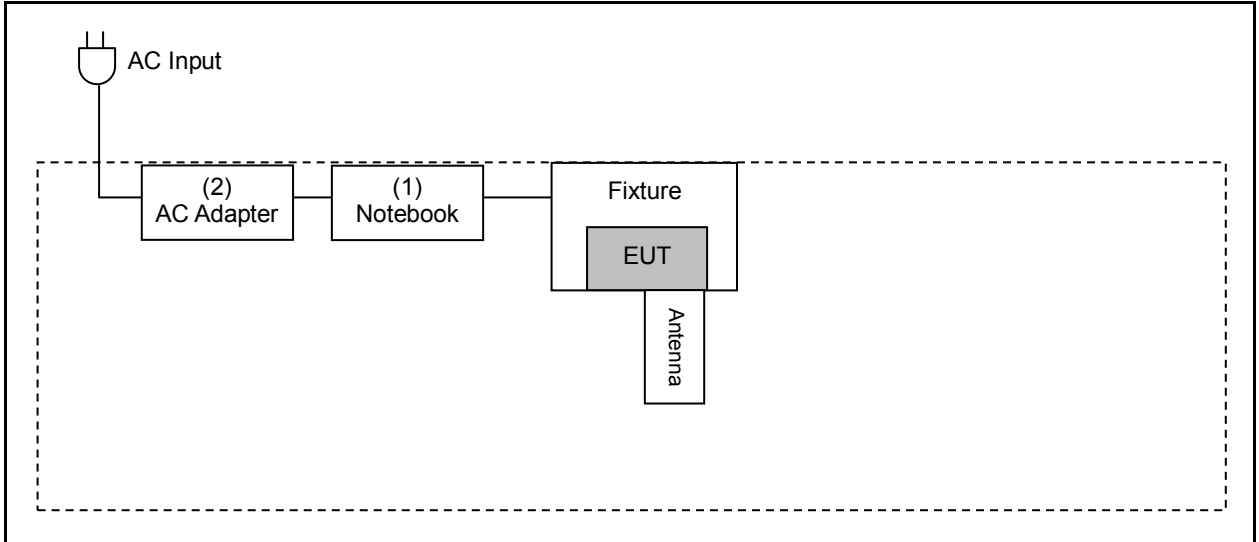

Radiated Emissions

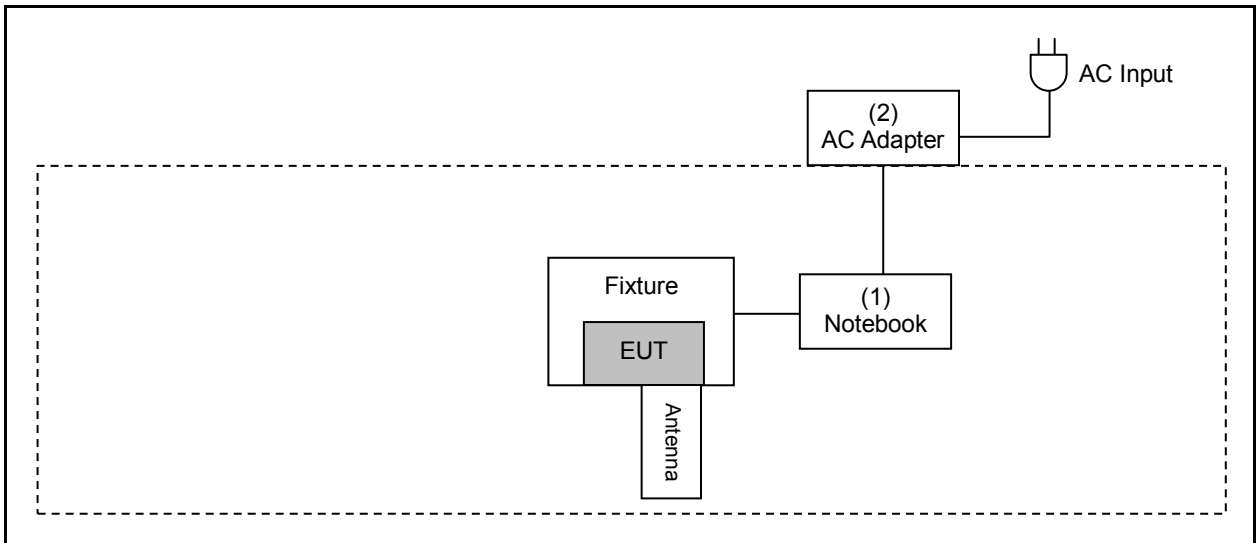

Devices Description					
	Product	Manufacturer	Model Number	Serial Number	Power Cord
(1)	Notebook	DELL	LATITUDE E6440	5HZBD72	---
(2)	AC Adapter	DELL	HA65NM130	---	Non-Shielded, 0.8 m



3.4. Test Instruments

For Conducted Emission

Test Period: Oct. 16, 2019

Testing Engineer: Louis Shen

Equipment	Manufacturer	Model Number	Serial Number	Cal. Date	Cal. Period
Test Receiver	R&S	ESCI	100367	05/23/2019	1 year
LISN	R&S	ENV216	101040	04/03/2019	1 year
LISN	R&S	ENV216	101041	03/28/2019	1 year
RF Cable	Woken	00100D1380194M	TE-02-03	05/23/2019	1 year

For Radiated Emissions

Test Period: Oct. 25, 2019 / Nov. 23, 2019

Testing Engineer: Ricky Liu

Equipment	Manufacturer	Model Number	Serial Number	Cal. Date	Cal. Period
Spectrum Analyzer (10 Hz~44 GHz)	Keysight	N9010A	MY52221312	01/14/2019	1 year
Pre Amplifier (1~26.5 GHz)	Agilent	8449B	3008A02237	10/18/2019	1 year
Pre Amplifier (100 kHz~1.3 GHz)	Agilent	8447D	2944A11119	01/14/2019	1 year
Broadband Antenna	Schwarzbeck	SB AC VULB	9168-0841	11/19/2018	1 year
Horn Antenna (1~18 GHz)	SCHWARZBECK MESS-ELEKTRONIK	BBHA9120D	9120D-550	08/22/2019	1 year
Horn Antenna (18~40 GHz)	SCHWARZBECK MESS-ELEKTRONIK	BBHA9170	9170-320	08/14/2019	1 year
RF Cable	EMCI	EMC104-N-N-6000	TE01-1	02/20/2019	1 year
Microwave Cable	EMCI	EMC104-SM -SM-13000	170814	10/30/2018	1 year
Microwave Cable	EMCI	EMC102-KM -KM-14000	151001	02/20/2019	1 year

Note: N.C.R. = No Calibration Request.



For Conducted

Test Period: Oct. 25, 2019 / Nov. 23, 2019

Testing Engineer: Negi Chiu

Equipment	Manufacturer	Model Number	Serial Number	Cal. Date	Cal. Period
Spectrum Analyzer (20 Hz~26.5 GHz)	Agilent	N9020A	US47520902	09/18/2019	1 year
Power Sensor	Anritsu	MA2411B	1126022	09/03/2019	1 year
Power Meter	Anritsu	ML2495A	1135009	09/03/2019	1 year
Microwave Cable	EMCI	EMC102-SM -SM1500	001	11/21/2018	1 year
Test Site	ATL	TE05	TE05	N.C.R.	-----

Note: N.C.R. = No Calibration Request.

3.5. Test Site Environment

Items	Required (IEC 60068-1)	Actual
Temperature (°C)	15-35	23-26
Humidity (%RH)	25-75	55-60
Barometric pressure (mbar)	860-1060	950

4 Measurement Procedure

4.1. AC Power Line Conducted Emission Measurement

■ Limit

Frequency (MHz)	Quasi-peak	Average
0.15 - 0.5	66 to 56	56 to 46
0.50 - 5.0	56	46
5.0 - 30.0	60	50

■ Test Setup

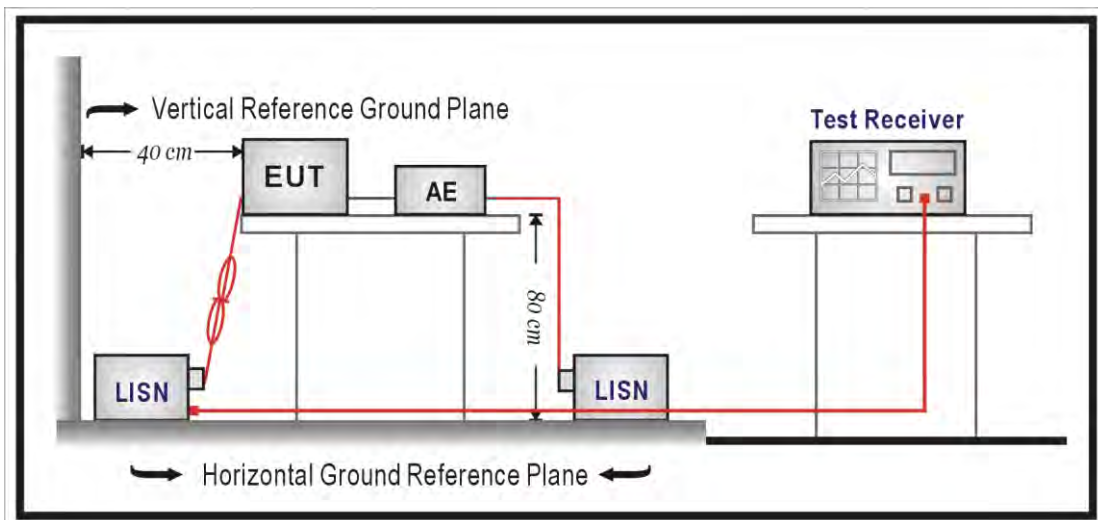

■ Test Procedure

The EUT and simulators are connected to the main power through a line impedance stabilization network (L.I.S.N.). This provides a $50 \Omega // 50 \mu\text{H}$ coupling impedance for the measuring equipment. The peripheral devices are also connected to the main power through a LISN that provides a $50 \Omega // 50 \mu\text{H}$ coupling impedance with 50 ohm termination.

Tabletop device shall be placed on a non-conducting platform, of nominal size 1 m by 1.5 m, raised 80 cm above the reference ground plane. The wall of screened room shall be located 40 cm to the rear of the EUT. Other surfaces of tabletop or floor standing EUT shall be at least 80 cm from any other ground conducting surface including one or more LISNs. For floor-standing device shall be placed under the EUT with a 12 mm insulating material.

Conducted emissions were investigated over the frequency range from 0.15 MHz to 30 MHz using a resolution bandwidth of 9 kHz. The equipment under test (EUT) shall be meet the limits in section 4.1, as applicable, including the average limit and the quasi-peak limit when using respectively, an average detector and quasi-peak detector measured in accordance with the methods described of related standard. When all of peak value were complied with quasi-peak and average limit from 150 kHz to 30 MHz then quasi-peak and average measurement was unnecessary.

The AMN shall be placed 0.8 m from the boundary of the unit under test and bonded to a ground reference plane for AMNs mounted on top of the ground reference plane. This distance is between the closest points of the AMN and the EUT. All other units of the EUT and associated equipment shall be at least 0.8 m from the AMN. If the mains power cable is longer than 1 m then the cable shall be folded back and forth at the centre of the lead to form a bundle no longer than 0.4 m. All of interconnecting cables that hang closer than 40 cm to the ground plane shall be folded back and forth in the center forming a bundle 30 cm to 40 cm long. All of EUT and AE shall be separate place more than 0.1 m. All 50Ω ports of the LISN shall be resistively terminated into 50Ω loads when not connected to the measuring instrument.

If the reading of the measuring receiver shows fluctuations close to the limit, the reading shall be observed for at least 15 s at each measurement frequency; the higher reading shall be recorded with the exception of any brief isolated high reading which shall be ignored.



4.2. Radiated Emission Measurement

■ Limit

According to §15.209(a), except as provided elsewhere in this subpart, the emissions from an intentional radiator shall not exceed the field strength levels specified in the following table:

Frequency (MHz)	Field Strength ($\mu\text{V}/\text{m}$ at meter)	Measurement Distance (meters)
0.009 – 0.490	2400 / F (kHz)	300
0.490 – 1.705	24000 / F (kHz)	30
1.705 – 30.0	30	30
30 - 88	100**	3
88-216	150**	3
216-960	200**	3
Above 960	500	3

** Except as provided in paragraph (g), fundamental emissions from intentional radiators operating under this Section shall not be located in the frequency bands 54-72 MHz, 76-88 MHz, 174-216 MHz or 470-806 MHz. However, operation within these frequency bands is permitted under other sections of this Part, e.g., Sections 15.231 and 15.241.

■ Setup

Below 1 GHz

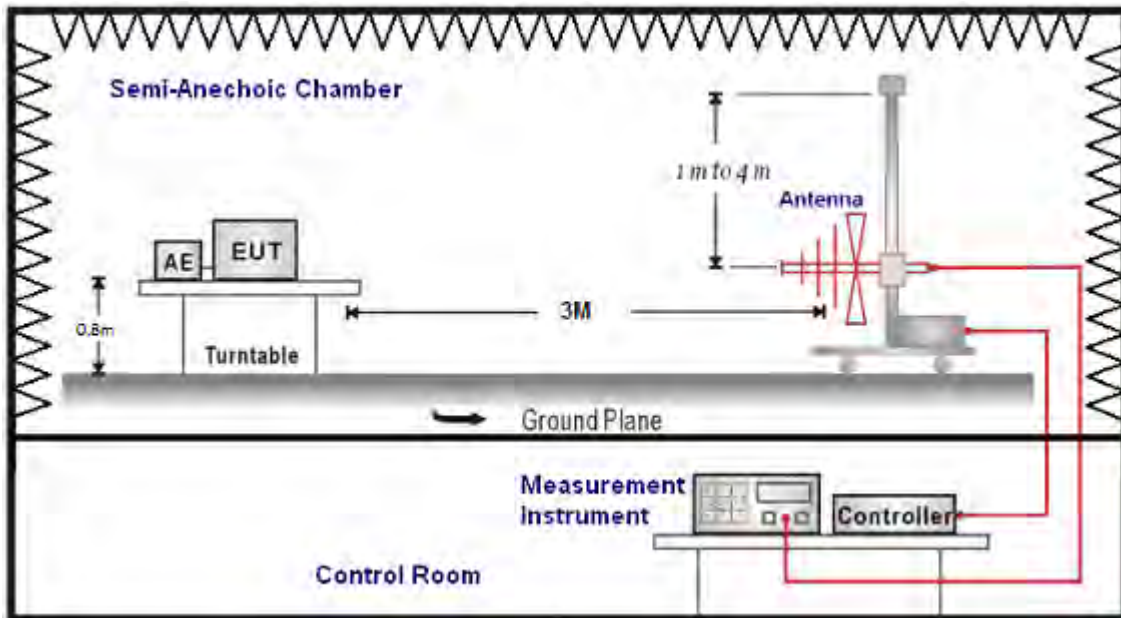

Above 1 GHz

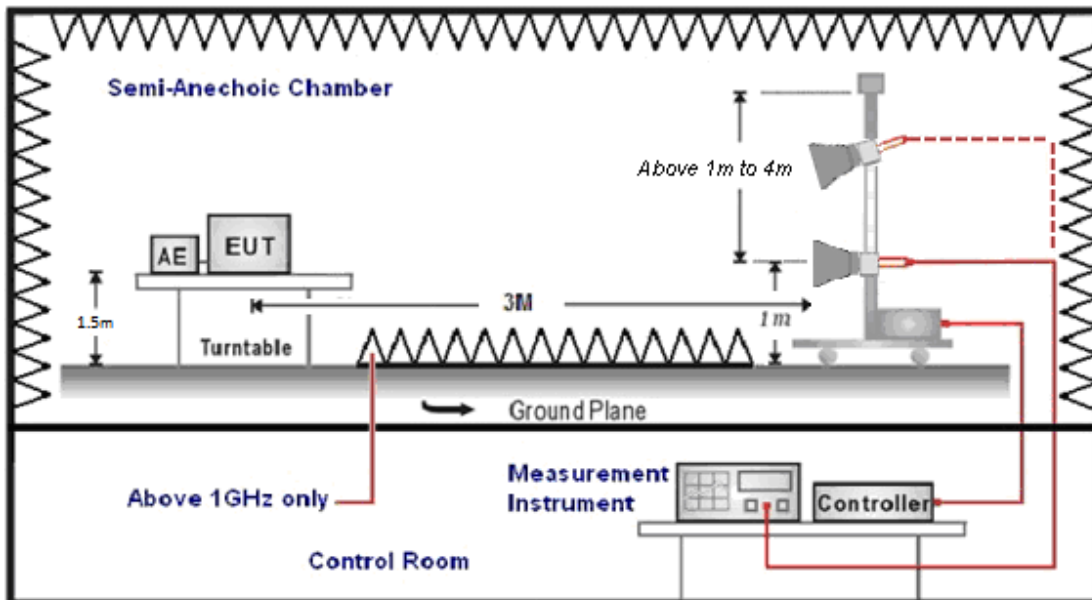

■ Test Procedure

Final radiation measurements were made on a three-meter, Semi Anechoic Chamber. The EUT system was placed on a nonconductive turntable which is 0.8 or 1.5 meters height, top surface 1.0 x 1.5 meter. The spectrum was examined from 250 MHz to 2.5 GHz in order to cover the whole spectrum below 10th harmonic which could generate from the EUT. During the test, EUT was set to transmit continuously & Measurements spectrum range from 9 kHz to 26.5 GHz is investigated.

For measurements below 1 GHz the resolution bandwidth is set to 100 kHz for peak detection measurements or 120 kHz for quasi-peak detection measurements. Peak detection is used unless otherwise noted as quasi-peak.

For measurements above 1 GHz the resolution bandwidth is set to 1 MHz, and then the video bandwidth is set to 3 MHz for peak measurements and 10 Hz for average measurements when Duty cycle >0.98 / $1/T$ for average measurements when Duty cycle <0.98 . A nonconductive material surrounded the EUT to supporting the EUT for standing on three orthogonal planes. At each condition, the EUT was rotated 360 degrees, and the antenna was raised and lowered from one to four meters to find the maximum emission levels. Measurements were taken using both horizontal and vertical antenna polarization.

SCHWARZBECK MESS-ELEKTRONIK Biconilog Antenna at 3 Meter and the SCHWARZBECK Double Ridged Guide Antenna was used in frequencies 1 –26.5 GHz at a distance of 3 meter. The antenna at an angle toward the source of the emission. All test results were extrapolated to equivalent signal at 3 meters utilizing an inverse linear distance extrapolation Factor (20 dB/decade).

For testing above 1 GHz, the emission level of the EUT in peak mode was 20 dB lower than average limit (that means the emission level in peak mode also complies with the limit in average mode), then testing will be stopped and peak values of EUT will be reported, otherwise, the emissions will be measured in average mode again and reported.

Appropriate preamplifiers were used for improving sensitivity and precautions were taken to avoid overloading or desensitizing the spectrum analyzer. No post – detector video filters were used in the test.

The spectrum analyzer's 6 dB bandwidth was set to 1 MHz, and the analyzer was operated in the peak detection mode, for frequencies both below and up 1 GHz. The average levels were obtained by subtracting the duty cycle correction factor from the peak readings.

The following procedures were used to convert the emission levels measured in decibels referenced to 1 microvolt (dBuV) into field intensity in micro volts pre meter (uV/m).

The actual field intensity in decibels referenced to 1 microvolt in to field intensity in micro volts per meter (dBuV/m).



The actual field intensity in referenced to 1 microvolt per meter (dBuV/m) is determined by algebraically adding the measured reading in dBuV, the antenna factor (dB), and cable loss (dB) and Subtracting the gain of preamplifier (dB) is auto calculate in spectrum analyzer.

(1) $\text{Amplitude (dBuV/m)} = \text{FI (dBuV)} + \text{AF (dBuV)} + \text{CL (dBuV)} - \text{Gain (dB)}$

FI= Reading of the field intensity.

AF= Antenna factor.

CL= Cable loss.

P.S Amplitude is auto calculate in spectrum analyzer.

(2) $\text{Actual Amplitude (dBuV/m)} = \text{Amplitude (dBuV)} - \text{Dis(dB)}$

The FCC specified emission limits were calculated according the EUT operating frequency and by following linear interpolation equations:

(a) For fundamental frequency : Transmitter Output < +30 dBm

(b) For spurious frequency : Spurious emission limits = fundamental emission limit /10

Data of measurement within this frequency range without mark in the table above means the reading of emissions are attenuated more than 20 dB below the permissible limits or the field strength is too small to be measured.

4.3. Maximum Conducted Output Power Measurement

■ Limit

For systems using digital modulation in the 2400-2483.5 MHz, the limit for peak output power is 30 dBm.

■ Test Setup

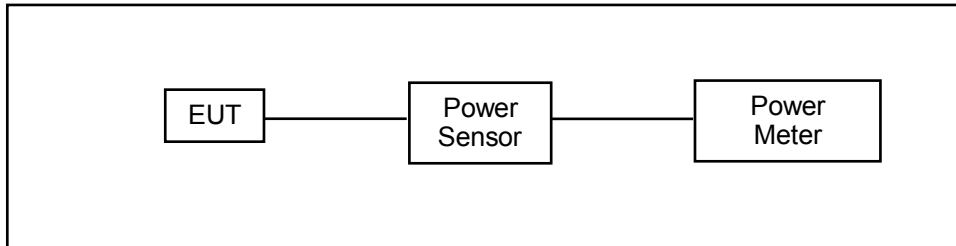

■ Test Procedure

The tests below are run with the EUT's transmitter set at high power in TX mode. The EUT is needed to force selection of output power level and channel number. While testing, EUT was set to transmit continuously. Remove the Subjective device's antenna and connect the RF output port to power sensor. The maximum peak output power shall not exceed 1 watt.

Use a direct connection between the antenna port of transmitter and the power sensor, for prevent the power sensor input attenuation 40-50 dB. Set the RBW Bandwidth of the emission or use a channel power meter mode.

For antennas with gains of 6 dBi or less, maximum allowed transmitter output is 1 watt (+30 dBm). For antennas with gains greater than 6 dBi, transmitter output level must be decreased by an amount equal to $(\text{GAIN} - 6)/3$ dBm.

The antenna port of the EUT was connected to the input of a power sensor. Power was read directly and cable loss correction was added to the reading to obtain power at the EUT antenna terminals.

4.4. 6 dB RF Bandwidth and 99 % Occupied Bandwidth Measurement

■ **Limit**

6 dB RF Bandwidth: Systems using digital modulation techniques may operate in the 2400–2483.5 MHz bands. The minimum 6 dB band-width shall be at least 500 kHz.

99 % Occupied Bandwidth: N/A

■ **Test Setup**

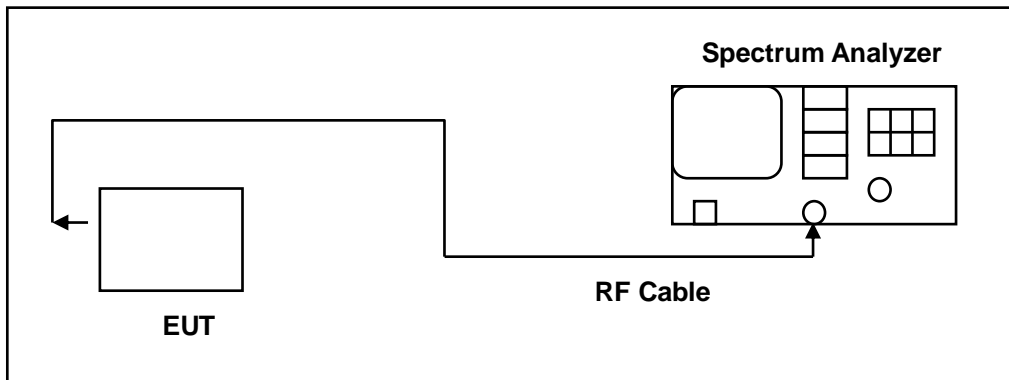

■ **Test Procedure**

The EUT tested to DTS test procedure of ANSI C63.10:2013 section 11.8.2 option2 for compliance to FCC 47CFR 15.247 requirements.

6 dB RF Bandwidth: The antenna port of the EUT was connected to the input of a spectrum analyzer. Analyzer RBW was set to 100 kHz. For each RF output channel investigated, the spectrum analyzer center frequency was set to the channel carrier. A peak output reading was taken, a DISPLAY line was drawn 6 dB lower than peak level. The 6 dB bandwidth was determined from where the channel output spectrum intersected the display line.

The test was performed at 3 channels (Channel low, middle, high)

99 % Occupied Bandwidth: The transmitter shall be operated at its maximum carrier power measured under normal test conditions.

The span of the analyzer shall be set to capture all products of the modulation process, including the emission skirts. The resolution bandwidth shall be set to as close to 1 % of the selected span as is possible without being below 1 %. The video bandwidth shall be set to 3 times the resolution bandwidth. Video averaging is not permitted. Where practical, a sampling detector shall be used since a peak or, peak hold, may produce a wider bandwidth than actual. The trace data points are recovered and are directly summed in linear terms. The recovered amplitude data points, beginning at the lowest frequency, are placed in a running sum until 0.5 % of the total is reached and that frequency recorded. The process is repeated for the highest frequency data points. This frequency is recorded.

4.5. Maximum Power Spectral Density Measurement

■ Limit

For digitally modulated systems, the power spectral density conducted from the intentional radiator to the antenna shall not be greater than 8 dBm in any 3 kHz band during any time interval of continuous transmission.

■ Test Setup

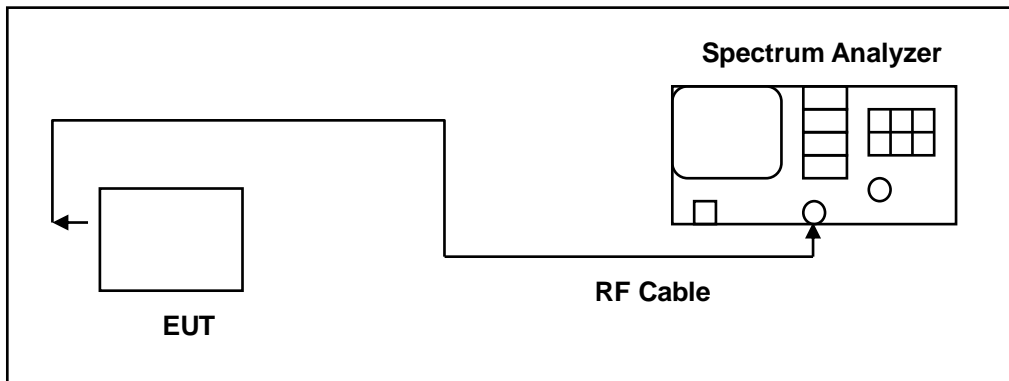

■ Test Procedure

The EUT tested to DTS test procedure of ANSI C63.10:2013 section 11.10.2 for compliance to FCC 47CFR 15.247 requirements.

1. Set analyzer center frequency to DTS channel center frequency.
2. Set the span to 1.5 times the DTS bandwidth.
3. Set the RBW to: $3 \text{ kHz} \leq \text{RBW} \leq 100 \text{ kHz}$.
4. Set the VBW $\geq 3 \text{ RBW}$.
5. Detector = peak.
6. Sweep time = auto couple.
7. Trace mode = max hold.
8. Allow trace to fully stabilize.
9. Use the peak marker function to determine the maximum amplitude level within the RBW.
10. If measured value exceeds limit, reduce RBW (no less than 3 kHz) and repeat.

4.6. Out of Band Conducted Emissions Measurement

■ Limit

In any 100 kHz bandwidth outside the frequency band in which the spread spectrum or digitally modulated intentional radiator is operating, the radio frequency power that is produced by the intentional radiator shall be at least 20 dB below that in the 100 kHz bandwidth within the band that contains the highest level of the desired power

■ Test Setup

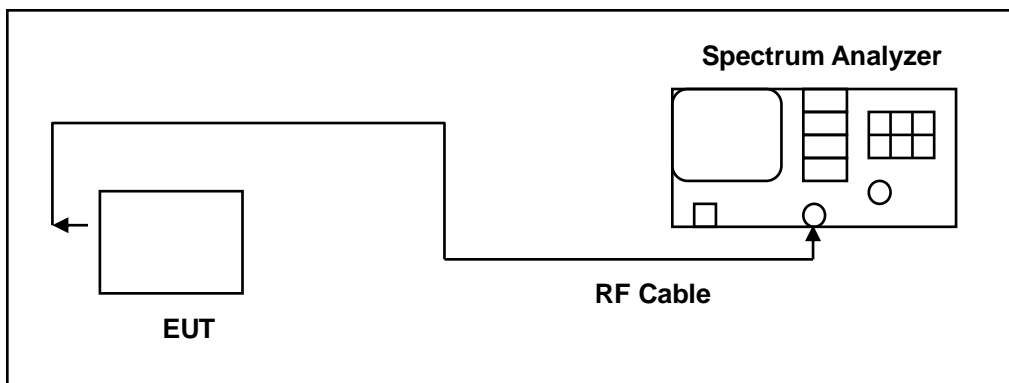

■ Test Procedure

In any 100 kHz bandwidth outside the EUT pass band, the RF power produced by the modulation products of the spreading sequence, the information sequence, and the carrier frequency shall be at least 20 dB below that of the maximum in-band 100 kHz emission, antenna output of the EUT was coupled directly to spectrum analyzer; if an external attenuator and/or cable was used, these losses are compensated for with the analyzer OFFSET function.

All other types of emissions from the EUT shall meet the general limits for radiated frequencies outside the pass band.

The test was performed at 3 channels (Channel low, middle, high)



4.7. Antenna Measurement

■ Limit

For intentional device, according to 15.203, an intentional radiator shall be designed to ensure that no antenna other than that furnished by the responsible party shall be used with the device.

And According to 15.247 (b), if transmitting antennas of directional gain greater than 6 dBi are used, the power shall be reduced by the amount in dB that the directional gain of the antenna exceeds 6 dBi.

■ Antenna Connector Construction

See section 2 – antenna information.

5 Test Results

Annex A. Conducted Emission

Standard:	FCC Part 15.247	Line:	L1
Test item:	Conducted Emission	Power:	AC 120 V/60 Hz
Test Mode:	Mode 1	Temp.(°C)/Hum.(%RH):	26(°C)/60 %RH
Description:			

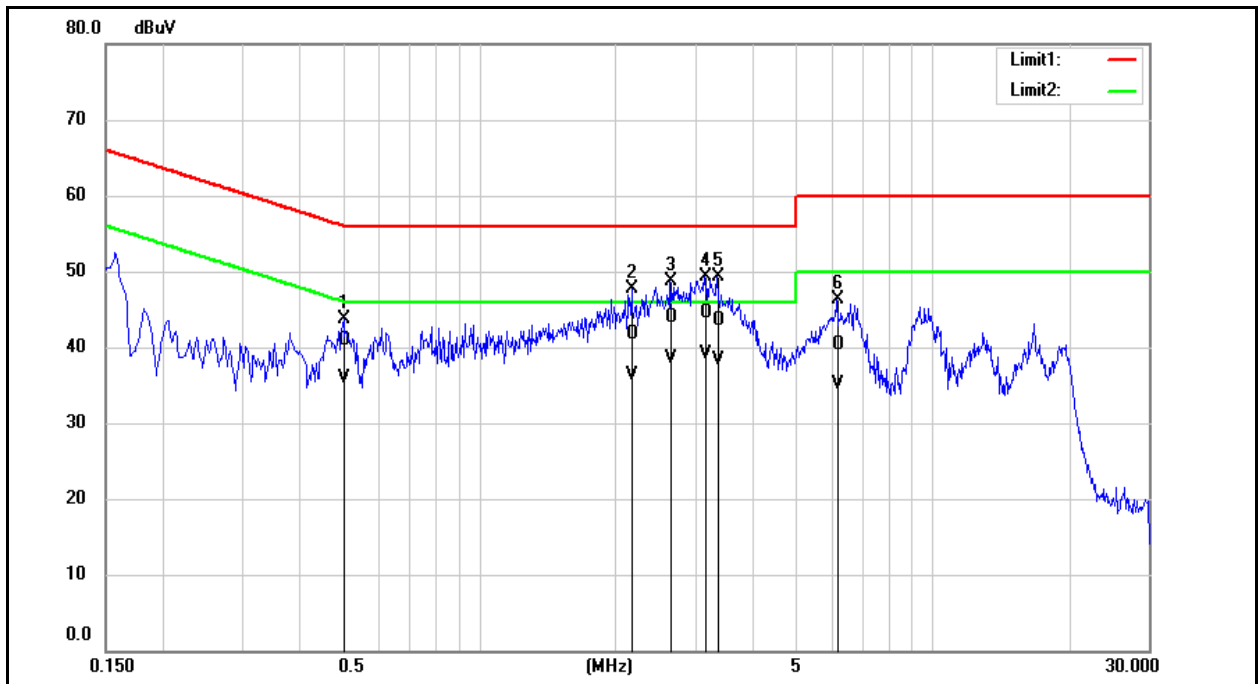

No.	Frequency (MHz)	QP reading (dBuV)	AVG reading (dBuV)	Correction factor (dB)	QP result (dBuV)	AVG result (dBuV)	QP limit (dBuV)	AVG limit (dBuV)	QP margin (dB)	AVG margin (dB)	Remark
1	0.5020	31.29	26.17	9.66	40.95	35.83	56.00	46.00	-15.05	-10.17	Pass
2	2.1780	32.07	26.67	9.72	41.79	36.39	56.00	46.00	-14.21	-9.61	Pass
3	2.6420	34.12	28.83	9.74	43.86	38.57	56.00	46.00	-12.14	-7.43	Pass
4	3.1460	34.73	29.41	9.75	44.48	39.16	56.00	46.00	-11.52	-6.84	Pass
5	3.3500	33.76	28.63	9.75	43.51	38.38	56.00	46.00	-12.49	-7.62	Pass
6	6.1740	30.45	25.35	9.82	40.27	35.17	60.00	50.00	-19.73	-14.83	Pass

Note: 1. Result (dBuV) = Correction factor (dB) + Reading(dBuV).

2. Correction factor (dB) = Cable loss (dB) + L.I.S.N. factor (dB).



Standard:	FCC Part 15.247	Line:	N
Test item:	Conducted Emission	Power:	AC 120 V/60 Hz
Test Mode:	Mode 1	Temp.(°C)/Hum.(%RH):	26(°C)/60 %RH
Description:			

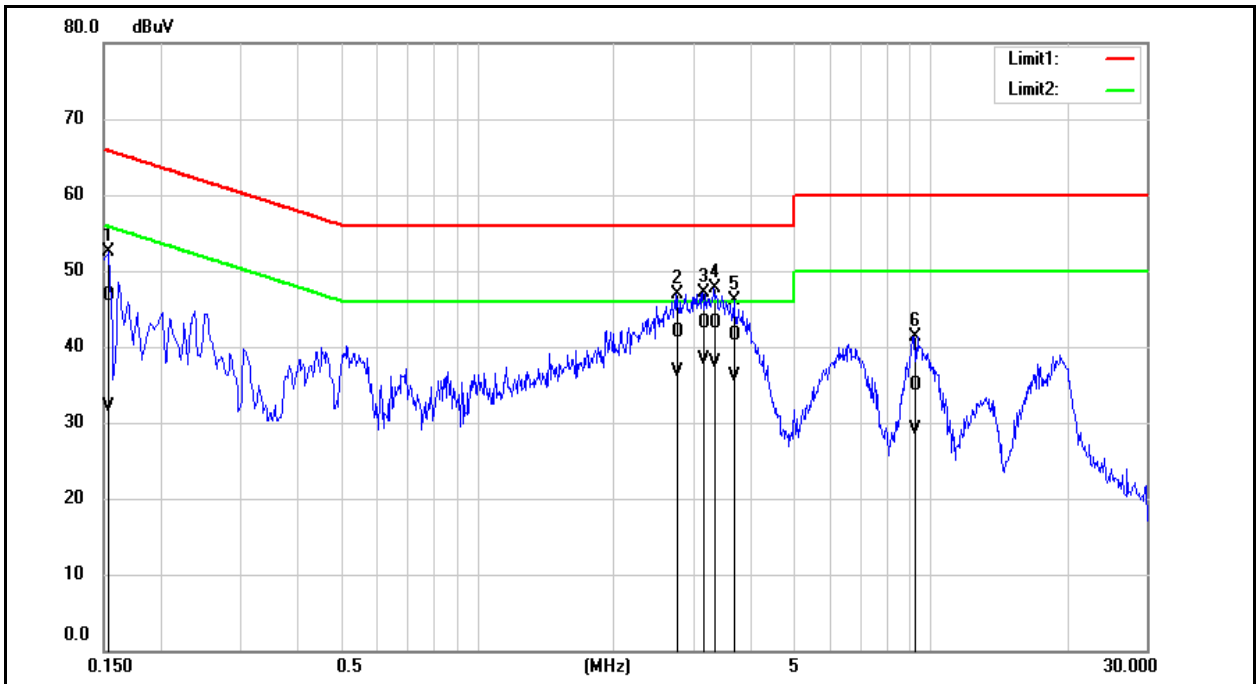

No.	Frequency (MHz)	QP reading (dBuV)	AVG reading (dBuV)	Correction factor (dB)	QP result (dBuV)	AVG result (dBuV)	QP limit (dBuV)	AVG limit (dBuV)	QP margin (dB)	AVG margin (dB)	Remark
1	0.1540	37.09	22.38	9.68	46.77	32.06	65.78	55.78	-19.01	-23.72	Pass
2	2.7540	32.05	26.90	9.77	41.82	36.67	56.00	46.00	-14.18	-9.33	Pass
3	3.1460	33.41	28.47	9.78	43.19	38.25	56.00	46.00	-12.81	-7.75	Pass
4	3.3340	33.30	28.11	9.78	43.08	37.89	56.00	46.00	-12.92	-8.11	Pass
5	3.6860	31.72	26.37	9.80	41.52	36.17	56.00	46.00	-14.48	-9.83	Pass
6	9.2060	25.01	19.12	9.94	34.95	29.06	60.00	50.00	-25.05	-20.94	Pass

Note: 1. Result (dBuV) = Correction factor (dB) + Reading(dBuV).
2. Correction factor (dB) = Cable loss (dB) + L.I.S.N. factor (dB).



Annex B. Conducted Test Results

Maximum Conducted Output Power Measurement

Test Mode	Mode 2				
Frequency (MHz)	Average Power		Peak Power		Limit (dBm)
	(dBm)	(W)	(dBm)	(W)	
2405	4.46	0.00279	4.52	0.00283	≤ 30
2440	4.60	0.00288	4.67	0.00293	≤ 30
2480	-4.00	0.00040	-3.18	0.00048	≤ 30

6 dB RF Bandwidth Measurement

Test Mode	Mode 2	
Frequency (MHz)	6 dB RF Bandwidth (kHz)	6 dB RF Bandwidth Limit (kHz)
2405	1520.000	≥ 500
2440	1535.000	≥ 500
2480	1575.000	≥ 500



■ Test Graphs

Mode 2: ZigBee Continuous TX mod

2405 MHz	<p>Agilent Spectrum Analyzer - Occupied BW</p> <p>Center Freq: 2.405000000 GHz Trig: Free Run #Atten: 10 dB Radio Std: None Radio Device: BTS</p> <p>Ref Offset 10.0 dB Ref 20.00 dBm</p> <p>Center 2.405 GHz #Res BW 100 kHz #VBW 300 kHz Span 3 MHz Sweep 1 ms</p> <p>Occupied Bandwidth 2.1637 MHz Total Power 11.8 dBm Transmit Freq Error -23.715 kHz OBW Power 99.00 % x dB Bandwidth 1.520 MHz x dB -6.00 dB</p>
2440 MHz	<p>Agilent Spectrum Analyzer - Occupied BW</p> <p>Center Freq: 2.440000000 GHz Trig: Free Run #Atten: 10 dB Radio Std: None Radio Device: BTS</p> <p>Ref Offset 10.0 dB Ref 20.00 dBm</p> <p>Center 2.44 GHz #Res BW 100 kHz #VBW 300 kHz Span 3 MHz Sweep 1 ms</p> <p>Occupied Bandwidth 2.2006 MHz Total Power 11.5 dBm Transmit Freq Error -24.476 kHz OBW Power 99.00 % x dB Bandwidth 1.535 MHz x dB -6.00 dB</p>
2480 MHz	<p>Agilent Spectrum Analyzer - Occupied BW</p> <p>Center Freq: 2.480000000 GHz Trig: Free Run #Atten: 10 dB Radio Std: None Radio Device: BTS</p> <p>Ref Offset 10.0 dB Ref 20.00 dBm</p> <p>Center 2.48 GHz #Res BW 100 kHz #VBW 300 kHz Span 3 MHz Sweep 1 ms</p> <p>Occupied Bandwidth 2.2186 MHz Total Power 2.99 dBm Transmit Freq Error -28.196 kHz OBW Power 99.00 % x dB Bandwidth 1.575 MHz x dB -6.00 dB</p>



Maximum Power Spectral Density Measurement

Test Mode	Mode 2	
Frequency (MHz)	Reading (dBm/ 3kHz)	Limit (dBm)
2405	-7.199	≤ 8
2440	-8.069	≤ 8
2480	-16.156	≤ 8



■ Test Graphs

Mode 2: ZigBee Continuous TX mod

2405 MHz



2440 MHz



2480 MHz

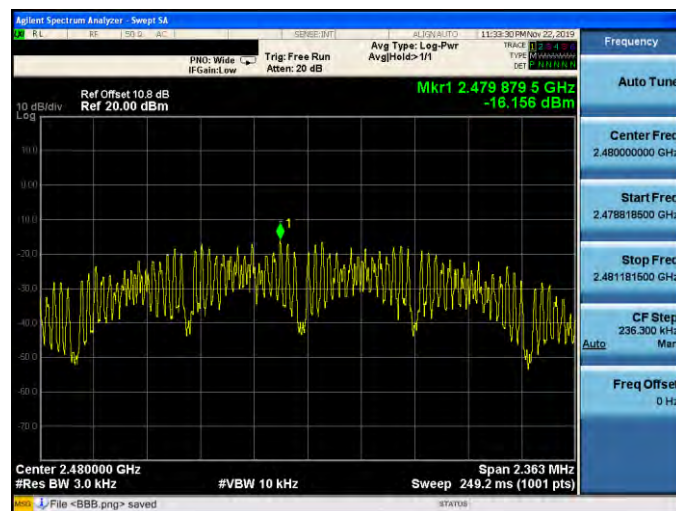

Out of Band Conducted Emissions Measurement

■ Test Graphs

Reference level

Mode 2: ZigBee Continuous TX mod	
2405 MHz	
2440 MHz	
2480 MHz	



Out of Band Conducted Emissions

Mode 2: ZigBee Continuous TX mod

2405 MHz

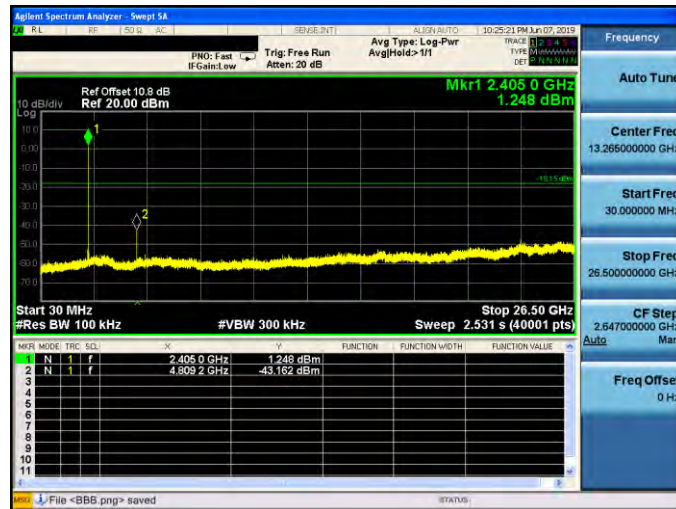

2440 MHz

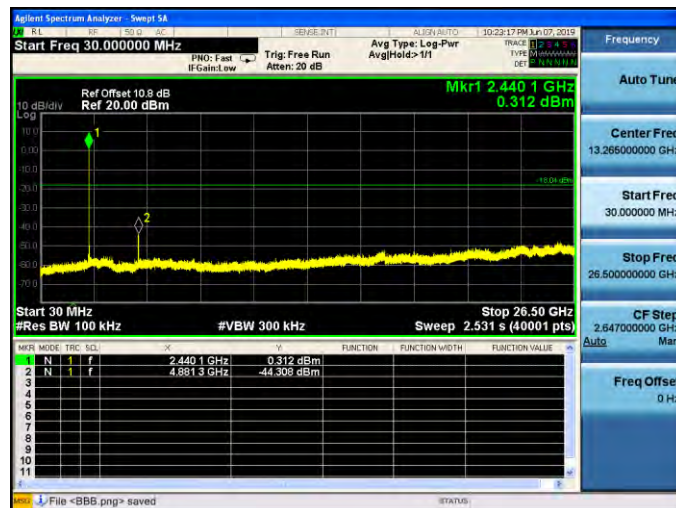

2480 MHz

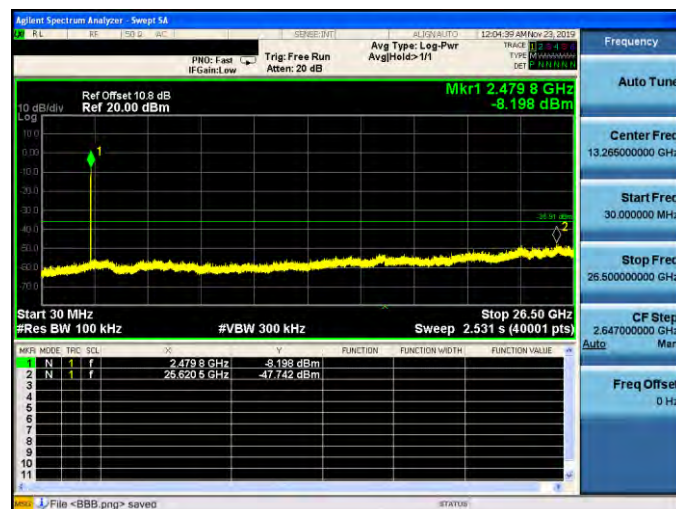

Conducted Band Edge

Mode 2: ZigBee Continuous TX mod

2405 MHz

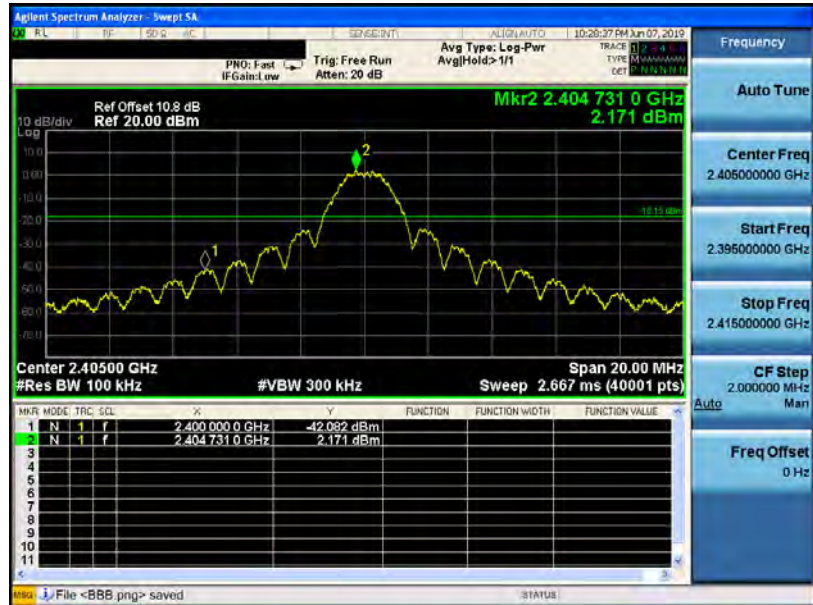

2480 MHz

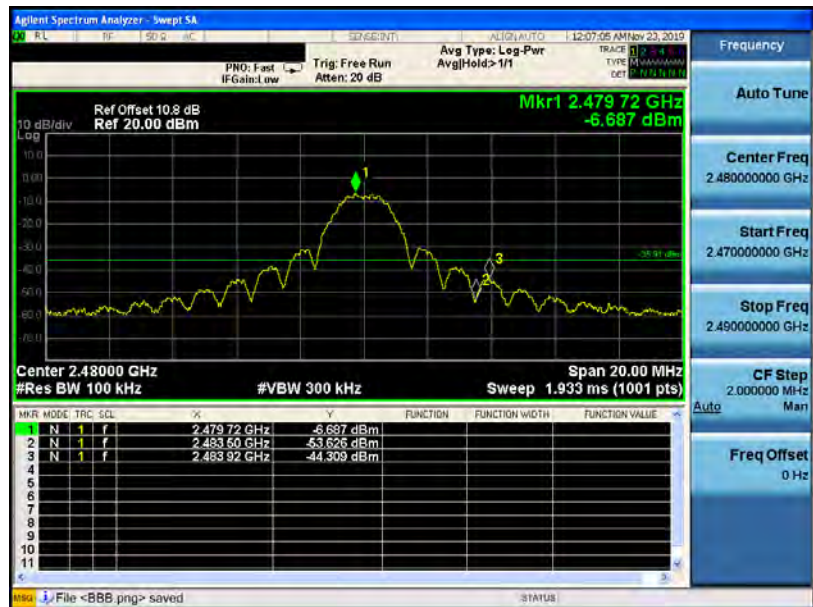

Annex C. Radiated Emission Measurement

Harmonic

Below 1 GHz

Standard:	FCC Part 15.247	Test Distance:	3 m
Test item:	Radiated Emission	Power:	DC 5 V
Mode:	Mode 2	Temp.(°C)/Hum.(%RH):	26(°C)/60 %RH
Frequency:	2405 MHz		

Frequency (MHz)	Reading (dBuV)	Correct Factor (dB/m)	Result (dBuV/m)	Limit (dBuV/m)	Margin (dB)	Remark	Ant.Polar. H / V
71.7100	46.51	-9.07	37.44	40.00	-2.56	QP	H
166.7700	34.66	-5.96	28.70	43.50	-14.80	QP	H
232.7300	40.64	-7.02	33.62	46.00	-12.38	QP	H
288.0200	40.28	-4.48	35.80	46.00	-10.20	QP	H
312.2700	37.99	-3.83	34.16	46.00	-11.84	QP	H
670.2000	28.98	3.07	32.05	46.00	-13.95	QP	H
71.7100	47.76	-9.07	38.69	40.00	-1.31	QP	V
93.0500	46.55	-11.94	34.61	43.50	-8.89	QP	V
166.7700	37.64	-5.96	31.68	43.50	-11.82	QP	V
233.7000	36.46	-6.94	29.52	46.00	-16.48	QP	V
324.8800	32.58	-3.62	28.96	46.00	-17.04	QP	V
797.2700	30.49	5.75	36.24	46.00	-9.76	QP	V

Note:1.Result (dBuV/m) = Correct Factor (dB/m) + Reading(dBuV).

Example: 37.44 = -9.07 + 46.51

2.Correction factor (dB/m) = Antenna Factor (dB/m) + Cable loss (dB) – Pre-Amplifier gain (dB).

3.When the peak results are less than average limit, so not need to evaluate the average.



Above 1 GHz

Standard:	FCC Part 15.247	Test Distance:	3 m
Test item:	Harmonic	Power:	DC 5 V
Frequency:	2405 MHz	Temp.(°C)/Hum.(%RH):	26(°C)/60 %RH
Mode:	Mode 2		
Ant.Polar.:	Horizontal		

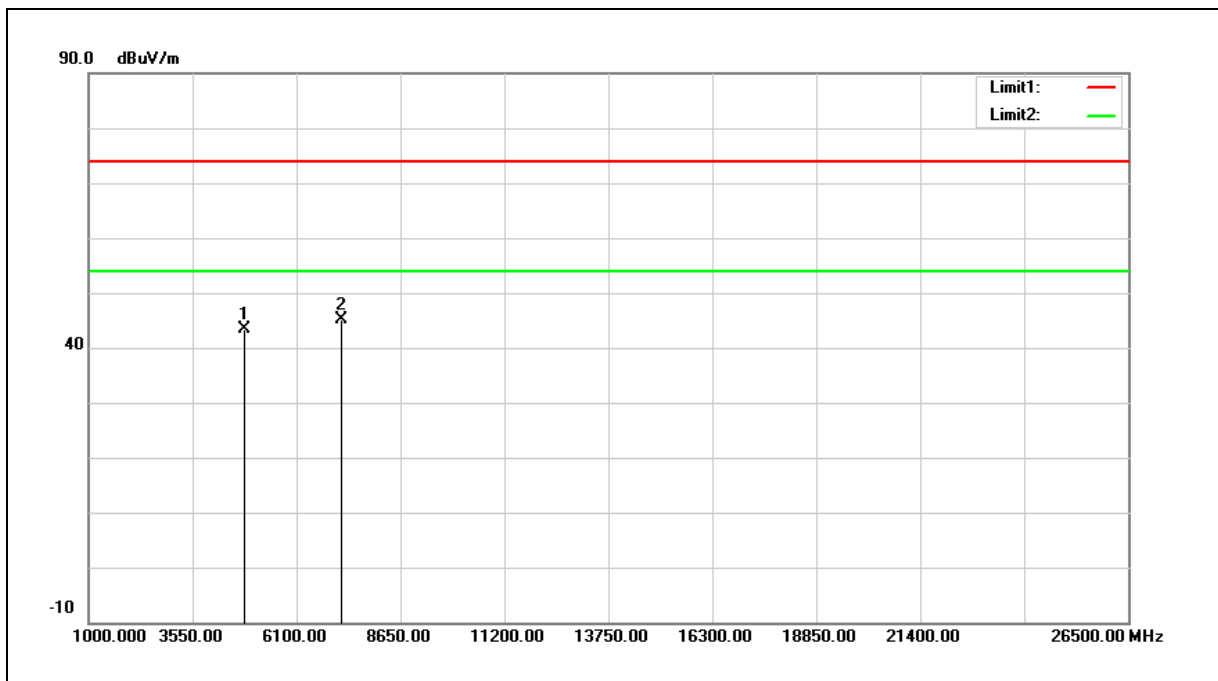

No.	Frequency (MHz)	Reading (dBuV)	Correct Factor (dB/m)	Result (dBuV/m)	Limit (dBuV/m)	Margin (dB)	Remark
1	4810.000	37.38	6.01	43.39	74.00	-30.61	peak
2	7215.000	32.84	12.24	45.08	74.00	-28.92	peak

Note:1.Result (dBuV/m) = Correct Factor (dB/m) + Reading(dBuV).

Example: 43.39 = 6.01 + 37.38

2.Correction factor (dB/m) = Antenna Factor (dB/m) + Cable loss (dB) – Pre-Amplifier gain (dB).

3.When the peak results are less than average limit, so not need to evaluate the average.



Standard:	FCC Part 15.247	Test Distance:	3 m
Test item:	Harmonic	Power:	DC 5 V
Frequency:	2405 MHz	Temp.(°C)/Hum.(%RH):	26(°C)/60 %RH
Mode:	Mode 2		
Ant.Polar.:	Vertical		

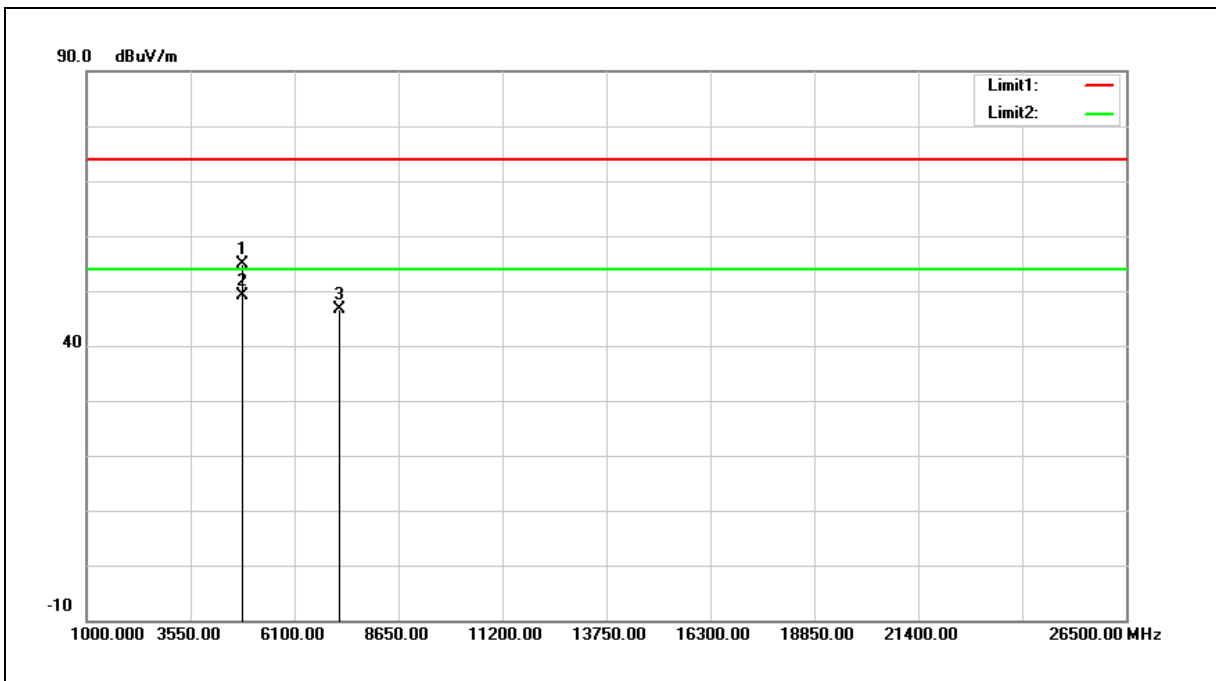

No.	Frequency (MHz)	Reading (dBuV)	Correct Factor (dB/m)	Result (dBuV/m)	Limit (dBuV/m)	Margin (dB)	Remark
1	4810.000	48.84	6.01	54.85	74.00	-19.15	peak
2	4810.000	43.11	6.01	49.12	54.00	-4.88	AVG
3	7215.000	34.38	12.24	46.62	74.00	-27.38	peak

Note:1.Result (dBuV/m) = Correct Factor (dB/m) + Reading(dBuV).

Example: 54.85 = 6.01 + 48.84

2.Correction factor (dB/m) = Antenna Factor (dB/m) + Cable loss (dB) – Pre-Amplifier gain (dB).

3.When the peak results are less than average limit, so not need to evaluate the average.



Standard:	FCC Part 15.247	Test Distance:	3 m
Test item:	Harmonic	Power:	DC 5 V
Frequency:	2440 MHz	Temp.(°C)/Hum.(%RH):	26(°C)/60 %RH
Mode:	Mode 2		
Ant.Polar.:	Horizontal		

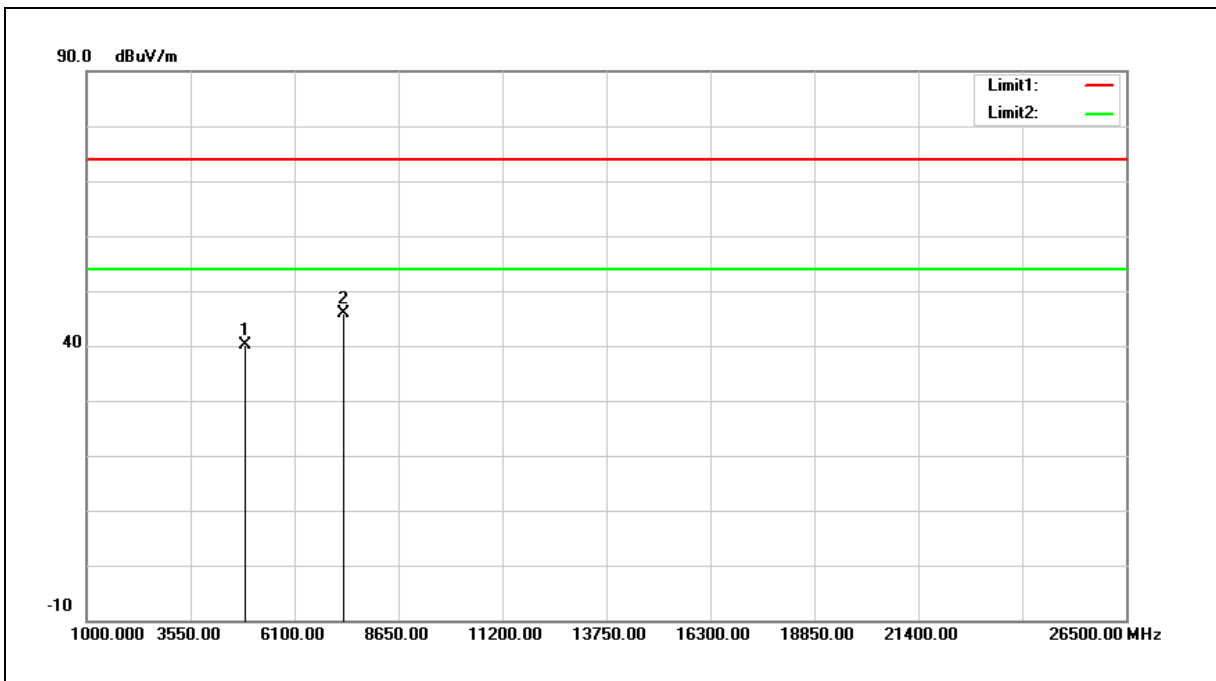

No.	Frequency (MHz)	Reading (dBuV)	Correct Factor (dB/m)	Result (dBuV/m)	Limit (dBuV/m)	Margin (dB)	Remark
1	4880.000	34.00	6.16	40.16	74.00	-33.84	peak
2	7320.000	33.31	12.47	45.78	74.00	-28.22	peak

- Note: 1. Result (dBuV/m) = Correct Factor (dB/m) + Reading(dBuV).
 2. Correction factor (dB/m) = Antenna Factor (dB/m) + Cable loss (dB) – Pre-Amplifier gain (dB).
 3. When the peak results are less than average limit, so not need to evaluate the average.



Standard:	FCC Part 15.247	Test Distance:	3 m
Test item:	Harmonic	Power:	DC 5 V
Frequency:	2440 MHz	Temp.(°C)/Hum.(%RH):	26(°C)/60 %RH
Mode:	Mode 2		
Ant.Polar.:	Vertical		

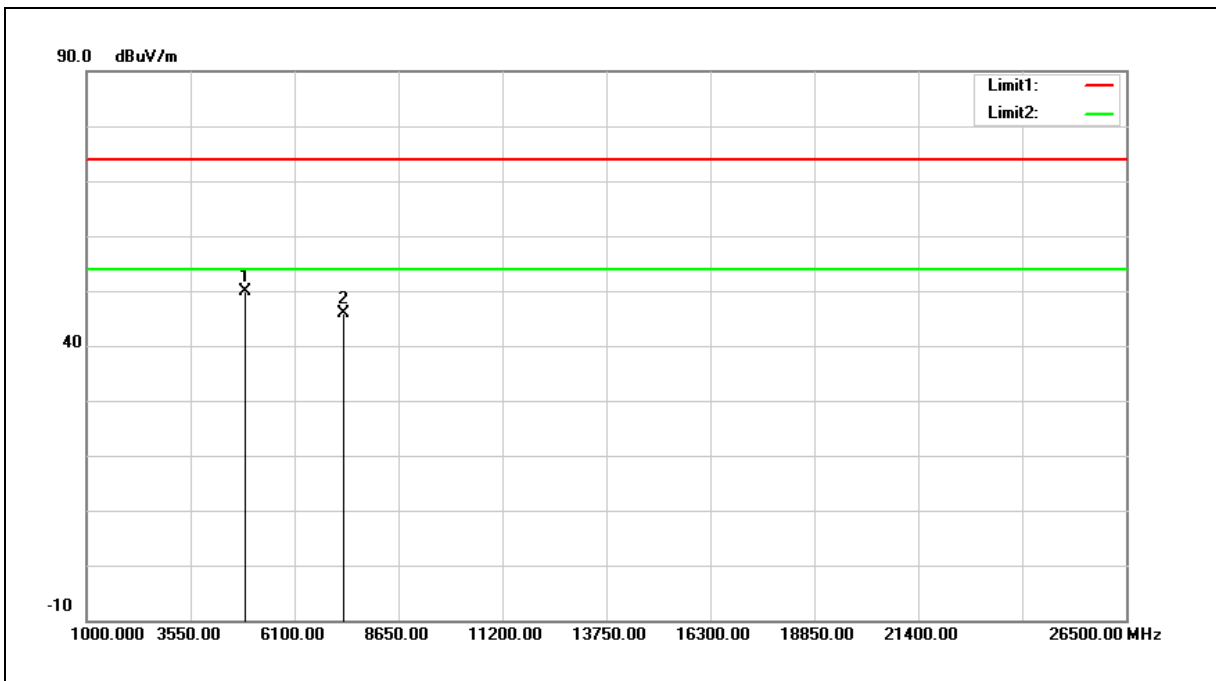

No.	Frequency (MHz)	Reading (dBuV)	Correct Factor (dB/m)	Result (dBuV/m)	Limit (dBuV/m)	Margin (dB)	Remark
1	4880.000	43.64	6.16	49.80	74.00	-24.20	peak
2	7320.000	33.33	12.47	45.80	74.00	-28.20	peak

Note:1.Result (dBuV/m) = Correct Factor (dB/m) + Reading(dBuV).

2.Correction factor (dB/m) = Antenna Factor (dB/m) + Cable loss (dB) – Pre-Amplifier gain (dB).

3. When the peak results are less than average limit, so not need to evaluate the average.



Standard:	FCC Part 15.247	Test Distance:	3 m
Test item:	Harmonic	Power:	DC 5 V
Frequency:	2480 MHz	Temp.(°C)/Hum.(%RH):	26(°C)/60 %RH
Mode:	Mode 2		
Ant.Polar.:	Horizontal		

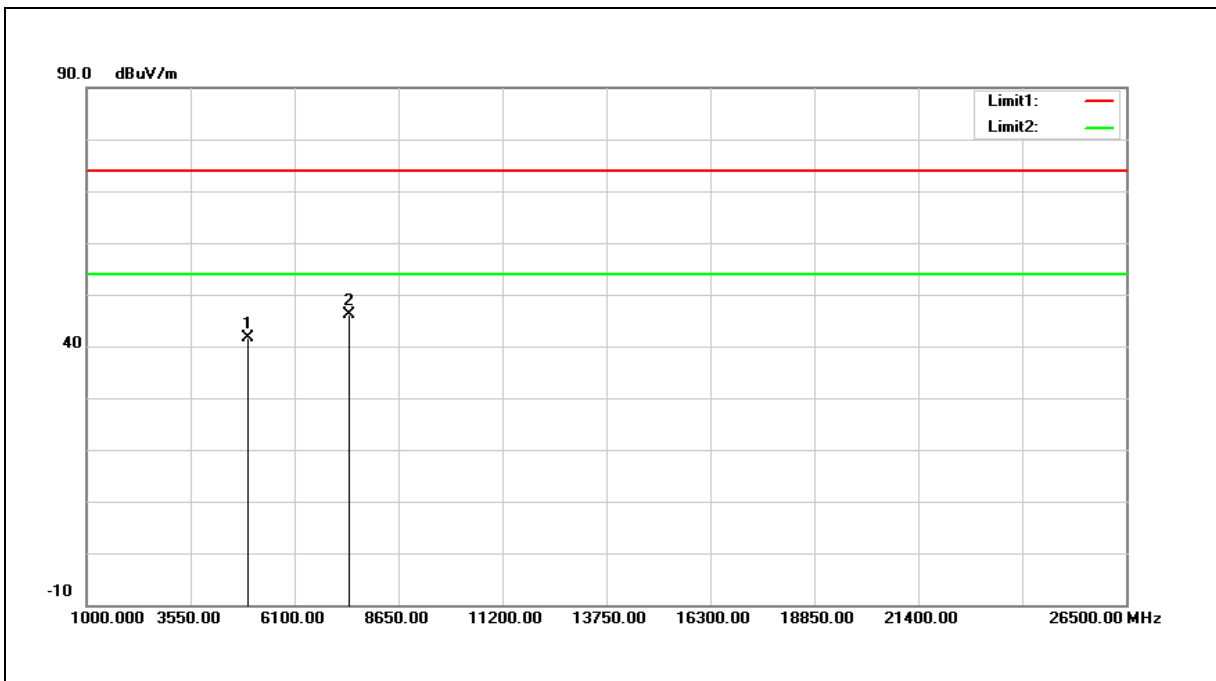

No.	Frequency (MHz)	Reading (dBuV)	Correct Factor (dB/m)	Result (dBuV/m)	Limit (dBuV/m)	Margin (dB)	Remark
1	4960.000	35.37	6.28	41.65	74.00	-32.35	peak
2	7440.000	33.12	13.13	46.25	74.00	-27.75	peak

Note:1.Result (dBuV/m) = Correct Factor (dB/m) + Reading(dBuV).

2.Correction factor (dB/m) = Antenna Factor (dB/m) + Cable loss (dB) – Pre-Amplifier gain (dB).

3. When the peak results are less than average limit, so not need to evaluate the average.



Standard:	FCC Part 15.247	Test Distance:	3 m
Test item:	Harmonic	Power:	DC 5 V
Frequency:	2480 MHz	Temp.(°C)/Hum.(%RH):	26(°C)/60 %RH
Mode:	Mode 2		
Ant.Polar.:	Vertical		

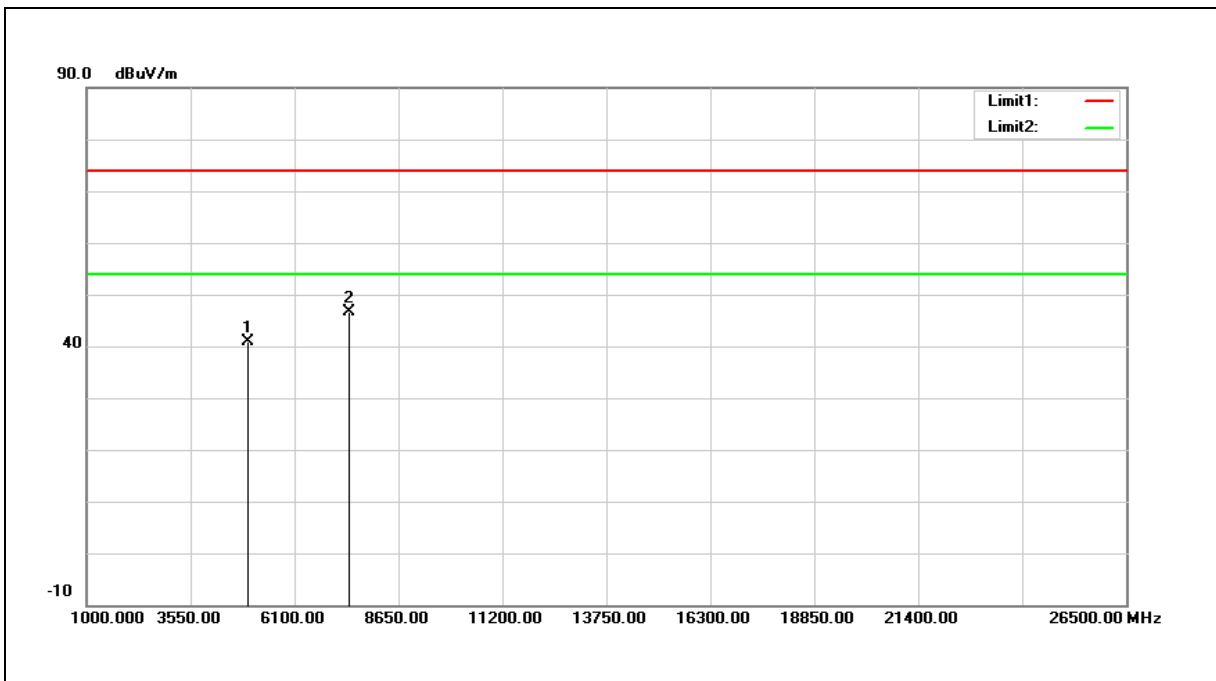

No.	Frequency (MHz)	Reading (dBuV)	Correct Factor (dB/m)	Result (dBuV/m)	Limit (dBuV/m)	Margin (dB)	Remark
1	4960.000	34.63	6.28	40.91	74.00	-33.09	peak
2	7440.000	33.49	13.13	46.62	74.00	-27.38	peak

Note:1.Result (dBuV/m) = Correct Factor (dB/m) + Reading(dBuV).

2.Correction factor (dB/m) = Antenna Factor (dB/m) + Cable loss (dB) – Pre-Amplifier gain (dB).

3. When the peak results are less than average limit, so not need to evaluate the average.



Band Edge

Standard:	FCC Part 15.247	Test Distance:	3 m
Test item:	Band edge	Power:	DC 5 V
Frequency:	2405 MHz	Temp.(°C)/Hum.(%RH):	26(°C)/60 %RH
Mode:	Mode 2		
Ant.Polar.:	Horizontal		

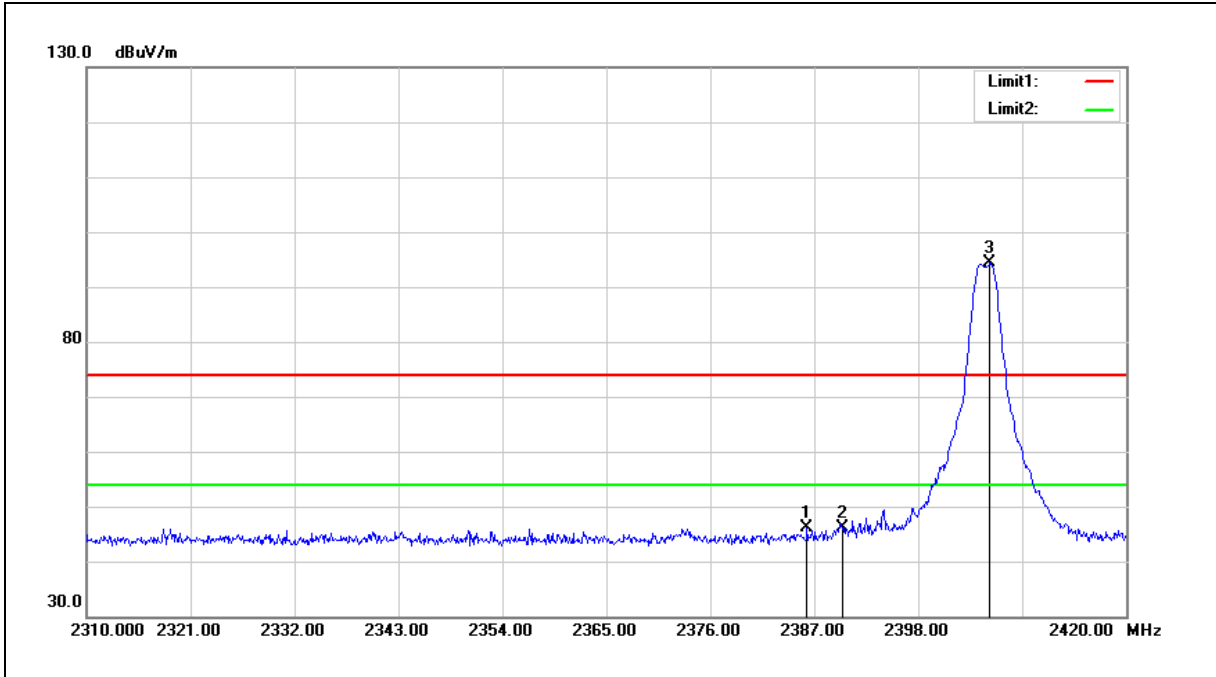

No.	Frequency (MHz)	Reading (dBuV)	Correct Factor (dB/m)	Result (dBuV/m)	Limit (dBuV/m)	Margin (dB)	Remark
1	2386.230	47.10	-0.97	46.13	74.00	-27.87	peak
2	2390.000	46.95	-0.94	46.01	74.00	-27.99	peak
3	2405.590	95.20	-0.87	94.33	--	--	peak

Note:1.Result (dBuV/m) = Correct Factor (dB/m) + Reading(dBuV).

2.Correction factor (dB/m) = Antenna Factor (dB/m) + Cable loss (dB) – Pre-Amplifier gain (dB).

3. When the peak results are less than average limit, so not need to evaluate the average.



Standard:	FCC Part 15.247	Test Distance:	3 m
Test item:	Band edge	Power:	DC 5 V
Frequency:	2405 MHz	Temp.(°C)/Hum.(%RH):	26(°C)/60 %RH
Mode:	Mode 2		
Ant.Polar.:	Vertical		

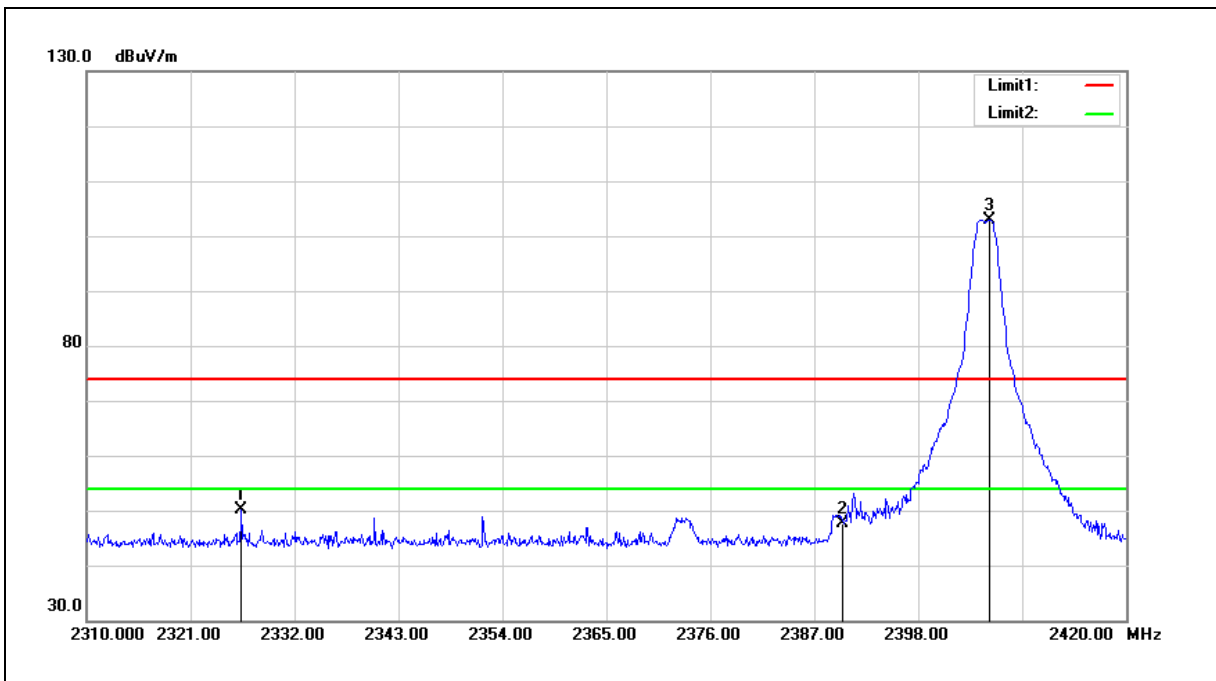

No.	Frequency (MHz)	Reading (dBuV)	Correct Factor (dB/m)	Result (dBuV/m)	Limit (dBuV/m)	Margin (dB)	Remark
1	2326.390	51.40	-1.23	50.17	74.00	-23.83	peak
2	2390.000	48.65	-0.94	47.71	74.00	-26.29	peak
3	2405.590	103.85	-0.87	102.98	--	--	peak

Note:1.Result (dBuV/m) = Correct Factor (dB/m) + Reading(dBuV).

2.Correction factor (dB/m) = Antenna Factor (dB/m) + Cable loss (dB) – Pre-Amplifier gain (dB).

3. When the peak results are less than average limit, so not need to evaluate the average.

Standard:	FCC Part 15.247	Test Distance:	3 m
Test item:	Band edge	Power:	DC 5 V
Frequency:	2480 MHz	Temp.(°C)/Hum.(%RH):	26(°C)/60 %RH
Mode:	Mode 2		
Ant.Polar.:	Horizontal		

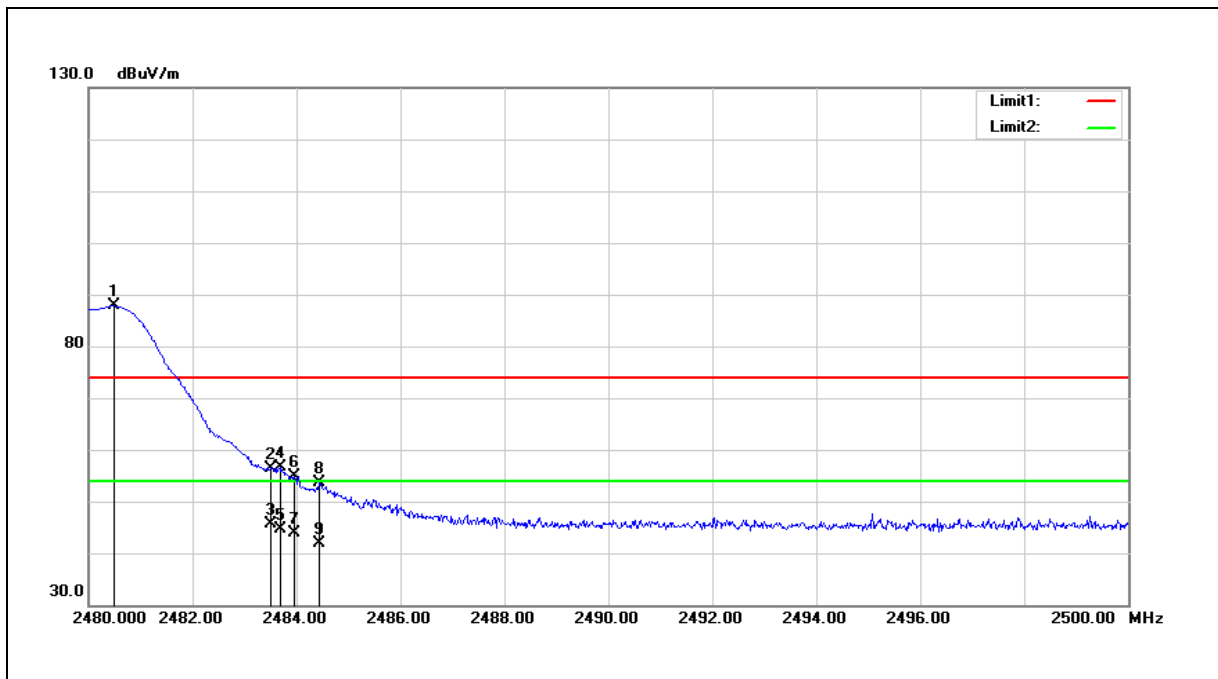

No.	Frequency (MHz)	Reading (dBuV)	Correct Factor (dB/m)	Result (dBuV/m)	Limit (dBuV/m)	Margin (dB)	Remark
1	2480.480	88.13	-0.36	87.77	--	--	peak
2	2483.500	56.61	-0.35	56.26	74.00	-17.74	peak
3	2483.500	45.93	-0.35	45.58	54.00	-8.42	AVG
4	2483.680	56.94	-0.35	56.59	74.00	-17.41	peak
5	2483.680	45.00	-0.35	44.65	54.00	-9.35	AVG
6	2483.960	55.20	-0.34	54.86	74.00	-19.14	peak
7	2483.960	44.22	-0.34	43.88	54.00	-10.12	AVG
8	2484.440	53.86	-0.34	53.52	74.00	-20.48	peak
9	2484.440	42.33	-0.34	41.99	54.00	-12.01	AVG

Note:1.Result (dBuV/m) = Correct Factor (dB/m) + Reading(dBuV).

2.Correction factor (dB/m) = Antenna Factor (dB/m) + Cable loss (dB) – Pre-Amplifier gain (dB).

3. When the peak results are less than average limit, so not need to evaluate the average.



Standard:	FCC Part 15.247	Test Distance:	3 m
Test item:	Band edge	Power:	DC 5 V
Frequency:	2480 MHz	Temp.(°C)/Hum.(%RH):	26(°C)/60 %RH
Mode:	Mode 2		
Ant.Polar.:	Vertical		

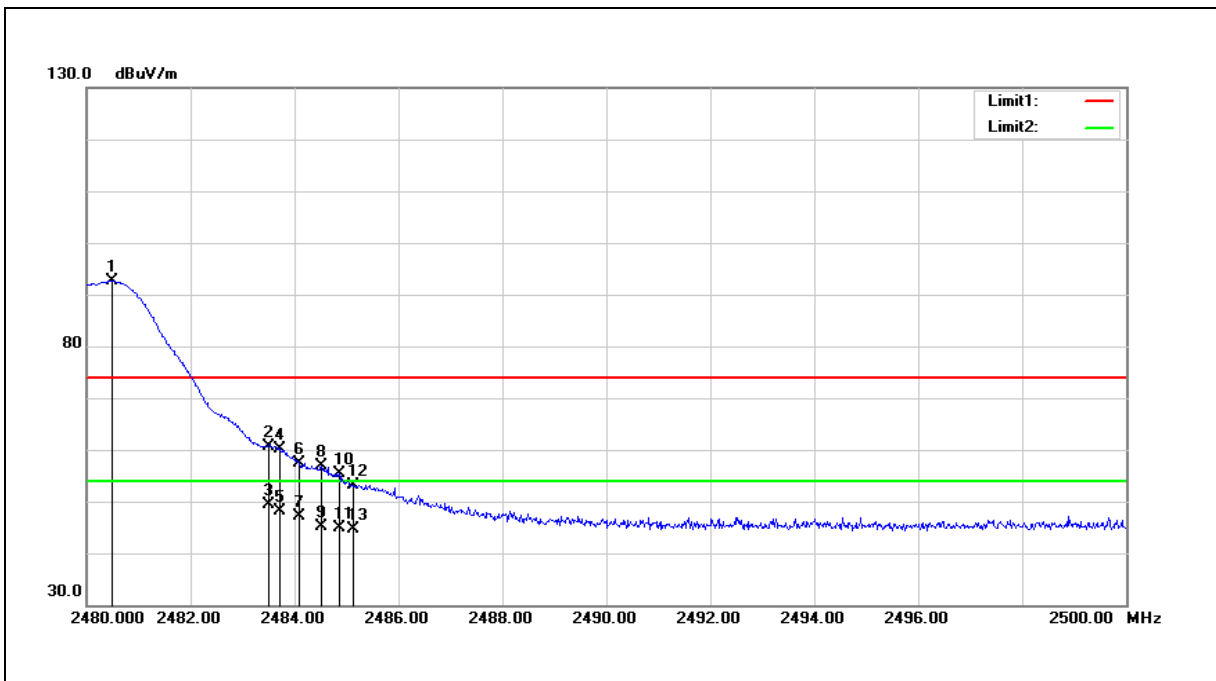



Standard:	FCC Part 15.247	Test Distance:	3 m
Test item:	Band edge	Power:	DC 5 V
Frequency:	2480 MHz	Temp.(°C)/Hum.(%RH):	26(°C)/60 %RH
Mode:	Mode 2		
Ant.Polar.:	Vertical		

No.	Frequency (MHz)	Reading (dBuV)	Correct Factor (dB/m)	Result (dBuV/m)	Limit (dBuV/m)	Margin (dB)	Remark
1	2480.500	92.94	-0.36	92.58	--	--	peak
2	2483.500	60.96	-0.35	60.61	74.00	-13.39	peak
3	2483.500	49.64	-0.35	49.29	54.00	-4.71	AVG
4	2483.720	60.56	-0.35	60.21	74.00	-13.79	peak
5	2483.720	48.48	-0.35	48.13	54.00	-5.87	AVG
6	2484.100	57.79	-0.34	57.45	74.00	-16.55	peak
7	2484.100	47.43	-0.34	47.09	54.00	-6.91	AVG
8	2484.520	57.28	-0.34	56.94	74.00	-17.06	peak
9	2484.520	45.54	-0.34	45.20	54.00	-8.80	AVG
10	2484.860	55.69	-0.34	55.35	74.00	-18.65	peak
11	2484.860	45.23	-0.34	44.89	54.00	-9.11	AVG
12	2485.120	53.47	-0.34	53.13	74.00	-20.87	peak
13	2485.120	44.85	-0.34	44.51	54.00	-9.49	AVG

Note:1.Result (dBuV/m) = Correct Factor (dB/m) + Reading(dBuV).

2.Correction factor (dB/m) = Antenna Factor (dB/m) + Cable loss (dB) – Pre-Amplifier gain (dB).

3. When the peak results are less than average limit, so not need to evaluate the average.

--- END---