



# SGS-CSTC Standards Technical Services (Shanghai) Co., Ltd.

588 West Jindu Road, Xinqiao, Songjiang, 201612 Shanghai, China  
Telephone: +86 (0) 21 6191 5666  
Fax: +86 (0) 21 6191 5678  
ee.shanghai@sgs.com

Report No.: SHEM160700438401  
Page: 1 of 18

## 1 Cover Page

# RF REPORT

<b>Application No.:</b>	SHEM1607004384CR
<b>Applicant:</b>	NINGBO DIYA ELECTRIC APPLIANCE CO.,LTD.
<b>FCC ID:</b>	2AC2CST1
<b>Equipment Under Test (EUT):</b> <b>NOTE:</b> The following sample(s) submitted was/were identified on behalf of the client as	
<b>Product Name:</b>	Transmitter
<b>Model No.:</b>	ST1(DR-1262)
<b>Standards:</b>	FCC PART 15 Subpart C: 2015
<b>Date of Receipt:</b>	2016-07-07
<b>Date of Test:</b>	2016-07-08 to 2016-07-15
<b>Date of Issue:</b>	2016-07-27
<b>Test Result:</b>	<b>PASS *</b>

In the configuration tested, the EUT detailed in this report complied with the standards specified above.



**Parlam Zhan**  
**E&E Section Manager**  
**SGS-CSTC (Shanghai) Co., Ltd.**

The manufacturer should ensure that all products in series production are in conformity with the product sample detailed in this report. If the product in this report is used in any configuration other than that detailed in the report, the manufacturer must ensure the new system complies with all relevant standards.



The report must not be used by the client to claim product certification, approval, or endorsement by NVLAP, NIST, or any agency of the federal government. All test results in this report can be traceable to National or International Standards.

This document is issued by the Company subject to its General Conditions of Service printed overleaf, available on request or accessible at [www.sgs.com/terms\\_and\\_conditions.htm](http://www.sgs.com/terms_and_conditions.htm) and, for electronic format documents, subject to Terms and Conditions for Electronic Documents at [www.sgs.com/terms\\_e-document.htm](http://www.sgs.com/terms_e-document.htm). Attention is drawn to the limitation of liability, indemnification and jurisdiction issues defined therein. Any holder of this document is advised that information contained hereon reflects the Company's findings at the time of its intervention only and within the limits of Client's instructions, if any. The Company's sole responsibility is to its Client and this document does not exonerate parties to a transaction from exercising all their rights and obligations under the transaction documents. This document cannot be reproduced except in full, without prior written approval of the Company. Any unauthorized alteration, forgery or falsification of the content or appearance of this document is unlawful and offenders may be prosecuted to the fullest extent of the law. Unless otherwise stated the results shown in this test report refer only to the sample(s) tested and such sample(s) are retained for 90 days only.



## 2 Version

Revision Record				
Version	Chapter	Date	Modifier	Remark
00	/	2016-07-27	/	Original

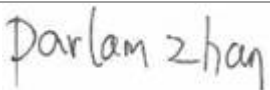
Authorized for issue by:				
Engineer		Eddy Zong _____ Print Name		 _____ Print Name
Clerk		Vincent Zhu _____ Print Name		 _____ Print Name
Reviewer		Parlam Zhan _____ Print Name		 _____ Print Name

### 3 Test Summary

Test Item	FCC Requirement	Test method	Result
Antenna Requirement	Part 15.203	/	PASS
Conducted Emission	Part 15.207	ANSI C63.10 (2013) Section 6.2	N/A
Field Strength of the Fundamental	Part 15.231 (b)	ANSI C63.10 (2013) Section 6.4	PASS
Radiated Spurious emissions	Part 15.209 15.231(b)	ANSI C63.10 (2013) Section 6.4&6.5&6.6	PASS
20dB Bandwidth	Part 15.231 (c)	ANSI C63.10 (2013) Section 6.9.2	PASS
99% Occupied Bandwidth	---	RSS-Gen Clause 4.6.1	PASS
Dwell Time	Part 15.231 (a)	ANSI C63.10 (2013) Section 7.8.4	PASS

Remark: 1. This EUT is powered by battery only; therefore the AC Conducted Emission test is not applicable.



## 4 Contents

	Page
<b>1 COVER PAGE.....</b>	<b>1</b>
<b>2 VERSION.....</b>	<b>2</b>
<b>3 TEST SUMMARY.....</b>	<b>3</b>
<b>4 CONTENTS.....</b>	<b>4</b>
<b>5 GENERAL INFORMATION.....</b>	<b>5</b>
5.1 CLIENT INFORMATION.....	5
5.2 GENERAL DESCRIPTION OF E.U.T.....	5
5.3 TECHNICAL SPECIFICATIONS:.....	5
5.4 DESCRIPTION OF SUPPORT UNITS.....	5
5.5 DETAILS OF TEST MODE.....	5
5.6 TEST LOCATION.....	5
5.7 TEST FACILITY.....	6
5.8 MEASUREMENT UNCERTAINTY.....	6
<b>6 EQUIPMENTS USED DURING TEST.....</b>	<b>7</b>
<b>7 TEST RESULTS AND MEASUREMENT DATA.....</b>	<b>8</b>
7.1 ANTENNA REQUIREMENT.....	8
7.2 CONDUCTED EMISSIONS.....	9
7.3 SPURIOUS EMISSIONS.....	10
7.3.1 <i>Field Strength of the Fundamental Signal</i> .....	12
7.3.2 <i>Spurious Emissions</i> .....	13
7.4 20DB BANDWIDTH.....	16
7.5 DWELL TIME.....	17
<b>8 TEST SETUP PHOTOGRAPHS.....</b>	<b>18</b>
<b>9 EUT CONSTRUCTIONAL DETAILS.....</b>	<b>18</b>

## 5 General Information

### 5.1 Client Information

Applicant:	NINGBO DIYA ELECTRIC APPLIANCE CO.,LTD.
Address of Applicant:	SIMEN TOWN YUYAO CITY ZHEJIANG CHINA
Manufacturer:	NINGBO DIYA ELECTRIC APPLIANCE CO.,LTD.
Address of Manufacturer:	SIMEN TOWN YUYAO CITY ZHEJIANG CHINA
Factory:	NINGBO DIYA ELECTRIC APPLIANCE CO.,LTD.
Address of Factory:	SIMEN TOWN YUYAO CITY ZHEJIANG CHINA

### 5.2 General Description of E.U.T.

Product Description:	Portable Product with 433MHz remote control function
Brand Name:	STANLEY
Power Supply:	DC 3V by a CR2032 battery for transmitter

### 5.3 Technical Specifications:

Operation Frequency:	433.92MHz
Modulation Technique:	ASK
Number of Channel:	1
Antenna Type	PCB antenna

### 5.4 Description of Support Units

The EUT has been tested independently

### 5.5 Details of Test Mode

Test Mode	Detail description of the test mode
Engineering Mode	Keeps EUT working in continuous transmitting mode
Standby mode	The EUT power switch on, all function idle.

### 5.6 Test Location

All tests were performed at:

SGS-CSTC Standards Technical Services (Shanghai) Co., Ltd. E&E Lab  
588 West Jindu Road, Xinqiao, Songjiang, 201612 Shanghai, China

Tel: +86 21 6191 5666

Fax: +86 21 6191 5678

No tests were sub-contracted.

## 5.7 Test Facility

The test facility is recognized, certified, or accredited by the following organizations:

- **CNAS (No. CNAS L0599)**

CNAS has accredited SGS-CSTC Standards Technical Services (Shanghai) Co., Ltd. to ISO/IEC 17025:2005 General Requirements for the Competence of Testing and Calibration Laboratories (CNAS-CL01 Accreditation Criteria for the Competence of Testing and Calibration Laboratories) for the competence in the field of testing. Date of expiry: 2017-07-14.

- **FCC – Registration No.: 402683**

SGS-CSTC Standards Technical Services (Shanghai) Co., Ltd. has been registered and fully described in a report filed with the Federal Communications Commission (FCC). The acceptance letter from the FCC is maintained in our files. Registration No.: 402683, Expiry Date: 2017-09-16.

- **Industry Canada (IC) – IC Assigned Code: 8617A**

The 3m Semi-anechoic chamber of SGS-CSTC Standards Technical Services (Shanghai) Co., Ltd. has been registered by Certification and Engineering Bureau of Industry Canada for radio equipment testing with Registration No.: 8617A-1. Expiry Date: 2017-06-18.

- **VCCI (Member No.: 3061)**

The 3m Semi-anechoic chamber and Shielded Room of SGS-CSTC Standards Technical Services (Shanghai) Co., Ltd. has been registered in accordance with the Regulations for Voluntary Control Measures with Registration No.: R-3868, C-4336, T-2221, G-830 respectively. Date of Expiry: 2017-11-16.

## 5.8 Measurement Uncertainty

No.	Parameter	Measurement Uncertainty
1	Radio Frequency	$< \pm 1 \times 10^{-5}$
2	Total RF power, conducted	$< \pm 1.5$ dB
3	RF power density, conducted	$< \pm 3$ dB
4	Spurious emissions, conducted	$< \pm 3$ dB
5	All emissions, radiated	$< \pm 6$ dB (Below 1GHz) $< \pm 6$ dB (Above 1GHz)
6	Temperature	$< \pm 1^{\circ}\text{C}$
7	Humidity	$< \pm 5$ %
8	DC and low frequency voltages	$< \pm 3$ %

## 6 Equipments Used during Test

Item	Test Equipment	Manufacturer	Model No.	Serial No.	Cal. Date	Cal. Due date
1	Power meter	Rohde & Schwarz	NRP	101641	2016-01-14	2017-01-13
2	Power Sensor	Rohde & Schwarz	NRP-Z22	101096	2015-08-06	2016-08-05
3	Spectrum Analyzer	Rohde & Schwarz	FSP-30	2705121009	2016-01-14	2017-01-13
4	EMI test receiver	Rohde & Schwarz	ESU40	100109	2015-02-13	2017-01-15
5	Active Loop Antenna (9kHz to 30MHz)	Rohde & Schwarz	FMZB1519	1519-034	2015-02-07	2017-01-15
6	Broadband UHF-VHF ANTENNA (25MHz to 2GHz)	SCHWARZBECK	VULB9168	9168-313	2015-02-07	2017-01-15
7	Ultra broadband antenna (25MHz to 3GHz)	Rohde & Schwarz	HL562	100227	2015-08-30	2016-08-29
8	Horn Antenna (1GHz to 18GHz)	Rohde & Schwarz	HF906	100284	2015-02-07	2017-01-15
9	Horn Antenna (1GHz to 18GHz)	SCHWARZBECK	BBHA9120D	9120D-679	2015-02-07	2017-01-15
10	Horn Antenna (14GHz to 40GHz)	SCHWARZBECK	BBHA 9170	BBHA917-0373	2015-02-13	2017-01-15
11	Pre-amplifier (9KHz – 2GHz)	LNA6900	TESEQ	71033	/	/
12	Pre-amplifier (1GHz – 26.5GHz)	SCHWARZBECK	SCU-F0118- G40-BZ4- CSS(F)	10001	2016-01-14	2017-01-13
13	Pre-amplifier (14GHz – 40GHz)	SCHWARZBECK	SCU-F1840- G35-BZ3- CSS(F)	10001	2016-01-14	2017-01-13
14	Tunable Notch Filter	Wainwright instruments GmbH	WRCT800.0/880 .0-0.2/40-5SSK	170397 169777 169780 192507	/	/
15	High pass Filter	FSCW	HP 12/2800- 5AA2	19A45-02	/	/
16	High-low temperature cabinet	Suzhou Zhihe	TL-40	50110050	2015-09-11	2016-09-10
17	AC power stabilizer	WOCEN	6100	51122	2016-01-14	2017-01-13
18	DC power	QJE	QJ30003SII	3573/4/3	2016-01-14	2017-01-13
19	Signal Generator (Interferer)	Rohde & Schwarz	SMR40	100555	2015-08-13	2016-08-12
20	Signal Generator (Blocker)	Rohde & Schwarz	SMJ100A	101394	2016-01-14	2017-01-13
21	Splitter	Anritsu	MA1612A	M12265	/	/
22	Coupler	e-meca	803-S-1	900-M01	/	/

## 7 Test results and Measurement Data

### 7.1 Antenna Requirement

15.203 Requirement:

An intentional radiator shall be designed to ensure that no antenna other than that furnished by the responsible party shall be used with the device. The use of a permanently attached antenna or of an antenna that uses a unique coupling to the intentional radiator, the manufacturer may design the unit so that a broken antenna can be replaced by the user, but the use of a standard antenna jack or electrical connector is prohibited.

The antenna is integrated and no consideration of replacement.

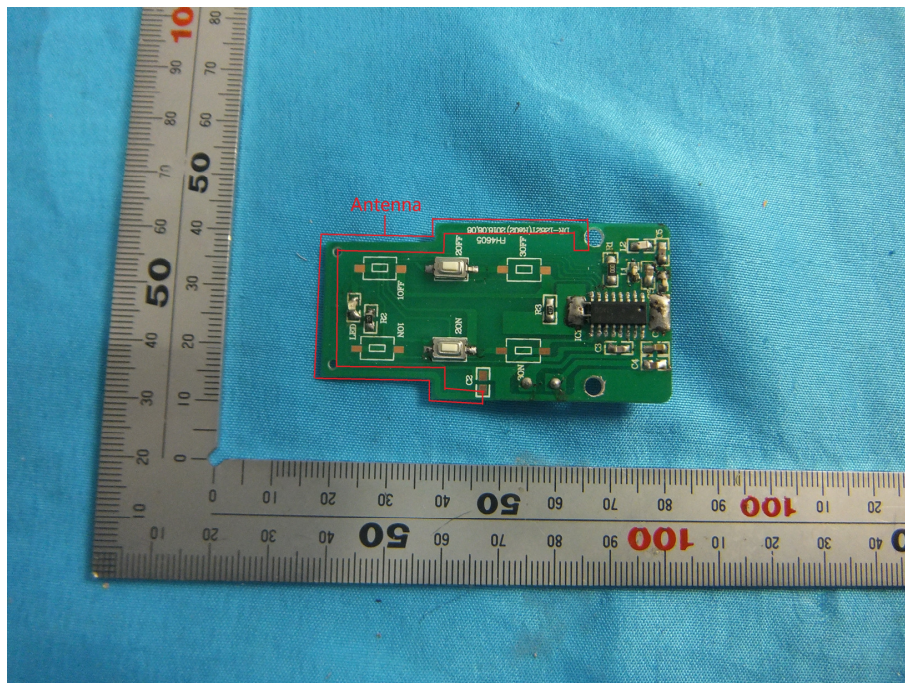



## 7.2 Conducted Emissions

**Frequency Range:** 150 KHz to 30 MHz

**Limit:**

Frequency range MHz	Class B Limits: dB (µV)	
	Quasi-peak	Average
0.15 to 0.50	66 to 56	56 to 46
0.50 to 5	56	46
5 to 30	60	50

Note1: The limit decreases linearly with the logarithm of the frequency in the range 0.15 MHz to 0.50MHz.  
Note2: The lower limit is applicable at the transition frequency.

**Test Setup:**

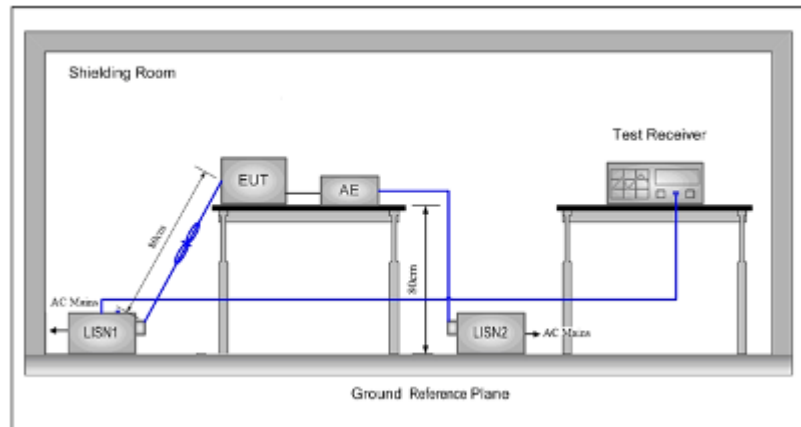

**Test Procedure:**

- The mains terminal disturbance voltage was measured with the EUT in a shielded room.
- The EUT was connected to AC power source through a LISN 1 (Line Impedance Stabilization Network) which provides  $50\Omega/50\mu\text{H} + 5\Omega$  linear impedance. The power cables of all other units of the EUT were connected to a second LISN, which was bonded to the ground reference plane in the same way as the LISN for the unit being measured. A multiple socket outlet strip was used to connect multiple power cables to a single LISN provided the rating of the LISN was not exceeded.
- The tabletop EUT was placed upon a non-metallic table 0.8m above the ground reference plane. And for floor-standing arrangement, the EUT was placed on the horizontal ground reference plane, but separated from metallic contact with the ground reference plane by 0.1m of insulation.
- The test was performed with a vertical ground reference plane. The rear of the EUT shall be 0.4 m from the vertical ground reference plane. The vertical ground reference plane was bonded to the horizontal ground reference plane. The LISN was placed 0.8 m from the boundary of the unit under test and bonded to a ground reference plane for LISN mounted on top of the ground reference plane. This distance was between the closest points of the LISN and the EUT. The mains lead of EUT excess 0.8m was folded back and forth parallel to the lead so as to form a horizontal bundle with a length between 0.3m and 0.4m. All other units of the EUT and associated equipment were at least 0.8 m from the LISN.

**Test Results:** N/A

**Measurement Data:**

This EUT is powered by battery only; therefore the AC Conducted Emission test is not applicable.

### 7.3 Spurious Emissions

**Test frequency range:** 9KHz – 5GHz

**Test Site:**

Measurement Distance: 3m (Semi-Anechoic Chamber)

**Receiver Setup:**

Frequency	Detector	RBW	VBW	Remark
0.009MHz-0.015MHz	Quasi-peak	200Hz	1KHz	Quasi-peak
0.015MHz-30MHz	Quasi-peak	9kHz	30KHz	Quasi-peak
30MHz-1GHz	Quasi-peak	120 kHz	300KHz	Quasi-peak
Above 1GHz	Peak	1MHz	3MHz	Peak
	Peak	1MHz	10Hz	Average

**Limit:**

**(Spurious Emissions)**

Frequency	Field strength (microvolt/meter)	Limit (dBuV/m )	Remark	Measurement distance (m)
0.009MHz-0.490MHz	2400/F(kHz)	-	Quasi-peak	300
0.490MHz-1.705MHz	24000/F(kHz)	-	Quasi-peak	30
1.705MHz-30MHz	30	-	Quasi-peak	30
30MHz-88MHz	100	40.0	Quasi-peak	3
88MHz-216MHz	150	43.5	Quasi-peak	3
216MHz-960MHz	200	46.0	Quasi-peak	3
960MHz-1GHz	500	54.0	Quasi-peak	3
Above 1GHz	500	54.0	Average	3
		74.0	Peak	3

**Limit:**

**(Field strength of the fundamental signal)**

Frequency	Limit (dBuV/m @3m)	Remark
433.09 - 434.61MHz	80.83	Average Value
	100.83	Peak Value

**Test Procedure:**

- The EUT was placed on the top of a rotating table 0.8 meters above the ground at a 3 meter semi-anechoic chamber. The table was rotated 360 degrees to determine the position of the highest radiation.
- The EUT was set 3 meters away from the interference-receiving antenna, which was mounted on the top of a variable-height antenna tower.
- The antenna height is varied from one meter to four meters above the ground to determine the maximum value of the field strength. Both horizontal and vertical polarizations of the antenna are set to make the measurement.
- For each suspected emission, the EUT was arranged to its worst case and then the antenna was tuned to heights from 1 meter to 4 meters (for the test frequency of below 30MHz, the antenna was tuned to heights 1 meter) and the rotatable table was turned from 0 degrees to 360 degrees to find the maximum reading.
- The test-receiver system was set to Peak Detect Function and Specified Bandwidth with Maximum Hold Mode.
- If the emission level of the EUT in peak mode was 10dB lower than the limit specified, then testing could be stopped and the peak values of the EUT would be reported. Otherwise the emissions that did not have 10dB margin would be re-tested one by one using peak, quasi-peak or average method as specified and then reported in a data sheet.
- The radiation measurements are performed in X, Y, Z axis positioning. And found the Z axis positioning which it is worse case, only the test worst case mode is recorded in the report.

**Test Setup:**

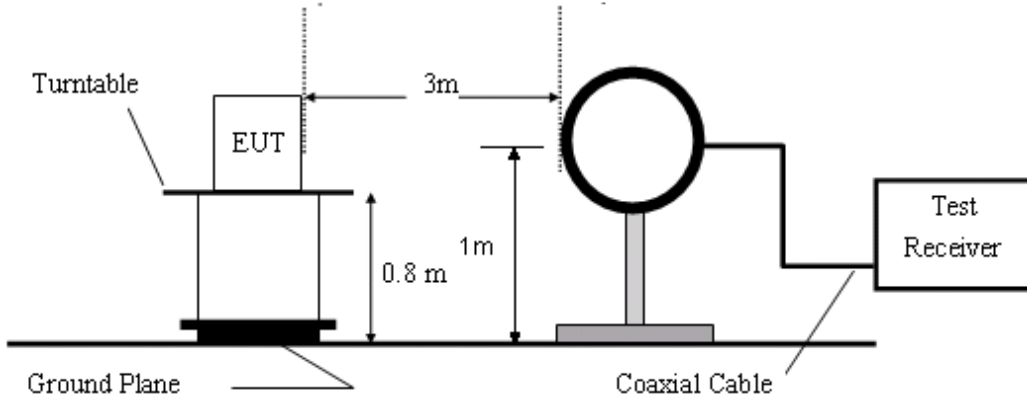

**Figure1. 30MHz to 1GHz radiated emissions test configuration**

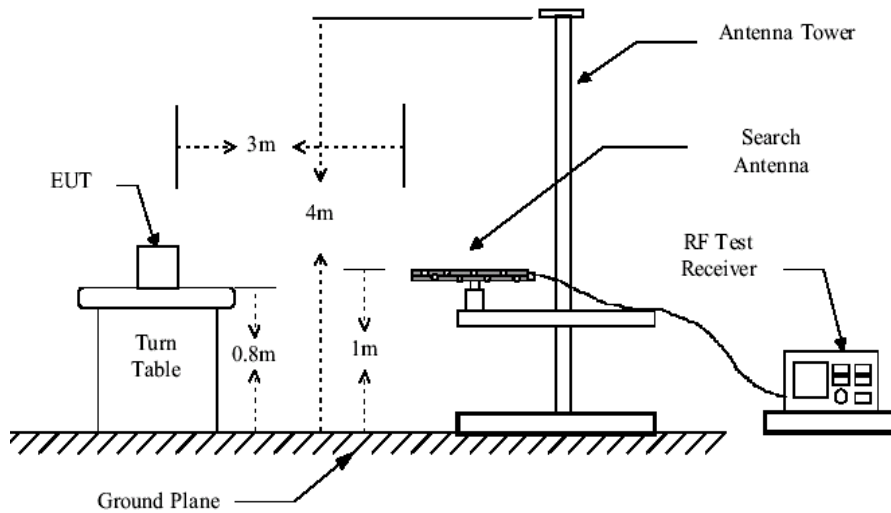

**Figure2. 30MHz to 1GHz radiated emissions test configuration**

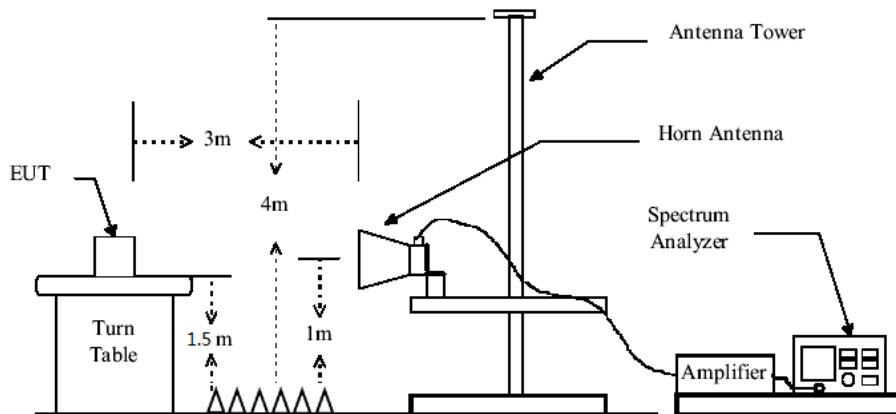

**Figure3. Above 1GHz radiated emissions test configuration**

**Test Results:** Pass

### 7.3.1 Field Strength of the Fundamental Signal

Test channel	Freq. (MHz)	Result Level (dB $\mu$ V/m)	Limit Line (dB $\mu$ V/m)	Over Limit (dB)	Detector	Polarization
Channel 1	433.92	74.22	80.83	-6.61	Peak	VERTICAL
		76.64	80.83	-4.19	Peak	HORIZONTAL

Remark: If the Peak value below the AV Limit, the AV test doesn't perform for this submission.

### 7.3.2 Spurious Emissions

Below 1GHz

Vertical:

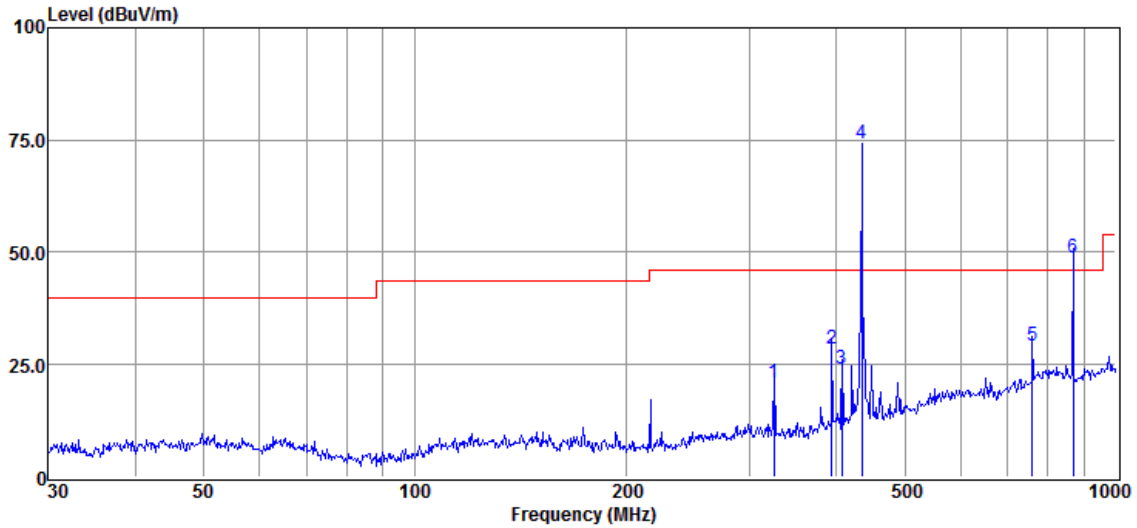

Item	Freq.	Read Level	Antenna Factor	Preamp Factor	Cable Loss	Result Level	Limit Line	Over Limit	Detector
(Mark)	(MHz)	(dB $\mu$ V)	(dB/m)	(dB)	(dB)	(dB $\mu$ V/m)	(dB $\mu$ V/m)	(dB)	
1	324.99	48.89	13.16	43.29	2.14	20.90	46.00	-25.10	QP
2	393.06	54.54	14.76	43.24	2.39	28.45	46.00	-17.55	QP
3	406.89	49.66	15.29	43.23	2.45	24.17	46.00	-21.83	QP
4	433.92	98.73	16.16	43.21	2.54	74.22	Fundamental signal		
5	760.80	46.53	22.30	43.07	3.53	29.29	46.00	-20.13	QP
6	870.63	65.02	23.16	43.04	3.80	48.94	60.8	-11.86	QP

**Horizontal:**

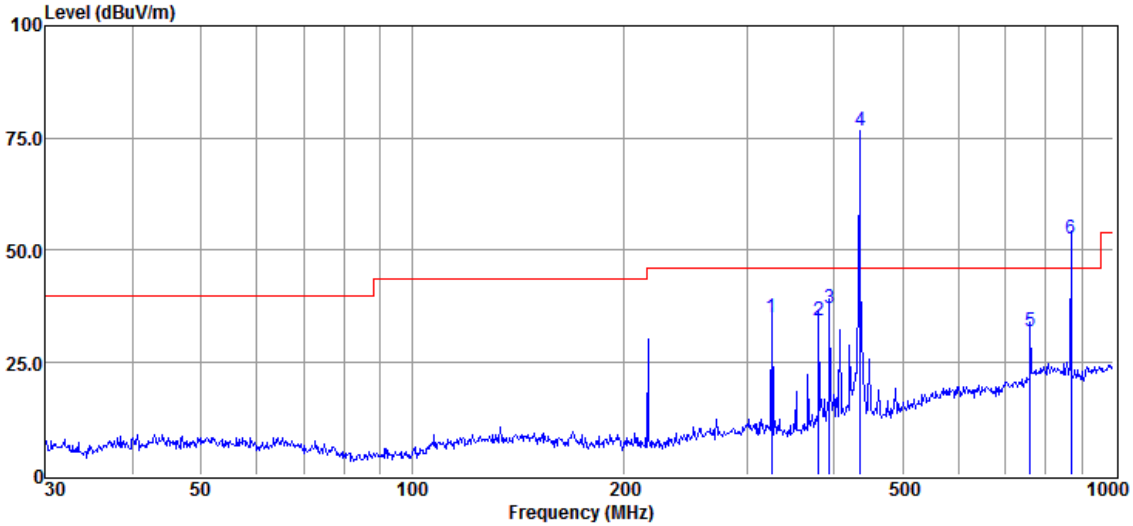

Item	Freq.	Read Level	Antenna Factor	Preamp Factor	Cable Loss	Result Level	Limit Line	Over Limit	Detector
(Mark)	(MHz)	(dB $\mu$ V)	(dB/m)	(dB)	(dB)	(dB $\mu$ V/m)	(dB $\mu$ V/m)	(dB)	
1	325.04	63.20	13.12	43.29	2.14	35.17	46.00	-10.83	QP
2	379.94	61.19	14.10	43.25	2.35	34.39	46.00	-11.61	QP
3	393.34	63.16	14.76	43.24	2.39	37.07	46.00	-8.93	QP
4	433.92	101.09	16.22	43.21	2.54	76.64	Fundamental signal		
5	760.23	49.09	22.30	43.07	3.53	31.85	46.00	-15.04	QP
6	870.33	68.49	23.16	43.04	3.80	52.41	60.8	-8.39	QP

Above 1GHz

Mark	Frequency (MHz)	Reading (dBUV)	Factor (dB)	Emission (dBUV/m)	Limit (dBUV/m)	Over Limit (dB)	Detector	polarization
1	1301.844	45.81	-7.38	38.43	54	-15.57	peak	Horizontal
2	1735.792	45.56	-5	40.56	54	-13.44	peak	Horizontal
3	2169.74	53.17	-2.93	50.24	54	-3.76	peak	Horizontal
4	1301.844	45.1	-7.38	37.72	54	-16.28	peak	Vertical
5	1735.792	44.34	-5	39.34	54	-14.66	peak	Vertical
6	2169.74	44.53	-2.93	41.6	54	-12.4	peak	Vertical

Remark:

- 1) The field strength is calculated by adding the Antenna Factor, Cable Factor & Preamplifier. The basic equation with a sample calculation is as follows:  
Final Test Level = Receiver Reading Level + Antenna Factor + Cable Factor – Preamplifier Factor
- 2) If Peak Result comply with AV limit, AV Result is deemed to comply with QP limit
- 3) No any other emissions level which are attenuated less than 20dB below the limit. According to 15.31(o), the amplitude of spurious emissions from intentional radiators and emissions from unintentional radiators which are attenuated more than 20 dB below the permissible value need not be reported unless specifically required elsewhere in this Part. Hence there no other emissions have been reported.

### 7.4 20dB Bandwidth

Test Setup:

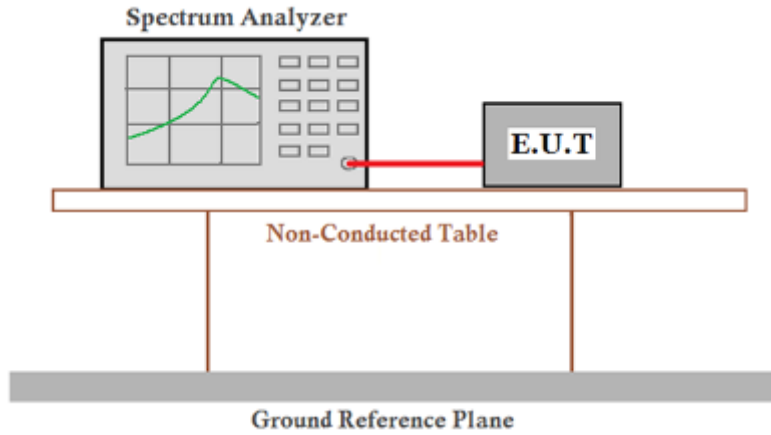

**Limit:** The bandwidth of the emission shall be no wider than 0.25% of the center frequency for devices operating above 70 MHz and below 900 MHz. For devices operating above 900 MHz, the emission shall be no wider than 0.5% of the center frequency. Bandwidth is determined at the points 20 dB down from the modulated carrier.

**Test Results:** Pass

**Measurement Data:**

Frequency(MHz)	20dB bandwidth (kHz)	Limit (kHz)	Results
433.92	8.00	1084.8	Pass

Test plot as follows:

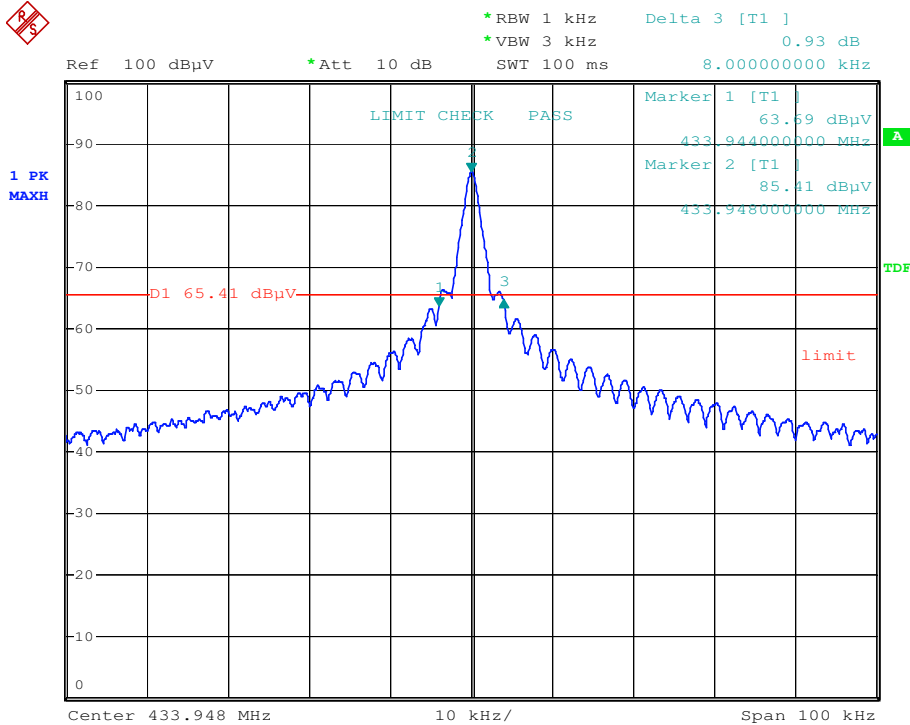



## 7.5 Dwell Time

Test Setup:

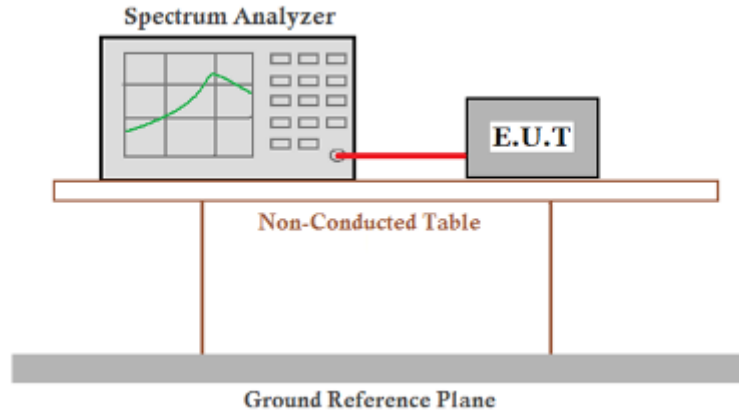

**Limit:** 15.231 (a): Not more than 5 seconds  
**Test Results:** Pass

### Measurement Data:

Test item	Limit (s)	Results
Transmission Duration	≤5s	Pass

Test plot as follows:

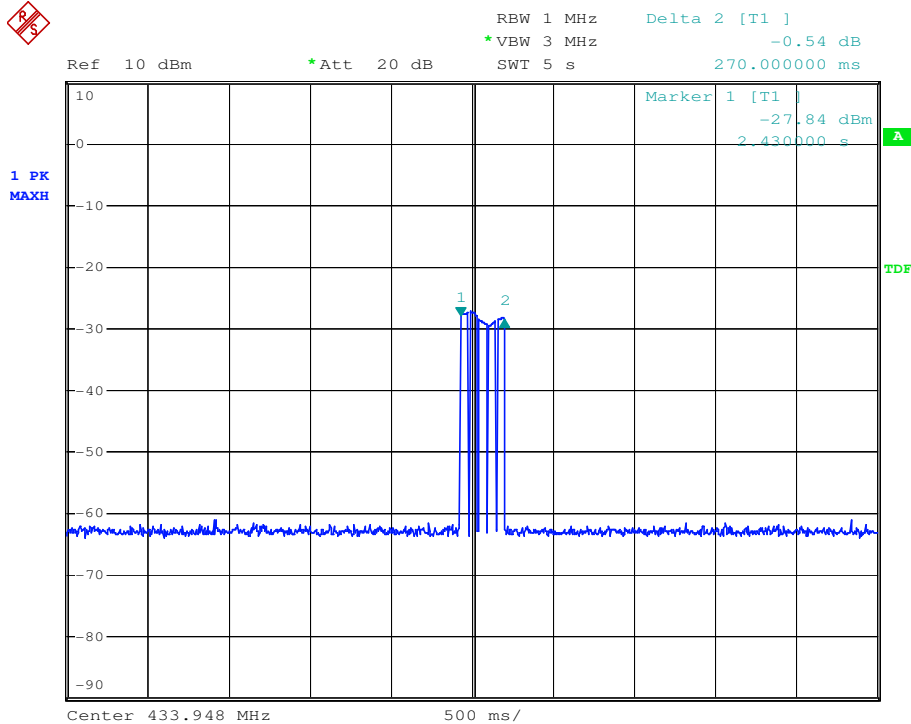

## **8 Test Setup Photographs**

Refer to the < DR-1262 \_Test Setup photos-FCC>.

## **9 EUT Constructional Details**

Refer to the < ST1(DR-1262) \_External Photos > & < ST1(DR-1262) \_Internal Photos >.

**--End of the Report--**